

MITSUBISHI ELECTRIC INDUSTRIAL ROBOT FR Series

e-Factory



MELFA **FR**
SERIES

GLOBAL IMPACT OF MITSUBISHI ELECTRIC



Through Mitsubishi Electric's vision, "Changes for the Better" are possible for a brighter future.

Changes for the Better

"Changes for the Better" represents the Mitsubishi Electric Group's attitude to "always strive to achieve something better", as we continue to change and grow. Each one of us shares a strong will and passion to continuously aim for change, reinforcing our commitment to creating "an even better tomorrow".

Mitsubishi Electric is involved in many areas including the following

Energy and Electric Systems

A wide range of power and electrical products from generators to large-scale displays.

Electronic Devices

A wide portfolio of cutting-edge semiconductor devices for systems and products.

Home Appliance

Dependable consumer products like air conditioners and home entertainment systems.

Information and Communication Systems

Commercial and consumer-centric equipment, products and systems.

Industrial Automation Systems

Maximizing productivity and efficiency with cutting-edge automation technology.

Our advances in AI and IoT are adding new value to society in diverse areas from automation to information systems. The creation of game-changing solutions is helping to transform the world, which is why we are honored to be recognized in the 2019 "Forbes Digital 100" as one of world's most influential digital corporations.



OVERVIEW

Product Lineup	7
Functions	11
Robot Specifications	33
Controller Specifications	51
Robot Option Specifications	53
System Configuration / Controller Option Specifications	57
Options	63
Technical Information	74

1
2
3
4
5
6
7
8

The new future of automation made possible by next-generation intelligent robots and e-F@ctory



Providing improvements in productivity, quality, environmental protection, safety and security to help reduce companies' TCO* and boost their corporate value

We offer solutions that use FA technology and IT to reduce total costs in everything from development through to production and maintenance, supporting customers to continuously improve their business operations and achieve truly cutting-edge manufacturing.

*TCO: Total Cost of Ownership
e-F@ctory is Mitsubishi Electric's trademark and registered trademark.

Seeing: Improvement

IT systems feed the results of analysis back into the production site

IT systems

Observing: Analysis

Primary processing of data collected using FA (edge computing) Seamless integration with IT systems

Edge computing

Watching: Visibility

Collecting production site data in real time

Production site

Helping to increase corporate value through "Visibility³ (cubed) — seeing, observing, watching" and "Usability"

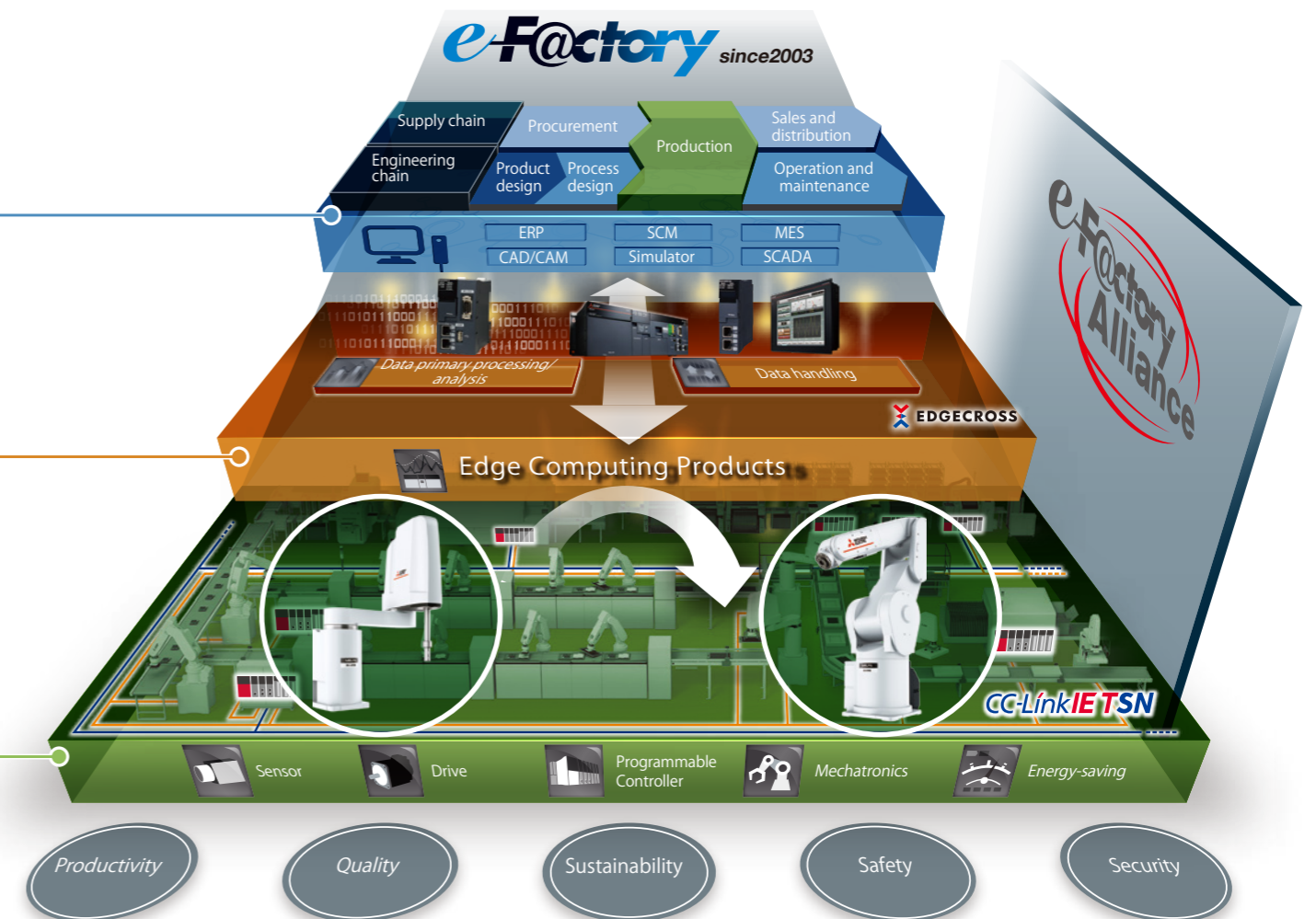

Introducing the next generation of intelligent robots, incorporating advanced solutions technology and "e-F@ctory", technologies and concepts developed and proven using Mitsubishi Electric's own production facilities that go beyond basic robotic performance to find ways of reducing the TCO in everything from planning and design through to operation and maintenance.



Cellular manufacturing

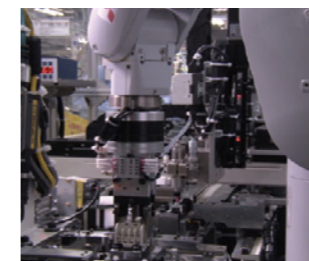

Assembly and Inspection

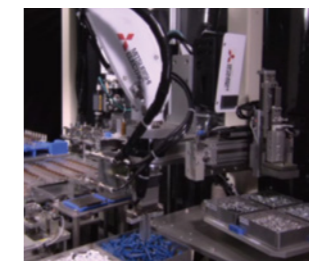

Parts supply

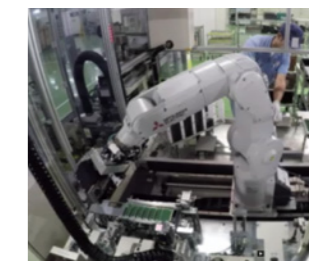

High mix production

Evolved intelligence realizes advances in work procedures, cooperation between people and robots, and e-F@ctory-compatibility, making next-generation manufacturing a reality.

With globalization and increasingly diverse consumer needs in the market, the manufacturing industries face a time of considerable change. It is no longer enough for industrial robots to simply perform a single task. Industry now demands robots with the capacity and flexibility to readily take on more sophisticated tasks. The MELFA FR series provides new, more intelligent solutions that underpin "next-generation manufacturing", offering a simpler approach to advanced and flexible production. These robots can handle all your automation needs.

MELFA FR Series

"Next-generation intelligent functions" make it simple to carry out work that has always defied automation. "Safe, collaborative work applications" allow robots and people to work together with high levels of safety. "FA-IT integration functions" support next-generation manufacturing. With these 3 key features, the FR Series is capable of handling virtually all your automation needs.

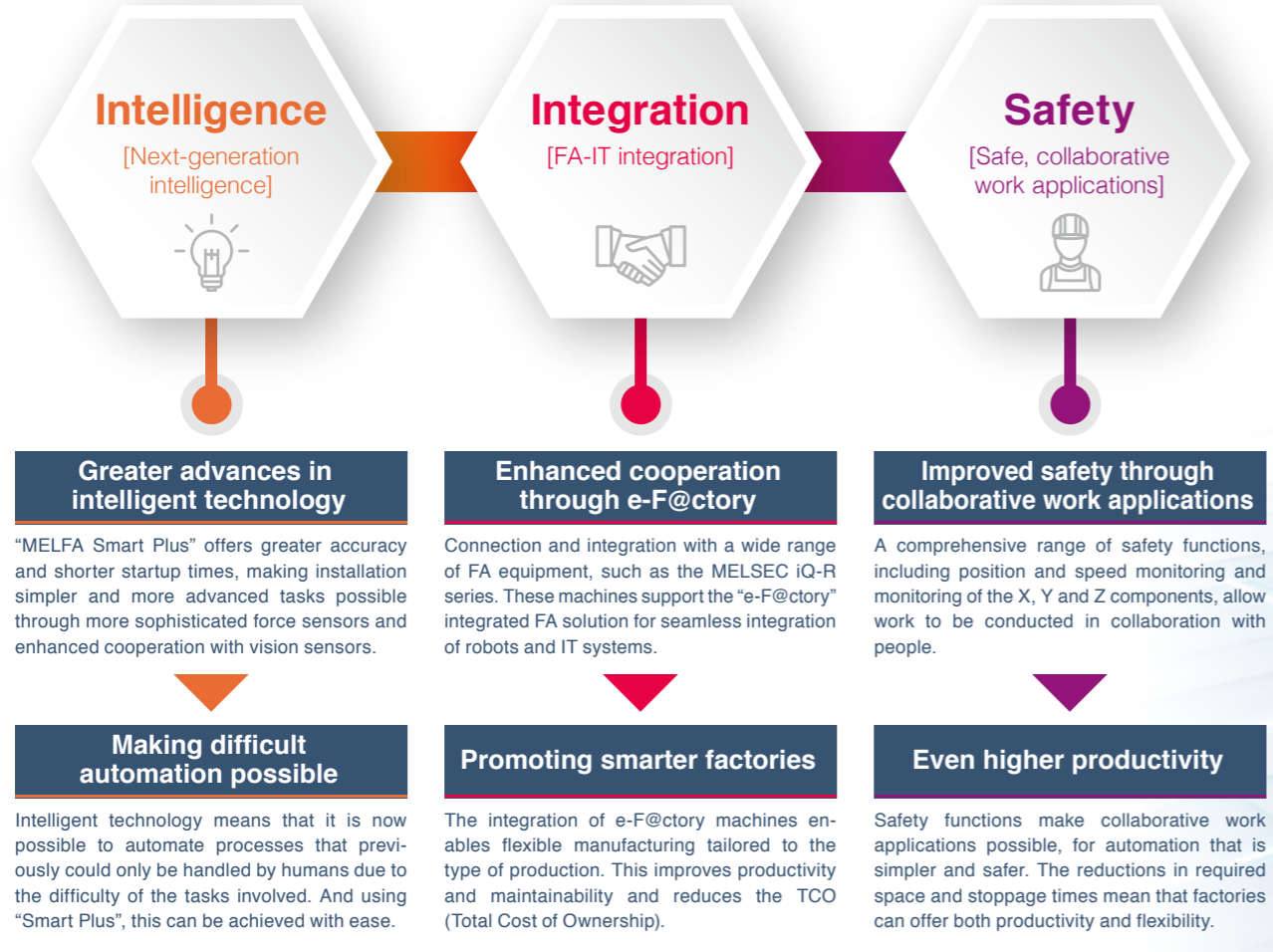

MELFA Smart Plus Function expansion options further broaden the range of possibilities of the MELFA FR series, offering performance beyond your expectations.

Integration with the MELSEC iQ-R series PLCs enables more advanced tasks! Integrating these robots with the Mitsubishi Electric MELSEC iQ-R PLCs simplifies startup and improves productivity and maintainability, ensuring that you maximize the potential of the FR series.

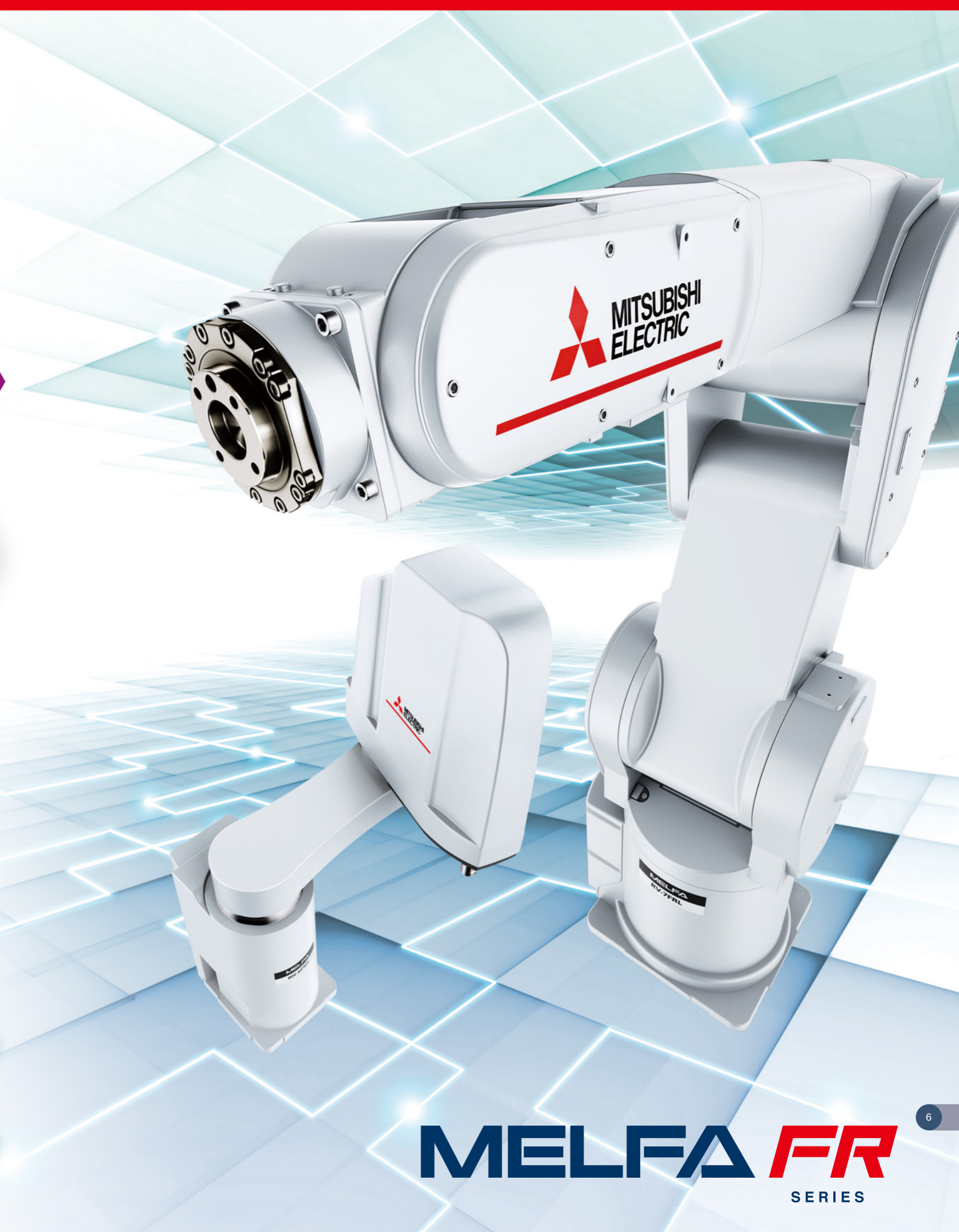

Vertical, multiple-joint type robots

RV-FR SERIES

- Optimized arm length and 6 joints for a broader range of movement support complex assembly and process operations.
- Compact body and slender arms capable of covering a large work area and large load capacity.
- Suitable for a broad range of layouts, from transporting machine parts to assembling electrical components.
- Designed to withstand environmental conditions, making it ideal for a wide range of applications without having to worry about the installation environment.



Horizontal, multiple-joint type robots

RH-FR SERIES

- With a wealth of operating areas and variations, it is the perfect fit for a variety of applications.
 - Highly rigid arms and cutting-edge servo controls provide superb precision and speed.
- Ideal for a wide range of fields, from high-volume production of foodstuffs and pharmaceuticals that demands fast operation, through to assembly work where high levels of precision are required.



■ Vertical, multiple-joint type (RV) series

Type	RV-2FR	RV-2FRL	RV-4FR	RV-4FRL	RV-7FR	RV-7FRL	RV-7FRL	RV-7FRL	RV-13FR	RV-13FRL	RV-20FR	
Maximum load capacity	3kg		4kg		7kg			13kg				20kg
Maximum reach radius	504mm	649mm	515mm	649mm	713mm	908mm	1503mm	1094mm	1388mm	1094mm		

■ Horizontal, multiple-joint type (RH) series

Type	RH-3FRH	RH-6FRH	RH-12FRH	RH-20FRH	RH-3FRHR
Maximum load capacity	3kg	6kg	12kg	20kg	3kg
Maximum reach radius	350mm 450mm 550mm				350mm
		350mm 450mm 550mm	700mm 850mm 1000mm		
Z stroke	150mm ^{*1}				150mm ^{*2}
		200mm			
		340mm	350mm		
			450mm		

*1 Clean specification: 120mm

*2 Clean and waterproof specification: 120mm



Improved controller performance

Control cycles on FR series controllers take just half the current time, improving robot control performance. The faster calculation speed gives better robot processing capacity and shorter cycle times for improved productivity. Integration with the various sensors also makes precision operation possible. (The performance of FR series Q type controller is equivalent to F series Q type controller.)

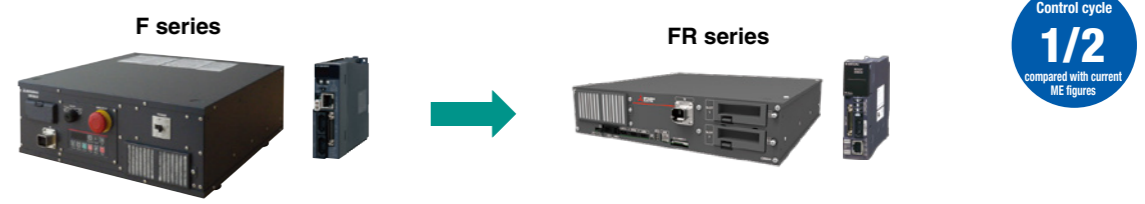

The R Type controllers supported by the MELSEC iQ-R series dramatically improve compatibility with FA equipment, allowing information to be shared mutually and data to be collected and processed. Improved system bus performance has also reduced communication cycles to 1/4 of current levels, allowing shorter cycle times for production facilities.

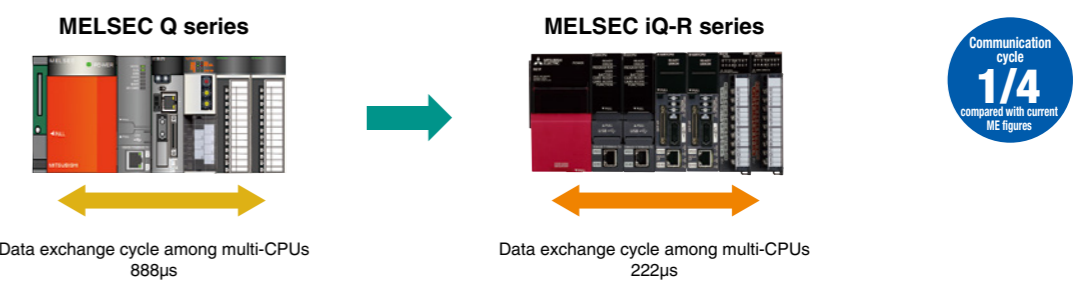

Dedicated motors for high-speed operation

Using motors developed in-house, highly rigid arms and our original drive control technology, these machines are capable of high-torque output at high rotation speeds, giving better operating performance. Their capacity for continuous operation is also improved, with higher productivity due to the shorter cycle times.

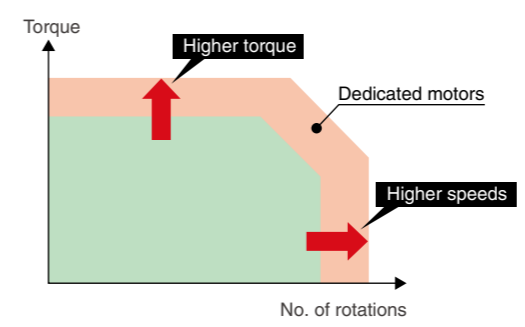

Expanded pivotal operating range

Improved flexibility for robot layout design considerations. Enabling more effective use of access space around the entire perimeter including to the rear. Shortened movement distances, enabling cycle times to be shortened.

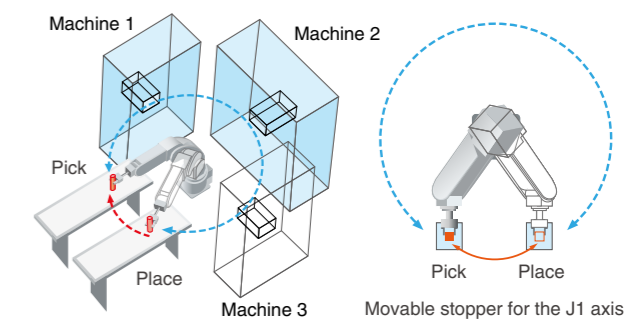

Preventing cable interference

Internal wiring channels provided in the tip axis. Allows wiring and tubes to be routed internally up to the gripper mount. By routing the body cables internally, areas where body cables might interfere with peripheral equipment can be minimized and the problem of wiring and tube tangles can be eliminated.

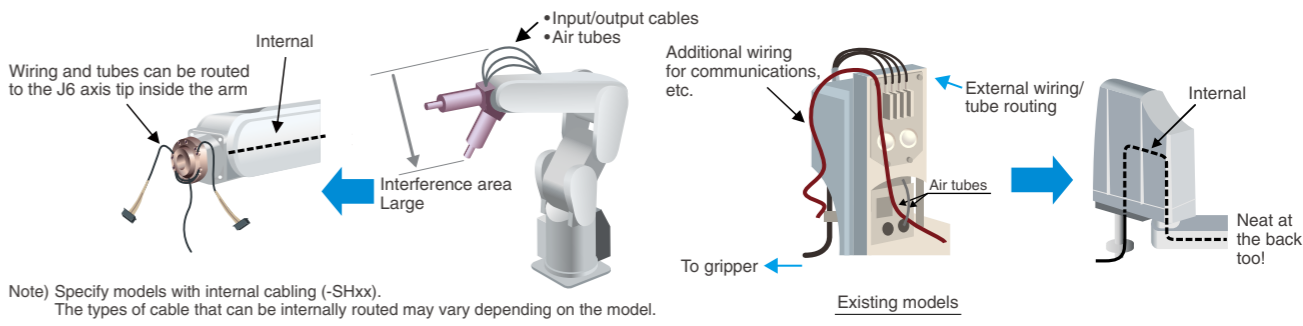

Controller Types

R/Q TYPE Controller

This controller is compatible with the "iQ Platform", which seamlessly integrates the various controllers used in a production site with HMIs, the engineering environment and the network. It uses a multi-CPU configuration that dramatically improves its interaction with FA equipment and also offers highly precise control and fast yet simple information management.

[R TYPE controller]
MELSEC iQ-R series-dedicated

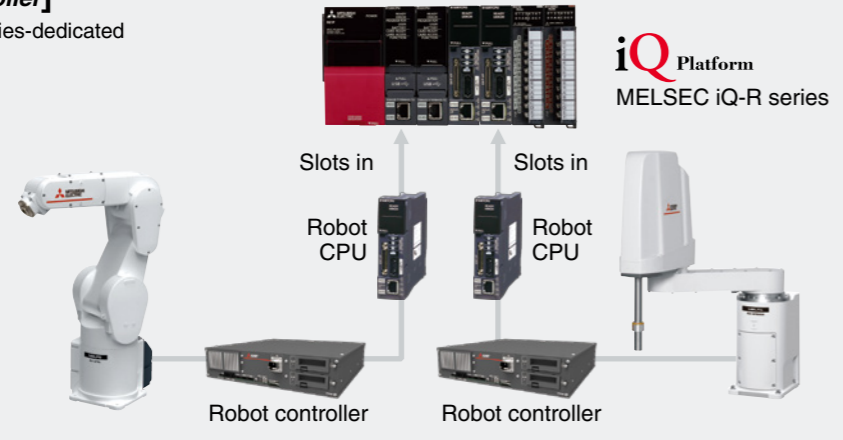

[Q TYPE controller]
MELSEC Q series-dedicated

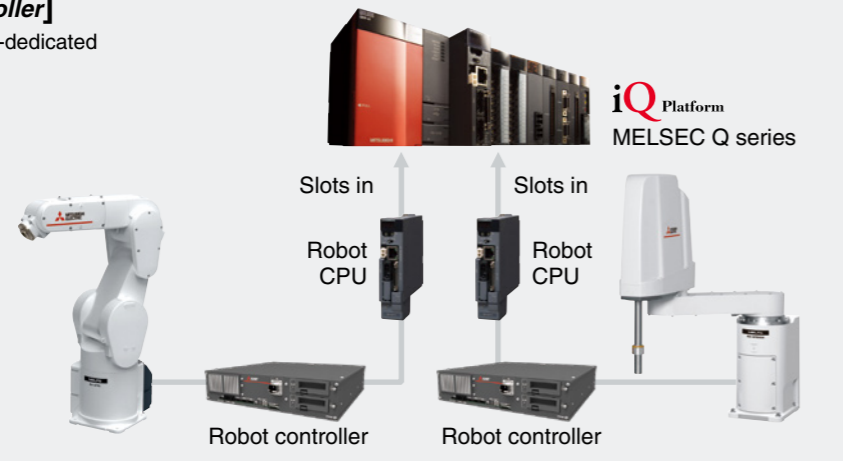

D TYPE Controller

A standalone controller similar to existing models. Enables the construction of cells using robot controllers as the control nucleus. Comes with various interfaces as standard, allowing customers to build a system optimized for their applications.

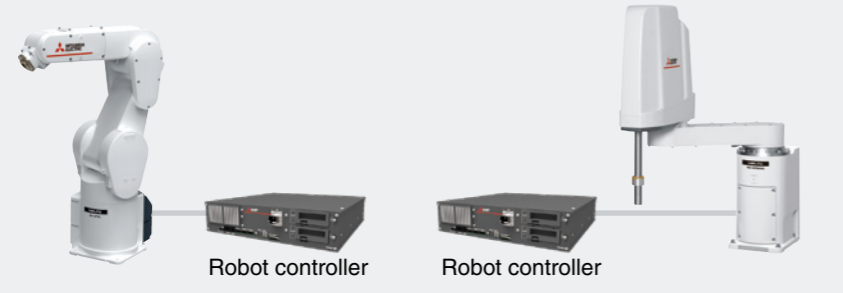



Greater advances in intelligent technology

Enhanced cooperation with vision sensors and more advanced force sensors allow more advanced tasks to be accomplished at higher speeds and with greater precision.

Through the use of highly accurate vision sensors and force sensors that control the levels of force applied by robots, it is now possible to automate extremely difficult tasks that have been beyond the scope of automation in the past.

Force sensor

- Checks the applied force and the force status during insertion to provide improved work quality
- Assembly of difficult-to-fit workpieces
- Teaching assistance using force information
- Faster control cycles for improved force control

3D vision sensor

- Kitting or sorting of irregularly placed or overlapping workpieces
- Supports functions for easier startup

Preventing interference

iQ Platform

Checking for interference between the arms and grippers of adjacent robots prevents any contact.

2D vision sensor

- Setup tools for vision simplify the calibration of robots and cameras
- Simple Ethernet connections between robots and cameras
- Easy control using vision control instructions in the robot programs

Cooperative control

iQ Platform

- Two robots can be coordinated to transport very long or heavy objects
- Positional relationships of non-fixed parts maintained during transportation and assembly

Multi-function gripper

- Multi-function electric grippers capable of working with different part types of varying sizes
- Less need for setup changes

Example of intelligent technology use

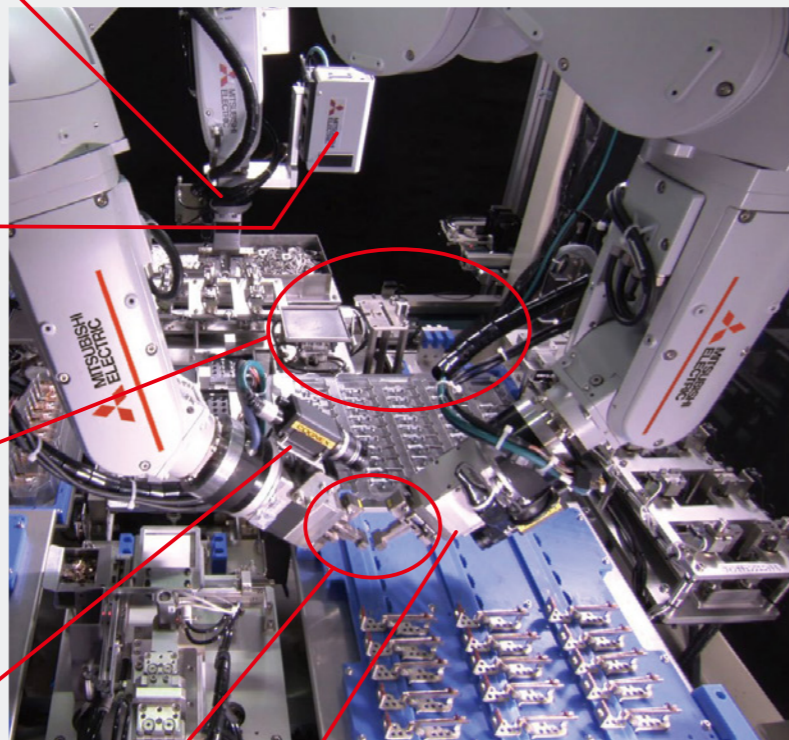

Tracking

Transport, alignment, and assembly work, etc. can be performed while robots are tracked with the workpiece on the conveyor without stopping the conveyor

Tracking accuracy enhancement function

Positional gain is changed in real time for even better tracking accuracy

Other functions

Singular point transit and orthogonal compliance functions facilitate the completion of a range of different tasks.



MELFA Smart Plus supports cell production, using robots to overcome the limitations on lead times, production volumes, and location.

MELFA Smart Plus

MELFA Smart Plus

Advanced features such as integration functions for the various sensors and autonomous startup adjustment functions are provided for all phases of customer's operations, from design and startup through to operation and maintenance.

*Activated with the insertion of a Smart Plus card

CR800 Controller



MELFA Smart Plus card (2F-DQ5XX)

Preventive maintenance function

Quickly detects abnormalities in drive system components before they affect robot behavior.

Preventive maintenance function

Maintains the robot's health with operation status tracking

Enhancement function for force sense control

Parameters for the optimum operation pattern are found using repeat learning in a short amount of time. SetUp and tact times are reduced.

MELFA-3D Vision enhancement function

Reduced startup time thanks to automatic parameter adjustment which utilize our proprietary AI technology "Maisart".

Coordinated control of additional axes

Using a robot with an RTU enables manufacturing and assembly at user specified speeds.
*RTU: Robot Transport Units

Robot mechanism thermal compensation function

Compensates for thermal expansion of the robot arm to increase position accuracy.

Calibration assistance function

Automatic calibration

Improves positioning accuracy by automatically correcting the vision sensor coordinates.

Work coordinate calibration

Improves positioning accuracy by automatically correcting the robot coordinates and work coordinates from the vision sensor.

Relative position calibration

Uses vision sensors to automatically adjust the robot location relative to other robots. Improves positioning accuracy during coordinated operation.

The high-precision technologies and calibration functions provided by MELFA Smart Plus allow correction of machine deviations between cells, offline teaching, and copy cells*1. This then enables coordinated operation between the master cell and other cells.

*1 Offline teaching: Operation where programs created in a simulation are transferred to an actual cell for operation.
Copy cell: Conveys master cell modification information. Processes in cells in other locations are then modified in the same way.

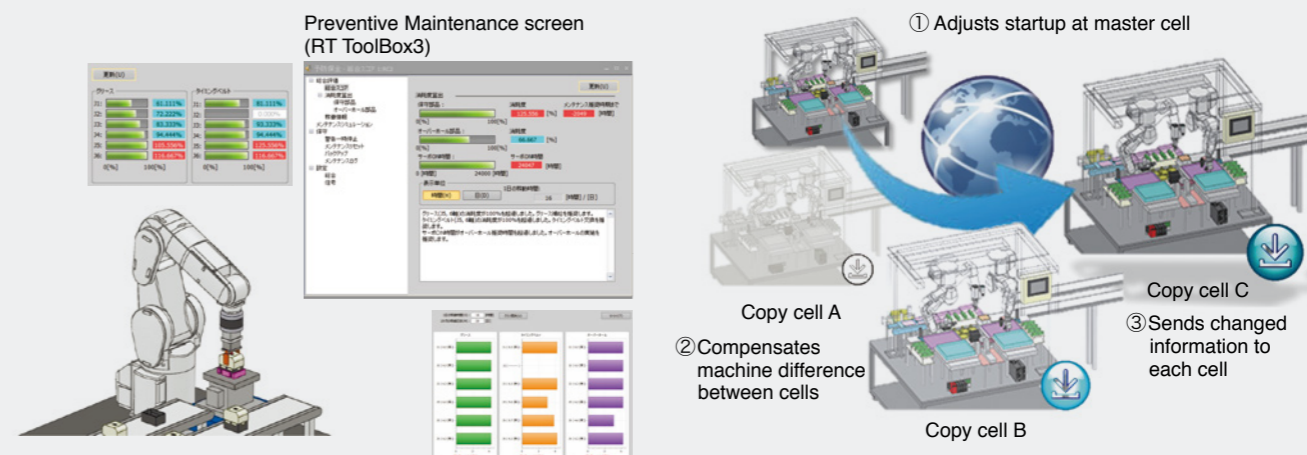



Greater advances in intelligent technology

Enhancement function for force sense control

MELFA Smart Plus

AI automatically adjusts to the optimum parameters for force sensing. The optimum parameter calculation function allows anyone to easily adjust to the optimum parameters in a short time. This allows shorter system startup and tact time.

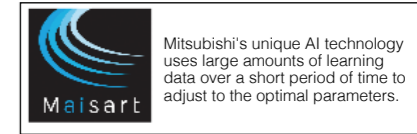

Force sensor

See P.67 for detailed specifications

Monitors the force applied to the robot gripper so that copying and fitting work can be carried out as it would by a human operator.

Force control

Controls "force" and "flexibility".
Modifies control properties during operation.

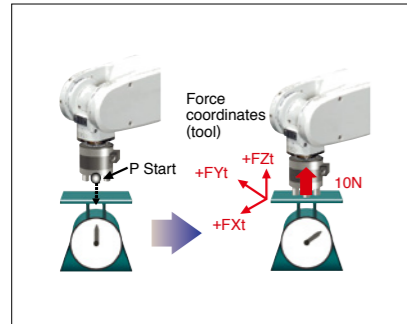

Keeps the force constant so that the workpiece can be handled without causing damage

Force detection

Switches operation in response to transitional states.

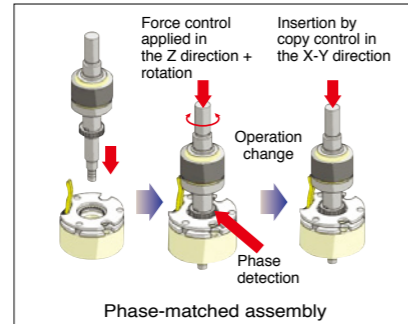

Complex assembly tasks achieved through techniques such as phase matching

Force log

Checks the work status.
Saves log data.

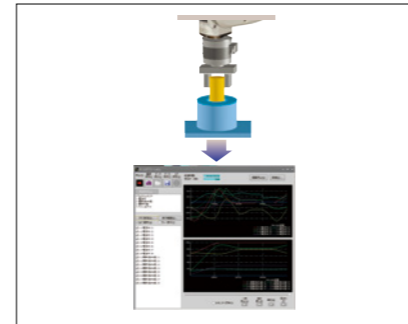

Checks the work status to facilitate adjustment. Log data analysis also allows predictive safety measures

More accurate force sensor

Advances in force sensors allow faster and more accurate testing.



Force sensor options
SSCNET III/H compatibility

Control cycle
1/2
compared with current
ME figures

Gravitational offset cancellation

Compensates for gravity in response to changes in force on the force sensor in the X, Y and Z directions when the attitude changes.
Force control can be exercised correctly even when the attitude changes.

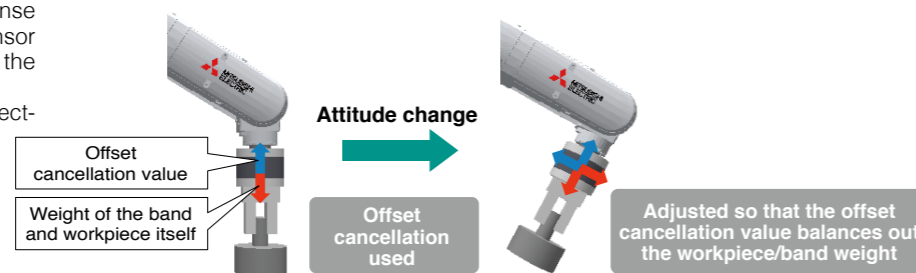

Teaching work assistance

Force GUI included**

- Computer software (RT ToolBox3) and a teaching box (R56TB or R32TB) are standard features of the force GUI screen, making it easy to use force sensors.
- Teaching can be carried out while monitoring the reactive force on the force GUI screen.

- Force data synchronized to the positional data can be saved as log data.
- Log data can be viewed as graphs using RT ToolBox.
- Log data files can be downloaded to a computer via FTP.

**1 GUI: Graphical User Interface

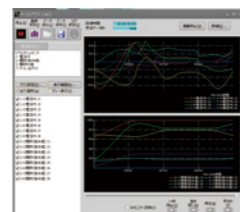

Force log (RT ToolBox3 log viewer)



R32TB

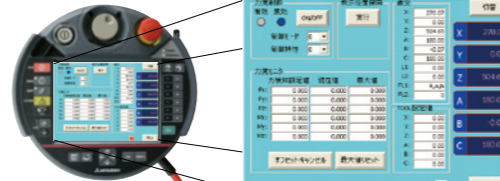

R56TB

Teaching while monitoring force states using the dedicated force control screen in the teaching box. Enables optimized location teaching

Select force sensing task

- Insertion and fitting
- Phase-matched insertion
- Contact detection

Operation settings

Set the operation settings of the force sense operation you want to create.

Setting for learning

Configure the learning settings such as permissible acting force and the number of times learning operation is repeated.

Learning

The learning operation is repeated when you execute the learning program. This repetition allows the AI to optimize control parameters, positions, and speed.

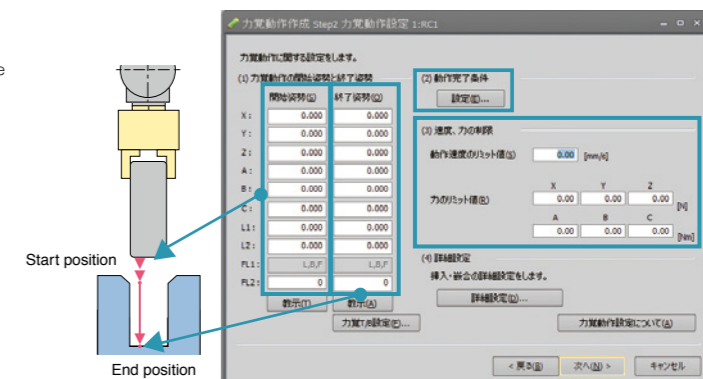

Assembly work (case study)

Fitting a coupling onto a spindle (insertion task with H7h7 tolerance)

Key Points!

- Insertion is by fitting along the Z axis in the soft state while rotating in the θ axis direction.
- Force is specified where both are aligned on the same axis.
- Once they are aligned on the same axis, operation switches to positional control mode and the parts are assembled into their installed positions.
- The parameters required for this work can be set freely.

Operation overview

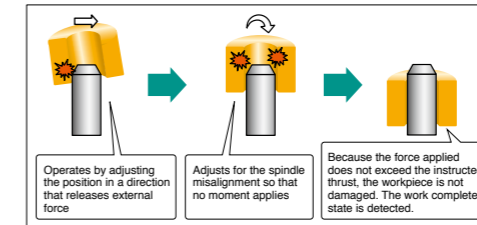

Related case studies

D-cut part insertion work

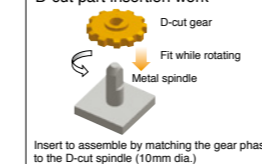

Insert to assemble by matching the gear phase to the D-cut spindle (10mm dia.)

Gear assembly work

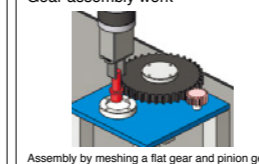

Assembly by meshing a flat gear and pinion gear

Bearing insertion work

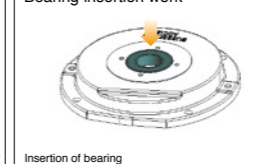

Insertion of bearing

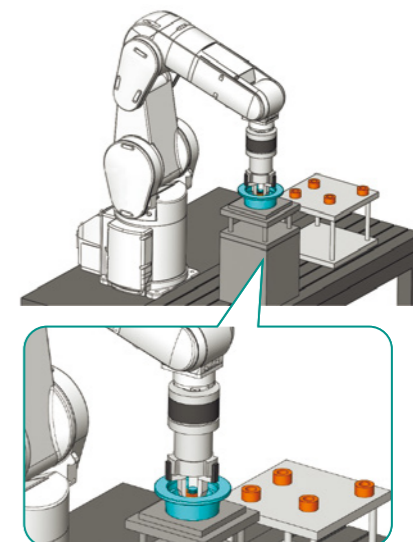

Force inspection (case study)

Fitting of a part where the force must be managed and the spring pressure inspected

Key Points!

- The fitting assembly and spring pressure inspection are carried out on one machine.
- Force is inspected at the fitting operation stop position.
- The spring pressure is inspected in the force log.
- Productivity is improved due to assembly reliability and automatic testing.

Spring pressure inspection waveform

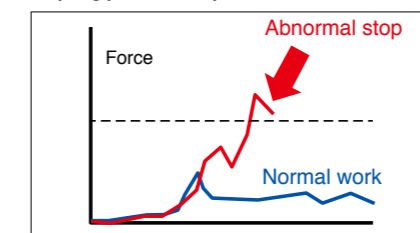

Related case studies

Spindle size inspection

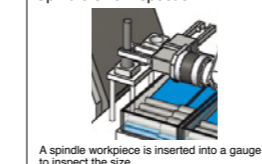

A spindle workpiece is inserted into a gauge to inspect the size

Snap mechanism part assembly work

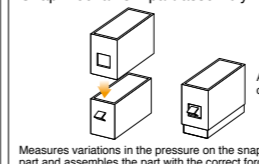

Measures variations in the pressure on the snap mechanism part and assembles the part with the correct force

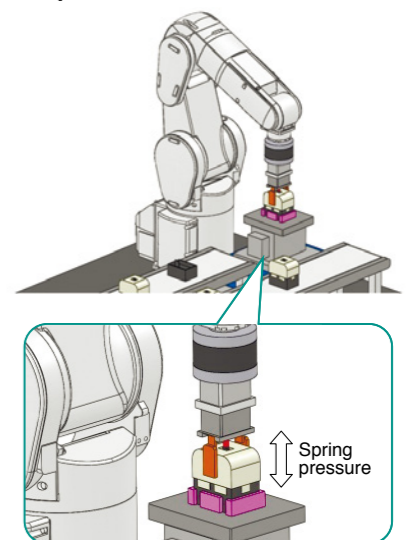



Greater advances in intelligent technology

3D vision sensor MELFA-3D Vision 3.0

NEW

See P.68 for detailed specifications.

Enables bulk feeding

The ability to perform bulk feeding without the use of special trays or parts feeders makes part feeding much easier.

High-speed picking using original technology

Shortens the image recognition time with high-speed recognition technology. (30% increase compared to our conventional model) Either the model-less recognition, which enables high-speed picking or the model-matching recognition method, which accurately matches the workpiece position and orientation, can be selected to suit the application.

Automatic parameter setting with AI



Mitsubishi's original AI technology and simulation technology automate the sensor parameter adjustment work, which requires expert knowledge. Anyone can easily achieve the same performance as a skilled worker in a short time without needing an actual machine. (Compatible only with model-less recognition)

Lightweight and compact for diverse installation

Compatible with ENSENSO N35 series cameras. The extensive lineup of compact and lightweight models enables a flexible system configuration.

Automatic calibration function

NEW

Equipped with an automatic calibration function that automatically aligns the robot and vision sensor. This makes adjustments much easier.

Workpiece supply assistance function

Spindle characteristic mode and orientation output mode can be used to ensure a stable grip during model-less recognition. The function to estimate the remaining bulk workpiece level allows the operator to understand the timing to load supplied parts.

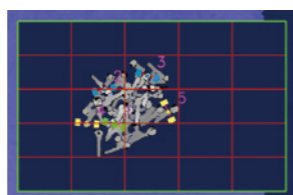

Model-less recognition



Model-matching recognition

Lightweight, compact, with a wide field of view

Smaller and more lightweight, equipped with ENSENSO camera head. Both hand-eye and fixed installation are available. Additionally, the camera itself supports oil mist environments (IP65/IP67), and increased workpiece distance and visual field allow for broader application. It flexibly supports everything from precision assembly of small parts to bulk picking from large pallets.

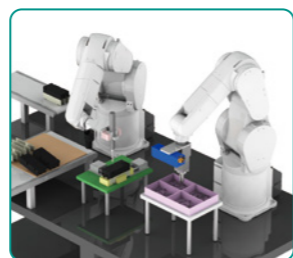

Small part assembly (Hand-eye)



Picking from a large pallet (Fixed camera)

Automatic parameter setting with AI



AI automatically adjusts the optimum 3D sensor parameters (image processing parameters, grip position recognition parameters) in a virtual space. (See P.68 for compatible cameras.) Adjustment of complicated parameters is simplified by using the 3D CAD data, even without the camera head. This greatly reduces the vision sensor parameter adjustment time.

Features

- AI automatically adjusts parameters on the PC.
- No need for expertise knowledge.

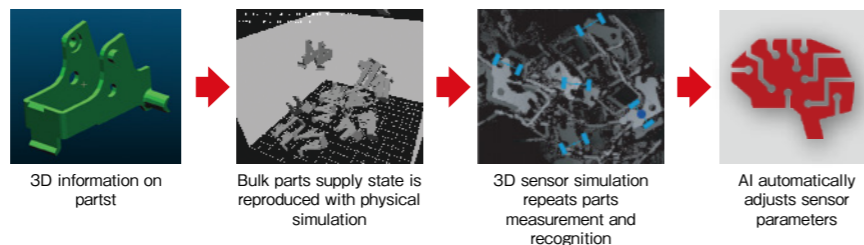
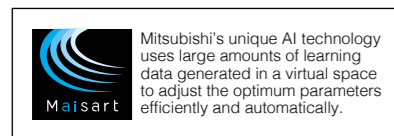

3D information on partst

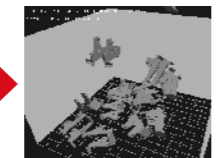

Bulk parts supply state is reproduced with physical simulation

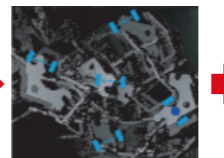

3D sensor simulation repeats parts measurement and recognition



AI automatically adjusts sensor parameters

Multi-function electric gripper

See P.71 for detailed specifications.

High-functioning operation control not possible using air cylinders

The gripping force and speed can be specified to suit the target, whether it's a heavy object or involves delicate work. Even when handling multiple workpieces of varying sizes, the operating positions can be specified so that the optimum stroke is configured. Product inspections can be informed by positional feedback from the gripper, such as whether gripping was successful or whether workpiece measurements indicate that it is acceptable.

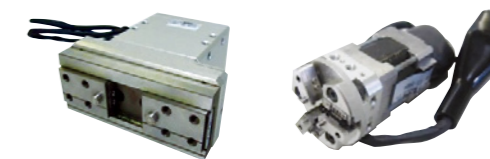

Multi-function electric gripper (TAIYO)

Open/close stroke control to prevent interference

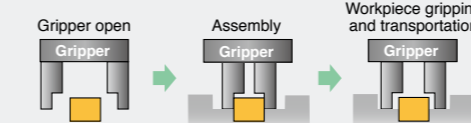

<Benefits of the electric gripper>

- Multi-point positional control (suited to many product models, adjustable open/close stroke)

Prevents distortion in plastic molded items, etc.

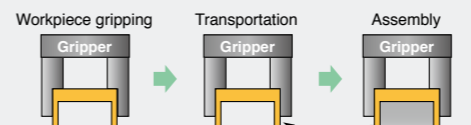

<Benefits of the electric gripper>

- Speed control (retains workpiece shape, lessens impact force)
- Gripping force control (prevents workpiece distortion)

Simple control

The operation stroke and grip force can easily be configured for the workpiece shape using the robot programming.



Easy operation

The gripper can be freely controlled from the dedicated gripper screen in the teaching box.

Interference prevention function



Automatically prevents collisions between robots

Unanticipated interference can be prevented during jogging or automatic operation because collisions between robots are detected in advance and robot movement is stopped.

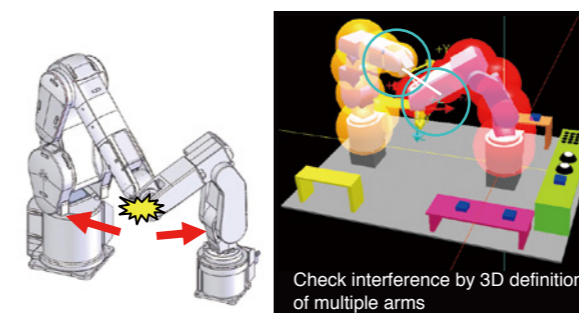

Check interference by 3D definition of multiple arms

Reduced workload during startup

The number of recovery processes following collisions due to missed interlocks or teaching errors can be reduced.

Cooperative control



Cooperative control using multiple arms

Cooperative control between multiple robots is enabled through CPU connection between the robots. Normal operation is through individual robot operation, making operation simple.



Assembly work that maintains the relative positions for mutual gripping

Coordinated transportation

Long or flexible objects can be transported using multiple small robots instead of larger robots.



Greater advances in intelligent technology

Tracking

- Transport, alignment, and installation work, etc. can be performed while a robot is tracking workpieces on the conveyor without stopping the conveyor.
- Different variations can be selected, including vision tracking in combination with a vision sensor, tracking in combination with an opto-electronic sensor, etc.
- Programs can be created easily in robot language (MELFA BASIC).
- Standard interface function. (Separate encoder and vision sensor required.)

- No need for a positioning device
- Reduce cycle time
- Reduce system costs

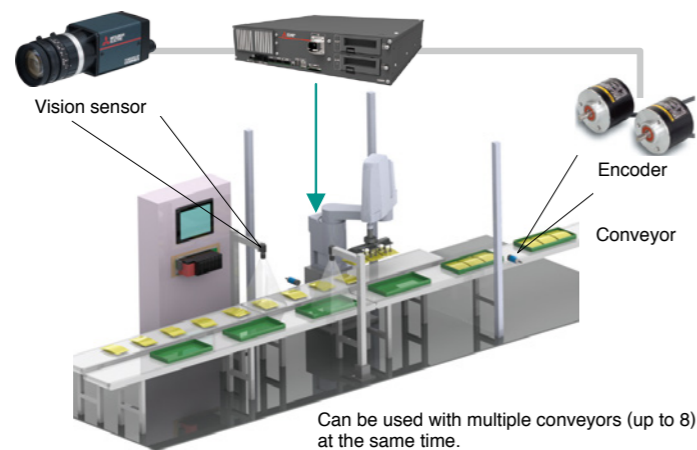

Additional axis function

- The layout can be set up to include the robot traveling axis and turntable as well as user machines separate from the robot such as loaders and positioning devices.
- Up to 8 additional axes can be controlled excluding the robot.
- Additional axes and user machines can be operated from the robot teaching pendant without any additional motion control hardware. The same JOG operation as for the robot can be used. Robot language can be used for control operations.
- The robot controller has compatibility with the MELSERVO (MR-J4-B, MR-J3-BS) servos.
- Standard interface function. (Separate servo amplifier and servo motor required.)

- No need for a dedicated control device

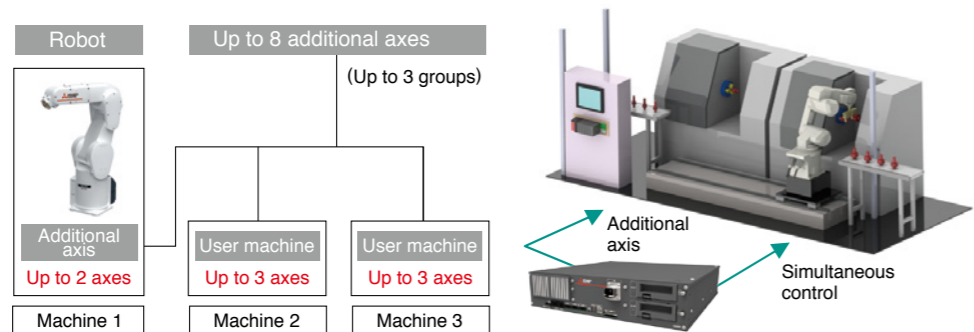

Improved accuracy

Active gain control

- Optimal motor control tuning set automatically based on robot operating position, posture, and load conditions.
- Improves tracking accuracy for the target trajectory.

- Active gain control is a control method that allows the position gain to be changed in real time.
- This is effective when traveling straight and sealing work requiring high accuracy.

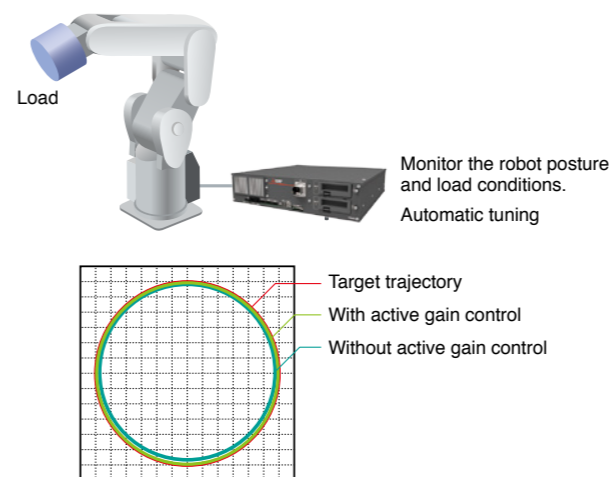

Operating mode setting function

- Trajectory priority mode/speed priority operation can be set in programs to match customer system requirements.
- Optimal motor control tuning set automatically based on robot operating position, posture, and load conditions.
- Improves tracking accuracy for the target trajectory.
- This is effective when traveling straight and sealing work requiring high accuracy.

- Improve trajectory accuracy
- Improve vibration-damping performance

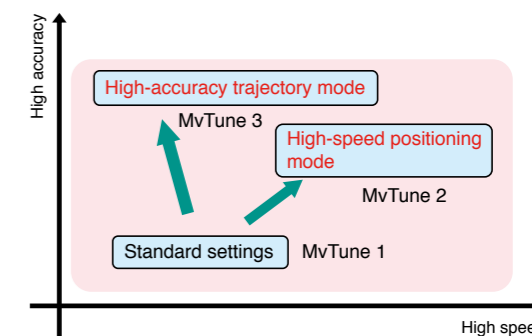

Other functions

Collision detection function

- This function detects robot arm collisions during teaching or operation which minimizes damage to the robot body and the grippers.
- The collision detection function can be used to protect the workpiece from becoming damaged due to interference between the workpiece and affected objects.
- The detection level can be changed according to the protection targets.
- Operation following collision detection can be programmed to suit the circumstances. Example: Stop immediately and post an error; retract and then post an error, etc.

- Reduce tooling costs
- Shorten downtime
- Reduce maintenance costs

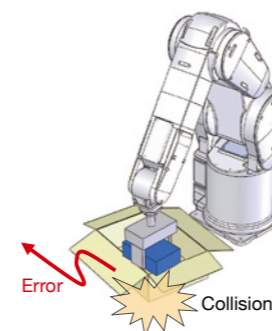

Function for passing through the singular point

- The robot can be made to pass through the singular point. This allows for greater flexibility in the layout of robots and surrounding areas.
- Teaching operations can be performed more easily as there is no longer any need to cancel operations due to the presence of the singular point.

What a singular point is:
There is an unlimited number of angles at which the J4 and J6 axes can be set such that the angle of the J5 axis is 0° when linear interpolation operations are performed using position data from a joint coordinate system. This point is the singular point and is the point at which the robot cannot be operated at an assigned position and posture under normal conditions. The position at which this occurs is referred to as a singular point.

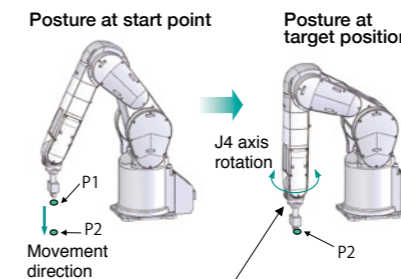

In moving from P1→P2, if the robot is passing the singular point (J5 axis = 0°) or a location in the vicinity at a constant posture, the J4 axis on the robot will rotate at high speed and be unable to pass through it.

Orthogonal compliance control

- This function reduces the rigidity of the robot arm and tracks external forces. The robot itself is equipped with a compliance function, which makes special grippers and sensors unnecessary.
- This allows the amount of force generated through interference during chucking and workpiece insertion to be reduced and external movement copying forces to be controlled.
- The compliance direction can be set arbitrarily using the robot coordinate system, the tool coordinate system, etc.
- This is useful in protecting against workpiece interference and cutting down on stoppage.

- Reduce tooling costs
- Shorten line stop times
- Shorten startup times

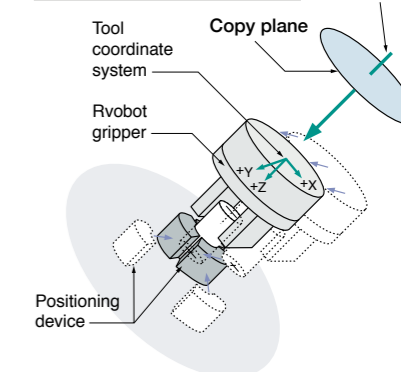



Greater advances in intelligent technology

Predictive maintenance function

Fault detection function



Mitsubishi's unique technology can detect signs of failure. This enables maintenance to be performed before a serious failure and reduces downtime.

Applicable parts :Reduction gears, encoders, batteries

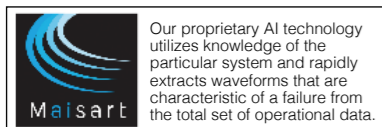

Features

Able to detect early signs of a failure

Our unique fault detection technology allows quick detection of abnormalities in drive system components before they have a chance to affect robot behavior.

No need for additional sensors or equipment

The robot controller is equipped with special fault detection AI processing that significantly reduces the number of required calculations by utilizing the knowledge of the particular system. This allows highly sensitive fault detection using only the existing controller without the need to add any analysis devices or sensors.

Preventive maintenance function

Maintenance simulation



This can be used to estimate the maintenance component replacement and component overhaul maintenance timings. This estimated information can be used to review the maintenance cycle beforehand and to verify operation to extend the service life of the robot.

Output data

Grease replenishment period (per axis) / Timing belt replacement period (per axis) / Recommended maintenance period for overhaulable parts (per axis)*1

*1 Among overhaulable parts such as reduction gears, bearings, ball screws, and ball splines, the part which needs to be overhauled the earliest will be displayed.

Features

Estimates the maintenance period according to operating conditions

It is possible to calculate the parts replacement and recommended maintenance periods when a specific operation pattern (robot program) is repeated.

Supports the investigation of robot-friendly operation

It is possible to estimate the service life of the robot through an offline simulation.

It is possible to verify operation while considering tact time and service life even when changing operation programs.

Wear calculation function

This function estimates the degree of wear of components from the robot operating status. It aids the implementation of efficient maintenance practices by providing maintenance timing notifications (with dedicated signal outputs, warning outputs), and by deciding the maintenance priority, etc.

Applicable parts :Consumable parts (grease, timing belts, etc.), overhaulable parts (reduction gears, bearings, ball screws, ball splines)

Features

Allows you to understand the degree of wear for major components

Allows you to use a dynamic model and drive data to calculate physical quantities such as velocity and forces acting on a component. It is possible to calculate the degree of wear for each part using its service life formula.

Appropriate maintenance period notifications

The system can issue a warning or output a signal to notify the user that maintenance is required.

Total score

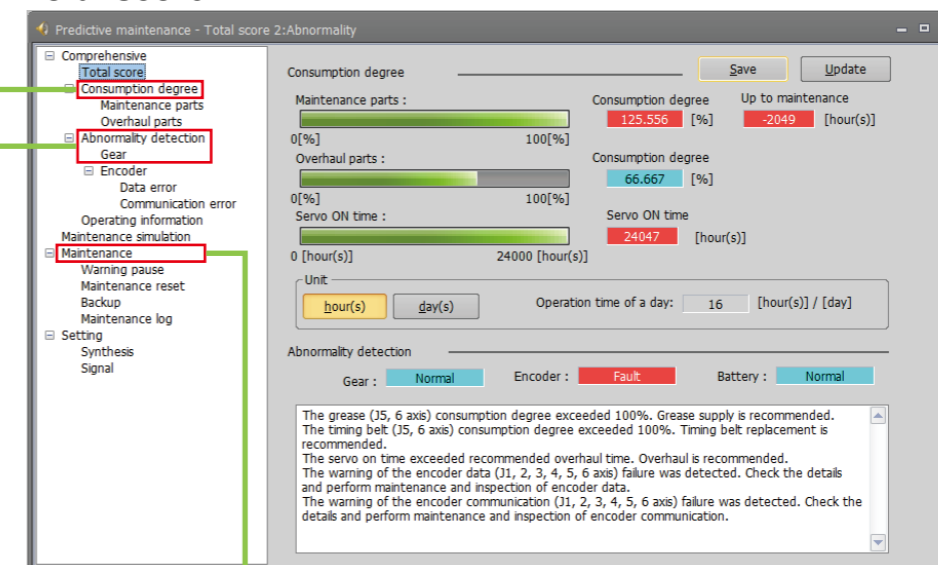

The total score screen allows you to check the state of the robot at a single glance.

Wear calculation function

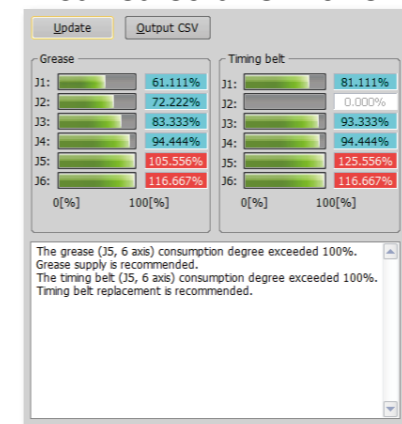

The degree of wear of maintenance components and overhaul components is color-coded, so components needing replacement can be quickly identified.

Maintenance simulation



The maintenance period can be predicted in advance through simulation.

Fault detection

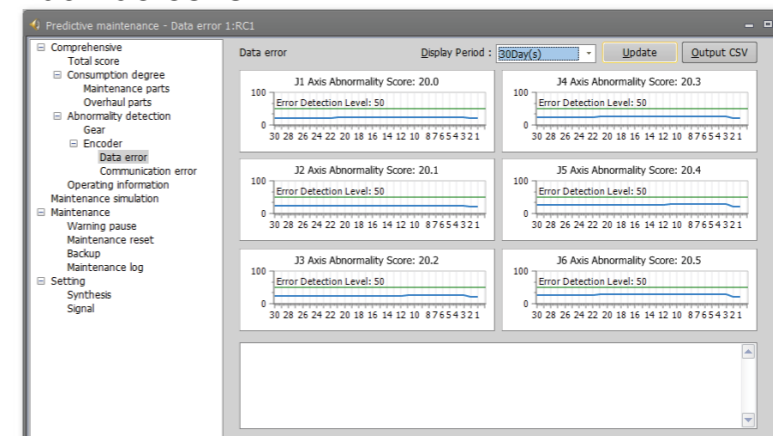

Allows you to view the fault score of the drive system components at a glance.



Greater advances in intelligent technology

Calibration assistance function

Automatic calibration

Commands for calibrating the robot and 2D vision are included. This automates the teaching work required for existing calibration and allows calibration to be conducted using robot programs. A function is also provided that uses screen deviation to compensate for vision sensor mounting error, ensuring more accurate calibration.

	Current method (manual)	Automatic calibration
Working time (minutes)	20	1
Calibration accuracy (mm)	±0.2	±0.05

(Mitsubishi Electric measurements)

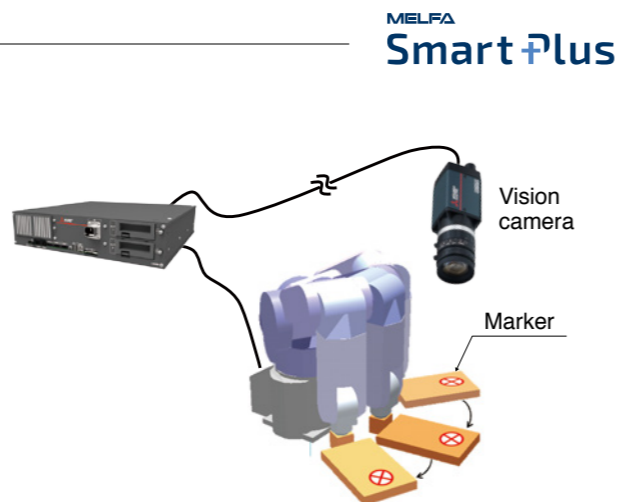

Workpiece coordinate calibration

Features 2D vision sensors mounted on the robot gripper and commands that calibrate work coordinates defined on the work palette, automating the teaching work required for existing calibration and allowing calibration to be conducted using robot programs. This simplifies tasks such as the calibration of work palettes and robots installed on dollies or automated guided vehicles (AGVs).

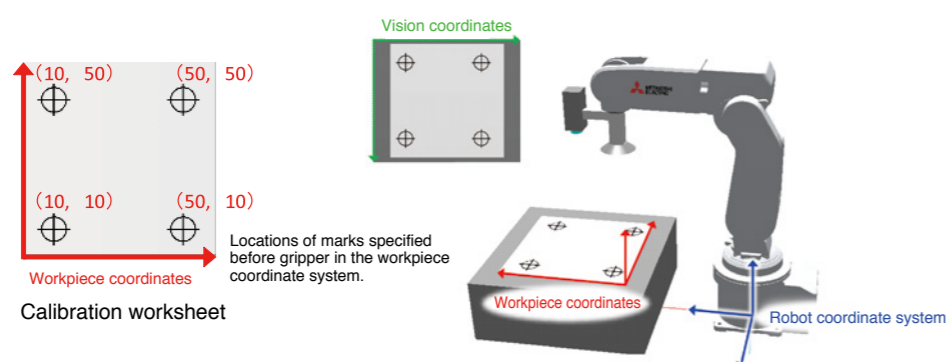

Inter-robot relational calibration

Coordinated work can be simplified by running robot programs to calibrate workpiece coordinates that are shared among multiple robots fitted with 2D vision sensors on their grippers.



Coordinated control for additional axes

- Allows synchronized operation where a robot is installed on an additional axis (linear axis) and its speed relative to the workpiece is specified.
- Supports machining of large workpieces using linear, circular or spline interpolation that exceeds the robot's range of movement.

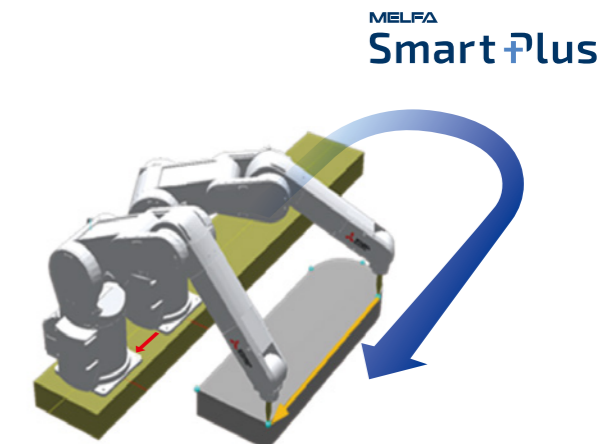

- Allows synchronized operation where tracking of the robot and workpieces on an additional axis (linear axis) is specified.
- Linear or circular interpolation while the workpiece is being transported allows operations such as precision sealing work and surface inspections.

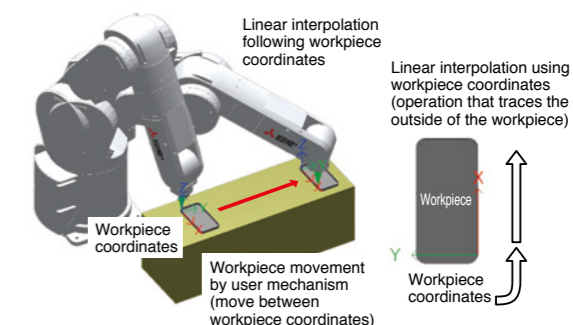

Robot mechanism temperature compensation function

- Monitors the robot arm temperature and automatically compensates for deviations caused by thermal expansion in the arm.
 - Positional errors due to thermal expansion in the arm when seasonal or time-period-related temperature changes arise are reduced to 1/5th* of previous levels. (Under Mitsubishi Electric measurement conditions)
- *It may change depends on models and environment around the robot.



Range error relative to start position

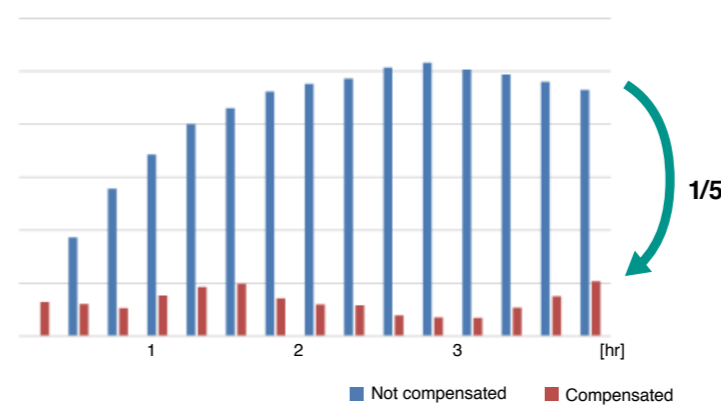

Thermal expansion estimated and corrected

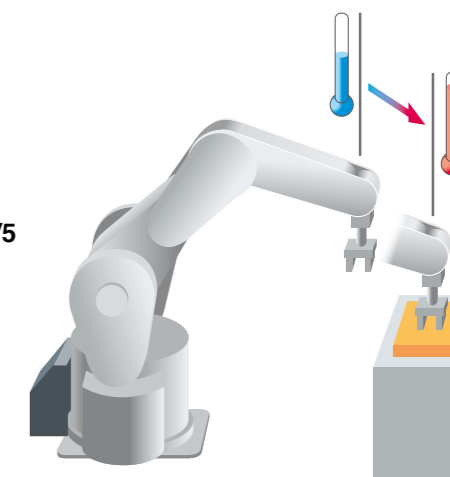



Enhanced cooperation with FA products

iQ Platform

- Collaboration with MELSEC Q series/MELSEC iQ-R series realize more advanced work
- Shorter I/O processing times due to faster communication between CPUs
- PLC management allows large volumes of information to be sent to and from robots in real time
- Allows direct read/write operations to memory shared between robot CPUs

CC-Link IE Field/SLMP

Allows seamless data communication from production management down to the level of devices

GOT integration

- Provides easy recipe management through checking of robot operations and information, data collection and setup switching
- Integrates production site operations with the GOT for improved operation and maintainability

Maintenance

Information before and after errors occur (state changes, I/O, external system variables, etc.) and program run states can be saved as log data, simplifying error identification.

Easier robot information management

Data specific to robot mechanisms is recorded and saved inside the mechanisms, simplifying maintenance.

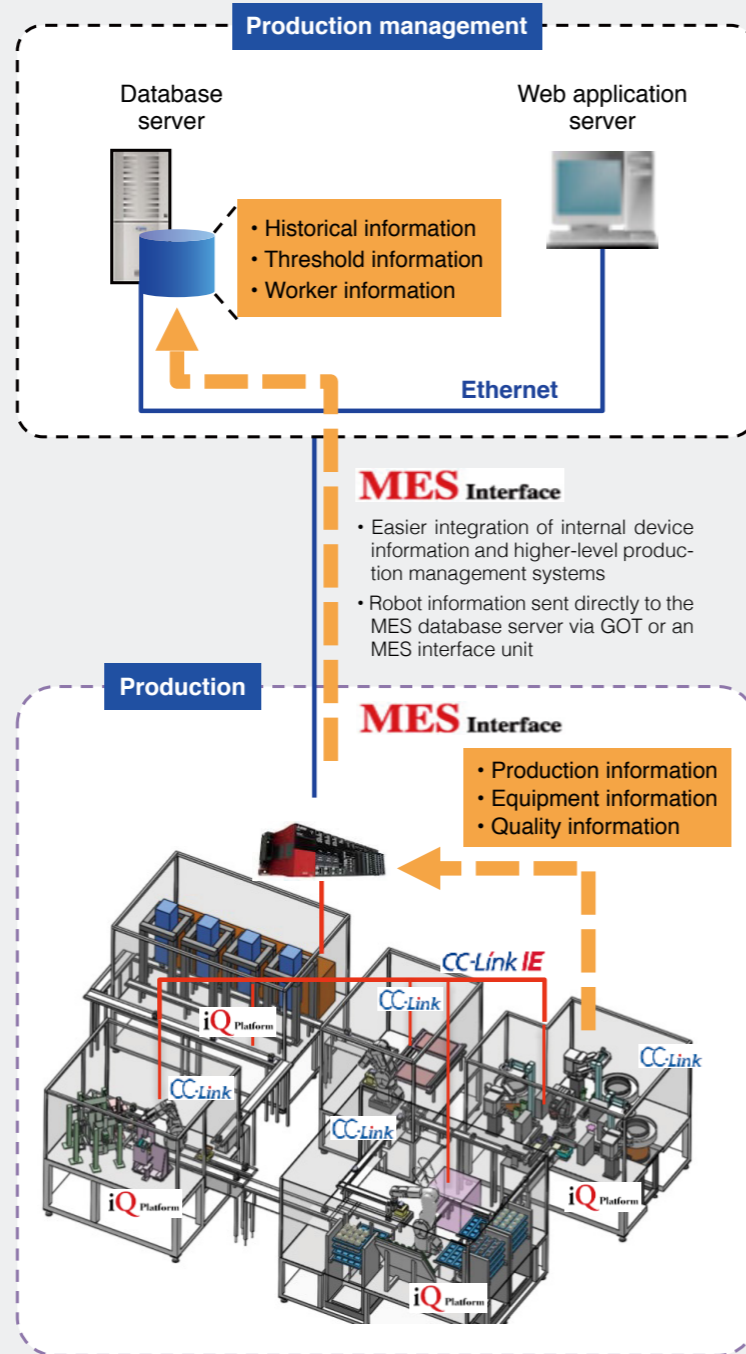

iQ Platform

Integration with the MELSEC iQ-R series PLCs enables more advanced tasks.

Better responsiveness due to faster communications

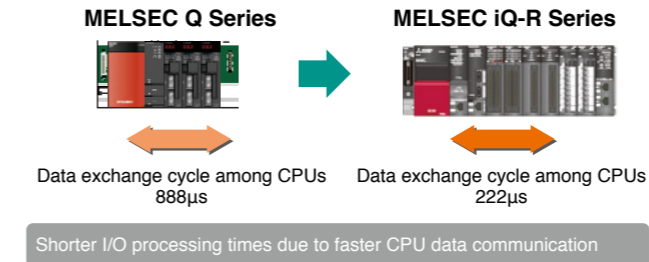

Large volumes of data

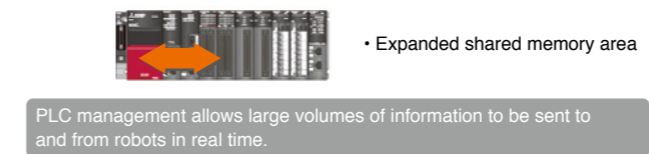

Direct communication between CPU units

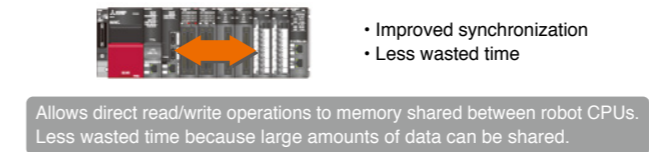

Batch management of multiple robots

Robots on the PLC network can be accessed from a computer connected to the main CPU. Allows shorter startup times for robots on the production line and improved maintenance.

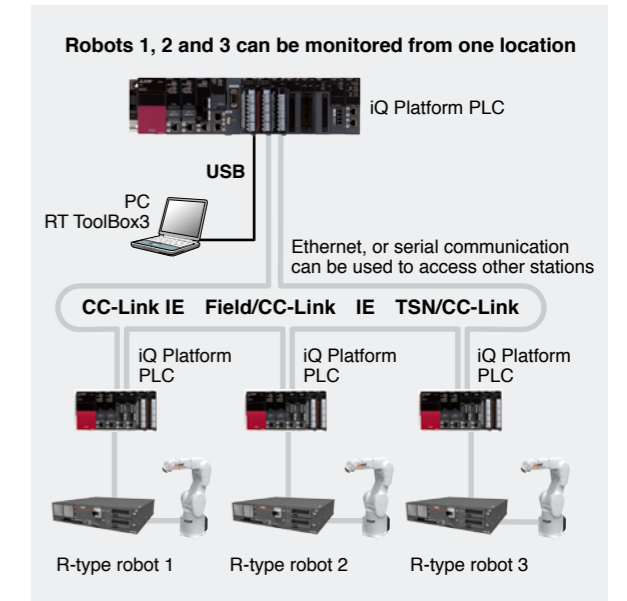

CC-Link IE Field/SLMP

- Compatible with CC-Link IE Field and SLMP.
- Allows seamless data communication system-wide, from the production management level down to the device level.

- Allows simple connection using just LAN cables.
- Enables general-purpose Ethernet devices compatible with SLMP (vision sensors, etc.) to be used with robot programs.
- Allows robot information (device information) to be collected from higher level devices.

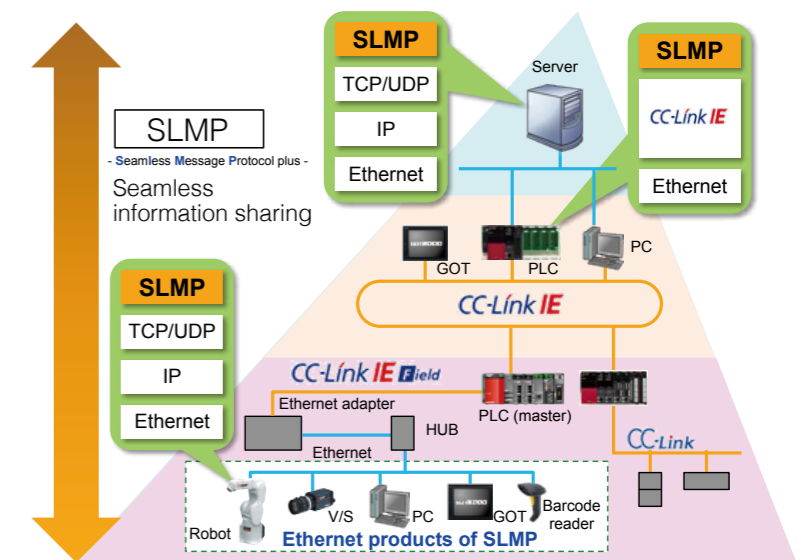

Various network options

The various network options allow connection to a variety of devices.

- | | | | |
|---------------------|---|---------|---|
| Standard equipment: | Ethernet | Option: | CC-Link |
| | USB | | Profibus |
| | SSCNET3 | | DeviceNet |
| | CC-Link IE Field Basic (Ver.A1d or later) | | Network base card (CC-Link IE Filed, EtherNet/IP, PROFINET, EtherCAT) |



Enhanced cooperation with FA products

GOT integration

The GOT integration function makes it easy to use features such as recipe functions through setup switching, data collection and checking of robot operations and information. Production site HMIs can be integrated with GOT to help improve operation and maintainability.

GOT backup/restore functions

Data such as robot programs and parameters can be saved (backed up) onto the GOT SD card or USB memory stick using the GOT backup and restore function.

By backing up the GOT beforehand, operation can be restored with the GOT with no need for a personal computer (GT21 and higher). This greatly improves serviceability. The situation is saved even when an unexpected error occurs. This helps prevent data from being lost due to the empty battery or robot malfunction.

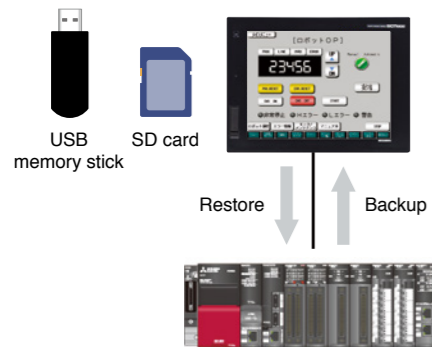

Shared memory expansion

Enhanced efficiency of monitoring and maintenance operations onsite using a single GOT (display device) as the Human Machine Interface (HMI).

Example of GOT display



Enables the robot to be controlled from the GOT even without a teaching box. Current robot position data, error information, etc. can be displayed easily on the GOT.

Internal robot information

- Error, variable, and program information
- Robot status (Current speed, current position, etc.)
- Maintenance information (Remaining battery capacity, grease life, etc.)
- Servo data (Load factor, current values, etc.)

Sample image files can be downloaded from the Mitsubishi Electric FA website.

- Useful sample image files that can immediately be used in actual systems.
- Sample sequence programs (function blocks) are provided for using the sample image files.

Note) The sample image files are for the GT27 (640x480 or better). To use the files, GT Designer3 Version 1.178L or later is required.

Device monitoring function

Allows the status of FA equipment such as PLCs, motion controllers, robot controllers and CNCs to be checked without a computer. Useful for tasks such as starting up devices.

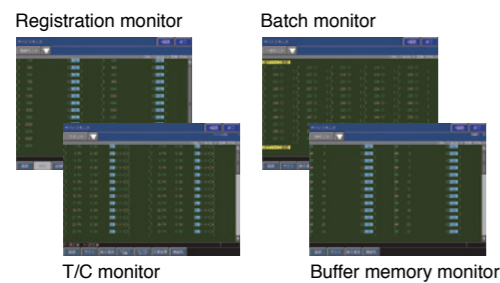

MELFA Smart Plus connection (GOT Drive)

Various GOT connection screens have been prepared to provide full support from robot startup to maintenance. There is also a variety of preventive maintenance and predictive maintenance screens that are compatible with MELFA Smart Plus. These allow you to easily check the condition of overhaul components and confirm maintenance timing.

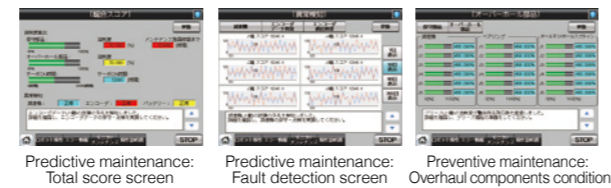

Sample image files can be downloaded from the Mitsubishi Electric FA website.

- FR series GOT2000 sample image files can immediately be used in actual systems.
- Signal control between the GOT and the robot is performed using the GOT scripting language.

Note 1) The sample image files are for the GT27 (640x480 or better). To use the files, GT Designer3 Version 1.178L or later is required.
 Note 2) If you create a ladder program to control a robot via a programmable controller, neither the GOT nor the ladder program will operate normally.

Logging & graphs list

Uses GOT to collect and display data from equipment such as PLCs and robots. Data can be checked in readily understandable graphs and lists, allowing early identification and analysis of the causes when faults occur.

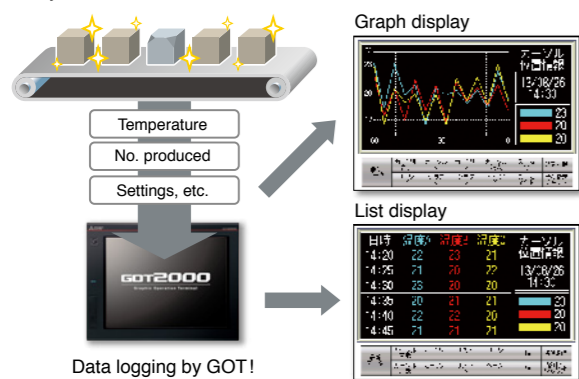

Support for the "e-F@ctory" FA integrated solution

Robot information can be sent to the MES database server using PLCs and MES interface units. The simple system construction allows you to obtain the robot production information (using the device allocation function).

Simple connection and integration of various types of FA devices (PLCs, GOT, servos, etc.). The GOT MES interface function can be used to integrate various types of information from FA devices, including robots, thereby improving productivity and maintainability.

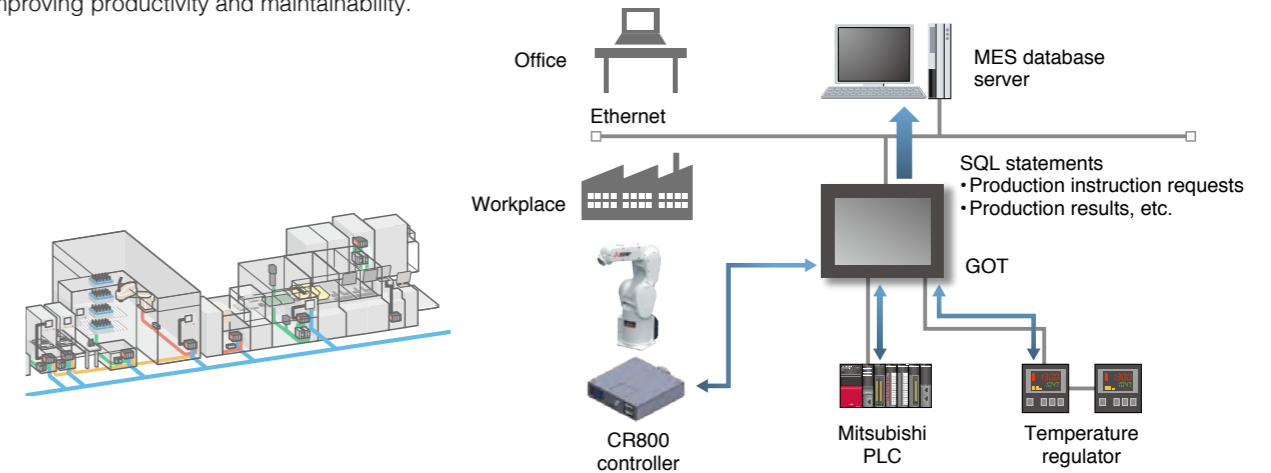

Recipe function

Since the data for each product is stored in the GOT with only the necessary data sent to the programmable controller, it is easy to perform setup changes, even with production lines that have a variety of models.

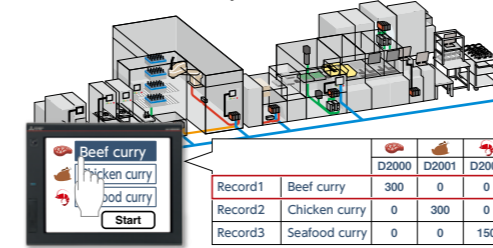

GOT connection (transparent function)

The transparent function can be used to edit programs and parameters from the USB interface on the front of the GOT. This makes operation much easier. (For the GT21 model or later)

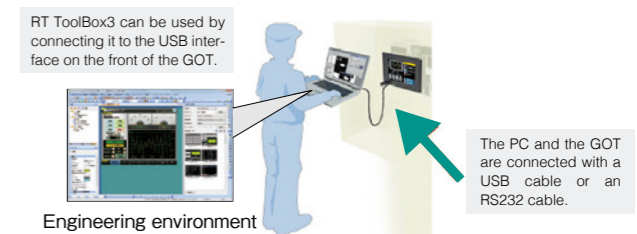

Maintenance (log function)

Robot information before and after an error occurs, and the program execution status can be automatically sent to the FTP server or saved on an SD card as log data. The operation log can also be retrieved, so causes of errors can be analyzed efficiently. (RT ToolBox3 is required.)



*It works only on FR series D type (CR800-D)

Easier robot information management

Memory is included in the robot body and used to store robot-specific information. This makes it easy to switch robot controllers. Information can also be collected without visiting the workplace, simplifying the formulation of maintenance plans.

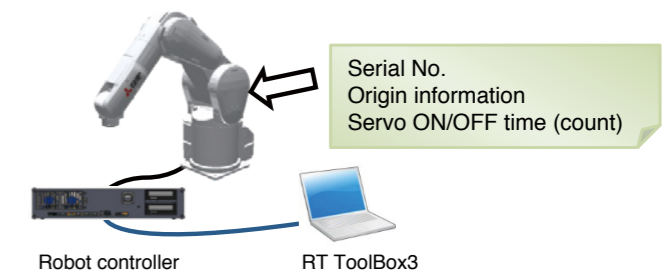



Improved safety through collaborative work applications

Safety functions ensure that automation is simpler, safer and more user-friendly.

Collaborative human-machine operation support that includes safety options allows working areas to be used jointly by people and robots. This ensures that factories provide both productivity and flexibility.

*Customers must conduct risk assessments.

Safety monitoring function

Safety features are provided that make risk assessment easier.

Safety I/O

Supports safe system connection through duplicated safe I/O (8 inputs and 4 outputs)

Safety communication function NEW

CC-Link IE TSN safety communication function (CR800-R) is supported for a simpler system configuration.

Position monitoring function

- Monitors robot positions
- Monitors movement into designated areas (8 locations)

Speed monitoring function

- Monitors robot speeds
- Also capable of monitoring each of the speed components in the X, Y and Z directions for the monitoring point

Safety logic editing

Allows the working parameters (logic) of the safety monitoring function to be defined.

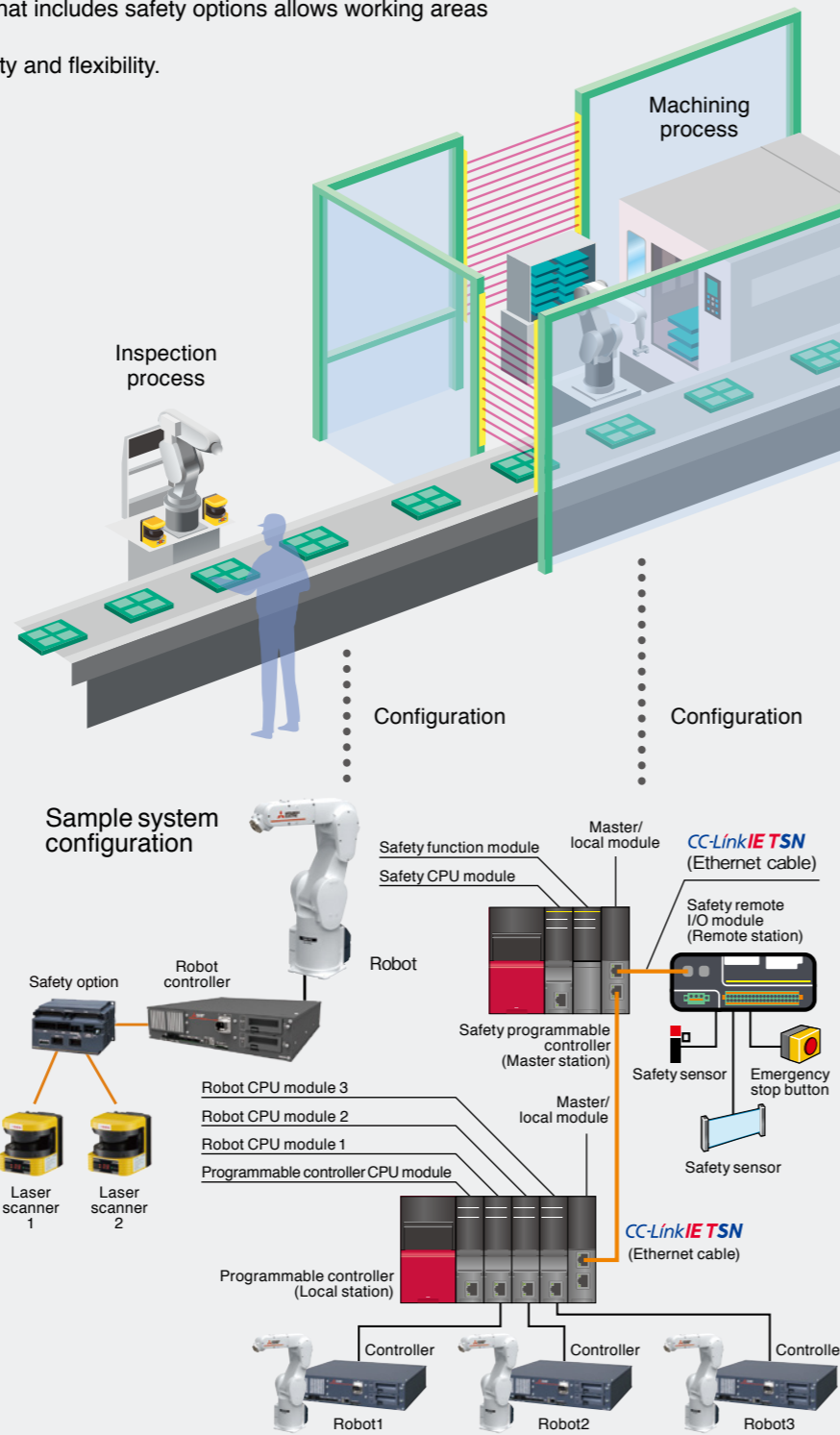

Safety option / Features

Operators can enter an operation area without stopping robots.

- **High safety compliant with international standards**
- **Robot's automatic operation continues even with a safety fence opened.**
The safety input function enables safety doors to open without causing an emergency stop of the robot.
- **Operators and robots share an operation area. = They can cooperate.**
While an operator is in a cooperative operation area, a robot does not approach the area. (Operation range limit function)
- **Robots in cooperative operation keeps the safety speed.**
A robot in cooperative operation continues its operation at the safety speed to secure operator's safety.
- **Robots can automatically shift to single operation from cooperative operation.**
Closing the safety door switches cooperative operation to single operation, and enables the robot to approach to the shared area.

*Risk assessment and safety level proof need to be performed for the system. Please contact us if you require any further information.

Examples of safety options

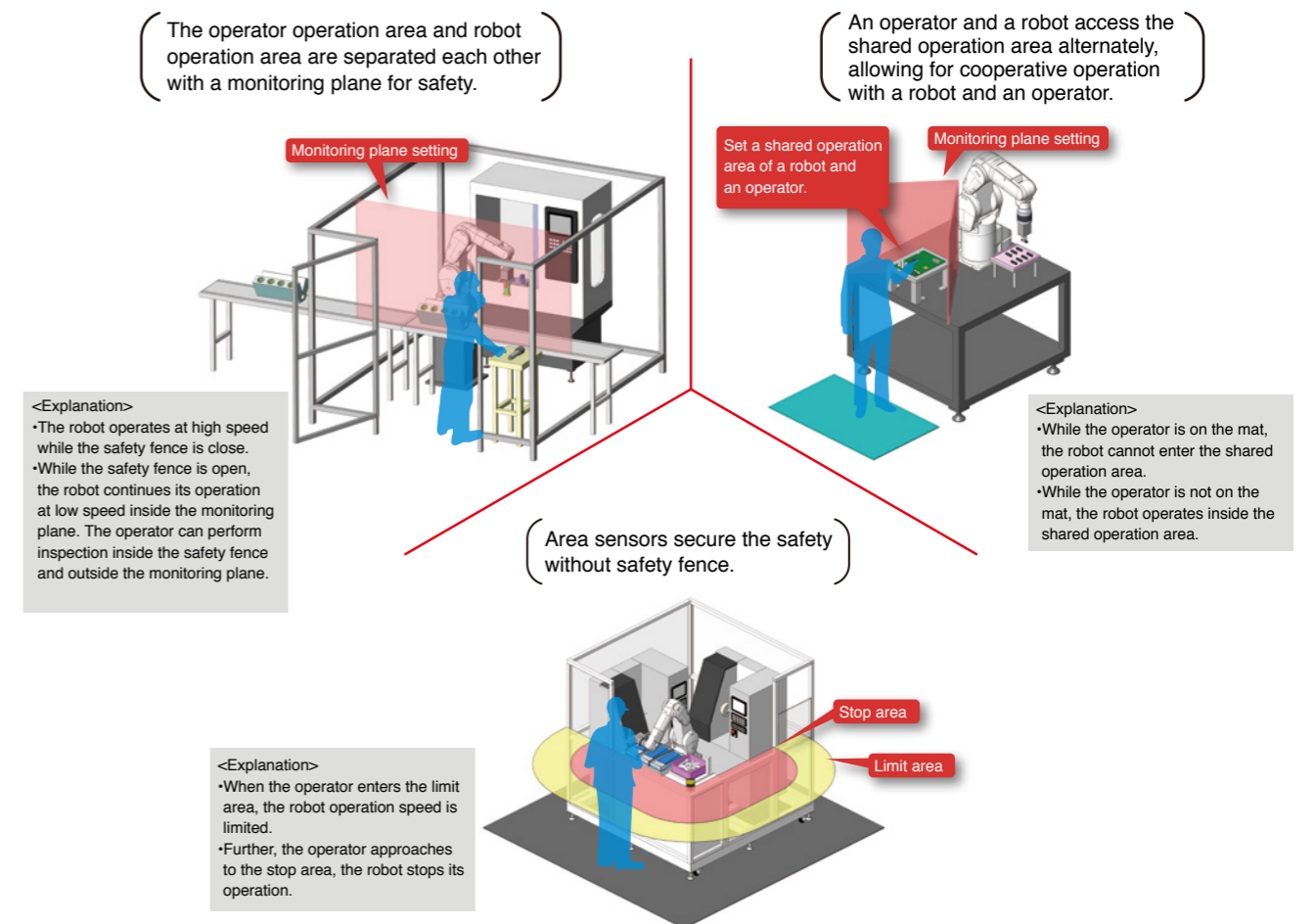



Improved safety through collaborative work applications

Safety monitoring function

Safety features that are compliant with the requirements of international standards are provided to make risk assessment easier.

Safety feature ^{*1}	Details	Safety performance ^{*2}	Remarks
STO function	Electrically shuts off driving power to the motors in the robot body.	Category 3, PL d, SIL2 (factory default settings) ^{*3} Category 4, PL e, SIL3 (when parameter settings are changed)	Supported as standard (Safety option not required)
SLS function	Monitors the TCP speed so that it does not exceed the monitoring speed.	Category 3, PL d, SIL2	Supported in combination with safety option.
SLP function	Monitors a specified monitoring position so that it does not go beyond the position monitoring surface.		
SOS function	Monitors the robot to ensure that it does not move from its stop position.		
SS1 function	Function stopped by STO.		
SS2 function	Function stopped by SOS.		

*1 Safety features are based on EN 61800-5-2. *2 Safety performance is based on IEC/EN 61508 and EN ISO 13849-1. *3 The STO function meets the requirements of SIL2, Category 3, and PL d when activated by the robot controller's external emergency stop input (when input diagnosis by test pulse is not set) and the safety extension unit input signal of the safety option. The STO function meets the requirements of SIL2, Category 4, and PL e when activated by the robot controller's external emergency stop input (when input diagnosis by test pulse is set) and CC-Link IE TSN safety communication function.

2 Functions

Stoppage monitoring function

- This function monitors the robot for any stoppages without interrupting the power supply to the motors.

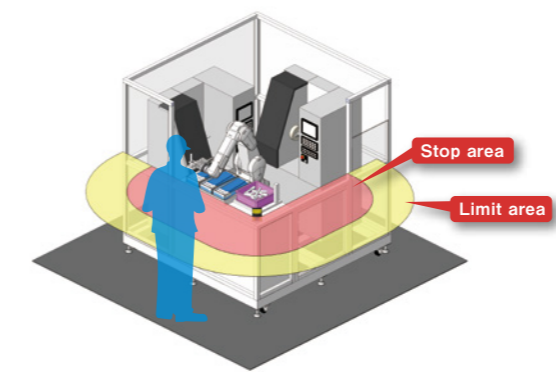

Position monitoring function

- Monitors robot positions.
- Monitors movement into designated areas in up to 8 locations.

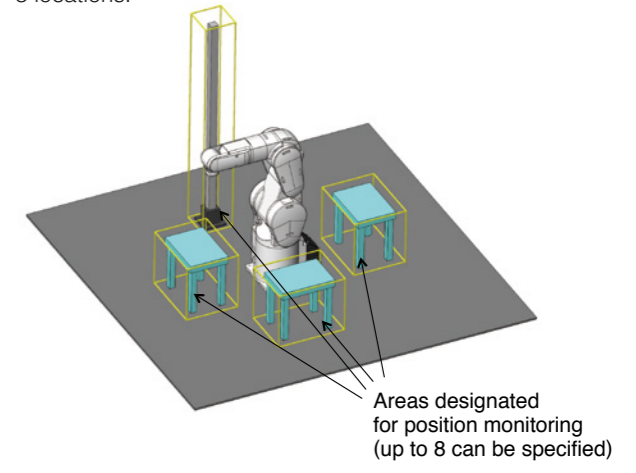

2 Functions

Safety I/O

Expands duplicated safe I/O to 8 inputs and 4 outputs. Allows the construction of various different safety systems.

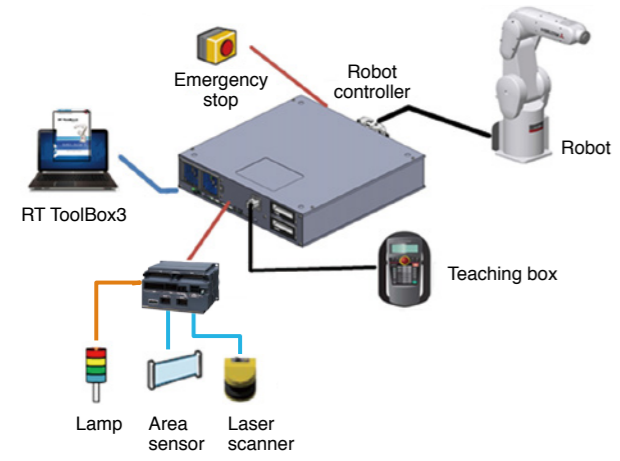

Safety communication function NEW

CC-Link IE TSN safety communication function (CR800-R) is supported for a simpler system configuration.

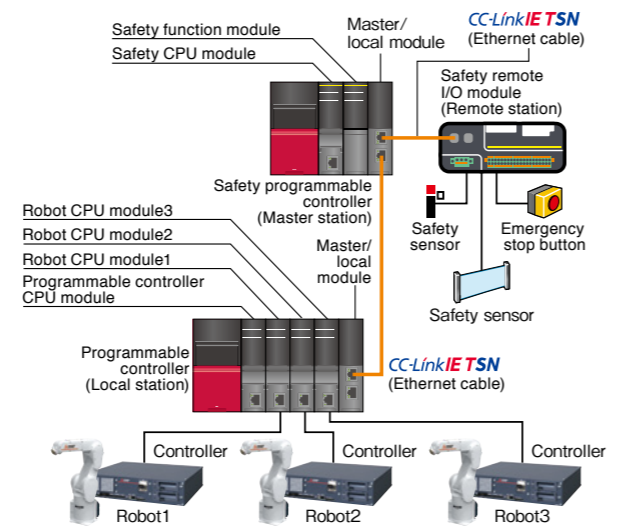

Speed monitoring function

- Monitors robot speeds
- Monitors designated monitoring points on the the robot arm and gripper to ensure that they do not exceed the monitoring speed.
- Also allows monitoring of each of the X-, Y- and Z-direction components for each monitoring point. By setting a low monitoring speed in the system for directions in which the robot does not move, safe distances can be made smaller to create compact cells safely.

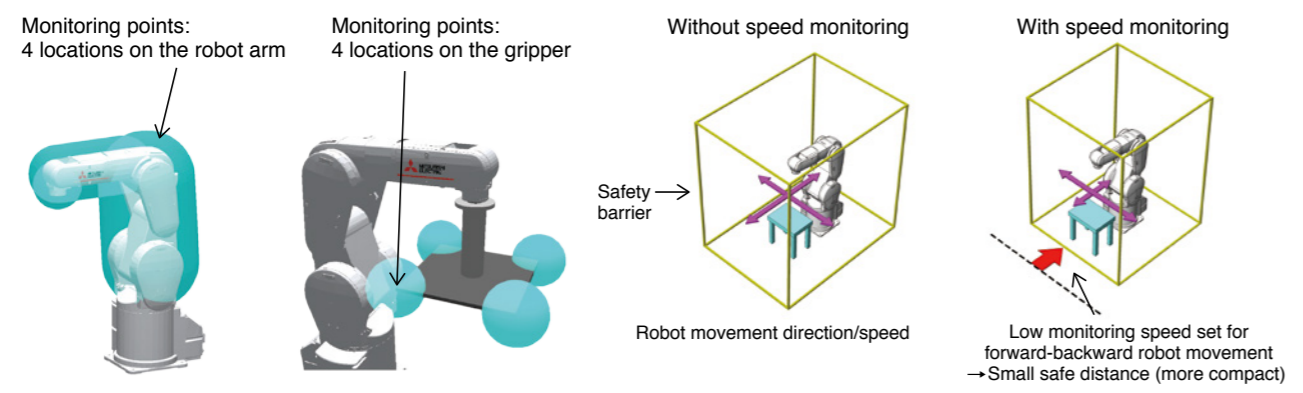

29

Safety logic editing

The safety logic editing function makes it easy to construct and operate safety systems. Because it allows you to freely define the operating parameters (logic) for the safety monitoring functions in the robot controller, you can configure the safety monitoring conditions without having to use a safety CPU.

By configuring the parameters in the editing screen, you can utilize interlock monitoring that combines safety I/O and position monitoring.
 Position monitoring: Activates the specified function according to the position of the robot.
 Interlock monitoring: Activates the specified safety function according to the position of another robot.

Usage scenarios

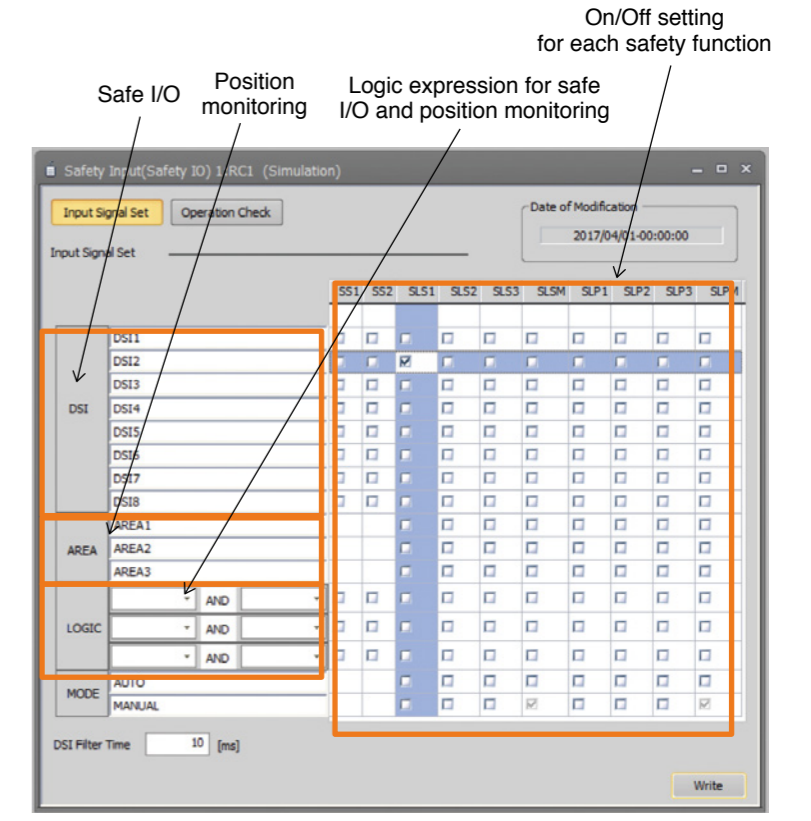
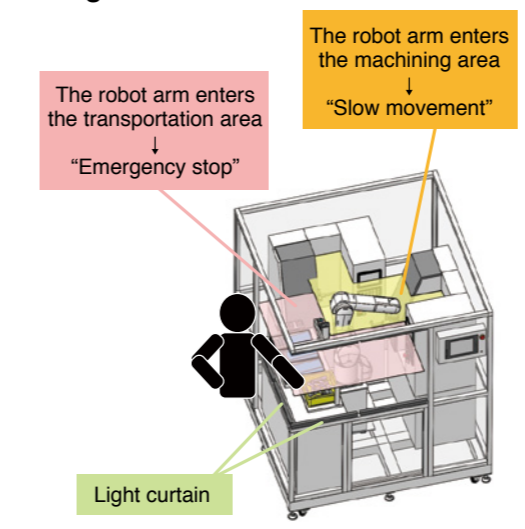

Safety logic editing screen

30



Program Creation and Total Engineering Support Software

2 Functions

RT ToolBox3

This is computer software to assist with a range of tasks from system startup through to debugging and operation. This includes creating and editing programs, checking the operating environment prior to robot installation, estimating cycle times, debugging when robots are started up, monitoring robots states once they are running and monitoring faults. Its features include a ribbon bar, output window and docking pane, making information easier to see and the software easier to use. Operations in the 3D monitor screen have also been updated to make using the screen more intuitive.

RT ToolBox3 mini	Simplified version. Offers programming, debugging, and monitoring functions.
RT ToolBox3	Includes simulation functions. May also be used for preliminary examinations.
RT ToolBox3 PRO	Runs on 3DCAD (SolidWorks). Allows even more realistic examinations. CAD data can also be used for path generation and operation programs.

Program editing and debugging

Auto-complete and fold functions make programming easier to use.

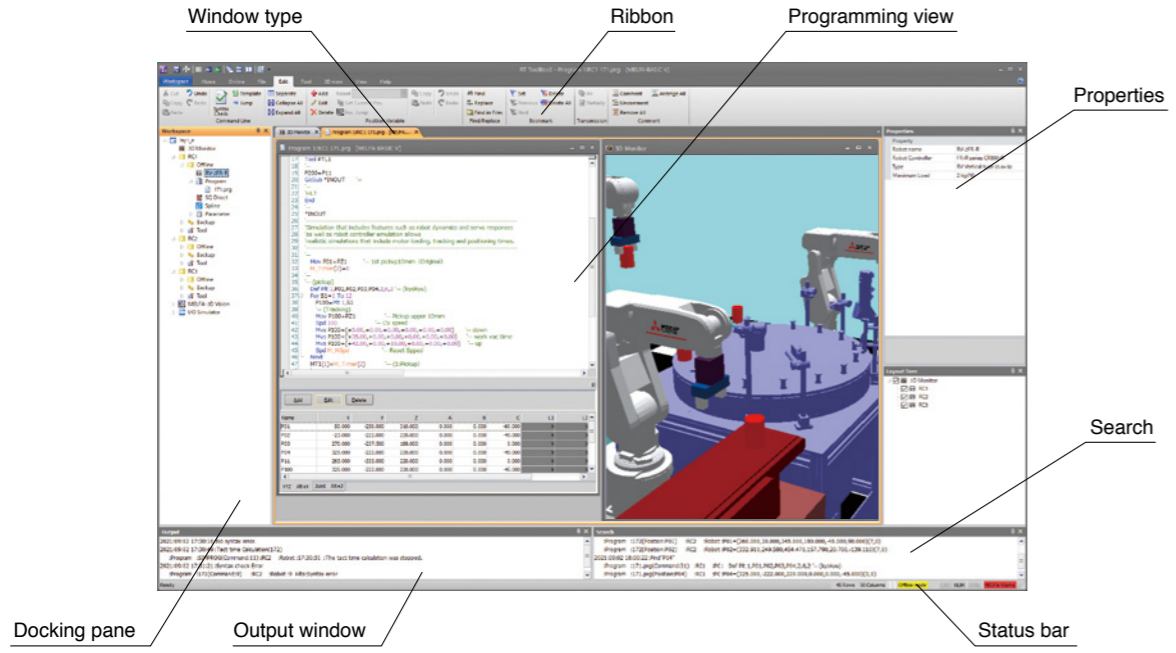

Simulation function

Simulation that includes features such as robot dynamics and servo responses as well as robot controller emulation allows realistic simulations that include motor loading, tracking and positioning times.

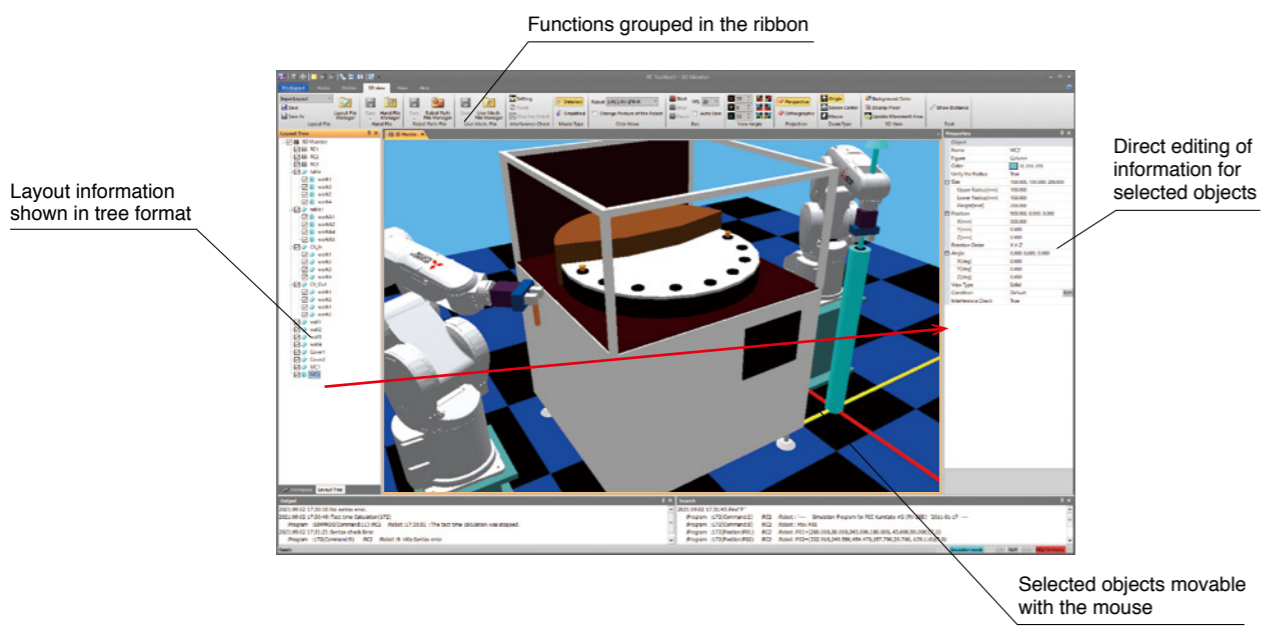

3D viewer

The 3D viewer can be used to check the robot attitude and operation and to visually check information such as limit values for user-defined areas, etc.

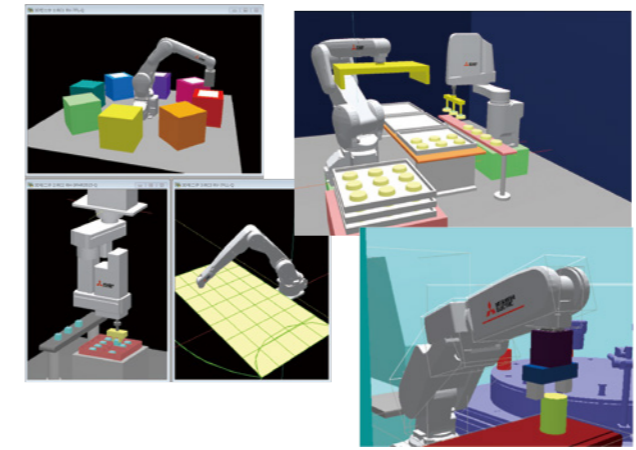

Real time external control

Robot movement can be controlled from the computer using synchronous units.

Melfa RXM.ocx communications middleware

Allows RT ToolBox functions to be run from computer applications.



MELFA BASIC VI

As well as providing a more complete set of commands, this uses structured programming to give high levels of reusability and readability.

Structured programming

Allows structured programs, enabling programming with high levels of reusability and readability. (Also supports existing programming methods.)

```

1 Function Main 'Entry point
2 MResult = FnMMove(P1, P2)
3 MResult = FnMMove(P3, P4)
4 FEnd
5
6 Function FnMMove(P1, P2) 'User function
7 Mov P1
8 Mov P2
9 Return 1
10 FEnd
    
```

Monitoring functions

As well as monitoring program run states, variables, input/output signals and other events, these functions can show graphs of robot operation waveforms (speeds and current values) and I/O states in real time. This makes it easy to see the correlation between program execution steps and waveform data, making debugging markedly more efficient.

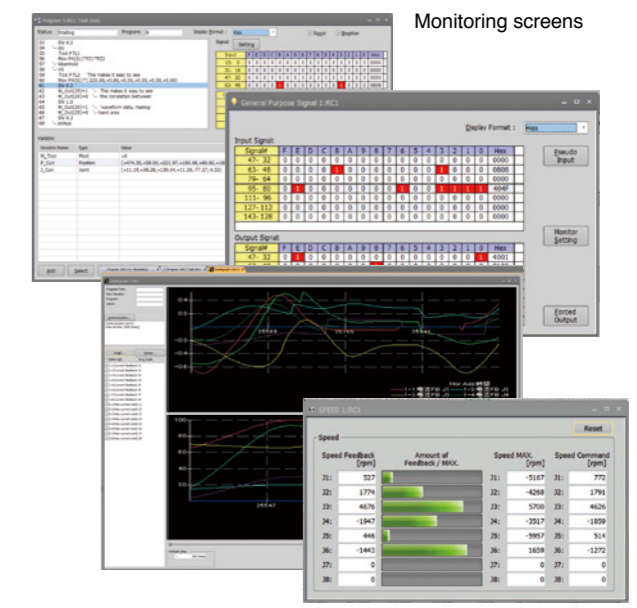

Library function

Keeping a library of program processing allows knowledge to be accumulated and provides improved reusability. The libraries can also be hidden to prevent knowledge from being disclosed.

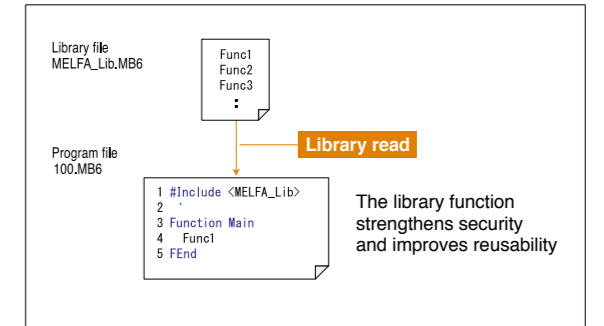

2 Functions

MELFA
RV-2FR
RV-2FRL

Vertical
2kg
type

RV-2FR
RV-2FRL



Compact body and slender arms cover large work areas. An ideal robot for compact cell construction. Perfect for transporting, assembling and inspecting small components.

- Among the fastest moving robots in its class [Max. composite speed: 5.0 m/s] (RV-2FR)
- Standard cycle time [0.6 second range] (RV-2FR)
- Pivotal operating range: ±240°
- Environmental specifications [standard: IP30]
- Standards compliance
Compliant with European Machinery Directives (CE) as standard. Compliance with other standards is available in specialized machines. Contact Mitsubishi Electric for details.

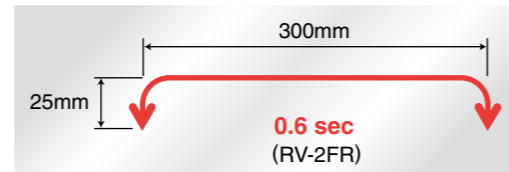

Specifications

Type	Unit	RV-2FR (B)	RV-2FRL (B)
Environmental specifications		Standard	
Protection degree		IP30	
Installation		Floor type, ceiling type, (wall-mounted type *2)	
Structure		Vertical multiple-joint type	
Degrees of freedom		6	
Drive system *1		AC servo motor (J2, J3 and J5: with brake)	
Position detection method		Absolute encoder	
Maximum load capacity	kg	Maximum 3 (Rated 2) *5	
Arm length	mm	230+270	310+335
Maximum reach radius	mm	504	649
Operating range	J1	480 (±240)	
	J2	240 (-120 to +120)	237 (-117 to +120)
	J3	160 (-0 to +160)	
	J4	400 (±200)	
	J5	240 (-120 to +120)	
	J6	720 (±360)	
Maximum speed	J1	300	225
	J2	150	105
	J3	300	165
	J4	450	412
	J5	450	
	J6	720	
Maximum composite speed *3	mm/sec	4955	4200
Cycle time *4	sec	0.6	0.7
Position repeatability	mm	±0.02	
Ambient temperature	°C	0 to 40	
Mass	kg	19	21
Tolerable moment	J4	4.17	
	J5	4.17	
	J6	2.45	
Tolerable amount of inertia	J4	0.18	
	J5	0.18	
	J6	0.04	
Tool wiring		Gripper: 4 input points/4 output points Signal cable for the multi-function gripper	
Tool pneumatic pipes		ø4 × 4	
Machine cable		5m (connector on both ends)	
Connected controller *6		CR800-D, CR800-R, CR800-Q	

External Dimensions/Operating Range Diagram

RV-2FR

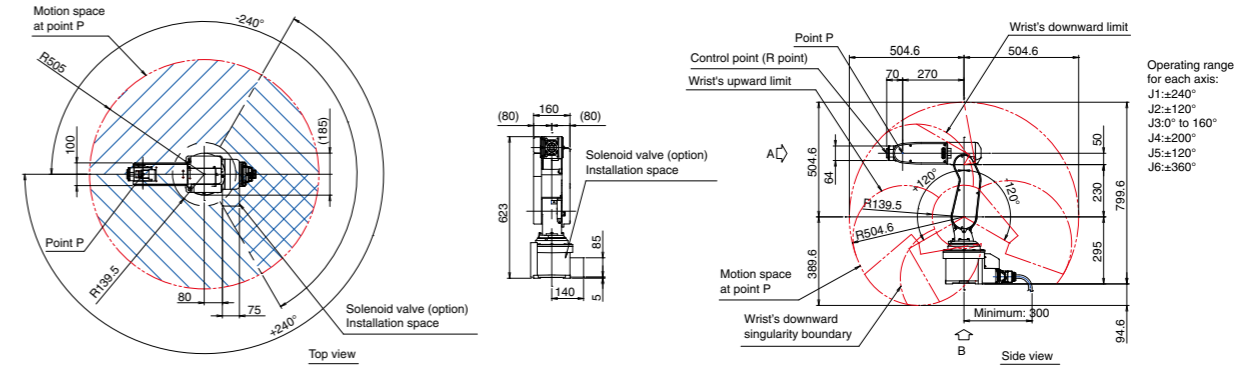

RV-2FRL

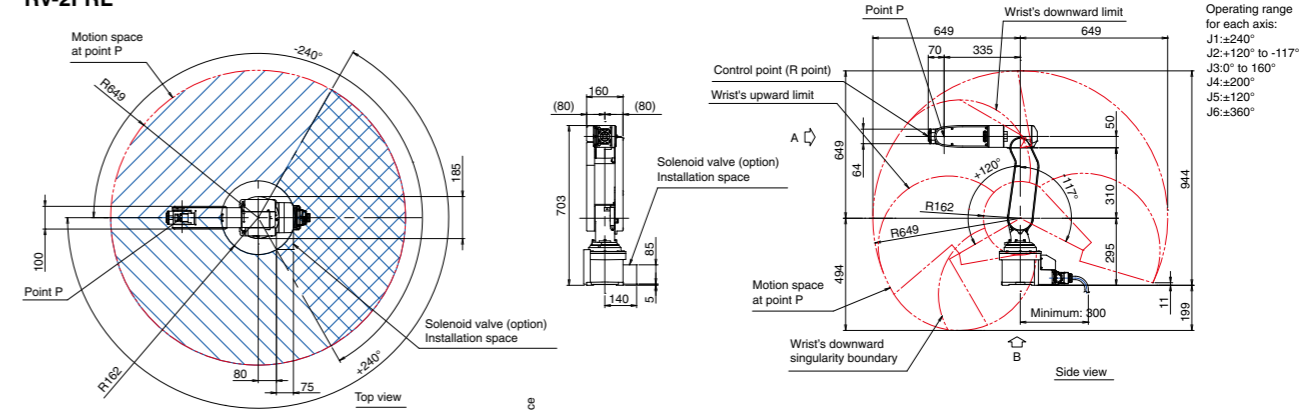

Shared parts

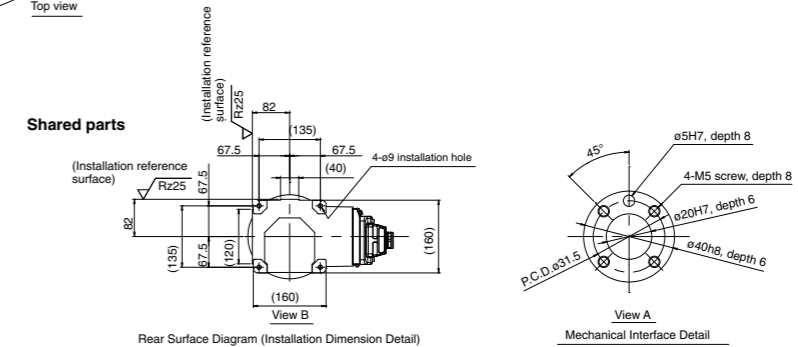

*Operating range limit
 When the J1-axis angle is inside the range of -75° < J1 < 70° and the J2-axis angle is J2 < -110°, operating range of the J3-axis is limited to 80° < J3.

RV-2FR

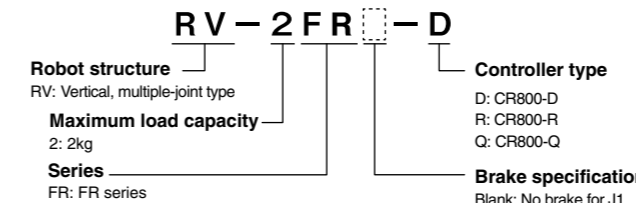

RV-2FRL

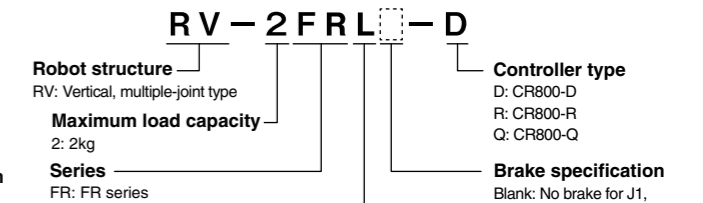

*1: The standard model does not have a brake on the J1, J4, or J6 axis. There are models available with brakes included for all axes.
 *2: The wall-mounted specification is a custom specification where the operating range of the J1-axis is limited.
 *3: This is the value at the surface of the mechanical interface when all axes are composited.
 *4: The cycle time is based on back-and-forth movement over a vertical distance of 25 mm and horizontal distance of 300 mm when the load is 1 kg.
 *5: The maximum load capacity indicates the maximum payload when the mechanical interface is facing downward (±10° to the perpendicular).
 *6: Select a controller according to the application. CR800-D: Standalone type, CR800-R: MELSEC i-Q-R compatible type, CR800-Q: MELSEC Q compatible type.

MELFA
RV-4FR
RV-4FRL

Vertical
4kg
type

RV-4FR
RV-4FRL

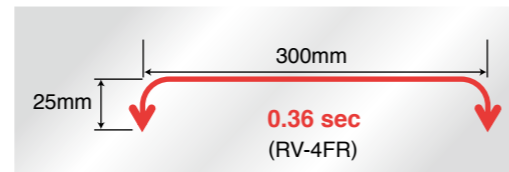

Cutting-edge servo control and optimized arm construction provide extremely fast and precise heavy-duty operation. Flap-style arms provide a range of movement ideally suited to compact areas. The use of space is highly efficient. Perfect for transporting, assembling and inspecting small components.

- Among the fastest moving robots in its class [Max. composite speed: 9.0 m/s]
- Standard cycle time [0.36 s]
- Pivotal operating range: ±240°
- Environmental specifications [standard: IP40; oil mist: IP67; cleanroom: ISO class 3]
- Standards compliance Compliant with European Machinery Directives (CE) as standard. Compliance with other standards is available in specialized machines. Contact Mitsubishi Electric for details.

Specifications

Type	Unit	RV-4FR (M) (C)	RV-4FRL (M) (C)
Environmental specifications		Standard/ Oil mist/ Cleanroom	
Protection degree		IP40 (standard)/ IP67 (oil mist) *1/ ISO class3 *7	
Installation		Floor type, ceiling type, (wall-mounted type *2)	
Structure		Vertical multiple-joint type	
Degrees of freedom		6	
Drive system		AC servo motor	
Position detection method		Absolute encoder	
Maximum load capacity	kg	Maximum 4 (Rated 4) *8	
Arm length	mm	235+275	310+335
Maximum reach radius	mm	515	649
Operating range	J1	480 (±240)	
	J2	240 (-120 to +120)	
	J3	161 (-0 to +161)	164 (-0 to +164)
	J4	400 (±200)	
	J5	240 (-120 to +120)	
	J6	720 (±360)	
Maximum speed	J1	450	420
	J2	450	336
	J3	300	250
	J4	540	540
	J5	623	623
	J6	720	720
Maximum composite speed *3	mm/sec	9027	9048
Cycle time *4	sec	0.36	0.36
Position repeatability	mm	±0.02	
Ambient temperature	°C	0 to 40	
Mass	kg	39	41
Tolerable moment	J4	6.66	
	J5	6.66	
	J6	3.96	
	J6	0.2	
Tolerable amount of inertia	J4	0.2	
	J5	0.2	
	J6	0.1	
Tool wiring		Gripper: 8 input points/8 output points Signal cable for the multi-function gripper and sensors LAN x 1 <100 BASE-TX> *5	
Tool pneumatic pipes		Primary: ø6 x 2 Secondary: ø4 x 8, ø4 x 4 (from base portion to forearm)	
Machine cable		5m (connector on both ends)	
Connected controller *6		CR800-D, CR800-R, CR800-Q	

External Dimensions/Operating Range Diagram

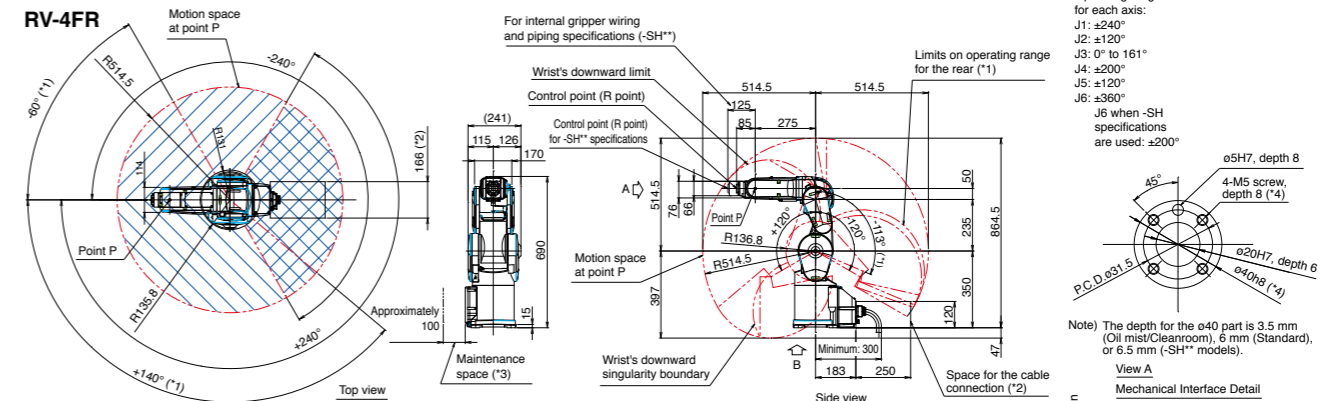

Notes
*1: Limits on the operating range for the back and side parts: When the J1-axis angle is inside the range of -60° ≤ J1 ≤ +140°, the operating range of the J2-axis is limited to -113° ≤ J2 ≤ +120°.
*2: Make sure to leave enough space open for cable connections between devices.
*3: Make sure to leave enough space open for removing and attaching covers during maintenance work.
*4: Specify a thread engagement length of 7.5 to 8 mm.

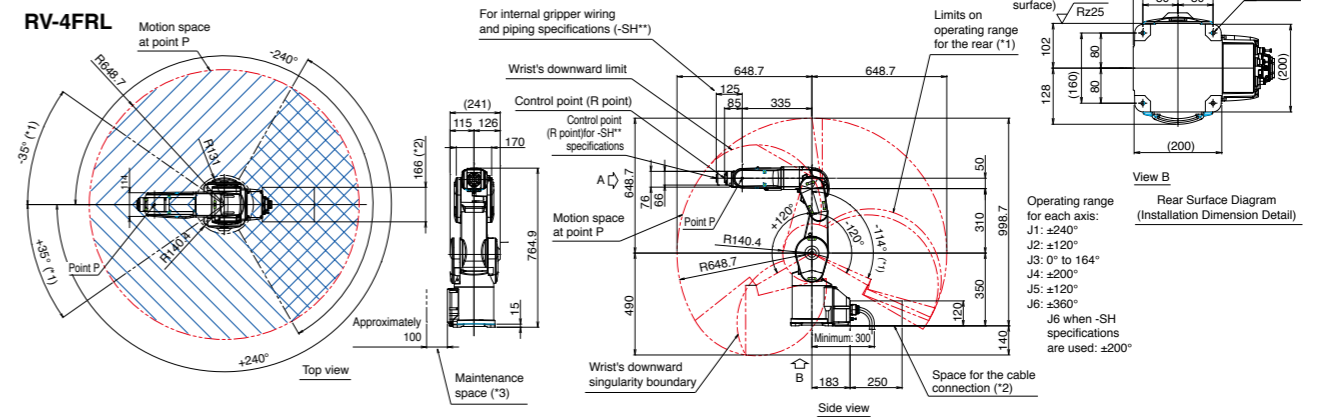

Notes
*1: Limits on the operating range for the back and side parts: When the J1-axis angle is inside the range of -35° ≤ J1 ≤ +35°, the operating range of the J2-axis is limited to -114° ≤ J2 ≤ +120°.
*2: Make sure to leave enough space open for cable connections between devices.
*3: Make sure to leave enough space open for removing and attaching covers during maintenance work.
*4: Specify a thread engagement length of 7.5 to 8 mm.

Mounting cable specifications (*1)

Devices that can be mounted	Model (machine no.)				
	-SH01	-SH02	-SH03	-SH04	-SH05
Air ø4	○ (x4)	-	-	○ (x2)	○ (x2)
Gripper input 8 points	○	○	○	○	○
Vision sensor	-	○	○	-	○
Force sensor	-	○ (may be used for either device)	○	○	-
Electric gripper	-	○	○	-	-

*1) The J6 axis range of motion is ±200deg. Protection level is IP40.

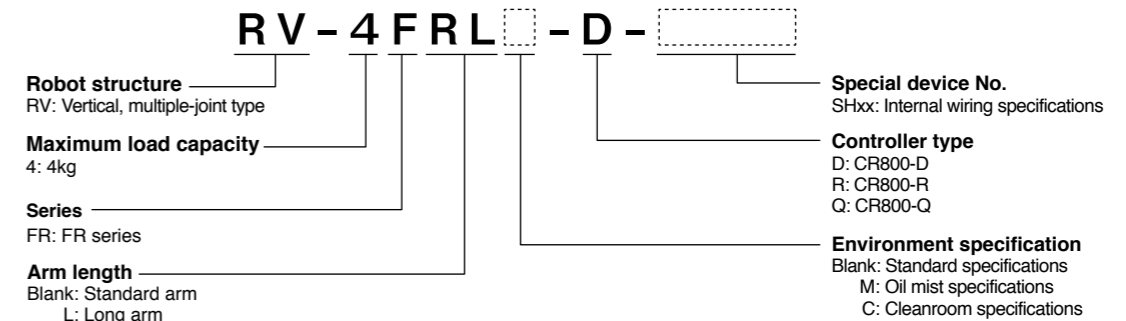
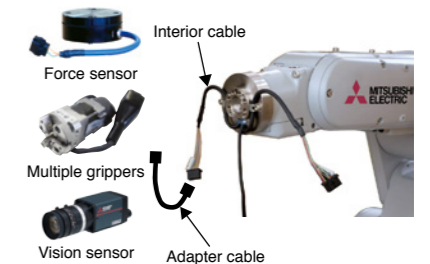

*1: Please contact Mitsubishi Electric dealer since the environmental resistance may not be secured depending on the characteristics of oil you use. Air will need to be purged from the lines. For details, refer to the specifications sheet.
*2: The wall-mounted specification is a custom specification where the operating range of the J1-axis is limited.
*3: This is the value at the surface of the mechanical interface when all axes are composited.
*4: Value for a 25mm up/down and 300mm horizontal reciprocal movement with 1kg load. The cycle time is the value for RV-4FR-R and RV-4FRL-R.
*5: This can also be used as a spare wire (0.13sq 4-pair wire.) The wire is prepared up to inside the forearm.
*6: Select one of the following controllers according to the application. CR800-D: Standalone type, CR800-R: MELSEC iQ-R compatible type, CR800-Q: MELSEC Q Series compatible type.
*7: Preservation of cleanliness levels depends on conditions of a downstream flow of 0.3 m/s in the cleanroom and internal robot suctioning. A ø8-mm coupler for suctioning is provided at the back of the base.
*8: The maximum load capacity indicates the maximum payload when the mechanical interface is facing downward (±10° to the perpendicular).

MELFA
RV-7FR
RV-7FRL
RV-7FRL

Vertical
7kg
type

RV-7FR
RV-7FRL
RV-7FRL

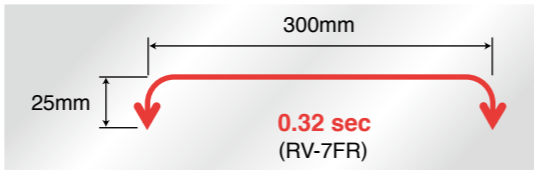

Cutting-edge servo control and optimized arm construction provide extremely fast and precise heavy-duty operation. Increased range of movement along each axis and slender arms to cover large work areas. An ideal robot for compact cell construction. The product line includes a model with a maximum reach radius of 1503 mm for a larger operating range.

- Among the fastest moving robots in its class [Max. composite speed: 11.0 m/s (RV-7FR)]
- Standard cycle time [0.32 s (RV-7FR)]
- Pivotal operating range: $\pm 240^\circ$ (RV-7FR/7FRL)
- Environmental specifications [standard: IP40; oil mist: IP67; cleanroom: ISO class 3]
- Standards compliance [Compliant with European Machinery Directives (CE) as standard. Compliance with other standards is available in specialized machines. Contact Mitsubishi Electric for details.]

Specifications

Type	Unit	RV-7FR (M) (C)	RV-7FRL (M) (C)	RV-7FRL (M) (C)
Environmental specifications				
Protection degree		Standard/ Oil mist/ Cleanroom		
Installation		IP40 (standard)/ IP67 (oil mist) *1/ ISO class3 *7		
Structure		Floor type, ceiling type, (wall-mounted type *2)		
Degrees of freedom		Vertical multiple-joint type		
Drive system		6		
Position detection method		AC servo motor		
Maximum load capacity	kg	Absolute encoder		
Arm length	mm	Maximum 7 (Rated 7) *8		
Maximum reach radius	mm	340+370	435+470	565+805
Operating range	J1	713		
	J2	480 (± 240)		
	J3	240 (-115 to +125)	240 (-110 to +130)	240 (-90 to +150)
	J4	156 (-0 to +156)	162 (-0 to +162)	167.5 (-10 to +157.5)
	J5	400 (± 200)		
	J6	240 (-120 to +120)		
Maximum speed	J1	720 (± 360)		
	J2	360	288	234
	J3	401	321	164
	J4	450	360	219
	J5	337		
	J6	450		
Maximum composite speed *3	mm/sec	11064	10977	15300
Cycle time *4	sec	0.32	0.35	0.63
Position repeatability	mm	± 0.02		
Ambient temperature	$^\circ\text{C}$	0 to 40		
Mass	kg	65	67	130
Tolerable moment	J4	16.2		
	J5	16.2		
	J6	6.86		
Tolerable amount of inertia	J4	0.45		
	J5	0.45		
	J6	0.10		
Tool wiring		Gripper: 8 input points, Signal cable for the multi-function gripper, LAN x 1 <100 BASE-TX> *5		
Tool pneumatic pipes		Primary: $\phi 6 \times 2$ Secondary: $\phi 4 \times 8$, $\phi 4 \times 4$ (from base portion to forearm)		
Machine cable		5m (connector on both ends)		
Connected controller *6		CR800-D, CR800-R, CR800-Q		

*1: Please contact Mitsubishi Electric dealer since the environmental resistance may not be secured depending on the characteristics of oil you use.
 *2: The wall-mounted specification is a custom specification where the operating range of the J1-axis is limited.
 *3: This is the value at the surface of the mechanical interface when all axes are composited.
 *4: Value for a 25mm up/down and 300mm horizontal reciprocal movement with 1kg. The cycle time is the value for RV-7FR-R, RV-7FRL-R, RV-7FRL-R.
 *5: Can also be used as a spare line (0.13 sq. mm, 4-pair cable) for conventional models.
 *6: Select either controller according to your application. CR800-D: Standalone type, CR800-R: MELSEC IQ-R compatible type, CR800-Q: MELSEC Q Series compatible type.
 *7: Preservation of cleanliness levels depends on conditions of a downstream flow of 0.3 m/s in the cleanroom and internal robot suctioning. A $\phi 8$ -mm coupler for suctioning is provided at the back of the base.
 *8: The maximum load capacity indicates the maximum payload when the mechanical interface is facing downward ($\pm 10^\circ$ to the perpendicular).

External Dimensions/Operating Range Diagram

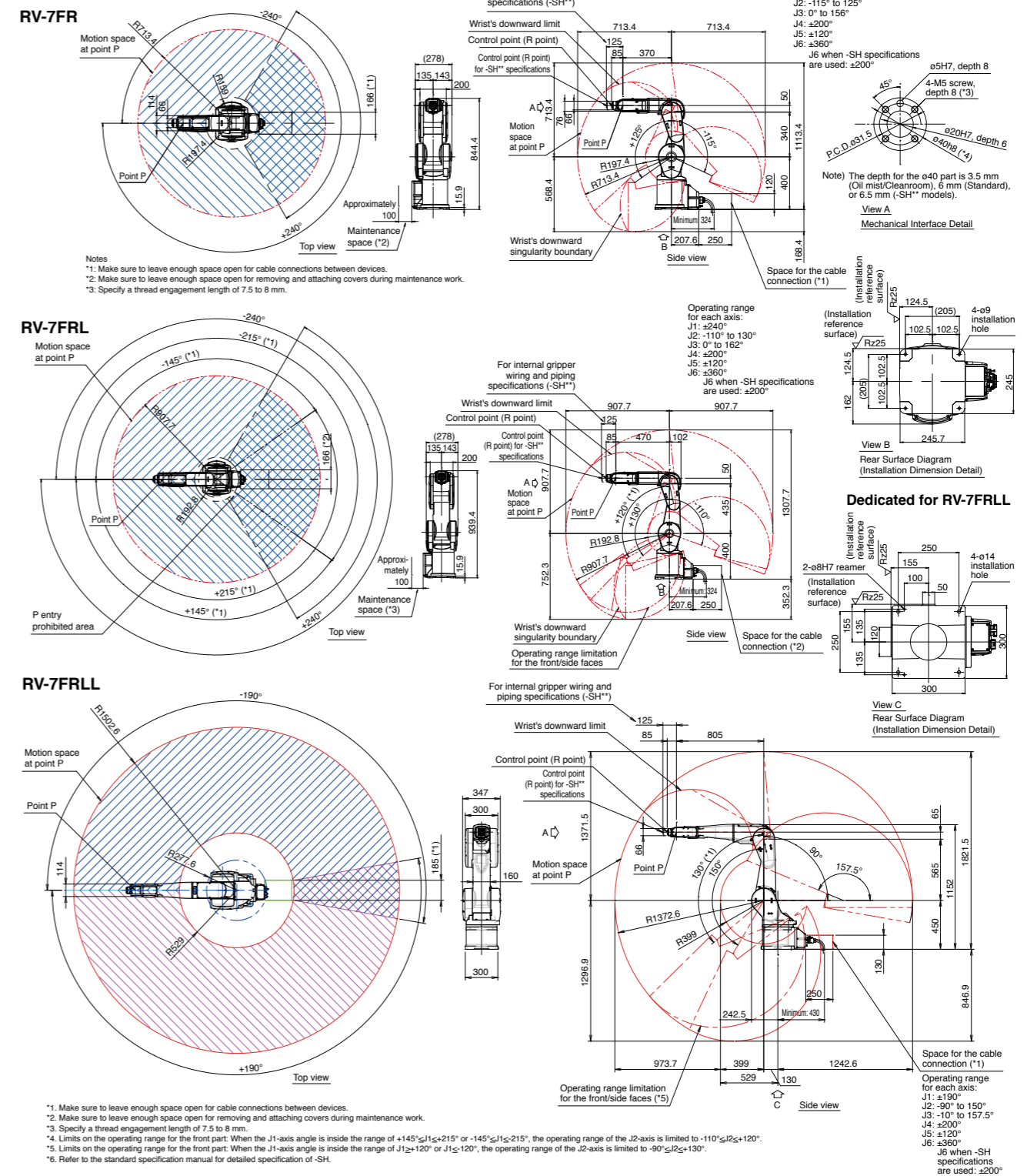

Mounting cable specifications (*1)

Devices that can be mounted	Model (machine no.)				
	-SH01	-SH02	-SH03	-SH04	-SH05
Air $\phi 4$	<input type="checkbox"/> (x4)	<input type="checkbox"/>	<input type="checkbox"/>	<input type="checkbox"/> (x2)	<input type="checkbox"/> (x2)
Gripper input 8 points	<input type="checkbox"/>	<input type="checkbox"/>	<input type="checkbox"/>	<input type="checkbox"/>	<input type="checkbox"/>
Vision sensor	<input type="checkbox"/>	<input type="checkbox"/>	<input type="checkbox"/>	<input type="checkbox"/>	<input type="checkbox"/>
Force sensor	<input type="checkbox"/>	<input type="checkbox"/>	<input type="checkbox"/>	<input type="checkbox"/>	<input type="checkbox"/>
Electric gripper	<input type="checkbox"/>	(may be used for either device)	<input type="checkbox"/>	<input type="checkbox"/>	<input type="checkbox"/>

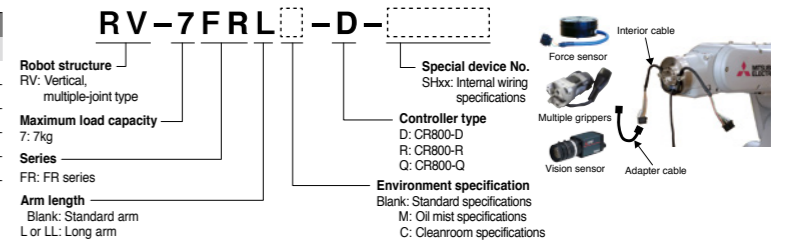

*1) The J6 axis range of motion is ± 200 deg. Protection level is IP40.

MELFA
RV-13FR
RV-13FRL

Vertical
13kg
type

RV-13FR
RV-13FRL



Cutting-edge servo control and optimized arm construction provide extremely fast and precise heavy-duty operation. Optimized arm length and 6 joints for a broader range of movement support a wide range of layouts. Designed to withstand environmental conditions, it can be used in a wide range of applications without having to worry about the installation environment. Suitable for various types of work, such as transporting mechanical parts, assembling electrical components and even packaging products such as pharmaceuticals and foodstuffs.

- Among the fastest moving robots in its class [Max. composite speed: 10.5 m/s (RV-13FR)]
- Standard cycle time [0.53 s (RV-13FR)]
- Pivotal operating range: ±190°
- Environmental specifications [standard: IP40; oil mist: IP67; cleanroom: ISO class 3]
- Standards compliance Compliant with European Machinery Directives (CE) as standard. Compliance with other standards is available in specialized machines. Contact Mitsubishi Electric for details.

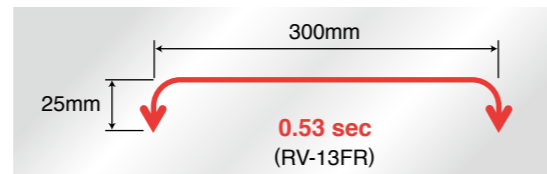

Specifications

Type	Unit	RV-13FR (M) (C)	RV-13FRL (M) (C)
Environmental specifications			
Standard/ Oil mist/ Cleanroom			
Protection degree		IP40 (standard)/ IP67 (oil mist) *1/ ISO class3 *7	
Installation		Floor type, ceiling type, (wall-mounted type *2)	
Structure		Vertical, multiple-joint type	
Degrees of freedom		6	
Drive system		AC servo motor	
Position detection method		Absolute encoder	
Maximum load capacity	kg	Maximum 13 (Rated 12) *8	
Arm length	mm	410+550	565+690
Maximum reach radius	mm	1094	1388
Operating range	J1	380 (±190)	
	J2	240 (-90 to +150)	
	J3	167.5 (-10 to +157.5)	
	J4	400 (±200)	
	J5	240 (-120 to +120)	
	J6	720 (±360)	
Maximum speed	J1	290	234
	J2	234	164
	J3	312	219
	J4	375	375
	J5	375	375
	J6	720	720
Maximum composite speed *3	mm/sec	10450	9700
Cycle time *4	sec	0.53	0.68
Position repeatability	mm	±0.05	
Ambient temperature	°C	0 to 40	
Mass	kg	120	130
Tolerable moment	J4	19.3	
	J5	19.3	
	J6	11	
Tolerable amount of inertia	J4	0.47	
	J5	0.47	
	J6	0.14	
Tool wiring		Gripper: 8 input points/8 output points Signal cable for the multi-function gripper LAN x 1 <100 BASE-TX> *5	
Tool pneumatic pipes		Primary: ø6 x 2 Secondary: ø6 x 8, ø4 x 4 (from base portion to forearm)	
Machine cable		5m (connector on both ends)	
Connected controller *6		CR800-D, CR800-R, CR800-Q	

External Dimensions/Operating Range Diagram
RV-13FR

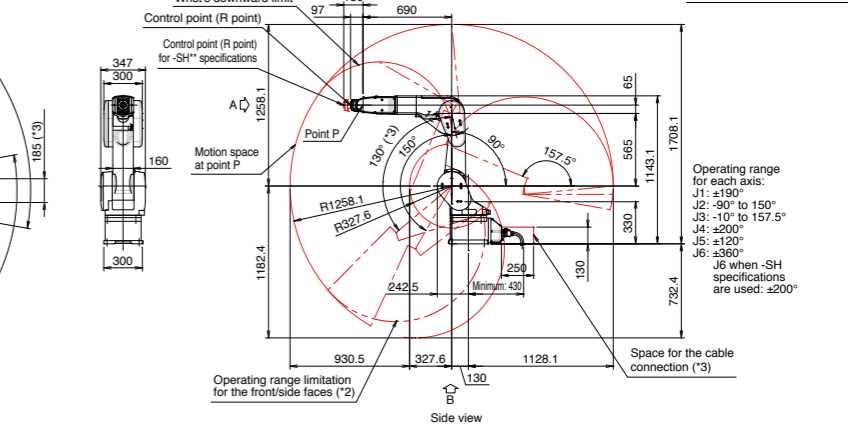
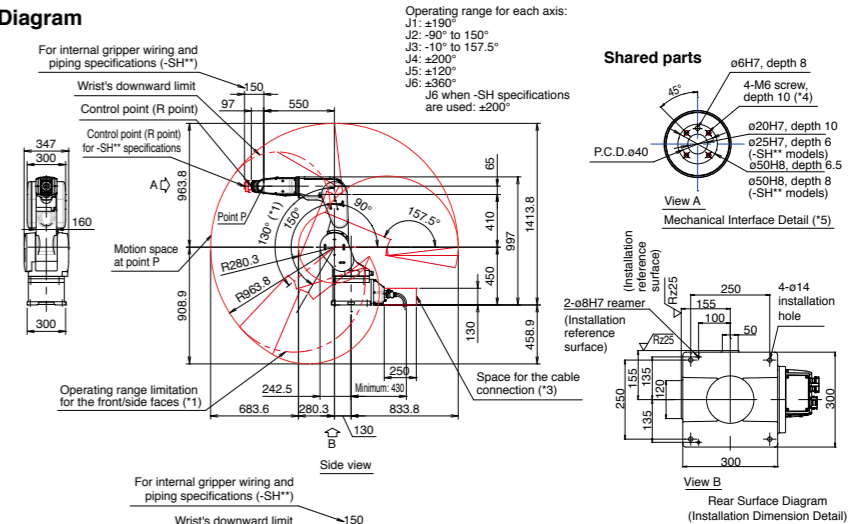
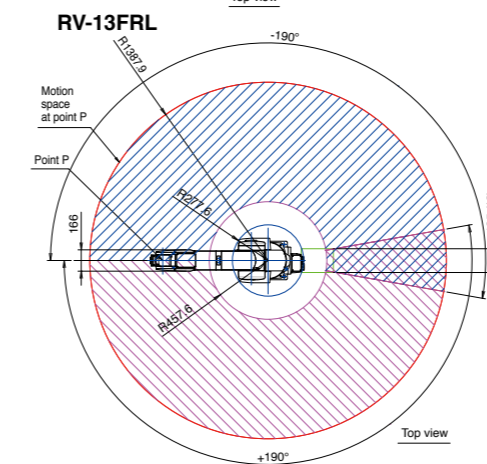
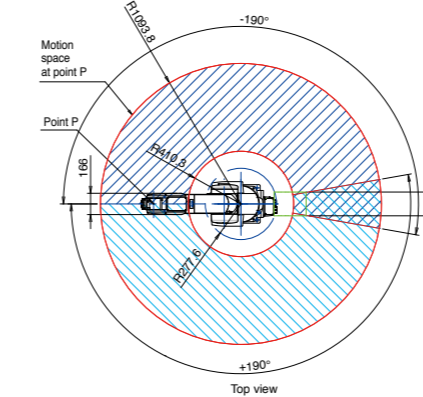

*1: Operating range for the front and side parts: When the J1-axis angle is inside the range of J1₂±120° or J1₅±130°, the operating range of the J2-axis is limited to -90°≤J2₅+130°.
*2: Make sure to leave enough space open for cable connections between devices.
*3: Specify a thread engagement length of 10 to 9mm.
*4: Refer to the standard specification manual for detailed specification of -SH.
*5: Please refer to the standard specification for detailed specifications of the -SH models.

Mounting cable specifications (*1)

Devices that can be mounted	Model (machine no.)				
	-SH01	-SH02	-SH03	-SH04	-SH05
Air ø4	○ (x4)	—	—	○ (x2)	○ (x2)
Gripper input 8 points	○	○	—	○	○
Vision sensor	—	○	○	—	○
Force sensor	—	○ (may be used for either device)	○	○	—
Electric gripper	—	—	○	—	—

*1) The J6 axis range of motion is ±200deg. Protection level is IP40.

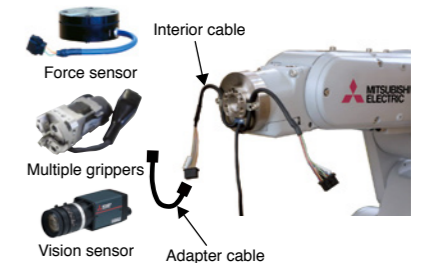

RV-13FRL-D

- Robot structure**
RV: Vertical, multiple-joint type
- Maximum load capacity**
13: 13kg
- Series**
F: FR series
- Arm length**
Blank: Standard arm
L: Long arm
- Special device No.**
SHxx: Internal wiring specifications
- Controller type**
D: CR800-D
R: CR800-R
Q: CR800-Q
- Environment specification**
Blank: Standard specifications
M: Oil mist specifications
C: Cleanroom specifications

*1: Please contact Mitsubishi Electric dealer since the environmental resistance may not be secured depending on the characteristics of oil you use.
*2: The wall-mounted specification is a custom specification where the operating range of the J1-axis is limited.
*3: This is the value at the surface of the mechanical interface when all axes are composited.
*4: Value for a 25mm up/down and 300mm horizontal reciprocal movement with 5kg load. The cycle time is the value for RV-13FR-R and RV-13FRL-R.
*5: Can also be used as a spare line (0.13 sq. mm, 4-pair cable) for conventional models. Provided up to the inside of the forearm.
*6: Select either controller according to your application. CR800-D: Standalone type, CR800-R: MELSEC iQ-R compatible type, CR800-Q: MELSEC Q Series compatible type.
*7: Preservation of cleanliness levels depends on conditions of a downstream flow of 0.3 m/s in the cleanroom and internal robot suctioning. A ø8-mm coupler for suctioning is provided at the back of the base.
*8: The maximum load capacity indicates the maximum payload when the mechanical interface is facing downward (±10° to the perpendicular).

MELFA RV-20FR

Vertical 20kg type

RV-20FR

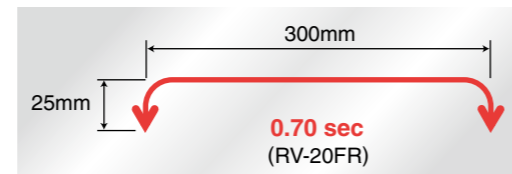

Highly portable RV-F series (maximum load capacity: 20 kg). Cutting-edge servo control and optimized arm construction provide extremely portable and precise heavy-duty operation. Optimized arm length and 6 joints for a broader range of movement support a wide range of layouts. Designed to withstand environmental conditions, it can be used in a wide range of applications without having to worry about the installation environment. Plenty of scope for using multiple grippers or multi-function grippers and capable of handling work such as transporting high-load mechanical parts, assembling electrical components and packaging pharmaceutical products.

- Standard cycle time [0.7 s]
- Pivotal operating range: ±190°
- Environmental specifications [standard: IP40; oil mist: IP67; cleanroom: ISO class 3]
- Standards compliance Compliant with European Machinery Directives (CE) as standard. Compliance with other standards is available in specialized machines. Contact Mitsubishi Electric for details.

Specifications

Type	Unit	RV-20FR (M) (C)
Environmental specifications		Standard/ Oil mist/ Cleanroom
Protection degree		IP40 (standard)/ IP67 (oil mist) *1/ ISO class3 *7
Installation		Floor type, ceiling type, (wall-mounted type *2)
Structure		Vertical multiple-joint type
Degrees of freedom		6
Drive system		AC servo motor
Position detection method		Absolute encoder
Maximum load capacity	kg	Maximum 20 (Rated 15) *8
Arm length	mm	410+550
Maximum reach radius	mm	1094
Operating range	J1	380 (±190)
	J2	240 (-90 to +150)
	J3	167.5 (-10 to +157.5)
	J4	400 (±200)
	J5	240 (-120 to +120)
	J6	720 (±360)
Maximum speed	J1	110
	J2	110
	J3	110
	J4	124
	J5	125
	J6	360
Maximum composite speed *3	mm/sec	4200
Cycle time *4	sec	0.70
Position repeatability	mm	±0.05
Ambient temperature	°C	0 to 40
Mass	kg	120
Tolerable moment	J4	49.0
	J5	49.0
	J6	11
Tolerable amount of inertia	J4	1.40
	J5	1.40
	J6	0.14
Tool wiring		Gripper: 8 input points/8 output points Signal cable for the multi-function gripper LAN x 1 <100 BASE-TX> *5
Tool pneumatic pipes		Primary: ø6 x 2 Secondary: ø6 x 8, ø4 x 4 (from base portion to forearm)
Machine cable		5m (connector on both ends)
Connected controller *6		CR800-D, CR800-R, CR800-Q

External Dimensions/Operating Range Diagram RV-13FR

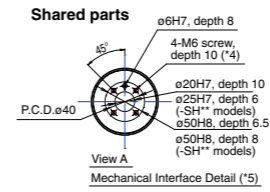
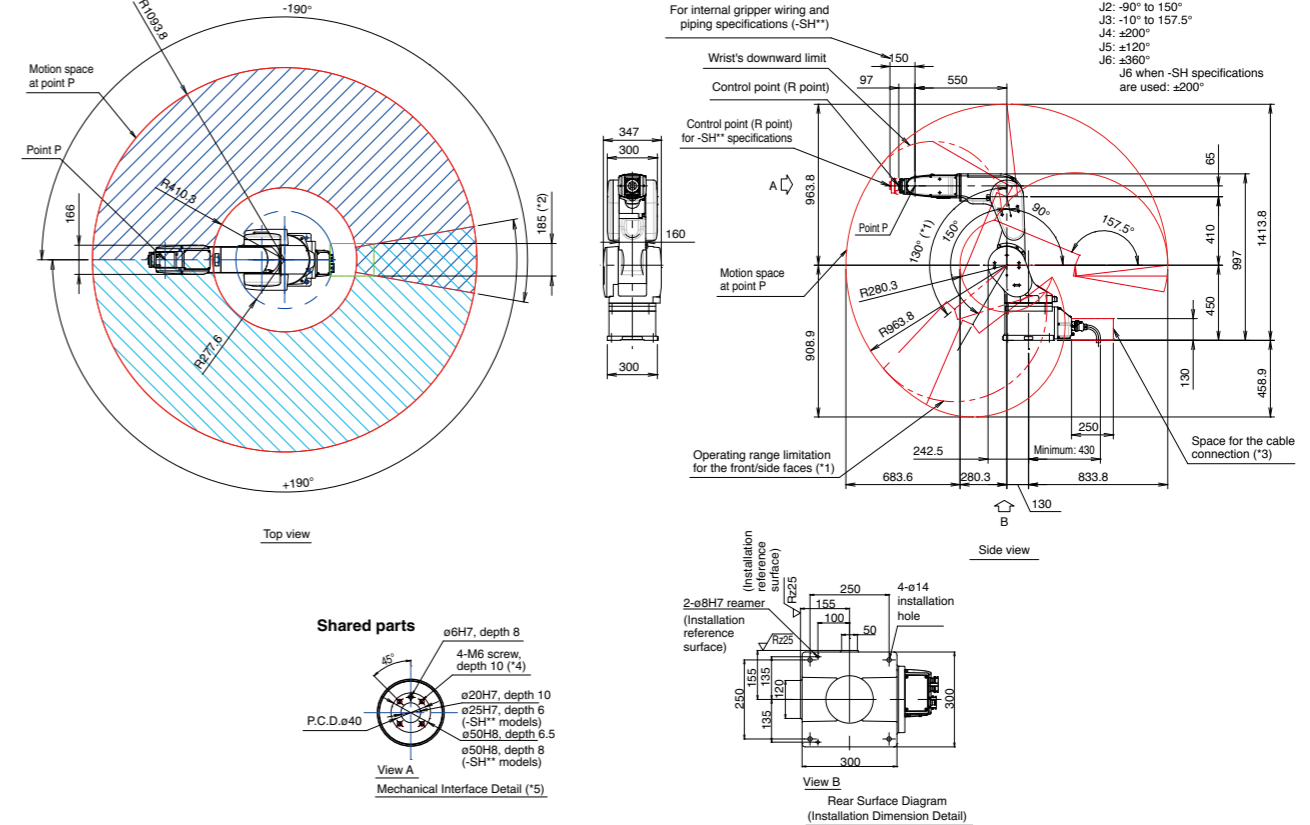

*1: Operating range for the front and side parts: When the J1-axis angle is inside the range of J1±120° or J1±130°, the operating range of the J2-axis is limited to -90°±J2±130°.
*2: Make sure to leave enough space open for cable connections between devices.
*3: Specify a thread engagement length of 10 to 9mm.
*4: Refer to the standard specification manual for detailed specification of -SH.

Mounting cable specifications (*1)

Devices that can be mounted	Model (machine no.)				
	-SH01	-SH02	-SH03	-SH04	-SH05
Air ø4	○ (x4)	-	-	○ (x2)	○ (x2)
Gripper input 8 points	○	○	-	○	○
Vision sensor	-	○	○	-	○
Force sensor	-	○	○	○	-
Electric gripper	-	(may be used for either device)	○	-	-

*1) The J6 axis range of motion is ±200deg. Protection level is IP40.

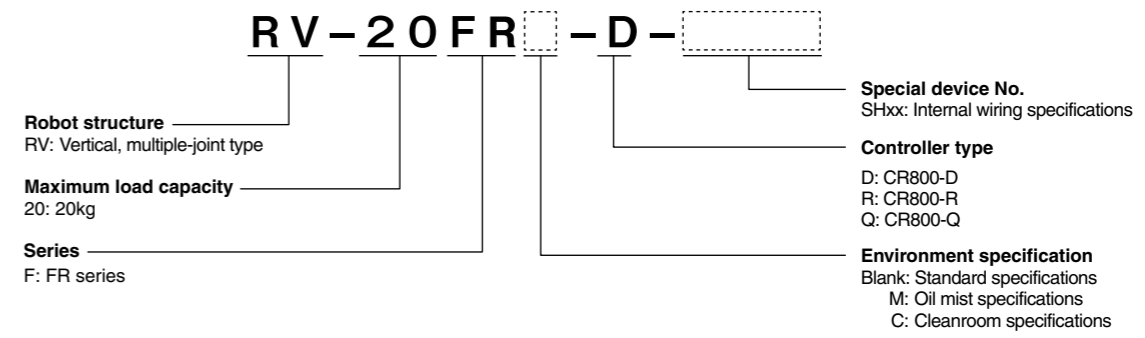
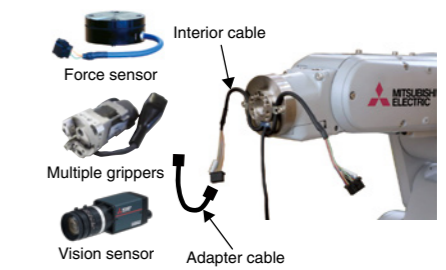

*1: Please contact Mitsubishi Electric dealer since the environmental resistance may not be secured depending on the characteristics of oil you use.
*2: The wall-mounted specification is a custom specification where the operating range of the J1-axis is limited.
*3: This is the value at the surface of the mechanical interface when all axes are composited.
*4: Value for a 25mm up/down and 300mm horizontal reciprocal movement with 5kg load. The cycle time is the value for RV-20FR-R.
*5: Can also be used as a spare line (0.13 sq. mm, 4-pair cable) for conventional models. Provided up to the inside of the forearm.
*6: Select either controller according to your application. CR800-D: Standalone type, CR800-R: MELSEC iQ-R compatible type, CR800-Q: MELSEC Q Series compatible type.
*7: Preservation of cleanliness levels depends on conditions of a downstream flow of 0.3 m/s in the cleanroom and internal robot suctioning. A ø8-mm coupler for suctioning is provided at the back of the base.
*8: The maximum load capacity indicates the maximum payload when the mechanical interface is facing downward (±10° to the perpendicular).

MELFA
RH-3FRH35
RH-3FRH45
RH-3FRH55

Horizontal
3kg
type

RH-3FRH35
RH-3FRH45
RH-3FRH55

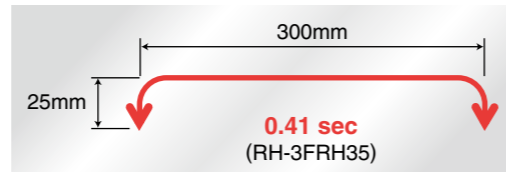

Ideal for compact cell construction, such as assembling or transporting small workpieces.

- Among the fastest moving robots in its class
[XY composite: 8,300 mm/s]
[J4 (θ axis): 3,000 deg/s]
- Standard cycle time
[0.41 s (RH-3FRH35)]
- Pivotal operating range: $\pm 170^\circ$
- Environmental specifications
[standard: IP20; cleanroom: ISO class 3]
- Standards compliance
Compliant with European Machinery Directives (CE) as standard.
Compliance with other standards is available in specialized machines.
Contact Mitsubishi Electric for details.

External Dimensions/Operating Range Diagram

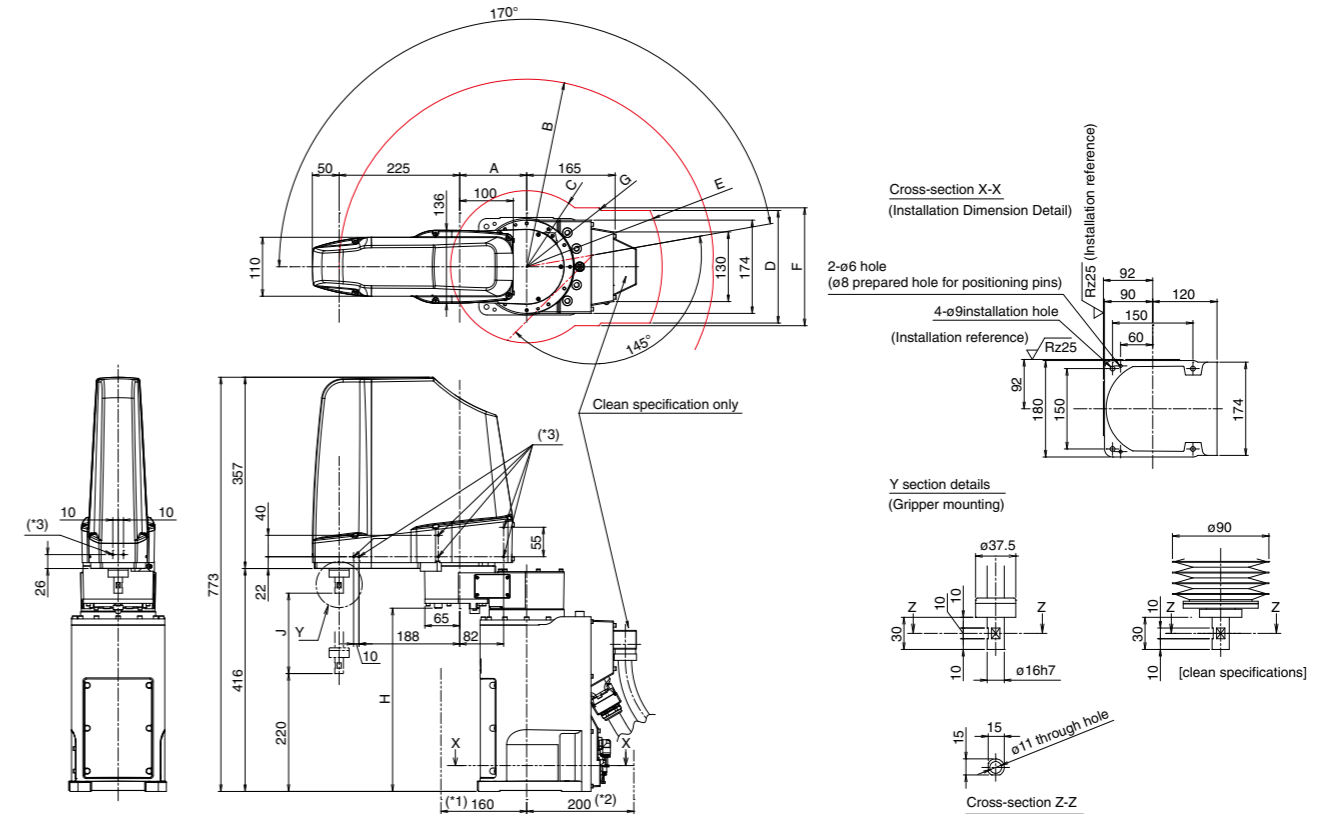

*1: Space required for the battery replacement
*2: Space required for the interconnection cable
*3: Screw holes (M4, 6 mm long) for affixing user wiring and piping. (6 locations on both sides and 2 locations on the front of the No. 2 arm.)

Variable dimensions

Robot series	A	B	C	D	E	F	G	H	J
RH-3FRH3515	125	R350	R142	210	R253	220	R174	342	150
RH-3FRH3512C	125	R350	R142	224	R253	268	R196	342	120
RH-3FRH4515	225	R450	R135	210	R253	220	R174	337	150
RH-3FRH4512C	225	R450	R135	224	R253	268	R197	337	120
RH-3FRH5515	325	R550	R191	160	R244	172	R197	337	150
RH-3FRH5512C	325	R550	R191	160	R253	259	R222	337	120

Specifications

Type	Unit	RH-3FRH3515/12C	RH-3FRH4515/12C	RH-3FRH5515/12C	
Environmental specifications			Standard/ Cleanroom		
Protection degree *1			IP20/ ISO class3 *6		
Installation			Floor type		
Structure			Horizontal multiple-joint type		
Degrees of freedom			4		
Drive system			AC servo motor		
Position detection method			Absolute encoder		
Maximum load capacity	kg		Maximum 3 (Rated 1)		
Arm length	NO1 arm	mm	125	225	
	NO2 arm	mm		225	
Maximum reach radius	mm	350	450	550	
Operating range	J1	deg	340 (± 170)		
	J2	deg	290 (± 145)		
	J3 (Z)	mm	150 (Clean specification: 120) *1		
	J4 (θ)	deg	720 (± 360)		
Maximum speed	J1	deg/sec	420		
	J2	deg/sec	720		
	J3 (Z)	mm/sec	1100		
	J4 (θ)	deg/sec	3000		
Maximum composite speed *2	mm/sec	6800	7500	8300	
Cycle time *3	sec	0.41	0.46	0.51	
Position repeatability	Y-X composite	mm	± 0.010	± 0.010	± 0.012
	J3 (Z)	mm		± 0.01	
	J4 (θ)	deg		± 0.004	
Ambient temperature	$^\circ\text{C}$		0 to 40		
Mass	kg	29	29	32	
Tolerable amount of inertia	Rating		0.005		
	Maximum	kgm ²		0.06	
Tool wiring			Gripper: 8 input points/8 output points (20 pins total) Signal cable for the multi-function gripper (2-pin + 2-pin power line) LAN x 1 <100 BASE-TX> (8-pin) *4		
Tool pneumatic pipes			Primary: $\phi 6 \times 2$ Secondary: $\phi 4 \times 8$		
Machine cable			5m (connector on both ends)		
Connected controller *5			CR800-D, CR800-R, CR800-Q		

RH-3FRH5515-D

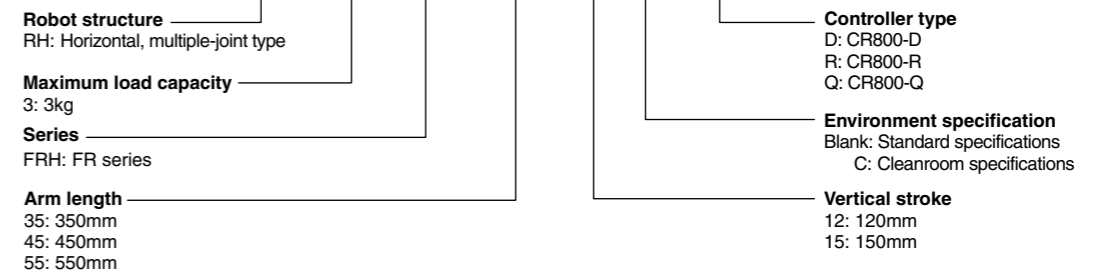

*1: The range for vertical movement listed in the environmental resistance specifications (C: Clean specifications) for the RH-3FRH is narrower than for the standard model. Keep this in mind when working with the RH-3FRH. The environment-resistant specifications are factory-set custom specifications.
*2: The value assumes composition of J1, J2, and J4.
*3: Value for a maximum load capacity of 2 kg. The cycle time may increase if specific requirements apply such as high work positioning accuracy, or depending on the operating position. (The cycle time is based on back-and-forth movement over a vertical distance of 25 mm and horizontal distance of 300 mm.)
*4: Can also be used as a spare line (0.2 sq. mm, 4-pair cable) for conventional models.
*5: Select either controller according to your application. CR800-D: Standalone type, CR800-R: MELSEC IO-R compatible type, CR800-Q: MELSEC Q Series compatible type.
*6: Preservation of cleanliness levels depends on conditions of a downstream flow of 0.3 m/s in the cleanroom and internal robot suctioning. A $\phi 8$ -mm coupler for suctioning is provided at the back of the base.

MELFA
RH-6FRH35
RH-6FRH45
RH-6FRH55

Horizontal
6kg
type

RH-6FRH35
RH-6FRH45
RH-6FRH55

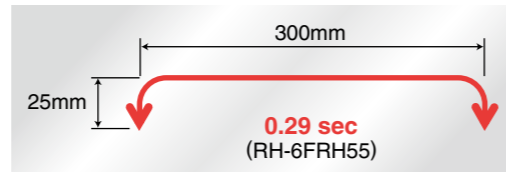

A horizontal, multiple-joint type robot with highly rigid arms and cutting-edge servo controls to provide extremely fast and precise heavy-duty operation. Ideal for a wide range of fields, from transportation of small components that demands high-speed operation through to assembly work where excellent precision is required.

- Among the fastest moving robots in its class
[XY composite: 8,300 mm/s]
[J4 (θ axis): 2,400 deg/s]
- Standard cycle time
[0.29 s (RH-6FRH55)]
- Pivotal operating range: $\pm 170^\circ$
- Environmental specifications
[standard: IP20; oil mist: IP65; cleanroom: ISO class 3]
- Standards compliance
Compliant with European Machinery Directives (CE) as standard. Compliance with other standards is available in specialized machines. Contact Mitsubishi Electric for details.

External Dimensions/Operating Range Diagram

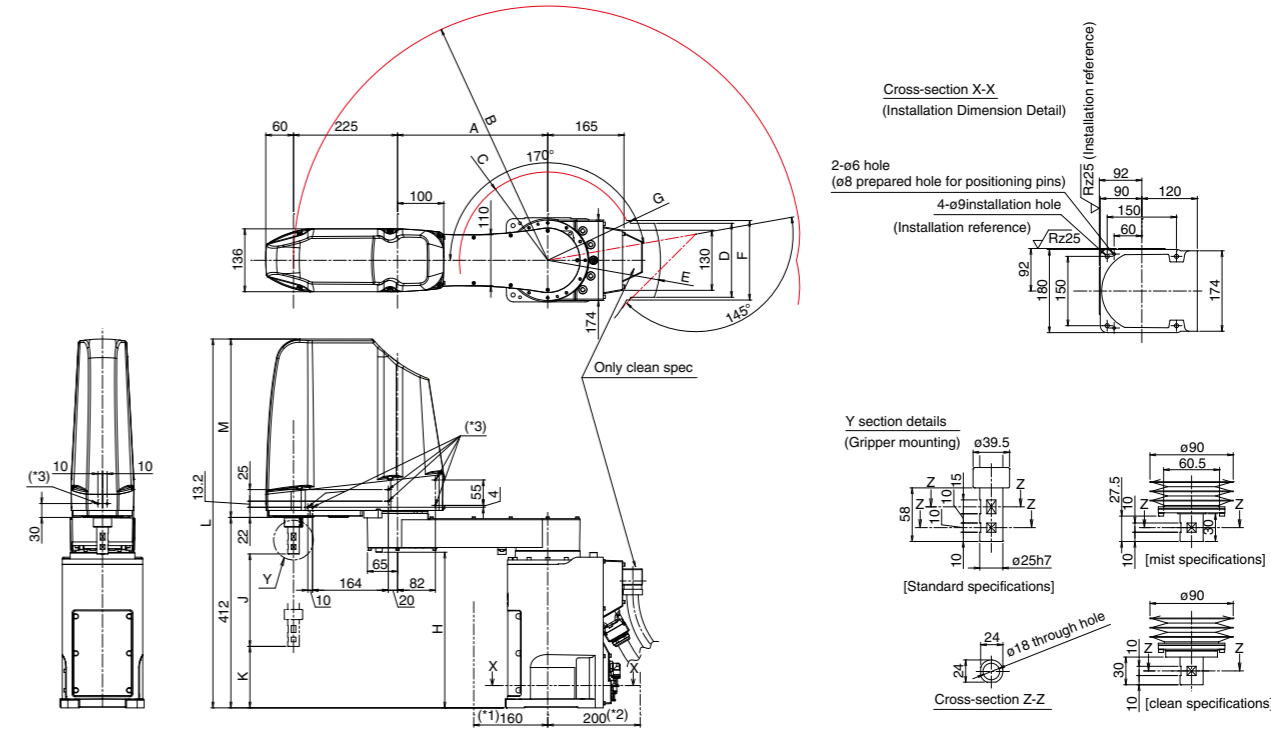

*1: Space required for the battery replacement
*2: Space required for the interconnection cable
*3: Screw holes (M4, 6 mm long) for affixing user wiring and piping. (6 locations on both sides and 2 locations on the front of the No. 2 arm.)

Variable dimensions

Robot series	A	B	C	D	E	F	G	H	J	K	L	M
RH-6FRH3520	125	R350	R142	210	R253	220	R174	342	200	133	798	386
RH-6FRH3520M/C	125	R350	R142	224	R253	268	R196	342	200	133	798	386
RH-6FRH3534	125	R350	R142	210	R253	220	R174	342	340	-7	938	526
RH-6FRH3534M/C	125	R350	R142	224	R253	268	R196	342	340	-43	938	526
RH-6FRH4520	225	R450	R135	210	R253	220	R174	337	200	133	798	386
RH-6FRH4520M/C	225	R450	R135	224	R253	268	R197	337	200	133	798	386
RH-6FRH4534	225	R450	R135	210	R253	220	R174	337	340	-7	938	526
RH-6FRH4534M/C	225	R450	R135	224	R253	268	R197	337	340	-43	938	526
RH-6FRH5520	325	R550	R191	160	R244	172	R197	337	200	133	798	386
RH-6FRH5520C	325	R550	R191	160	R253	259	R222	337	200	133	798	386
RH-6FRH5520M	325	R550	R191	160	R244	259	R222	337	200	133	798	386
RH-6FRH5534	325	R550	R191	160	R244	172	R197	337	340	-7	938	526
RH-6FRH5534C	325	R550	R191	160	R253	259	R222	337	340	-43	938	526
RH-6FRH5534M	325	R550	R191	160	R244	259	R222	337	340	-43	938	526

Specifications

Type	Unit	RH-6FRH35XX/M/C	RH-6FRH45XX/M/C	RH-6FRH55XX/M/C
Environmental specifications		Standard/ Oil mist/ Cleanroom		
Protection degree *1		IP20/IP65 *6, ISO class3 *7		
Installation		Floor type		
Structure		Horizontal multiple-joint type		
Degrees of freedom		4		
Drive system		AC servo motor		
Position detection method		Absolute encoder		
Maximum load capacity	kg	Maximum 6 (Rated 3)		
Arm length	NO1 arm	125	225	325
	NO2 arm		225	
Maximum reach radius	mm	350	450	550
Operating range	J1	340 (± 170)		
	J2	290 (± 145)		
	J3 (Z)	xx=20:200, xx=34:340		
	J4 (θ)	720 (± 360)		
Maximum speed	J1	400		
	J2	670		
	J3 (Z)	2400		
	J4 (θ)	2500		
Maximum composite speed *2	mm/sec	6900	7600	8300
Cycle time *3	sec	0.29		
Position repeatability	Y-X composite	± 0.010	± 0.010	± 0.012
	J3 (Z)		± 0.01	
	J4 (θ)		± 0.004	
Ambient temperature	$^\circ\text{C}$	0 to 40		
Mass	kg	36	36	37
Tolerable amount of inertia	Rating	0.01		
	Maximum	0.12		
Tool wiring		Gripper: 8 input points/8 output points (20 pins total) Signal cable for the multi-function gripper (2-pin + 2-pin power line) LAN x 1 <100 BASE-TX> (8-pin) *4		
Tool pneumatic pipes		Primary: $\phi 6 \times 2$ Secondary: $\phi 4 \times 8$		
Machine cable		5m (connector on both ends)		
Connected controller *5		CR800-D, CR800-R, CR800-Q		

RH-6FRH5520-D

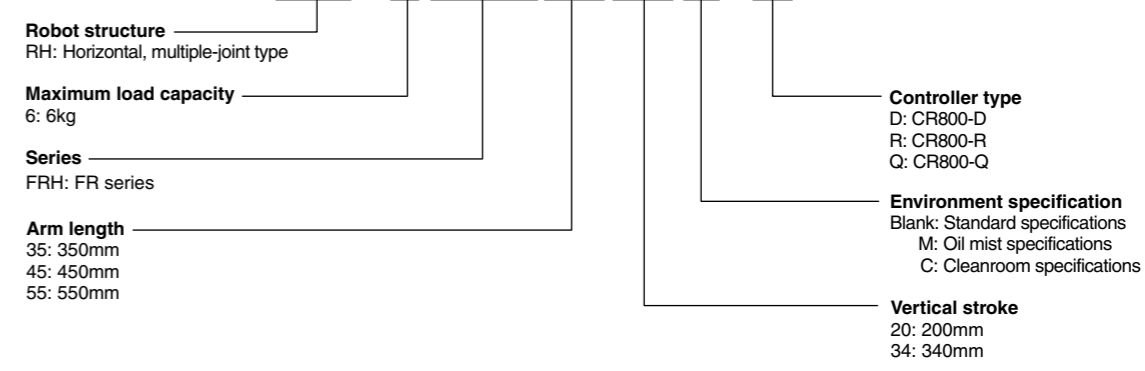

*1: The environmental resistance specifications (M: Oil mist specifications, C: Cleanroom specifications) for the RH-6FRH is factory-set custom specifications.
*2: The value assumes composition of J1, J2, and J4.
*3: Value for a maximum load capacity of 2 kg. The cycle time may increase if specific requirements apply such as high work positioning accuracy, or depending on the operating position. (The cycle time is based on back-and-forth movement over a vertical distance of 25 mm and horizontal distance of 300 mm.)
*4: Can also be used as a spare line (0.2 sq. mm, 4-pair cable) for conventional models.
*5: Select either controller according to your application. CR800-D: Standalone type, CR800-R: MELSEC IO-R compatible type, CR800-Q: MELSEC Q Series compatible type.
*6: Please contact Mitsubishi Electric dealer since the environmental resistance may not be secured depending on the characteristics of oil you use. Direct jet to the bellows is excluded.
*7: Preservation of cleanliness levels depends on conditions of a downstream flow of 0.3 m/s in the cleanroom and internal robot suctioning. A $\phi 8$ -mm coupler for suctioning is provided at the back of the base.

MELFA
RH-12FRH55
RH-12FRH70
RH-12FRH85
RH-20FRH85
RH-20FRH100

Horizontal
12/20kg
type

RH-12FRH55
RH-12FRH70
RH-12FRH85
RH-20FRH85
RH-20FRH100



A horizontal, multiple-joint type robot with highly rigid arms and cutting-edge servo controls to provide extremely fast and precise heavy-duty operation. Enhancements to the wrist axis also mean that the robot has ample scope for handling multi-function grippers and offset grippers. Ideal for assembly and palletizing work.

- Among the fastest moving robots in its class
[XY composite: 13,283 mm/s (RH-20FRH)]
[J4 (θ axis): 2,400 deg/s (RH-12FRH)]
- Standard cycle time
[0.30 s (RH-12FRH85)]
- Pivotal operating range: $\pm 170^\circ$
- Environmental specifications
[standard, Oil mist: IP65; cleanroom: ISO class 3]
- Standards compliance
Compliant with European Machinery Directives (CE) as standard.
Compliance with other standards is available in specialized machines.
Contact Mitsubishi Electric for details.

External Dimensions/Operating Range Diagram

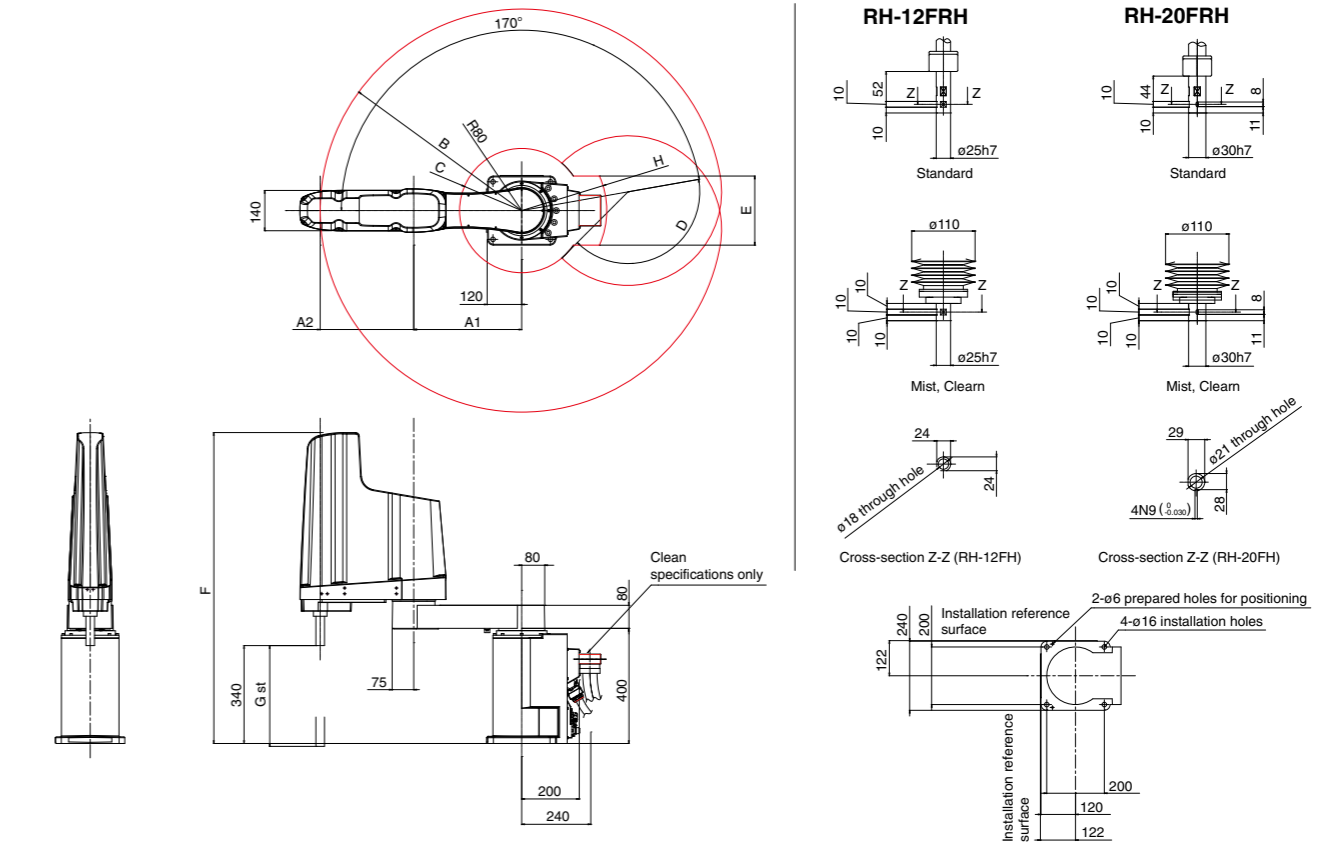

Specifications

Type	Unit	RH-12FRH55XX/M/C	RH-12FRH70XX/M/C	RH-12FRH85XX/M/C	RH-20FRH85XX/M/C	RH-20FRH100XX/M/C
Environmental specifications		Standard/ Oil mist/ Cleanroom			Standard/ Oil mist/ Cleanroom	
Protection degree *1		IP20/ IP65 *6/ ISO class 3 *7			IP20/ IP65 *6/ ISO class 3 *7	
Installation		Floor type			Floor type	
Structure		Horizontal multiple-joint type				
Degrees of freedom		4				
Drive system		AC servo motor				
Position detection method		Absolute encoder				
Maximum load capacity	kg	Maximum 12 (Rated 3)			Maximum 20 (Rated 5)	
Arm length	NO1 arm	225	375	525	525	525
	NO2 arm		325		325	475
Maximum reach radius	mm	550	700	850	850	1000
Operating range	J1	340 (± 170)			340 (± 170)	
	J2	290 (± 145)			306 (± 153)	
	J3 (Z)	xx=35:350, xx=45:450				
	J4 (θ)	720 (± 360)			720 (± 360)	
Maximum speed	J1	420			280	
	J2	450			450	
	J3 (Z)	2800			2400	
	J4 (θ)	2400			1700	
Maximum composite speed *2	mm/sec	11435	12535	11350	11372	13283
Cycle time *3	sec	0.30	0.30	0.30	0.30	0.36
Position repeatability	Y-X composite	± 0.012				
	J3 (Z)	± 0.015			± 0.015	
	J4 (θ)	± 0.005			± 0.005	
Ambient temperature	$^\circ\text{C}$	0 to 40				
Mass	kg	65	67	69	75	77
Tolerable amount of inertia	Rating	0.025			0.065	
	Maximum	0.3			1.05	
Tool wiring		Gripper: 8 input points/8 output points (20 pins total) Signal cable for the multi-function gripper (2-pin + 2-pin power line) LAN x 1 <100 BASE-TX> (8-pin) *4				
Tool pneumatic pipes		Primary: $\phi 6 \times 2$ Secondary: $\phi 6 \times 8$				
Machine cable		5m (connector on both ends)				
Connected controller *5		CR800-D, CR800-R, CR800-Q				

Variable dimensions

Robot series	A1	A2	B	C	D	E	F	G	H
RH-12FRH55xx	225	325	R550	R191	145°	240	1080/1180	350/450	R295
RH-12FRH55xxM/C	225	325	R550	R191	145°	320	1080/1180	350/450	R382
RH-12FRH70xx	375	325	R700	R216	145°	240	1080/1180	350/450	R295
RH-12FRH70xxM/C	375	325	R700	R216	145°	320	1080/1180	350/450	R382
RH-12FRH/20FRH85xx	525	325	R850	R278	153°	-	1080/1180	350/450	-
RH-12FRH/20FRH85xx4M/C	525	325	R850	R278	153°	240	1080/1180	350/450	R367
RH-20FRH100xx	525	475	R1000	R238	153°	240	1080/1180	350/450	R295
RH-20FRH100xxM/C	525	475	R1000	R238	153°	-	1080/1180	350/450	-

RH-20FRH10045-D

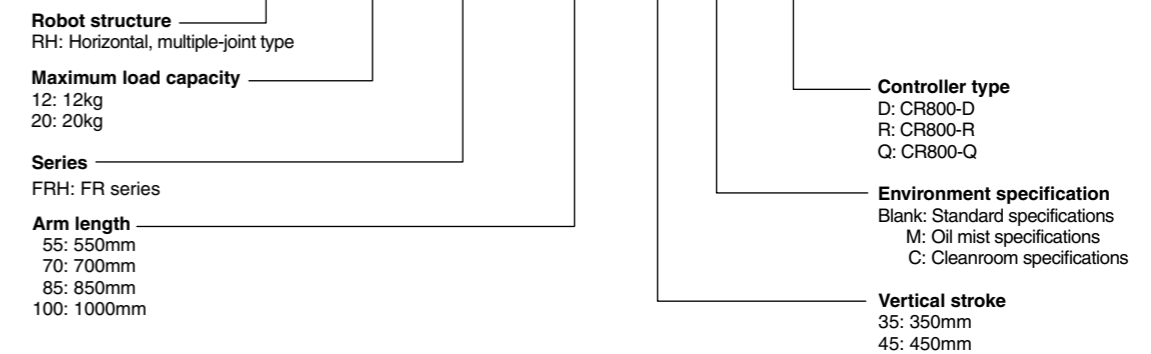

*1: The environmental resistance specifications (M: Oil mist specifications, C: Cleanroom specifications) is factory-set custom specifications.
*2: The value assumes composition of J1, J2, and J4.
*3: Value for a maximum load capacity of 2 kg. The cycle time may increase if specific requirements apply such as high work positioning accuracy, or depending on the operating position.
*4: Can also be used as a spare line (0.2 sq. mm, 4-pair cable) for conventional models.
*5: Select either controller according to your application. CR800-D: Standalone type, CR800-R: MELSEC IO-R compatible type, CR800-Q: MELSEC Q Series compatible type.
*6: Please contact Mitsubishi Electric dealer since the environmental resistance may not be secured depending on the characteristics of oil you use. Direct jet to the bellows is excluded.
*7: Preservation of cleanliness levels depends on conditions of a downstream flow of 0.3 m/s in the cleanroom and internal robot suctioning. A $\phi 8$ -mm coupler for suctioning is provided at the back of the base.

MELFA RH-3FRHR35

Ceiling mounted, horizontal 3kg type

RH-3FRHR35

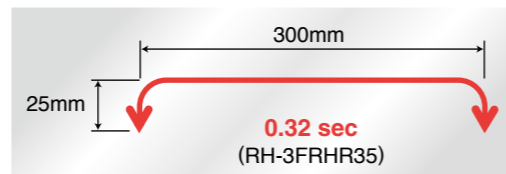

A horizontal, multiple-joint type robot with a space-saving suspended installation mode. Suitable for a wide range of applications, from precision assembly of electrical, electronic and other small components through to inspections, high-speed transportation and packaging.

- Among the fastest moving robots in its class [XY composite: 6,267 mm/s] [J4 (θ axis): 3,146 deg/s]
- Standard cycle time [0.32 s (RH-3FRHR35)]
- Pivotal operating range: $\pm 225^\circ$
- Environmental specifications [standard: IP20; cleanroom: ISO class 5; Waterproof: IP65]
- Standards compliance Compliant with European Machinery Directives (CE) as standard. Compliance with other standards is available in specialized machines. Contact Mitsubishi Electric for details.

External Dimensions/Operating Range Diagram

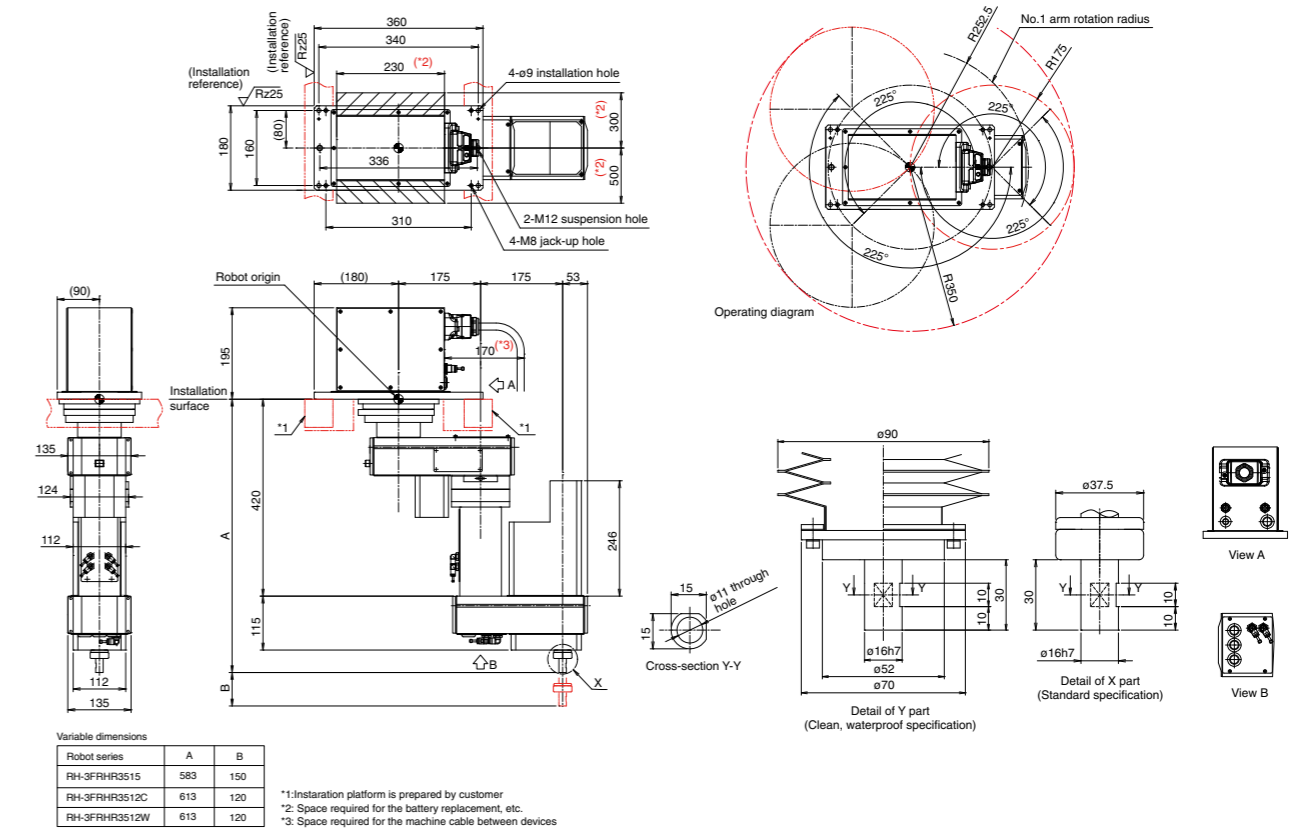

Specifications

Type	Unit	RH-3FRHR3515	RH-3FRHR3512C	RH-3FRHR3512W
Environmental specifications		Standard	Cleanroom	Waterproof
Protection degree *1		IP20	ISOclass5 *5	IP65 *6
Installation		Ceiling type		
Structure		Horizontal multiple-joint type		
Degrees of freedom		4		
Drive system		AC servo motor		
Position detection method		Absolute encoder		
Maximum load capacity	kg	Maximum 3 (Rated 1)		
Arm length	mm	175		
Maximum reach radius	mm	350		
Operating range	J1	450 (± 225)		
	J2	450 (± 225)		
	J3 (Z)	150	120	
	J4 (θ)	1440 (± 72)		
Maximum speed	J1	672		
	J2	708		
	J3 (Z)	1500		
	J4 (θ)	3146		
Maximum composite speed *2	mm/sec	6267		
Cycle time *3	sec	0.32		
Position repeatability	Y-X composite	± 0.01		
	J3 (Z)	± 0.01		
	J4 (θ)	± 0.01		
Ambient temperature	$^\circ\text{C}$	0 to 40		
Mass	kg	24	28	
Tolerable amount of inertia	Rating	0.005		
	Maximum	0.05		
Tool wiring		Gripper: 8 input points (up to 4 points for shaft) / 8 output points, 8 spare lines		
Tool pneumatic pipes		Primary: $\phi 6 \times 2$ Secondary: $\phi 4 \times 8$		
Machine cable		5m (connector on both ends)		
Connected controller *4		CR800-D, CR800-R, CR800-Q		

Waterproof specification

- IP65-rated and can be washed with water
 - Uses food-grade grease (NSF H1)*1
 - Prevents any peeling of the coating (coating-free)
- *1: Hygiene-related guidelines from the US NSF (National Sanitation Foundation)

Cleanroom specification

- ISO Class 5 cleanliness
- Suitable for clean environments, such as transporting electrical/electronic components and pharmaceutical products.
- Wiring and tubing can be installed internally in the tip. Prevents contamination produced by problems such as cable twisting or abrasion

Features

Reduced equipment space

By suspending the machine from the ceiling, wasted space is eliminated and less space is needed for the entire installation.

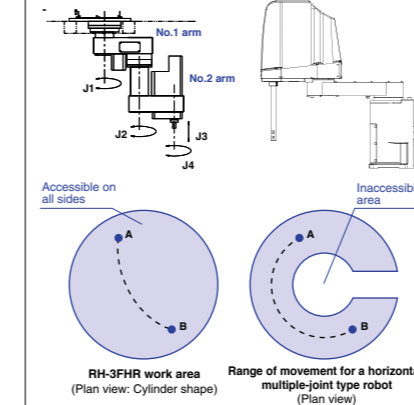

Easy installation and startup

- (1) Constructed so that it can be suspended from fittings installed on top of the ceiling joists, making installation simple.
- (2) Internal gripper tubing channels are provided in the tip axis, making tube installation easy and eliminating the problem of tangled tubes. (Handles up to 4 inside the shaft.)

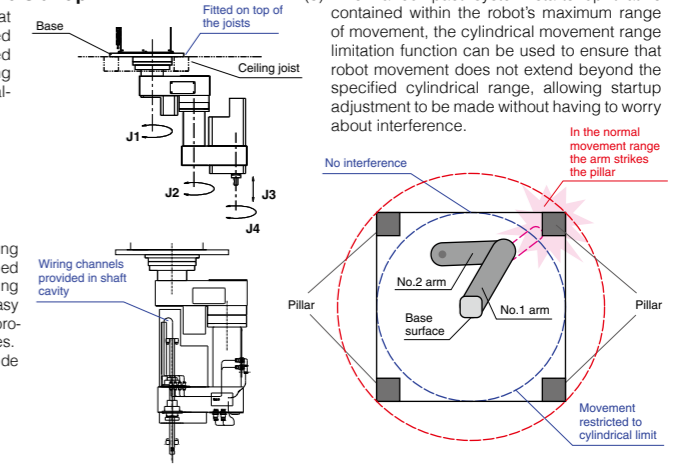

*1: The environmental resistance specifications (C: Cleanroom specifications, W: Waterproof specifications) for the RH-3FRHR is factory-set custom specifications.
*2: The value assumes composition of J1, J2, and J4.
*3: Value for a maximum load capacity of 1 kg. The cycle time may increase if specific requirements apply such as high work positioning accuracy, or depending on the operating position. (The cycle time is based on back-and-forth movement over a vertical distance of 25 mm in the clean room and internal robot suctioning. A $\phi 8$ -mm coupler for suctioning is provided at the back of the base.
*4: Select either controller according to your application. CR800-D: Standalone type, CR800-R: MELSEC iQ-R compatible type, CR800-Q: MELSEC Q Series compatible type.
*5: Preservation of cleanliness levels depends on conditions of a downstream flow of 0.3 m/s in the clean room and internal robot suctioning. A $\phi 8$ -mm coupler for suctioning is provided at the back of the base.
*6: Direct jet to the bellows is excluded.

RH-3FRHR3512-D

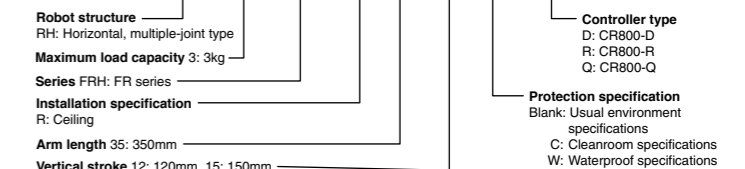

MELFA Controller CR800-R/Q/D

CR800-R
CR800-Q
CR800-D

MELSEC iQ-R/Q compatible robot controller

Uses a multi-CPU configuration that dramatically improves its interaction with FA equipment and also offers highly precise control and fast yet simple information management.

Standalone type robot controller

Can be constructed as the control nucleus for robot controllers.



Specifications

Type	Unit	CR800-R	CR800-Q	CR800-D
Robot CPU		R16RTCPU	Q172DSRCPU	Built-in
Path control method		PTP control and CP control		
Number of axes controlled		Maximum 6 axes + additional 8 axes available		
Robot language		MELFA-BASIC V, VI		
Position teaching method		Teaching method, MDI method		
Memory capacity	Number of teaching points	points	39000	26000
	Number of steps	step	78000	52000
	Number of programs	unit		512
External input/output	General-purpose I/O	points	0 input/0 output (8192 input points/8192 output points with the multiple CPU common device)	
	Dedicated I/O	points	Assigned to multiple CPU common device	
	Gripper open/close	points	8 input / 8 output *6	
	Emergency stop input	points	1 (redundant)	
	Door switch input	points	1 (redundant)	
	Enabling device input *7	points	1 (redundant)	
	Emergency stop output	points	1 (redundant)	
	Mode output	points	1 (redundant)	
	Robot error output	points	1 (redundant)	
	Synchronization of additional axes	points	1 (redundant)	
Interface	Encoder input	channels	2	Q173DPX (optional)
	RS-422	ports	1 (dedicated T/B)	
	Ethernet	ports	1 (dedicated T/B)	
	USB *5	ports	1 (for customer) 10BASE-T/100BASE-TX/1000BASE-T Correspondence with CC-Link IE Field Basic (Ver.A1d or later)	
	Additional-axis interface	channels	1 (SSCNET III/H)	
	Extension slot *1	slots	1 (Available only for function expansion option card)	
	R/C communication interface	channels	—	
	Remote I/O	channels	1 (Ver.2)	
Ambient temperature		°C	0 to 40 (controller) / 0 to 55 (robot CPU)	
		%RH	45 to 85	
Power supply	Input voltage range *2	V	RV-2FR/4FR/7FR, RH-3FRH/3FRHR/6FRH/12FRH/20FRH: Single-phase AC 200V to 230V RV-13FR/20FR/7FRLL, RH-1FRHR: Three-phase AC 200V to 230V or Single-phase AC 230V	
	Power capacity *3	KVA	RV-2FR, RH-3FRH: 0.5 RH-3FRHR, RV-4FR, RH-6FRH: 1.0 RH-12FRH/20FRH: 1.5 RV-7FR (except RV-7FRLL): 2.0 RV-7FRLL, RV-13FR, RV-20FR: 3.0	
External dimensions (including legs)	mm	430(W) × 425(D) × 99.5(H)		
Weight	kg	Approx. 12.5		
Structure [protective specification]		Self-contained floor type/open structure (Vertical and horizontal position can be placed) [IP20]		
Grounding *4	Ω	100 or less (class D grounding)		

*1: For installing option interface.
*2: The rate of power-supply voltage fluctuation is within 10%.
*3: The power capacity indicates the rating for normal operation. Take note that the power capacity does not include the current being input when the power is turned on. The power capacity is only a rough guide and whether or not operation can be guaranteed depends on the input power-supply voltage.
*4: Grounding works are the customer's responsibility.
*5: Recommended USB cable (USB A-to-USB mini B): MR-J3USBCBL3M (Mitsubishi Electric), GT09-C30USB-5P (Mitsubishi Electric System & Service Co., Ltd)
*6: RV-2FR series has 4 inputs and 4 outputs.
*7: Mode selection switch provided by the customer.

Controller CR800-R/CR800-Q

External Dimensions

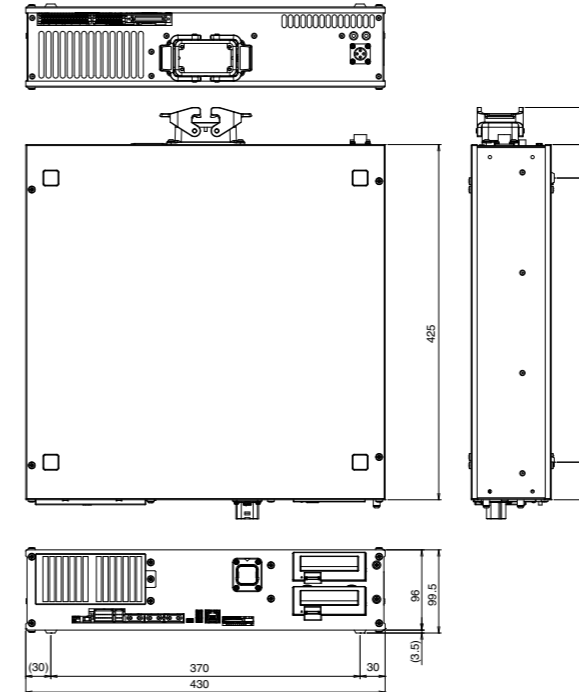

R16RTCPU

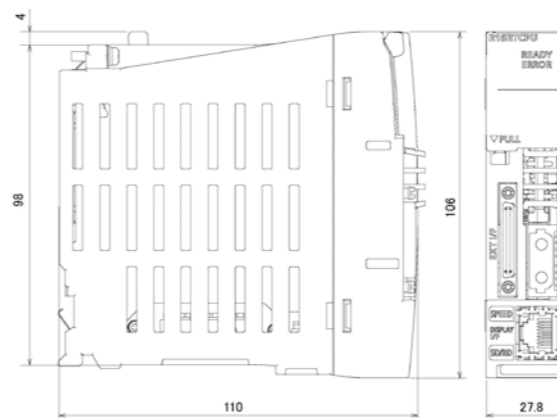

Q172DSRCPU

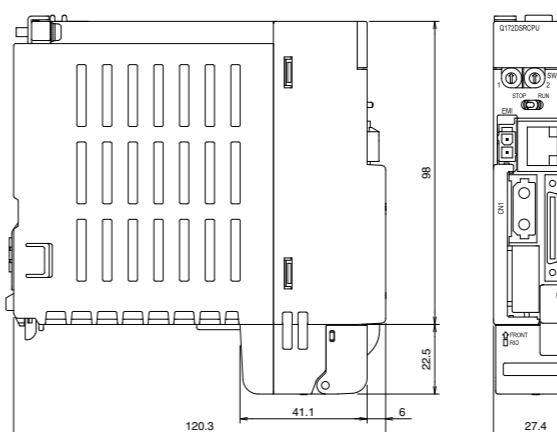

CR800-D

External Dimensions

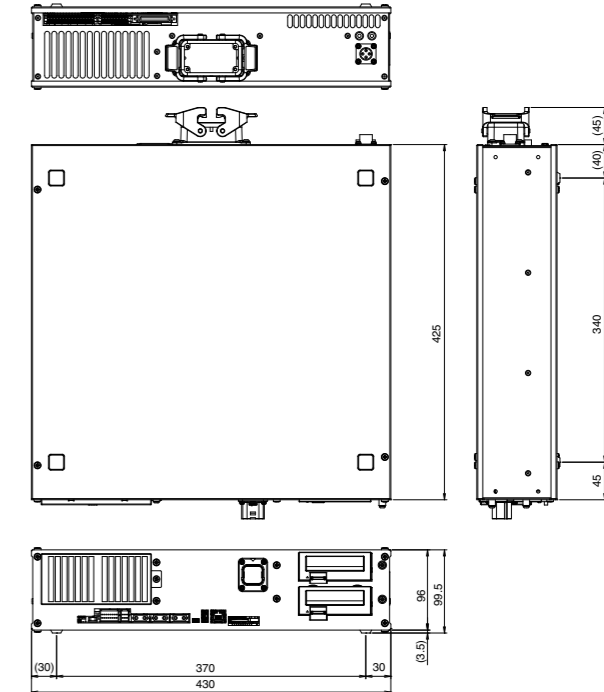

Multiple CPU environment

<CR800-R>

Unit	Type
Base	R35B 5-slot
	R38B 8-slot
	R312B 12-slot
Power supply	R61P
	R62P
	R63P
	R64P
PLC CPU	R00CPU
	R01CPU
	R02CPU
	R04CPU
	R08CPU
	R120CPU

<CR800-Q>

Unit	Type
Base	High-speed standard base between multiple CPU
	Q35DB 5-slot
	Q38DB 8-slot
Power supply	Q312DB 12-slot
	Q61P
	Q62P
PLC CPU	Q63P
	Q64PN
	Universal Model
	Q03UD(E/V)CPU
	Q04UD(E/V)HCPU
	Q06UD(E/V)HCPU
	Q10UD(E)HCPU
	Q13UD(E/V)HCPU
Q20UD(E)HCPU	
Q26UD(E/V)HCPU	
Q100UD(E)HCPU	

Note) For details of the PLC units, refer to the PLC manual or the Mitsubishi Electric FA website, etc.

Robot arm options (RV)



Machine cable (standard)
Fixed 5 m



Machine cable (replacement)
Fixed 2, 10, 15 or 20 m
Flexible 10, 15 or 20 m



Solenoid valve set (sink/source type)
With dedicated hand output cable
1 to 4 valves



Hand output cable
Used when solenoid valves are provided by the customer



Hand input cable
For gripper sensor signal input



Hand curl tube
Tube for pneumatic grippers (1 to 4 tubes)



J1 axis movement range modification
J2 axis movement range modification (RV-2FR series)
J3 axis movement range modification (RV-2FR series)
To be installed by the customer.



Cable outlets in the machine

- Forearm external wiring set
- Base external wiring set



Internal wiring/ tubing specifications

The factory default specification is for wiring/tubing to be routed internally to the wrist with an outlet from the mechanical interface.



RV-FR Mechanical Options

No.	Name	Type	RV					Specifications
			2FR 2FRL	4FR 4FRL	7FR 7FRL	7FRLL	13FR 13FRL 20FR	
①	Solenoid valve set	1E-VD0□ (sink) 1E-VD0□E (source)	○	—	—	—	—	1 to 2 valves with solenoid valve cable. □ indicates the number of valves (1 or 2); output: 4ø
		1F-VD0□-02 (sink) 1F-VD0□E-02 (source)	—	○	○	○	—	1 to 4 valves with solenoid valve cable. □ indicates the number of valves (1, 2, 3, 4); output: 4ø
		1F-VD0□-03 (sink) 1F-VD0□E-03 (source)	—	—	—	—	○	1 to 4 valves with solenoid valve cable. □ indicates the number of valves (1, 2, 3, 4); output: 6ø
②	Hand output cable	1E-GR35S	○	—	—	—	—	Straight cable for 2-valve systems, robot connector on one end, unterminated on the other. Total length: 350 mm
		1F-GR35S-02	—	○	○	○	○	Straight cable for 4-valve systems, robot connector on one end, unterminated on the other. Total length: 500 mm
③	Hand input cable	1S-HC30C-11	○	—	—	—	—	4-point type, with a robot connector on one side and unterminated on the other. Total length: 1000 mm
		1F-HC35S-02	—	○	○	○	○	4-point type, with a robot connector on one side and unterminated on the other. Total length: 1000 mm
④	Hand curl tube	1E-ST040□C	○	○	○	○	—	For 1- to 4-ø4-valve systems; total length: 630 mm (including 180 mm curled section) □ indicates No. of tubes (2, 4, 6 or 8), 2 or 4 only in the RV-2FR and RV-2FRL
		1N-ST060□C	—	—	—	—	○	For 1- to 4-ø6-valve systems; total length: 1150 mm (including 250 mm curled section) □ indicates No. of tubes (2, 4, 6 or 8)
⑤	Forearm external wiring set 1	1F-HB01S-01	—	○	○	○	○	For the forearm. External wiring box used for connecting the gripper input cable, Ethernet cable and the electric gripper and force sensor cable.
		1F-HB02S-01	—	○	○	○	○	For the forearm. External wiring box used for connecting the force sensor, electric gripper and Ethernet cable.
⑥	Base external wiring set 1	1F-HA01S-01	—	○	○	○	○	For the base. External wiring box used for connecting the electric gripper communications output, electric gripper and force sensor cable and Ethernet cable. Includes gripper input.
		1F-HA02S-01	—	○	○	○	○	For the base. External wiring box used for connecting the electric gripper communications output, electric gripper, force sensor and Ethernet cable. No gripper input.
⑦	Machine cable (replacement) (fixed)	1F-□□UCBL-41	○	○	○	○	○	Replacement type, 2, 10, 15 or 20 m □ indicates cable length (02, 10, 15 or 20 m)
		Machine cable (replacement) (flexible)	1F-□□LUCBL-41	○	○	○	○	○
⑧	J1 axis movement range modification	1S-DH-11J1	○	—	—	—	—	Stopper for changing the range, installed by customer
		1F-DH-05J1	—	—	—	○	○	Stopper for changing the range, installed by customer (Also compatible with RV-7FRLL)
		1F-DH-04	—	—	○	—	—	Stopper for changing the range, installed by customer
		1F-DH-03	—	○	—	—	—	Stopper for changing the range, installed by customer
J2 axis movement range modification	1S-DH-11J2	○	—	—	—	—	Stopper for changing the range, installed by customer	
J3 axis movement range modification	1S-DH-11J3	○	—	—	—	—	Stopper for changing the range, installed by customer	

RV-4FR/7FR/13FR/20FR series tooling machine configurations

The required options differ depending on the gripper (tool) configuration. The table below lists the "Forearm external wiring sets" and "Base external wiring sets" required for the different gripper configurations. Select wiring sets accordingly.

Gripper configuration	Wiring mode	Body specifications	Required equipment		Comment
			Forearm external wiring set	Base external wiring set (*3)	
•Pneumatic gripper + gripper input signals	Internal	-SH01	— (*1)	—	Air tubes: Up to 2 sets (4ø × 4), 8 input signals
	Externa	Standard	— (*2)	—	Air tubes: Up to 4 sets (4ø × 8)
•Pneumatic gripper + gripper input signals •Vision sensor	Internal	-SH05	— (*1)	(1F-HA01S-01)	Air tubes: Up to 1 set (4ø × 2), 8 input signals
	Externa	Standard	1F-HB01S-01 (*2)	1F-HA01S-01	Air tubes: Up to 4 sets (4ø × 8)
•Pneumatic gripper + gripper input signals •Force sensor	Internal	-SH04	— (*1)	(1F-HA01S-01)	Air tubes: Up to 1 set (4ø × 2), 8 input signals
	Externa	Standard	1F-HB01S-01 (*2)	1F-HA01S-01	Air tubes: Up to 4 sets (4ø × 8)
•Pneumatic gripper + gripper input signals •Vision sensor •Force sensor	Internal (External air tubes)	-SH02	— (*1)	(1F-HA01S-01)	External air tubes: Up to 4 sets (4ø × 8)
	Externa	Standard	1F-HB01S-01	1F-HA01S-01	Air tubes: Up to 4 sets (4ø × 8)
•Electric gripper + gripper input signals •Vision sensor	Internal	-SH02	—	(1F-HA01S-01)	
	Externa	Standard	1F-HB01S-01	1F-HA01S-01	
•Electric gripper •Vision sensor •Force sensor	Internal	-SH03	—	(1F-HA02S-01)	
	Externa	Standard	1F-HB02S-01	1F-HA02S-01	

*1: For pneumatic grippers with internal wiring, solenoid valves should be provided.
*2: For pneumatic grippers with external wiring, solenoid valves, tubing and input cables, etc. should be provided as necessary.
*3: For machines with internal wiring and tubing, a base external wiring set is included with the machine and does not need to be provided separately.

Robot arm options (RH)



Machine cable (standard)
Fixed 5 m



Machine cable (replacement)
Fixed 2, 10, 15 or 20 m
Flexible 10, 15 or 20 m



J1 axis movement range modification
J2 axis movement range modification
To be installed by the customer.

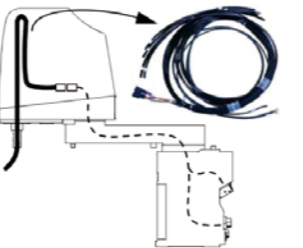

Internal wiring and tubing set for grippers
An air tube and cable set used to run air tubes and gripper input signal cables from inside the second arm to the shaft tip

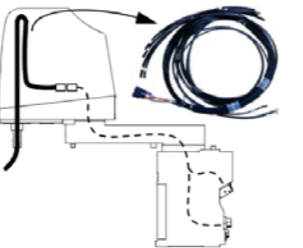

External wiring and tubing box
A useful option for taking air tubes and signal wires out from the back end of the second arm or running gripper wiring and/or tubing outside the robot

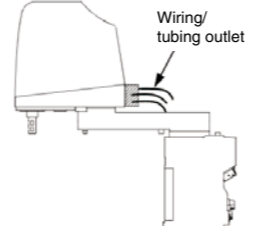

Solenoid valve set (sink/source type) ①
With dedicated hand output cable
1 to 4 valves



Hand output cable ②
Used when solenoid valves are provided by the customer

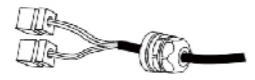

Hand input cable ③
For gripper sensor signal input

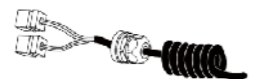

Hand curl tube ④
Tube for pneumatic grippers (1 to 4 tubes)

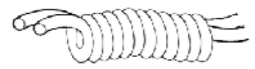

Hand tube (for RH-3FRHR series) ⑤
Tube for pneumatic grippers (2 tubes)



RH-FR Main Options

No.	Name	Type	RH				Specifications
			3FRH	6FRH	12FRH 20FRH	3FRHR	
①	Solenoid valve set	1F-VD0□-01 (Sink)	○	○	—	—	1 to 4 valves with solenoid valve cable. □ indicates the number of valves (1, 2, 3, 4); output: 4φ
		1F-VD0□E-01 (Source)	—	—	○	—	1 to 4 valves with solenoid valve cable. output: 6 mm dia. (standard)
		1S-VD0□-01 (Sink)	—	—	○	—	4 valves with solenoid valve cable. □ indicates the number of valves (1, 2, 3, 4); output: 6φ
		1S-VD0□E-01 (Source)	—	—	—	○	4 valves with solenoid valve cable. Output: ø4 (cleanroom specification / waterproof specification)
②	Hand output cable	1F-GR60S-01	○	○	○	—	For 4-valve systems, robot connector on one end, unterminated on the other, with drip-proof grommet Total length 1,050 mm, straight CBL
		1S-GR35S-02	—	—	—	○	Straight cable for 4-valve systems, robot connector on one end, unterminated on the other. Total length: 450 mm
③	Hand input cable	1F-HC35C-01	○	○	—	—	8-point type, with a robot connector on one side and unterminated on the other, equipped with a splash-proof grommet. Total length: 1800 mm (including 350 mm curled section)
		1F-HC35C-02	—	—	○	—	8-point type, with a robot connector on one side and unterminated on the other, equipped with a splash-proof grommet. Total length: 1650 mm (including 350 mm curled section)
		1S-HC00S-01	—	—	—	○	4-point type, with a robot connector on one side and unterminated on the other, equipped with a splash-proof grommet. Total length: 1210 mm
④	Hand curl tube	1E-ST0408C-300	○	○	—	—	For 4-ø4-valve systems; total length: 1000 mm (including 300 mm curled section)
		1N-ST0608C-01	—	—	○	—	For 1- to 4-ø6-valve systems; total length: 630 mm (including 250 mm curled section)
⑤	Hand tube	1S-ST0304S	—	—	—	○	3 mm dia. for 2 tubes (customer-usable length: 400 mm)
⑥	Internal wiring and tubing set for grippers	1F-HS604S-01	—	—	○	—	Internal wiring and tubing set for the tip axis (8 gripper inputs + two 6 mm dia. tubes) For 350 mm Z-axis stroke
		1F-HS604S-02	—	—	○	—	Internal wiring and tubing set for the tip axis (8 gripper inputs + two 6 mm dia. tubes) For 450 mm Z-axis stroke
		1F-HS408S-01	—	○	—	—	Internal wiring and tubing set for the tip axis (8 gripper inputs + four 4 mm dia. tubes) For 200 mm Z-axis stroke
		1F-HS408S-02	—	○	—	—	Internal wiring and tubing set for the tip axis (8 gripper inputs + four 4 mm dia. tubes) For 340 mm Z-axis stroke
		1F-HS304S-01	○	—	—	—	Wiring and piping set for internal mounting in the tip axis (compatible with 4 input points for gripper systems+ø3-2 solenoid valve systems)
⑦	External user wiring and tubing box	1F-UT-BOX-01	—	—	○	—	External outlet box for user wiring (gripper input/output, gripper tubes)
		1F-UT-BOX	○	○	—	—	External outlet box for user wiring (gripper input/output, gripper tubes)
⑧	Machine cable (replacement) (fixed)	1F-□□UCBL-41	○	○	○	○	Replacement type, 2, 10, 15 or 20 m □ indicates cable length (02, 10, 15 or 20 m)
		1F-□□LUCBL-41	○	○	○	○	Replacement type, 10, 15 or 20 m □ indicates cable length (10, 15 or 20 m)
⑨	J1 axis movement range modification	1F-DH-02	—	—	○	—	Stopper for changing the range, installed by customer
		1F-DH-01	○	○	—	—	Stopper for changing the range, installed by customer
		1S-DH-05J1	—	—	—	○	Stopper for changing the range, installed by customer
		1S-DH-11J2	—	—	—	—	Stopper for changing the range, installed by customer
J2 axis movement range modification	1S-DH-05J2	—	—	—	○	Stopper for changing the range, installed by customer	

R Type Controller

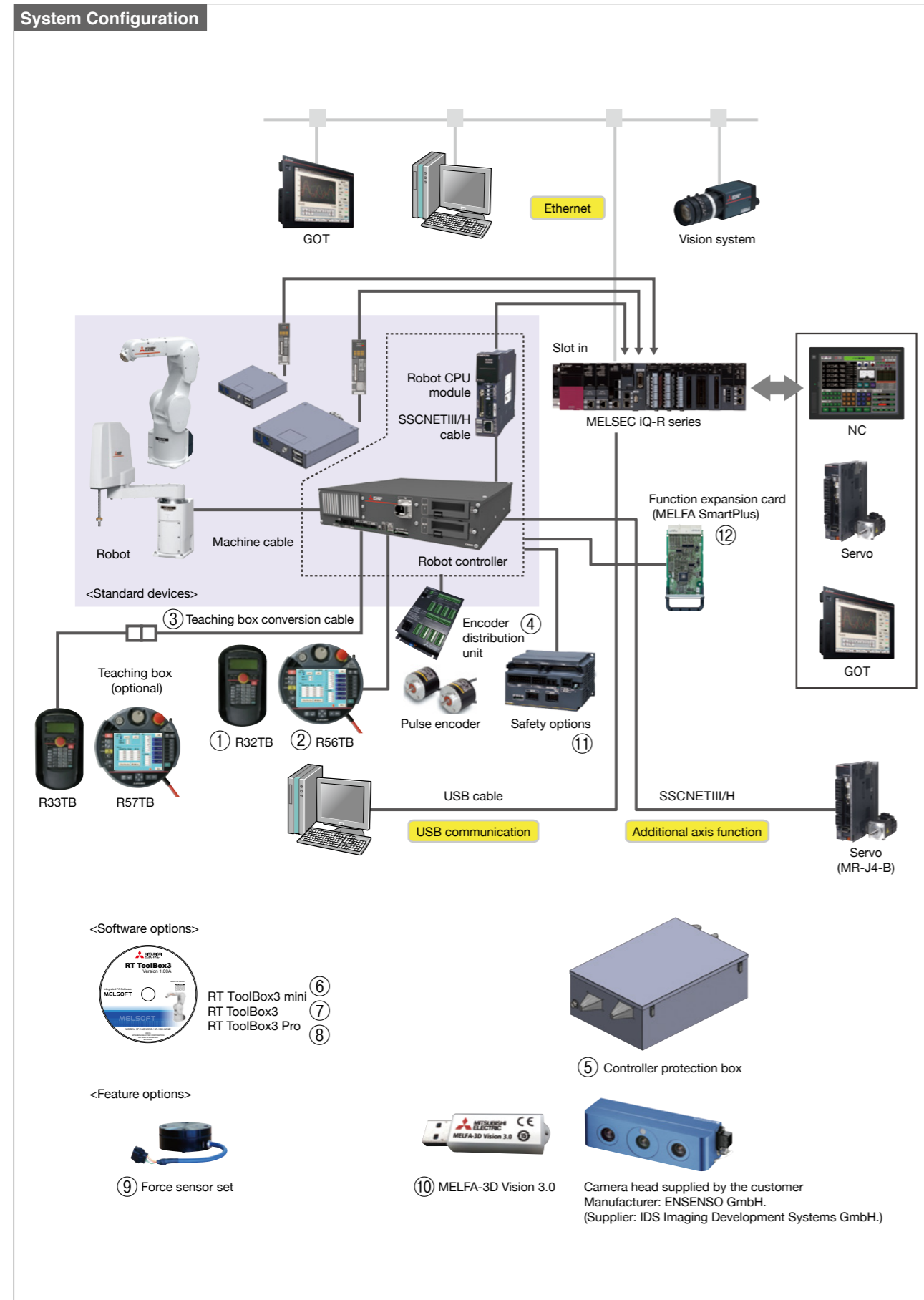

OPTIONS (R Type Controller)

Optional Configuration (Controllers)

No.	Name	Model	Specifications
①	Simple teaching box (7, 15 m)	R32TB (-**)	7 m: Standard; 15 m: Special (model name includes "-15")
②	High-performance teaching box (7, 15 m)	R56TB (-**)	7 m: Standard; 15 m: Special (model name includes "-15")
③	Teaching box conversion cable (33→32)	2F-33CON03M	Conversion cable for connecting the CR800 controller to the R33TB/R57TB. Cable length: 3m
④	Encoder distribution unit	2F-YZ581	Unit used for connecting multiple controllers to one rotary encoder when using the tracking function (for 4 robots)
⑤	Controller protection box	CR800-MB	Houses a controller and provides protection against dust and water. (IP54)
⑥	Computer support software mini version	3F-15C-WINE	Simplified version (CD-ROM), (RT ToolBox3 mini)
⑦	Computer support software	3F-14C-WINE	With simulation function (CD-ROM), (RT ToolBox3)
⑧	Computer support software Pro version	3F-16C-WINE	Professional version (DVD-ROM), (RT ToolBox3 Pro)

Optional Configurations (Functions)

No.	Name	Model	Specifications
⑨	Force sensor set	4F-FS002H-W200 4F-FS002H-W1000	Set of devices required for force control functionality, including force sensors, the interface unit, and support software.
⑩	MELFA-3D Vision 3.0	3F-53U-WINM	MELFA-3D Vision software
⑪	Safety option	4F-SF002-01	Devices required by the safety functions

Option Configurations (Software Expansion Functions)

No.	Name	Model	Specifications
⑫	MELFA Smart Plus Card Pack	2F-DQ510	Enables all A-type functions
		2F-DQ520	Enables all A and B-type functions
	MELFA Smart Plus Card	2F-DQ511	Selects and enables one function from the A-type functions
		2F-DQ521	Selects and enables one function from the A and B-type functions

Classification	Name	Type	Function outline
Intelligent function	Calibration assistance function	A	Assists positional calibration with peripheral devices using 2D vision sensors. Improves positioning accuracy by automatically correcting the vision sensor coordinates. Improves positioning accuracy by correcting the robot coordinates and work coordinates from the vision sensor. Uses vision sensors to adjust the relative locations of multiple robots. Improves positioning accuracy during coordinated operation.
	Automatic calibration		
	Work coordinate calibration		
	Inter-robot relational calibration		
	Robot mechanism thermal compensation function	A	Improves positioning accuracy by compensating for thermal expansion in the robot arm.
Coordinated control for additional axis	A	Function for highly accurate coordination (interpolation) with additional axis (straight coaxial)	
Preventive maintenance function (Maintenance simulation, Wear calculation function)	A	Function for managing the robot status by tracking operation status. * Compatible with robot controller Version A3 or later.	
AI function	MELFA 3D Vision enhancement function	B	Automates 3D vision sensor parameter adjustment work, and improves measurement and recognition performance using AI technology. * Compatible with robot controller Version A3 or later.
	Predictive maintenance function (Fault detection function)	B	Quickly detects abnormalities in drive system components before they affect robot behavior. * Compatible with robot controller Version A4 or later. * By enabling this function, it is also possible to use the preventive maintenance function (maintenance simulation and wear calculation function).
	Enhancement function for force sense control	B	Utilizes AI technology to perform repeated learning in a short time period to calculate the optimal insertion pattern. * Compatible with robot controller Version A4 or later.

Q Type Controller

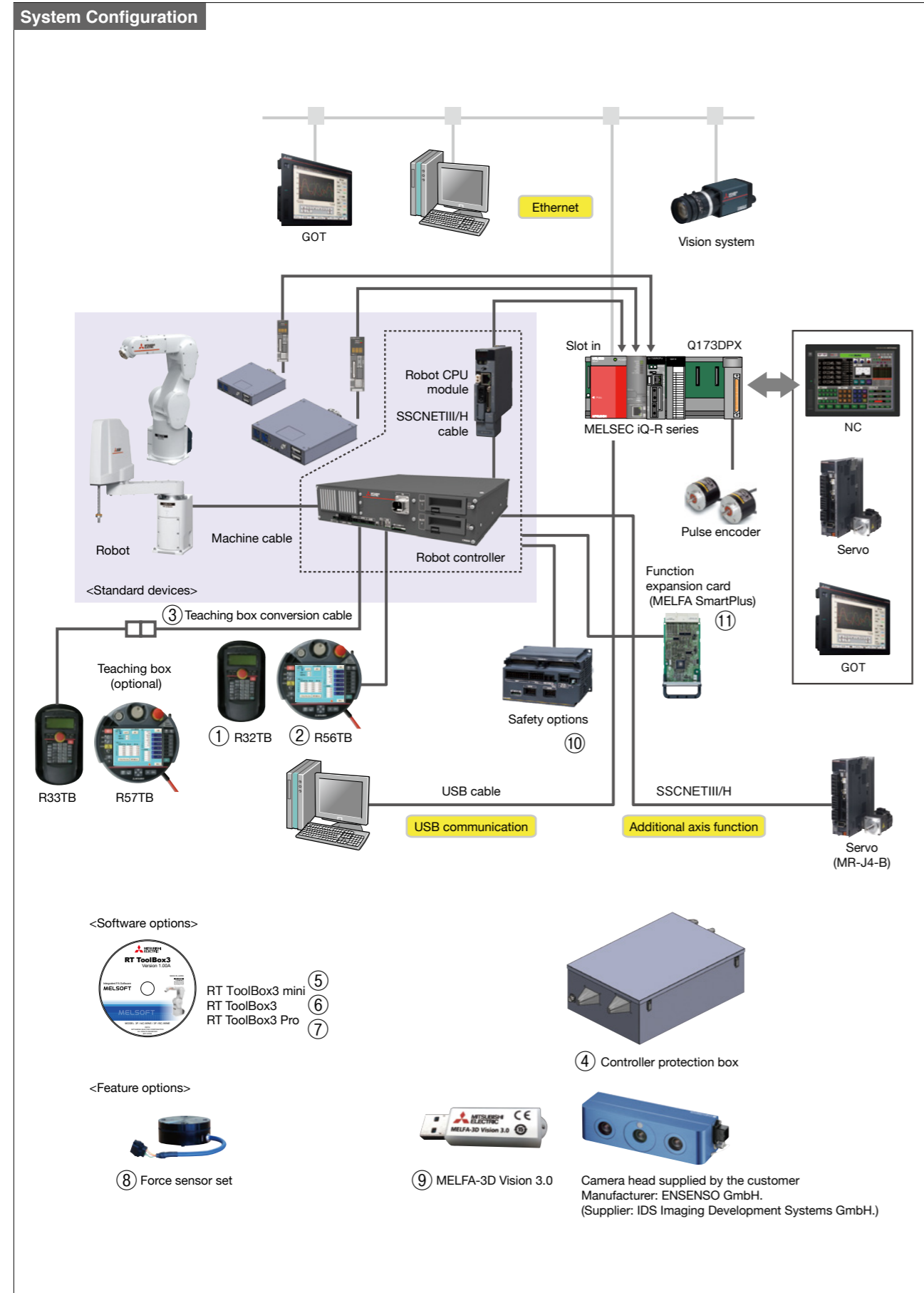

OPTIONS (Q Type Controller)

Optional Configuration (Controllers)

No.	Name	Model	Specifications
①	Simple teaching box (7, 15 m)	R32TB (-**)	7 m: Standard; 15 m: Special (model name includes "-15")
②	High-performance teaching box (7, 15 m)	R56TB (-**)	7 m: Standard; 15 m: Special (model name includes "-15")
③	Teaching box conversion cable (33→32)	2F-33CON03M	Conversion cable for connecting the CR800 controller to the R33TB/R57TB. Cable length: 3m
④	Controller protection box	CR800-MB	Houses a controller and provides protection against dust and water. (IP54)
⑤	Computer support software mini version	3F-15C-WINE	Simplified version (CD-ROM), (RT ToolBox3 mini)
⑥	Computer support software	3F-14C-WINE	With simulation function (CD-ROM), (RT ToolBox3)
⑦	Computer support software Pro version	3F-16C-WINE	Professional version (DVD-ROM), (RT ToolBox3 Pro)

Optional Configurations (Functions)

No.	Name	Model	Specifications
⑧	Force sensor set	4F-FS002H-W200 4F-FS002H-W1000	Set of devices required for force control functionality, including force sensors, the interface unit, and support software.
⑨	MELFA-3D Vision 3.0	3F-53U-WINM	MELFA-3D Vision software
⑩	Safety option	4F-SF002-01	Devices required by the safety functions

Option Configurations (Software Expansion Functions)

No.	Name	Model	Specifications
⑪	MELFA Smart Plus Card Pack	2F-DQ510	Enables all A-type functions
		2F-DQ520	Enables all A and B-type functions
	MELFA Smart Plus Card	2F-DQ511	Selects and enables one function from the A-type functions
		2F-DQ521	Selects and enables one function from the A and B-type functions

Classification	Name	Type	Function outline
Intelligent function	Calibration assistance function	A	Assists positional calibration with peripheral devices using 2D vision sensors.
	Automatic calibration		Improves positioning accuracy by automatically correcting the vision sensor coordinates.
	Work coordinate calibration		Improves positioning accuracy by correcting the robot coordinates and work coordinates from the vision sensor.
	Inter-robot relational calibration	Uses vision sensors to adjust the relative locations of multiple robots. Improves positioning accuracy during coordinated operation.	
	Robot mechanism thermal compensation function	A	Improves positioning accuracy by compensating for thermal expansion in the robot arm.
AI function	Coordinated control for additional axis	A	Function for highly accurate coordination (interpolation) with additional axis (straight coaxial)
	Preventive maintenance function (Maintenance simulation, Wear calculation function)	A	Function for managing the robot status by tracking operation status. * Compatible with robot controller Version A3 or later.
	MELFA 3D Vision enhancement function	B	Automates 3D vision sensor parameter adjustment work, and improves measurement and recognition performance using AI technology. * Compatible with robot controller Version A3 or later.
	Predictive maintenance function (Fault detection function)	B	Quickly detects abnormalities in drive system components before they affect robot behavior. * Compatible with robot controller Version A4 or later. * By enabling this function, it is also possible to use the preventive maintenance function (maintenance simulation and wear calculation function).
	Enhancement function for force sense control	B	Utilizes AI technology to perform repeated learning in a short time period to calculate the optimal insertion pattern. * Compatible with robot controller Version A4 or later.

D Type Controller

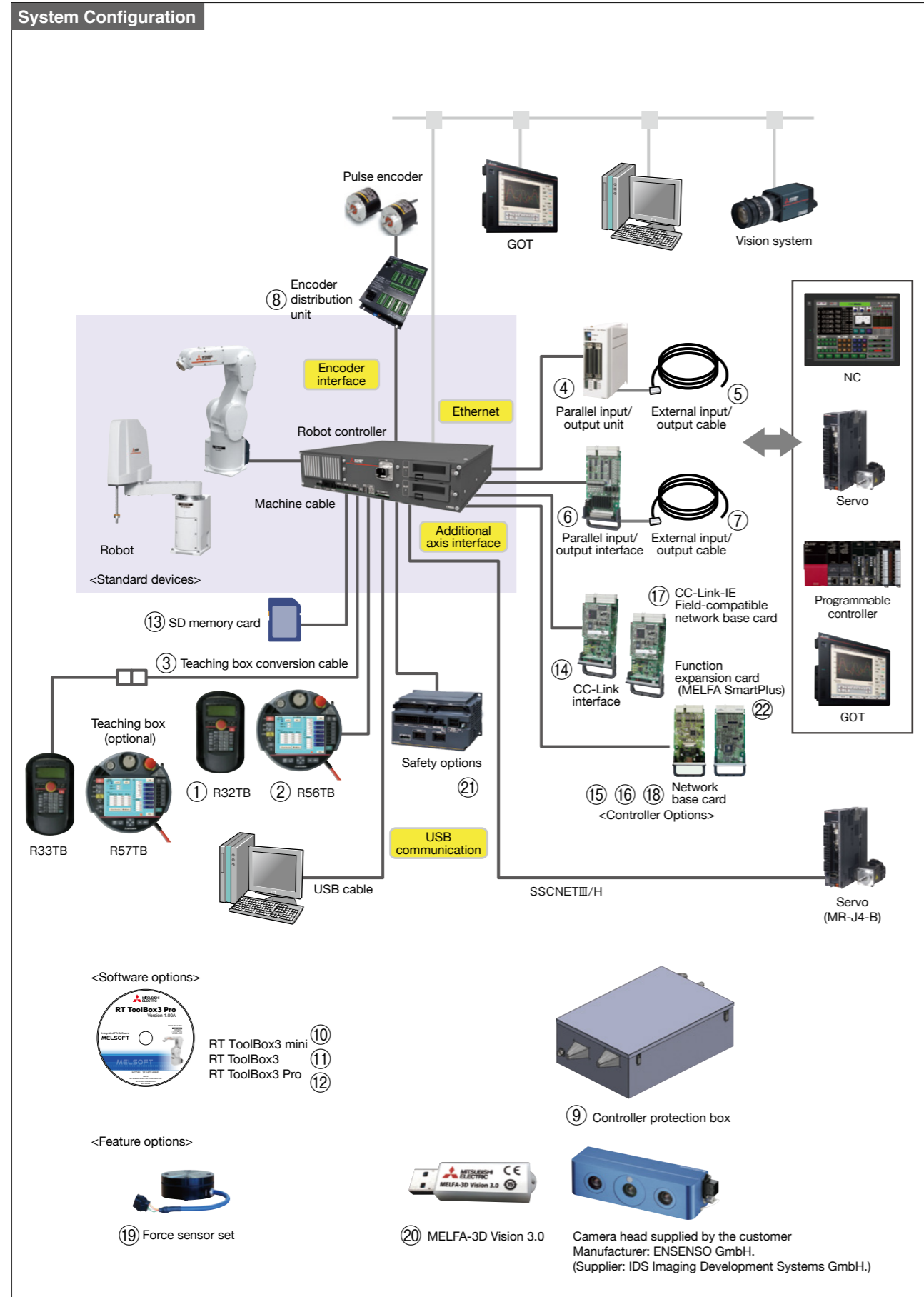

OPTIONS (D Type Controller)

Optional Configuration (Controllers)

No.	Name	Model	Specifications
①	Simple teaching box (7, 15 m)	R32TB(-**)	7 m: Standard; 15 m: Special (model name includes "-15")
②	High-performance teaching box (7, 15 m)	R56TB(-**)	7 m: Standard; 15 m: Special (model name includes "-15")
③	Teaching box conversion cable (33→32)	2F-33CON03M	Conversion cable for connecting the CR800 controller to the R32TB/R57TB. Cable length: 3m
④	Parallel input/output unit	(Sink type)	2A-RZ361
		(Source type)	2A-RZ371
⑤	External input/output cable (5, 15 m)	2A-CBL**	CBL05: 5 m; CBL15: 15 m, one end unterminated For 2A-RZ361/371
⑥	Parallel input/output interface (built-in)	(Sink type)	2D-TZ368
		(Source type)	2D-TZ378
⑦	External input/output cable (5, 15 m)	2D-CBL**	CBL05: 5 m; CBL15: 15 m, one end unterminated For 2D-TZ368/378
⑧	Encoder distribution unit	2F-YZ581	Unit used for connecting multiple controllers to one rotary encoder when using the tracking function (for 4 robots)
⑨	Controller protection box	CR800-MB	Houses a controller and provides protection against dust and water. (IP54)
⑩	Computer support software mini version	3F-15C-WINJ	Simplified version (CD-ROM), (RT ToolBox3 mini)
⑪	Computer support software	3F-14C-WINJ	With simulation function (CD-ROM), (RT ToolBox3)
⑫	Computer support software Pro version	3F-16D-WINJ	Professional version (DVD-ROM), (RT ToolBox3 Pro)
⑬	SD memory card	2F-2GBSD	2 GB, logging
⑭	CC-Link interface	2D-TZ576	CC-Link intelligent device station Ver. 2.0, for 1-4 stations
⑮	Network base card (Ethernet/IP interface)	2D-TZ535	Communications interface for installation in an HMS Anybus-CompactCom module. HMS Ethernet/IP module (AB6314) to be provided by the customer.
⑯	Network base card (PROFINET interface)	2D-TZ535-PN	Communications interface for installation in an HMS Anybus-CompactCom module. HMS PROFINET IO module (AB6489-B) to be provided by the customer.
⑰	Network base card (CC-Link-IE Field interface)	2F-DQ535	Communications interface for installation in an HMS Anybus-CompactCom module. HMS CC-Link-IE Field module (AB6709) to be provided by the customer.
⑱	Network base card (EtherCAT interface)	2F-DQ535-EC	Communications interface for installation in an HMS Anybus-CompactCom module. HMS EtherCAT module (AB6607) to be provided by the customer.

Optional Configurations (Functions)

No.	Name	Model	Specifications
⑲	Force sensor set	4F-FS002H-W200 4F-FS002H-W1000	Set of devices required for force control functionality, including force sensors, the interface unit, and support software.
⑳	MELFA-3D Vision 3.0	3F-53U-WINM	MELFA-3D Vision software
㉑	Safety option	4F-SF002-01	Devices required by the safety functions

Option Configurations (Software Expansion Functions)

No.	Name	Model	Specifications
㉒	MELFA Smart Plus Card Pack	2F-DQ510	Enables all A-type functions
		2F-DQ520	Enables all A and B-type functions
		2F-DQ511	Selects and enables one function from the A-type functions
	MELFA Smart Plus Card	2F-DQ521	Selects and enables one function from the A and B-type functions

Classification	Name	Type	Function outline	
Intelligent function	Calibration assistance function	A	Assists positional calibration with peripheral devices using 2D vision sensors.	
	Automatic calibration			Improves positioning accuracy by automatically correcting the vision sensor coordinates.
	Work coordinate calibration			Improves positioning accuracy by correcting the robot coordinates and work coordinates from the vision sensor.
	Inter-robot relational calibration	Uses vision sensors to adjust the relative locations of multiple robots. Improves positioning accuracy during coordinated operation.		
	Robot mechanism thermal compensation function	A	Improves positioning accuracy by compensating for thermal expansion in the robot arm.	
Coordinated control for additional axis	A	Function for highly accurate coordination (interpolation) with additional axis (straight coaxial)		
Preventive maintenance function (Maintenance simulation, Wear calculation function)	A	Function for managing the robot status by tracking operation status. * Compatible with robot controller Version A3 or later.		
AI function	MELFA 3D Vision enhancement function	B	Automates 3D vision sensor parameter adjustment work, and improves measurement and recognition performance using AI technology. * Compatible with robot controller Version A3 or later.	
	Predictive maintenance function (Fault detection function)	B	Quickly detects abnormalities in drive system components before they to affect robot behavior. * Compatible with robot controller Version A4 or later. * By enabling this function, it is also possible to use the preventive maintenance function (maintenance simulation and wear calculation function).	
	Enhancement function for force sense control	B	Utilizes AI technology to perform repeated learning in a short time period to calculate the optimal insertion pattern. * Compatible with robot controller Version A4 or later.	

Solenoid valve set



RH-3FHR and 6FHR
RH-12FHR and 20FHR

When grippers or various other tools are mounted on the end of the arm, this solenoid valve option is used to control those tools. Fitted with features such as manifolds, couplings and connectors to facilitate mounting on the robot body. The solenoid valve attachment shapes differ depending on the robot. Note the attachment shape before using.

Hand output cable

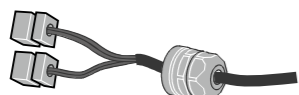

Cable size x No. of cores	AWG#24 (0.2 mm ²) x 12 cores
Total length:	300 mm (RV), 1050 mm (RH)

Useful for using solenoid valves other than the optional solenoid valve set. One end can be connected to the gripper signal output connector in the robot. The other end is unterminated (bare cable).

Hand input cable

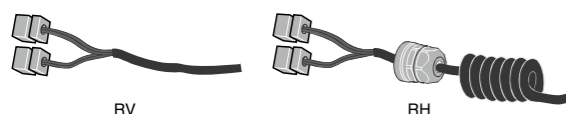

Cable size x No. of cores	AWG#24 (0.2 mm ²) x 12 cores
Total length:	1000 mm (RV), 1650/1800 mm (RH: Includes a 350 mm curled section)

Used when the air gripper is designed by the customer. Used to convey gripper open/close confirmation signals and grip confirmation signals to the controller. One end can be connected to the gripper signal input connector on the top of the robot body. The other end is connected to a sensor in the gripper designed by the customer.

Hand curl tube

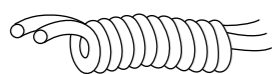

Material	Urethane
Size (mm)	4 mm dia. (external), 2.5 mm dia. (internal); length: 180 mm curled section, 250 + 200 mm straight section

Curl tube for air gripper.

Internal wiring and tubing set for grippers

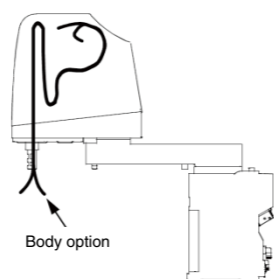

Body option

An air tube and cable set used to run input signal cables from inside the second arm to the shaft tip. An air tube and gripper input signal cable set. Includes grease (for applying to the upper part of the shaft), silicon rubber and cable ties.

External user wiring and tubing box

This is a useful option for taking air tubes and signal wires out from the back end of the second arm or running gripper wiring and/or tubing outside the robot. Features a coupling for exiting air tubes and a hole with cable clamps to secure exiting signal wires. Optional gripper output cables and gripper input cables can be secured.

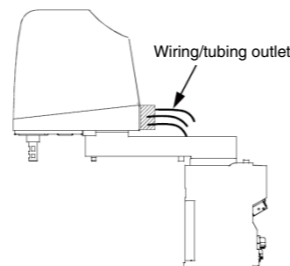

J1 axis movement range modification

	RV (*1)	RH
+J1	(Standard +240°) +210°, +150°, +90°	(Standard +170°) +150°, +130°
-J1	(Standard -240°) -210°, -150°, -90°	(Standard -170°) -150°, -130°

*1: For RV-2FR or RV-2FRL. Refer to the specifications for information on other models.

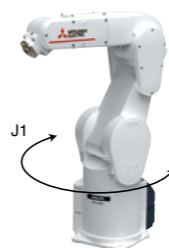

The J1 axis range of movement is limited by mechanical stoppers on the robot body and by the controller parameters. Use this feature when the range of movement needs to be limited due to problems such as interference with nearby devices.

Machine cable (replacement)



Fixed cable	2m, 10m, 15m or 20m
Flexible cable	10, 15 or 20 m; min. bend radius: 100 R or more

Used for replacement of the standard machine cable (5 m) included to extend the distance between robot controller and the robot main unit and connect it. There are 2 types of cables: fixed and flexible. Both type consists of motor signal cable and motor power cable.

Simple teaching box

R32TB

External dimensions	195 (W) x 292 (H) x 106 (D) mm
Weight	Approx. 0.9 kg (body only, excluding cables)
Display	LCD type: 24 characters x 8 rows, backlit
Display languages	Japanese, English



Used for creating, editing and managing programs, to teach operating positions and for jogging. Fitted with a 3-position enabling switch to ensure safe use. When multiple robots are used, the connections can be switched to a single teaching box. The connections can be switched when the power is shut off.

Parallel input/output unit

<Input>		
Model	DC input	
No. of input	32	
Isolation method	Photocoupler isolation	
Rated input voltage	12 V DC	24 V DC
Rated input current	Approx. 3 mA	Approx. 7 mA
<Output>		
Model	Transistor output	
No. of outputs	32	
Isolation method	Photocoupler isolation	
Rated load voltage	12/24 V DC	
Maximum load current	0.1 A/output	



Used when external input/outputs are added. Connector cables for external devices are not included. External input/output cables (for parallel input/output units) are available as options. Both sink and source types are available.

External input/output cables (for parallel input/output units)

Cable size x No. of cores	AWG#28 x 25P (50 cores)
Total length:	5 or 15 m



This is a dedicated cable for connecting external peripheral devices to parallel input/output unit connectors. One end is matched to the parallel input/output unit and the other end is unterminated. Input/output signals from peripheral devices should be connected via the unterminated end of the cable. One cable supports 16 inputs and 16 outputs. If a parallel input/output unit is installed, 32 inputs and 32 outputs are connected per unit, so two cables must be added.

High-performance teaching box

R56TB

See P.66 for details.

External dimensions	252 (W) x 240 (H) x 114 (D) mm
Weight	Approx. 1.3 kg (body only, excluding cables)
Interface	USB port (1)
Display	6.5-Inch TFT (640 x 480) Color touch-screen, backlit
Display languages	Japanese, English



High-performance teaching box with improved monitor function in addition to the R32TB function.

Parallel input/output interface

<Input>		
Model	DC input	
No. of input	32	
Isolation method	Photocoupler isolation	
Rated input voltage	12 V DC	24 V DC
Rated input current	Approx. 3 mA	Approx. 9 mA
<Output>		
Model	Transistor output	
No. of outputs	32	
Isolation method	Photocoupler isolation	
Rated load voltage	12/24 V DC	
Maximum load current	0.1 A/output	



Installing this option on the controller allows external input/output to be used. Connector cables for external devices are not included. External input/output cables (for parallel input/output interfaces) are available as options. The input/output specifications are the same as for PLC interfaces. Both sink and source types are available.

External input/output cables (for parallel input/output interfaces)

Cable size x No. of cores	AWG#28 x 20P (40 cores)
Total length:	5 or 15 m



This is a dedicated cable for connecting external peripheral devices to parallel input/output interface connectors. One end is matched to the parallel input/output interface and the other end is unterminated. Input/output signals from peripheral devices should be connected via the unterminated end of the cable. One cable supports 16 inputs and 16 outputs. If a parallel input/output interface is installed, 32 inputs and 32 outputs are connected per unit, so two cables must be added.

CC Link Interface

Communication functions	Bit/word data transfer
Station type	Intelligent device station
Support station	Local station (no master station function)
CC-Link-compatible version	Ver.2, allows extended cyclic configuration
No. of isolated stations	Isolation of 1, 2, 3 or 4 stations can be configured



The CC-Link interface option augments CC-Link functionality by allowing cyclic transmission of word data as well as bit data to the robot controller.

EtherNet/IP-compatible network base card

Installation module	AB6314
Transmission specifications	10BASE-T/100BASE-TX
No. of inputs	Max. 2,048
No. of outputs	Max. 2,048



EtherNet/IP communication can be achieved by having the customer install an HMS Anybus-CompactCom module (order code: AB6314) in the network base card (2D-TZ535).

EtherCAT-compatible network base card

Installation module	AB6707
Transmission specification	100Mbps (100BASE-TX)
No. of inputs	Bit device : Max. 256 points Word device: Max. 128 points
No. of outputs	Bit device : Max. 256 points Word device: Max. 128 points



EtherCAT communication can be achieved by having the customer mount an Anybus-CompactCom module (order code: AB6707) on the network base card (2F-DQ535-EC).

Controller protection box

Houses a controller and provides protection against dust and water. (IP54)

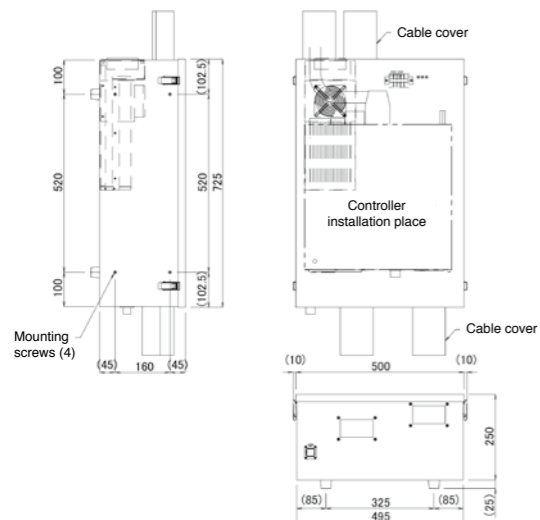

CC-LinkIE Field-compatible network base card

Installation module	AB6709
Transmission specifications	1Gbps (1000BASE-T)
No. of inputs	Max. 2,048
No. of outputs	Max. 2,048



CC-Link IE Field communication can be achieved by having the customer install an HMS Anybus-CompactCom module (order code: AB6709) in the network base card (2F-DQ535).

PROFINET-compatible network base card

Installation module	AB6489-B
Transmission specifications	100BASE-TX
No. of inputs	Max. 2040
No. of outputs	Max. 2040



PROFINET IO communication can be achieved by having the customer install an HMS Anybus-CompactCom module (order code: AB6489-B) in the network base card (2D-TZ535-PN).

Safety option



Allows people to approach and enter the work area without stopping the robot.

Safety expansion unit	Input signal	8 systems (duplicated)
	Output signal	4 systems (duplicated)
	External dimensions	115 x 168 x 100mm
	Applicable robot controller	CR800-R/Q/D

R56TB

Model R56TB

TFT color LED display provides colorful displays for greater ease of operations.

The new R56TB teaching box delivers enhanced robot operations. Outfitted with monitoring functions on par with PC support software, it has become even easier to use to edit programs, set parameters, and display I/O status. The touch panel GUI allows easy programming and monitoring, and switches arranged around the panel ensure efficient robot operations. The teaching box is also equipped with a USB memory interface for backing up controller data without the use of a PC.

R56TB is... An upgraded teaching box model to R32TB. In addition to "training" the robot, its LCD display and monitoring functions can be effectively used for debugging tasks.



Specifications/Functions

Item	Specification
External dimensions	252mm (W) x 240mm (H) x 114mm (D)
Body color	Dark gray
Weight	1.3kg (main unit only, excluding cable)
Connection method	Connection with controller using a dedicated connector
Interface	1 USB port
Display	6.5" TFT color LCD display; 4 status indicator LEDs
Operation panel	Touch panel, emergency stop button, enabling switch (3 positions), TB button, wheel, 30 operation keys
Display languages	Japanese, English

Features

Improved display performance



Menu display

- Adopts a VGA (640x480) full-color touch panel for user-friendly screen layouts.
- Visual menu screens ensure easy operations.

Functions on par with PC software



Program screens

- Program editing screens use a large layout (6.5") to display programs in an easy-to-understand fashion.
- Programs can be written and parameter names entered easily using the keyboard screen.
- Text can also be entered using a stylus pen.



Monitoring screens

- Program debugging time can be shortened via screen operations, such as the I/O monitor screen, which was not available with R32TB.

USB connection interface

By connecting USB memory, controller data may be backed up without the need to have a PC on site. Program information, parameter information, system information, and other such data may be backed up, as with a PC.

Enhanced user-friendliness



The teaching box can be held with one gripper by gripping the grip handle, and the enable switch operated with a finger on the same gripper. The other gripper can be used to operate the touch panel and buttons. The right and left grippers may be interchangeable.

User-defined screen functions



Monitor screens may be individually created to suit each user's debugging task. Debugging time is shortened by being able to easily display the screen to monitor.

Operations panel



The robot operations screen provides the same functions as the robot controller panel, and may be used to activate such automated operations as servo on/off, startup, shut-down, reset, and program selection.

Force Sensor Set

Model 4F-FS002H-W200/1000

Assembly/processing tasks are performed in the same manner as a human being, while sensing the force that is applied to the gripper. Tasks requiring subtle adjustment and detection of force can be performed.

Improved production stability

Parts can be inserted/attached without damage, while adjusting for displacement absorptions caused by parts variations and subtle external forces. Work stability is improved by position latching and retry processing at times of work failure. Furthermore, quality can be managed using log data, and the causes of work errors can be analyzed.

Realization of complex assembly and processing tasks

Parts can be inserted/attached without damage, while adjusting for subtle external forces. Action direction and pushing force can be changed by detecting the contact force, and interrupt processing can be performed using trigger conditions that combine position information and force information.

Easy control

Programs can be easily created using dedicated robot language. Based on representative examples of application programs, work programs can be easily created in response to each customer's required task.

Simple operations

The robot can be quickly "taught" accurate positions based on position and force data from the teaching box. Work conditions can be verified and adjusted by viewing the position and force data from the teaching box and the graph waveform on RT ToolBox3.



Product features

Item	Features		
Controller	Force control	Force control: Function for controlling robots while applying a specified force Stiffness control: Function for controlling the stiffness of robot appendages Gain changes: Function for changing control characteristics while the robot is running	
	Force detection	Execution of interrupts: Interrupts can be executed (MO triggers) under trigger conditions combining position and force information. Data latch: Function for acquiring force sensor and robot positions while contact made Data reference: Function for display force sensor data and maintaining maximum values	
		Force log	Synchronous data: Function for acquiring force sensor information synchronized to position information as log data and displaying it in graph form Start/stop trigger: Allows logging start/stop commands to be specified in robot programs FTP transmission: Function for transferring acquired log files to the FTP server
			Teaching box

System Configuration

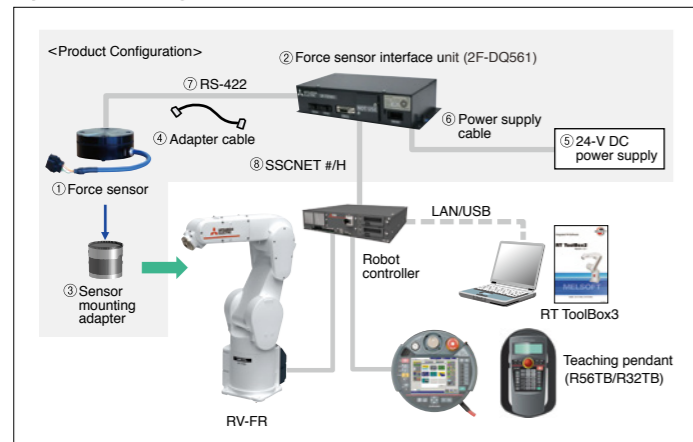

Product Configuration

Name	Qty.	Name	Qty.
① Force sensor	Qty. 1	⑤ 24V DC power supply	Qty. 1
② Force sensor interface unit	Qty. 1	⑥ 24V DC power supply cable	1m
③ Sensor adapter (*1)	Qty. 1	⑦ Serial cable between the unit and sensor	5m
④ Adapter cable	Qty. 1	⑧ SSCNET III cable	10m

*1 Not included in 4F-FS002H-W1000. An adapter needs to be selected from the chart at right and purchased separately in accordance with your robot model.

Force Sensor Specifications

Item	Unit	Specification Value
Rated load	-	4F-FS002H-W200 4F-FS002H-W1000
Max. static load	Fx, Fy, Fz	N 200 1000
	Mx, My, Mz	Nm 4 30
Breaking load	Fx, Fy, Fz	N 0.3
	Mx, My, Mz	Nm 0.03
Consumption current	mA	200
Weight (sensor unit)	g	360 580
External dimensions	mm	ø80×32.5 ø90×40
Protective structure	-	IP30

Force Sense Interface Unit Specifications

Item	Unit	Specification Value
Interface	RS-422	ch 1 (For sensor connection)
	SSCNET #/H	ch 1 (For robot controller and additional axis ampconnection)
Power supply	Input voltage	Vdc 24±5%
	Power consumption	W 25
External dimensions	mm	225(W)×111(D)×48(H)
Weight	kg	Approx. 0.8
Construction	-	IP20 (Panel installation, opentype)

Sensor mounting adapter (for 4F-FS002H-W1000)

Name of product	Model
Sensor mounting adapter (for RV-2/4/7FR)	1F-FSFLGSET-01
Sensor mounting adapter (for RV-13/20FR)	1F-FSFLGSET-02

* 4F-FS002H-W200 comes with a sensor mounting adapter (for RV-2/4/7FR).

MELFA-3D Vision 3.0

Model 3F-53U-WINM

Software for 3D vision sensors for small robots that deliver high-speed and high-accuracy measurements. The unique model-less recognition process allows bulk picking at a high speed.

Compact and lightweight

The compact and lightweight body (camera head: 175×52×50mm, 0.65 kg) can be used for hand-eye and fixed camera configurations. It can also be used in a mist environment due to its improved environmental resistance (IP65/IP67).

Automatic calibration

Equipped with an automatic calibration that automatically aligns the robot and vision sensor. This makes adjustments much easier.

Automatic parameter setting with AI

Mitsubishi's original AI technology and simulation technology automate the sensor parameter adjustment work, which requires expert knowledge. Anyone can easily achieve the same performance as a skilled worker in a short time without needing an actual machine. (Only when model-less recognition is used, compatible models: N35-804-16-IR, N35-806-16-IR, N35-808-16-IR)



MELFA-3D Vision 3.0
(Manufactured by Mitsubishi Electric)

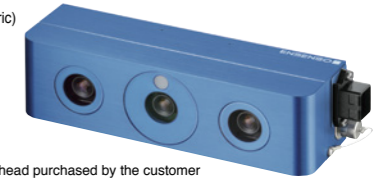

Camera head purchased by the customer
Manufacturer: ENSENSO GmbH.
(Supplier: IDS Imaging Development Systems GmbH.)
For more details, please refer to the IDS website.
<https://en.ids-imaging.com/ensenso-3d-camera-n-series.html>

Product configuration

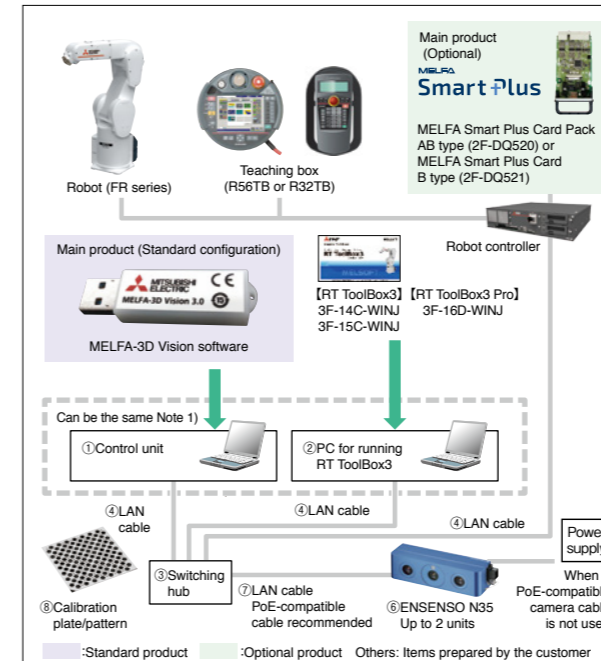

Name	Specifications	Quantity
① PC for running the MELFA-3D Vision 3.0 software	OS: Windows 10 Professional/Enterprise (64bit) CPU: Intel Core i7 (9th generation) RAM: 8 [GB] or more HDD: 100 [GB] or more Gigabit Ethernet port x1	x1
② PC for running the RT ToolBox3	RT ToolBox3 installed (can be used with ①)	x1
③ Switching hub*1	100BASE-T or higher, PoE-compatible	x1
④ LAN cable	Category 5e or higher	x3
⑤ Camera head mounting jig	-	x1
⑥ Camera head*2	ENSENSO N35 series (infrared model) See the table below. Manufacturer: ENSENSO GmbH. Supplier: IDS Imaging Development Systems GmbH.	x1
⑦ LAN cable*3	Category 5e or higher, PoE-compatible Recommended: AD00268 (Supplier: IDS Imaging Development Systems GmbH.)	x1
⑧ Calibration plate/pattern	Compatible with the camera head model selected in ⑥ Supplier: IDS Imaging Development Systems GmbH.	x1

*1) The switching hub must be compatible with Gigabit Ethernet and PoE. If you do not use a PoE-compatible cable, you need to provide a separate camera power cable.
*2) There are also ENSENSO N35 series models other than those shown in the table below. For more details, please check with IDS Imaging Development Systems GmbH.
*3) A PoE-compatible LAN cable is recommended. If you do not use a PoE-compatible cable, you need to provide a separate camera power cable.

Recommended models

Model	N35-804-16-IR	N35-806-16-IR	N35-808-16-IR	N35-1204-16-IR	N35-1604-20-IR
Measurement range*1 [mm]	388×291~860×645	287×215~435×326	231×173~290×217	315×236~431×323	248×186~268×201
Minimum workpiece size (reference)	Model-less: Short side of 1/25 of measurable area – long side of 1/3 of measurable area Model matching: Short side of 1/10 of measurable area – long side of 1/3 of measurable area				
Measurement time	Approx. 0.8 seconds				
Recognition time*2	Model-less: Approx. 0.5 seconds/Model matching: Approx. 1 second				
Work distance*3	480~1000	350~550	280~360	600~850	700~800
Focal length	650	420	310	700	750
External dimensions [mm]	W175×D52×H50				
Weight [kg]	0.65				
Usage environment [deg C]	0~45				
Protection Level	IP65/IP67				

*1) This value is for when using MELFA-3D Vision 3.0. It may differ from the measurement range of the camera head.
*2) This is the standard time from the start of recognition to output. The process may take longer than the standard time depending on the conditions of the surrounding environment, workpieces, and processing parameters.
*3) The distance between the front end of the camera to the measurement point. All areas cannot be used at the same time.

Workpiece distance and measurement range

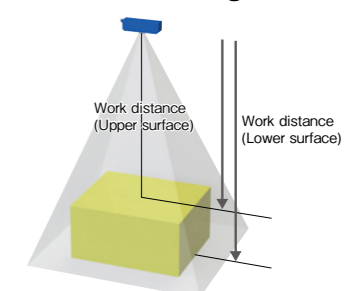

RT ToolBox3

Model 3F-14C-WINE/3F-15C-WINE

Software for program creation and total engineering support.

This is PC software that supports all processes from system startup to debugging and operations, including programming and editing, verification of the scope of operations prior to introducing a robot, estimation of tact time, robot debugging prior to startup, and monitoring of robot conditions and malfunctions during operations.

Windows® compatible

- Easy operations on Windows®
- Compatible with Windows®XP, Windows®Vista, Windows®7, 8, 8.1, 10 (32-bit version 1.8 or later, 64-bit version 2.0 or later)

Simulation functions

- Compatible with all models that connect to the CRn-500 Series, CRn-700 Series, CRn-750 Series, and CRn-800 Series controllers.
- Robot movements and tact times can be calculated using a PC (not available with the mini version).
- Robot movements, operational status, input signals, and servo conditions can be monitored.

Full support, from programming to startup and maintenance

- Programs can be edited using MELFA-BASIC IV, V and VI and (varies depending on the model).
- Robot movements, operational status, input signals, and servo conditions can be monitored.

Enhanced maintenance functions

- Equipped with a maintenance forecast function that notifies users of the robot's greasing time and battery life, and an assistance function for position recovery in the event of trouble, the software is effective for preventive maintenance and for shortening recovery time.
- Data is managed by project, to allow collective backup of the entire system.

Program editing and debugging functions

Programs are created using MELFA-BASIC IV, V and VI.*1 A multi-window format has been adopted for greater work efficiency and enhanced editing. Operations such as program step executions and breakpoint settings can be conveniently verified.

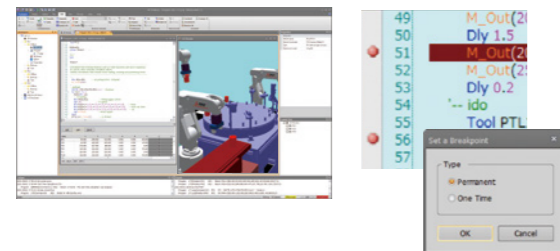

3D viewer

The 3D viewer allows easy verification of robot poses and movements, verification of the limit values of user-defined parameters, and virtual placements of peripheral devices by basic objects. It can also be used to check for interferences between the robot and peripheral devices. Distance measuring functions are also available on the screen.

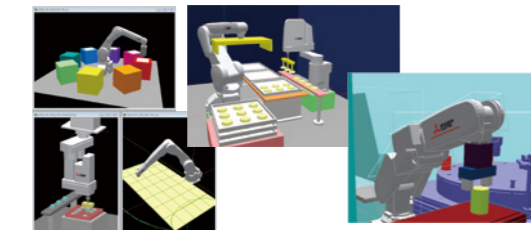

Simulation functions

Programs that have been created can be executed in the PC, movements can be verified, and the tact times of specified parts of a program can be measured. Such simulation functions are also effective for preliminary system examinations. Servo simulations can also be performed, for preliminary examination of loads. Signals can be coordinated with GX works2 and GX works3 for easy creation of line simulators. A maximum of 8 robots can be operated, and coordinated movements among robots can be verified.

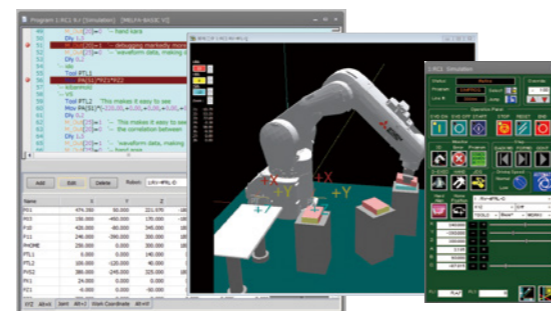

Monitoring functions

Program execution status, variables, I/O signals, etc. can be monitored.



Maintenance functions

Maintenance functions include maintenance forecasts, position recovery support, parameter management, etc.

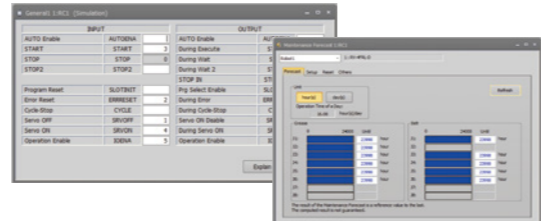

*1: MELFA BASIC is a language that has been developed based on the usability and user-friendliness of the widely-used conventional BASIC language, with the addition of commands needed for robot control. MELFA BASIC IV/V not only offers these additional commands, but also incorporates structuring and parallel processing functions that were difficult to realize with BASIC, for even greater ease of use and detailed control.

Classification	Main functions
Mov Psafe Mov Pget,-50	*Move to evasion point *Move above workpiece
Mvs Pget Dly 0.2 Hclose 1 Dly 0.2 Mvs Pget,-50	*Workpiece extraction position *Wait 0.2 seconds *Close hand *Wait 0.2 seconds *Move above workpiece extraction position
Wait M_In (12)=1 Mov Pput,-80	*Wait for signal *Move above workpiece placement position
Mvs Pput Dly 0.2 Hopen 1	*Workpiece placement position *Wait 0.2 seconds *Open hand
Movements	Joint, linear, and circular interpolation, optimal acceleration/deceleration control, compliance control, collision detection, singular point passage
Input/output	Bit/byte/word signals, interrupt control
Numerical operations	Arithmetic calculation, pose (position), character strings, logic operations
Additional functions	Multi-tasking, tracking, vision sensor functions

*Windows® is registered trademark of Microsoft Corporation in the United States and other countries.

RT ToolBox3 Pro

Model 3F-16D-WINE

A 3D robot simulator that provides powerful support for system designs and preliminary layout examinations.

RT ToolBox3 Pro allows robot simulations to be run on SolidWorks® 3D CAD software.

Programs can be created to match today's era of high-mix, low-volume production, such as for layout considerations prior to introducing robots, desktop program debugging, and generation of complex motion paths.

By linking an add-in tool to SolidWorks® 3D CAD software, robot simulation functions can be added on to SolidWorks® platform.

*1) SolidWorks® is a registered trademark of SolidWorks Corporation (USA).
*2) An add-in tool is a software program that adds certain functions to application software packages.

Features

Automatic robot program creation function

By loading 3D CAD data (*3) of the relevant workpiece to SolidWorks® and setting processing conditions and areas, teaching position data and robot movement programs that are necessary to operate the robot can be generated automatically. Programs can be automatically created even for workpieces with complex shapes that require multiple teaching position data.

*3) Formats that can be loaded into SolidWorks®

- IGES
 - STEP
 - ParasolidR
 - SAT (ACISR)
 - Pro/ENGINEER
 - CGR (CATIAGraphics)
 - Unigraphics
 - PAR (Solid Edge TM)
 - IPT (Autodesk Inventor)
 - DWG
 - DXFTM
 - STL
 - VRML
 - VDA-FS
 - Mechanical Desktop
 - CADKEYR
 - Viewpoint
 - RealityWave
 - HOOPS
 - HCG (Highly compressed graphics)
- Note) See the SolidWorks website and other published information for the latest specifications.

Screen configuration

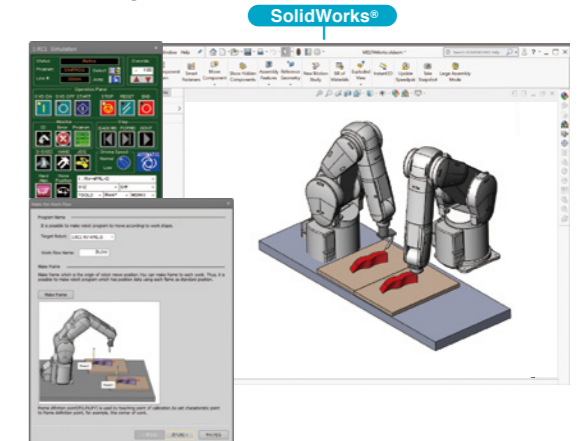

Calibration tool

List of functions

Data loading from peripheral devices and making rearrangements

Data of parts created with SolidWorks® can be loaded into the simulator. The loaded parts can be arranged relative to the CAD origin or other parts. They can also be rearranged by numerical input.

Installation of grippers

Grippers designed and created with SolidWorks® can be installed on selected robots. An Auto Tool Changer (ATC) can also be specified for each gripper.

Handling workpieces

Workpieces can be handled without fail by simulating gripper signal control using a robot program.

CAD links

Work data for performing sealing operations and other such tasks that require many teaching steps can be easily created by selecting the processing area on the 3D CAD data. Since work data is created from 3D CAD data, even complex 3D curves can be generated, and the number of teaching steps can be significantly reduced.

Offline teaching

Robot poses can be "taught" on screen, in advance.

Creation of robot programs (templates)

Workflows can be created by combining offline teaching and CAD links, and converted to robot programs (MELFA BASIC IV, V format).

Specifying robot programs

Robot programs may be used as they are without modifications, and can be specified for each task slot.

Simulation of robot operations

Robot programs, including I/O signals, can be simulated. That is, the operations of the actual system can be reproduced as they are. The I/O signals of a robot controller may be simulated according to two methods: (1) by defining movements associated with I/O signals in a simple manner, or (2) by linking robot programs with GX Simulator2/3.

Displaying robot trajectories

The trajectories of robot operations can be displayed by locus lines in space.

Interference checks

Interferences between the robot and peripheral devices can be checked. Items that are to be subject to an interference check may be specified simply by clicking on it on screen. If an interference is detected, information about the interference (name of the part, the program line that was executed and the position of the robot when the interference occurred, etc.) may be stored in a log file.

Saving videos

Simulated operations can be saved to a video file (AVI format).

Measurement of cycle times

The cycle time of robot operations can be measured in a manner resembling a stopwatch. The cycle time of specified locations of a program can also be measured.

Robot program debugging functions

The following functions are provided for debugging robot programs.

- **Stepped operation:** Specified programs are executed one step at a time.
- **Breakpoint:** Breakpoints can be inserted in a specified program.
- **Direct execution:** Arbitrary robot commands are executed.

Jog function

A robot displayed in SolidWorks® can be jogged, just as a teaching box can jog a robot.

Traveling axis

A travelling axis can be installed in the robot, for examination of the operations of a system equipped with a traveling axis.

Calibration

The point sequence data of CAD coordinates created using CAD links is corrected into robot coordinate data, and the operations program and point sequence data are sent to the robot. In consideration of the frequent need for calibration onsite, the calibration tool is an application separate from SolidWorks®, designed to run efficiently on a laptop PC that does not have SolidWorks® software.

Please contact your local representative or sales office.

Multifunctional Electric Gripper Option

The multifunctional electric gripper option supports customer's various applications with various functions, great lineup, and highly accurate gripping

Highly advanced control impossible with air cylinders

Grip force/speed setting according to the target workpiece	Operation stroke setting according to the shape of the target workpiece	Easily applied to inspection, in addition to workpiece handling
--	---	---

Grip patterns can be set according to the grip target, such as soft workpieces and heavy workpieces, with the torque specification and grip speed setting.

Even when target workpieces are different in size, the optimal stroke can be specified with the operation position specification.

Applications to inspection are possible with feedbacks of the torque or position of the gripper, including whether a workpiece is gripped or not or whether a workpiece is acceptable or not with workpiece dimension measurement.

New applications will be available.

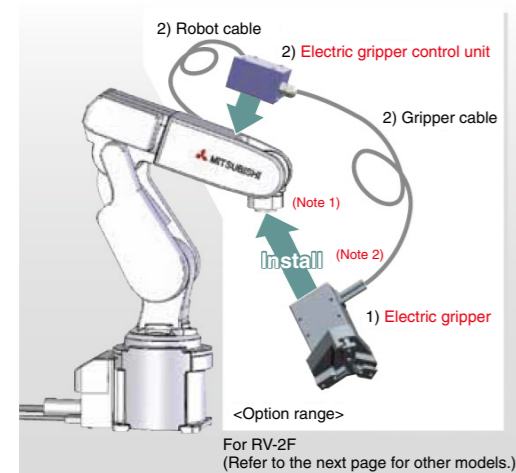

Components

No.	Name	Quantity	Remarks
1)	Electric gripper	1	Select the model by the grip force and stroke.
	Electric gripper control unit	1	Connected to the electric gripper.
2)	grripper cable	1	Connects the electric gripper and control unit.
	Robot cable	1	The cable type differs depending on the robot model.

Specifications of the electric gripper control unit

Item	Specifications	Remarks
External dimensions	60 (W) × 60 (D) × 40 (H)	
Weight	Approx. 200 g	
Input power source	24 V DC ±10%, 1 A (max.)	Powered by the robot controller (Customers need to prepare no power supplies.)
No. of teaching points	32 points	Position data for multiple-point position control

* Only one model of the electric gripper control unit is available for the electric grippers.
 (Note 1) To install the electric gripper to a mechanical interface, fabricate an attachment separately.
 (Note 2) The cable of the electric gripper is not designed to be resistant to bending. Take cautions to prevent any stress from applying to the cable while the robot is operating.

<Electric gripper>

Item	Specifications	Exterior image	
2-claw type (4 models)	Max. grip force	5.0 to 150N	
	Grip force adjustment range	100 to 30% of the max. grip force	
	Stroke	3.2 to 38mm	
	Max. speed	100mm/s(Screw type : 50mm/s)	
	Min. speed	20mm/s	
	Max. grip weight	0.05 to 1.5kg	
	Repetitive stop accuracy	±0.01 to 0.02mm	
2-claw type (1 models)	Max. grip force	2.0N	
	Grip force adjustment range	100 to 30% of the max. grip force	
	Stroke	13mm	
	Max. speed	100mm/s	
	Min. speed	20mm/s	
	Max. grip weight	0.02kg	
	Repetitive stop accuracy	±0.03mm	
Weight	190g		

Type	Model	Stroke(mm)	Grip force(N)	
2-claw type	Single-cam type	4F-MEHGR-01	3.2	1.5 to 5
		4F-MEHGR-02	7.6	1.8 to 6
	Screw type	4F-MEHGR-03	14.3	6.6 to 22
		4F-MEHGR-04	38	45 to 150
3-claw type	4F-MEHGR-05	13	0.6 to 2	

Please contact your local representative or sales office.

Configuration requirement of the multi-function electric gripper

RV-2F series

No.	Name: model	Quantity	Purchased at	Remarks
1	Electric gripper	1	Mitsubishi Electric	Electric gripper used by customers
2	Control unit for the electric gripper: 4F-MEHCU-01	1	Mitsubishi Electric	
3	Electric gripper installation flange	1	Fabricated by customers	Electric gripper used by customers
4	Robot	1	Mitsubishi Electric	Standard specifications
5	Banding band/fixing plate	As required	Fabricated by customers	For fixing a cable

RV-4F/7F/20F series, external wiring specifications

No.	Name: model	Quantity	Purchased at	Remarks
1	Electric gripper	1	Mitsubishi Electric	Electric gripper used by customers
2	Control unit for the electric gripper: 4F-MEHCU-02	1		
3	Adapter cable: 4F-MEHCBCL-01	1		
4	Electric gripper installation flange	1	Fabricated by customers	For fixing the tip of the electric gripper
5	Electric gripper control unit installation stand	1	Fabricated by customers	For wiring from a forearm
Robot				
6	Robot, standard (external wiring) specifications	1	Mitsubishi Electric	Standard specifications External wiring sets (option) need to be connected to each of the forearm part and base part.
7	External wiring unit for the base	1		1F-HA01S-01: When the gripper input signal and Ethernet signal are used together 1F-HA02S-01: When the force sensor signal and Ethernet signal are used together
8	External wiring unit for the forearm	1		1F-HA01S-01: When the gripper input signal and Ethernet signal are used together 1F-HA02S-01: When the force sensor signal and Ethernet signal are used together
9	Wrist wiring internal-wiring specifications: RV-□F-SH02/SH-03	1		Wrist wiring custom specifications SH-02: When the gripper input signal and vision sensor signal are used together SH-03: When the force sensor signal and vision sensor signal are used together

RH-3/6/12/20F series

No.	Name: model	Quantity	Purchased at	Remarks	
1	Electric gripper	1	Mitsubishi Electric	Electric gripper used by customers	
2	Control unit for the electric gripper: 4F-MEHCU-02	1			
Relay cable		1			
3	RH-3FH35/45/5515 & C specifications Z=120 RH-6FH(M)(C)35/45/5520	4F-MEHCBCL-02 (Length: 1300 + 150 mm)			1
	RH-6FH(M)(C)35/45/5534	4F-MEHCBCL-03 (Length: 1600 + 150mm)			1
	RH-12FH(M)(C)55/70/8535 RH-20FH(M)(C)8535	4F-MEHCBCL-04 (Length: 1800 + 150mm)			1
	RH-12FH(M)(C)55/70/8545 RH-20FH(M)(C)10035/45	4F-MEHCBCL-05 (Length: 2100 + 150mm)	1		
4	Banding band, nylon clamp, etc.	1	Fabricated by customers	For fixing a cable	
5	Electric gripper installation flange	1	Fabricated by customers	For fixing the shaft tip of the electric gripper	

RV-4F/7F/13F/20F series, piping internal wiring specifications

Specifications	Possible gripper configuration	Accessory		Remarks
		External wiring set for the forearm	External wiring set for the base	
-SH02	•Electric gripper + gripper input signal •Vision sensor	-	1F-HA01S-01	An external wiring set for the base is enclosed with the internal wiring type robot.
-SH03	•Electric gripper •Vision sensor •Force sensor	-	1F-HA02S-01	

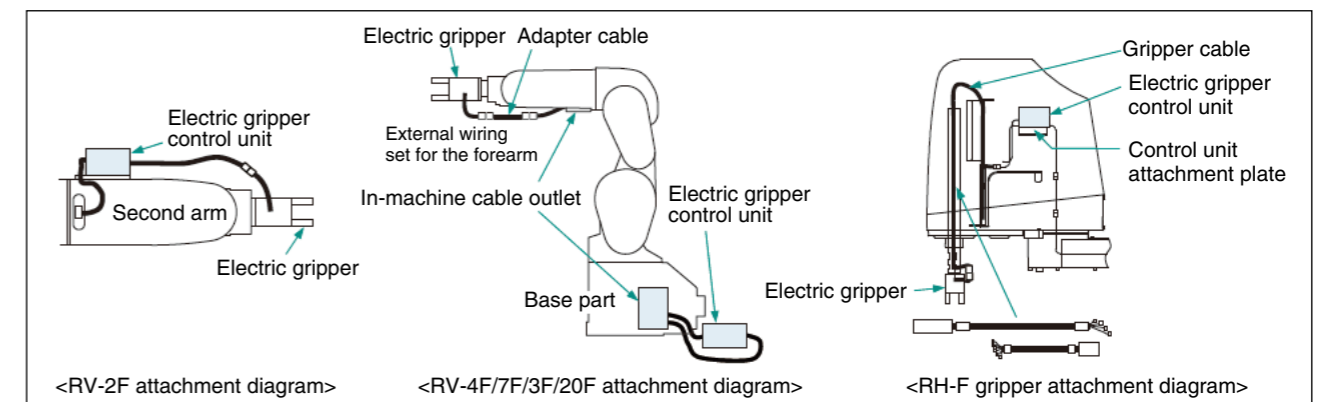

ASLINK (Manufactured by AnyWire: Exclusively for Mitsubishi Electric robots)

The AnyWire ASLINK wiring system can be incorporated in MELFA robots, to resolve gripper wiring problems. By connecting the AnyWire dedicated cable unit to the standard wiring of a conventional robot, all 256 I/O points of the robot gripper can be used without drawing external wiring to the robot arm.

By introducing AnyWire ASLINK...

Before introduction

Issues:

- Limited number of wires in multi-core cable
- Increased size due to relay box
- Increased weight
- Frequent stoppages due to disconnection

After introduction

Improvements:

- Larger number of points with fewer wires
- Elimination of relay box
- Conversion with easy additions and detachments
- Easy assembly using connector branches
- Reduced risk of disconnection with the use of internal cables

MELFA x AnyWire ASLINK wiring/device calibration

No.	Device	Model	Quantity	Supplier	Remarks
①	Forearm external wiring set	1F-HB02S-01	1	Mitsubishi Electric	
②	Base external wiring set	1F-HA02S-01	1	Mitsubishi Electric	
③	AnyWire ASLINK unit	To be selected as required	n	AnyWire	
④	Forearm conversion adapter cable	BL2-RVAS	1	AnyWire	200mm fixed cable
⑤	Base conversion adapter cable	BL2-RVBS	1	AnyWire	200mm fixed cable
⑥	AnyWire ASLINK master unit	QJ51AW12AL	1	Mitsubishi Electric	For Mitsubishi Electric PLCs

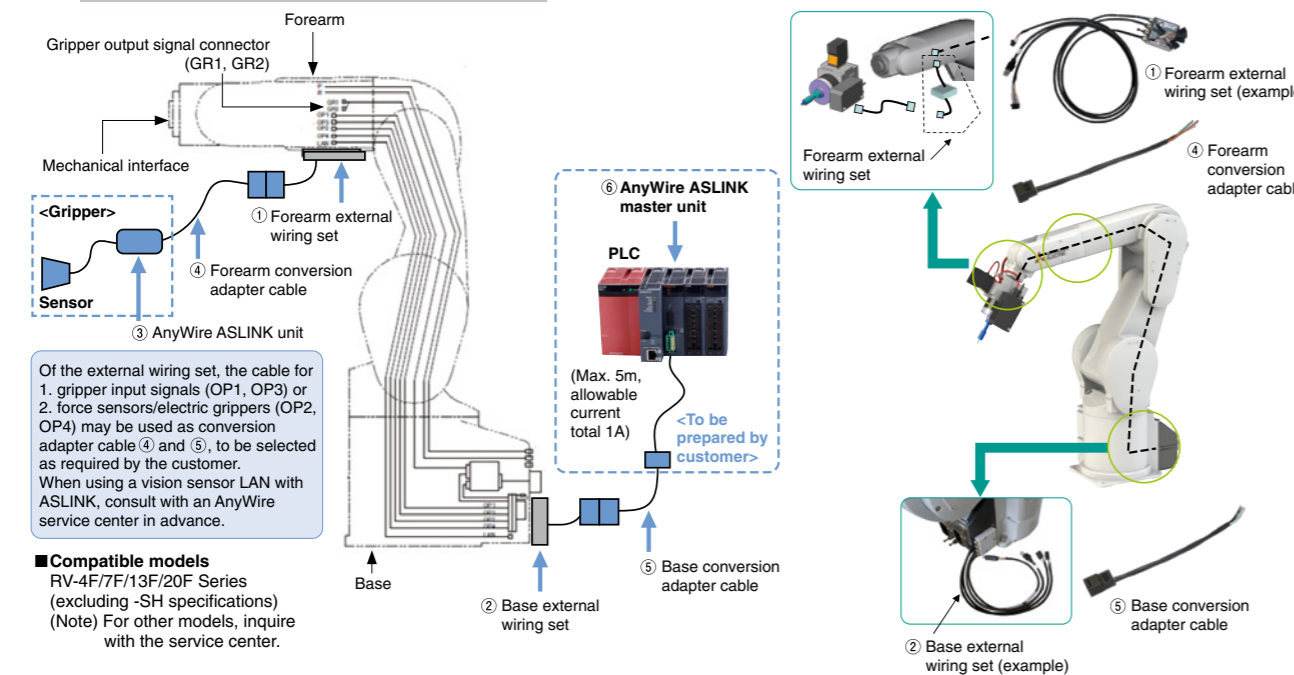

Calculating the Inertia

A tolerable inertia is set in the mechanical interface for robot arm. If a load exceeding this inertia is mounted, the robot may vibrate or an overload alarm may occur when the robot moves. When selecting the robot, it must be considered whether the hand or load to be mounted on the arm is suitable. The method of calculating the load inertia is explained below.

Example 1 Horizontally articulated robot

Calculate the total inertia around the J4 axis.

$$I = I_{z1} + I_{z2} + W_1 L_1^2 + W_2 L_2^2$$

I : Total inertia around the J4 axis
 I_z : Load inertia
 W : Each weight (kg)

For square shape

Load inertia: $I_z = W \cdot \frac{a^2 + b^2}{12}$

For round shape

Load inertia: $I_z = W \cdot \frac{r^2}{2}$

[Example of calculation]

The total inertia around the J4 axis:

$$I = 0.0068 + 0.0012 + 2.5 \times 0.05^2 + 1.5 \times 0.1^2 = 0.030 \text{ kg} \cdot \text{m}^2$$

The RH-6FRH tolerable inertia (rating) is 0.01 kg·m² so 0.030 kg·m² exceeds the tolerable inertia. However, if the hand center of gravity is aligned with the J4 rotary axis, and the workpiece is grasped directly below the J4 axis, both L₁ and L₂ become zero (0), so the total inertia around J4 axis can be determined by the following formula:

$$I = 0.0068 + 0.0012 = 0.008 \text{ kg} \cdot \text{m}^2 < 0.01 \text{ kg} \cdot \text{m}^2$$

This falls within the tolerable inertia. Even if the total inertia is exceeded, consider changing the grasping method or changing the position.

MEMO

YOUR SOLUTION PARTNER



Mitsubishi Electric offers a wide range of automation equipment from PLCs and HMIs to CNC and EDM machines.

A NAME TO TRUST

Since its beginnings in 1870, some 45 companies use the Mitsubishi name, covering a spectrum of finance, commerce and industry.

The Mitsubishi brand name is recognized around the world as a symbol of premium quality.

Mitsubishi Electric Corporation, established in 1921, is active in space development, transportation, semi-conductors, energy systems, communications and information processing, audio visual equipment and home electronics, building and energy management and automation systems, and has 183 factories, laboratories and offices worldwide in over 140 countries.

This is why you can rely on Mitsubishi Electric automation solution - because we know first hand about the need for reliable, efficient, easy-to-use automation and control in our own factories.

As one of the world's leading companies with a global turnover of over 4 trillion Yen (over \$40 billion), employing over 146,000 people, Mitsubishi Electric has the resource and the commitment to deliver the ultimate in service and support as well as the best products.



Low voltage: MCCB, MCB, ACB



Medium voltage: VCB, VCC



Power monitoring, energy management



Compact and Modular Controllers



Inverters, Servos and Motors



Visualization: HMIs



Numerical Control (NC)



Industrial / Collaborative Robots



Processing machines: EDM, Lasers, IDS



Transformers, Air conditioning, Photovoltaic systems

* Not all products are available in all countries.

Global Partner. Local Friend.

American Offices

USA Mitsubishi Electric Automation, Inc. 500 Corporate Woods Parkway, Vernon Hills, IL 60061, USA. Tel: +1-847-478-2100	Brazil Mitsubishi Electric do Brasil Comercio e Servicos Ltda. Rua Jussara, 1750- Bloco B- Sala 01, Jardim Santa Cecilia, CEP 06465-070, Barueri - SP, Brasil Tel: +55-11-4689-3000	Mexico Mitsubishi Electric Automation, Inc. Blvd. Miguel de Cervantes Saavedra 301, Torre Norte Piso 5 Col. Ampliación Granada, Miguel Hidalgo - Ciudad de México, CP 11520, México Tel: +1-847-478-2100
Australia MITSUBISHI ELECTRIC AUSTRALIA PTY. LTD. 348 VICTORIA ROAD, RYDALMERE, NSW. 2116 AUSTRALIA Tel: +61-2-9684-7777		

Asia-Pacific Offices

China Mitsubishi Electric Automation (China) Ltd. No.1386 Hongqiao Road, Mitsubishi Electric Automation Center 3F Shanghai, China Tel: +86-21-2322-3030	Taiwan Mitsubishi Electric Taiwan Co., Ltd. 10F, No.88, Sec.6, Chung-Shan N.Rd., Taipei, Taiwan Tel: +886-02-2833-5430	Korea Mitsubishi Electric Automation Korea Co., Ltd. 7F-9F, Gangseo Hangang Xi-tower A, 401, Yangcheon-ro, Gangseo-Gu, Seoul 157-801, Korea Tel: +82-2-3660-9550
Singapore Mitsubishi Electric Asia Pte. Ltd. 307 Alexandra Road Mitsubishi Electric Building Singapore 159943 Tel: +65-6470-2480	Thailand MITSUBISHI ELECTRIC FACTORY AUTOMATION (THAILAND) CO., LTD. 101 True Digital Park Office, 5th Floor, Sukhumvit Road, Bangchak, Phra Khanong, Bangkok, 10260 TRUE DIGITAL PARK SUKHUMVIT 101 Tel: +662-092-8600	India Mitsubishi Electric India Pvt. Ltd. ICC-Devi Gaurav Technology Park, Unit no. 402, Fourth Floor, Survey no. 191-192 (P), Opp. Vallabh Nagar Bus Depot, Pune - 411018, Maharashtra, India Tel: +91-(20)-46242100

European Offices

Germany Mitsubishi Electric Europe B.V. German Branch Mitsubishi-Electric-Platz 1, 40882 Ratingen, Germany Tel: +49-2102-486-0	UK Mitsubishi Electric Europe B.V. UK Branch Travellers Lane, Hatfield, Hertfordshire, AL10 8XB, U.K. Tel: +44-1707-27-6100	Italy Mitsubishi Electric Europe B.V. Italian Branch VIALE COLLEONI 7-20041 Agrate Brianza (Milano), Italy Tel: +39-039-60531
Spain Mitsubishi Electric Europe B.V. Spanish Branch Carretera de Rubi 76-80-AC.4720, E-08190 Sant Cugat del Valles (Barcelona), Spain Tel: +34-935-65-3131	France Mitsubishi Electric Europe B.V. French Branch 2, rue de l'Union FR-92741 Nanterre Cedex, France Tel: +33-1-41-02-83-00	Czech Republic Mitsubishi Electric Europe B.V. Czech Branch Pekarska 621/7, 155 00 Praha 5, Czech Republic Tel: +420-255 719 200
Poland Mitsubishi Electric Europe B.V. Polish Branch ul. Krakowska 50 32-083 Balice, Poland Tel: +48-12-630-47-00	Ireland Mitsubishi Electric Europe B.V. Irish Branch Westgate Business Park, Ballymount. IRL-Dublin 24 Tel: +353-14198800	Russia Mitsubishi Electric Europe B.V. Russian Branch Moscow Office 52, bld. 3, Kosmodamianskaya nab., RU-115054, Moscow, Russia Tel: +7-495-721-2070
Netherlands Mitsubishi Electric Europe B.V. Netherlands Branch Capronilaan 46 NL-1119 NS Schiphol-Rijk Tel: +31-297-250-350		

Mitsubishi Electric Corporation Nagoya Works
 is a factory certified for ISO 14001
 (standards for environmental management
 systems).

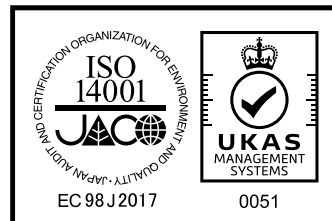

MITSUBISHI ELECTRIC CORPORATION

HEAD OFFICE: TOKYO BLDG., 2-7-3 MARUNOUCHI,
 CHIYODA-KU, TOKYO 100-8310, JAPAN