

Mitsubishi Electric Industrial Robot

CR800-D series controller
CR750-D/CR751-D series controller
CRnD-700 series controller

Network Base Card

Instruction Manual

2D-TZ535

Safety Precautions

Always read the following precautions and the separate "Safety Manual" before starting use of the robot to learn the required measures to be taken.

 **CAUTION** All teaching work must be carried out by an operator who has received special training.
(This also applies to maintenance work with the power source turned ON.)
→Enforcement of safety training

 **CAUTION** For teaching work, prepare a work plan related to the methods and procedures of operating the robot, and to the measures to be taken when an error occurs or when restarting. Carry out work following this plan.
(This also applies to maintenance work with the power source turned ON.)
→Preparation of work plan

 **WARNING** Prepare a device that allows operation to be stopped immediately during teaching work.
(This also applies to maintenance work with the power source turned ON.)
→Setting of emergency stop switch

 **CAUTION** During teaching work, place a sign indicating that teaching work is in progress on the start switch, etc.
(This also applies to maintenance work with the power source turned ON.)
→Indication of teaching work in progress

 **DANGER** Provide a fence or enclosure during operation to prevent contact of the operator and robot.
→Installation of safety fence

 **CAUTION** Establish a set signaling method to the related operators for starting work, and follow this method.
→Signaling of operation start

 **CAUTION** As a principle turn the power OFF during maintenance work. Place a sign indicating that maintenance work is in progress on the start switch, etc.
→Indication of maintenance work in progress

 **CAUTION** Before starting work, inspect the robot, emergency stop switch and other related devices, etc., and confirm that there are no errors.
→Inspection before starting work

The points of the precautions given in the separate "Safety Manual" are given below.
Refer to the actual "Safety Manual" for details.

**DANGER**

When automatic operation of the robot is performed using multiple control devices (GOT, programmable controller, push-button switch), the interlocking of operation rights of the devices, etc. must be designed by the customer.

**CAUTION**

Use the robot within the environment given in the specifications. Failure to do so could lead to faults or a drop of reliability.
(Temperature, humidity, atmosphere, noise environment, etc.)

**CAUTION**

Transport the robot with the designated transportation posture. Transporting the robot in a non-designated posture could lead to personal injuries or faults from dropping.

**CAUTION**

Always use the robot installed on a secure table. Use in an instable posture could lead to positional deviation and vibration.

**CAUTION**

Wire the cable as far away from noise sources as possible. If placed near a noise source, positional deviation or malfunction could occur.

**CAUTION**

Do not apply excessive force on the connector or excessively bend the cable. Failure to observe this could lead to contact defects or wire breakage.

**CAUTION**

Make sure that the workpiece weight, including the hand, does not exceed the rated load or tolerable torque.
Exceeding these values could lead to errors or faults.

**WARNING**

Securely install the hand and tool, and securely grasp the workpiece. Failure to observe this could lead to personal injuries or damage if the object comes off or flies off during operation.

**WARNING**

Securely ground the robot and controller. Failure to observe this could lead to malfunctioning by noise or to electric shock accidents.

**CAUTION**

Indicate the operation state during robot operation. Failure to indicate the state could lead to operators approaching the robot or to incorrect operation.

**WARNING**

When carrying out teaching work in the robot's movement range, always secure the priority right for the robot control. Failure to observe this could lead to personal injuries or damage if the robot is started with external commands.

**CAUTION**

Keep the jog speed as low as possible, and always watch the robot. Failure to do so could lead to interference with the workpiece or peripheral devices.

**CAUTION**

After editing the program, always confirm the operation with step operation before starting automatic operation. Failure to do so could lead to interference with peripheral devices because of programming mistakes, etc.

**CAUTION**

Make sure that if the safety fence entrance door is opened during automatic operation, the door is locked or that the robot will automatically stop. Failure to do so could lead to personal injuries.

**CAUTION**

Never carry out modifications based on personal judgments, non-designated maintenance parts. Failure to observe this could lead to faults or failures.

**WARNING**

When the robot arm has to be moved by hand from an external area, do not place hands or fingers in the openings. Failure to observe this could lead to hands or fingers catching depending on the posture.

**CAUTION**

Do not stop the robot or apply emergency stop by turning the robot controller's main power OFF. If the robot controller main power is turned OFF during automatic operation, the robot accuracy could be adversely affected. Also a dropped or coasted robot arm could collide with peripheral devices.

**CAUTION**

Do not turn OFF the robot controller's main power while rewriting the robot controller's internal information, such as a program and parameter. Turning OFF the robot controller's main power during automatic operation or program/parameter writing could break the internal information of the robot controller.

**DANGER**

Do not connect the Handy GOT when using the GOT direct connection function of this product. Failure to observe this may result in property damage or bodily injury because the Handy GOT can automatically operate the robot regardless of whether the operation rights are enabled or not.

**DANGER**

Do not connect the Handy GOT to a programmable controller when using an iQ Platform compatible product with the CR750-Q/CR751-Q/CR800-R/CR800-Q/CR860-R/CR860-Q controller. Failure to observe this may result in property damage or bodily injury because the Handy GOT can automatically operate the robot regardless of whether the operation rights are enabled or not.

**DANGER**

Do not remove the SSCNET III cable while power is supplied to the multiple CPU system or the servo amplifier when using an iQ Platform compatible product with the CR750-Q/CR751-Q/CR800-R/CR800-Q/CR860-R/CR860-Q controller. Do not look directly at light emitted from the tip of SSCNET III connectors or SSCNET III cables of the Motion CPU or the servo amplifier. Eye discomfort may be felt if exposed to the light.
(Reference: SSCNET III employs a Class 1 or equivalent light source as specified in JIS C 6802 and IEC 60825-1 (domestic standards in Japan).)

**DANGER**

Do not remove the SSCNET III cable while power is supplied to the controller. Do not look directly at light emitted from the tip of SSCNET III connectors or SSCNET III cables. Eye discomfort may be felt if exposed to the light.
(Reference: SSCNET III employs a Class 1 or equivalent light source as specified in JIS C 6802 and IEC60825-1 (domestic standards in Japan).)

**DANGER**

Attach the cap to the SSCNET III connector after disconnecting the SSCNET III cable. If the cap is not attached, dirt or dust may adhere to the connector pins, resulting in deterioration connector properties, and leading to malfunction.

**CAUTION**

Make sure there are no mistakes in the wiring. Connecting differently to the way specified in the manual can result in errors, such as the emergency stop not being released. In order to prevent errors occurring, please be sure to check that all functions (such as the teaching box emergency stop, customer emergency stop, and door switch) are working properly after the wiring setup is completed.

**CAUTION**

Use the network equipments (personal computer, USB hub, LAN hub, etc) confirmed by manufacturer. The thing unsuitable for the FA environment (related with conformity, temperature or noise) exists in the equipments connected to USB. When using network equipment, measures against the noise, such as measures against EMI and the addition of the ferrite core, may be necessary. Please fully confirm the operation by customer. Guarantee and maintenance of the equipment on the market (usual office automation equipment) cannot be performed.

**CAUTION**

To maintain the safety of the robot system against unauthorized access from external devices via the network, take appropriate measures. To maintain the safety against unauthorized access via the Internet, take measures such as installing a firewall.

■ Revision History

Print date	Instruction manual No.	Revision content
2011-09-20	BFP-A8872	First print
2013-08-19	BFP-A8872-A	Addition of PROFINET IO module
2014-07-25	BFP-A8872-B	Addition of amplification
2017-05-31	BFP-A8872-C	Addition of CR800-D series controller
2018-02-01	BFP-A8872-D	Safety Precautions was revised. (The CR800-Q controller was added.)
2023-04-17	BFP-A8872-E	<ul style="list-style-type: none">•The HMS module model was corrected.•Other mistakes were corrected and some sections were changed.
2023-09-14	BFP-A8872-F	<ul style="list-style-type: none">•Added the CR860 controller.•Changed some sections.

■ Introduction

Thank you for purchasing Mitsubishi Electric industrial robot.

This instruction manual explains network base card (2D-TZ535) option.

The network base card is an option which realizes various communication interfaces when the HMS Anybus-CompactCom module is mounted on the card.

The mountable modules are listed in Chapter 2-3 for reference.

Always read this manual thoroughly and understand the contents before starting use of the network base card (2D-TZ535).

The information contained in this document has been written to be accurate as much as possible. Please interpret that items not described in this document "cannot be performed."

Note that this instruction manual has been prepared for use by operators who understand the basic operations and functions of the Mitsubishi industrial robot.

Refer to the separate "Instruction Manual, Detailed Explanation of Functions and Operations" for details on basic operations.

The CR800-D series indicates the CR800-D and CR860-D controllers.

*Symbols in instruction manual



DANGER

Precaution indicating cases where there is a risk of operator fatality or serious injury if handling is mistaken. Always observe these precautions to safely use the robot.



WARNING

Precaution indicating cases where the operator could be subject to fatalities or serious injuries if handling is mistaken. Always observe these precautions to safely use the robot.



CAUTION

Precaution indicating cases where operator could be subject to injury or physical damage could occur if handling is mistaken. Always observe these precautions to safely use the robot.

- No part of this document may be reproduced without express permission of Mitsubishi Electric Corporation.
- Please note that the information in this manual is subject to change without notice in the future.
- The specification values in this manual are obtained with the Mitsubishi standard test method.
- Although this manual has been prepared to contain accurate information, please contact us if you find any errors or have questions.
- Ethernet is registered trademarks or trademarks of Xerox Corporation in the United States.
- The product names used in this manual are trademarks or registered trademarks of respective owners.
- In the body text of this manual, ® and TM marks are omitted.

CONTENTS

1. BEFORE USE	1-1
1.1. Terminology	1-1
1.2. How to Use the Instruction Manual	1-2
2. FLOW OF OPERATIONS	2-3
2.1. Work Procedures	2-3
3. FEATURES OF NETWORK BASE CARD (2D-TZ535)	3-4
3.1. What is a Network Base Card?	3-4
3.2. Mountable Modules	3-4
3.3. Features when Module is Mounted	3-5
3.3.1. Features when EtherNet/IP module is mounted.....	3-5
3.3.2. Features when PROFINET IO 2-Port module is mounted.....	3-6
3.4. Hardware of the 2D-TZ535 Card	3-7
3.4.1. Card overview	3-7
3.4.2. LED	3-7
3.5. Software configuration	3-9
3.5.1. For the EtherNet/IP module	3-9
3.5.2. For the PROFINET IO 2-Port module	3-9
4. ETHERNET/IP MODULE AND 2D-TZ535 CARD SPECIFICATIONS	4-10
4.1. Specifications list	4-10
4.2. List of robot parameters	4-11
4.3. Robot controller I/O signals.....	4-12
4.3.1. I/O signal number map.....	4-12
4.3.2. Flow of I/O signal	4-14
4.3.3. Dedicated Input/Output	4-14
4.3.4. Output signal Reset pattern	4-15
4.3.5. Specifications related to Robot language.....	4-16
5. PROFINET IO 2-PORT MODULE AND 2D-TZ535 CARD SPECIFICATIONS	5-18
5.1. Specifications list	5-18
5.2. List of robot parameters	5-19
5.3. Robot controller I/O signals.....	5-20
5.3.1. I/O signal number map.....	5-20
5.3.2. Flow of I/O signal	5-20
5.3.3. Dedicated Input/Output	5-20
5.3.4. Output signal Reset pattern	5-21
5.3.5. Specifications related to Robot language.....	5-22
6. ITEMS TO BE CHECKED BEFORE USING THIS PRODUCT	6-24
6.1. Checking the Product.....	6-24
6.2. Devices to be Prepared by the Customer	6-25
6.2.1. For the EtherNet/IP module	6-25
6.2.2. For the PROFINET IO 2-Port module	6-25
7. HARDWARE SETTINGS	7-26
7.1. Module Mounting Procedures	7-26
7.2. Setting the 2D-TZ535 Card Hardware	7-28
8. CONNECTIONS AND WIRING	8-29
8.1. Mounting 2D-TZ535 Card onto Robot Controller	8-29

8.1.1. CR800-D controller	8-29
8.1.2. CR860-D controller	8-30
8.1.3. CR750-D/CR751-D controller.....	8-31
8.1.4. CR1D-700 controller	8-32
8.1.5. CR2D-700 controller	8-33
8.1.6. CR3D-700 controller	8-34
8.2. Wiring.....	8-35
8.2.1. For the EtherNet/IP module	8-35
8.2.2. For the PROFINET IO 2-Port module	8-38
9. PROCEDURES FOR STARTING OPERATION	9-41
9.1. Setting the Parameters	9-42
9.1.1. For the EtherNet/IP module	9-42
9.1.2. For the PROFINET IO 2-Port module	9-46
9.2. Checking the I/O Signals	9-62
9.2.1. For the EtherNet/IP module	9-62
9.2.2. For the PROFINET IO 2-Port module	9-64
9.3. Execution of robot program.....	9-67
9.3.1. Setting the dedicated input/output.....	9-67
9.3.2. General-purpose input/output.....	9-67
9.3.3. Example of robot program creation (using general-purpose input/output)	9-68
9.3.4. Sample program for input/output confirmation	9-69
10.TROUBLESHOOTING	10-70
10.1. List of Errors.....	10-70
11.APPENDIX	11-72
11.1. Displaying the Option Card Information	11-72
11.1.1. For the EtherNet/IP module	11-73
11.1.2. For the PROFINET IO 2-Port module	11-73
11.2. Pseudo-input Function	11-74

1. Before Use

This chapter describes items to be checked and precautions to be taken before start using the network base card (2D-TZ535).

1.1. Terminology

Table 1-1 Terminology

Term	Explanation
ODVA	Abbreviation of Open DeviceNet Vendor Association. A non-profit organization in the United States established by development vendors to globally promote Common Industrial Protocol (CIP) technology and products incorporating this technology.
CIP	Abbreviation of Common Industrial Protocol, a common protocol used in the OSI application layer for industrial purposes. This protocol is common for EtherNet/IP which handles information-related information, DeviceNet which handles device-related information, and CompoNet which controls sensors and actuators.
EtherNet/IP	An industrial network standard using commercially-available Ethernet communication chips and physical media. "IP" is the abbreviation for Industrial Protocol. An open protocol is used in the application layer.
DeviceNet	A connection method promoted by ODVA. It is used to connect control devices such as personal computers, PLCs, sensors and actuators, and to connect field devices between controllers.
PI	Abbreviation of PROFIBUS & PROFINET International
PROFINET	This is a communication standard for the automation that PI (PROFIBUS & PROFINET International) made. This is provided by International Standard IEC61158 and IEC61784. There are two kinds of PROFINET about PROFINET CBA and PROFINET IO.

1.2. How to Use the Instruction Manual

This manual is organized as follows and describes functions of the 2D-TZ535 card. For information about the functions provided for standard robot controllers and how to operate them, refer to the instruction manual that comes with the robot controller.









Table 1-2 Contents of the instruction manual

Chapter	Title	Description
1	Before Use	Chapter 1 describes how to use this manual (Network Base Card Instruction Manual). Please read here before actually starting to use the 2D-TZ535 card.
2	Flow of Operations	Chapter 2 describes the operations required to configure a network system. Make sure to perform all of the required operations.
3	Features of Network Base Card (2D-TZ535)	Chapter 3 describes the features of the TZ535 card and for mounting the module.
4 5	2D-TZ535 Card and Ethernet/IP Module Specifications	Chapter 4 - 5 describes the specifications of the TZ535 card.
6	Items to Be Checked Before Using This Product	Before purchasing the TZ535 card, check the required devices and the version of the robot controller.
7	Hardware Settings	This product has no hardware settings.
8	Connections and Wiring	Chapter 8 describes how to connect the TZ535 card and the master station using cables.
9	Procedures for Starting Operation	Chapter 9 describes the procedures up to operating the network system with the module mounted.
10	Troubleshooting	Chapter 10 describes how to resolve problems that may occur when using the TZ535 card, such as malfunctions and errors. Please refer to this chapter as needed.
11	Appendix	Chapter 11 describes the methods of displaying the TZ535 card information with RT ToolBox2/RT ToolBox3.

2. Flow of operations

The flowchart below shows the flow of operations necessary for configuring a network base card system. Use it as a reference to perform the required operations without any excess or deficiency.

2.1. Work Procedures

- 1 Determining the Network Specifications See Chapters 3 and 5 of this manual.
With an understanding of the network base card and communication module specifications, determine the interface related to the system signals using the communication module. (For example, assignment of dedicated I/O signals, specification of general-purpose I/O signals).

- 2 Checking Products See Chapter 6 of this manual.
Check the product you have purchased and prepare other products as needed.

- 3 Mounting Module onto Network Base Card See Section 7.1 of this manual.
Mount the communication module onto 2D-TZ535.

- 4 Setting Hardware and Mounting onto Robot Controller See Section 7.2 of this manual.
The 2D-TZ535 hardware has no settings, so mount the 2D-TZ535 onto the robot controller as it is.

- 5 Wiring and Connections See Chapter 8 of this manual.
Wire the 2D-TZ535 card mounted on the robot controller to the master station using an Ethernet cable.

- 6 Setting Master Station Parameters See Chapter 9 of this manual.
Set the IP address with the master station.

- 7 Setting Robot Controller Parameters See Chapter 9 of this manual.
Set the IP address on the robot controller side.

- 8 Creating Robot Programs See Section 9.3 of this manual.
Create a robot program, and run it with automatic operation.

- 9 Troubleshooting See Chapter 10 of this manual.

- 10 Completion of Operations

3. Features of Network Base Card (2D-TZ535)

3.1. What is a Network Base Card?

The network base card is an optional card for the robot controller. By mounting a HMS's Anybus-CompactCom module on the card, various communication interfaces can be realized.

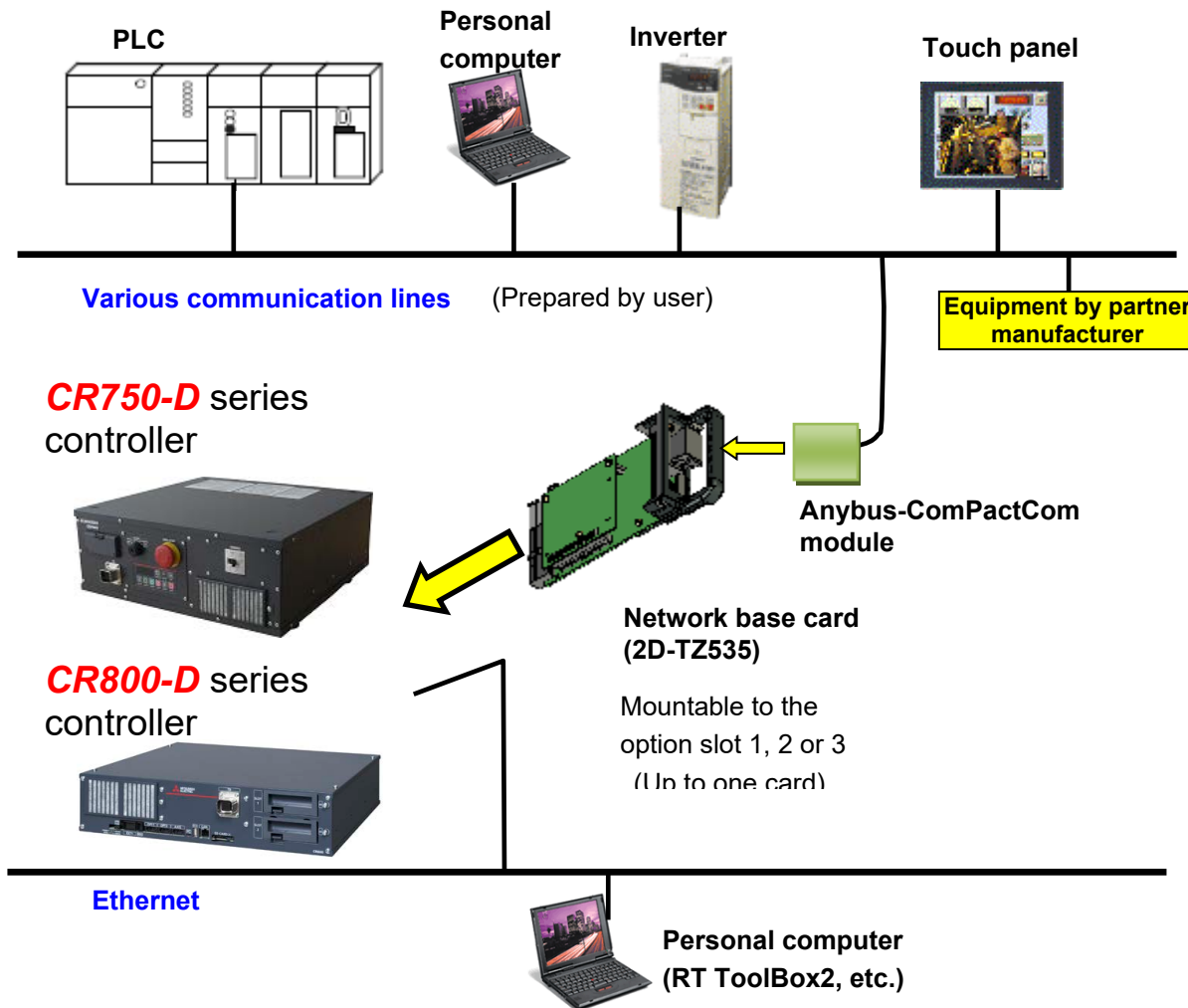

Figure 3-1 Example of configuring EtherNet/IP with network base card

3.2. Mountable Modules

The modules which can be mounted on the network base card (2D-TZ535) are shown below.

Mountable module	EtherNet/IP module (AB6314-B-218)
	PROFINET IO 2-Port module (AB6489-B)
(*) <u>It is different from the model described in the catalog of the HMS Co. because of the model that fixes the version of the firmware.</u>	

3.3. Features when Module is Mounted



3.3.1. Features when EtherNet/IP module is mounted

The following features are enabled when the EtherNet/IP module is mounted on the 2D-TZ535 card.

(1) Connection

Connection to EtherNet/IP network is possible.

EtherNet/IP is one of the three official network standards (DeviceNet, ControlNet, EtherNet/IP), and uses the "Common Industrial Protocol" (CIP) application layer.

Control from a field level and direct connection of automation products in the factory level are enabled by this common application layer, open software, and hardware interfaces.

This is also called "Industrial Ethernet".

(2) Transmission style

10/100Mbps Semi/full duplex transmission supported

(3) Data

Real-time I/O data (max. 2048 points each) transmission/reception is possible using UDP/IP.

(4) The table below shows differences of the functions which are available with the EtherNet/IP module, and with the Ethernet provided with the robot controller as a standard.

No.	Function name	Explanation of function	EtherNet/IP module	Standard Ethernet
1	General-purpose I/O signal	Function which handles up to 2048 I/O signal points each via Ethernet.	●	–
2	TCP/IP communication	Communication with RT2	–	●
3		Data link	–	●
4		Real-time external control	–	●
		Function which controls the robot from a personal computer, etc.		

3.3.2. Features when PROFINET IO 2-Port module is mounted

PROFINET IO

The following features are enabled when the PROFINET IO 2-Port module is mounted on the 2D-TZ535 card.

(1) Connection

Connection to PROFINET network is possible.

PROFINET is a strong network where a real-time communication and the IT communication are achieved at the same time as industrial Ethernet by the communication standard for the automation that PI made.

(2) Transmission style

10/100Mbps Semi/full duplex transmission supported

(3) Data

Real-time I/O data (max. 2040 points each) transmission/reception is possible using UDP/IP.

(4) The table below shows differences of the functions which are available with the PROFINET IO 2-Port module, and with the Ethernet provided with the robot controller as a standard.

No.	Function name		Explanation of function	PROFINET IO 2-Port module	Standard Ethernet
1	General-purpose I/O signal		Function which handles up to 2040 I/O signal points each via Ethernet.	●	–
2	TCP/IP communication	Communication with RT2	Function which communicates with RT ToolBox2/RT ToolBox3 via Ethernet	–	●
3		Data link	Function which communicates with other devices, such as a network vision sensor, via Ethernet	–	●
4		Real-time external control	Function which controls the robot from a personal computer, etc.	–	●

(5) Certification

This product is certificated by PROFIBUS and PROFINET International (PI).

Certification items	Contents
Certificate No	Z10801
Conformance Class	B

3.4. Hardware of the 2D-TZ535 Card

The 2D-TZ535 card hardware is explained in this section. An Anybus-CC module is mounted on the network base card.

3.4.1. Card overview

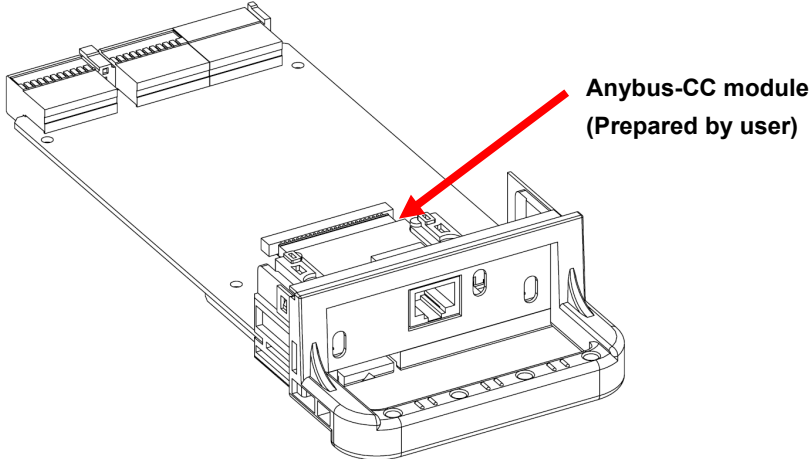

Figure 3-2 Overall view of 2D-TZ535 card

3.4.2. LED

There are three LEDs on the 2D-TZ535 card, and the operating state of the interface card can be confirmed by each on/off.

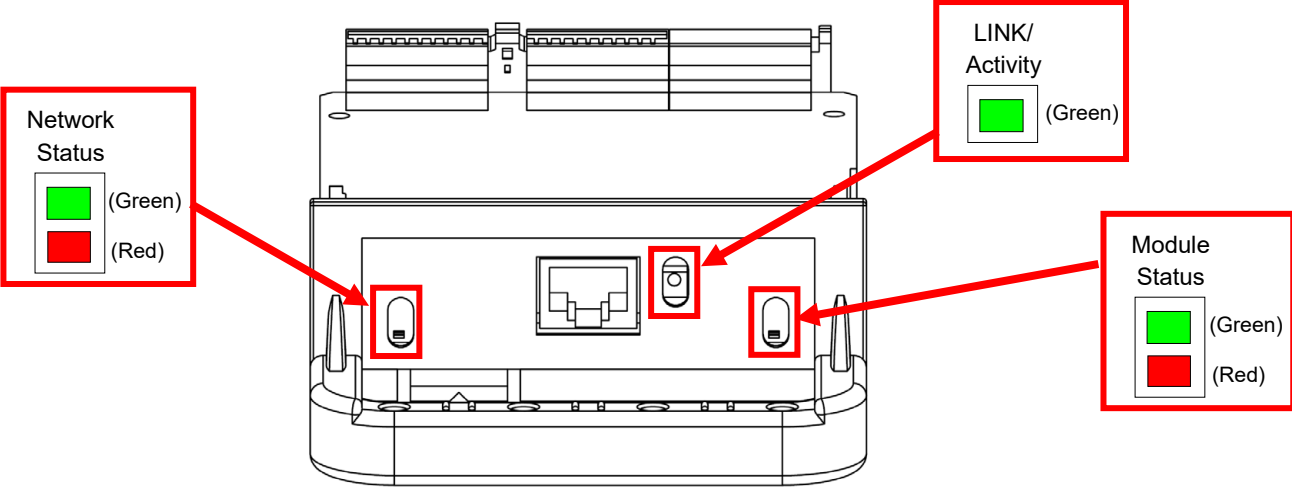

Figure 3-3 Layout of LEDs

The meaning of each LED on, flash and off state is shown below.
Please confirm specifications of the HMS Co. about details.

Table 3-1 Description of LED

Details of Network Status LED

LED status	Details
Off	Power is not ON, or there is no IP address.
Green (on)	Online with one or more connection established (CIP Class 1 or 3).
Green (flash)	Online with no connection established.
Red (on)	IP address duplicate, FATAL error.
Red (flash)	One or more connection has timed out (CIP Class 1 or 3).

Details of Module Status LED

LED status	Details
Off	Power is not ON.
Green (on)	Controlling with RUN state scanner.
Green (flash)	Configuration incomplete, or scanner is idle.
Red (on)	Serious error (EXCEPTION state, FATAL error, etc.).
Red (flash)	Recoverable error.

Details of LINK/Activity LED [Reference]

LED status	Details
Off	Link not established, data not exchanged.
Green (on)	Link established.
Green (flash)	Exchanging data.



CAUTION

It takes some time for the communication line to be established after the robot controller power is turned ON.

It takes about one minute for the communication line to be established (for the Network Status LED to turn on) after the robot controller power is turned ON. If automatic operation is started immediately after turning the power ON, L6130 (network communication error) will occur. Wait for a short time before starting automatic operation.



CAUTION

It takes some time for the communication line to be established after the cable is connected.

It takes about one minute for the communication line to be established (for the Network Status LED to turn on) after the cable is connected to the Anybus-CC module on the TZ535 card.

3.5. Software configuration

3.5.1. For the EtherNet/IP module

The software configuration of this product is shown below.

EtherNet/IP

Table 3-2 Compatible versions for EtherNet/IP

Name		Version
Robot controller		Version S2 and above
Teaching pendant	R32TB/R33TB	1.0 and above
	R56TB/R57TB	1.0 and above
Personal computer support software	RT ToolBox3	1.0 and above
	RT ToolBox2	1.0 and above
	RT ToolBox	Version G3 and above

3.5.2. For the PROFINET IO 2-Port module

The software configuration of this product is shown below.

PROFINET IO

Table 3-3 Compatible versions for PROFINET IO 2-Port

Name		Version
Robot controller		Version S5k and above
Teaching pendant	R32TB/R33TB	1.0 and above
	R56TB/R57TB	1.0 and above
Personal computer support software	RT ToolBox3	1.0 and above
	RT ToolBox2	1.0 and above
	RT ToolBox	Version G3 and above

4. EtherNet/IP module and 2D-TZ535 card specifications



4.1. Specifications list

The specifications which apply when the EtherNet/IP card is mounted on the network base card are shown below.

Table 4-1 2D-TZ535 card specifications

Item		Specification	Remarks
Network base interface card board model		2D-TZ535	
Mountable slot expansion option slot		Slot 1 to 3	CR800-D:Slot 1 - 2 CR75x-D:Slot 1 - 2 CR1D:Slot 1 only CR2D/CR3D:Slot 1 - 3
Number of 2D-TZ535 cards that can be installed at the same time		1 card (*1)	
Coexistence with other fieldbus options (CC-Link/PROFIBUS/DeviceNet)		Not possible (*2)	Parallel I/O interface card (TZ368/TZ378) can coexist.
Transmission specifications	Media access method	CSMA/CD	
	Modulation method	Base band	
	Transmission path style	Star type	
	Transmission speed	100Mbit/s (100BASE-TX) 10Mbit/s (10BASE-TX)	100BASE-TX recommended
	Transmission medium	Twisted pair cable	
	Transmission distance	100m	Distance between switching hub and node
	Number of cascaded modules	No limits when using switching hub	
Communication function	Cyclic communication	Yes	
Communication instance	Input instance	100	
	Output instance	150	
Number of I/O communication points per robot controller	Send	Max. 2048 points	Max. 256 bytes
	Receive	Max. 2048 points	Max. 256 bytes
Start I/O number of robot controller		Address 2000 and later	Overlapping with PROFIBUS area and DeviceNet area
MELFA BASIC	I/O signal access	M_In/M_InB/M_InW/M_In32 M_Out/M_OutB/M_OutW/ M_Out32	Handled as general I/O area
RT ToolBox	Option information read	Yes	

(*1) An error will occur if multiple 2D-TZ535 cards are inserted. (Error 6110)

(*2) An error will occur if CC-Link/PROFIBUS/DeviceNet coexists. (Error 6111)

4.2. List of robot parameters

Table 4-2 List of robot parameters related to EtherNet/IP

Parameter name	Initial value	Setting range	Explanation
STOP2	-1,-1	-1/ 2000 to 4047	Parameter which sets a dedicated input signal number for stopping the robot program. (Parameter "STOP" is fixed to "0", so "STOP2" is used with the 2D-TZ535 card to define a stop signal from an external source.)
ORST2000 ORST2032 : ORST4015	00000000,000 00000, 00000000,000 00000	0/1/*	Set the output transmission data used in the 2D-TZ535 card when resetting the signal output. Refer to " 4.6 Output Signal Reset Pattern " for details.
EPSDLN	8	1 to 256	Set the number of I/O communication transmission bytes used with EtherNet/IP.
EPRDLN	8	1 to 256	Set the number of I/O communication reception bytes used with EtherNet/IP.
EPIP	192.168.0.200	0.0.0.0 to 255.255.255.255	Designate the IP address for EtherNet/IP. (*1)
EPMSK	255.255.255.0	0.0.0.0 to 255.255.255.255	Designate the sub-net mask for EtherNet/IP. (*1)
EPGW	192.168.0.254	0.0.0.0 to 255.255.255.255	Designate the Gateway IP address for EtherNet/IP. (*1)

(*1) Set in the range of Class A to C.

4.3. Robot controller I/O signals

The I/O signals handled in the robot controller are the maximum 2048 points between address 2000 and 4047 for input and output regardless of the EtherNet/IP node or station number.

4.3.1. I/O signal number map

The I/O signal data size is set as a byte number with a parameter for input and for output. (Set in the range of 1 to 256 bytes.)

Table 4-3 EtherNet/IP signal table

Byte number	Usable number of points	Start	End	Byte number	Usable number of points	Start	End	Byte number	Usable number of points	Start	End
0	0	-	to -	43	344	2000	to 2343	86	688	2000	to 2687
1	8	2000	to 2007	44	352	2000	to 2351	87	696	2000	to 2695
2	16	2000	to 2015	45	360	2000	to 2359	88	704	2000	to 2703
3	24	2000	to 2023	46	368	2000	to 2367	89	712	2000	to 2711
4	32	2000	to 2031	47	376	2000	to 2375	90	720	2000	to 2719
5	40	2000	to 2039	48	384	2000	to 2383	91	728	2000	to 2727
6	48	2000	to 2047	49	392	2000	to 2391	92	736	2000	to 2735
7	56	2000	to 2055	50	400	2000	to 2399	93	744	2000	to 2743
8	64	2000	to 2063	51	408	2000	to 2407	94	752	2000	to 2751
9	72	2000	to 2071	52	416	2000	to 2415	95	760	2000	to 2759
10	80	2000	to 2079	53	424	2000	to 2423	96	768	2000	to 2767
11	88	2000	to 2087	54	432	2000	to 2431	97	776	2000	to 2775
12	96	2000	to 2095	55	440	2000	to 2439	98	784	2000	to 2783
13	104	2000	to 2103	56	448	2000	to 2447	99	792	2000	to 2791
14	112	2000	to 2111	57	456	2000	to 2455	100	800	2000	to 2799
15	120	2000	to 2119	58	464	2000	to 2463	101	808	2000	to 2807
16	256	2000	to 2127	59	472	2000	to 2471	102	816	2000	to 2815
17	136	2000	to 2135	60	480	2000	to 2479	103	824	2000	to 2823
18	144	2000	to 2143	61	488	2000	to 2487	104	832	2000	to 2831
19	152	2000	to 2151	62	496	2000	to 2495	105	840	2000	to 2839
20	160	2000	to 2159	63	504	2000	to 2503	106	848	2000	to 2847
21	168	2000	to 2167	64	512	2000	to 2511	107	856	2000	to 2855
22	176	2000	to 2175	65	520	2000	to 2519	108	864	2000	to 2863
23	184	2000	to 2183	66	528	2000	to 2527	109	872	2000	to 2871
24	192	2000	to 2191	67	536	2000	to 2535	110	880	2000	to 2879
25	200	2000	to 2199	68	544	2000	to 2543	111	888	2000	to 2887
26	208	2000	to 2207	69	552	2000	to 2551	112	896	2000	to 2895
27	216	2000	to 2215	70	560	2000	to 2559	113	904	2000	to 2903
28	224	2000	to 2223	71	568	2000	to 2567	114	912	2000	to 2911
29	232	2000	to 2231	72	576	2000	to 2575	115	920	2000	to 2919
30	240	2000	to 2239	73	584	2000	to 2583	116	928	2000	to 2927
31	248	2000	to 2247	74	592	2000	to 2591	117	936	2000	to 2935
32	256	2000	to 2255	75	600	2000	to 2599	118	944	2000	to 2943
33	264	2000	to 2263	76	608	2000	to 2607	119	952	2000	to 2951
34	272	2000	to 2271	77	616	2000	to 2615	120	960	2000	to 2959
35	280	2000	to 2279	78	624	2000	to 2623	121	968	2000	to 2967
36	288	2000	to 2287	79	632	2000	to 2631	122	976	2000	to 2975
37	296	2000	to 2295	80	640	2000	to 2639	123	984	2000	to 2983
38	304	2000	to 2303	81	648	2000	to 2647	124	992	2000	to 2991
39	312	2000	to 2311	82	656	2000	to 2655	125	1000	2000	to 2999
40	320	2000	to 2319	83	664	2000	to 2663	126	1008	2000	to 3007
41	328	2000	to 2327	84	672	2000	to 2671	127	1016	2000	to 3015
42	336	2000	to 2335	85	680	2000	to 2679	128	1024	2000	to 3023

Byte number	Usable number of points	Start	End
129	1032	2000	to 3031
130	1040	2000	to 3039
131	1048	2000	to 3047
132	1056	2000	to 3055
133	1064	2000	to 3063
134	1072	2000	to 3071
135	1080	2000	to 3079
136	1088	2000	to 3087
137	1096	2000	to 3095
138	1104	2000	to 3103
139	1112	2000	to 3111
140	1120	2000	to 3119
141	1128	2000	to 3127
142	1136	2000	to 3135
143	1144	2000	to 3143
144	1152	2000	to 3151
145	1160	2000	to 3159
146	1168	2000	to 3167
147	1176	2000	to 3175
148	1184	2000	to 3183
149	1192	2000	to 3191
150	1200	2000	to 3199
151	1208	2000	to 3207
152	1216	2000	to 3215
153	1224	2000	to 3223
154	1232	2000	to 3231
155	1240	2000	to 3239
156	1248	2000	to 3247
157	1256	2000	to 3255
158	1264	2000	to 3263
159	1272	2000	to 3271
160	1280	2000	to 3279
161	1288	2000	to 3287
162	1296	2000	to 3295
163	1304	2000	to 3303
164	1312	2000	to 3311
165	1320	2000	to 3319
166	1328	2000	to 3327
167	1336	2000	to 3335
168	1344	2000	to 3343
169	1352	2000	to 3351
170	1360	2000	to 3359
171	1368	2000	to 3367

Byte number	Usable number of points	Start	End
172	1376	2000	to 3375
173	1384	2000	to 3383
174	1392	2000	to 3391
175	1400	2000	to 3399
176	1408	2000	to 3407
177	1416	2000	to 3415
178	1424	2000	to 3423
179	1432	2000	to 3431
180	1440	2000	to 3439
181	1448	2000	to 3447
182	1456	2000	to 3455
183	1464	2000	to 3463
184	1472	2000	to 3471
185	1480	2000	to 3479
186	1488	2000	to 3487
187	1496	2000	to 3495
188	1504	2000	to 3503
189	1512	2000	to 3511
190	1520	2000	to 3519
191	1528	2000	to 3527
192	1536	2000	to 3535
193	1544	2000	to 3543
194	1552	2000	to 3551
195	1560	2000	to 3559
196	1568	2000	to 3567
197	1576	2000	to 3575
198	1584	2000	to 3583
199	1592	2000	to 3591
200	1600	2000	to 3599
201	1608	2000	to 3607
202	1616	2000	to 3615
203	1624	2000	to 3623
204	1632	2000	to 3631
205	1640	2000	to 3639
206	1648	2000	to 3647
207	1656	2000	to 3655
208	1664	2000	to 3663
209	1672	2000	to 3671
210	1680	2000	to 3679
211	1688	2000	to 3687
212	1696	2000	to 3695
213	1704	2000	to 3703
214	1712	2000	to 3711

Byte number	Usable number of points	Start	End
215	1720	2000	to 3719
216	1728	2000	to 3727
217	1736	2000	to 3735
218	1744	2000	to 3743
219	1752	2000	to 3751
220	1760	2000	to 3759
221	1768	2000	to 3767
222	1776	2000	to 3775
223	1784	2000	to 3783
224	1792	2000	to 3791
225	1800	2000	to 3799
226	1808	2000	to 3807
227	1816	2000	to 3815
228	1824	2000	to 3823
229	1832	2000	to 3831
230	1840	2000	to 3839
231	1848	2000	to 3847
232	1856	2000	to 3855
233	1864	2000	to 3863
234	1872	2000	to 3871
235	1880	2000	to 3879
236	1888	2000	to 3887
237	1896	2000	to 3895
238	1904	2000	to 3903
239	1912	2000	to 3911
240	1920	2000	to 3919
241	1928	2000	to 3927
242	1936	2000	to 3935
243	1944	2000	to 3943
244	1952	2000	to 3951
245	1960	2000	to 3959
246	1968	2000	to 3967
247	1976	2000	to 3975
248	1984	2000	to 3983
249	1992	2000	to 3991
250	2000	2000	to 3999
251	2008	2000	to 4007
252	2016	2000	to 4015
253	2024	2000	to 4023
254	2032	2000	to 4031
255	2040	2000	to 4039
256	2048	2000	to 4047

4.3.2. Flow of I/O signal

The mapping for the master and slave signals is shown below.

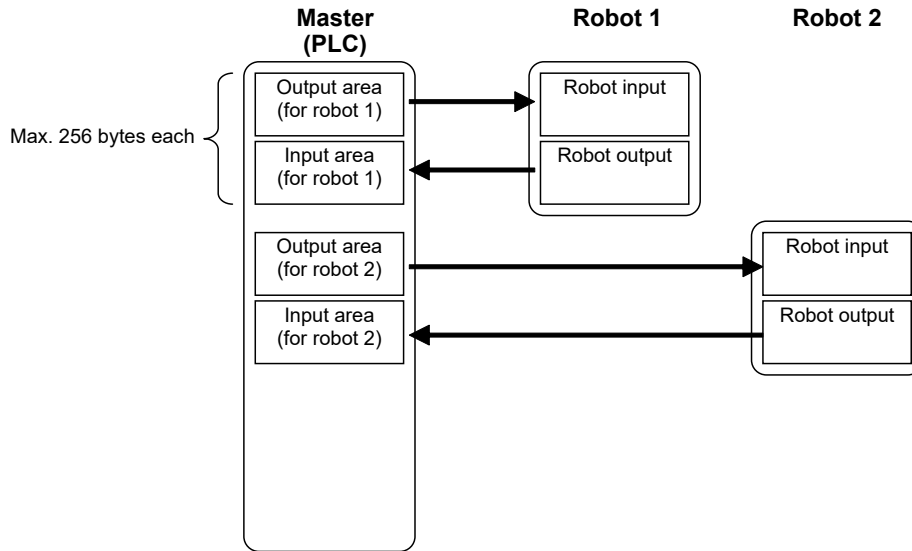

Figure 4-1 Flow of I/O signal

4.3.3. Dedicated Input/Output

Dedicated inputs and outputs can be used by assigning the signal numbers of the 2D-TZ535 card to the dedicated I/O signal parameters. Refer to "6 External Input/Output Functions" in the separate "Instruction Manual, Detailed Explanation of Functions and Operations" for details on using the dedicated inputs and outputs.

4.3.4. Output signal Reset pattern

In the factory setting, all general-purpose output signals start at OFF (0). The status of the general-purpose output signal at power ON can be changed by changing the following parameters. These parameters are also used for the general-purpose output signal reset operation (executed with dedicated input signal, etc.) and for the reset pattern when the "Clr" instruction is executed.

The settings are [OFF], [ON] and [Hold]. A list of general-purpose output reset parameters related to the 2D-TZ535 card is given below.

Table 4-4 List of output signal reset pattern parameters

Parameter name	Start number	End number	Parameter name	Start number	End number
ORST2000	2000	2031	ORST3024	3024	3055
ORST2032	2032	2063	ORST3056	3056	3087
ORST2064	2064	2095	ORST3088	3088	3119
ORST2096	2096	2127	ORST3120	3120	3151
ORST2128	2128	2159	ORST3152	3152	3183
ORST2160	2160	2191	ORST3184	3184	3215
ORST2192	2192	2223	ORST3216	3216	3247
ORST2224	2224	2255	ORST3248	3248	3279
ORST2256	2256	2287	ORST3280	3280	3311
ORST2288	2288	2319	ORST3312	3312	3343
ORST2320	2320	2351	ORST3344	3344	3375
ORST2352	2352	2383	ORST3376	3376	3407
ORST2384	2384	2415	ORST3408	3408	3439
ORST2416	2416	2447	ORST3440	3440	3471
ORST2448	2448	2479	ORST3472	3472	3503
ORST2480	2480	2511	ORST3504	3504	3535
ORST2512	2512	2543	ORST3536	3536	3567
ORST2544	2544	2575	ORST3568	3568	3599
ORST2576	2576	2607	ORST3600	3600	3631
ORST2608	2608	2639	ORST3632	3632	3663
ORST2640	2640	2671	ORST3664	3664	3695
ORST2672	2672	2703	ORST3696	3696	3727
ORST2704	2704	2735	ORST3728	3728	3759
ORST2736	2736	2767	ORST3760	3760	3791
ORST2768	2768	2799	ORST3792	3792	3823
ORST2800	2800	2831	ORST3824	3824	3855
ORST2832	2832	2863	ORST3856	3856	3887
ORST2864	2864	2895	ORST3888	3888	3919
ORST2896	2896	2927	ORST3920	3920	3951
ORST2928	2928	2959	ORST3952	3952	3983
ORST2960	2960	2991	ORST3984	3984	4015
ORST2992	2992	3023	ORST4016	4016	4047

Parameter ORST○○○○ has the initial value "00000000, 00000000, 00000000, 00000000". [OFF], [ON] and [HOLD] can be set for 32 points using "0", "1" and "*". The start number is assigned **from the left side**.

For example, if ORST2000 = "*00000001, 00000000, 11110000, 00000000" is set and the general-purpose output signal is reset, the following state will result:

Output No. 2000: Holds state before output signal reset

Output No. 2007: ON

Output No. 2016 to 2019: ON

4.3.5. Specifications related to Robot language

The robot language (MELFA-BASIC V/VI) used with the 2D-TZ535 card is explained below.

Table 4-5 List of system status variables used for data input/output

Item	Type	Function	Read/Write
M_In	Integer 1	Reads 1 bit of data from designated input signal	Read
M_Out	Integer 1	Writes 1 bit of data to designated output signal	Write
M_Inb	Integer 1	Reads 8 bits of data from designated input signal	Read
M_Outb	Integer 1	Writes 8 bits of data to designated output signal	Write
M_Inw	Integer 1	Reads 16 bits of data from designated input signal	Read
M_Outw	Integer 1	Writes 16 bits of data to designated output signal	Write
M_In32	Integer 1	Reads 32 bits of data from designated input signal	Read
M_Out32	Integer 1	Writes 32 bits of data to designated output signal	Write

◆◆ Inconsistency of input/output data ◆◆

If data read/write is started with the robot program before the master stations finishes data transmission, data inconsistency (state in which robot controller's input/output data is not consistent with master station side's input/output data) will occur. For example, if an application which continuously writes data to the same output address is written, in actual cases only the value written last may be notified to the partner. The following is an example of data inconsistency which occurs if data reading is executed from the robot controller while transmitting data from the master station to the buffer memory.

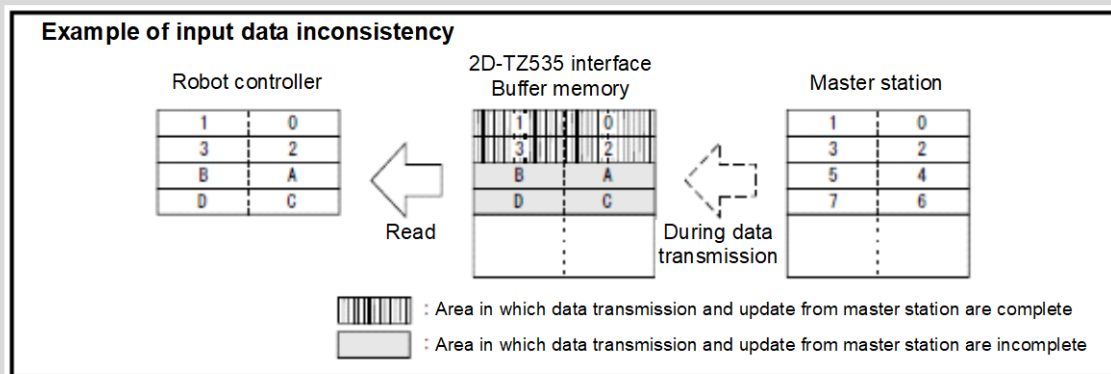

To prevent data inconsistency, the following type of data read/write interlock must be provided in the application (robot program or PLC ladder). An example of using the interlock when sending one-word data from the master station to the robot is given.

Table 4-6 Example of assigning master station and robot I/O signals

Meaning	Master station (*1)	Robot
Data send/receive area	Data send area	Input 2000 to 2015
PLC data write complete flag	WRTFLG	Input No. 2016
Robot data read complete flag	RDFLG	Output No. 2020

(*1) Names are given to the master station I/O signal assignments for convenience. In actual use, refer to the master station instruction manual and make arbitrary assignments of the I/O signals.

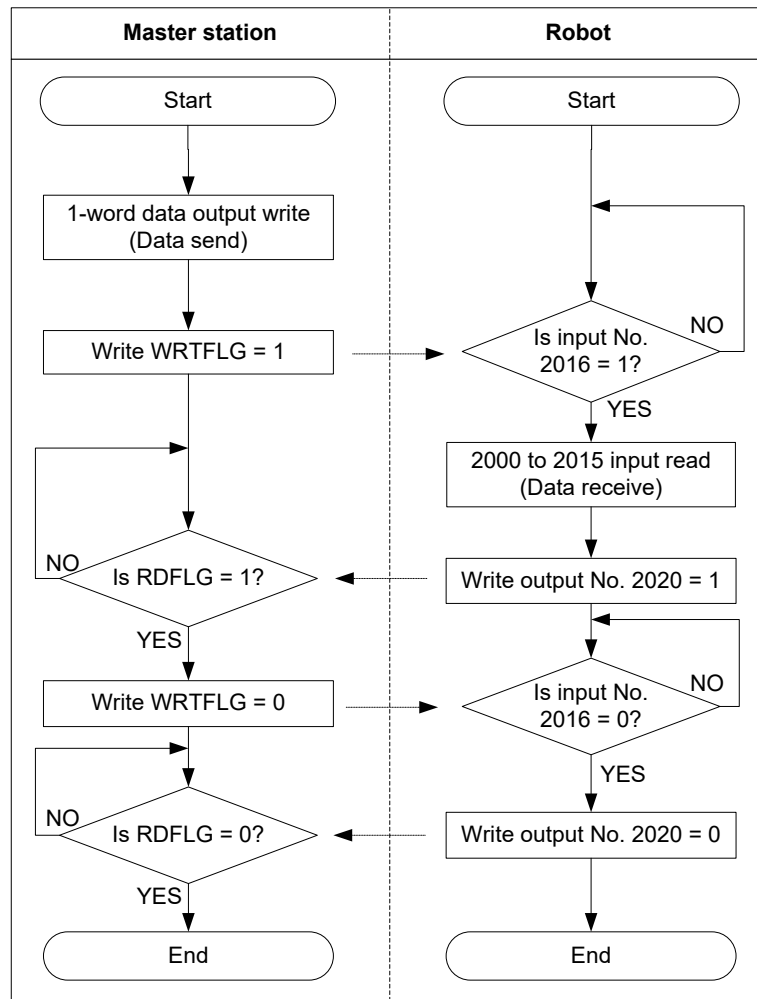

Figure 4-2 Example of using interlock

An example of the robot program corresponding to Figure 4-2 flow chart is given below. Refer to the instruction manual for the device in use for details on the master station side programs (ladder, etc.).

```

*Loop1: If M_In(2016) = 0 Then *Loop1
Mdata = M_InW(2000)
M_Out(2020) = 1
*Loop2: If M_In(2016) = 1 Then *Loop2
M_Out(2016) = 0
  
```

5. PROFINET IO 2-Port module and 2D-TZ535 card specifications

PROFINET IO

5.1. Specifications list

The specifications which apply when the PROFINET IO 2-Port card is mounted on the network base card are shown below.

Table 5-1 2D-TZ535 card specifications

Item		Specification	Remarks
Network base interface card board model		2D-TZ535-PN	
Mountable slot expansion option slot		Slot 1 to 3	CR800-D:Slot 1 - 2 CR75x-D:Slot 1 - 2 CR1D:Slot 1 only CR2D/CR3D:Slot 1 - 3
Number of 2D-TZ535 cards that can be installed at the same time		1 card (*1)	
Coexistence with other fieldbus options (CC-Link/PROFIBUS/DeviceNet)		Not possible (*2)	Parallel I/O interface card (TZ368/TZ378) can coexist.
Transmission specifications	Media access method	CSMA/CD	
	Auto-MDI/MDI-X(*3)	Yes	
	Modulation method	Base band	
	Transmission path style	Star type	
	Transmission speed	100Mbit/s (100BASE-TX)	
	Transmission medium	Twisted pair cable	
	Transmission distance	100m	Distance between switching hub and node
	Number of cascaded modules	No limits when using switching hub	
Communication function	Cyclic communication	Yes	
Number of I/O communication points per robot controller	Send	Max. 2040 points	Max. 255 bytes
	Receive	Max. 2040 points	Max. 255 bytes
Start I/O number of robot controller		Address 2000 and later	Overlapping with PROFIBUS area, DeviceNet area and EtherNet/IP.
MELFA BASIC	I/O signal access	M_In / M_InB / M_InW / M_In8 / M_In16 / M_In32 M_Out / M_OutB / M_OutW / M_Out8 / M_Out16 / M_Out32	Handled as general I/O area
RT ToolBox	Option information read	Yes	

(*1) An error will occur if multiple 2D-TZ535 cards are inserted. (Error 6110)

(*2) An error will occur if CC-Link/PROFIBUS/DeviceNet coexists. (Error 6111)

(*3) A function that identifies straight/cross cable by the automatic operation, and configures the connection appropriately.

5.2. List of robot parameters

Table 5-2 List of robot parameters related to PROFINET IO

Parameter name	Initial value	Setting range	Explanation
STOP2	-1,-1	-1/ 2000 to 4039	Parameter which sets a dedicated input signal number for stopping the robot program. (Parameter "STOP" is fixed to "0", so "STOP2" is used with the 2D-TZ535 card to define a stop signal from an external source.)
ORST2000 ORST2032 : ORST4015	00000000,000 00000, 00000000,000 00000	0/1/*	Set the output transmission data used in the 2D-TZ535 card when resetting the signal output. Refer to " 4.6 Output Signal Reset Pattern " for details.
PNIOLN	16	8 / 16 / 32 / 64 / 128 / 255	Set the number of I/O communication transmission bytes used with PROFINET IO.

5.3. Robot controller I/O signals

The I/O signals handled in the robot controller are the maximum 2040 points between address 2000 and 4039 for input and output regardless of the PROFINET IO station number.

5.3.1. I/O signal number map

The I/O signal data size is set as a byte number with a parameter for input and for output. (Set in the range of 8 / 16 / 32 / 64 / 128 / 255bytes.)

Table 5-3 PROFINET IO signal table

Byte number	Usable number of points	Start	End
8	64	2000 to	2063
16	256	2000 to	2127
32	256	2000 to	2255
64	512	2000 to	2511
128	1024	2000 to	3023
255	2040	2000 to	4039

5.3.2. Flow of I/O signal

The mapping for the master and slave signals is shown below.

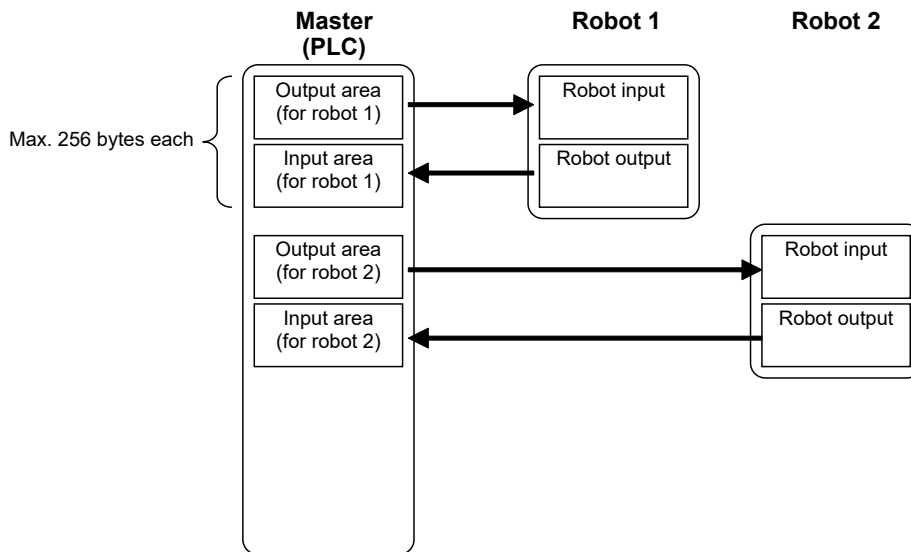

Figure 5-1 Flow of I/O signal

5.3.3. Dedicated Input/Output

Dedicated inputs and outputs can be used by assigning the signal numbers of the 2D-TZ535 card to the dedicated I/O signal parameters. Refer to "6 External Input/Output Functions" in the separate "Instruction Manual, Detailed Explanation of Functions and Operations" for details on using the dedicated inputs and outputs.

5.3.4. Output signal Reset pattern

In the factory setting, all general-purpose output signals start at OFF (0). The status of the general-purpose output signal at power ON can be changed by changing the following parameters. These parameters are also used for the general-purpose output signal reset operation (executed with dedicated input signal, etc.) and for the reset pattern when the "Clr" instruction is executed.

The settings are [OFF], [ON] and [Hold]. A list of general-purpose output reset parameters related to the 2D-TZ535 card is given below.

Table 5-4 List of output signal reset pattern parameters

Parameter name	Start number	End number	Parameter name	Start number	End number
ORST2000	2000	2031	ORST3024	3024	3055
ORST2032	2032	2063	ORST3056	3056	3087
ORST2064	2064	2095	ORST3088	3088	3119
ORST2096	2096	2127	ORST3120	3120	3151
ORST2128	2128	2159	ORST3152	3152	3183
ORST2160	2160	2191	ORST3184	3184	3215
ORST2192	2192	2223	ORST3216	3216	3247
ORST2224	2224	2255	ORST3248	3248	3279
ORST2256	2256	2287	ORST3280	3280	3311
ORST2288	2288	2319	ORST3312	3312	3343
ORST2320	2320	2351	ORST3344	3344	3375
ORST2352	2352	2383	ORST3376	3376	3407
ORST2384	2384	2415	ORST3408	3408	3439
ORST2416	2416	2447	ORST3440	3440	3471
ORST2448	2448	2479	ORST3472	3472	3503
ORST2480	2480	2511	ORST3504	3504	3535
ORST2512	2512	2543	ORST3536	3536	3567
ORST2544	2544	2575	ORST3568	3568	3599
ORST2576	2576	2607	ORST3600	3600	3631
ORST2608	2608	2639	ORST3632	3632	3663
ORST2640	2640	2671	ORST3664	3664	3695
ORST2672	2672	2703	ORST3696	3696	3727
ORST2704	2704	2735	ORST3728	3728	3759
ORST2736	2736	2767	ORST3760	3760	3791
ORST2768	2768	2799	ORST3792	3792	3823
ORST2800	2800	2831	ORST3824	3824	3855
ORST2832	2832	2863	ORST3856	3856	3887
ORST2864	2864	2895	ORST3888	3888	3919
ORST2896	2896	2927	ORST3920	3920	3951
ORST2928	2928	2959	ORST3952	3952	3983
ORST2960	2960	2991	ORST3984	3984	4015
ORST2992	2992	3023	ORST4016	4016	4047

Parameter ORST○○○○ has the initial value "00000000, 00000000, 00000000, 00000000". [OFF], [ON] and [HOLD] can be set for 32 points using "0", "1" and "*". The start number is assigned **from the left side**.

For example, if ORST2000 = "*00000001, 00000000, 11110000, 00000000" is set and the general-purpose output signal is reset, the following state will result:

Output No. 2000: Holds state before output signal reset

Output No. 2007: ON

Output No. 2016 to 2019: ON

5.3.5. Specifications related to Robot language

The robot language (MELFA-BASIC V/VI) used with the 2D-TZ535 card is explained below.

Table 5-5 List of system status variables used for data input/output

Item	Type	Function	Read/Write
M_In	Integer 1	Reads 1 bit of data from designated input signal	Read
M_Out	Integer 1	Writes 1 bit of data to designated output signal	Write
M_Inb	Integer 1	Reads 8 bits of data from designated input signal	Read
M_Outb	Integer 1	Writes 8 bits of data to designated output signal	Write
M_Inw	Integer 1	Reads 16 bits of data from designated input signal	Read
M_Outw	Integer 1	Writes 16 bits of data to designated output signal	Write
M_In32	Integer 1	Reads 32 bits of data from designated input signal	Read
M_Out32	Integer 1	Writes 32 bits of data to designated output signal	Write

◆◆ Inconsistency of input/output data ◆◆

If data read/write is started with the robot program before the master stations finishes data transmission, data inconsistency (state in which robot controller's input/output data is not consistent with master station side's input/output data) will occur. For example, if an application which continuously writes data to the same output address is written, in actual cases only the value written last may be notified to the partner. The following is an example of data inconsistency which occurs if data reading is executed from the robot controller while transmitting data from the master station to the buffer memory.

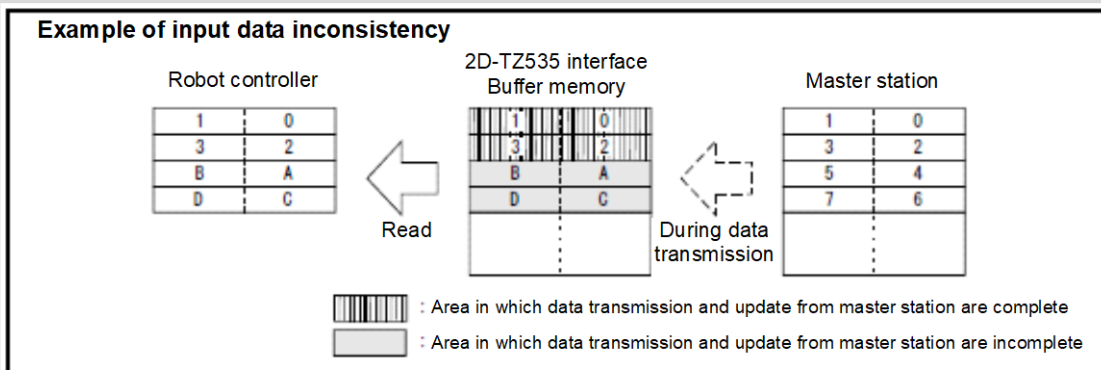

To prevent data inconsistency, the following type of data read/write interlock must be provided in the application (robot program or PLC ladder). An example of using the interlock when sending one-word data from the master station to the robot is given.

Table 5-6 Example of assigning master station and robot I/O signals

Meaning	Master station (*1)	Robot
Data send/receive area	Data send area	Input 2000 to 2015
PLC data write complete flag	WRTFLG	Input No. 2016
Robot data read complete flag	RDFLG	Output No. 2020

(*1) Names are given to the master station I/O signal assignments for convenience. In actual use, refer to the master station instruction manual and make arbitrary assignments of the I/O signals.

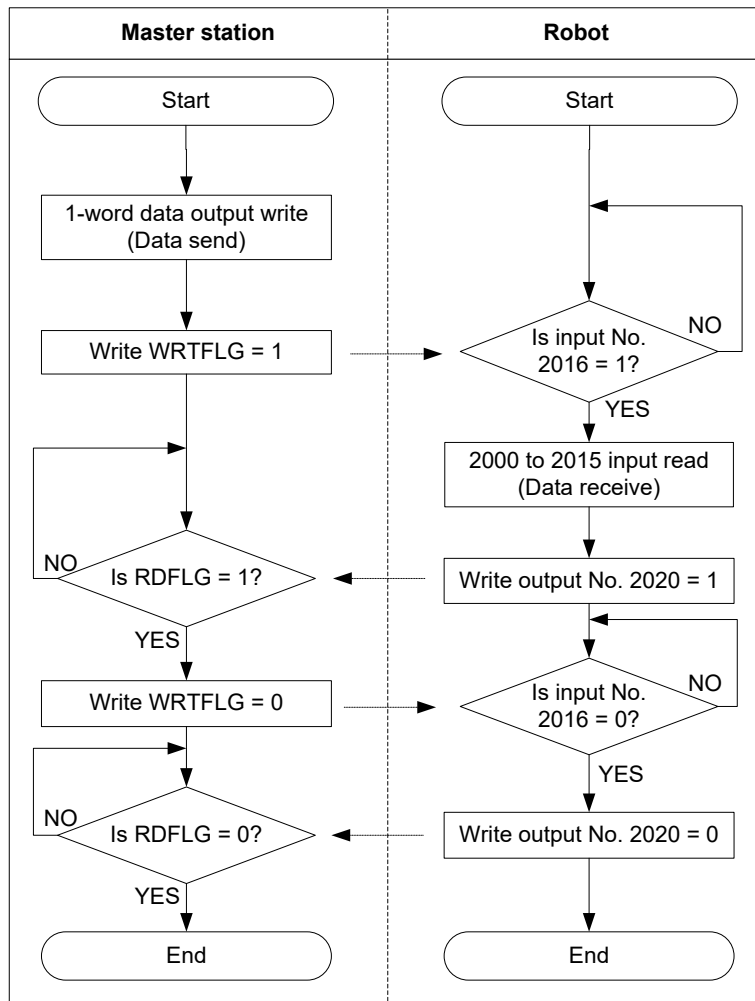

Figure 5-2 Example of using interlock

An example of the robot program corresponding to Figure 5-2 flow chart is given below. Refer to the instruction manual for the device in use for details on the master station side programs (ladder, etc.).

```

*Loop1: If M_In(2016) = 0 Then *Loop1
Mdata = M_InW(2000)
M_Out(2020) = 1
*Loop2: If M_In(2016) = 1 Then *Loop2
M_Out(2016) = 0
    
```

6. Items to Be Checked Before Using This Product

6.1. Checking the Product

The product (2D-TZ535) you purchased consists of the following items as standard. Please verify the items.

Table 6-1 List of the standard items in the product (2D-TZ535)

No.	Name	Model	Quantity
(1)	Instruction Manual (CD-ROM)	BFP-A8873	1
(2)	Network base card (2D-TZ535 card)	TZ535	1
(3)	Module fixing parts (module mount, screws)		1 set

Note) The numbers in the table correspond with the numbers in the following figure.

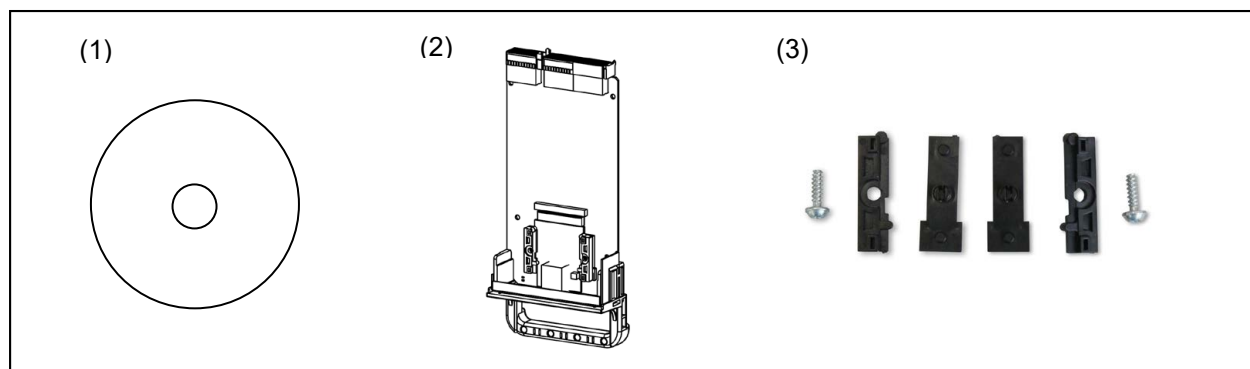

Figure 6-1 Items contained in the delivered product

6.2. Devices to be Prepared by the Customer



6.2.1. For the EtherNet/IP module

The devices which must be prepared by the customer to use the EtherNet/IP module with the Mitsubishi 2D-TZ535 card are listed below.

Table 6-2 List of the standard items in the product (2D-TZ535)

Device to be prepared	Condition
Master station	Master station compatible with EtherNet/IP
EtherNet/IP module	An Anybus-CompactCom module by HMS Anybus-CC EtherNet/IP module (AB6314-B-218)
Ethernet cable	This cable must conform to the specification of EtherNet/IP.
Switching hub	Always use a switching hub when using the I/O signal function. * I/O signal data collisions will increase if a repeater hub is used.
Driver for hex lobular (torques) screw	Driver for module fixing part screws. Prepare a size "T-10" screwdriver.
Cross-point driver	Used for card handle fixing screw.



6.2.2. For the PROFINET IO 2-Port module

The devices which must be prepared by the customer to use the PROFINET IO 2-Port module with the Mitsubishi 2D-TZ535 card are listed below.

Table 6-3 Devices prepared by the customer

Device to be prepared	Condition
Master station	Master station compatible with PROFINET IO
PROFINET IO 2-Port module	An Anybus-CompactCom module by HMS Anybus-CC PROFINET IO 2-Port module (AB6489-B)
Ethernet cable	This cable must conform to the specification of PROFINET IO 2-Port.
Switching hub	Always use a switching hub when using the I/O signal function. * I/O signal data collisions will increase if a repeater hub is used.
Driver for hex lobular (torques) screw	Driver for module fixing part screws. Prepare a size "T-10" screwdriver.
Cross-point driver	Used for card handle fixing screw.

7. Hardware Settings

7.1. Module Mounting Procedures

The example of installing the EtherNet/IP module on the network base card (2D-TZ535) is shown below.

- (1) Prepare the network base card (2D-TZ535), EtherNet/IP module and module fixing parts.
Remove the card handle fixing screws from the network base card (2D-TZ535), and separate the card from the card handle.

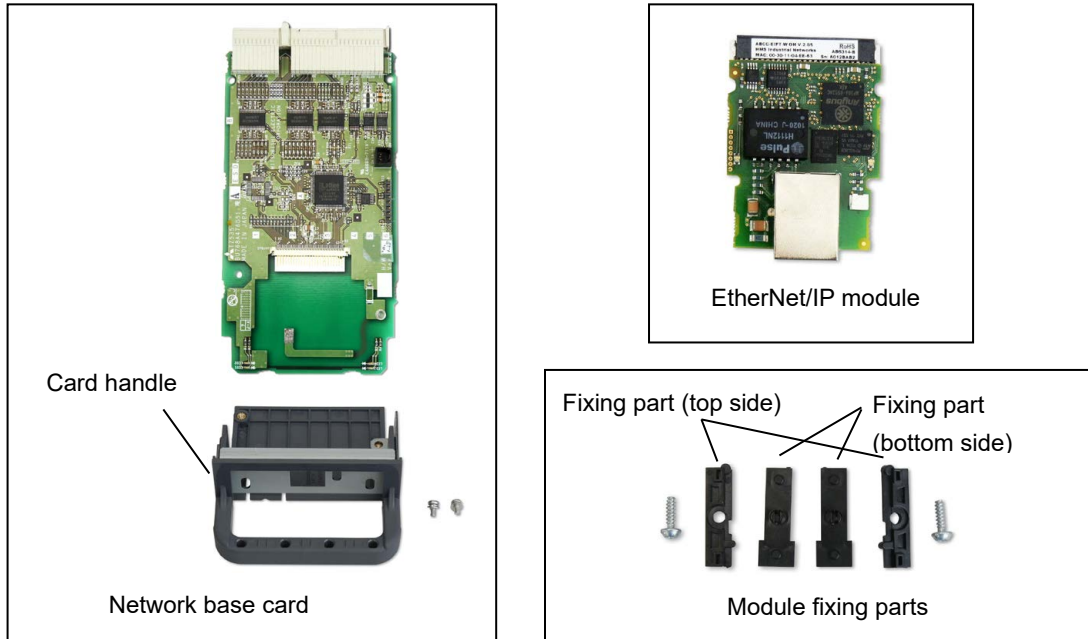

- (2) Insert the protrusions on the module fixing parts (bottom side) into the holes on the card.

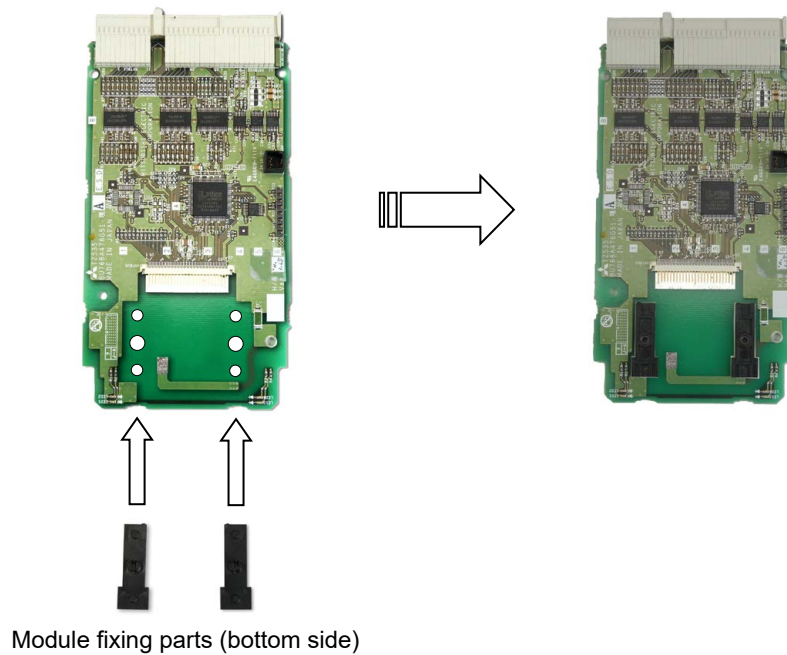

- (3) Place the EtherNet/IP module onto the fixing parts, and slide it to connect its module connector with pins on the card side.

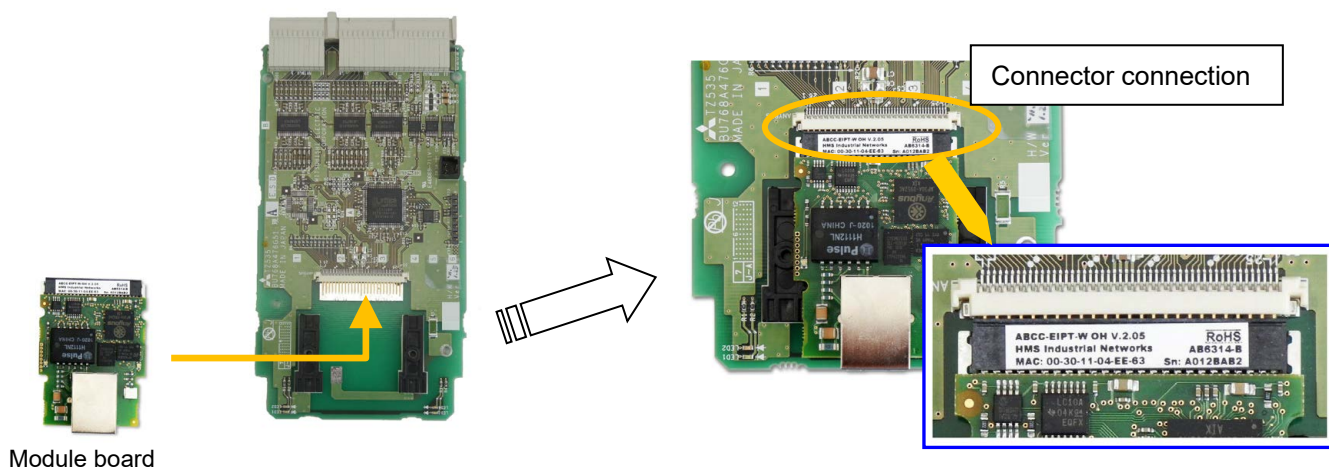

- (4) Align the protrusions on the module fixing parts (top side) with the slits on the module, and mount the module as if sandwiching it from the left, right and top. Adjust the position of the module so that the screw holes on the top fixing parts and bottom fixing parts are aligned. There may be a small opening at the connector section between the module and card, but this is not a problem.

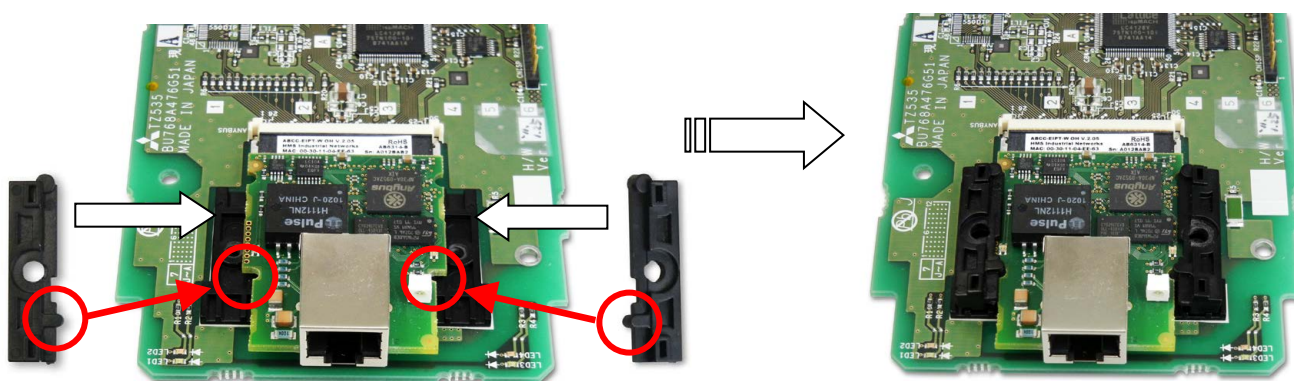

- (5) Fasten the module fixing parts with screws. Use the hex lobular driver.

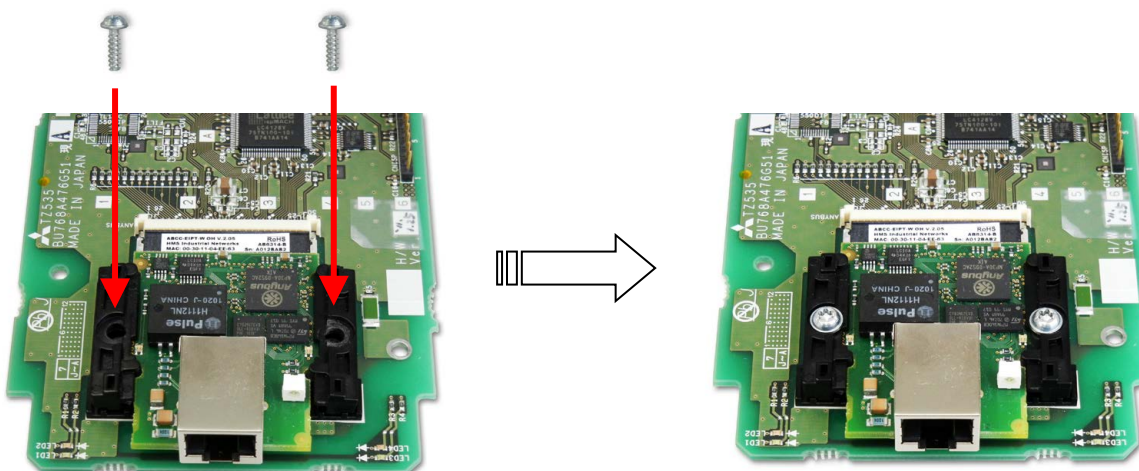

7 Hardware Settings

- (6) Mount the card handle. Fit the handle so that the network connector of the module board fits into the hole on the card handle plate.

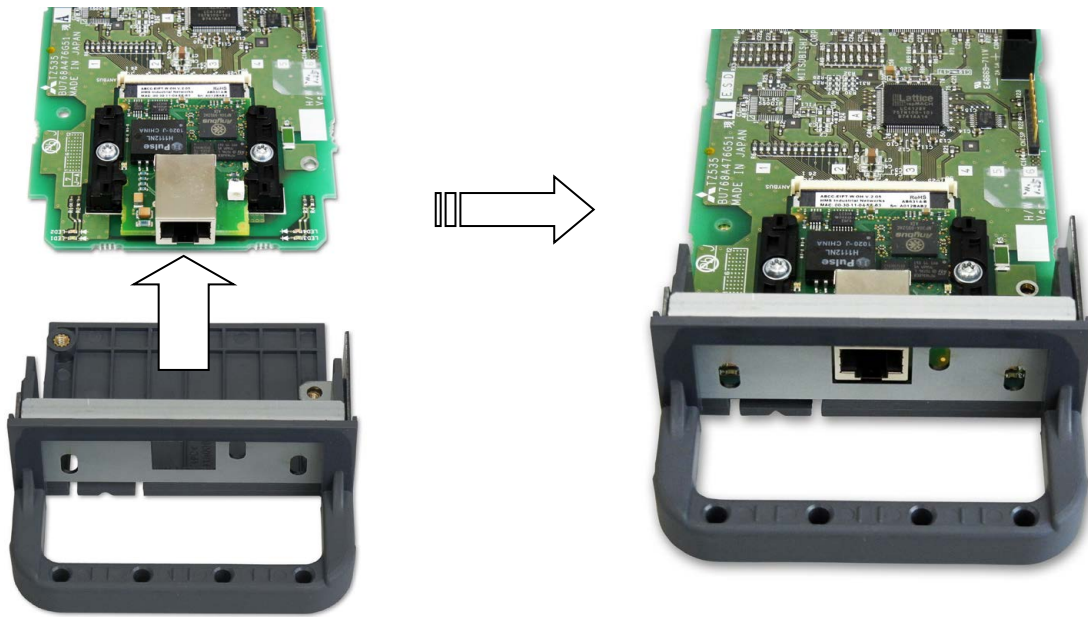

- (7) Fasten the card and card handle with screws. This completes the module mounting process. Tighten the screws with a cross-point driver.

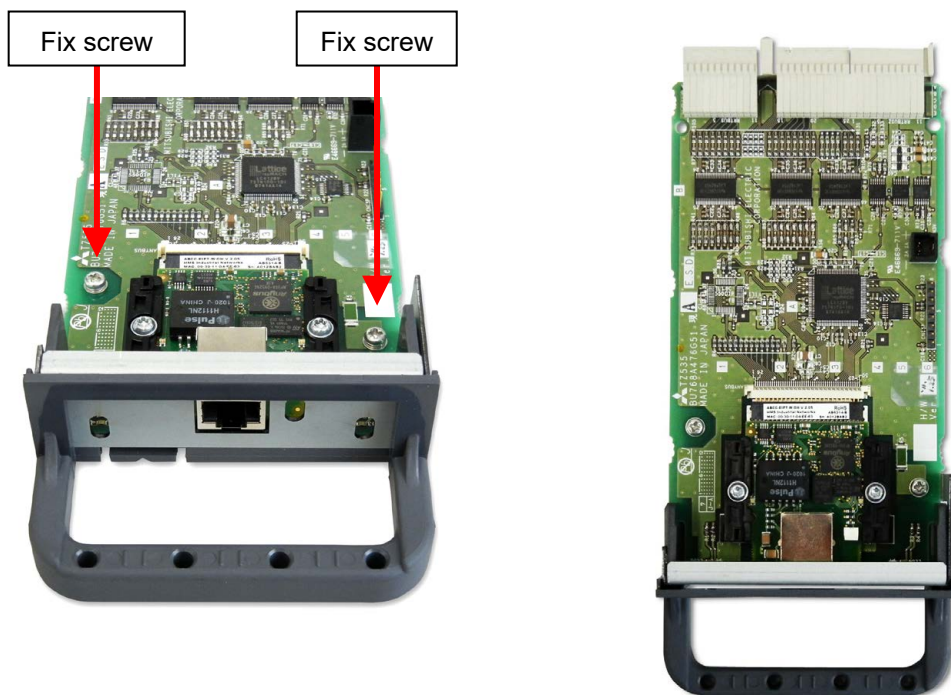

7.2. Setting the 2D-TZ535 Card Hardware

The 2D-TZ535 card does not have any hardware settings.

All settings are completed with the master station parameters and robot controller parameters.

Refer to "9.1 Parameter Settings" for details.

8. Connections and Wiring

8.1. Mounting 2D-TZ535 Card onto Robot Controller

One 2D-TZ535 card can be mounted in **the option slot (*1)** of the robot controller. If two or more cards are mounted, the H.6110 error (multiple network base cards mounted) will occur.

8.1.1. CR800-D controller

Remove one interface cover of the option slots 1-2 in the robot controller front, and mount the 2D-TZ535 card there. Please use the handle of the interface card at mounting of the interface card.

<CR800 controller (Front side)>

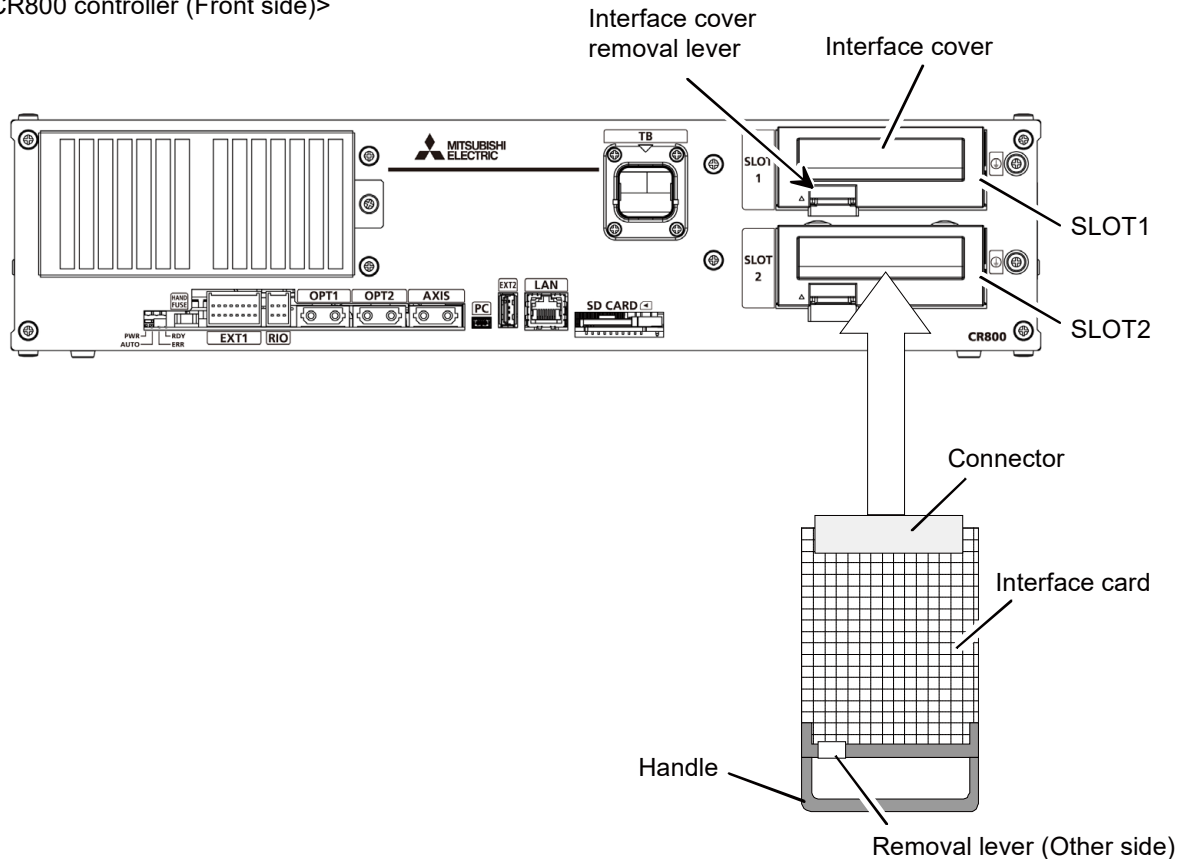

Figure 8-1 Mounting of the 2D-TZ535 card (CR800-D controller)

8.1.2. CR860-D controller

Remove the interface cover of option slot 1 or 2 on the front of the R800CPU module, and mount the 2D-TZ535 card there.
Please use the handle of the interface card at mounting of the interface card.

<CR860-D controller (Front side)>

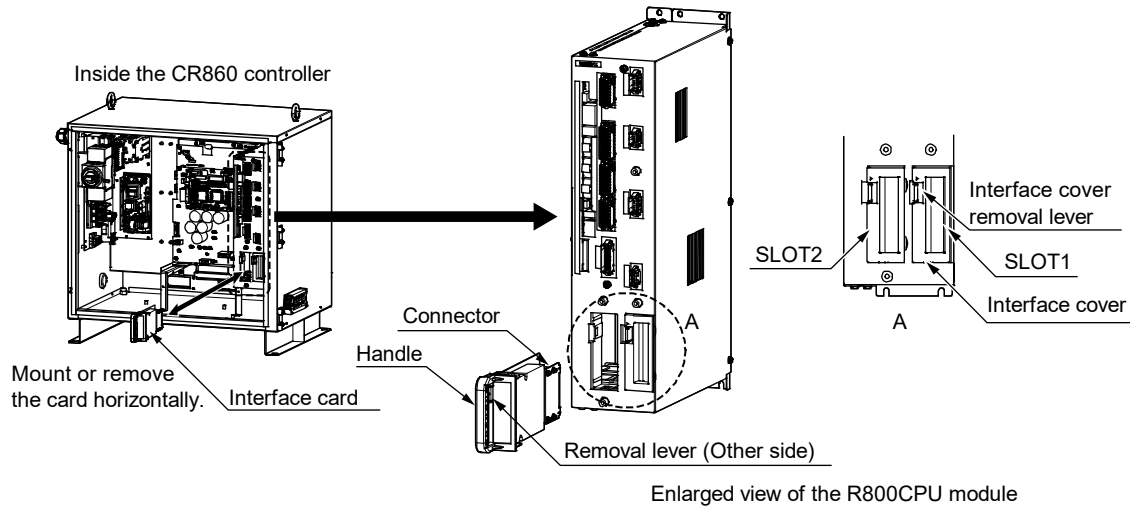
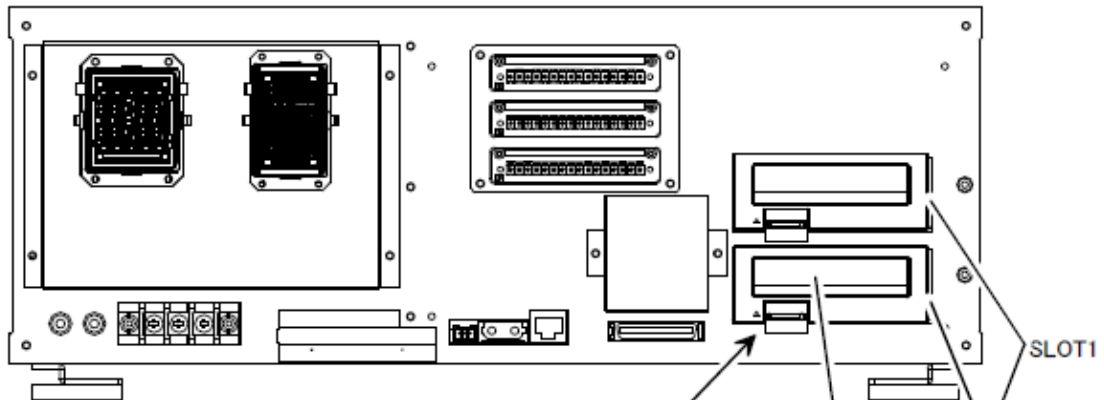

Figure 8-2 Mounting of the 2D-TZ535 card (CR860-D controller)

8.1.3. CR750-D/CR751-D controller

Remove one interface cover of the option slots 1-2 in the robot controller front or rear, and mount the 2D-TZ535 card there. Please use the handle of the interface card at mounting of the interface card.

<CR750 controller (Rear side)>



<CR751 controller (Front side)>

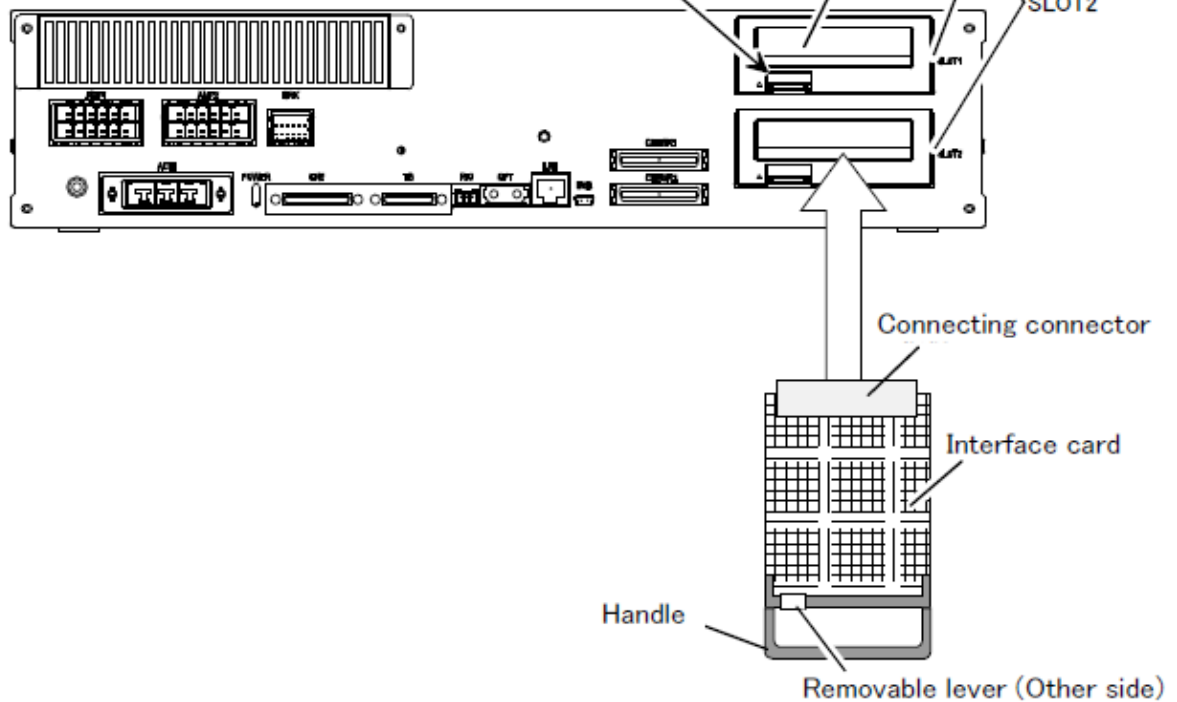

Figure 8-3 Mounting of the 2D-TZ535 card (CR750-D/CR751-D controller)

8.1.4. CR1D-700 controller

Remove one interface cover of the option slots 1 in the robot controller rear, and mount the 2D-TZ535 card there. Please use the handle of the interface card at mounting of the interface card.

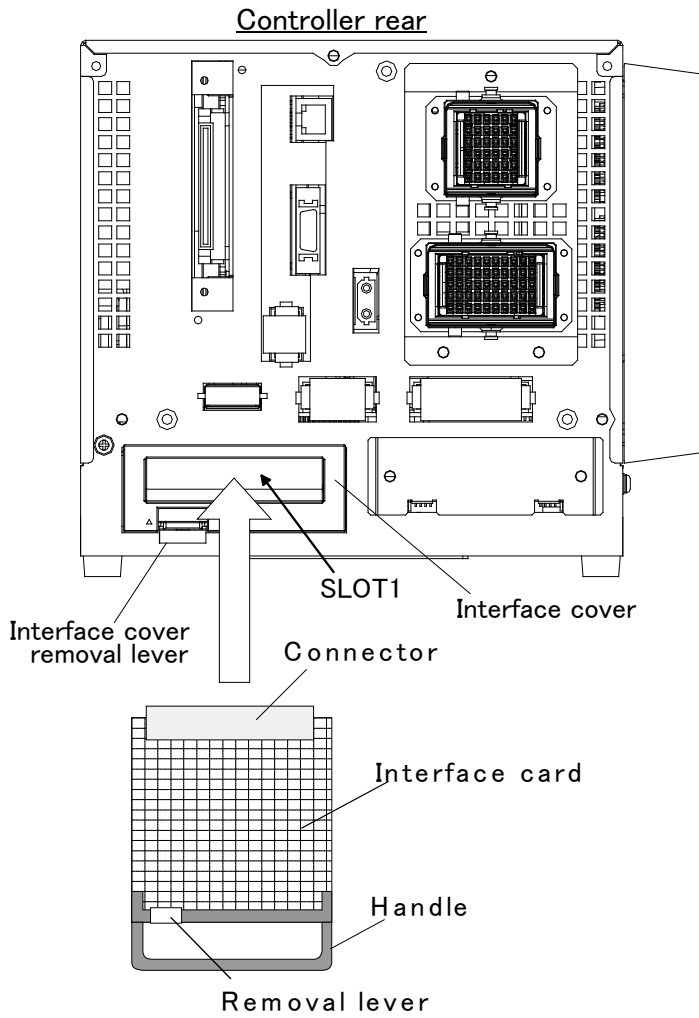

Figure 8-4 Mounting of the 2D-TZ535 card (CR1D controller)

8.1.5. CR2D-700 controller

Remove one interface cover of the option slots 1-3 in the robot controller rear, and mount the 2D-TZ535 card there. Please use the handle of the interface card at mounting of the interface card.

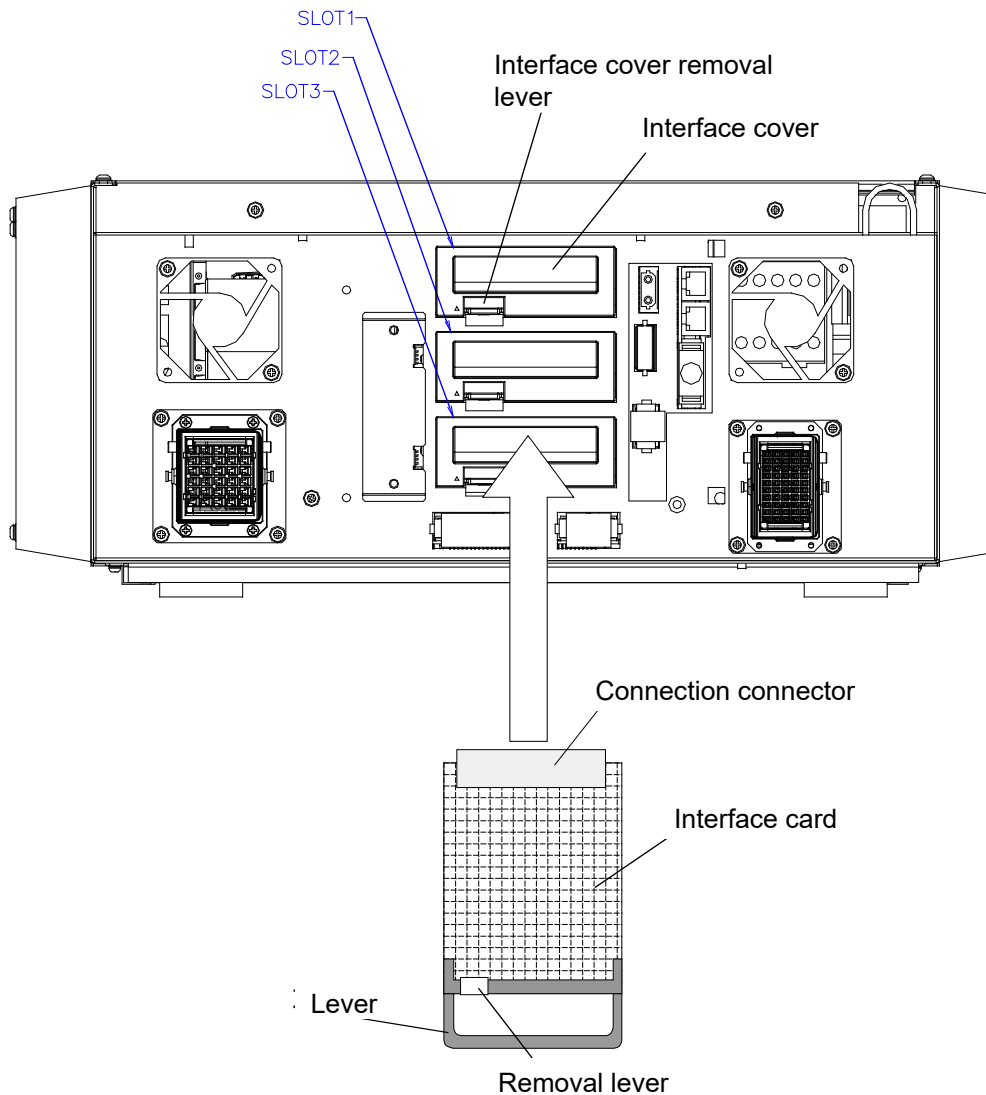

Figure 8-5 Mounting of the 2D-TZ535 card (CR2D controller)

8.1.6. CR3D-700 controller

Open the door of the robot controller.

The R700CPU unit is installed in the right end. Remove one interface cover of the option slots 1-3 in the CPU unit, and mount the 2D-TZ535 card there.

Please use the handle of the interface card at mounting of the interface card.

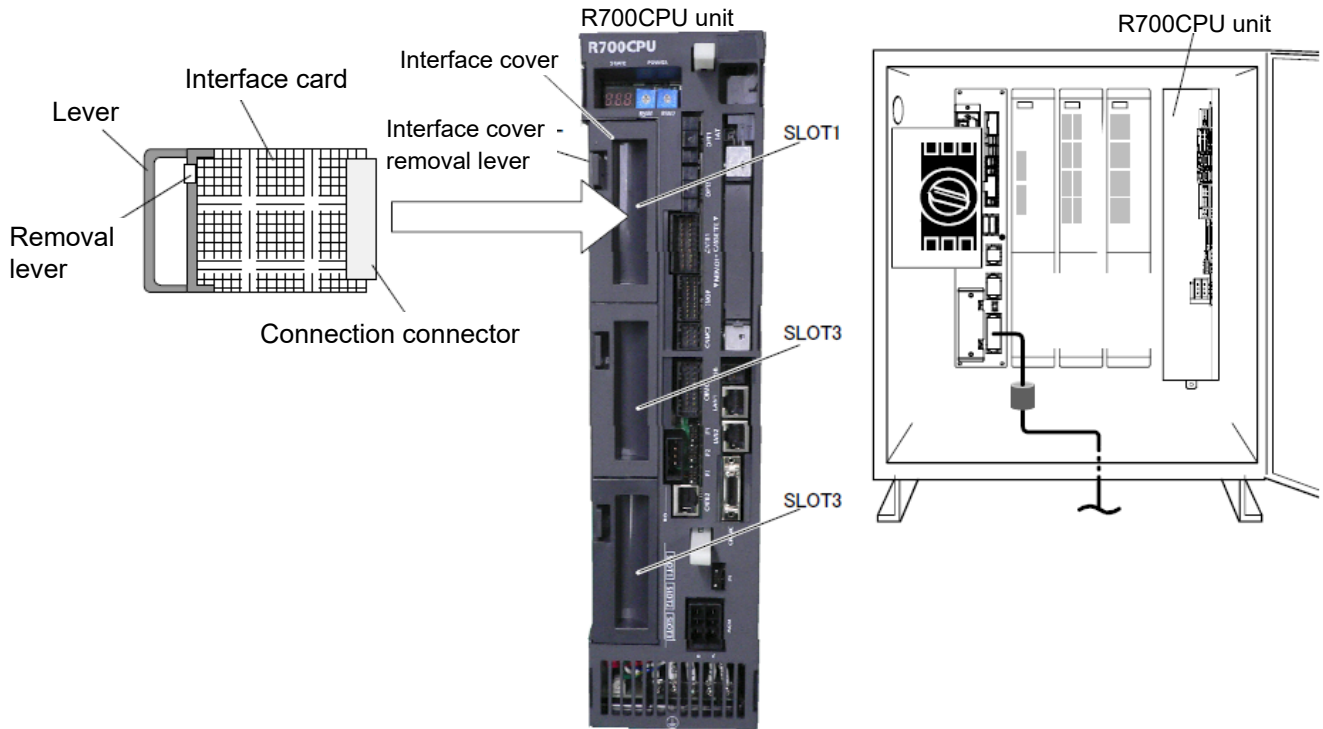

Figure 8-6 Mounting of the 2D-TZ535 card (CR3D controller)

8.2. Wiring

EtherNet/IP

8.2.1. For the EtherNet/IP module

An example of connecting the 2D-TZ535 card and Rockwell PLC (CompactLogix L35E) one-on-one with an Ethernet cable is explained below.

- (1) Connect the Ethernet straight cable connector to the 2D-TZ535 card.
- (2) Connect the other connector to the hub.

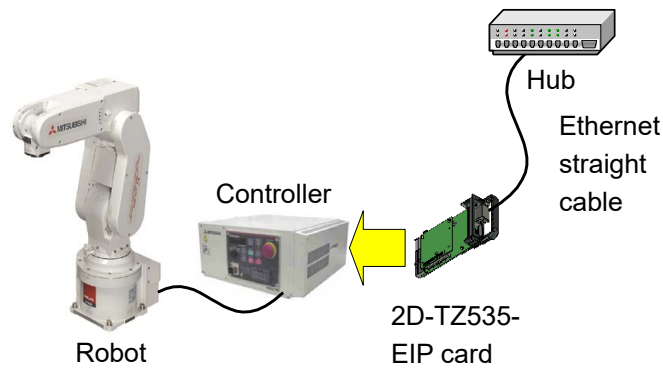

- (3) Connect the Ethernet straight cable connector to the EtherNet/IP connector on CompactLogix L35E (PLC by Rockwell).
- (4) Connect the other connector to the hub.

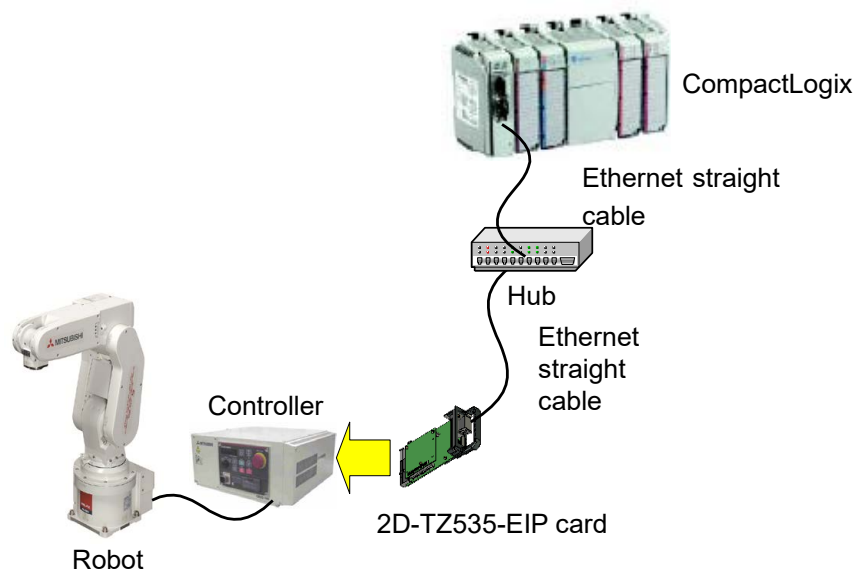

8 Connections and Wiring

- (5) Connect the Ethernet straight cable connector to the personal computer in which RSLogix5000 (Rockwell support software) is installed.
- (6) Connect the other connector to the hub.

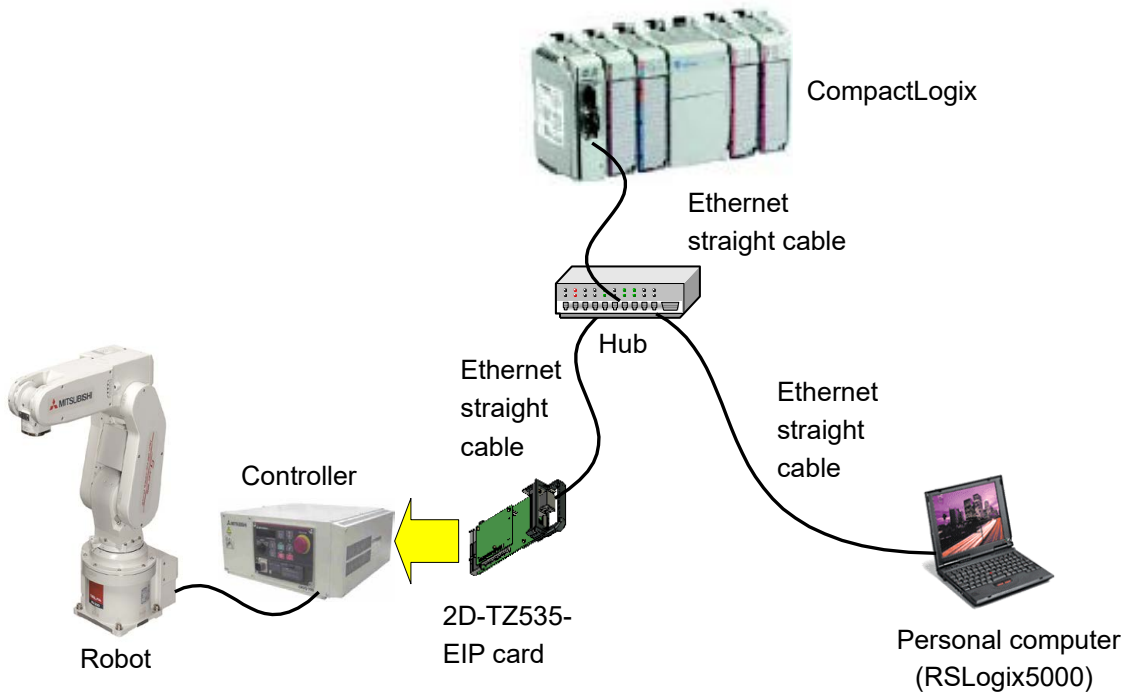

The whole image of the connection is shown below. Please refer to it.

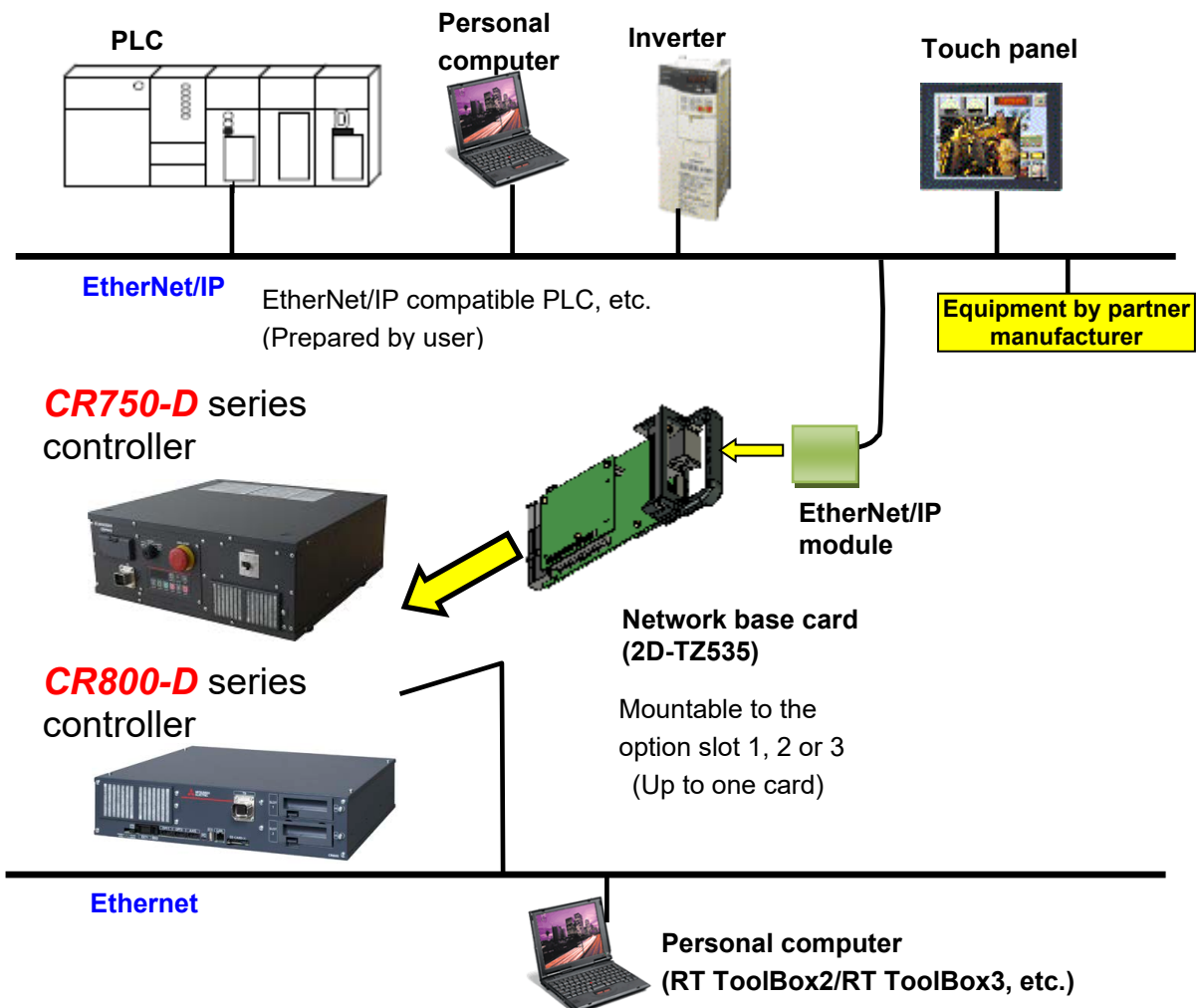

Check the following connections again before using the 2D-TZ535 card.

Table 8-1 Checking connections

No.	Check item	Check
1	Is the 2D-TZ535 card securely mounted into the controller slot?	
2	Are the Ethernet cables between the 2D-TZ535 card and prepared external devices correctly connected?	

PROFINET IO

8.2.2. For the PROFINET IO 2-Port module

An example of connecting the 2D-TZ535 card and Siemens PLC (SIMATIC) one-on-one with an Ethernet cable is explained below.

- (1) Connect the Ethernet straight cable connector to the 2D-TZ535 card.
- (2) Connect the other connector to the hub.

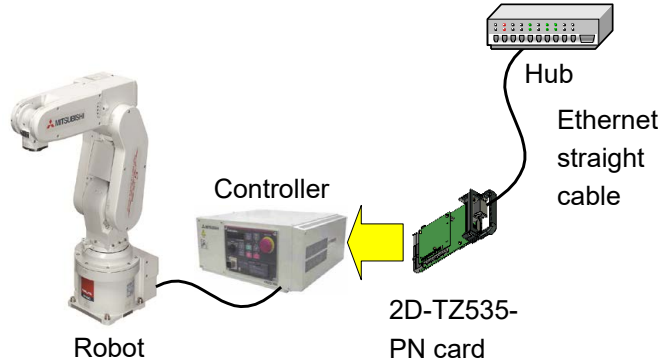

- (3) Connect the Ethernet straight cable connector to the PROFINET IO connector on SIMATIC PLC (PLC by Siemens).

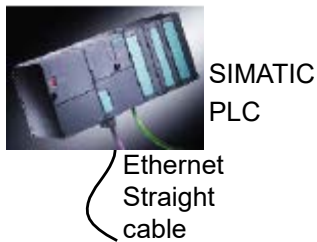

- (4) Connect the other connector to the hub.

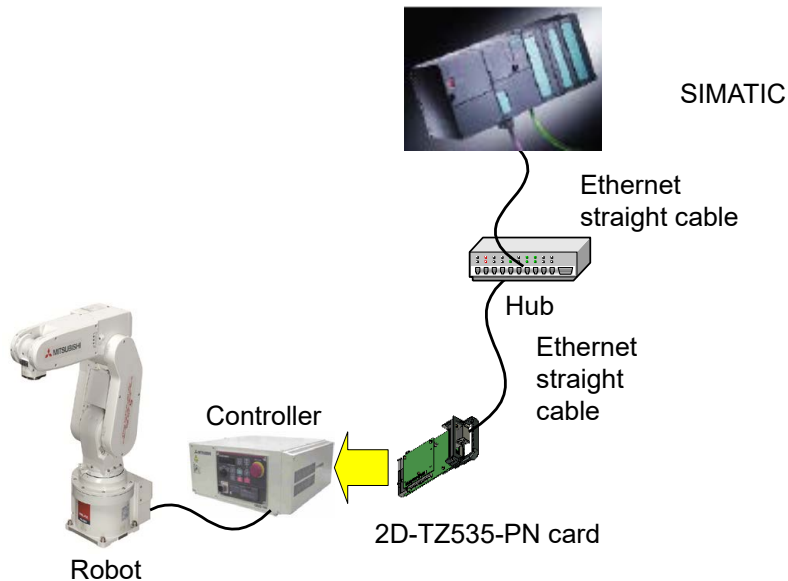

- (5) Connect the Ethernet straight cable connector to the personal computer in which STEP7 (Siemens support software) is installed.
- (6) Connect the other connector to the hub.

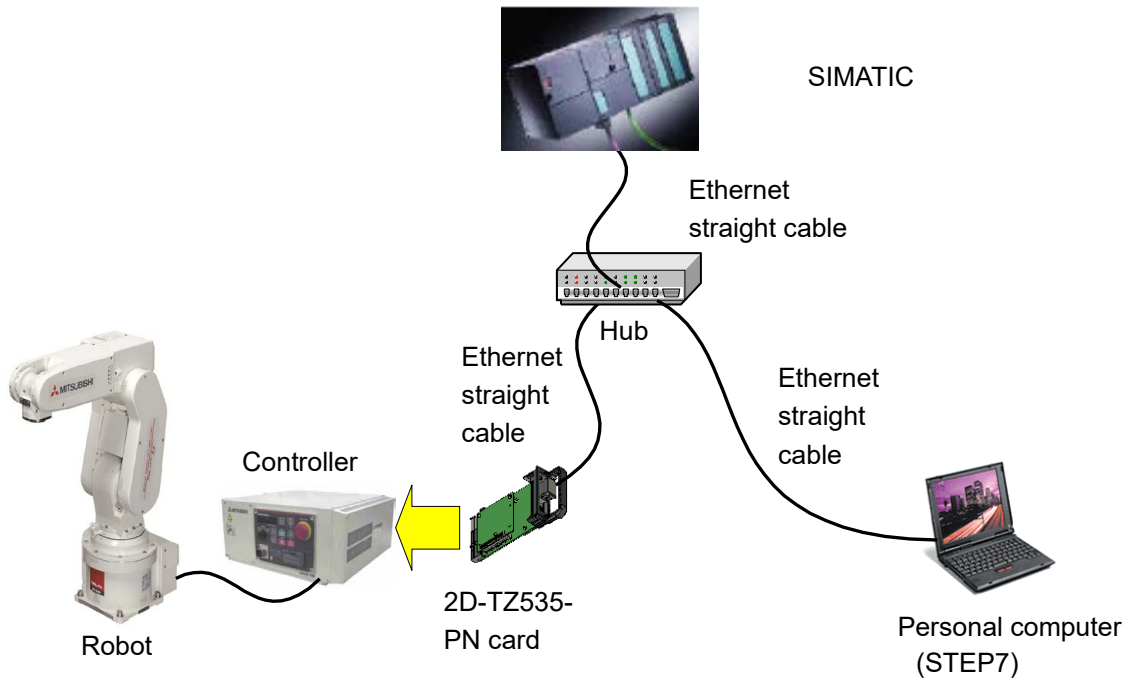

Because the PROFINET IO 2-Port module has two connectors, the following connections are possible.

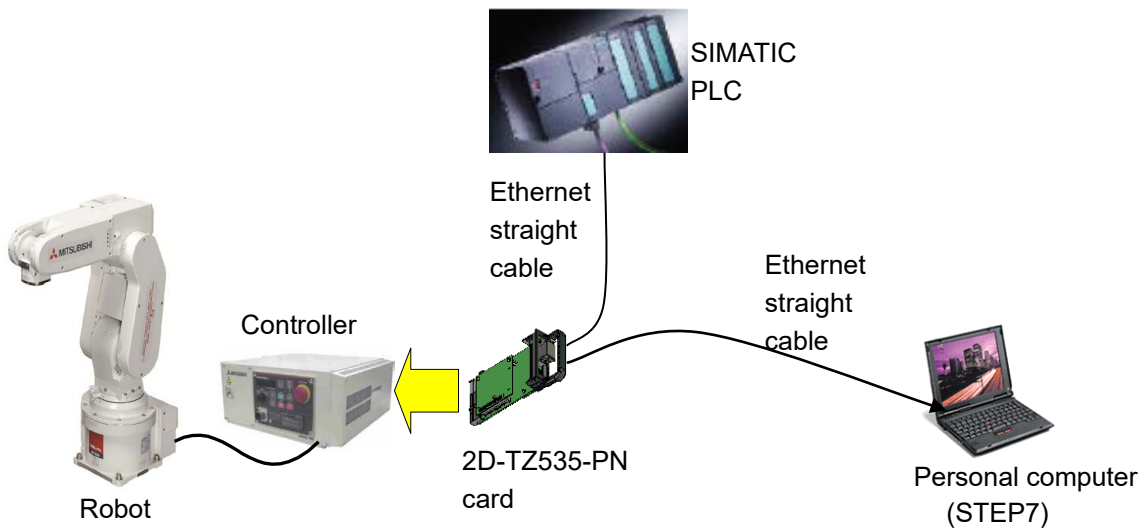

The whole image of the connection is shown below. Please refer to it.

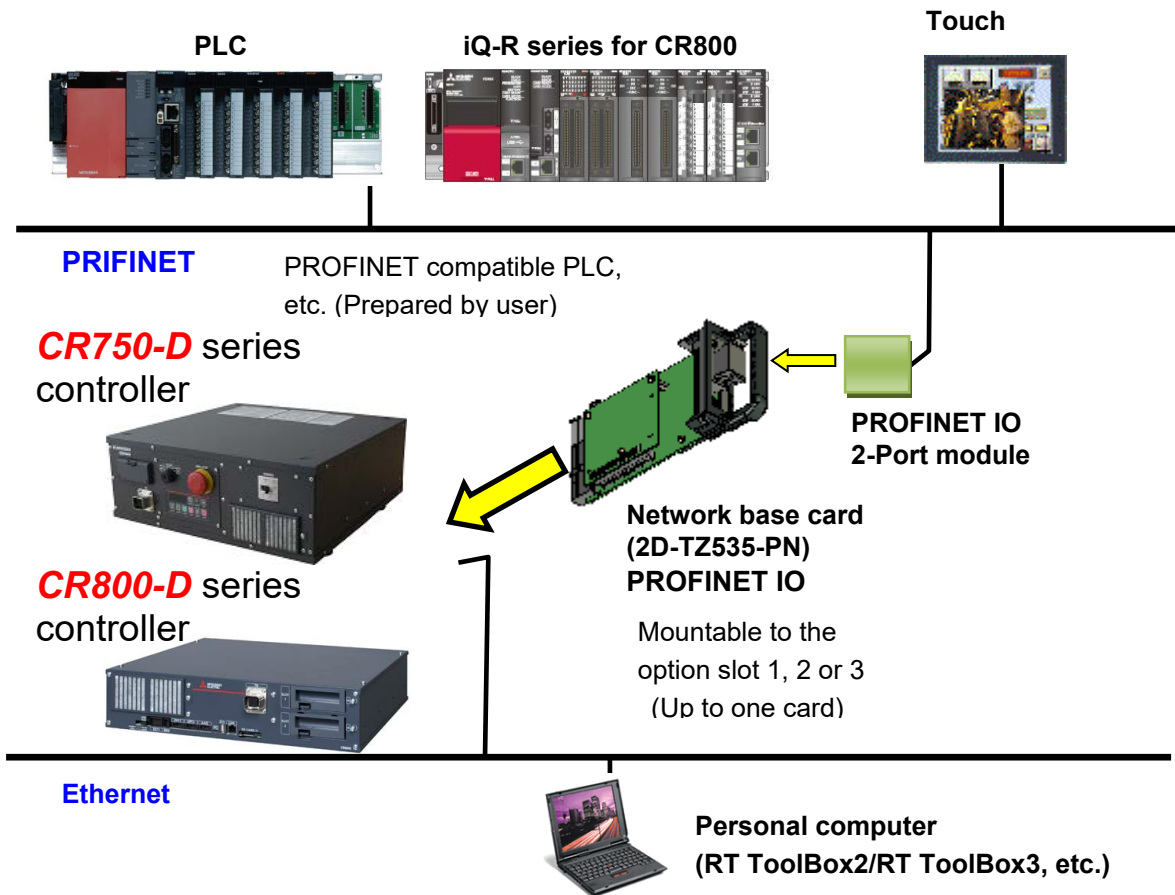

Check the following connections again before using the 2D-TZ535 card.

Table 8-2 Checking connections

No.	Check item	Check
1	Is the 2D-TZ535 card securely mounted into the controller slot?	
2	Are the Ethernet cables between the 2D-TZ535 card and prepared external devices correctly connected?	

9. Procedures for Starting Operation

The procedures for starting operation with the Anybus-CompactCom module are shown below. In this example, the 2D-TZ535 card and the PLC are connected one-on-one with an Ethernet cable, and an operation to confirm the I/O signal is performed.

For more information on the PLC, refer to the manual enclosed with the PLC.

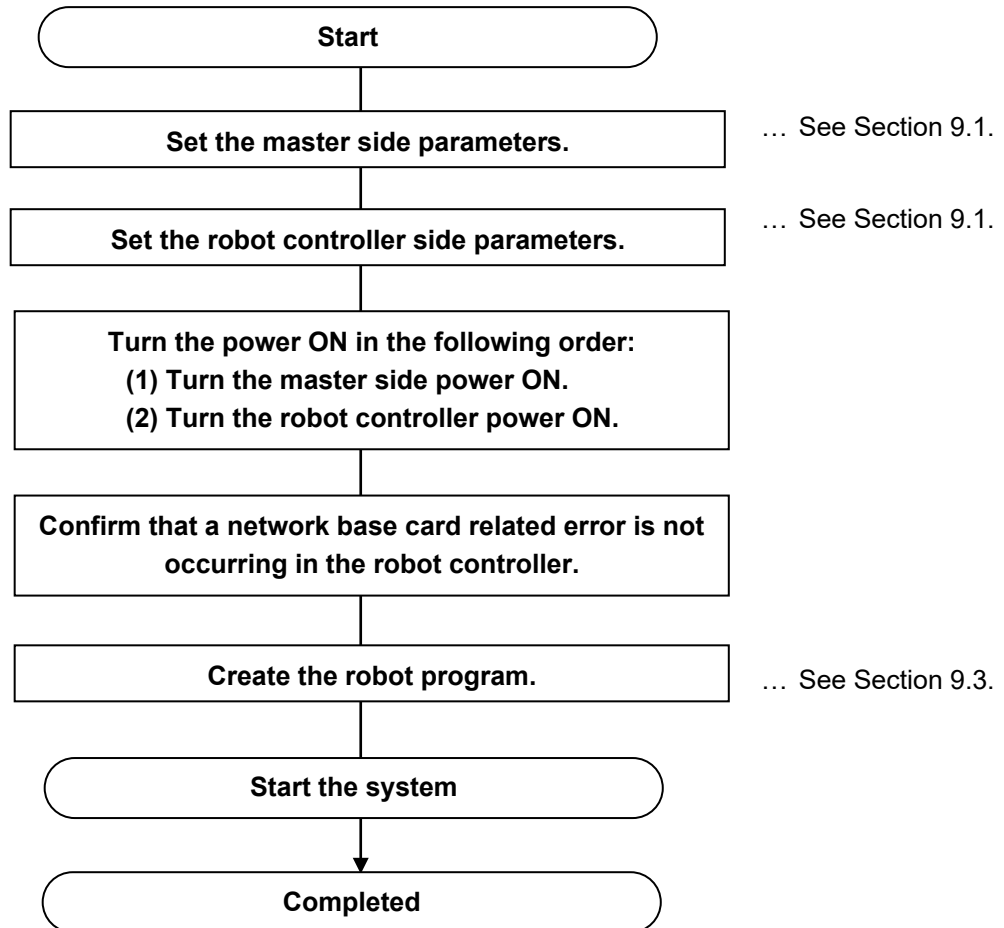

Figure 9-1 Procedures for starting operation

9.1. Setting the Parameters



9.1.1. For the EtherNet/IP module

- (1) Set the IP address and upgrade the firmware version as explained in the "Installation Guide" enclosed with CompactLogix.
- (2) The EDS file (ABCC EIPT EDS file) is included on the instruction manual CD-ROM (BFP-A8873).
 - a) Start the EDS Hardware Installation Tool.

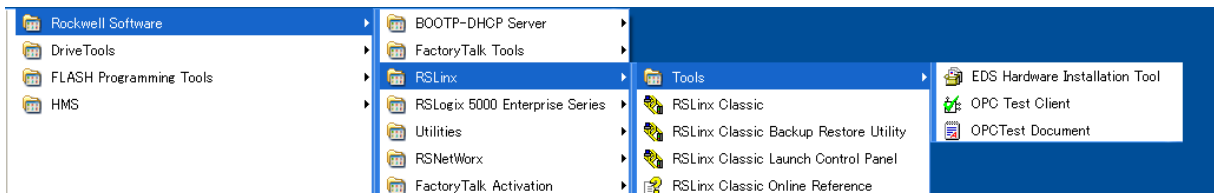

- b) Click the [Add] button.

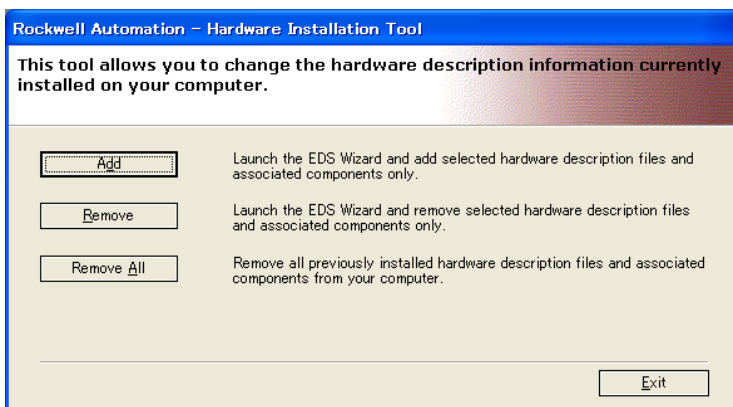

- c) Designate the folder containing the EDS file.

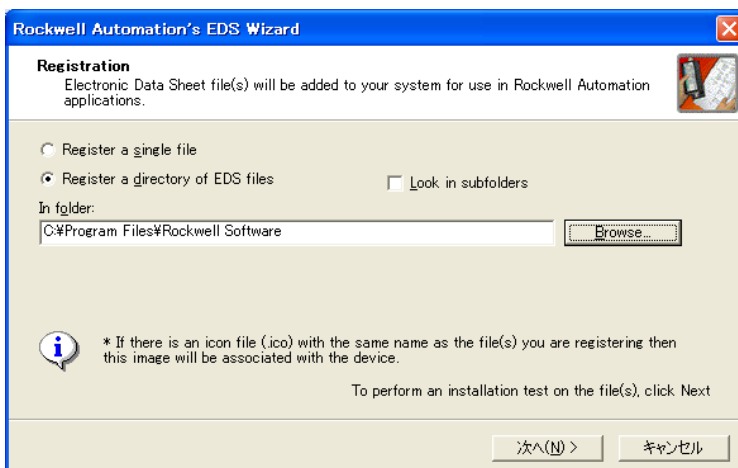

- d) Click the [Next] button to complete the process.
(If necessary, the icon which indicates that the PLC has recognized the 2D-TZ535 card can be changed.)

(3) Set the IP address for the robot controller EtherNet/IP in the robot controller parameter "EPIP".

Set the IP address for EtherNet/IP in the parameter "EPIP" on the RT ToolBox2 or RT ToolBox3 "Parameter list" screen.

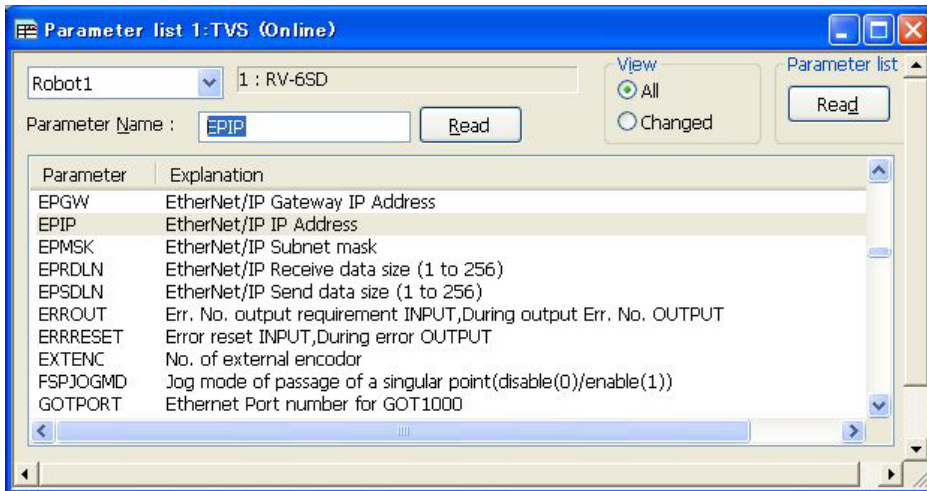

(4) Set the system configuration using RSLogix5000.

e) Start RSLogix5000, and click [New] under the [File] menu.

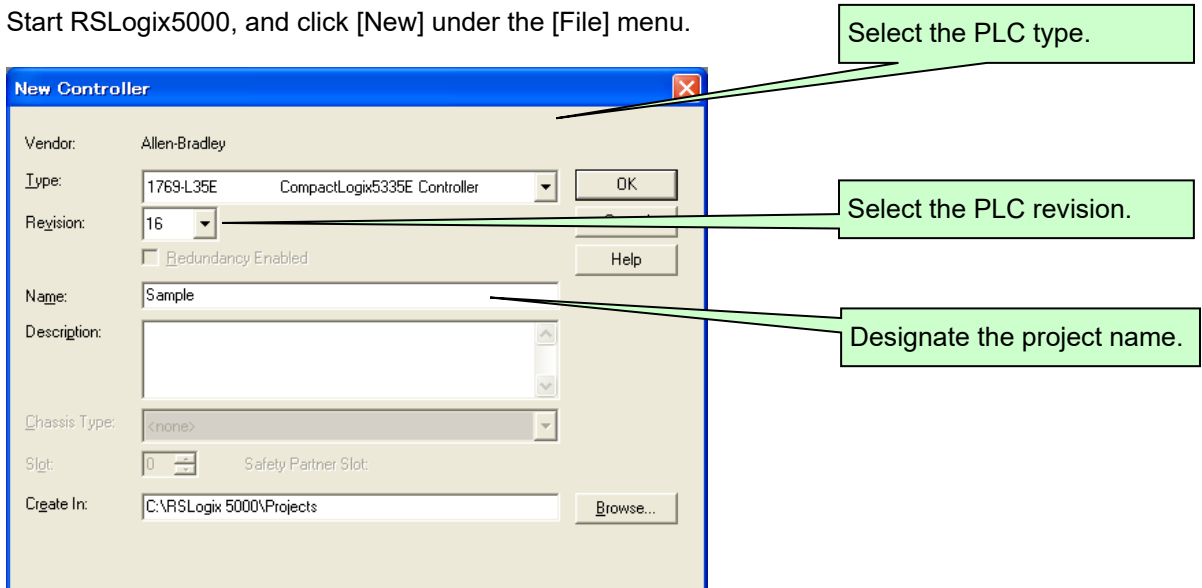

f) Click [Who Active] under the [Communications] menu, click "CompactLogix Processor", and then click [Set Project Path].

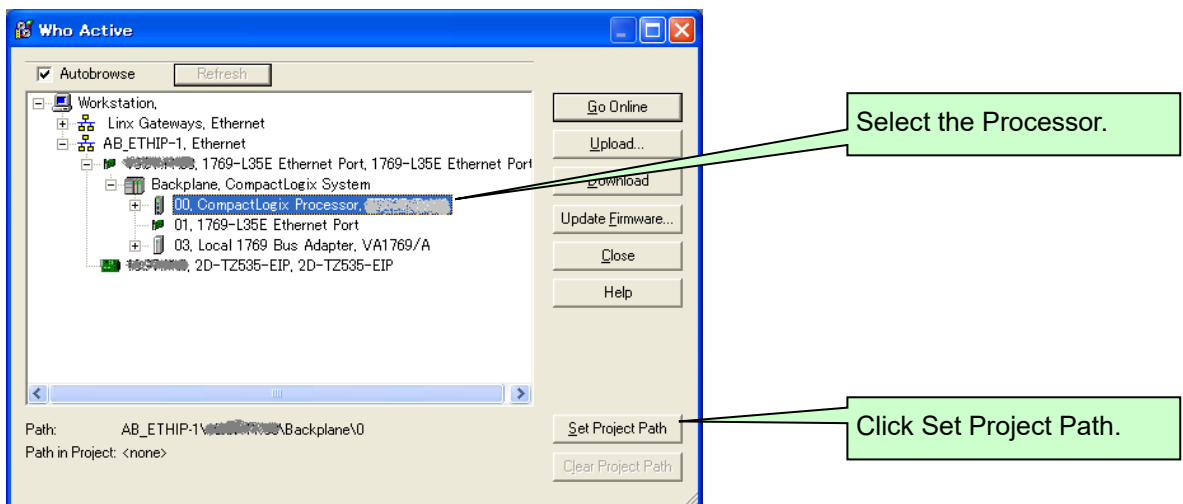

9 Procedures for Starting Operation

g) Right-click [Ethernet] in the project tree [I/O Configuration], and click [New Module].

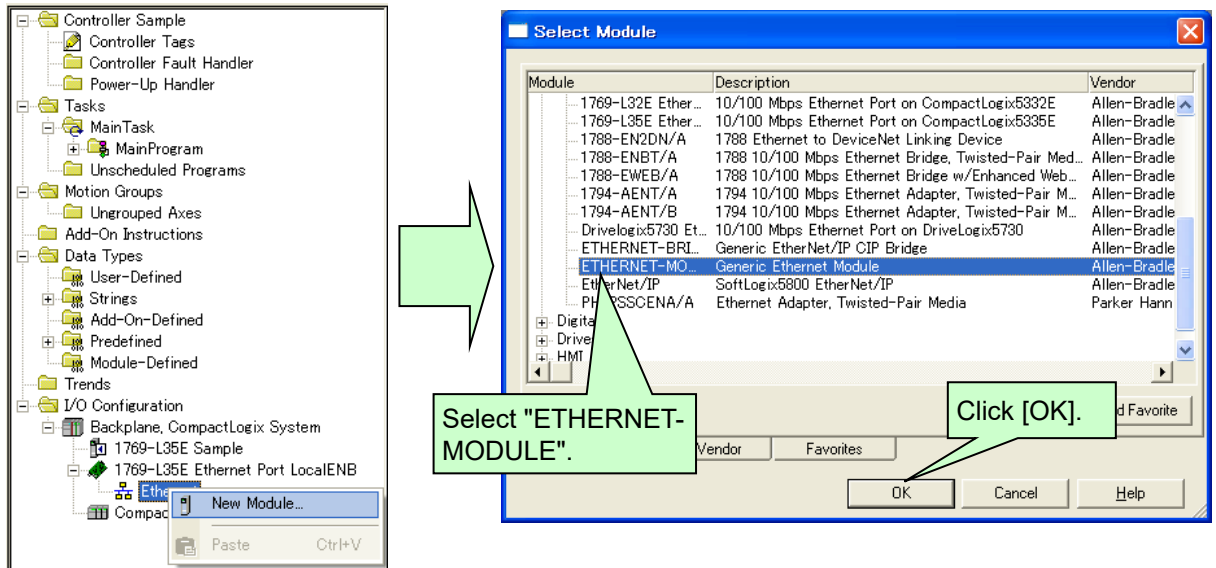

h) Complete the 2D-TZ535 card settings on the "New Module" screen.

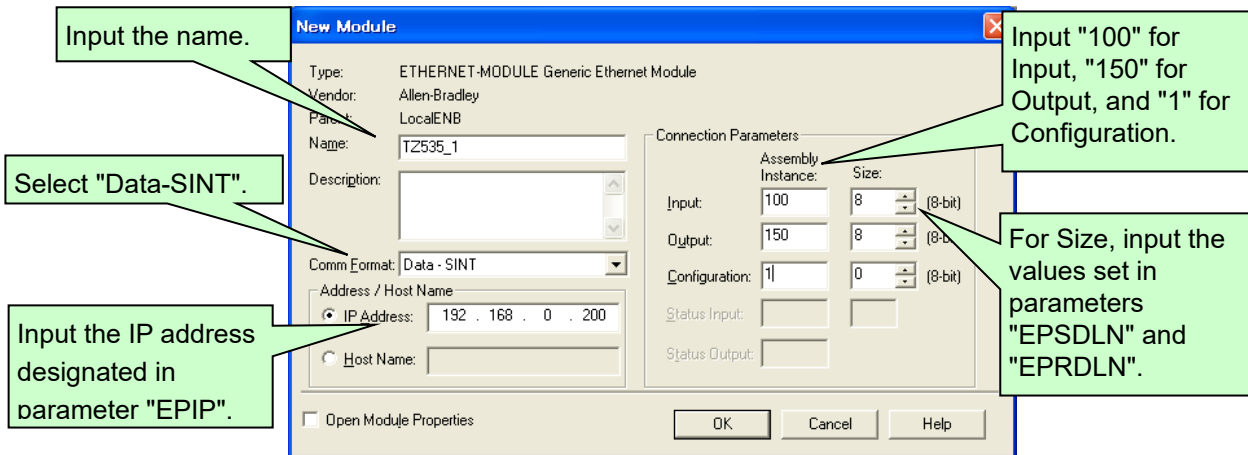

i) Set RPI.

Set RPI on the following screen which opens.

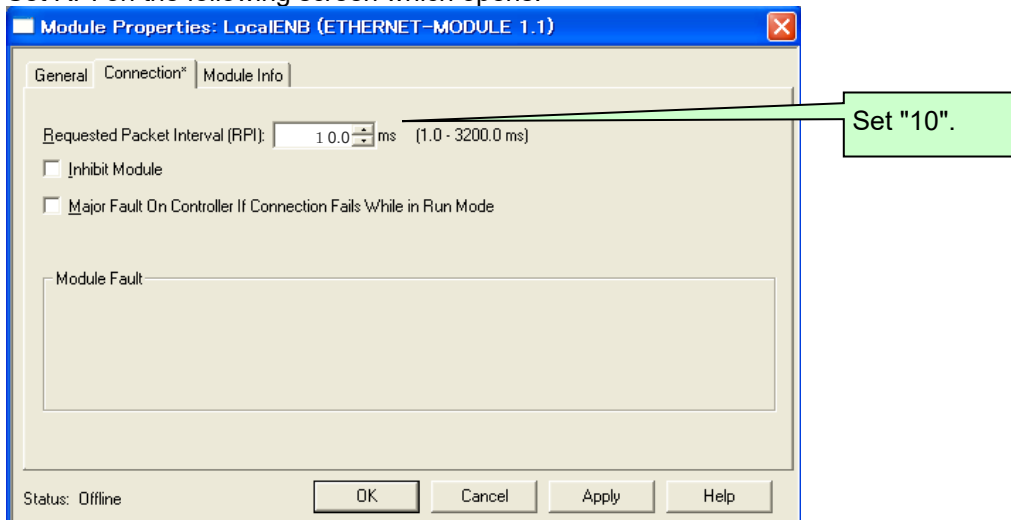

If the above screen does not open, right-click "ETHERNET-MODULE arbitrary name" in the project tree, click [Properties], and click the [Connection] tab.

j) Click [Download] under the [Communications] menu, and click the [Download] button.

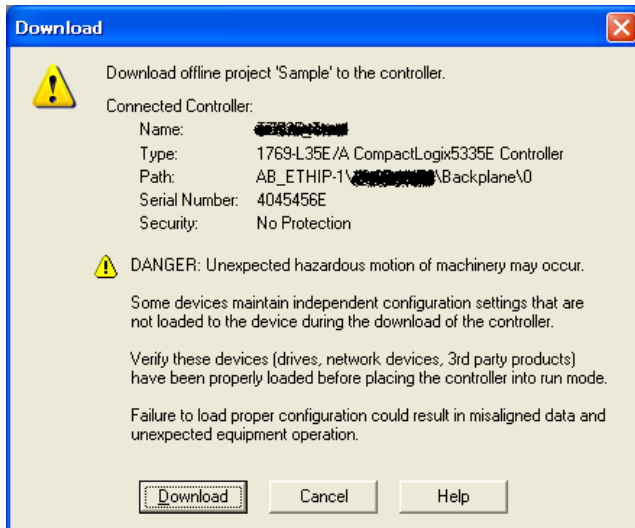

(5) Confirm that the status for the added "ETHERNET-MODULE" is "Running".

Click "ETHERNET-MODULE arbitrary name" in the project tree, and confirm that the "Status" display is "Running".
 If the status is not "Running" and an error is displayed, refer to the PLC help and remove the cause of the error.

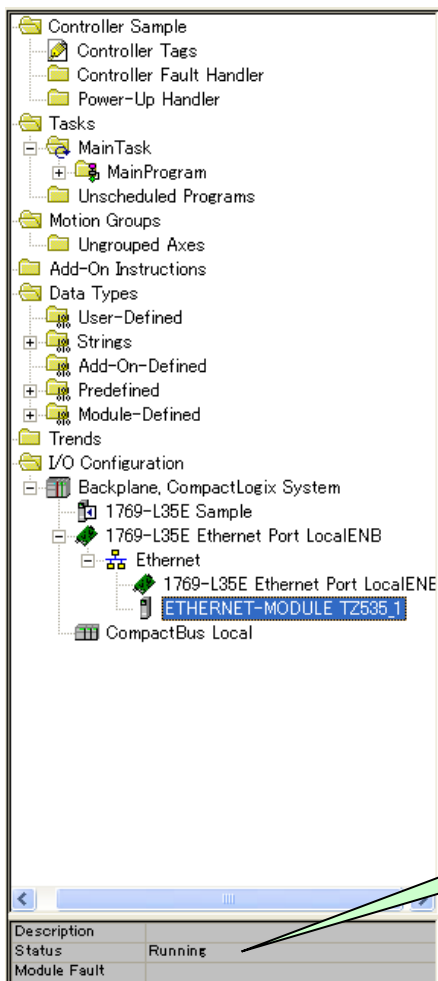

Confirm this status is "Running".

9.1.2. For the PROFINET IO 2-Port module

- (1) Make the project of PLC newly.

Start "SIMATIC Manager".

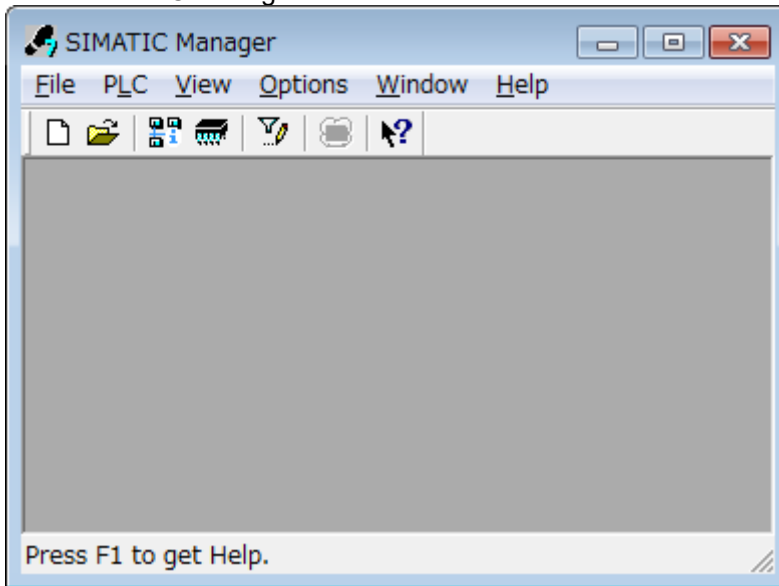

For the wizard, click the [Cancel] button. And, click [File]-[New] from the menu.

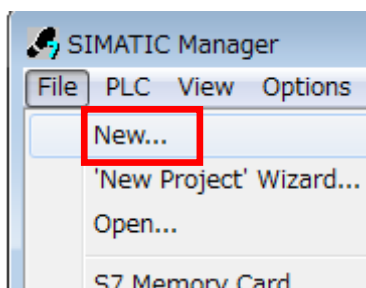
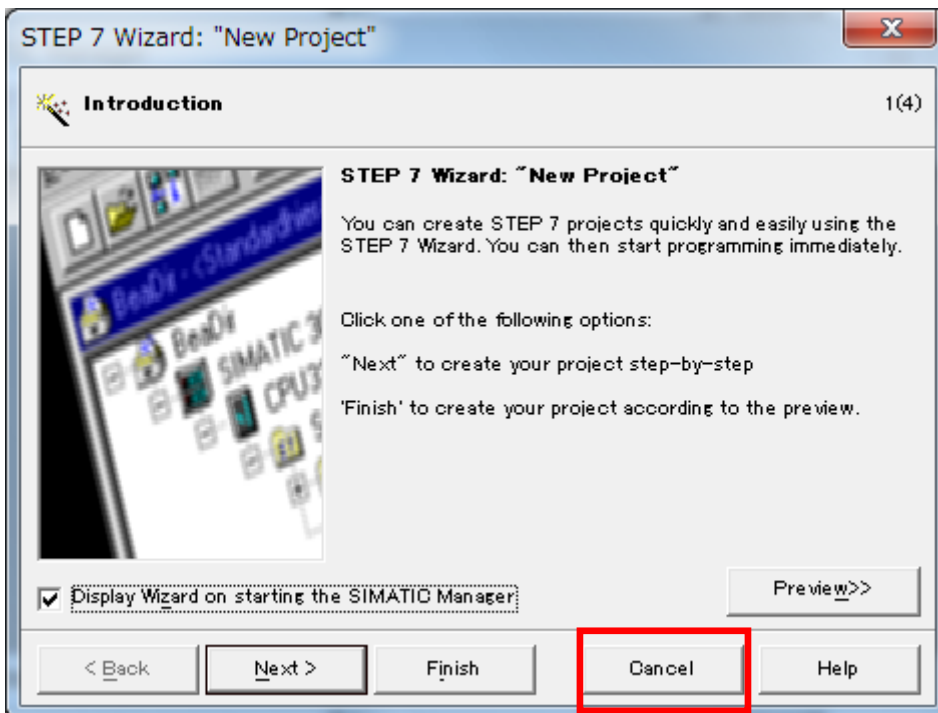

Fill in the project name. Then click the [OK] button.

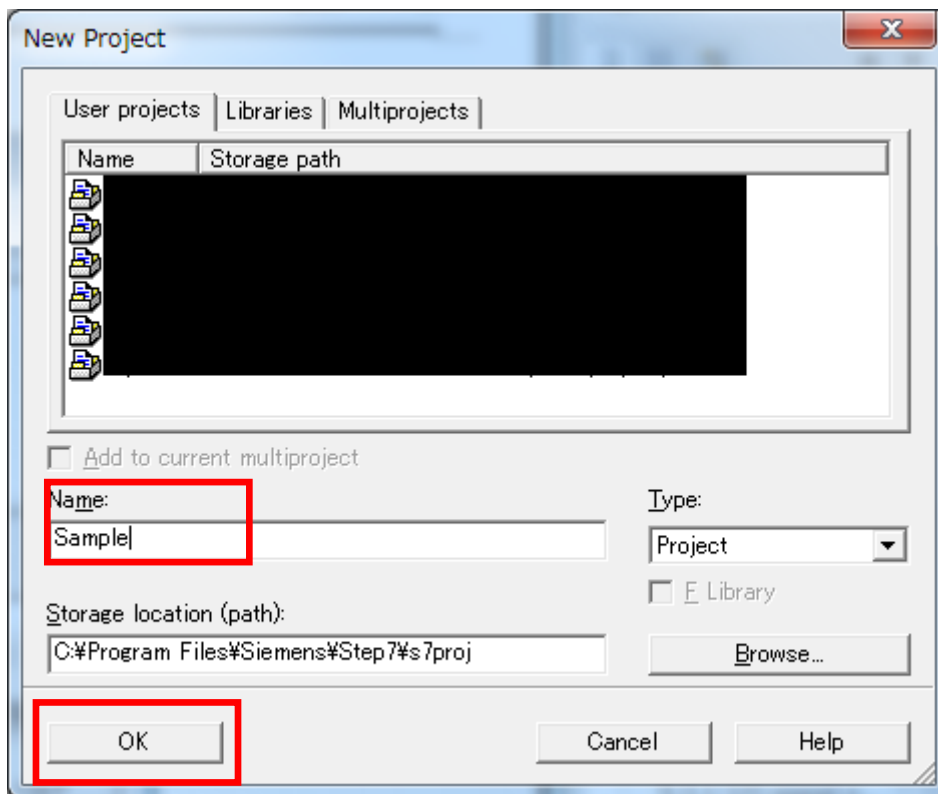

(2) Set the hardware configuration of PLC.

In a left frame with the displayed screen, right-clicking in the icon of the project name, and click the menu [Insert New Object] – [SIMATIC*** Station] (** = Series number).

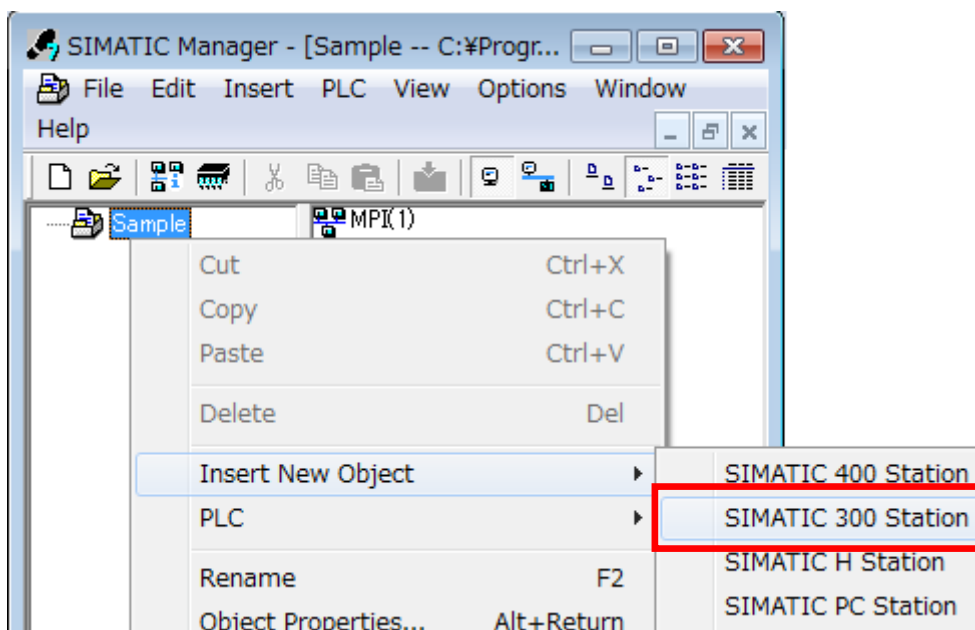

Again, right-clicking in the icon of the project name, and click the menu [Insert New Object] – [Industrial Ethernet].

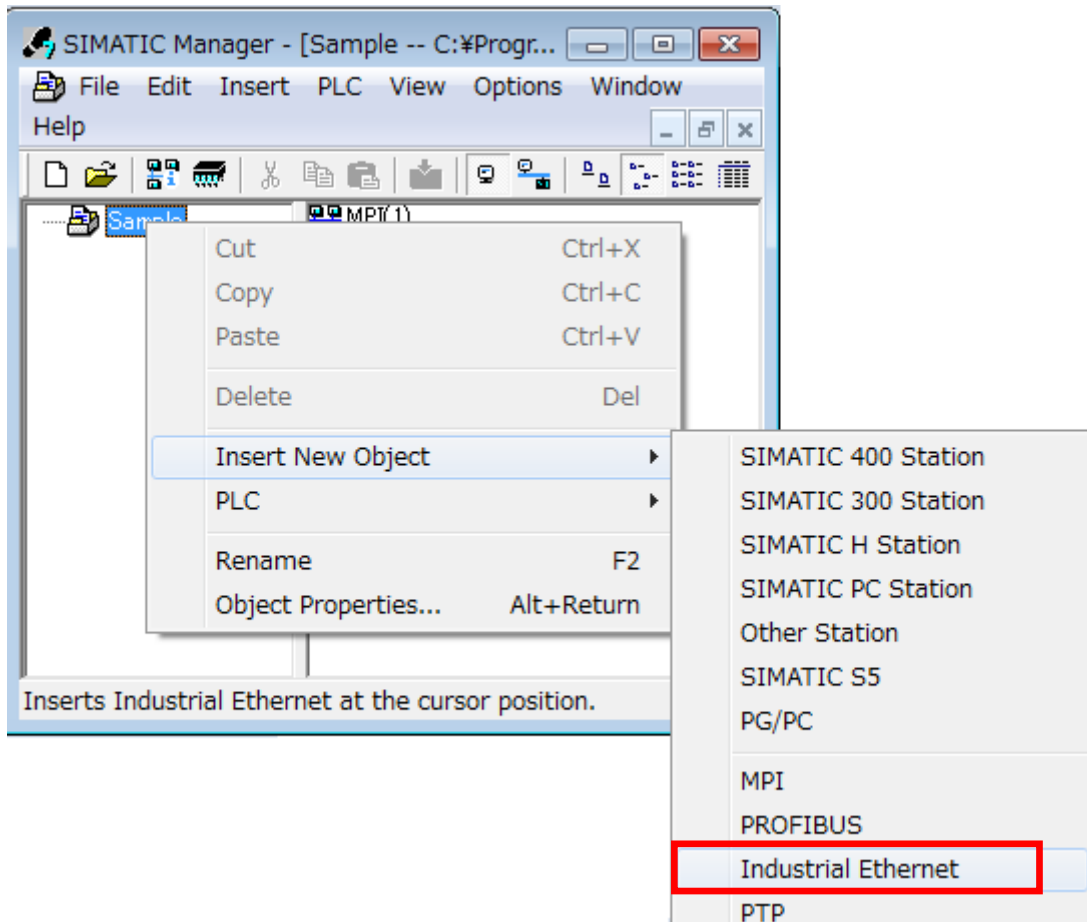

Click [SIMATIC ***] in a left frame, and double-click [Hardware] displayed in a right frame.

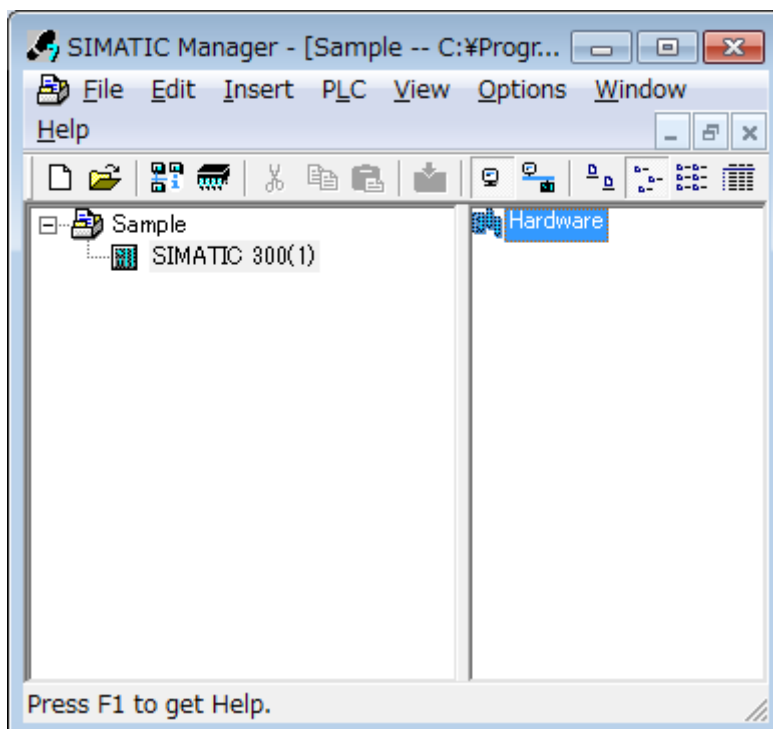

Drag "Rail" that exists in [SIMATIC***] – [RACK-***] of "HW catalog" frame, and drop to the frame on the left on the displayed "HW configuration" screen.
 Similarly drag other units, and drop to a left frame.
 For instance, drag "PS 307 2A" of the power supply unit, and drop to slot 1 of "Rail".
 In addition, drag CPU, and drop to slot 2.

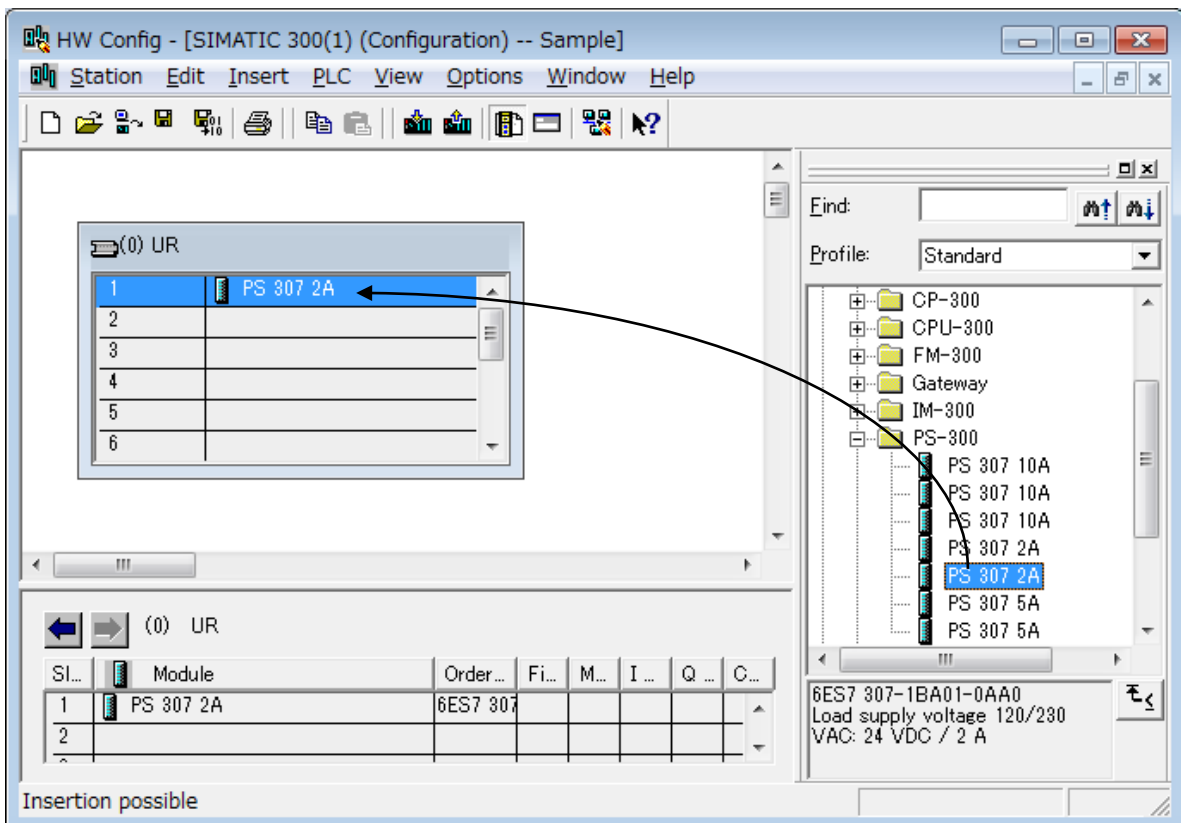
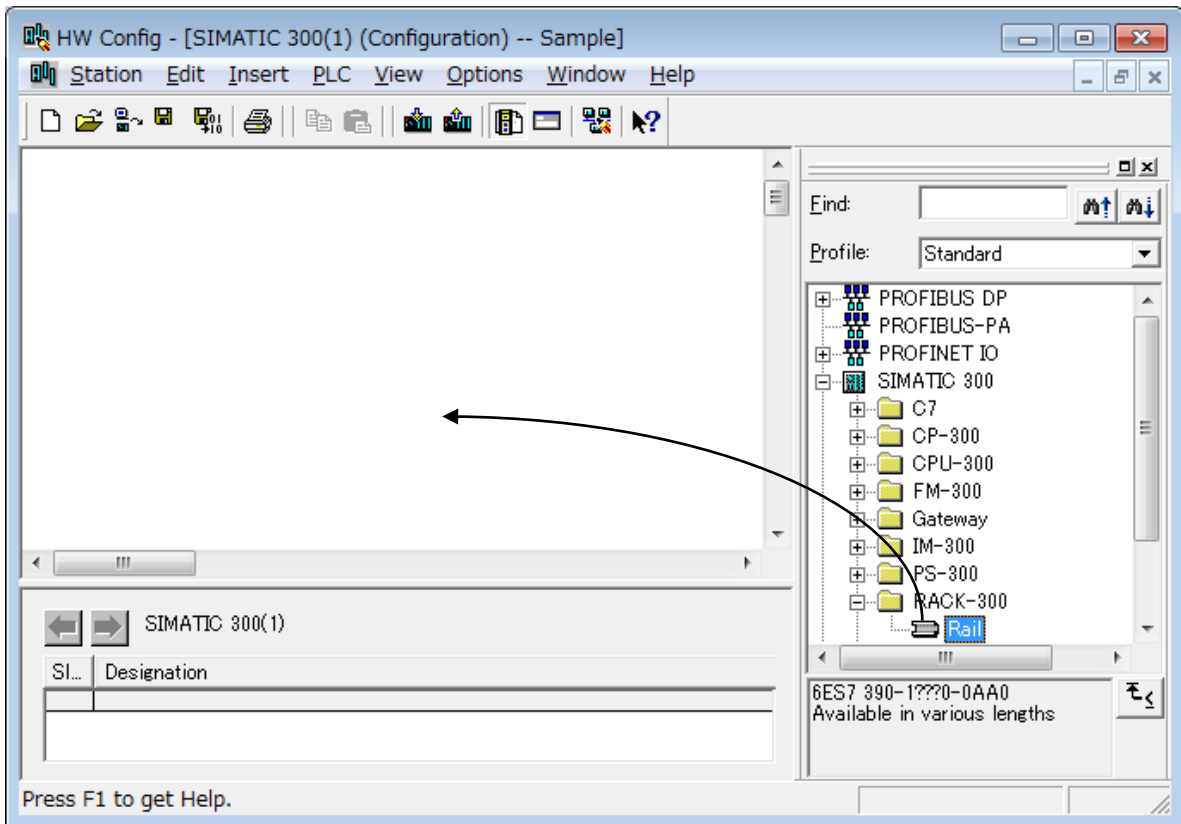

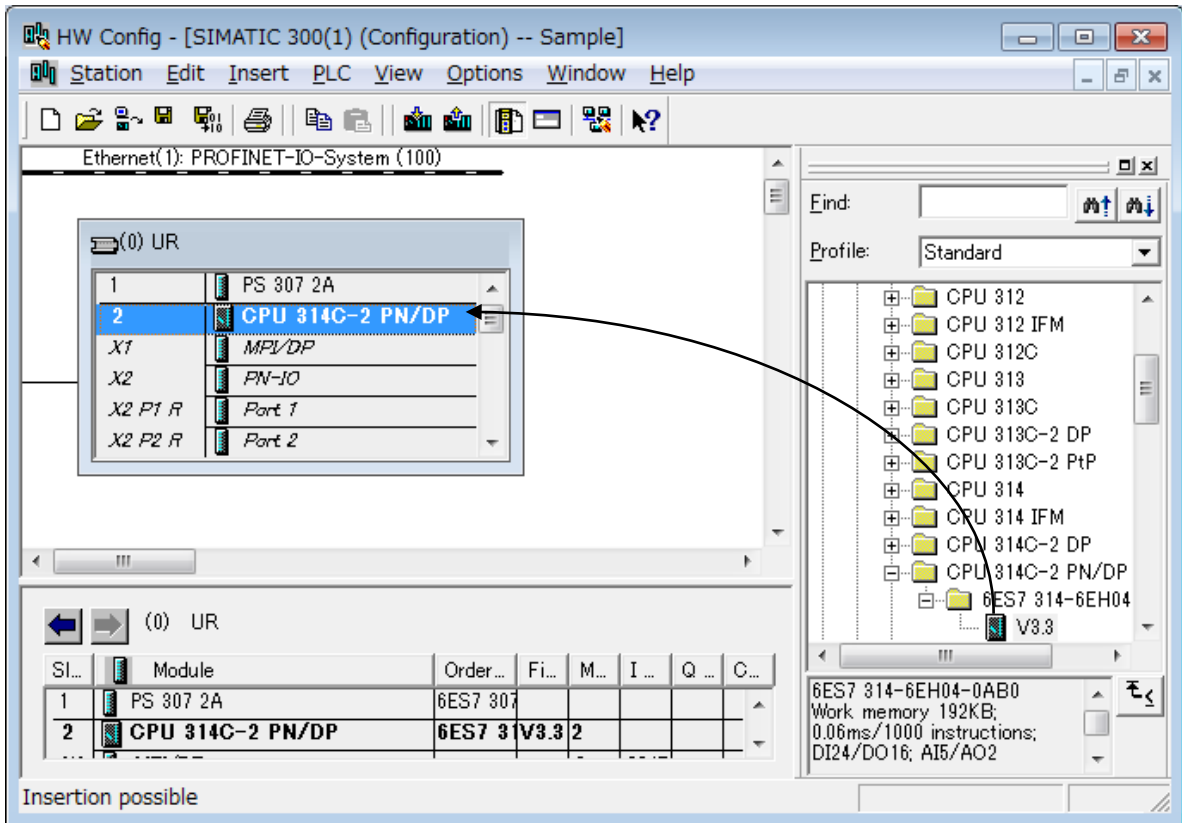

When CPU is dropped, the following properties(network setting) screen is displayed.
 Set a necessary item.
 Select "Ethernet(1)" displayed in the subnet item.

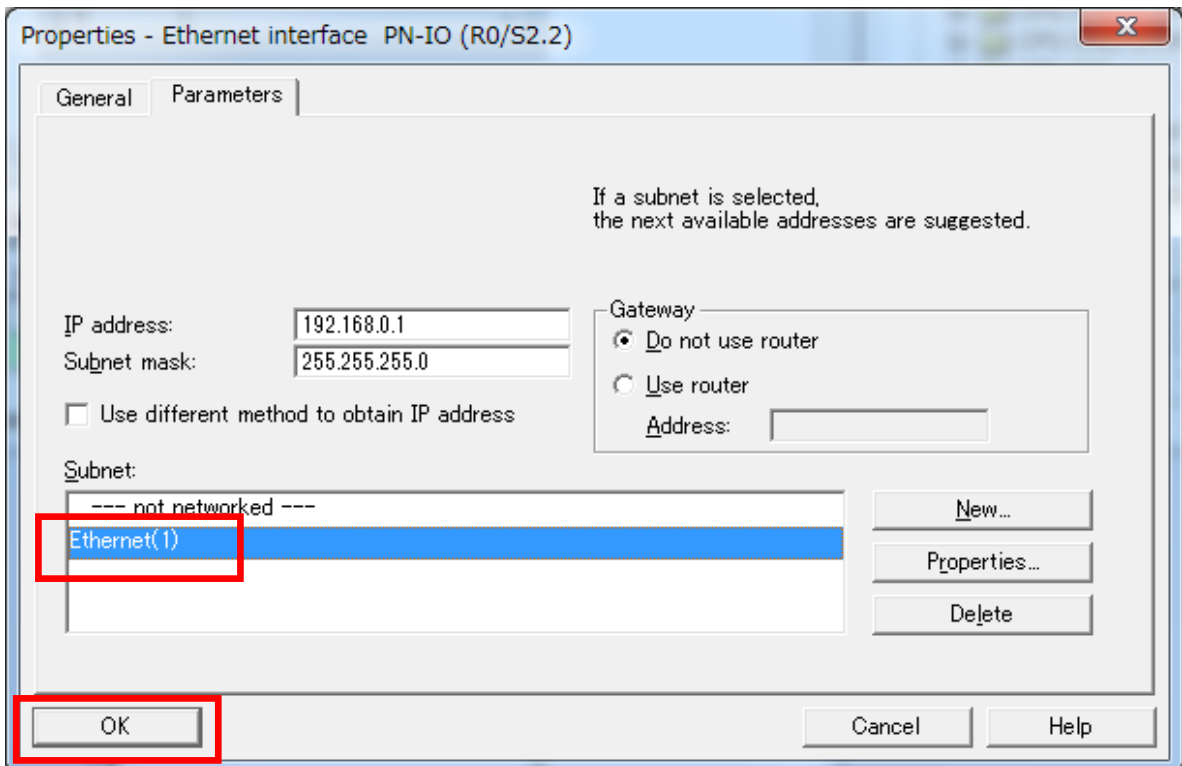

(3) Set the "Size of the process-image area" of PLC.

Double-click dropping CPU. "Properties" screen is displayed.

Click [Cycle/Clock Memory] tab, and change the size of the process image input area and the size of the process image output area to "512".

After that, Click the [OK] button. The screen is closed.

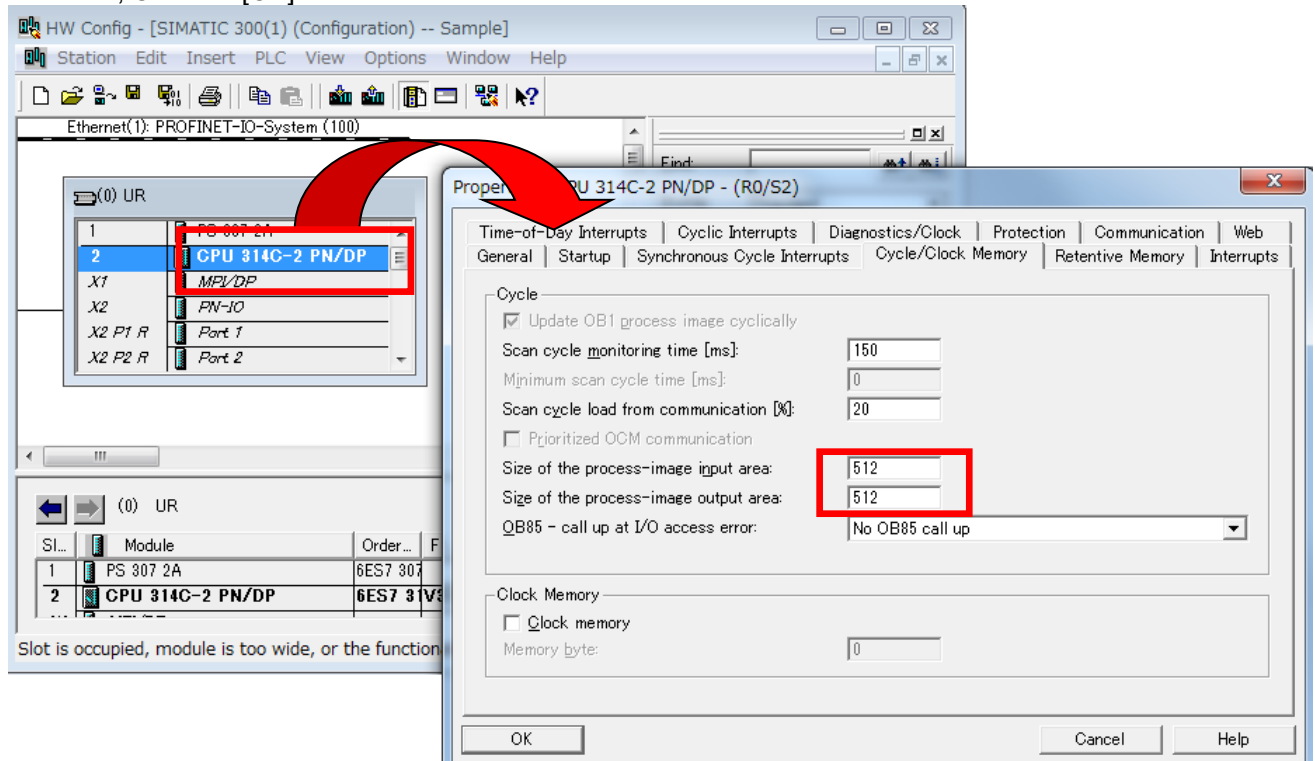
**(4)** Install the GSDML file for the robot.

Click [Options] – [Install GSD File...] from the menu.

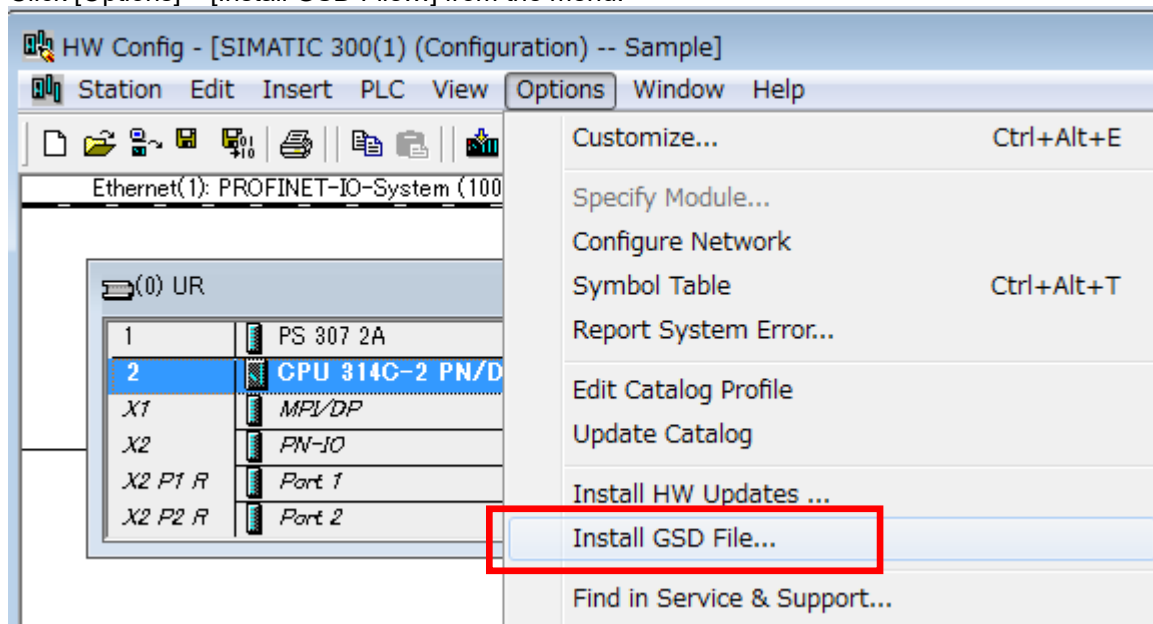

9 Procedures for Starting Operation

The GSD file is in CD-ROM of the attachment.
The file name is "GSDML-V"Version" -MITSUBISHI-TZ535_PN -"Update day".xml.
The Bmp file name is "GSDML-021C-3B01-TZ535_PN.bmp".

Select the corresponding GSD file and click [Install] button.

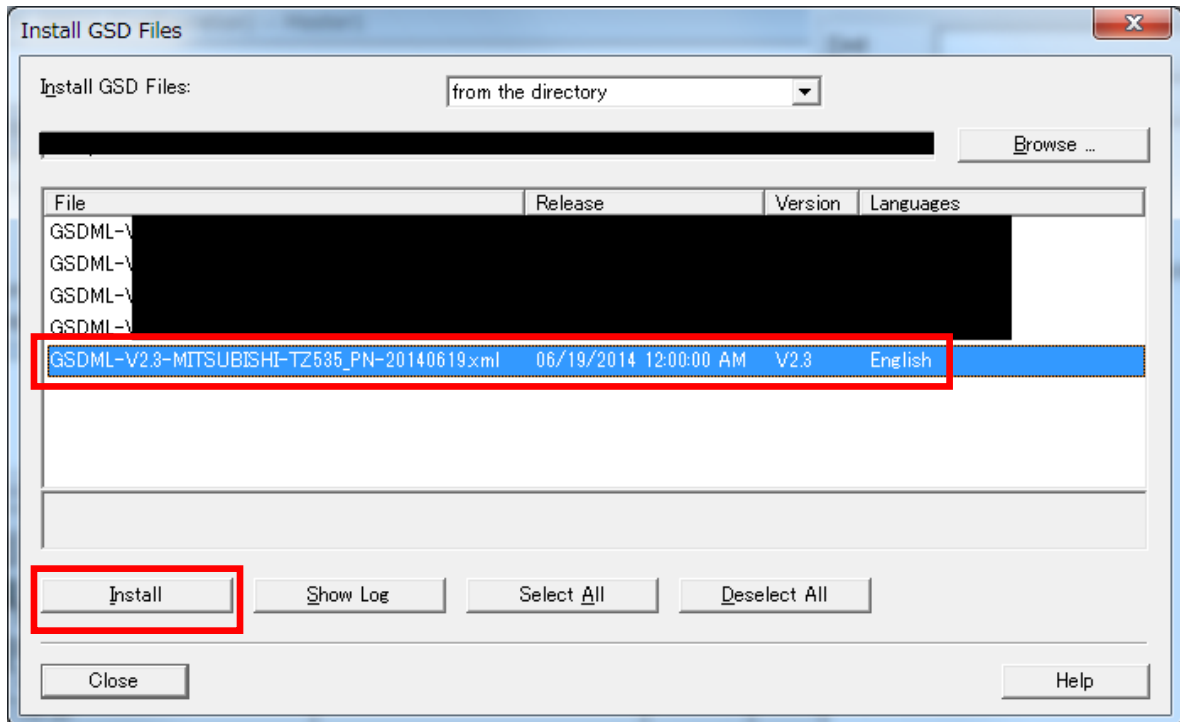

When the installation is completed, the following screens are displayed.

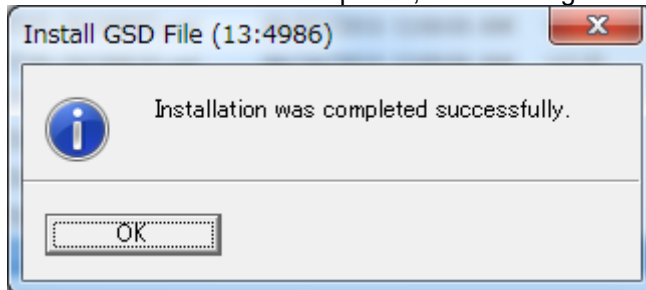

Click the [OK] button. And Click [Close] button on [Install GSD Files] screen.

(5) Add the robot to the H/W configuration.

There is "2D-TZ535-PN(PROFINET IO)" icon for the Mitsubishi robot in the HW catalog frame ([PROFINET IO] – [Additional Field Devices] – [General] – [2D-TZ535-PN]).

Drag it, and drop to "Ethernet(1)".

Next, click [+] sign of the "2D-TZ535-PN(PROFINET IO)" icon. Then six items are displayed.

Drag the icon of a corresponding number of bytes to robot controller's parameter "PNIOLN", and drop to slot 1.

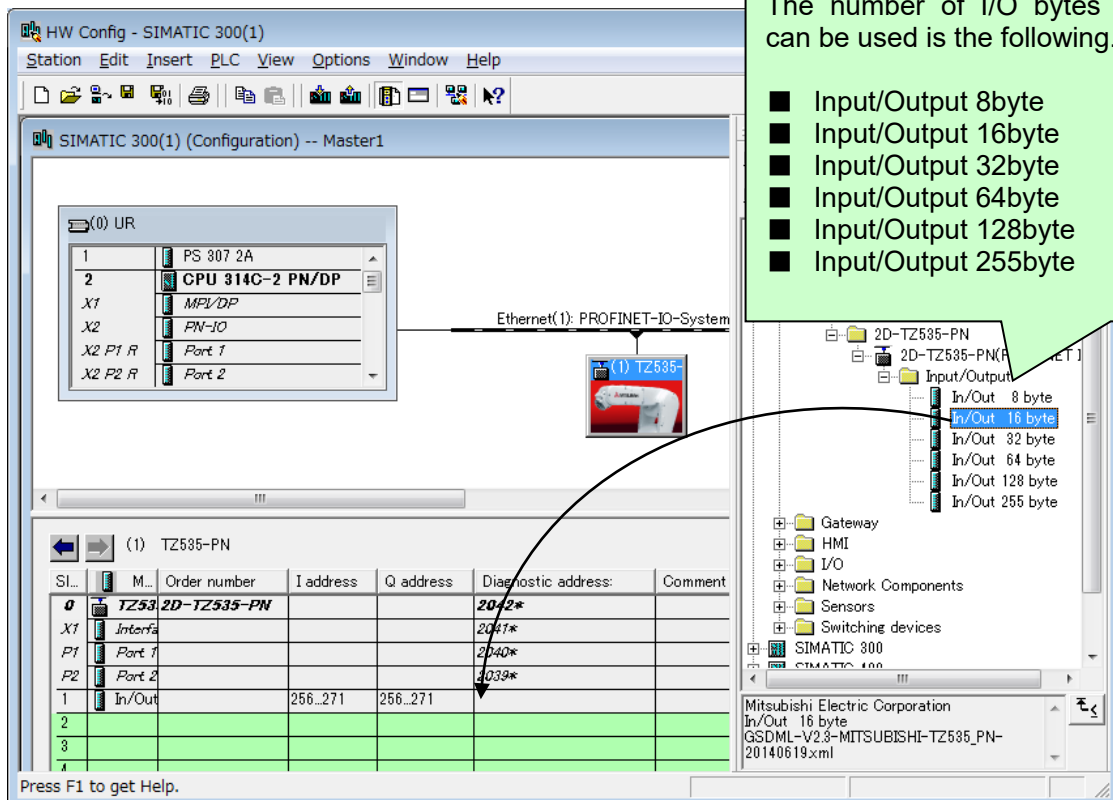
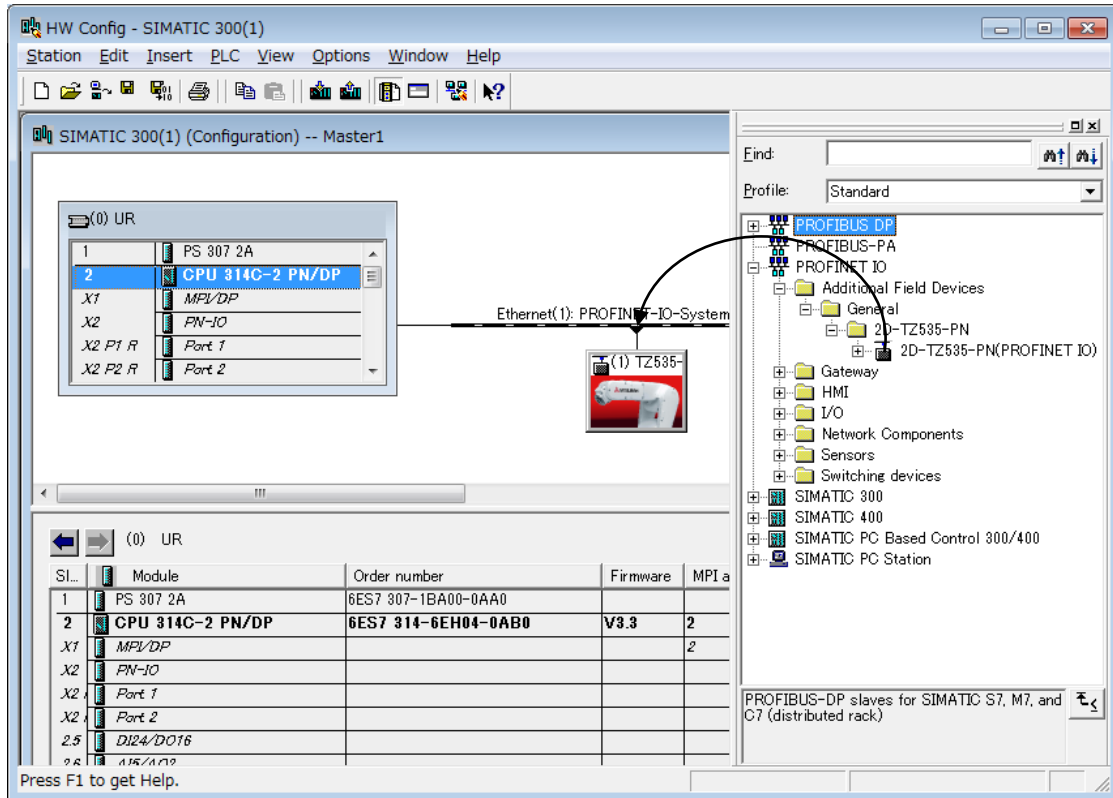

Save the setting clicking [Station] – [Save] from the menu.

(6) Make the program of PLC.

Click the [Blocks] icon of a left frame, and double-click [OB1] icon displayed in a right frame on the SIMATIC Manager screen.

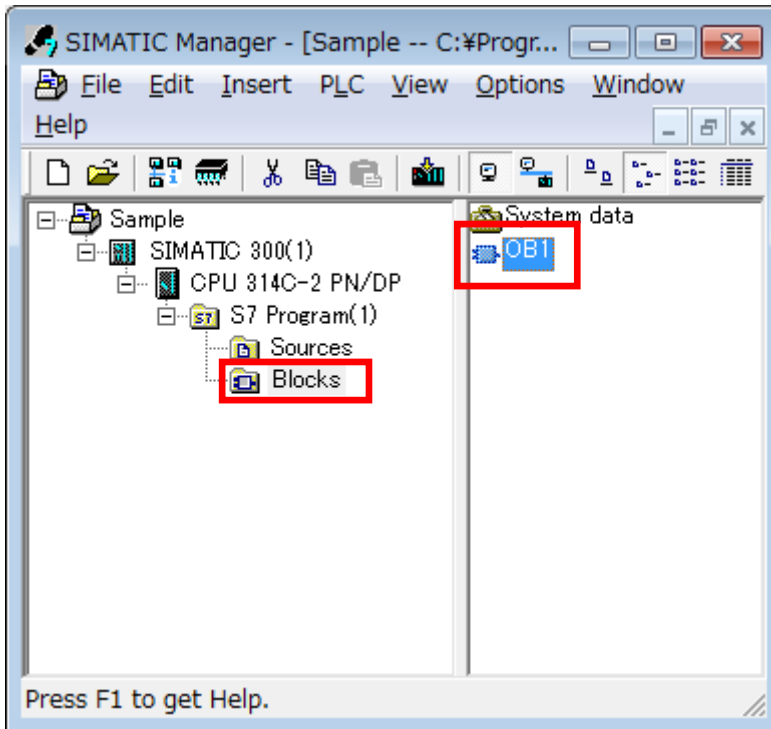

Set the following content when the following "Properties - Organization Block" screen is displayed.

- Fill in the [Symbol Name] on "General – Part1" tab.
- Change the [Created in Language] to "LAD".

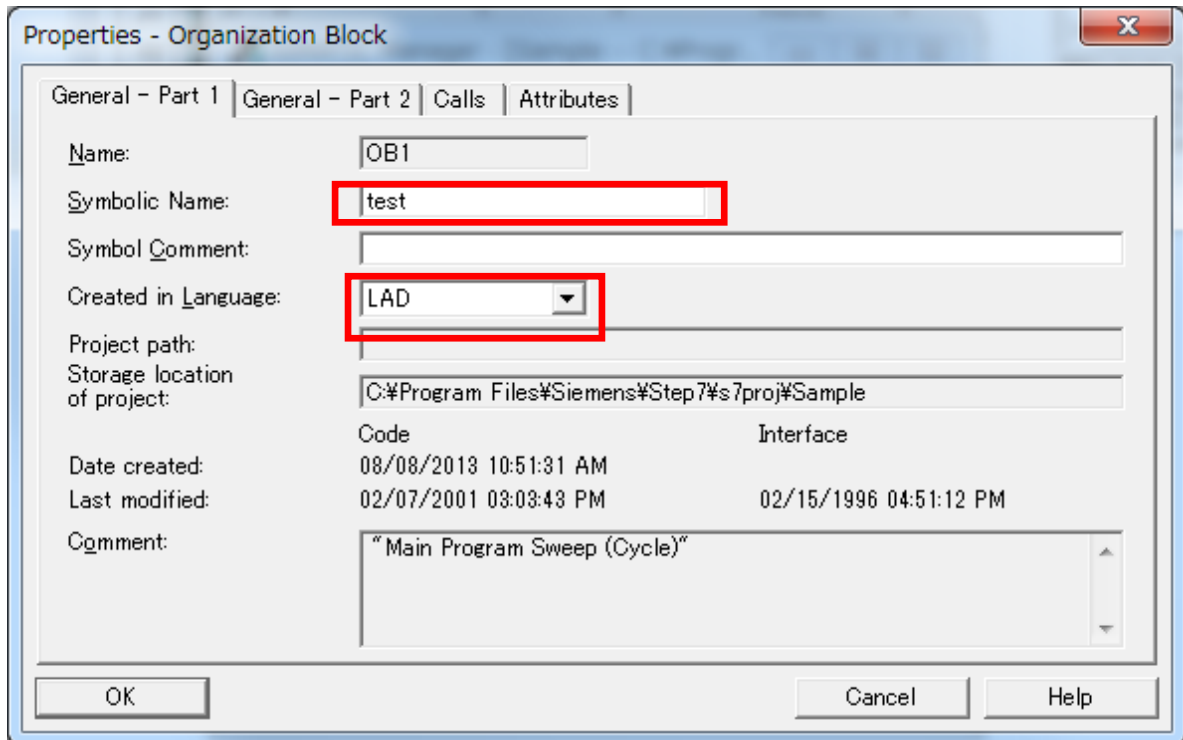

Click the [OK] button.

Drag SFC20 from [Libraries] - [Standard Library] – [System Function Blocks] of a left frame, and drop to a right frame on the displayed "Program window" screen.

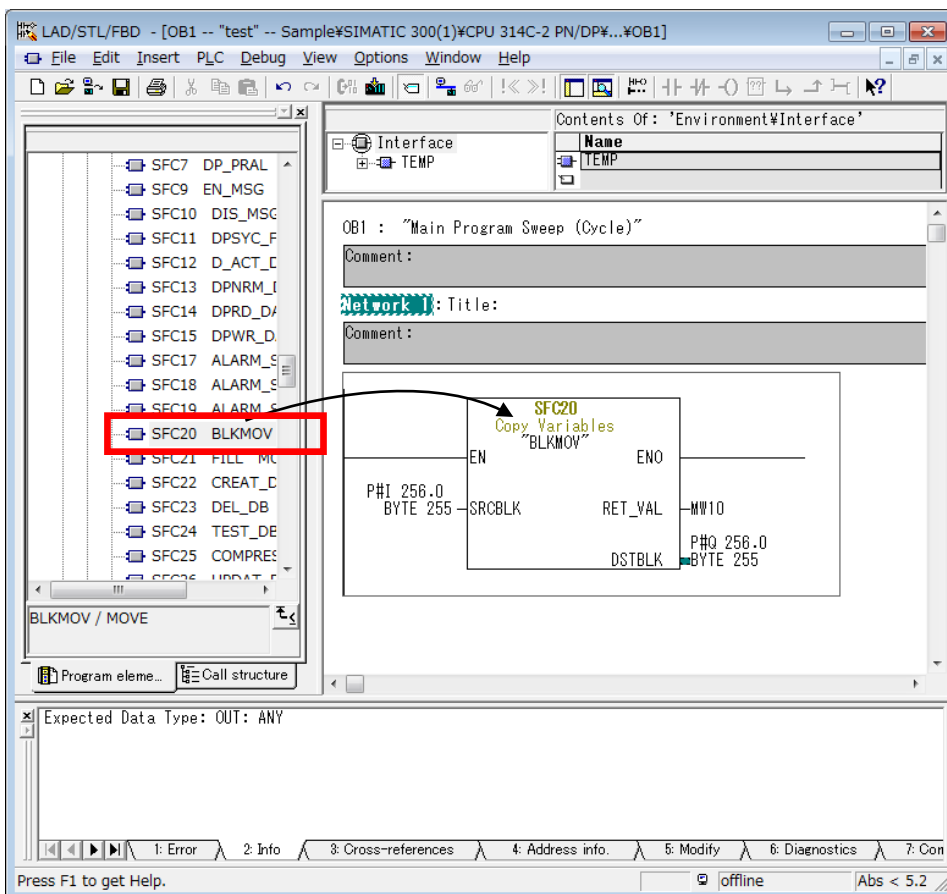
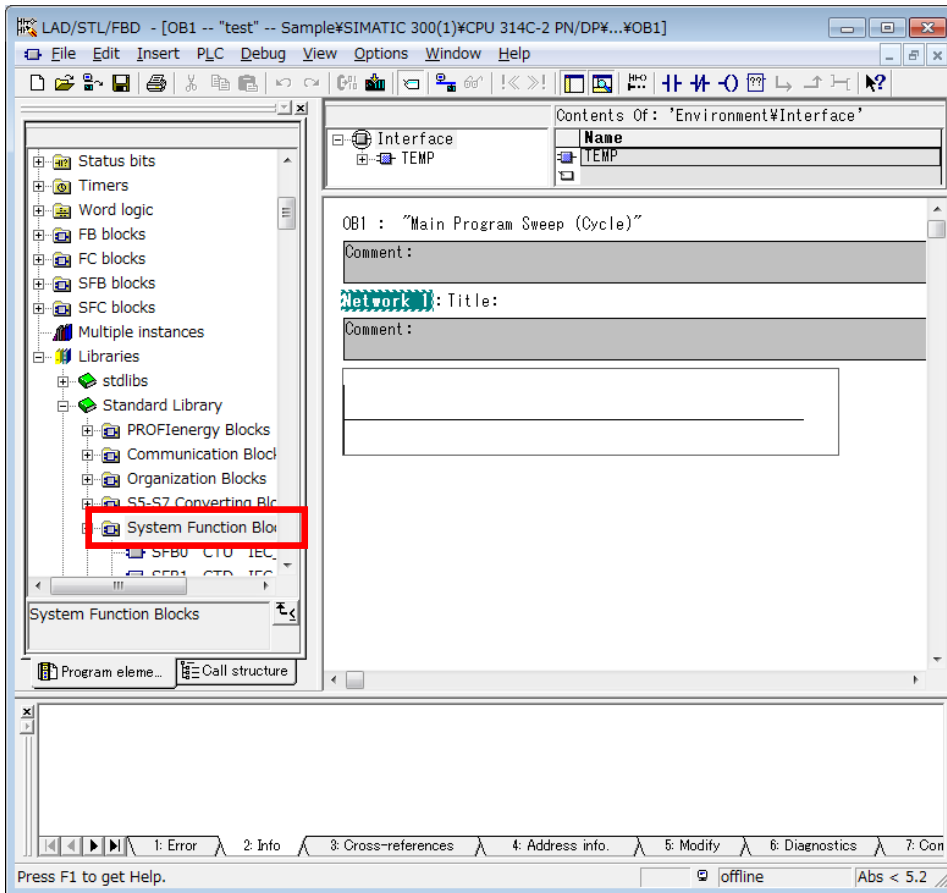

9 Procedures for Starting Operation

Specify the following content in the displayed "SFC20 block".

- [SRCBLK]:"P#I256.0 BYTE 255"
- [DSTBLK]:"P#Q256.0 BYTE 255"
- RET_VAL: Arbitrary variable (for instance, "MW10")

This program returns the signal that the robot output to the input signal of the robot as it is.

OB1 : "Main Program Sweep (Cycle)"

Comment :

Network 1: Title:

Comment :

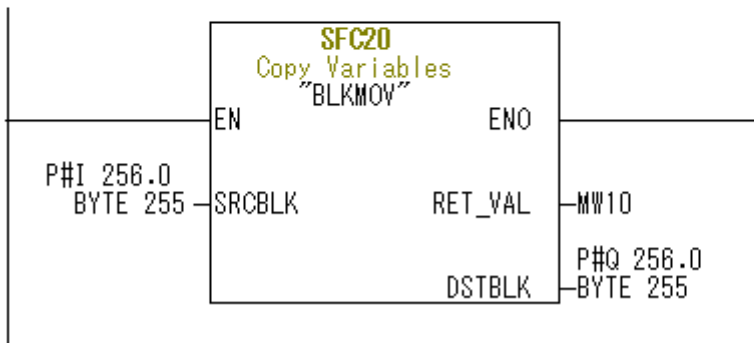

- (7) Specify the Ethernet card of the personal computer to make PLC communicated with the personal computer.

Click [Options] – [Configure Network] from the menu on "HW Config" screen.

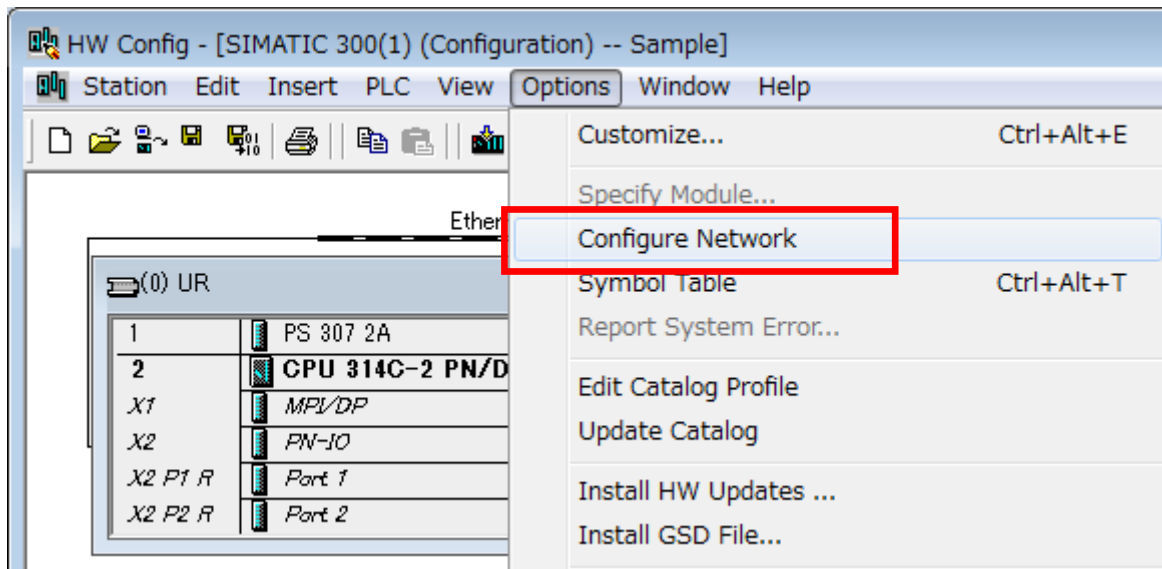

Click [Options] – [Set PG/PC Interface] from the menu on the displayed "NetPro" screen.

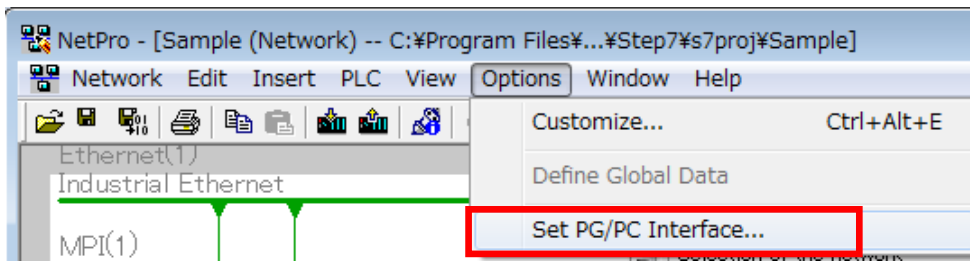

Select the Ethernet card of the personal computer that connects PLC with Hub, and click [OK] button.

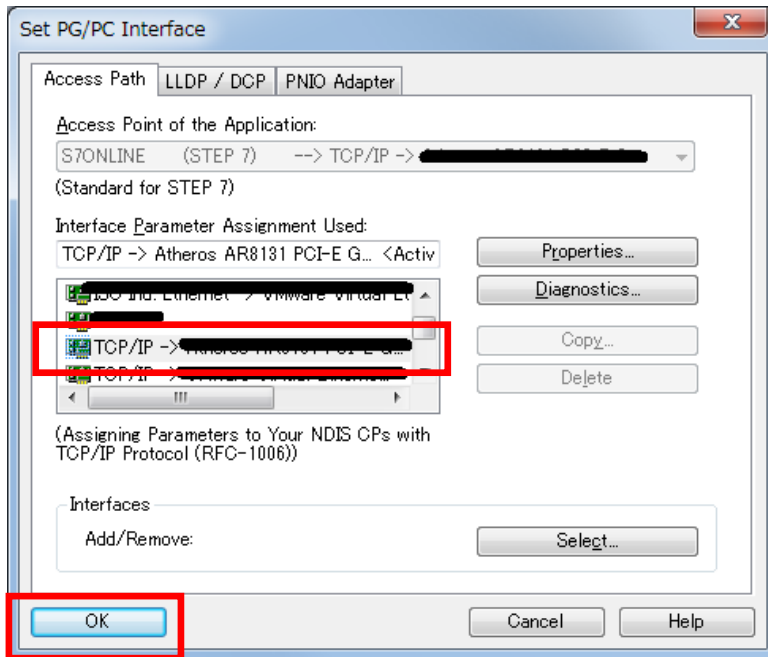

(8) Set information on Internet Protocol address etc. of PLC and the robot (for TZ535-PN).

Click [PLC] – [Ethernet] – [Edit Ethernet Node] from the menu on "HW Config" screen.

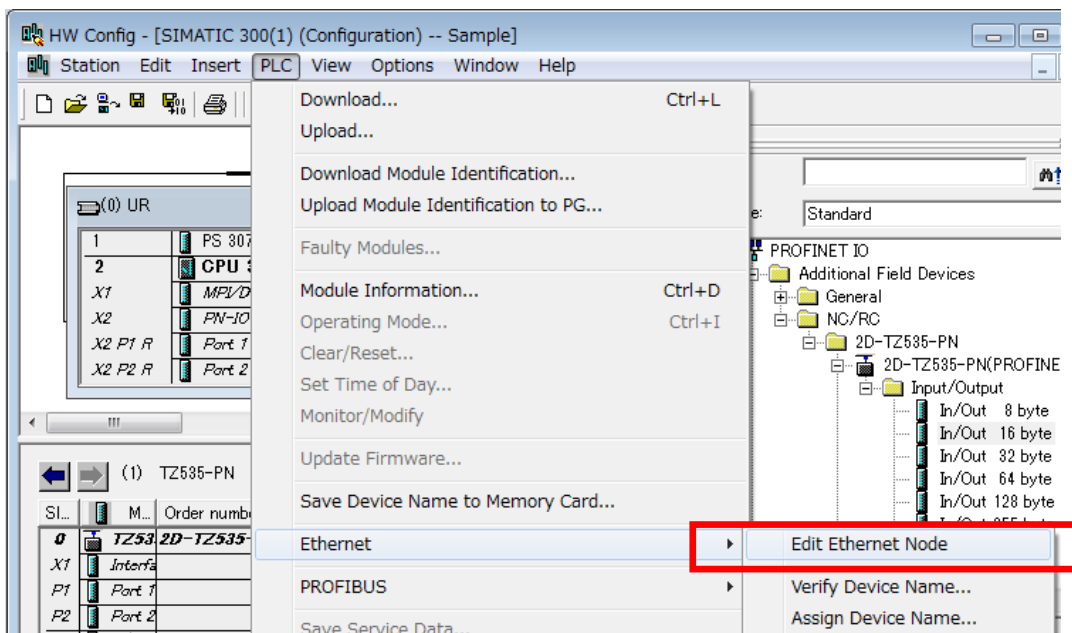

Click [Browse] button on the displayed "Edit Ethernet Node" screen.

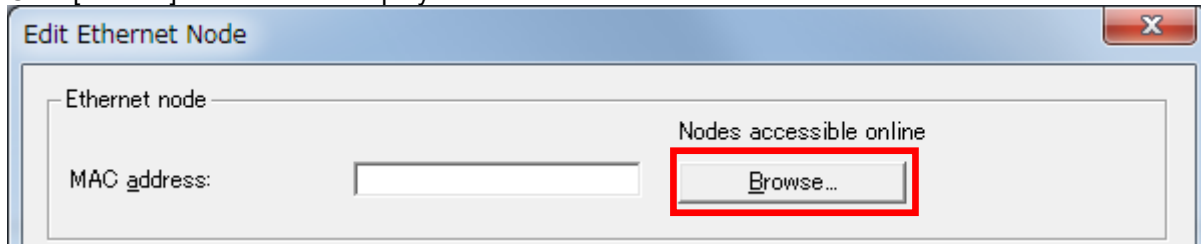

Select the node that corresponds to TZ535-PN. And, click [OK] button.

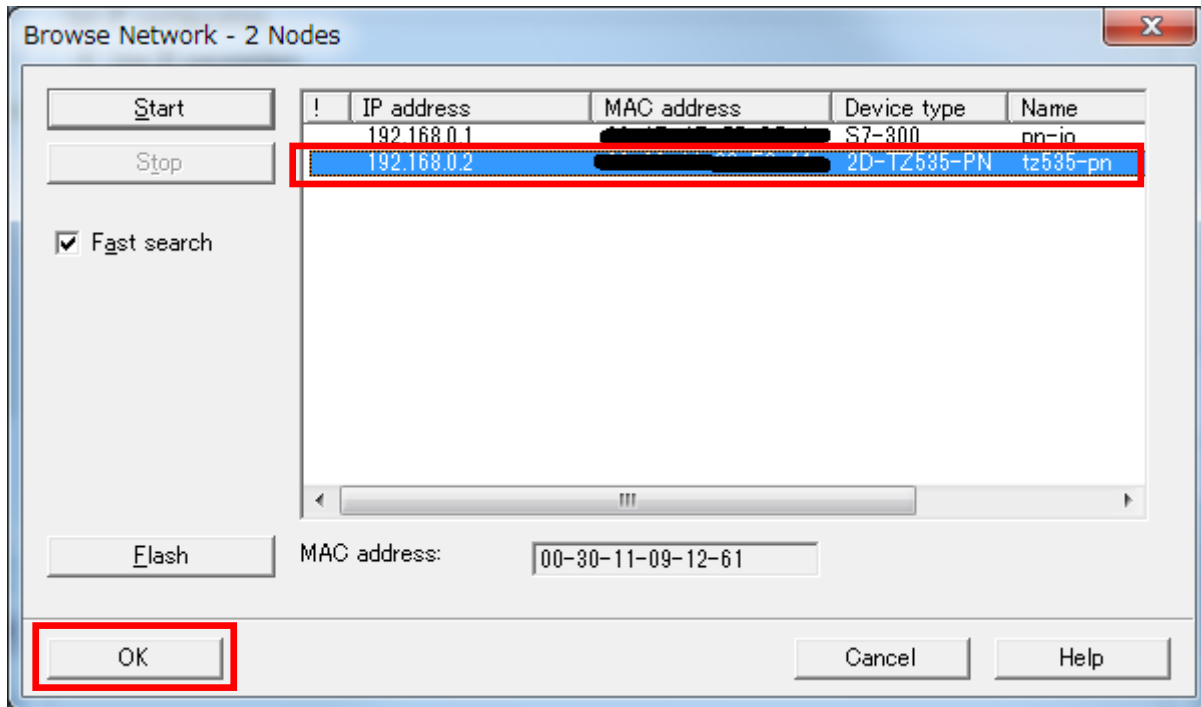

Click the [Assign IP Configuration] button after inputting the “IP address” and “Subnet mask”.
Click the [Assign Name] button after Inputting the “Device name”.

The screenshot shows the 'Edit Ethernet Node' dialog box. The 'Set IP configuration' section is active, with 'Use IP parameters' selected. The 'IP address' field contains '192.168.0.2' and the 'Subnet mask' field contains '255.255.255.0'. The 'Assign IP Configuration' button is highlighted with a red box. The 'Assign device name' section shows the 'Device name' field containing 'tz535-pn' and the 'Assign Name' button highlighted with a red box. Other sections include 'Ethernet node' with a MAC address field and 'Reset to factory settings' with a 'Reset' button.

Similarly, set “IP address” and “Subnet mask” etc. of PLC.

The screenshot shows the 'Edit Ethernet Node' dialog box. The 'Set IP configuration' section is active, with 'Use IP parameters' selected. The 'IP address' field contains '192.168.0.1' and the 'Subnet mask' field contains '255.255.255.0'. The 'Assign IP Configuration' button is highlighted with a red box. The 'Assign device name' section shows the 'Device name' field containing 'pn-io' and the 'Assign Name' button highlighted with a red box. Other sections include 'Ethernet node' with a MAC address field and 'Reset to factory settings' with a 'Reset' button.

(9) Download the set content to PLC.

Click [PLC] – [Download] from the menu on "HW Config" screen.

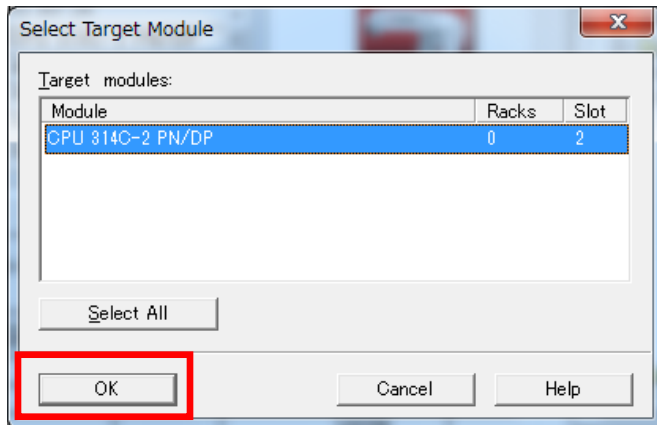
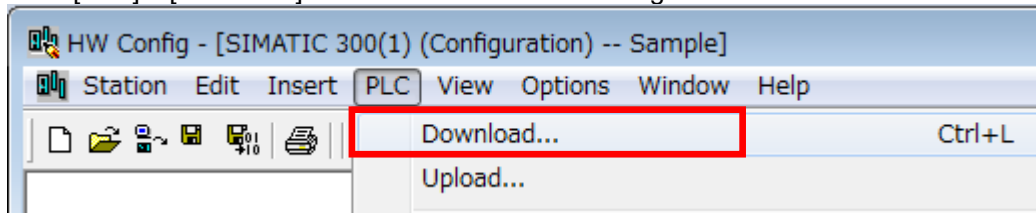

Select corresponding PLC and click [OK] button.

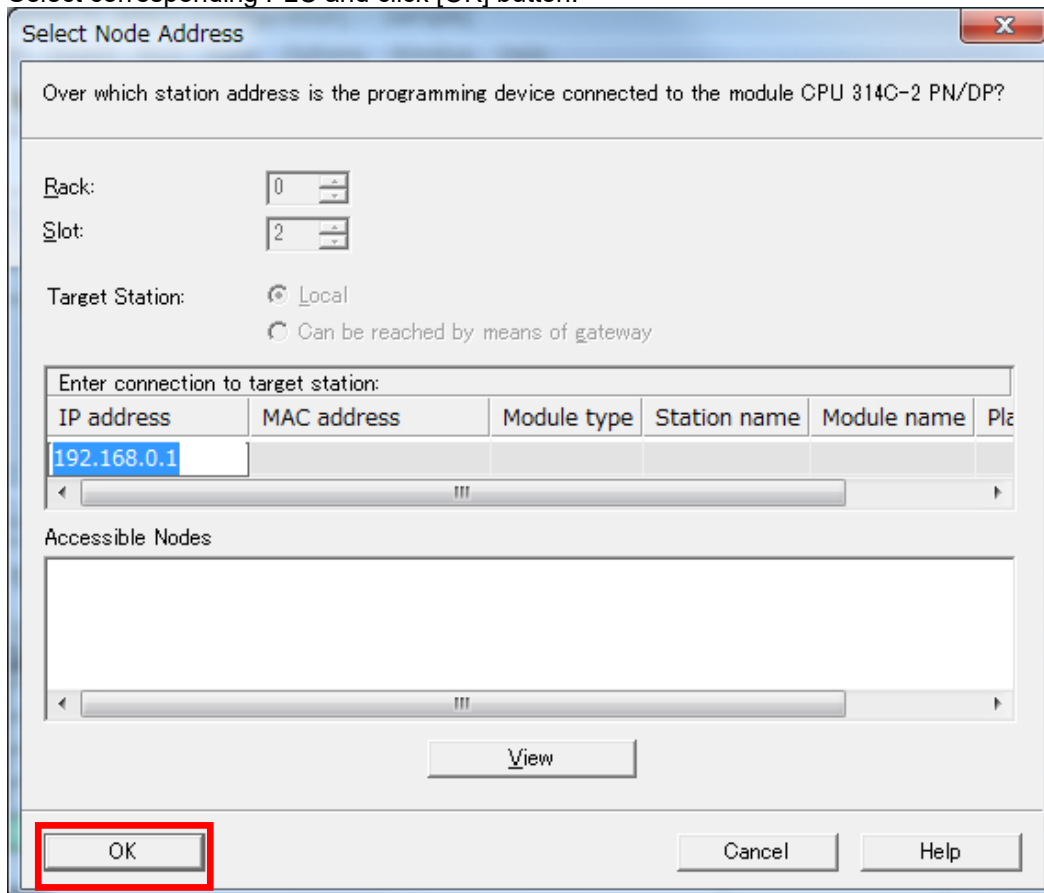

(10) Confirm the value of robot controller's parameter "PNIOLN".

Confirm the value of parameter "PNIOLN" by turning on robot controller's power supply, and using RT ToolBox2/RT ToolBox3.

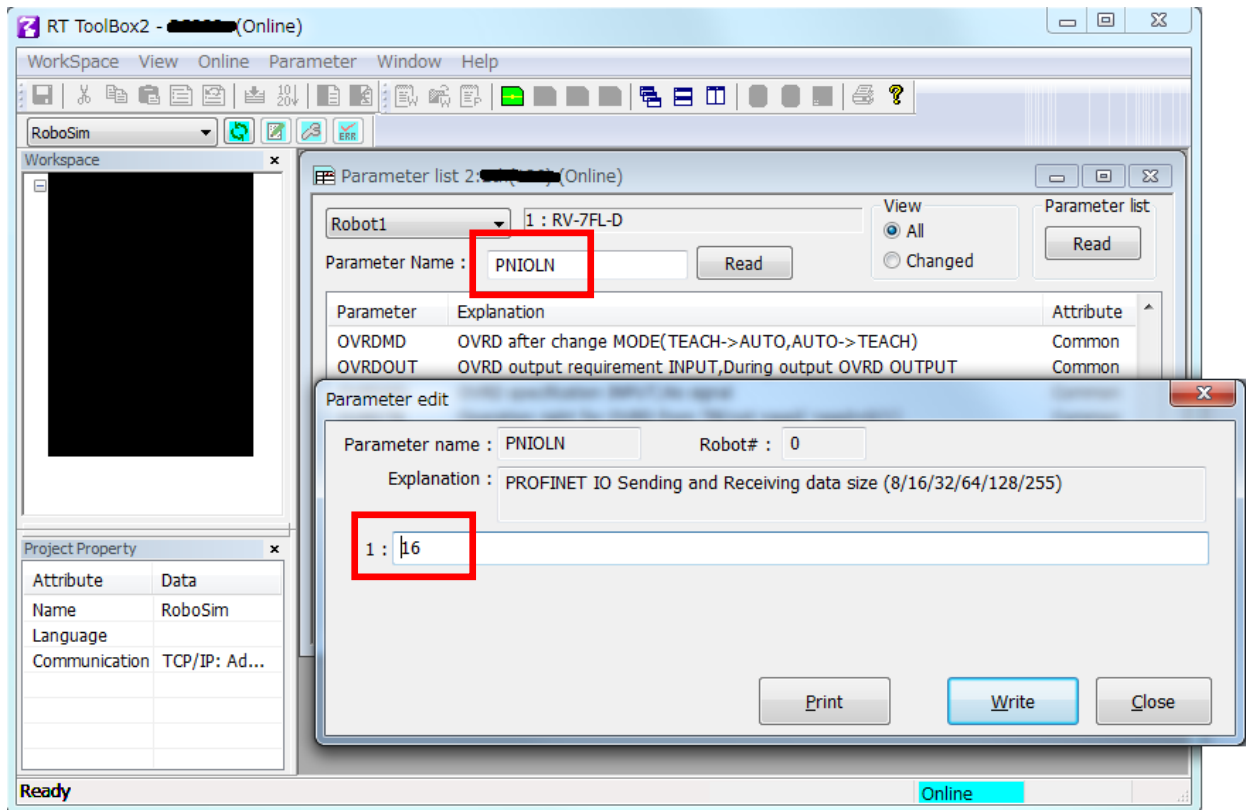
**(11)** Confirm LED on PLC.

Change the switch of Siemens PLC from [STOP] to [RUN].
Confirm turning off LED SF, BF1, and BF2 on PLC.

The error occurs when LED lights red.
Please correspond according to the content of the error.

9.2. Checking the I/O Signals



9.2.1. For the EtherNet/IP module

Check the exchange of I/O signals using RT ToolBox2/RT ToolBox3 and the RSLogix5000 "Controller Tags" screen.

- (1) Start the RT ToolBox2/RT ToolBox3 "General purpose Signal" monitor.

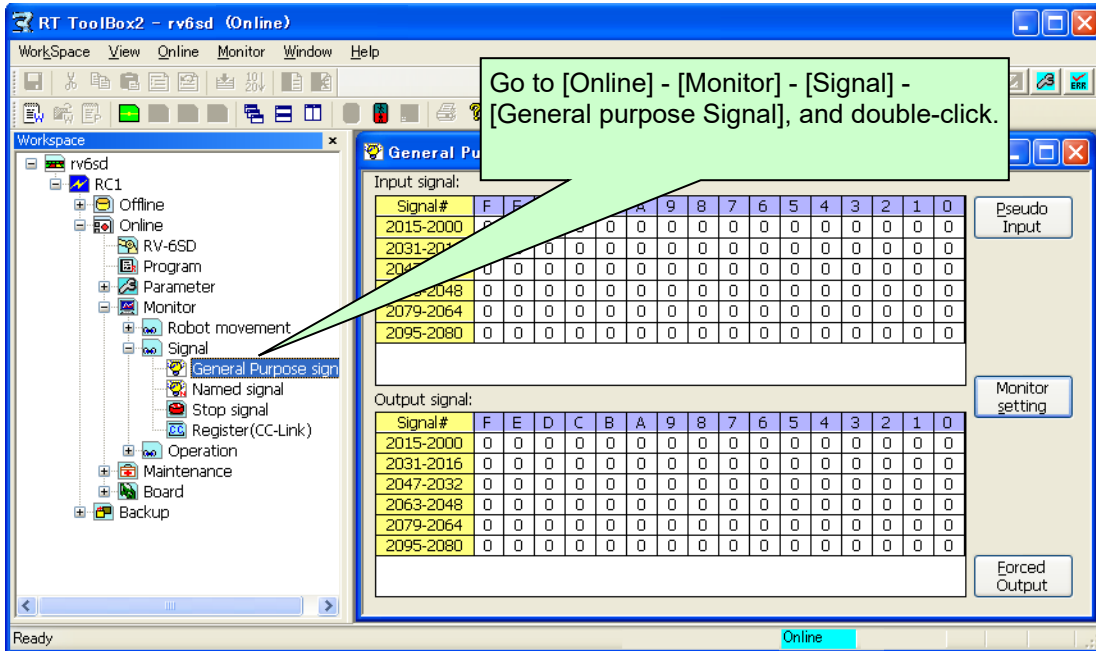

- (2) Open the RSLogix5000 "Controller Tags" screen.

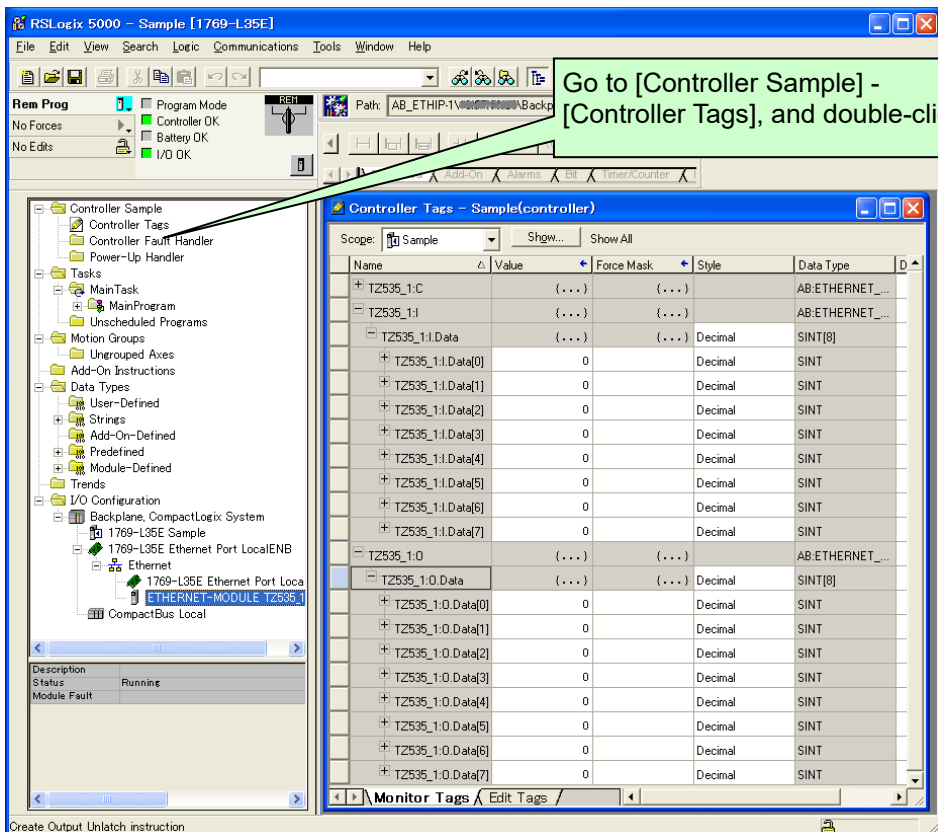

- (3) Click [Bit Forced Output] button on the RT ToolBox2/RT ToolBox3 "General-purpose OUTPUT signal" monitor, and test a random output.

(2) Select random signals, and click [Bit Forced Output] button.

(3) Confirm that robot output is input into master PLC.

(1) Click [Forced Output] button.

- (4) On the RSLogix5000 "Controller Tags" screen, execute a random output and confirm the input on the RT ToolBox2/RT ToolBox3 general-purpose monitor.

(1) Input random data in TZ535_1:0.

(2) Confirm that the robot input is the data designated from the master PLC.

PROFINET IO

9.2.2. For the PROFINET IO 2-Port module

Check the exchange of I/O signals using RT ToolBox2/RT ToolBox3 and the "screen on SIMATIC Manager.

- (1) Start the RT ToolBox2/RT ToolBox3 "General purpose Signal" monitor.

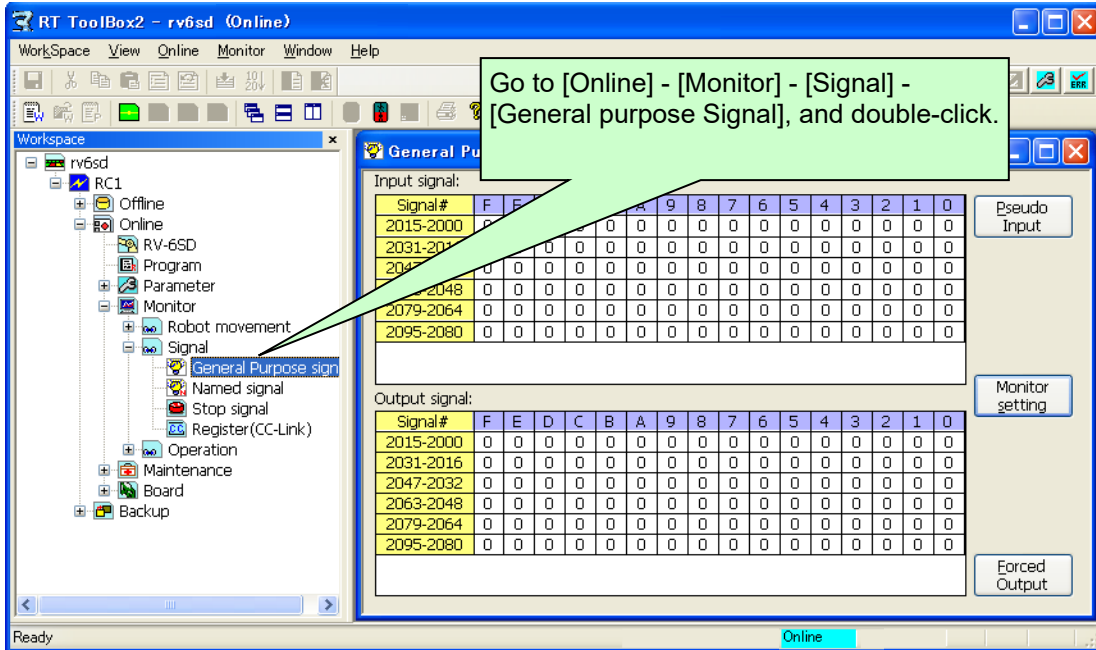

- (2) Click the [TZ535-PN] on "HW Config" screen.

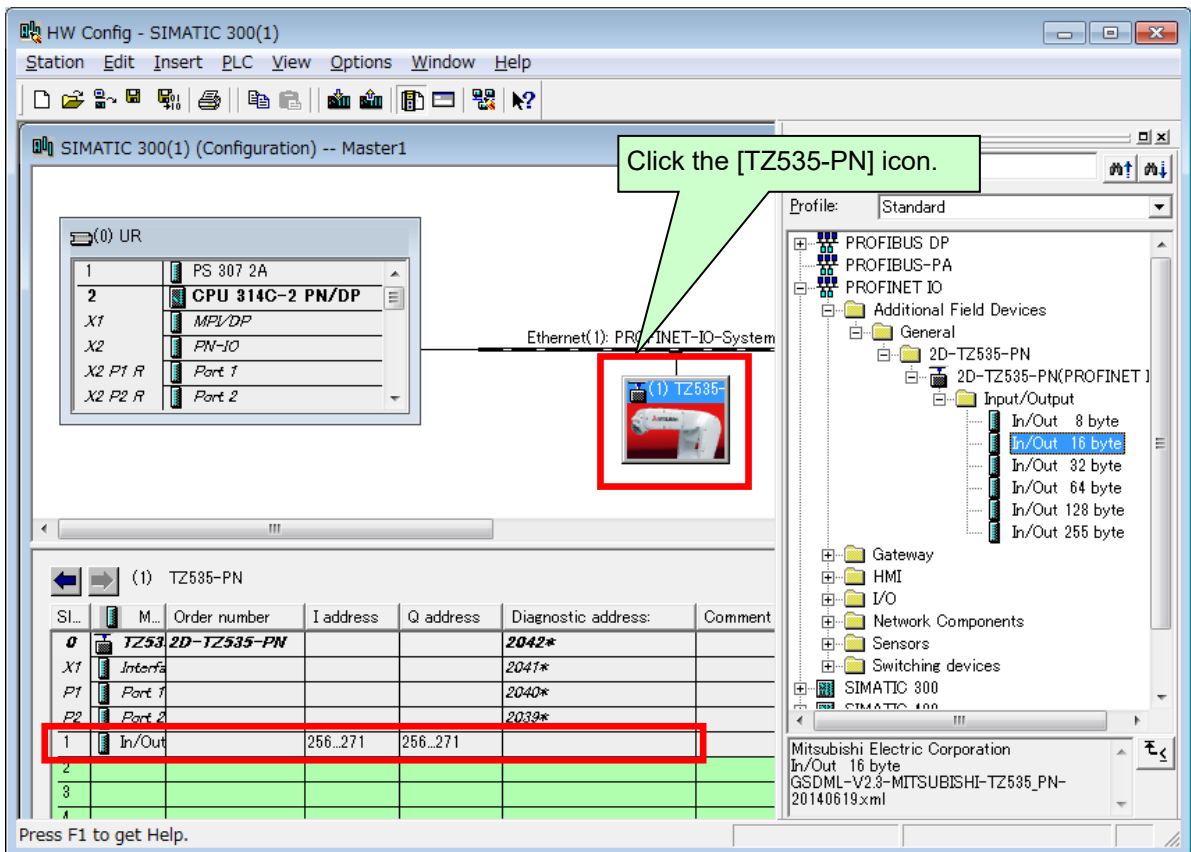

- (3) Right-click in "In/Out **byte" of slot 1, and click [Monitor/Modify] button.

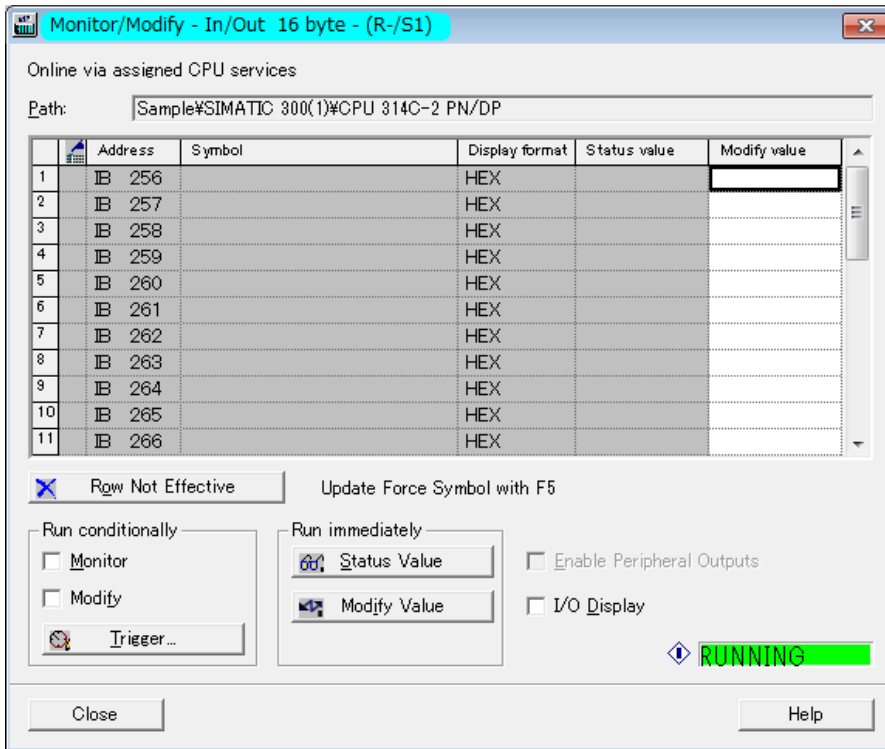

- (4) Click [Bit Forced Output] button on the RT ToolBox2/RT ToolBox3 "General-purpose OUTPUT signal" monitor, and test a random output.

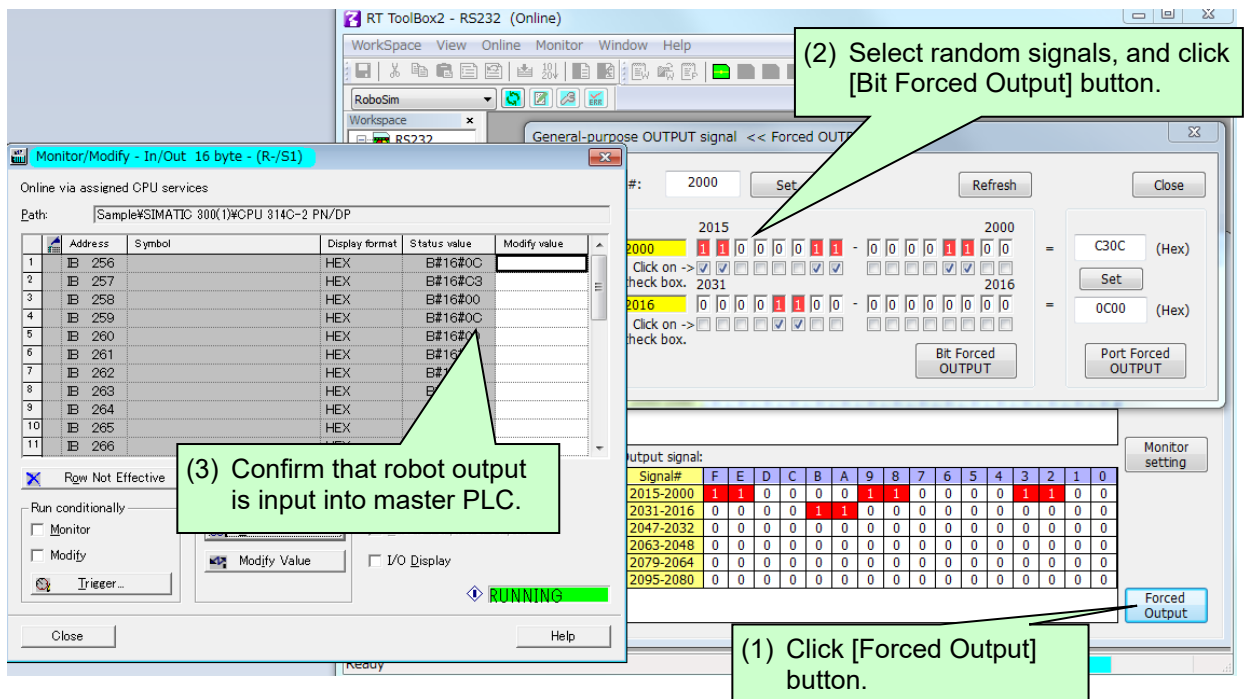

- (5) Confirm the output signal has returned to the input as it is on the RT ToolBox2/RT ToolBox3 general-purpose monitor.

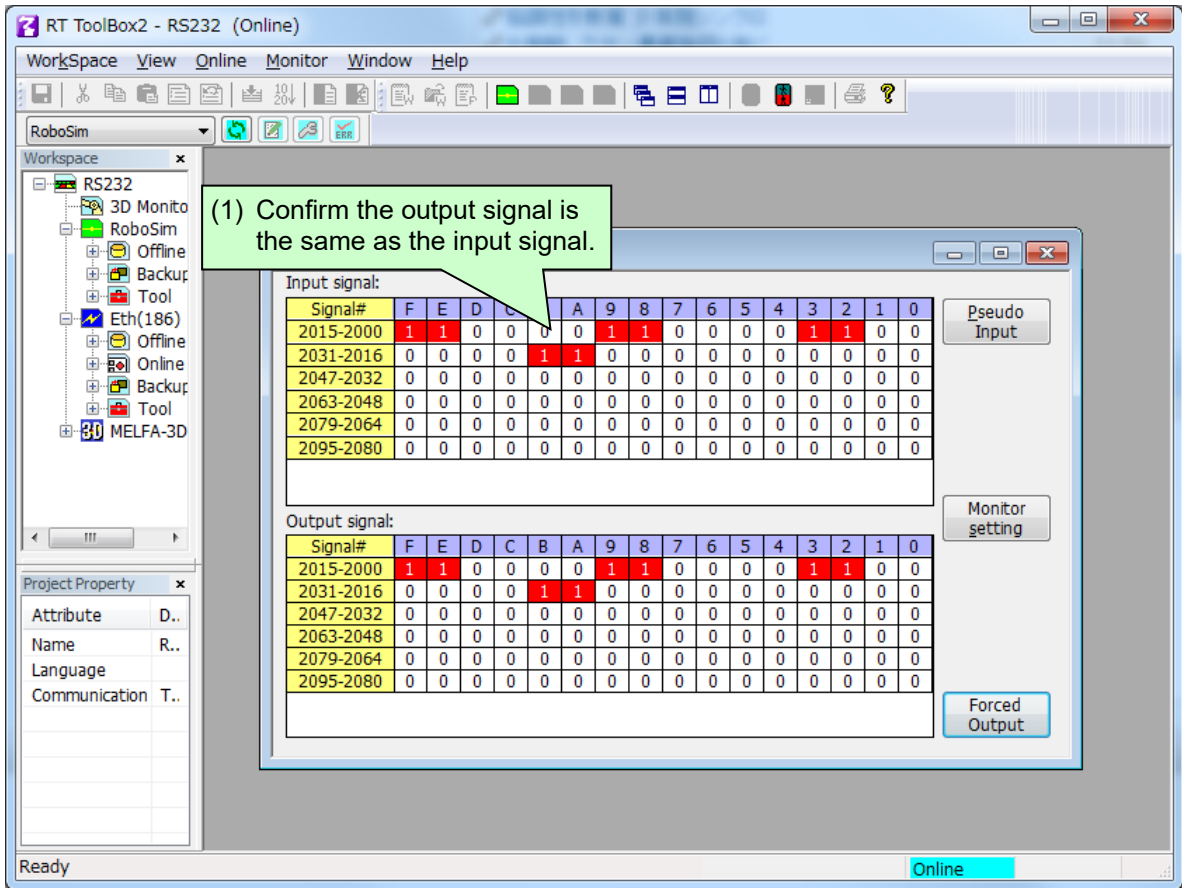

9.3. Execution of robot program

In this chapter shows examples of using the Ethernet/IP, but the PROFINET IO is also the same.

9.3.1. Setting the dedicated input/output

Set the dedicated input/output as shown below. After changing the parameters, turn the power OFF and ON once.

Refer to the separate "Instruction Manual, Detailed Explanation of Functions and Operations" for details on the settings.

Table 9-1 Setting the dedicated input/output

Parameter name	Input		Output	
	Meaning	No.	Meaning	No.
IOENA	Operation rights enable	2000	Operation rights enabled	2000
START	Program start	2001	Program starting	2001
STOP2	Stop	2002	Stopping	2002
SLOTINIT	Program reset	2003	Program selection enabled	2003
SRVON	Servo power ON	2004	Servo ON	2004
SRVOFF	Servo power OFF	2005		

9.3.2. General-purpose input/output

The general-purpose inputs and outputs can be accessed with the I/O system variables such as M_In and M_Out.

Note that when accessing multiple bits with a variable such as M_Inb, M_Inw, M_Outb or M_Outw, the access cannot extend over an area used by EtherNet/IP, such as the number 1999. Always create the program to fit within the area between 2000 and 4047.

Correct example) M_In(2000), M_Inb(2010), M_Out(3000), M_Outb(3010), etc.

Incorrect example) M_Inb(1999), M_Inw(5070), M_Outb(1999), M_Outw(1999), etc.

9.3.3. Example of robot program creation (using general-purpose input/output)

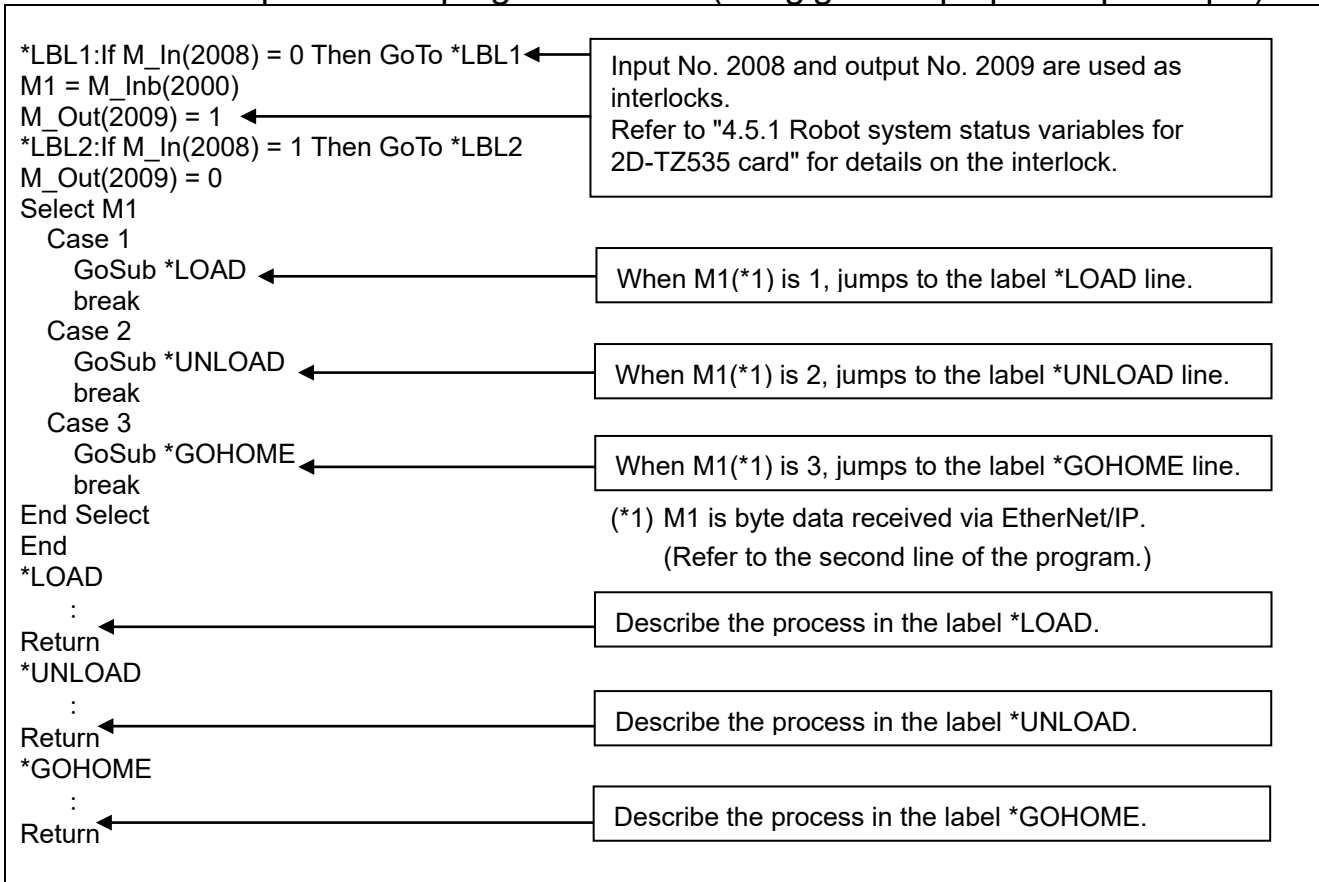

9.3.4. Sample program for input/output confirmation

A sample program for confirming the 2D-TZ535 card input/output is shown below.
Use this as necessary for startup adjustment, etc.

Table 9-2 Signal assignment conditions

Robot side input (master station output)	Input 2000 to 4047 (256 bytes)
Robot side output (master station input)	Output 2000 to 4047 (256 bytes)

Robot program specifications

Copy all input bits to the output bits.

```
[Program example 1]
'Loop the input signal to the robot back to the output signal. (For bit checking)
For M1 = 2000 To 4047
  M_Out(M1) = M_In(M1) 'Copy with bit variable
Next M1
End

[Program example 2]
'Loop the input signal to the robot back to the output signal. (For byte checking)
For M1 = 2000 To 4040 Step 8
  M_Outb(M1) = M_Inb(M1) 'Copy with byte variable
Next M1
End

[Program example 3]
'Loop the input signal to the robot back to the output signal. (For word checking)
For M1 = 2000 To 4032 Step 16
  M_Outw(M1) = M_Inw(M1) 'Copy with word variable
Next M1
End
```

Execute this program and check the signals looped back to the master station side.

10. Troubleshooting

Please read this chapter first if you suspect that some failure has occurred.

10.1. List of Errors

◆◆ The meanings of the error numbers are shown below. ◆◆

□ 0000 *

- An error marked with an asterisk (*) requires power resetting. Perform the actions indicated in the countermeasures.
- The error type is shown with a 4-digit number.
- The errors are categorized into three types.
 - H: High-level error Servo-OFF is performed.
 - L: Low-level error Operation stops.
 - C: Warning Operation continues.

Table 10-1 List of errors related to the network base card

Error No.	Error cause and measures	
H.6100	Error message	Module is not mounted.
	Cause	A module board by HMS must be mounted in the network base card. A module board is not mounted in the network base card.
	Measures	Mount a module suitable for the network base card.
H.6101	Error message	Unsupported module mounted error
	Cause	An unsupported HMS module board is mounted in the network base card.
	Measures	Replace the module.
H.6110	Error message	Multiple network base cards are mounted.
	Cause	Only one network base card can be mounted. Two or more are currently mounted in the option slot.
	Measures	Mount only one network base card.
H.6111	Error message	Another fieldbus card is mounted.
	Cause	Only one fieldbus card can be mounted. A CC-Link card, PROFIBUS card or DeviceNet card is mounted.
	Measures	Mount only one fieldbus card.
H.6120	Error message	Network base card error n. (n is a number between 1 and 4.)
	Cause	A network base card error has been detected. n=1: A watch dog timeout has occurred with the communication module. n=2: An unsupported object, instance or command has been issued. n=3: The received form is incorrect. n=4: The I/O offset amount is incorrect. n=5: IP address is incorrect. n=6: Subnet mask IP address is incorrect. n=7: Gateway IP address is incorrect.
	Measures	Replace the network base card. Contact the manufacturer when replacing the card.

Error No.	Error cause and measures	
L.6130	Error message	Network communication error n. (n is a number between 1 and 2.)
	Cause	Line error or invalid parameter. This can occur if communication is not established when: (1) The robot program is started, (2) Continuous operation is attempted with direct execution from the RT ToolBox2, or (3) An execution program is started while an error is occurring. n=1: Ethernet cable is disconnected. n=2: IP address is not established.
	Measures	Check the cable and parameters.
H.6140	Error message	Parameter error (parameter name)
	Cause	The parameter setting is invalid. The parameter value is not within range, or the data is invalid and cannot be read.
	Measures	Check the parameter setting value.
L.6190	Error message	Network error occurrence (error code)
	Cause	A network error has occurred. (Error code) indicates an error code which occurs between the Anybus-CC Module.
	Measures	Check the details of the network error.

11. Appendix

11.1. Displaying the Option Card Information

The option card information can be displayed with the RT ToolBox2 /RT ToolBox3 (option). In the online state, click "Online" in the work space tree, and click "Slot n (n=1 to 3): Network Base" under "Board". The 2D-TZ535 card information will be read into the properties window.

* The option card information in the properties window is not updated automatically. To update the information, go offline and then online and repeat the above steps.

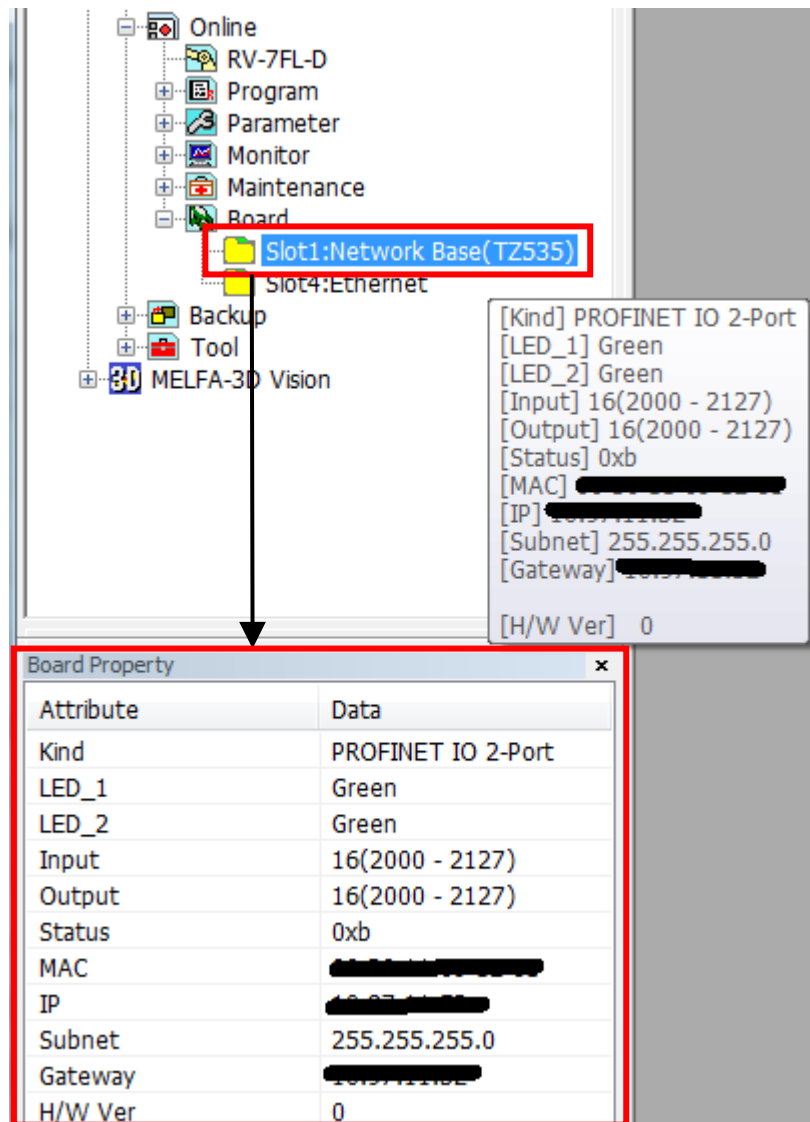

Figure 11-1 Example of displaying option card information with RT ToolBox2

EtherNet/IP

11.1.1. For the EtherNet/IP module

Table 11-1 2D-TZ535 card information(For EtherNet/IP module)

Display item	Display example	Meaning	Remarks
Card name	Network Base (TZ535)	Card name	
[Kind]	EtherNet/IP	Name of Anybus-CC module on network base card	
[LED_1]	Green	Module Status LED status	
[LED_2]	Green	Network Status LED status	
[Input]	8 (2000 - 2063)	Number of received bytes (signal number)	1(-) to 256 (2000 - 4047)
[Output]	8 (2000 - 2063)	Number of send bytes (signal number)	1(-) to 256 (2000 - 4047)
[Status]	0003	Network status	bit 0: Linked bit 1: IP address established
[MAC Address]	**_**_*_*_*_*_*_*_*_*	MAC address	
[IP]	***_*_*_*_*_*_*_*_*	IP address	Parameter [EPIP]
[Subnet]	***_*_*_*_*_*_*_*_*	Subnet Mask	Parameter [EPMSK]
[Gateway]	***_*_*_*_*_*_*_*_*	Gateway	Parameter [EPGW]
[H/W Ver]	0	Card group number	0: G51 to 6: G57 7: Use prohibited

PROFINET IO

11.1.2. For the PROFINET IO 2-Port module

Table 11-2 2D-TZ535 card information(For PROFINET IO 2-Port module)

Display item	Display example	Meaning	Remarks
Card name	Network Base (TZ535)	Card name	
[Kind]	PROFINET IO 2-Port	Name of Anybus-CC module on network base card	
[LED_1]	Green	Module Status LED status	
[LED_2]	Green	Network Status LED status	
[Input]	16 (2000 - 2127)	Number of received bytes (signal number)	8 / 16 / 32 / 64 / 128 / 255
[Output]	16 (2000 - 2127)	Number of send bytes (signal number)	8 / 16 / 32 / 64 / 128 / 255
[Status]	0003	Network status	bit 0: Linked bit 1: IP address established bit 3: Link port1 bit 4: Link port2
[MAC Address]	**_**_*_*_*_*_*_*_*_*	MAC address	
[IP]	***_*_*_*_*_*_*_*_*	IP address	Set address from PLC
[Subnet]	***_*_*_*_*_*_*_*_*	Subnet Mask	Set address from PLC
[Gateway]	***_*_*_*_*_*_*_*_*	Gateway	Set address from PLC
[H/W Ver]	0	Card group number	0: G51 to 6: G57 7: Use prohibited

11.2. Pseudo-input Function

The pseudo-input function for the EtherNet/IP network base card allows the pseudo input signals from RT ToolBox2/RT ToolBox3.

Usable cases and usage methods are explained below.

No.	Network base card (TZ535) status	Condition	Usability
1	Mounted	Not mounted	×
2		Network cable not connected	●
3		Network cable connected, but a communication error occurring	●
4		In normal communication	●

● indicates usable, and × indicates not usable.

* A pseudo-input is not possible while an error is occurring.

<Usage method>

- (1) Start RT ToolBox2/RT ToolBox3.
- (2) Click [Online] - [Monitor] - [Signal Monitor] - [General Signals] in the work space tree, and start the general-purpose signal monitor.

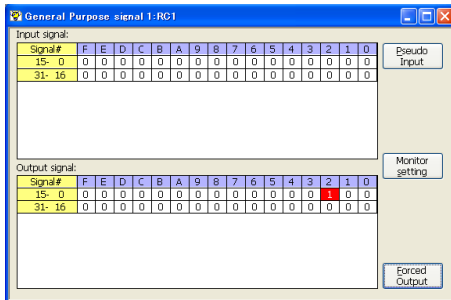

- (3) Click the [Pseudo-input] button.

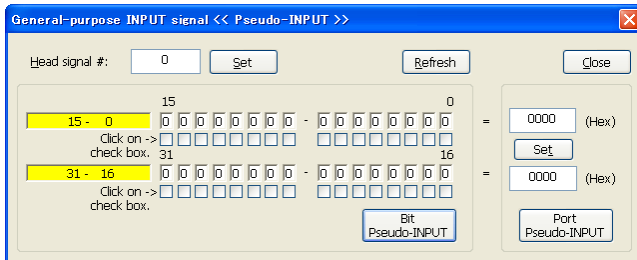

- (4) Input the signal number (2000 or higher) in the "Head signal #" field and click the [Set] button.
- (5) Select the check box for the signal to be input, and click the [Bit pseudo INPUT] button.

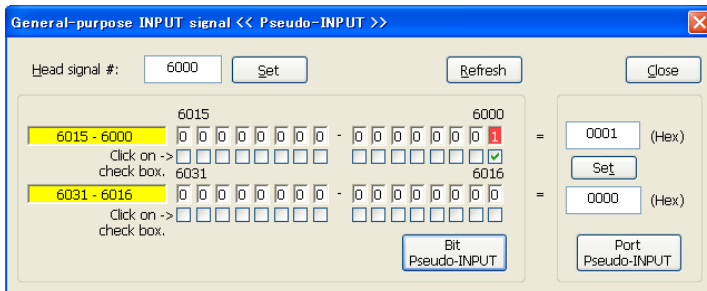

mitsubishi electric corporation

HEAD OFFICE: TOKYO BLDG., 2-7-3, MARUNOUCHI, CHIYODA-KU, TOKYO 100-8310, JAPAN
NAGOYA WORKS: 1-14, YADA-MINAMI 5-CHOME, HIGASHI-KU, NAGOYA 461-8670, JAPAN