

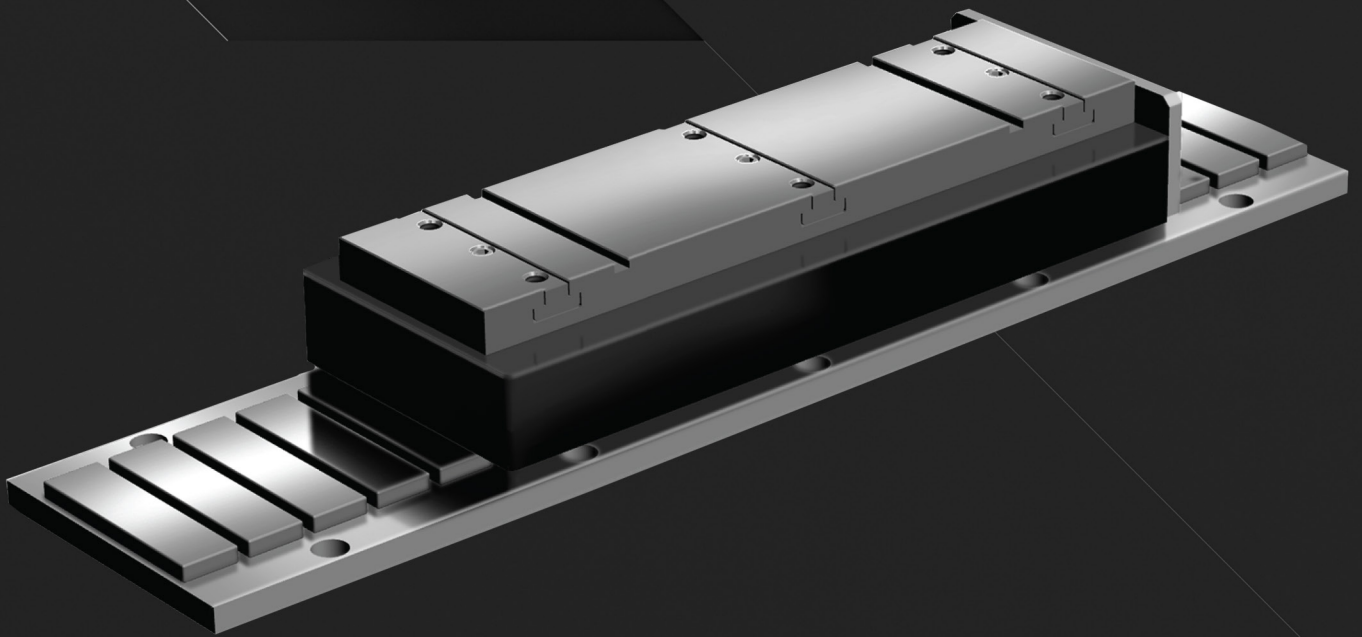

DIRECT DRIVE TECHNOLOGY
Product Catalogue
VERSION 4.1



PIX SERIES
IRONCORE LINEAR MOTOR

- PLAY VIDEO -



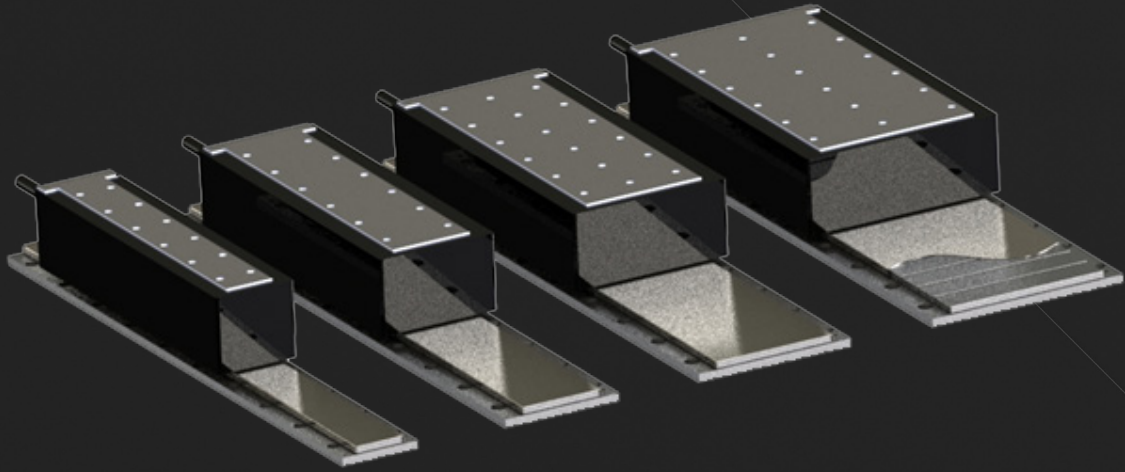

PIX150B SERIES
IRONCORE LINEAR MOTOR

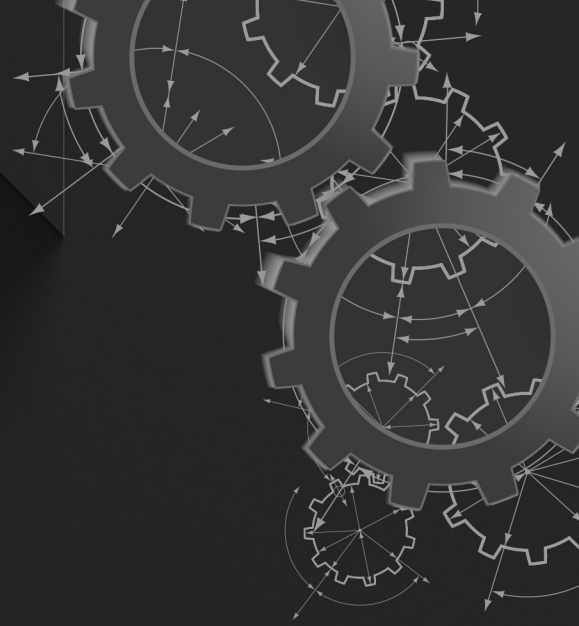

PIX150B SERIES

IRONCORE LINEAR MOTOR

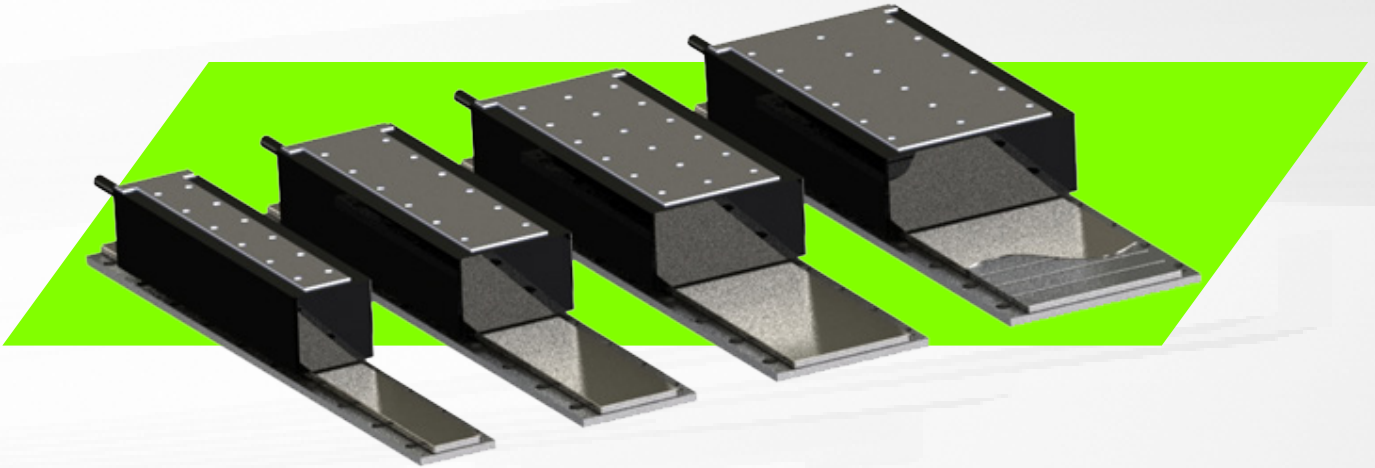

PIX B Iron core motors offer an affordable high force solution to demanding linear applications with an anti-cogging effect that is associated with traditional iron core linear motors.

Our Ironcore is designed for optimal dissipation of heat and thus capable of extremely high forces. These motor coils are manufactured with high flex cables and optional external hall effect attachments widely used in multiple general automation applications.

Modular Flat Magnet tracks are available in different length increments to complete this product selection and allow for easy assembly of un-restricted effective stroke by butting tracks of different lengths together.

- High Power Density
- Anti-cogging design for smooth operation
- Efficient cooling system
- Modular hall sensor
- High speed, acceleration and fast response
- High Synchronous run
- Zero backlash - direct drive technology
- Maintenance-free operation - mechanical simplicity due to reduced component count
- Long travels without performance loss

APPLICATION

- Material Transfer/Pick and place
- Packaging
- Semiconductor Machine
- Photovoltaic
- Laser Cutting
- Lithium battery production
- Machine Tools
- Large format printing
- Glass and LCD transfer

**Technical specifications subject to change without prior notice*

PART NUMBERING SYSTEM

32

PIX150B - 050

33

PIX150B - 075

36

PIX150B - 100

39

PIX150B - 125

42

Motor Model	Coil Size	Continuous Force (N)	Peak Force (N)	Continuous Current (A ^{PH})	Peak Current (A ^{PH})	Coil Weight (Kg)	Motor Dimensions without Hall Sensor LxWxH (mm)	Motor Dimensions with Hall Sensor LxWxH (mm)
PIX150B-050	C1	35	121	3.3	12.7	0.35	58 x 50 x 34.3	87 x 50 x 34.3
	C2	69	242	3.3	12.7	0.6	100 x 50 x 34.3	129 x 50 x 34.3
	C3	104	363	3.3	12.7	0.9	142 x 50 x 34.3	171 x 50 x 34.3
	C4	139	484	6.5	25.4	1.1	184 x 50 x 34.3	213 x 50 x 34.3
PIX150B-075	C1	59	208	3.3	12.7	0.5	58 x 75 x 34.3	87 x 75 x 34.3
	C2	119	416	3.3	12.7	0.9	100 x 75 x 34.3	129 x 75 x 34.3
	C3	178	624	3.3	12.7	1.3	142 x 75 x 34.3	171 x 75 x 34.3
	C4	238	832	6.5	25.4	1.6	184 x 75 x 34.3	213 x 75 x 34.3
	C6	357	1248	9.8	38.2	2.4	268 x 75 x 34.3	297 x 75 x 34.3
PIX150B-100	C1	89	310	3.3	12.7	0.7	58 x 100 x 34.3	87 x 100 x 34.3
	C2	177	620	3.3	12.7	1.2	100 x 100 x 34.3	129 x 100 x 34.3
	C3	266	930	3.3	12.7	1.8	142 x 100 x 34.3	171 x 100 x 34.3
	C4	355	1240	6.5	25.4	2.3	184 x 100 x 34.3	213 x 100 x 34.3
	C6	532	1860	9.8	38.2	3.3	268 x 100 x 34.3	297 x 100 x 34.3
PIX150B-125	C1	114	397	3.3	12.7	0.85	58 x 125 x 34.3	87 x 125 x 34.3
	C2	227	794	3.3	12.7	1.5	100 x 125 x 34.3	129 x 125 x 34.3
	C3	341	1191	3.3	12.7	2.1	142 x 125 x 34.3	171 x 125 x 34.3
	C4	454	1588	6.5	25.4	2.8	184 x 125 x 34.3	213 x 125 x 34.3
	C6	681	2382	9.8	38.2	4.0	268 x 125 x 34.3	297 x 125 x 34.3

Note: Continuous force is measured under natural convection, refer to the detail parameters table for more information

DXB/BT
PIX
PSM/PSME
CVC
CVCA
RVCA
PDDR
PCA
PVA
PLA
PDAB
PIAB
OCTO
PRG
LINEAR ENCODER
SERVO AMPLIFIER

Force Chart for PIX150B Linear Motor

Force Chart For PIX150B Motors

PIX150B Product Series

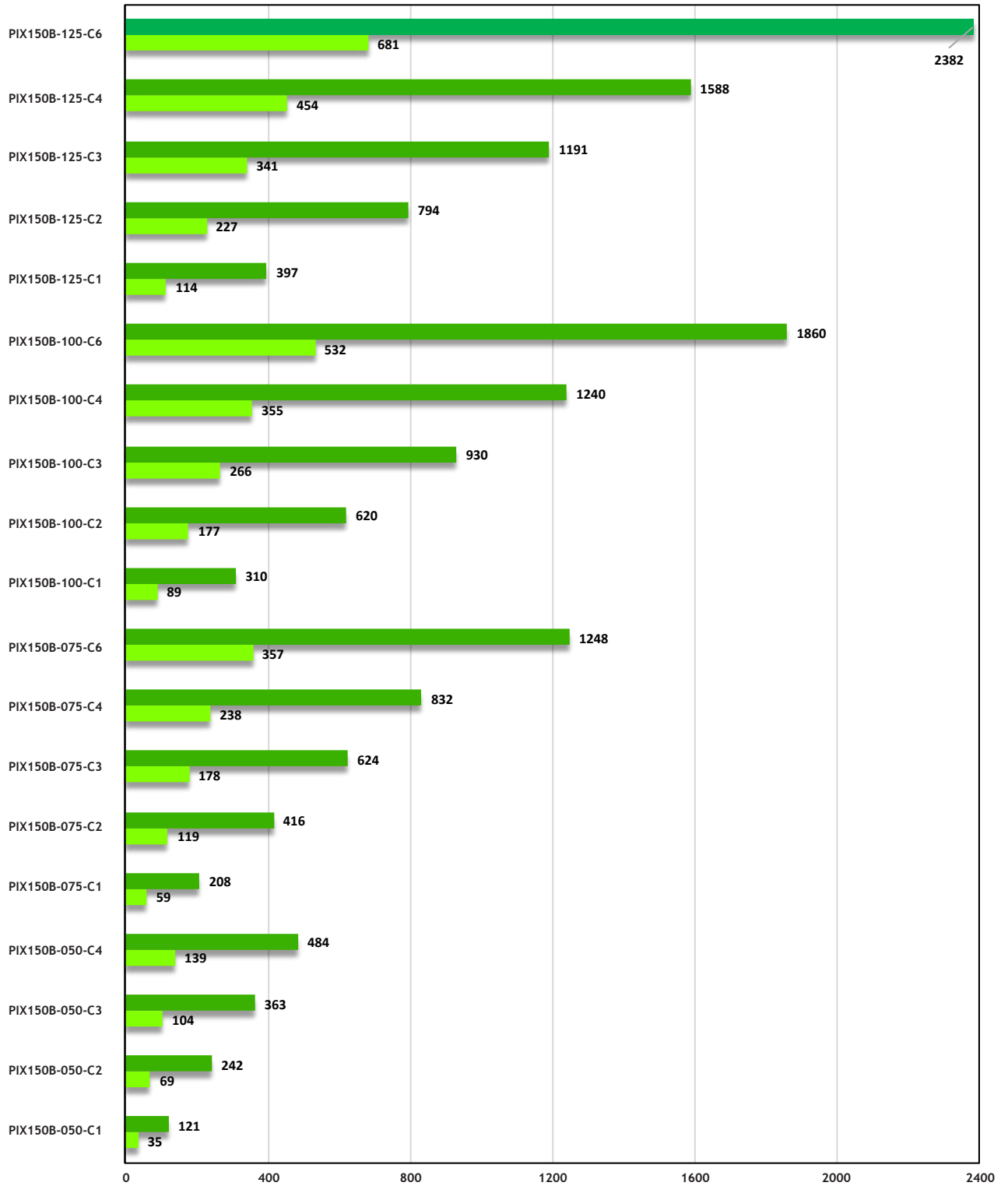

Peak Force Continuous Force

PART NUMBERING SYSTEM

COIL ASSEMBLY



MOTOR MODEL	
PIX150B-050	
PIX150B-075	
PIX150B-100	
PIX150B-125	

MOTOR COIL SIZE	
C1	
C2	
C3	
C4	
C6	

THERMAL PROTECTION	
TC*	PT100 Sensor
TM**	Thermostat

CABLE LENGTH	
0.5	Power and Hall sensor cable

COOLING TYPE	
NC	Normal Convection

DESIGN VERSIONS	
00	Standard
01	Customised Version
:	

HALL SENSOR AND CONNECTOR OPTIONS	
NH	No Hall Sensor
H	Hall Sensor With Flying Leads
HC	Hall Sensor with 9 D sub Male Connector
CHC	Hall Sensor with 5 pins Circular Quick Lock Male Connector
HCL	9 pins D Sub Male Connector with Line Driver

POWER CABLE OPTIONS	
NF	No Ferrite Core (Flying Leads)
9NF	No Ferrite Core, D Sub 9 pins Female Connector
CNF	

* TC - Sensor output to temperature controller
 ** TM - On/Off switch, triggers 100 °C

MAGNET TRACK



MOTOR MODEL	
PIXM150-050	
PIXM150-075	
PIXM150-100	
PIXM150-125	

TRACK LENGTH	
TL084	84mm
TL210	210mm
TL420	420mm

TRACK COVER	
NC	No Cover
C	With Cover

DESIGN VERSIONS	
	Standard
01	Customized Version
:	

DXB/BT
 PIX
 PSM/PSME
 CVC
 CVCA
 RVCA
 PDDR
 PCA
 PWA
 PLA
 PDAB
 PIAB
 OCTO
 PRG
 LINEAR ENCODER
 SERVO AMPLIFIER

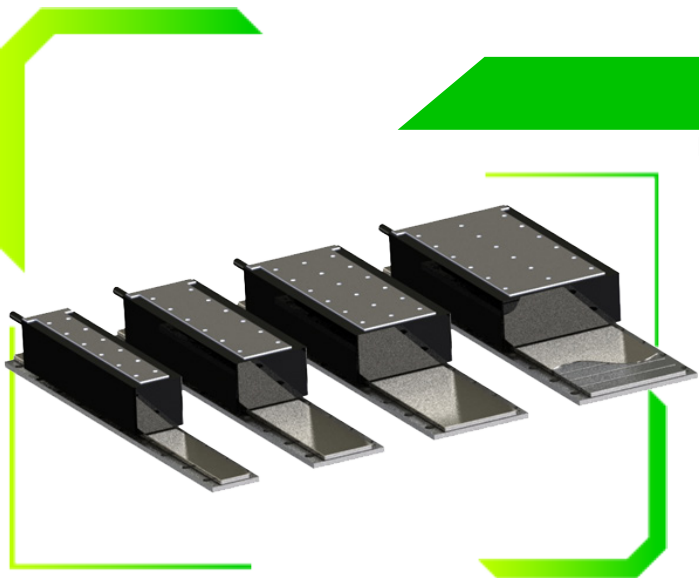

PIX150B SERIES

IRONCORE LINEAR MOTOR

PIX150B - 050

- Peak force up to 484N, Continuous force up to 139N
- Hall Sensor (Optional)

SPECIFICATION		MODEL			
		PIX150B-050-C1	PIX150B-050-C2	PIX150B-050-C3	PIX150B-050-C4
Performance	Unit				
Peak Force	N	121	242	363	484
Continuous Force @ 100°C*	N	35	69	104	139
Continuous Stall Force @ 100°C*	N	24	49	73	98
Peak Power @ 100°C	W	360	721	1081	1442
Continuous Power @ 100°C*	W	24	47	71	94
Electrical					
Peak Current	A ^{pk}	12.7	12.7	12.7	25.4
Continuous Current @ 100°C*	A ^{pk}	3.3	3.3	3.3	6.5
Continuous Stall Current @ 100°C*	Arms	2.3	2.3	2.3	4.6
Force Constant	N/A ^{pk}	10.7	21.3	32.0	21.3
Back EMF Constant	V ^{pk} /m/s	12.3	24.6	36.9	24.6
Coil Resistance L-L @ 25°C	ohm	2.3	4.6	6.8	2.3
Coil Resistance L-L @ 100°C*	ohm	3.0	5.9	8.9	3.0
Inductance L-L @ 1kHz	mH	5.5	11.0	16.5	5.5
Motor Constant @ 25°C*	N//W	8.1	11.5	14.1	16.3
Motor Constant @ 100°C*	N//W	7.1	10.1	12.4	14.3
Max. Terminal Voltage	Vdc	600			
Thermal					
Thermal Resistance @ 100°C*	°C/W	3.18	1.59	1.06	0.80
Max. Winding Temperature	°C	100			
Mechanical					
Coil Weight	kg	0.35	0.6	0.9	1.1
Attractive Force	kN	0.21	0.42	0.63	0.84
Electrical Cycle Length	mm	21			

Notes:

1. $A_{pk} = 1.414 * Arms$; $V_{pk} = 1.414 * V_{rms}$
2. * Ambient temperature 25°C, natural convection, with heat sink of size L x 2W x 12mm. (L = length of coil, W = width of coil)
3. Specifications tolerance : +/-10%
4. Peak force and current : 4% duty ratio and 1 second duration
5. Motor Insulation Class : Class B (130° C)
6. IP Rating : IP00
7. IEC Protection Class : Class 1
8. Compliance Standards : CE, RoHS
9. Ambient Operating Temperature : 0 - 40°C
10. Ambient Operating Humidity : 10 - 90% RH
11. Specifications are subject to change without prior notice.

PIX150B - 050

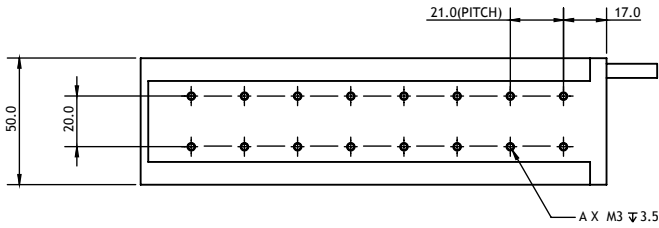

COIL	L	A
PIX150B-050-C1	58	4
PIX150B-050-C2	100	8
PIX150B-050-C3	142	12
PIX150B-050-C4	184	16

MAGNET TRACK	TL	B	WEIGHT (kg)
PIXM150-050-TL084-NC/C	084	4	0.28
PIXM150-050-TL210-NC/C	210	10	0.68
PIXM150-050-TL420-NC/C	420	20	1.365

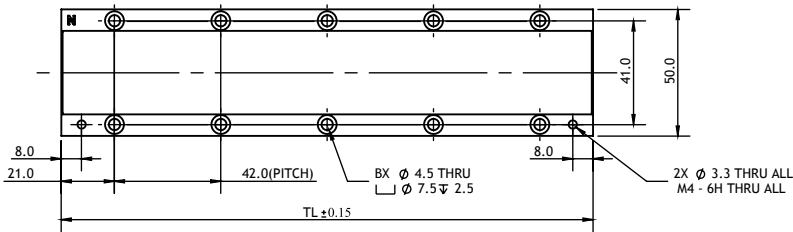
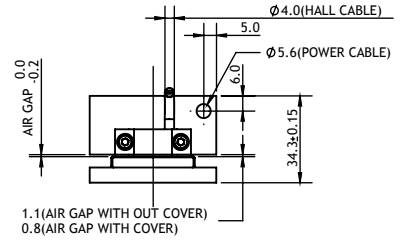
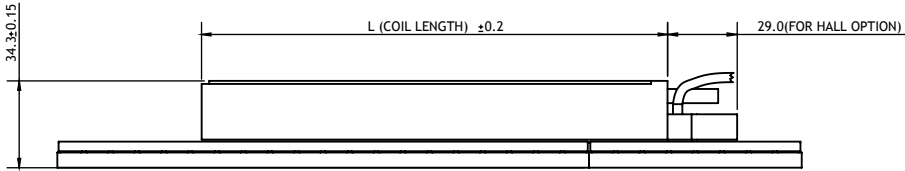

NOTE:
 MOTOR AND HALL CABLES TO OBSERVE:
 FIXED INSTALLATION : STATIC BEND RADIUS $R > 3 \times$ CABLE DIAMETER
 FLEXING INSTALLATION : DYNAMIC BEND RADIUS $R > 10 \times$ CABLE DIAMETER

GRAPH: Force VS Speed

PIX150B-050-C1

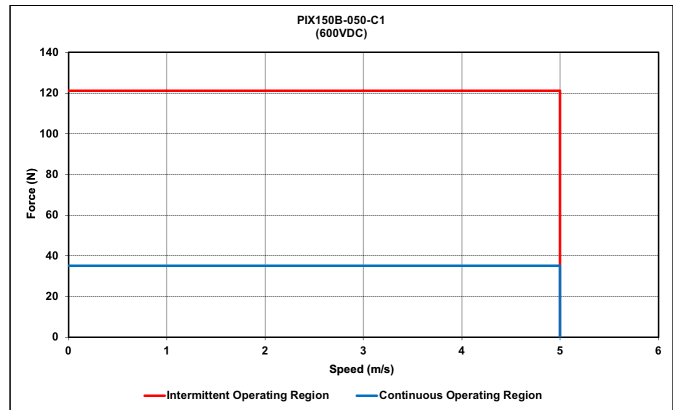
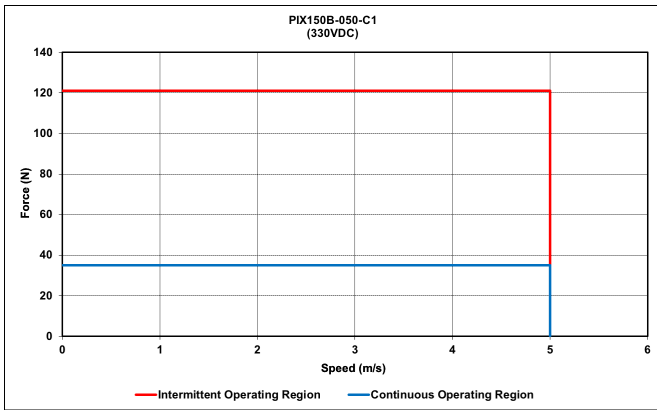

PIX150B-050-C2

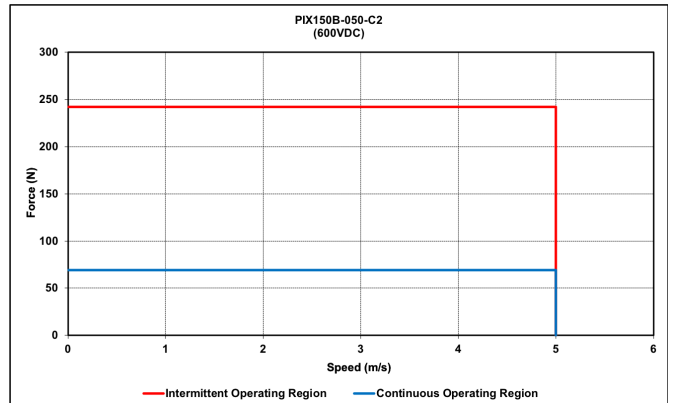
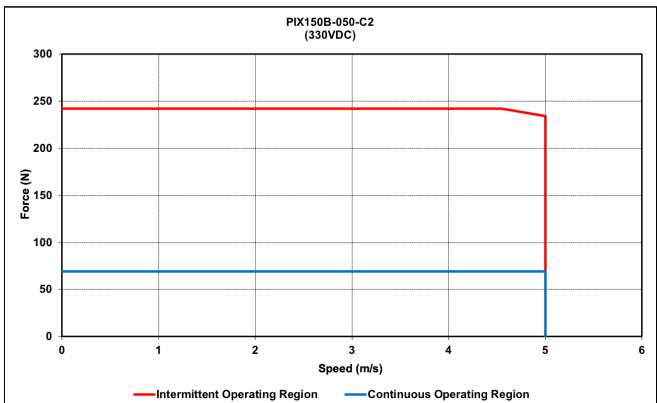

PIX150B-050-C3

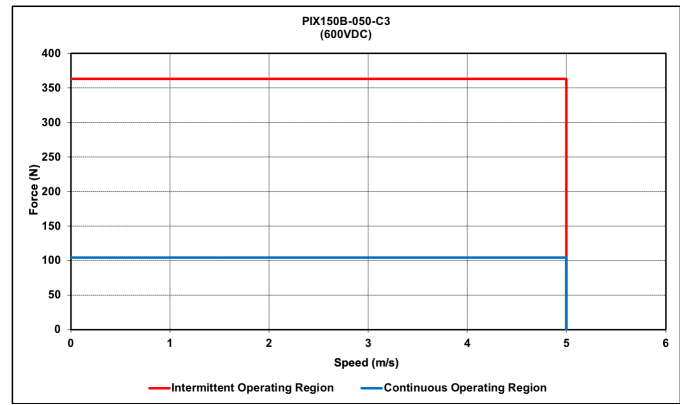
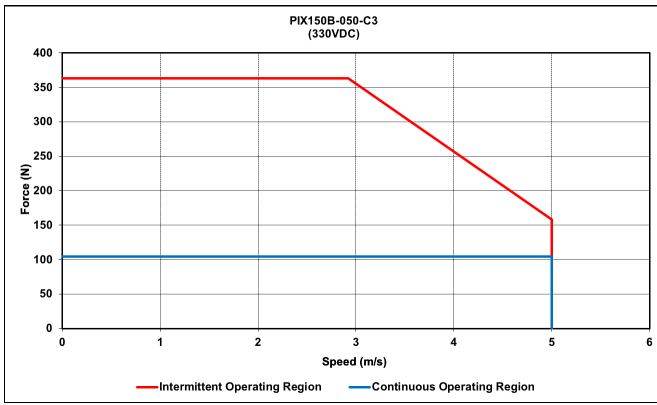

PIX150B-050-C4

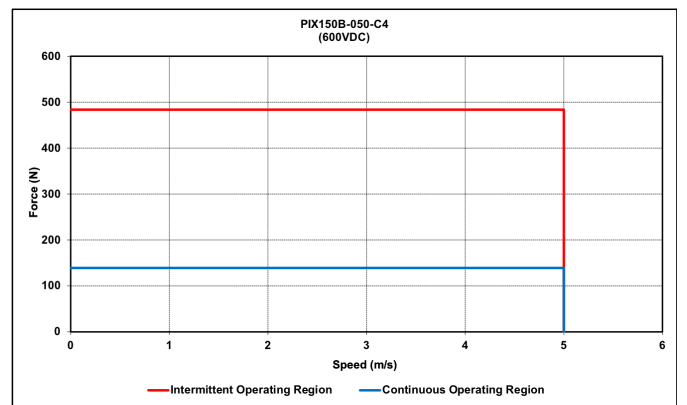
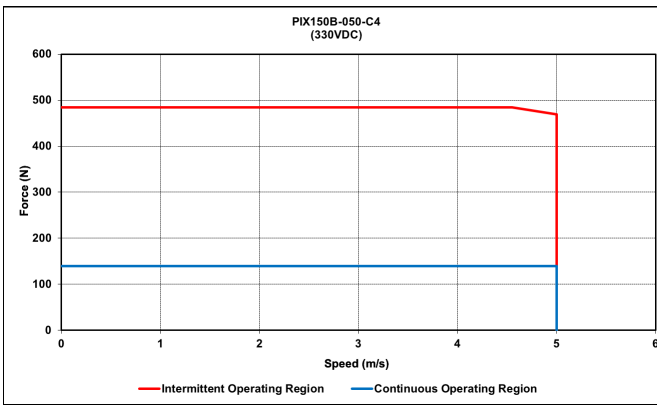

PIX150B SERIES

IRONCORE LINEAR MOTOR

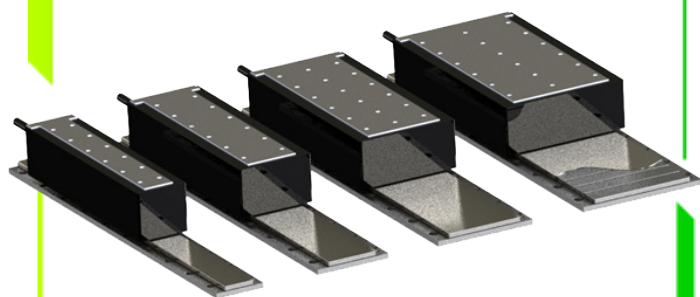

PIX150B - 075

- Peak force up to 1248N, Continuous force up to 357N
- Hall Sensor (Optional)

SPECIFICATION	MODEL					
	PIX150B-075-C1	PIX150B-075-C2	PIX150B-075-C3	PIX150B-075-C4	PIX150B-075-C6	
Performance	Unit					
Peak Force	N	208	416	624	832	1248
Continuous Force @ 100°C*	N	59	119	178	238	357
Continuous Stall Force @ 100°C*	N	42	84	126	168	252
Peak Power @ 100°C	W	530	1059	1589	2118	3177
Continuous Power @ 100°C*	W	35	69	104	139	208
Electrical						
Peak Current	A ^{pk}	12.7	12.7	12.7	25.4	38.2
Continuous Current @ 100°C*	A ^{pk}	3.3	3.3	3.3	6.5	9.8
Continuous Stall Current @ 100°C*	Arms	2.3	2.3	2.3	4.6	6.9
Force Constant	N/A ^{pk}	18.3	36.5	54.8	36.5	36.5
Back EMF Constant	V ^{pk} /m/s	21.1	42.2	63.3	42.2	42.2
Coil Resistance L-L @ 25°C	ohm	3.4	6.7	10.1	3.4	2.2
Coil Resistance L-L @ 100°C*	ohm	4.4	8.7	13.1	4.4	2.9
Inductance L-L @ 1kHz	mH	8.8	17.5	26.3	8.8	5.8
Motor Constant @ 25°C*	N//W	11.5	16.3	20.0	23.1	28.2
Motor Constant @ 100°C*	N//W	10.1	14.3	17.5	20.2	24.7
Max. Terminal Voltage	Vdc	600				
Thermal						
Thermal Resistance @ 100°C*	°C/W	2.17	1.08	0.72	0.54	0.36
Max. Winding Temperature	°C	100				
Mechanical						
Coil Weight	kg	0.5	0.9	1.3	1.6	2.4
Attractive Force	kN	0.36	0.72	1.08	1.44	2.16
Electrical Cycle Length	mm	21				

Notes:

1. $A_{pk} = 1.414 \cdot \text{Arms}$; $V_{pk} = 1.414 \cdot V_{rms}$
2. * Ambient temperature 25°C, natural convection, with heat sink of size L x 2W x 12mm. (L = length of coil, W = width of coil)
3. Specifications tolerance : +/-10%
4. Peak force and current : 4% duty ratio and 1 second duration
5. Motor Insulation Class : Class B (130°C)
6. IP Rating : IP00
7. IEC Protection Class : Class 1
8. Compliance Standards : CE, RoHS
9. Ambient Operating Temperature : 0 - 40°C
10. Ambient Operating Humidity : 10 - 90% RH
11. Specifications are subject to change without prior notice.

PIX150B - 075

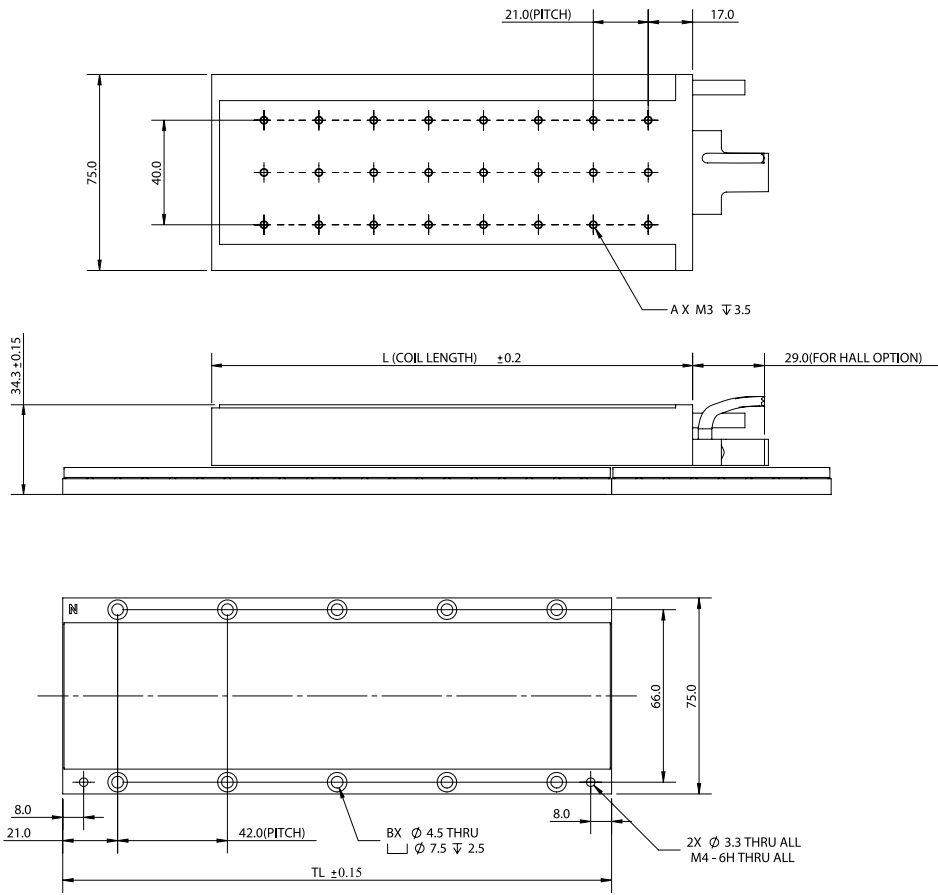

COIL	L	A
PIX150B-075-C1	58	6
PIX150B-075-C2	100	12
PIX150B-075-C3	142	18
PIX150B-075-C4	184	24
PIX150B-075-C6	268	36

MAGNET TRACK	TL	B	WEIGHT (kg)
PIXM150-075-TL084-NC/C	084	4	0.430
PIXM150-075-TL210-NC/C	210	10	1.071
PIXM150-075-TL420-NC/C	420	20	2.143

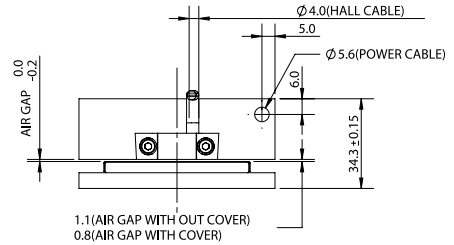

NOTE:
 MOTOR AND HALL CABLES TO OBSERVE:
 FIXED INSTALLATION : STATIC BEND RADIUS $R > 3 \times$ CABLE DIAMETER
 FLEXING INSTALLATION : DYNAMIC BEND RADIUS $R > 10 \times$ CABLE DIAMETER

GRAPH: Force VS Speed

PIX150B-075-C1

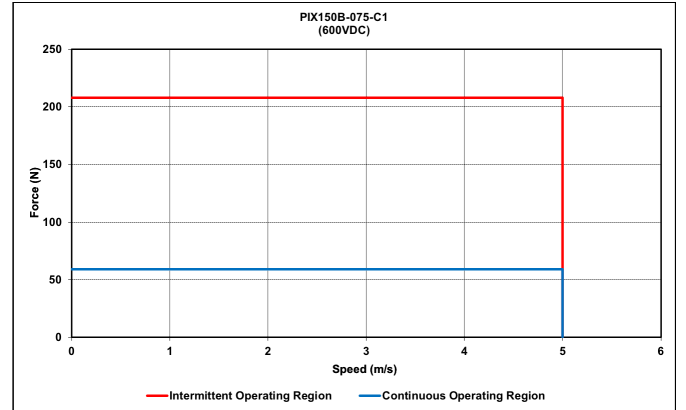
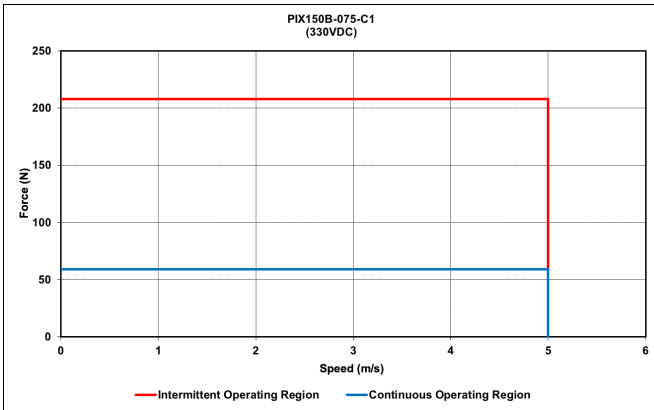

PIX150B-075-C2

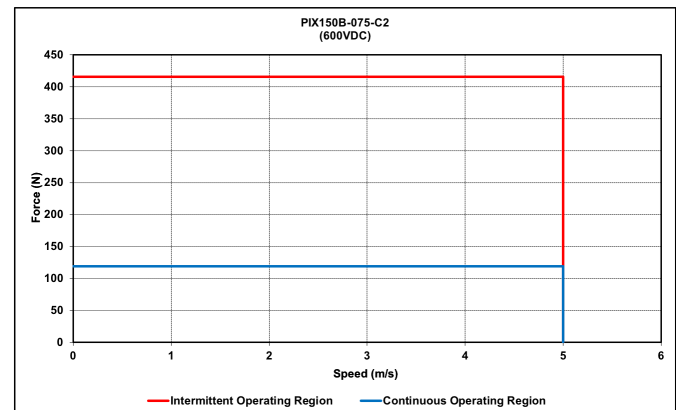
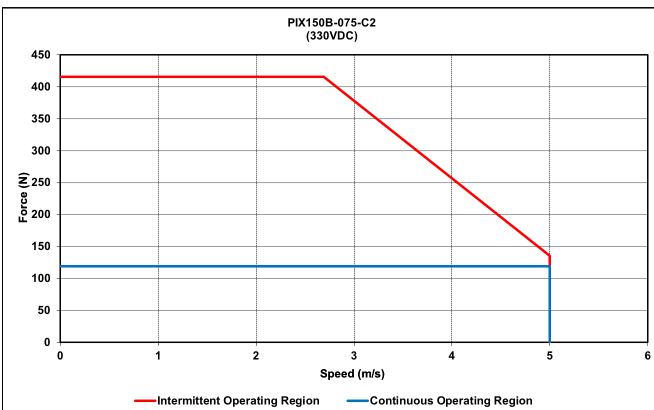

PIX150B-075-C3

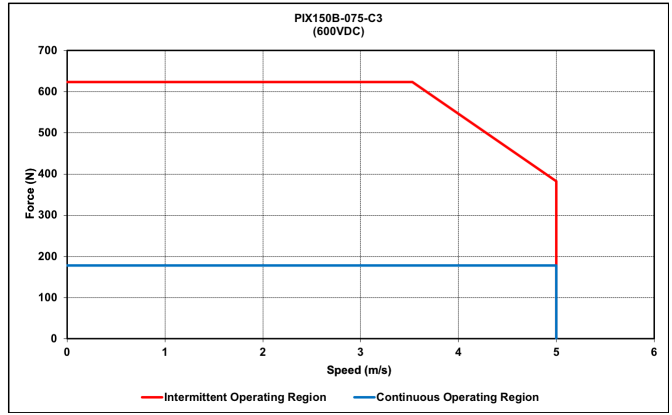
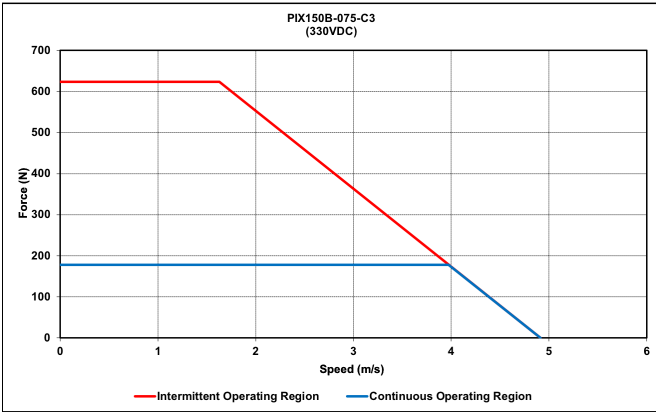

PIX150B-075-C4

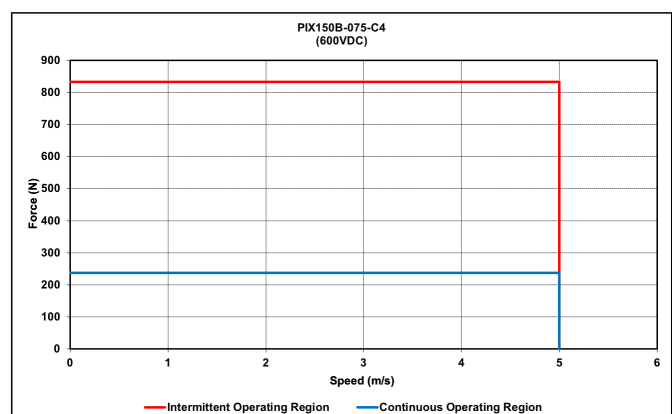
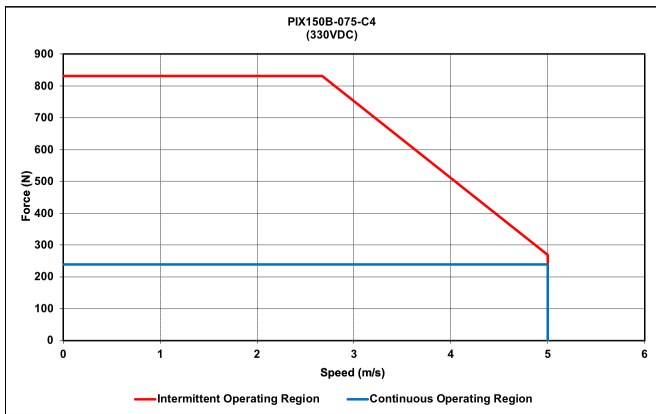

PIX150B-075-C6

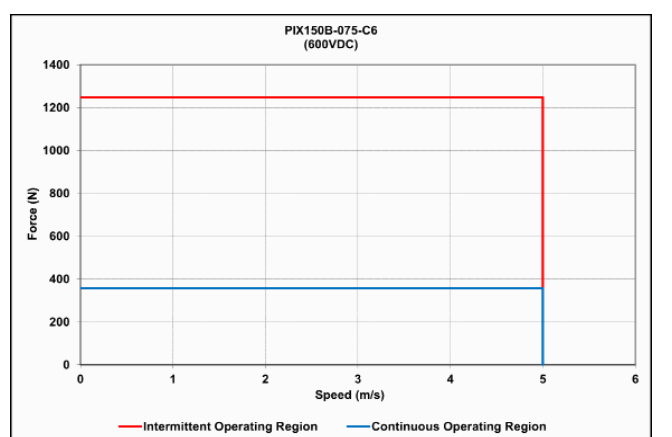
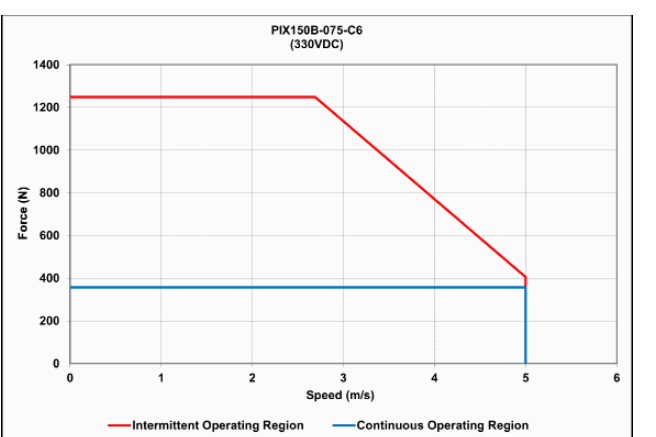

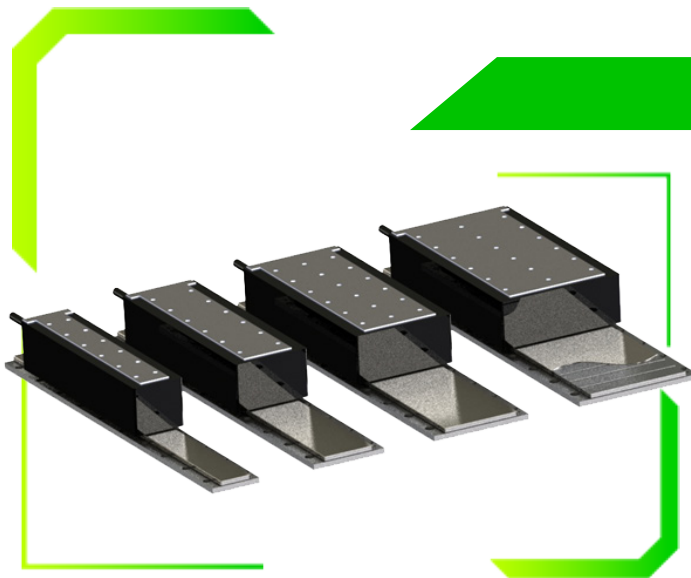

PIX150B SERIES

IRONCORE LINEAR MOTOR

PIX150B - 100

- Peak force up to 1860N, Continuous force to 532N
- Hall Sensor (Optional)

SPECIFICATION		MODEL				
		PIX150B-100-C1	PIX150B-100-C2	PIX150B-100-C3	PIX150B-100-C4	PIX150B-100-C6
Performance		Unit				
Peak Force	N	310	620	930	1240	1860
Continuous Force @ 100°C*	N	89	177	266	355	532
Continuous Stall Force @ 100°C*	N	63	125	188	251	376
Peak Power @ 100°C	W	727	1454	2181	2909	4363
Continuous Power @ 100°C*	W	48	95	143	190	285
Electrical						
Peak Current	A ^{pk}	12.7	12.7	12.7	25.4	38.2
Continuous Current @ 100°C*	A ^{pk}	3.3	3.3	3.3	6.5	9.8
Continuous Stall Current @ 100°C*	Arms	2.3	2.3	2.3	4.6	6.9
Force Constant	N/A ^{pk}	27.3	54.6	81.8	54.6	54.6
Back EMF Constant	V ^{pk} /m/s	31.5	63.0	94.5	63.0	63.0
Coil Resistance L-L @ 25°C	ohm	4.6	9.2	13.8	4.6	3.1
Coil Resistance L-L @ 100°C*	ohm	6.0	12.0	18.0	6.0	4.0
Inductance L-L @ 1kHz	mH	13.3	26.6	39.9	13.3	8.9
Motor Constant @ 25°C*	N//W	14.7	20.8	25.4	29.4	36.0
Motor Constant @ 100°C*	N//W	12.9	18.2	22.3	25.7	31.5
Max. Terminal Voltage	Vdc	600				
Thermal						
Thermal Resistance @ 100°C*	°C/W	1.58	0.79	0.53	0.39	0.26
Max. Winding Temperature	°C	100				
Mechanical						
Coil Weight	kg	0.7	1.2	1.8	2.3	3.3
Attractive Force	kN	0.54	1.08	1.62	2.16	3.24
Electrical Cycle Length	mm	21				

Notes:

1. $A_{pk} = 1.414 * Arms$; $V_{pk} = 1.414 * V_{rms}$
2. * Ambient temperature 25°C, natural convection, with heat sink of size L x 2W x 12mm. (L = length of coil, W = width of coil)
3. Specifications tolerance : +/-10%
4. Peak force and current : 4% duty ratio and 1 second duration
5. Motor Insulation Class : Class B (130°C)
6. IP Rating : IP00
7. IEC Protection Class : Class 1
8. Compliance Standards : CE, RoHS
9. Ambient Operating Temperature : 0 - 40°C
10. Ambient Operating Humidity : 10 - 90% RH
11. Specifications are subject to change without prior notice.

PIX150B - 100

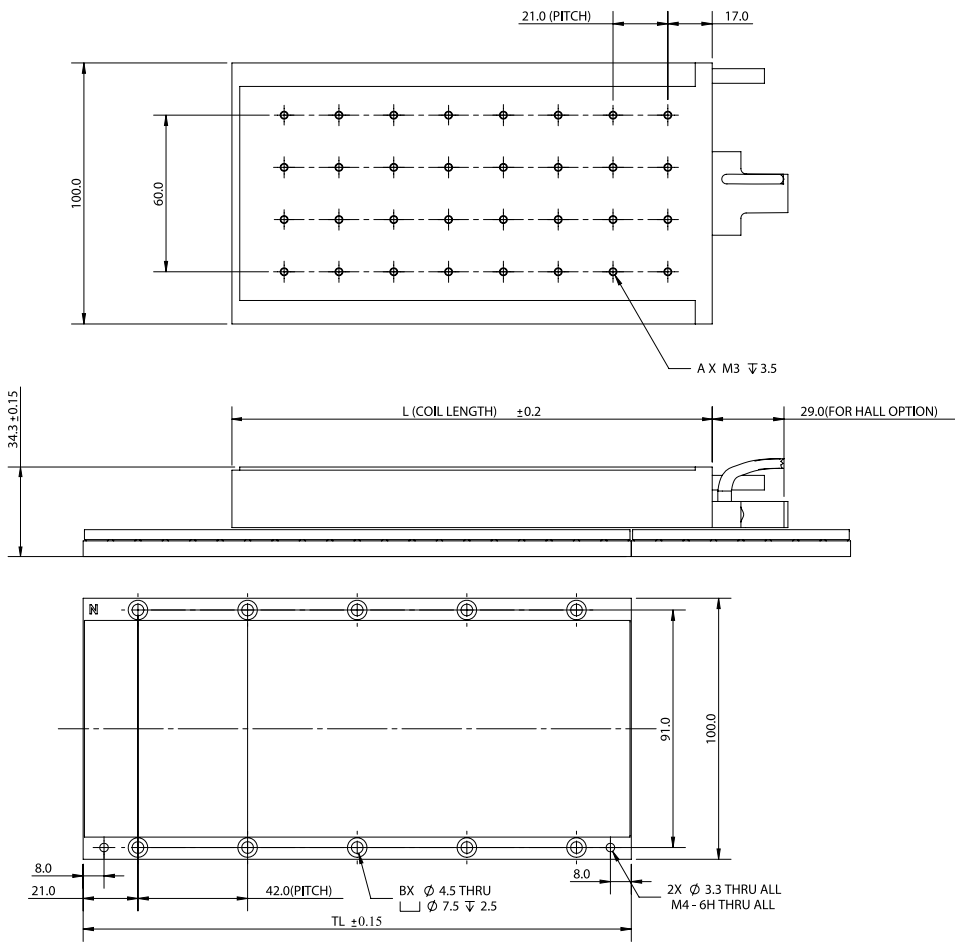

COIL	L	A
PIX150B-100-C1	58	8
PIX150B-100-C2	100	16
PIX150B-100-C3	142	24
PIX150B-100-C4	184	32
PIX150B-100-C6	268	48

MAGNET TRACK	TL	B	WEIGHT (kg)
PIXM150-100-TL084-NC/C	084	4	0.594
PIXM150-100-TL210-NC/C	210	10	1.484
PIXM150-100-TL420-NC/C	420	20	2.969

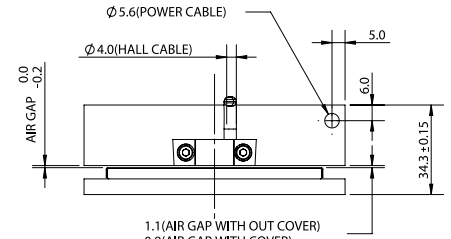

NOTE:
MOTOR AND HALL CABLES TO OBSERVE:
FIXED INSTALLATION : STATIC BEND RADIUS $R > 3 \times$ CABLE DIAMETER
FLEXING INSTALLATION : DYNAMIC BEND RADIUS $R > 10 \times$ CABLE DIAMETER

GRAPH: Force VS Speed

PIX150B-100-C1

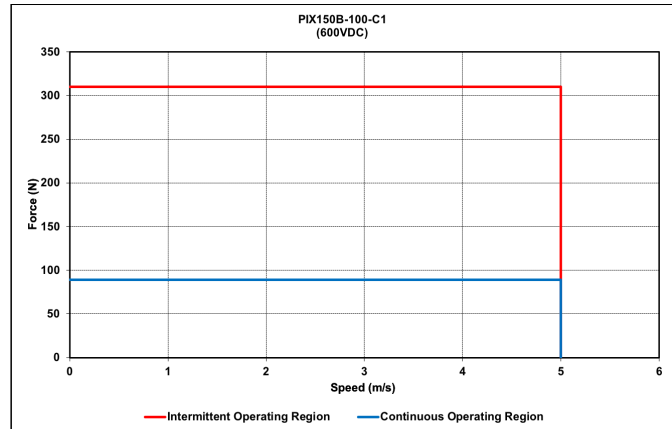
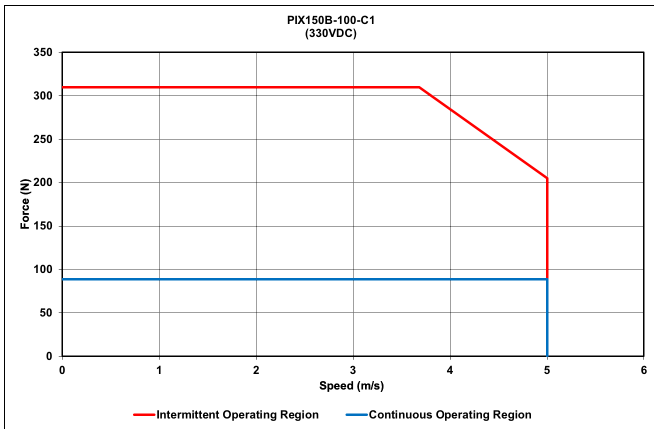

PIX150B-100-C2

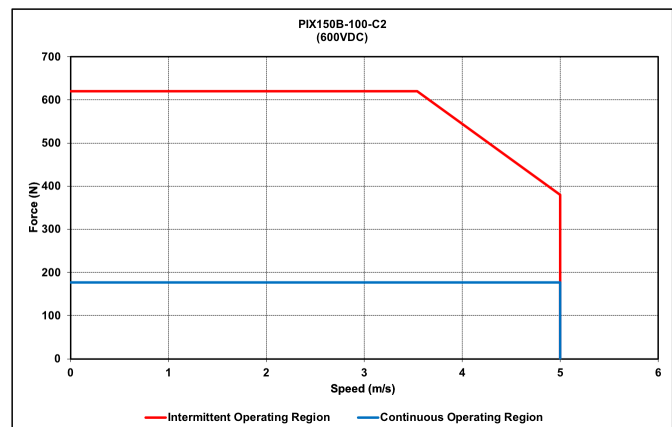
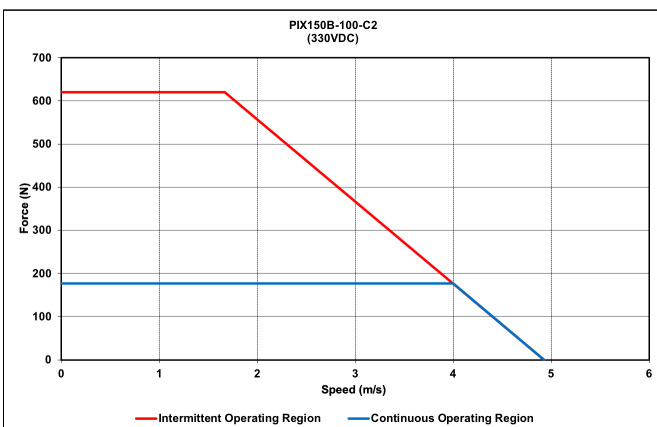

DXB/BT
 PIX
 PSM/PSME
 CVC
 CVCA
 RVCA
 PDDR
 PCA
 PWA
 PLA
 PDAB
 PIAB
 OCTO
 PRG
 LINEAR ENCODER
 SERVO AMPLIFIER

PIX150B-100-C3

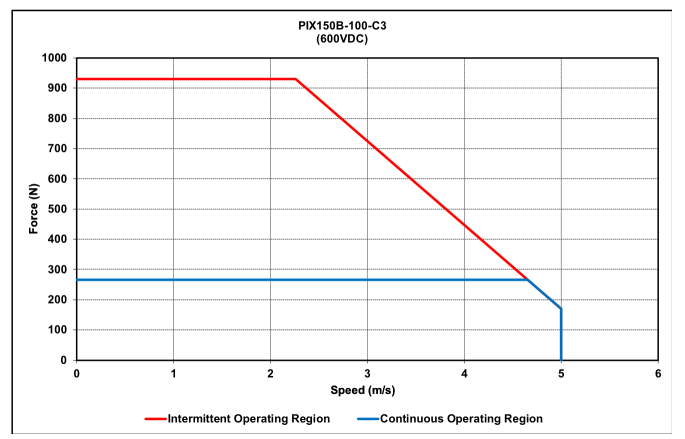
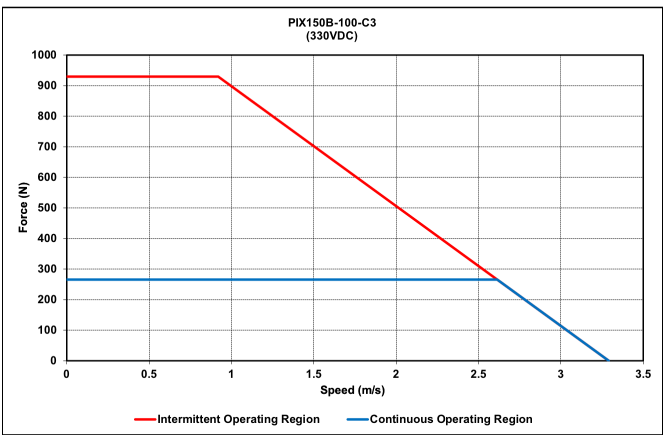

PIX150B-100-C4

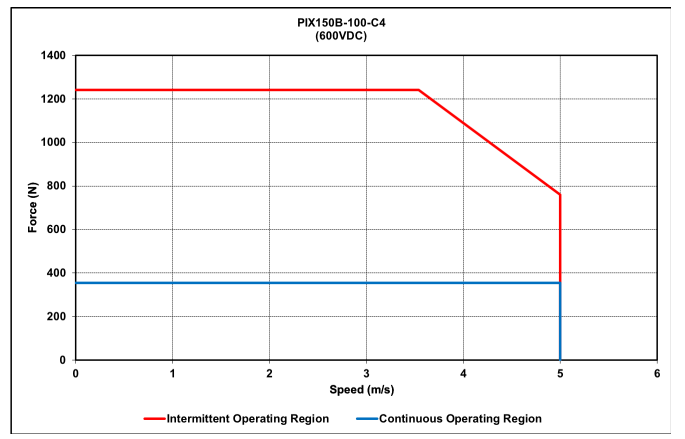
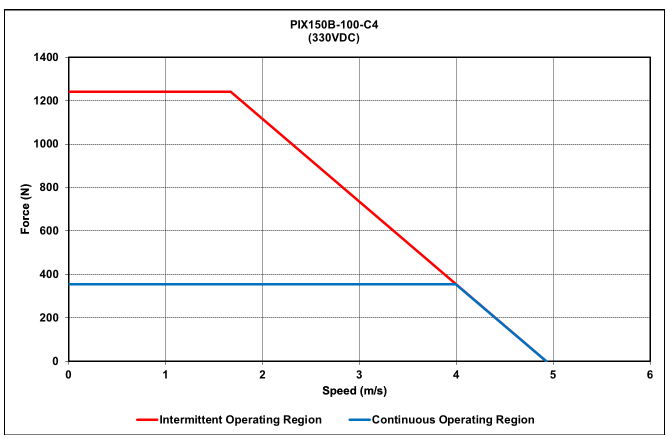

PIX150B-100-C6

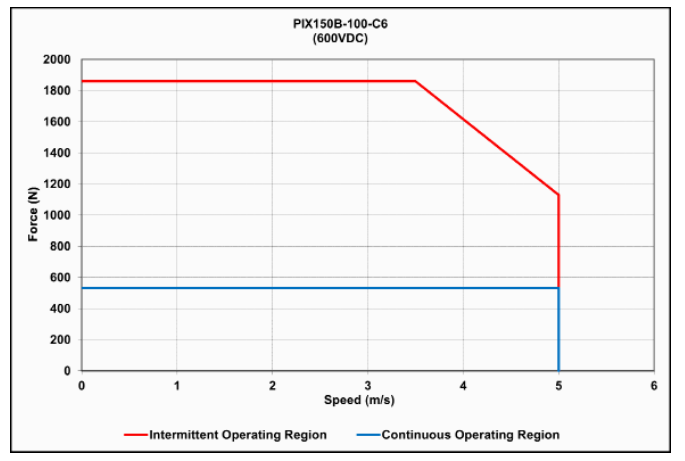
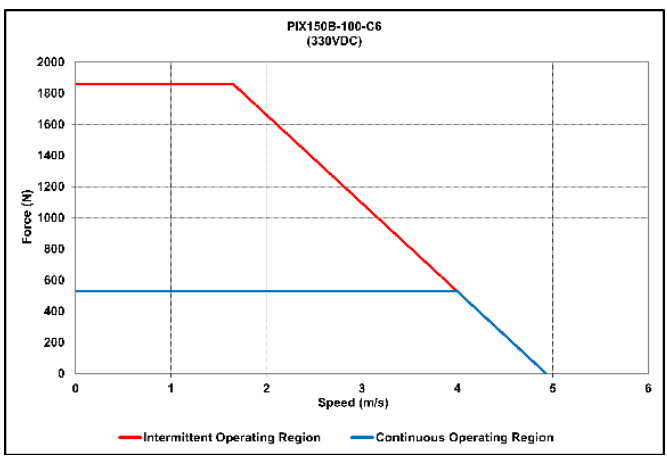

PIX150B SERIES

IRONCORE LINEAR MOTOR

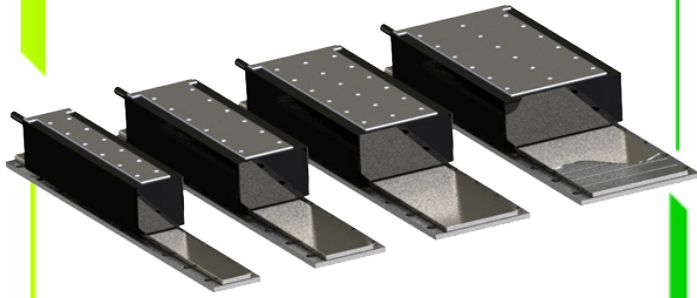

PIX150B - 125

- Peak force up to 2382N, Continuous force up to 681N
- Hall Sensor (Optional)

SPECIFICATION	MODEL					
	PIX150B-125-C1	PIX150B-125-C2	PIX150B-125-C3	PIX150B-125-C4	PIX150B-125-C6	
Performance	Unit					
Peak Force	N	397	794	1191	1588	2382
Continuous Force @ 100°C*	N	114	227	341	454	681
Continuous Stall Force @ 100°C*	N	80	161	241	321	482
Peak Power @ 100°C	W	972	1944	2917	3889	5833
Continuous Power @ 100°C*	W	64	128	191	254	382
Electrical						
Peak Current	A ^{pk}	12.7	12.7	12.7	25.4	38.2
Continuous Current @ 100°C*	A ^{pk}	3.3	3.3	3.3	6.5	9.8
Continuous Stall Current @ 100°C*	Arms	2.3	2.3	2.3	4.6	6.9
Force Constant	N/A ^{pk}	34.9	69.8	104.7	69.8	69.8
Back EMF Constant	V ^{pk} /m/s	40.3	80.6	120.9	80.6	80.6
Coil Resistance L-L @ 25°C	ohm	6.2	12.3	18.5	6.2	4.1
Coil Resistance L-L @ 100°C*	ohm	8.0	16.0	24.0	8.0	5.3
Inductance L-L @ 1kHz	mH	17.0	33.9	50.9	17.0	11.3
Motor Constant @ 25°C*	N//W	16.3	23.0	28.1	32.5	39.8
Motor Constant @ 100°C*	N//W	14.2	20.1	24.7	28.5	34.9
Max. Terminal Voltage	Vdc	600				
Thermal						
Thermal Resistance @ 100°C*	°C/W	1.18	0.59	0.39	0.29	0.20
Max. Winding Temperature	°C	100				
Mechanical						
Coil Weight	kg	0.85	1.5	2.1	2.8	4.0
Attractive Force	kN	0.69	1.38	2.07	2.76	4.14
Electrical Cycle Length	mm	21				

Notes:

1. $A_{pk} = 1.414 \cdot I_{rms}$; $V_{pk} = 1.414 \cdot V_{rms}$
2. * Ambient temperature 25°C, natural convection, with heat sink of size L x 2W x 12mm. (L = length of coil, W = width of coil)
3. Specifications tolerance : +/-10%
4. Peak force and current : 4% duty ratio and 1 second duration
5. Motor Insulation Class : Class B (130°C)
6. IP Rating : IP00
7. IEC Protection Class : Class 1
8. Compliance Standards : CE, RoHS
9. Ambient Operating Temperature : 0 - 40°C
10. Ambient Operating Humidity : 10 - 90% RH
11. Specifications are subject to change without prior notice.

DXB/BT
 PIX
 PSM/PSME
 CVC
 CVCA
 RVCA
 PDDR
 PCA
 PVA
 PLA
 PDAB
 PIAB
 OCTO
 PRG
 LINEAR ENCODER
 SERVO AMPLIFIER

PIX150B - 125

DXB/BT
 PIX
 PSM/PSME
 CVC
 CVCA
 RVCA
 PDDR
 PCA
 PWA
 PLA
 PDAB
 PIAB
 OCTO
 PRG
 LINEAR ENCODER / SERVO AMPLIFIER

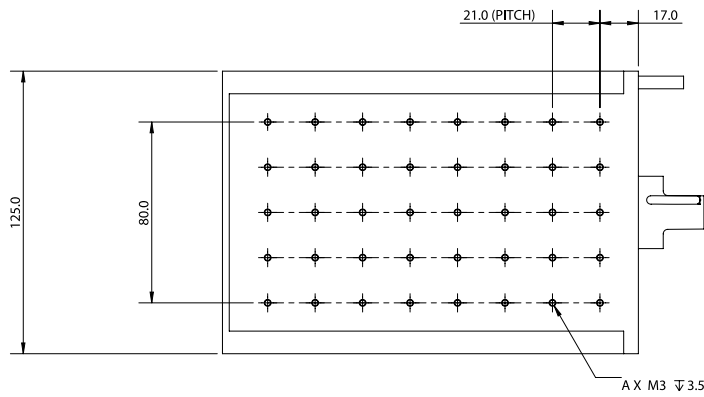

COIL	L	A
PIX150B-125-C1	58	10
PIX150B-125-C2	100	20
PIX150B-125-C3	142	30
PIX150B-125-C4	184	40
PIX150B-125-C6	268	60

MAGNET TRACK	TL	B	WEIGHT (kg)
PIXM150-125-TL084-NC/C	84	4	0.750
PIXM150-125-TL210-NC/C	210	10	1.873
PIXM150-125-TL420-NC/C	420	20	3.747

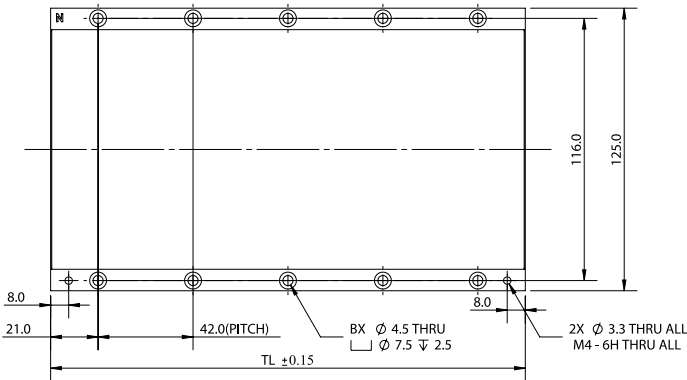
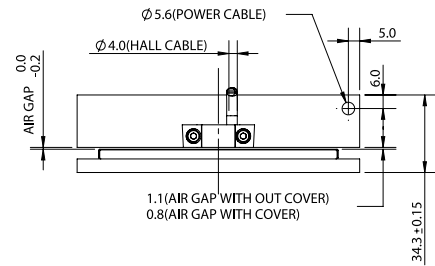
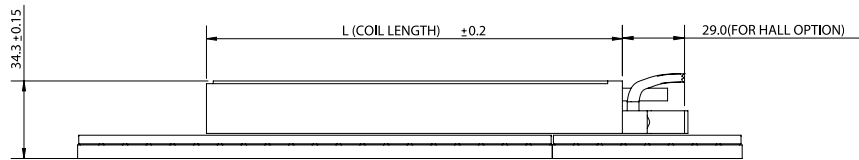

NOTE:
 MOTOR AND HALL CABLES TO OBSERVE:
 FIXED INSTALLATION : STATIC BEND RADIUS $R > 3 \times$ CABLE DIAMETER
 FLEXING INSTALLATION : DYNAMIC BEND RADIUS $R > 10 \times$ CABLE DIAMETER

GRAPH: Force VS Speed

PIX150B-125-C1

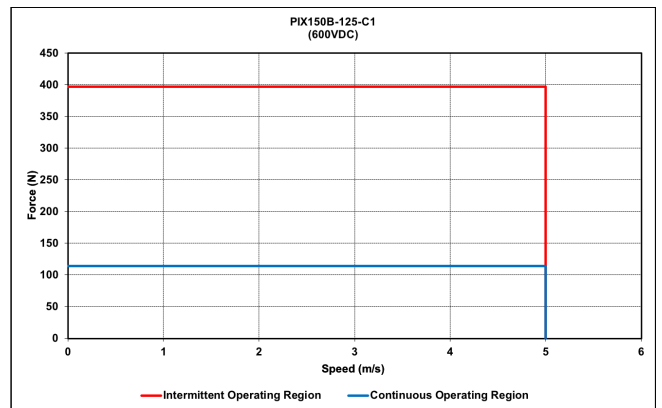
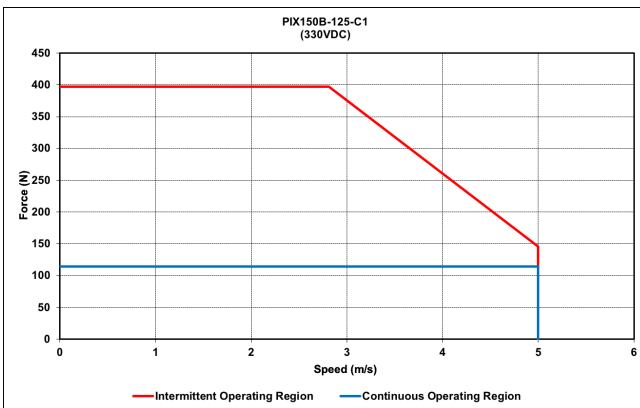

PIX150B-125-C2

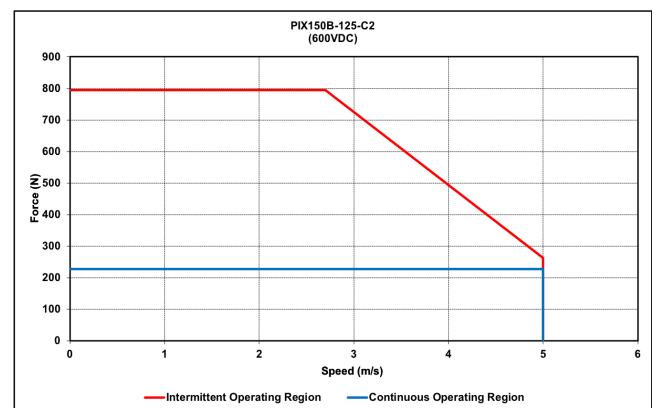
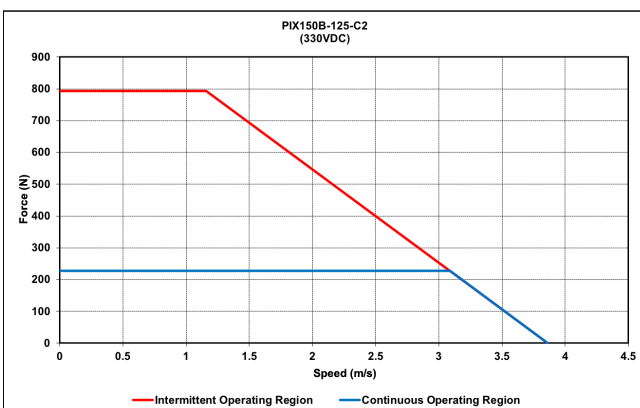

PIX150B-125-C3

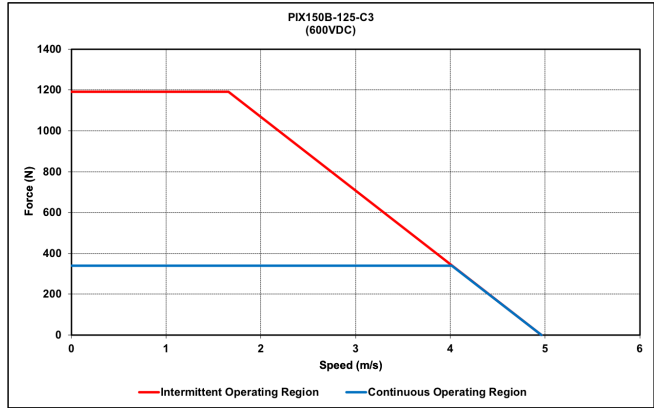
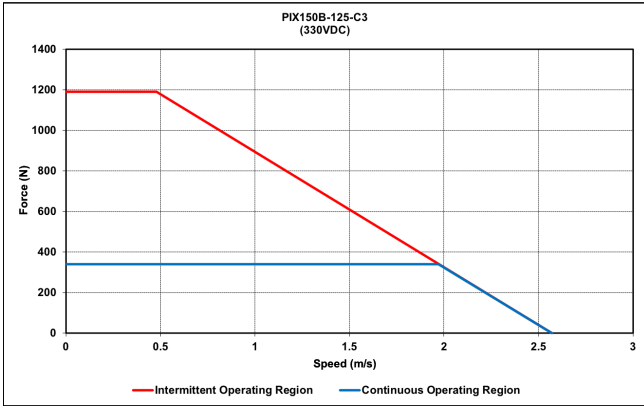

PIX150B-125-C4

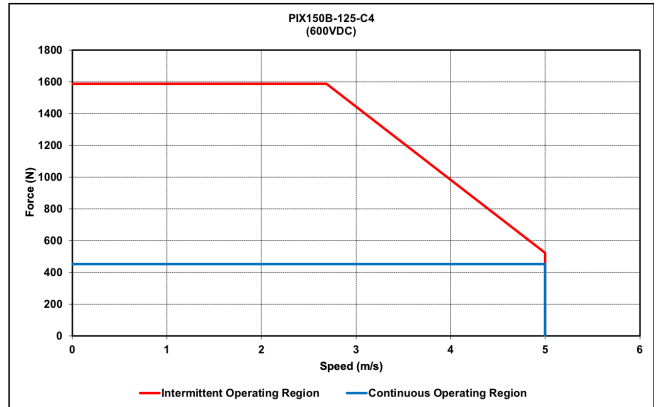
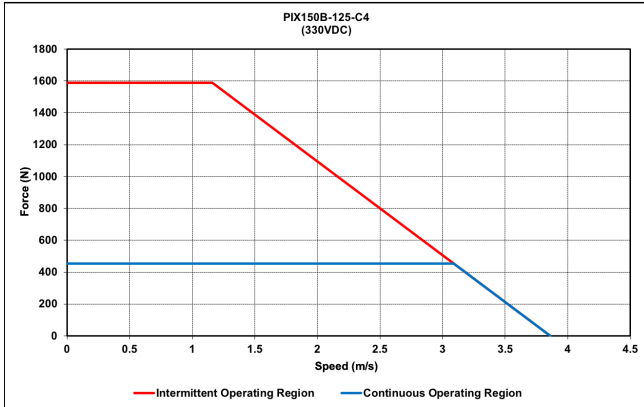

PIX150B-125-C6

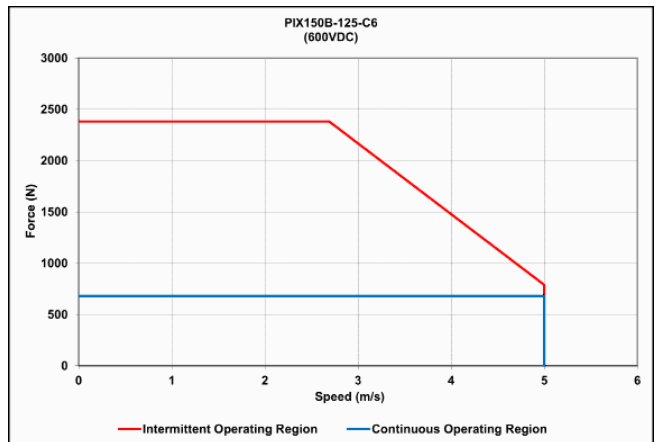
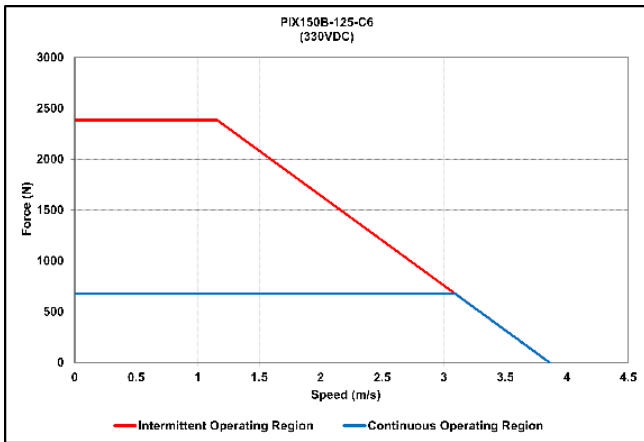

CABLE OPTION

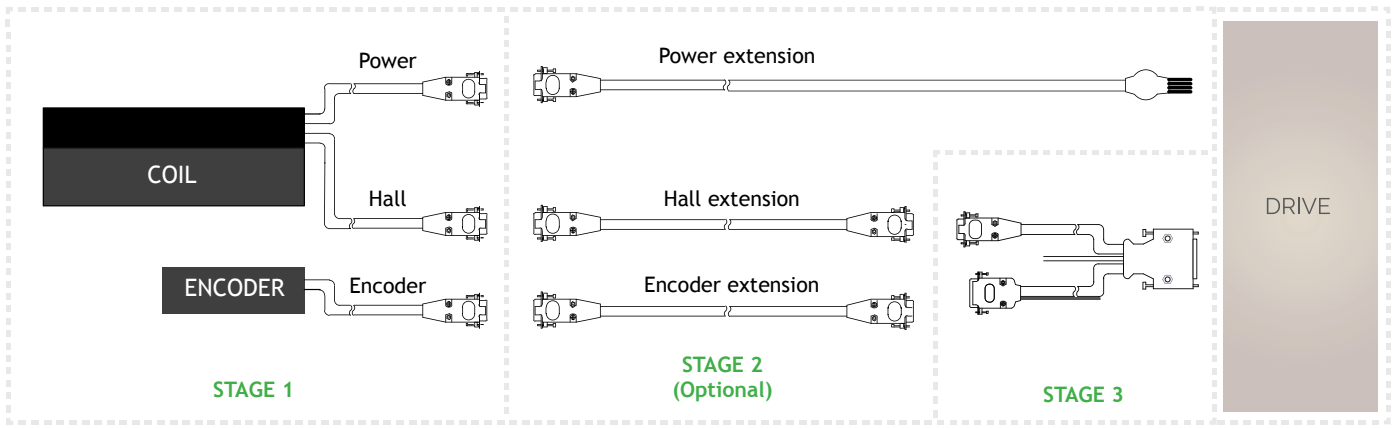

THERMAL PROTECTION

The temperature at which the thermal device is activated is shown below

MODEL	THERMAL DEVICE TYPE	
PIX150B	PT100	TC: Refer to note 1
PIX150B	THERMOSTAT	TM: (NC) Opens at 100° C

Note 1:

- Programmable and can be used where there are temperature controllers or drivers/motion controllers with analog inputs.
- Recommended to set cut-off temperature to 100° C (max) to prevent coil damage.
- User has to ensure that the thermal protection devices are wired to appropriate electronics to ensure that the motor power cutoff is active when temperature reaches its allowable limit.

STAGE 1 | POWER AND HALL CABLE OPTION

PIX150B-050-C1-TM-O.5-NC-NF-HC-00

POWER CABLE OPTIONS

NF		<table border="1"> <tr><td>M1</td><td>Grey</td></tr> <tr><td>M2</td><td>Brown</td></tr> <tr><td>M3</td><td>Black</td></tr> <tr><td>PE</td><td>Yellow</td></tr> <tr><td>Temp sensor 1</td><td>Black</td></tr> <tr><td>Temp sensor 2</td><td>Orange</td></tr> </table>	M1	Grey	M2	Brown	M3	Black	PE	Yellow	Temp sensor 1	Black	Temp sensor 2	Orange															
M1	Grey																												
M2	Brown																												
M3	Black																												
PE	Yellow																												
Temp sensor 1	Black																												
Temp sensor 2	Orange																												
FC		<table border="1"> <tr><td>M1</td><td>Grey</td></tr> <tr><td>M2</td><td>Brown</td></tr> <tr><td>M3</td><td>Black</td></tr> <tr><td>PE</td><td>Yellow</td></tr> <tr><td>Temp sensor 1</td><td>Black</td></tr> <tr><td>Temp sensor 2</td><td>Orange</td></tr> </table>	M1	Grey	M2	Brown	M3	Black	PE	Yellow	Temp sensor 1	Black	Temp sensor 2	Orange															
M1	Grey																												
M2	Brown																												
M3	Black																												
PE	Yellow																												
Temp sensor 1	Black																												
Temp sensor 2	Orange																												
9NF	 9 Pin D-Sub Female	<table border="1"> <tr><td>P1</td><td>M1</td><td>Grey</td></tr> <tr><td>P2</td><td>M1</td><td>Black (Jumper)</td></tr> <tr><td>P3</td><td>M3</td><td>Black</td></tr> <tr><td>P4</td><td>M3</td><td>Black (Jumper)</td></tr> <tr><td>P5</td><td>M2</td><td>Brown</td></tr> <tr><td>P6</td><td>M2</td><td>Black (Jumper)</td></tr> <tr><td>P7</td><td>Temp sensor 1</td><td>Black</td></tr> <tr><td>P8</td><td>Temp sensor 2</td><td>Orange</td></tr> <tr><td>P9</td><td>PE</td><td>Yellow</td></tr> </table>	P1	M1	Grey	P2	M1	Black (Jumper)	P3	M3	Black	P4	M3	Black (Jumper)	P5	M2	Brown	P6	M2	Black (Jumper)	P7	Temp sensor 1	Black	P8	Temp sensor 2	Orange	P9	PE	Yellow
P1	M1	Grey																											
P2	M1	Black (Jumper)																											
P3	M3	Black																											
P4	M3	Black (Jumper)																											
P5	M2	Brown																											
P6	M2	Black (Jumper)																											
P7	Temp sensor 1	Black																											
P8	Temp sensor 2	Orange																											
P9	PE	Yellow																											
CNF	 Push Pull 6 Pin Male	<table border="1"> <tr><td>P1</td><td>M1</td><td>Grey</td></tr> <tr><td>P2</td><td>M2</td><td>Brown</td></tr> <tr><td>P3</td><td>M3</td><td>Black</td></tr> <tr><td>P4</td><td>Temp Sensor 1</td><td>Black</td></tr> <tr><td>P5</td><td>Temp Sensor 2</td><td>Orange</td></tr> <tr><td>P6</td><td>PE</td><td>Yellow</td></tr> </table>	P1	M1	Grey	P2	M2	Brown	P3	M3	Black	P4	Temp Sensor 1	Black	P5	Temp Sensor 2	Orange	P6	PE	Yellow									
P1	M1	Grey																											
P2	M2	Brown																											
P3	M3	Black																											
P4	Temp Sensor 1	Black																											
P5	Temp Sensor 2	Orange																											
P6	PE	Yellow																											

HALL SENSOR OPTIONS

H		<table border="1"> <tr><td>Hall A</td><td>White</td></tr> <tr><td>Hall B</td><td>Green</td></tr> <tr><td>Hall C</td><td>Blue</td></tr> <tr><td>5V</td><td>Red</td></tr> <tr><td>0V</td><td>Black</td></tr> </table>	Hall A	White	Hall B	Green	Hall C	Blue	5V	Red	0V	Black						
Hall A	White																	
Hall B	Green																	
Hall C	Blue																	
5V	Red																	
0V	Black																	
HC	 9 Pin D-Sub Male	<table border="1"> <tr><td>P1</td><td>Hall A</td><td>White</td></tr> <tr><td>P2</td><td>Hall B</td><td>Green</td></tr> <tr><td>P3</td><td>Hall C</td><td>Blue</td></tr> <tr><td>P4</td><td>5V</td><td>Red</td></tr> <tr><td>P5</td><td>0V</td><td>Black</td></tr> </table>	P1	Hall A	White	P2	Hall B	Green	P3	Hall C	Blue	P4	5V	Red	P5	0V	Black	
P1	Hall A	White																
P2	Hall B	Green																
P3	Hall C	Blue																
P4	5V	Red																
P5	0V	Black																
CHC	 Push Pull 5 Pin Male	<table border="1"> <tr><td>P1</td><td>Hall A</td><td>White</td></tr> <tr><td>P2</td><td>Hall B</td><td>Green</td></tr> <tr><td>P3</td><td>Hall C</td><td>Blue</td></tr> <tr><td>P4</td><td>5V</td><td>Red</td></tr> <tr><td>P5</td><td>0V</td><td>Black</td></tr> </table>	P1	Hall A	White	P2	Hall B	Green	P3	Hall C	Blue	P4	5V	Red	P5	0V	Black	
P1	Hall A	White																
P2	Hall B	Green																
P3	Hall C	Blue																
P4	5V	Red																
P5	0V	Black																
HCL	 9 Pin D-Sub Male	<table border="1"> <tr><td>P1</td><td>Hall A+</td></tr> <tr><td>P2</td><td>Hall A-</td></tr> <tr><td>P3</td><td>Hall B+</td></tr> <tr><td>P4</td><td>Hall B-</td></tr> <tr><td>P5</td><td>Hall C+</td></tr> <tr><td>P6</td><td>Hall C-</td></tr> <tr><td>P7</td><td>5V</td></tr> <tr><td>P8</td><td>0V</td></tr> </table>	P1	Hall A+	P2	Hall A-	P3	Hall B+	P4	Hall B-	P5	Hall C+	P6	Hall C-	P7	5V	P8	0V
P1	Hall A+																	
P2	Hall A-																	
P3	Hall B+																	
P4	Hall B-																	
P5	Hall C+																	
P6	Hall C-																	
P7	5V																	
P8	0V																	

Notes: All connectors shown are front view

STAGE 2 | PIX 150B SERIES EXTENSION CABLE

Connection example: PIX150B-□-□-□-□-□-9NF-HC-00

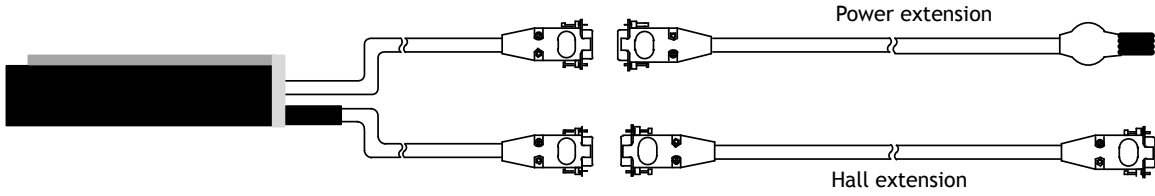

Extension Cable		Part Number
Power Extension Cable		CBL_EXT_PWR1_X.X
		CBL_EXT_PWR1_CC_X.X
Hall Sensor Extension Cable		CBL_EXT_HALLO_X.X
		CBL_EXT_HALLO_CC_X.X
		CBL_EXT_HALLO_DIF_X.X
Encoder Extension Cable		CBL_EXT_REN00_X.X
		CBL_EXT_REN00A_X.X
		CBL_EXT_REN01_X.X
		CBL_EXT_REN01B_X.X
		CBL_EXT_REN05_X.X
		CBL_EXT_REN05A_X.X

CABLE		CABLE LENGTH (X.X)	
00	RGH41, VIONIC, QUANTIC Digital	0.5	0.5 meter
		1.0	1.0meter
00A	RGH41 Analog	2.0	2.0 meter
01	RH200 Digital	3.0	3.0 meter (standard)
01B	PH200 Analog		
05	ATOM Ri Interface Digital		
05A	ATOM Ri Interface Analog		

Notes: 1. X.X is the length of the cable in meters. 2. For customized cable length, contact PBA

HALL SENSOR MODULE PART NUMBERING SYSTEM

Hall Sensor Module Assembly

PIX150B - HM - D - 0.5 - HC - 00

MOTOR MODEL
PIX150B

HALL MODULE
HM

SIGNAL TYPE
D Digital

CABLE LENGTH
0.5 0.5m

DESIGN VERSIONS
00 Standard
01 Customized Version
:

HALL SENSOR AND CONNECTOR OPTIONS
H Flying Leads (No Connector)
HC 9 pins D sub Male Connector
CHC 5 pins Circular Quick Lock Male Connector
HCL 9 pins D Sub Male Connector with Line Driver

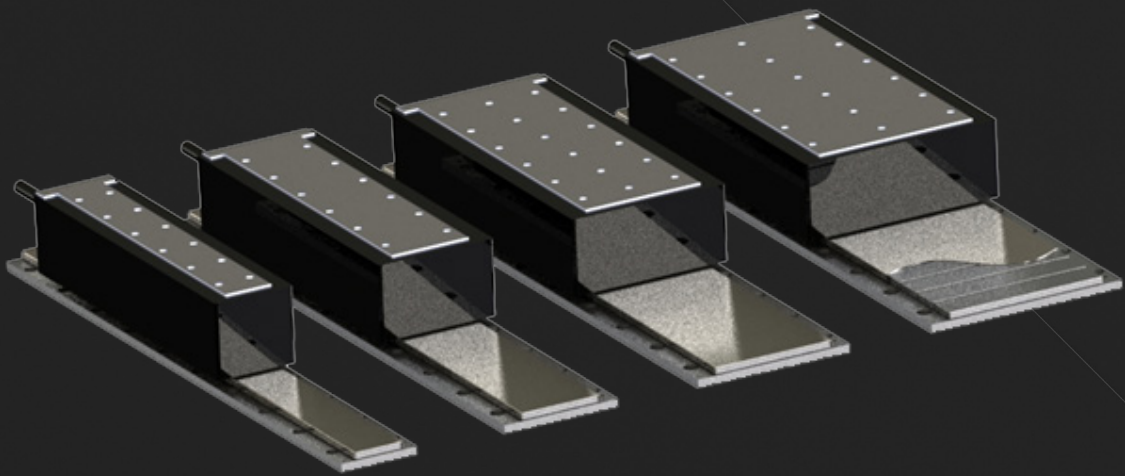

PIX250B SERIES
IRONCORE LINEAR MOTOR

PIX250B SERIES

IRONCORE LINEAR MOTOR

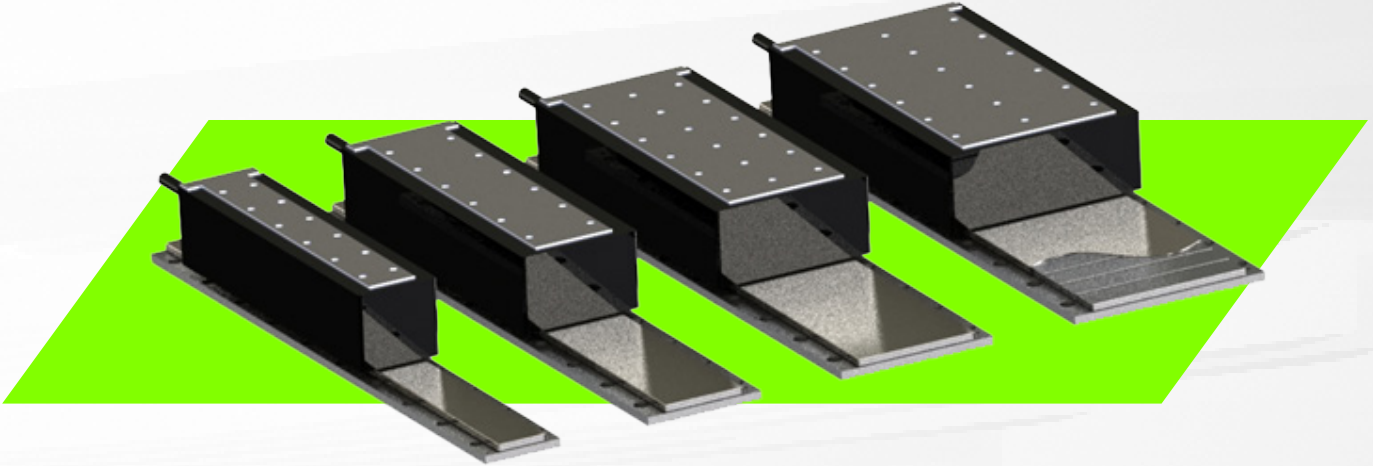

PIX B Iron core motors offer an affordable high force solution to demanding linear applications with an anti-cogging effect that is associated with traditional iron core linear motors.

Our Ironcore is designed for optimal dissipation of heat and thus capable of extremely high forces. These motor coils are manufactured with high flex cables and optional external hall effect attachments widely used in multiple general automation applications.

Modular Flat Magnet tracks are available in different length increments to complete this product selection and allow for easy assembly of un-restricted effective stroke by butting tracks of different lengths together.

- High Power Density
- Anti-cogging design for smooth operation
- Efficient cooling system
- High speed, acceleration and fast response
- High Synchronous run
- Zero backlash - direct drive technology
- Maintenance-free operation - mechanical simplicity due to reduced component count
- Long travels without performance loss

APPLICATION

- Material Transfer/Pick and place
- Packaging
- Semiconductor Machine
- Photovoltaic
- Laser Cutting
- Lithium battery production
- Machine Tools
- Large format printing
- Glass and LCD transfer

**Technical specifications subject to change without prior notice*

PART NUMBERING SYSTEM

51

PIX250B - 050	51
PIX250B - 075	54
PIX250B - 100	57
PIX250B - 125	60

DXB/BT
 PIX
 PSM/PSME
 CVC
 CVCA
 RVCA
 PDDR
 PCA
 PWA
 PLA
 PDAB
 PIAB
 OCTO
 PRG
 LINEAR ENCODER
 SERVO AMPLIFIER

Motor Model	Coil Size	Continuous Force (N)	Peak Force (N)	Continuous Current (A ^{pk})	Peak Current (A ^{pk})	Coil Weight (Kg)	Motor Dimensions without Hall Sensor LxWxH (mm)	Motor Dimensions with Hall Sensor LxWxH (mm)
PIX250B-050	C1	110	240	6.8	20.4	1.3	105 x 51 x 61.1	134 x 51 x 61.1
	C2	220	480	6.8	20.4	2.3	189 x 51 x 61.1	218 x 51 x 61.1
	C3	330	720	6.8	20.4	3.4	273 x 51 x 61.1	302 x 51 x 61.1
	C4	440	960	13.6	40.8	4.4	357 x 51 x 61.1	386 x 51 x 61.1
PIX250B-075	C1	183	400	6.8	20.4	2.1	105 x 75 x 61.1	134 x 75 x 61.1
	C2	366	800	6.8	20.4	4.0	189 x 75 x 61.1	218 x 75 x 61.1
	C3	549	1200	6.8	20.4	5.9	273 x 75 x 61.1	302 x 75 x 61.1
	C4	733	1600	13.6	40.8	7.8	357 x 75 x 61.1	386 x 75 x 61.1
	C6	1099	2400	20.4	61.1	11.6	525 x 75 x 61.1	554 x 75 x 61.1
PIX250B-100	C1	274	600	6.8	20.4	2.7	105 x 100 x 61.1	134 x 100 x 61.1
	C2	548	1200	6.8	20.4	4.8	189 x 100 x 61.1	218 x 100 x 61.1
	C3	823	1800	6.8	20.4	6.9	273 x 100 x 61.1	302 x 100 x 61.1
	C4	1097	2400	13.6	40.8	9.0	357 x 100 x 61.1	386 x 100 x 61.1
	C6	1645	3600	20.4	61.1	13.2	525 x 100 x 61.1	554 x 100 x 61.1
PIX250B-125	C1	366	800	6.8	20.4	3.9	105 x 125 x 61.1	134 x 125 x 61.1
	C2	731	1600	6.8	20.4	7.3	189 x 125 x 61.1	218 x 125 x 61.1
	C3	1097	2400	6.8	20.4	10.7	273 x 125 x 61.1	302 x 125 x 61.1
	C4	1463	3200	13.6	40.8	14.0	357 x 125 x 61.1	386 x 125 x 61.1
	C6	2194	4800	20.4	61.1	20.7	525 x 125 x 61.1	554 x 125 x 61.1

Note: Continuous force is measured under natural convection, refer to the detail parameters table for more information

Force Chart for PIX250B Linear Motor

Force Chart For PIX250B Motors

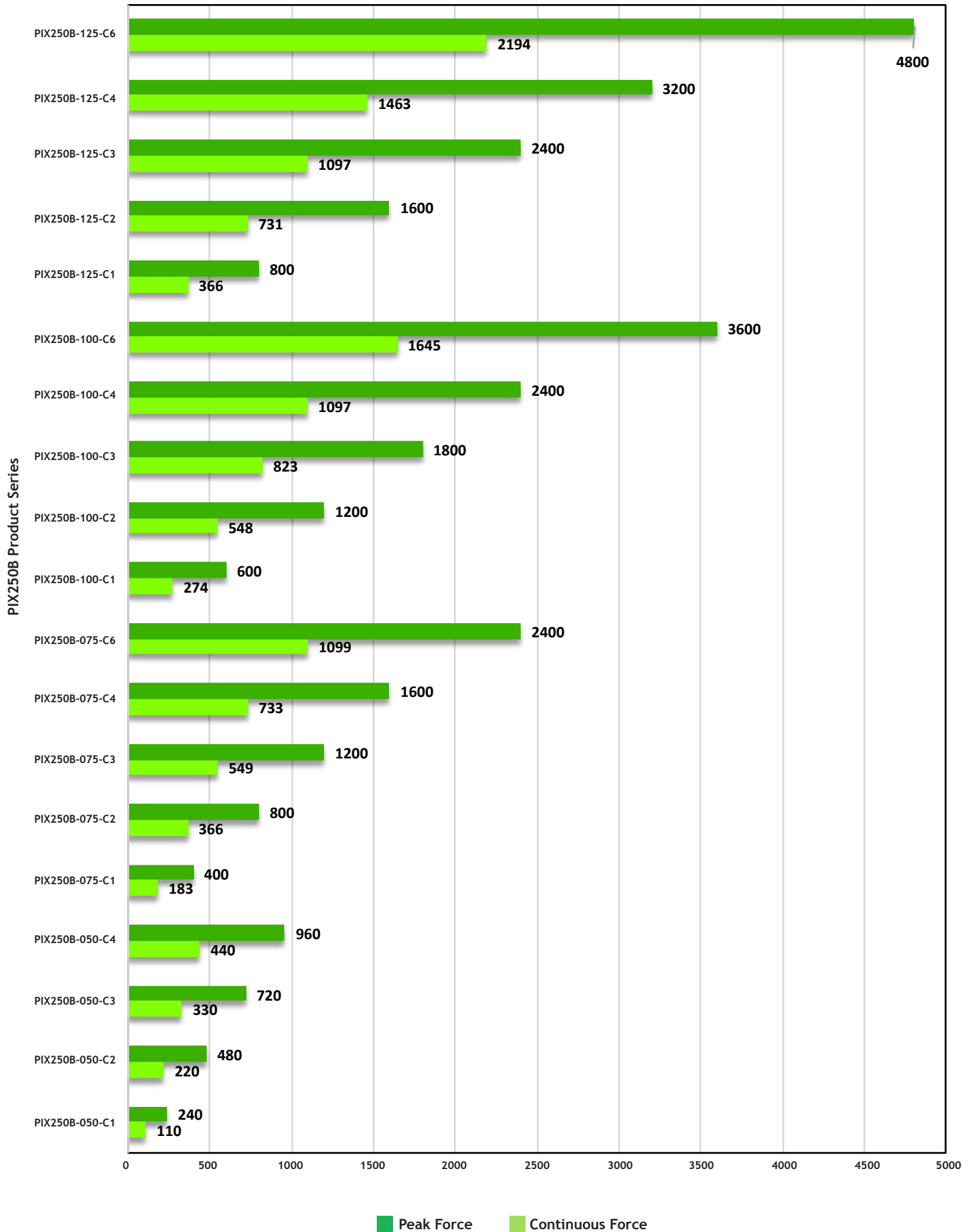

DXB/BT
 PIX
 PSM/PSME
 CVC
 CVCA
 RVCA
 PDDR
 PCA
 PWA
 PLA
 PDAB
 PIAB
 OCTO
 PRG
 LINEAR ENCODER
 SERVO AMPLIFIER

PART NUMBERING SYSTEM

COIL ASSEMBLY

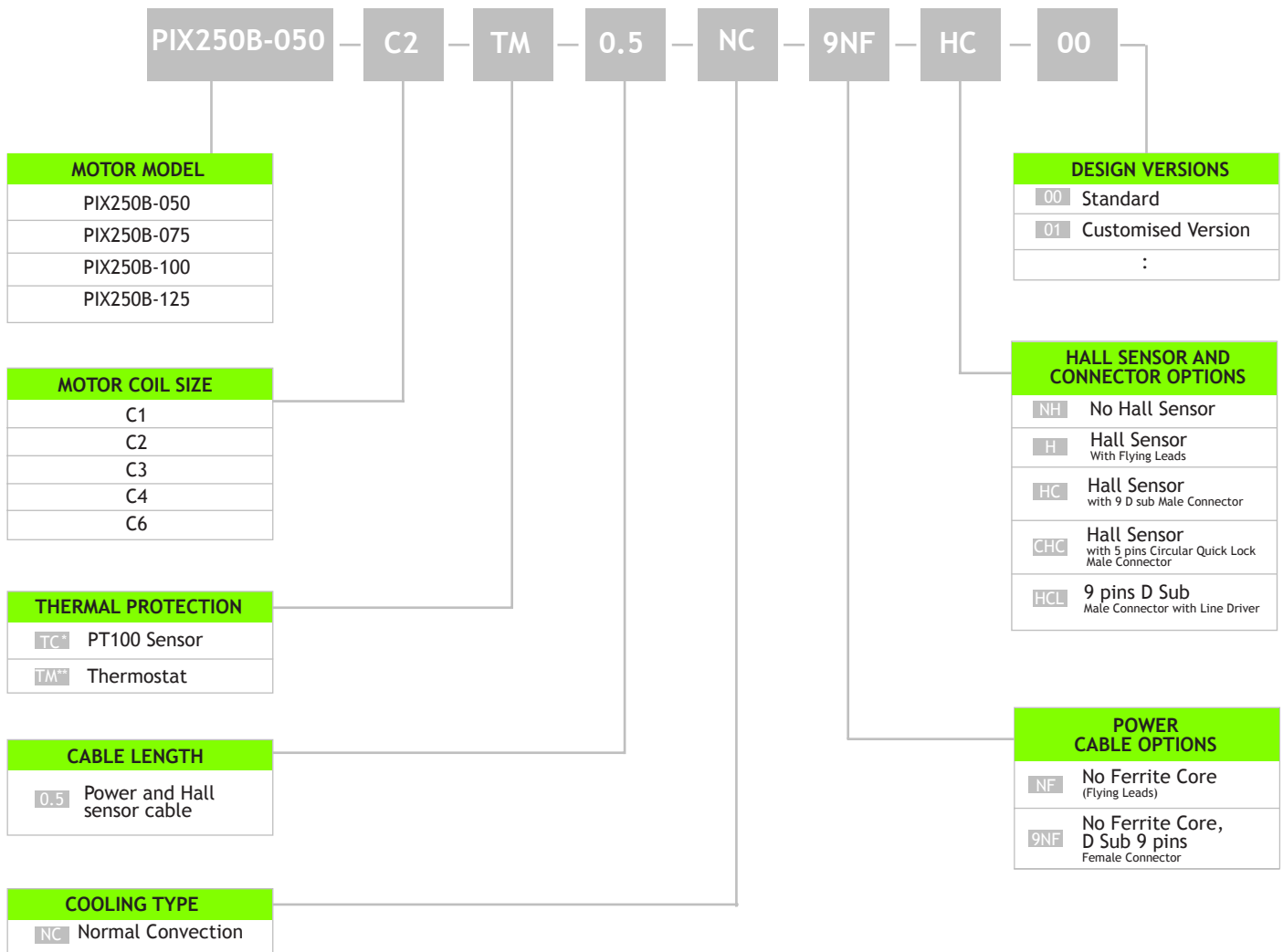

* TC - Sensor output to temperature controller
 ** TM - On/Off switch, triggers at 100°C

MAGNET TRACK

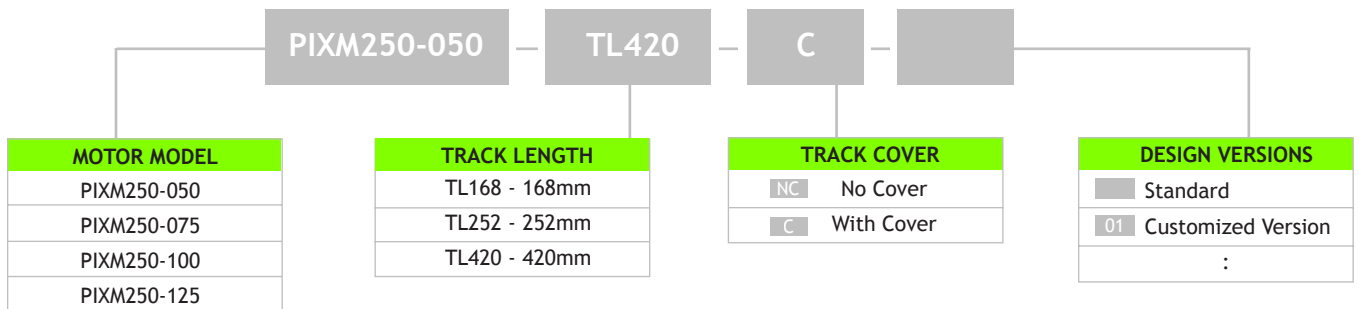

PIX250B SERIES

IRONCORE LINEAR MOTOR

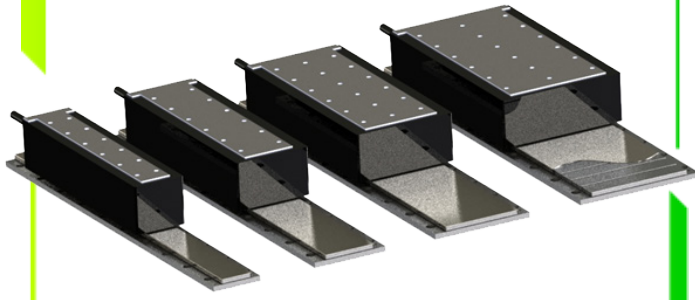

PIX250B - 050

- Peak force up to 960N, Continuous force up to 440N
- Hall Sensor (Optional)

SPECIFICATION	MODEL				
	PIX250B-50-C1	PIX250B-50-C2	PIX250B-50-C3	PIX250B-50-C4	
Performance	Unit				
Peak Force	N	240	480	720	960
Continuous Force @ 100°C*	N	110	220	330	440
Continuous Stall Force @ 100°C*	N	78	155	233	311
Peak Power @ 100°C	W	405	811	1216	1621
Continuous Power @ 100°C*	W	45	90	135	180
Electrical					
Peak Current	A ^{pk}	20.4	20.4	20.4	40.7
Continuous Current @ 100°C*	A ^{pk}	6.8	6.8	6.8	13.6
Continuous Stall Current @ 100°C*	Arms	4.8	4.8	4.8	9.6
Force Constant	N/A ^{pk}	16.2	32.4	48.6	32.4
Back EMF Constant	V ^{pk} /m/s	18.7	37.4	56.1	37.4
Coil Resistance L-L @ 25°C	ohm	1.0	2.0	3.0	1.0
Coil Resistance L-L @ 100°C*	ohm	1.3	2.6	3.9	1.3
Inductance L-L @ 1kHz	mH	13.2	26.4	39.6	13.2
Motor Constant @ 25°C*	N//W	18.7	26.4	32.4	37.4
Motor Constant @ 100°C*	N//W	16.4	23.2	28.4	32.8
Max. Terminal Voltage	Vdc	600			
Thermal					
Thermal Resistance @ 100°C*	°C/W	1.67	0.83	0.56	0.42
Max. Winding Temperature	°C	100			
Mechanical					
Coil Weight	kg	1.3	2.3	3.4	4.4
Attractive Force	kN	0.5	1	1.5	2
Electrical Cycle Length	mm	42			

Notes:

1. $A_{pk} = 1.414 \cdot I_{rms}$; $V_{pk} = 1.414 \cdot V_{rms}$
2. * Ambient temperature 25°C, natural convection, with heat sink of size L x 2W x 12mm. (L = length of coil, W = width of coil)
3. Specifications tolerance : +/- 10%
4. Peak force and current : 4% duty ratio and 1 second duration
5. Motor Insulation Class : Class B (130°C)
6. IP Rating : IP00
7. IEC Protection Class : Class 1
8. Compliance Standards : CE, RoHS
9. Ambient Operating Temperature : 0 - 40°C
10. Ambient Operating Humidity : 10 - 90% RH
11. Specifications are subject to change without prior notice.

DXB/BT
 PIX
 PSM/PSME
 CVC
 CVCA
 RVCA
 PDDR
 PCA
 PWA
 PLA
 PDAB
 PIAB
 OCTO
 PRG
 LINEAR ENCODER
 SERVO AMPLIFIER

PIX250B-050

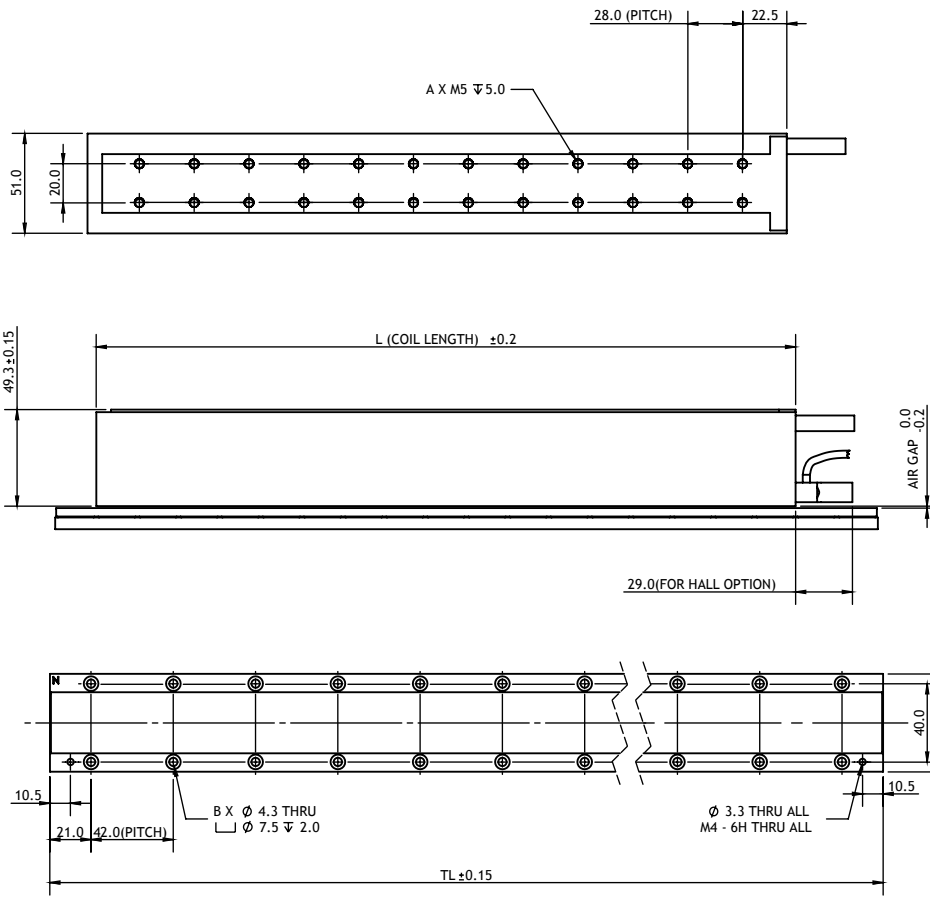

COIL	L	A
PIX250B-050-C1	105	6
PIX250B-050-C2	189	12
PIX250B-050-C3	273	18
PIX250B-050-C4	357	24

MAGNET TRACK	TL	B	WEIGHT (kg)
PIXM250-050-TL168-NC/C	168	8	0.54
PIXM250-050-TL252-NC/C	252	12	0.81
PIXM250-050-TL420-NC/C	420	20	1.35

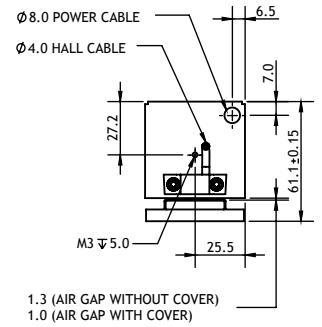

NOTE:
 MOTOR AND HALL CABLES TO OBSERVE:
 FIXED INSTALLATION : STATIC BEND RADIUS $R > 3 \times$ CABLE DIAMETER
 FLEXING INSTALLATION : DYNAMIC BEND RADIUS $R > 10 \times$ CABLE DIAMETER

GRAPH: Force VS Speed

PIX250B-050-C1

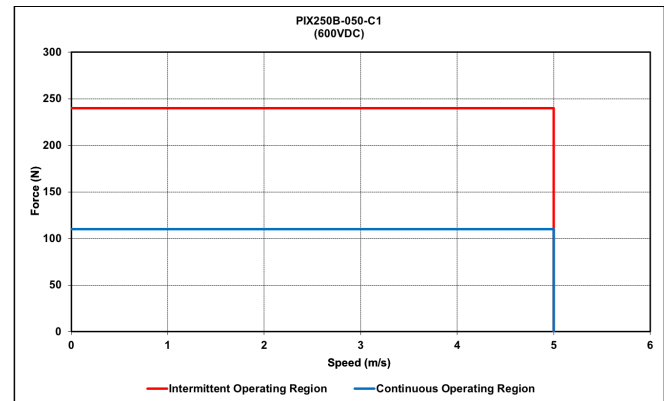
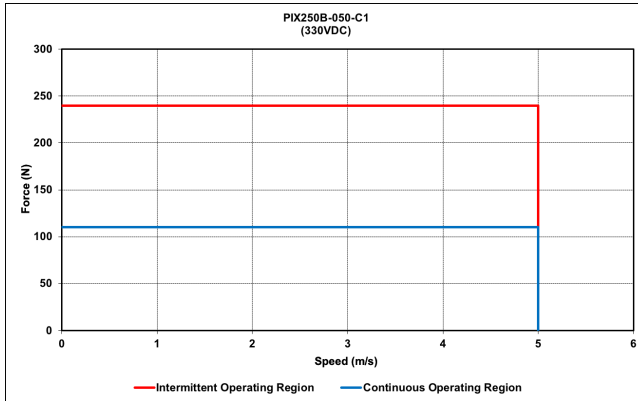

PIX250B-050-C2

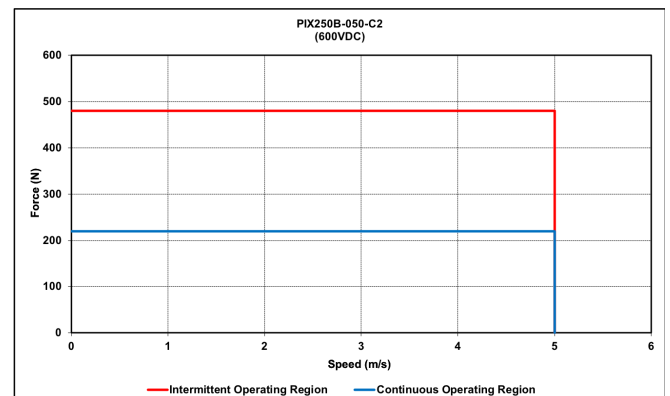
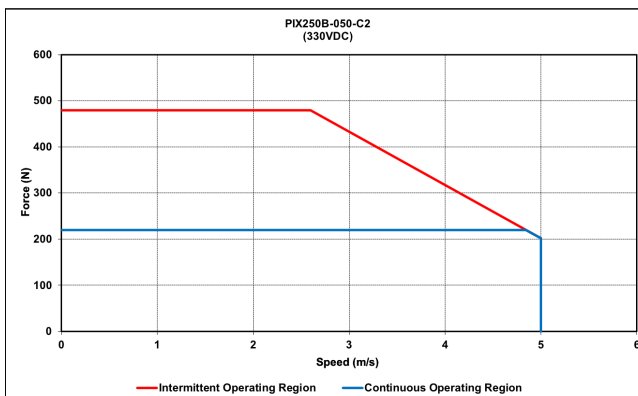

PIX250B-050-C3

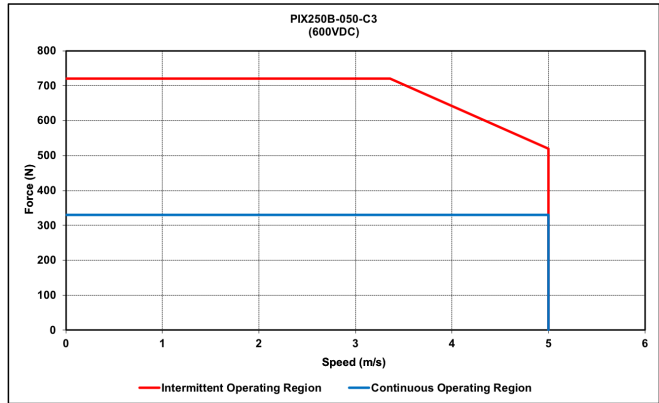
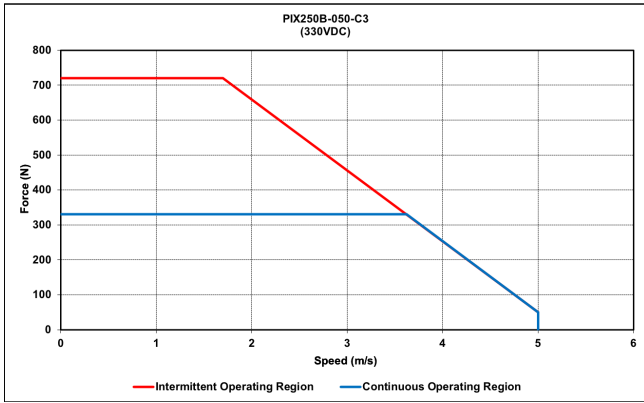

PIX250B-050-C4

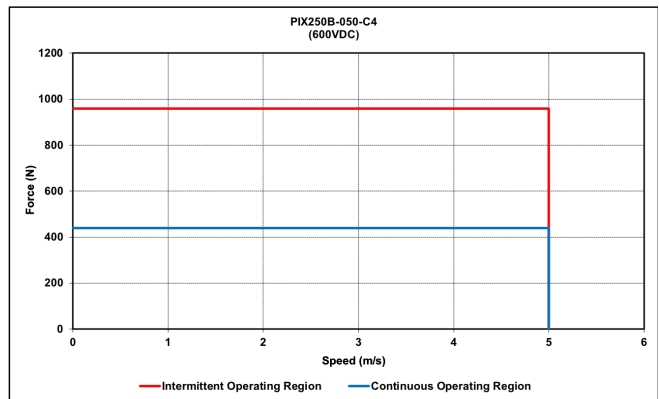
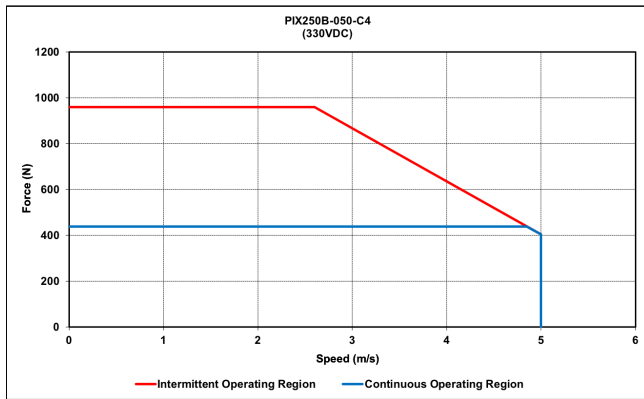

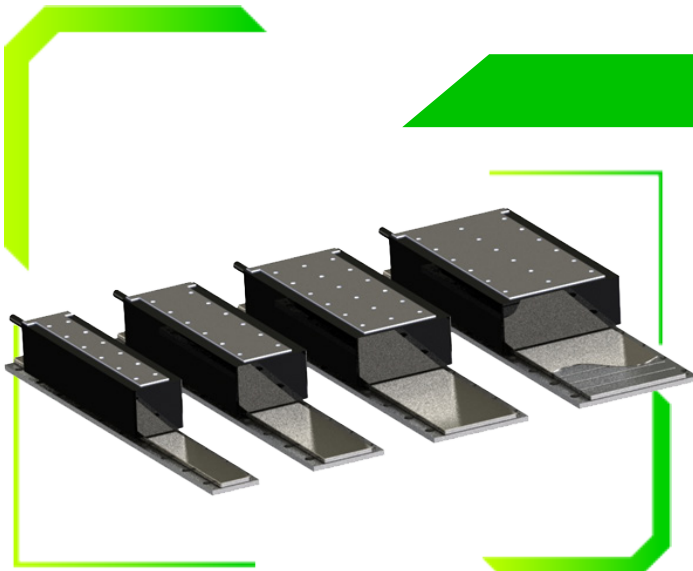

PIX250B SERIES

IRONCORE LINEAR MOTOR

PIX250B - 075

- Peak force up to 2400N, Continuous force up to 1099N
- Hall Sensor (Optional)

SPECIFICATION	MODEL					
	PIX250B-075-C1	PIX250B-075-C2	PIX250B-075-C3	PIX250B-075-C4	PIX250B-075-C6	
Performance						
	Unit					
Peak Force	N	400	800	1200	1600	2400
Continuous Force @ 100°C*	N	183	366	549	733	1099
Continuous Stall Force @ 100°C*	N	130	259	389	518	777
Peak Power @ 100°C	W	553	1106	1659	2213	3319
Continuous Power @ 100°C*	W	61	123	184	246	369
Electrical						
Peak Current	A ^{pk}	20.4	20.4	20.4	40.8	61.2
Continuous Current @ 100°C*	A ^{pk}	6.8	6.8	6.8	13.6	20.4
Continuous Stall Current @ 100°C*	Arms	4.8	4.8	4.8	9.6	14.4
Force Constant	N/A ^{pk}	26.9	53.9	80.8	53.9	53.9
Back EMF Constant	V ^{pk} /m/s	31.1	62.2	93.3	62.2	62.2
Coil Resistance L-L @ 25°C	ohm	1.4	2.7	4.1	1.4	0.9
Coil Resistance L-L @ 100°C*	ohm	1.8	3.5	5.3	1.8	1.2
Inductance L-L @ 1kHz	mH	19.6	39.2	58.8	19.6	13.1
Motor Constant @ 25°C*	N//W	26.7	37.7	46.2	53.3	65.3
Motor Constant @ 100°C*	N//W	23.4	33.0	40.5	46.7	57.2
Max. Terminal Voltage	Vdc	600				
Thermal						
Thermal Resistance @ 100°C*	°C/W	1.22	0.61	0.41	0.31	0.20
Max. Winding Temperature	°C	100				
Mechanical						
Coil Weight	kg	2.1	4.0	5.9	7.8	11.6
Attractive Force	kN	0.82	1.64	2.46	3.28	4.92
Electrical Cycle Length	mm	42				

Notes:

1. $A_{pk} = 1.414 \cdot \text{Arms}$; $V_{pk} = 1.414 \cdot V_{rms}$
2. * Ambient temperature 25°C, natural convection, with heat sink of size L x 2W x 12mm. (L = length of coil, W = width of coil)
3. Specifications tolerance : +/-10%
4. Peak force and current : 4% duty ratio and 1 second duration
5. Motor Insulation Class : Class B (130°C)
6. IP Rating : IP00
7. IEC Protection Class : Class 1
8. Compliance Standards : CE, RoHS
9. Ambient Operating Temperature : 0 - 40°C
10. Ambient Operating Humidity : 10 - 90% RH
11. Specifications are subject to change without prior notice.

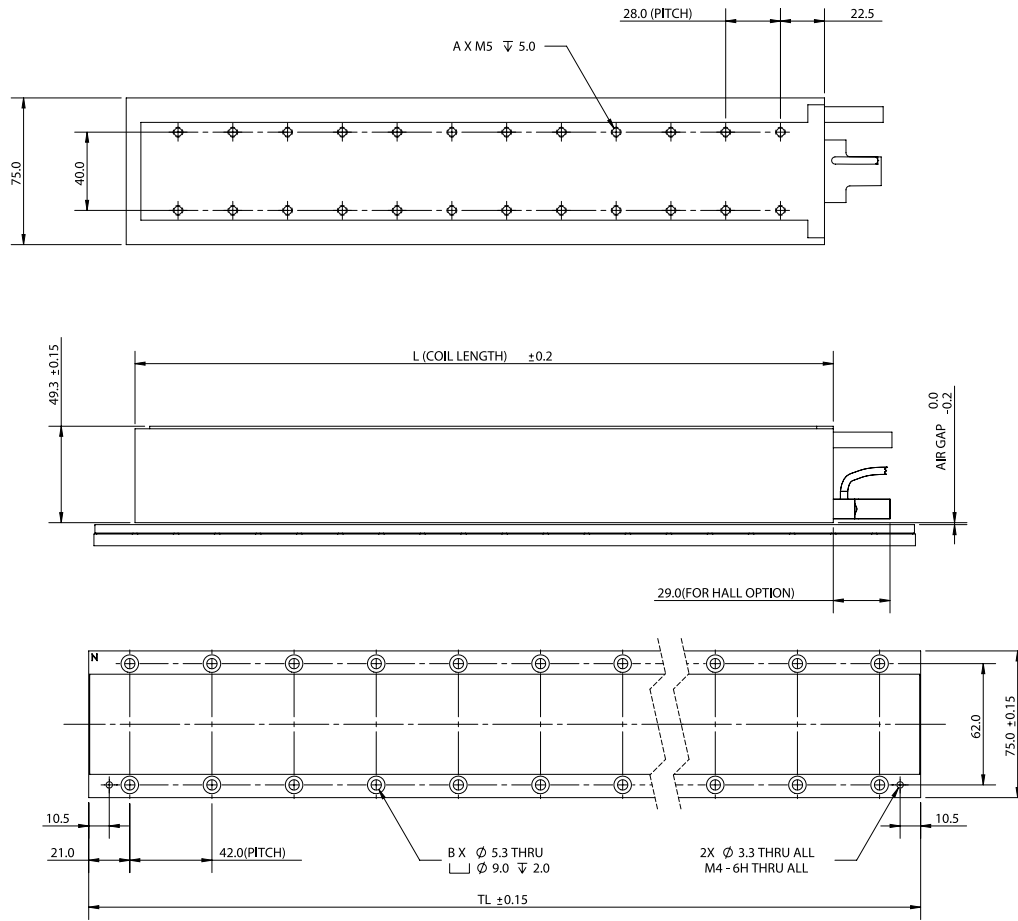

COIL	L	A
PIX250B-075-C1	105	6
PIX250B-075-C2	189	12
PIX250B-075-C3	273	18
PIX250B-075-C4	357	24
PIX250B-075-C6	525	36

MAGNET TRACK	TL	B	WEIGHT (kg)
PIXM250-075-TL168-NC/C	168	8	0.87
PIXM250-075-TL252-NC/C	252	12	1.31
PIXM250-075-TL420-NC/C	420	20	2.17

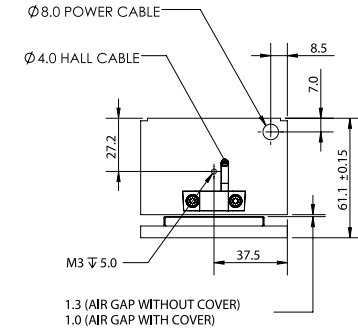

NOTE:
 MOTOR AND HALL CABLES TO OBSERVE:
 FIXED INSTALLATION - STATIC BEND RADIUS $R > 3 \times$ CABLE DIAMETER
 FLEXING INSTALLATION - DYNAMIC BEND RADIUS $R > 10 \times$ CABLE DIAMETER

GRAPH: Force VS Speed

PIX250B-075-C1

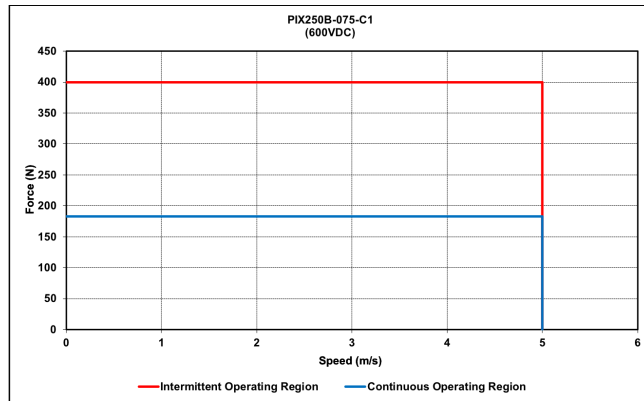
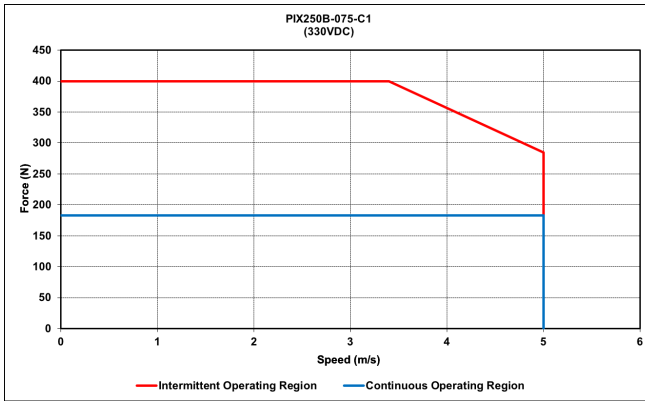

PIX250B-075-C2

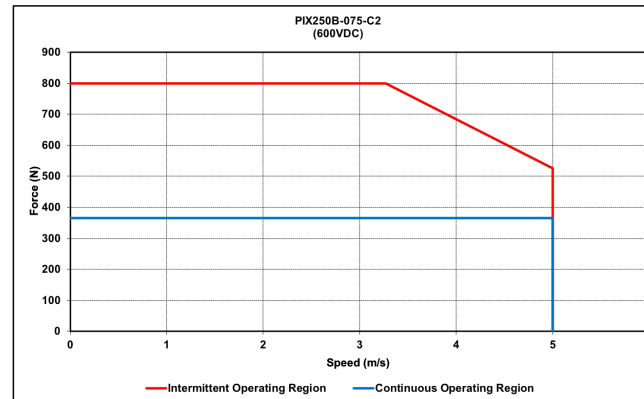
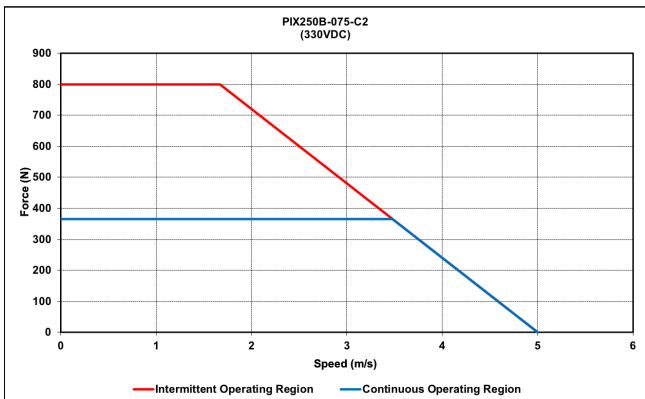

DXB/BT
 PIX
 PSM/PSME
 CVC
 CVCA
 RVCA
 PDDR
 PCA
 PWA
 PLA
 PDAB
 PIAB
 OCTO
 PRG
 LINEAR ENCODER
 SERVO AMPLIFIER

PIX250B-075-C3

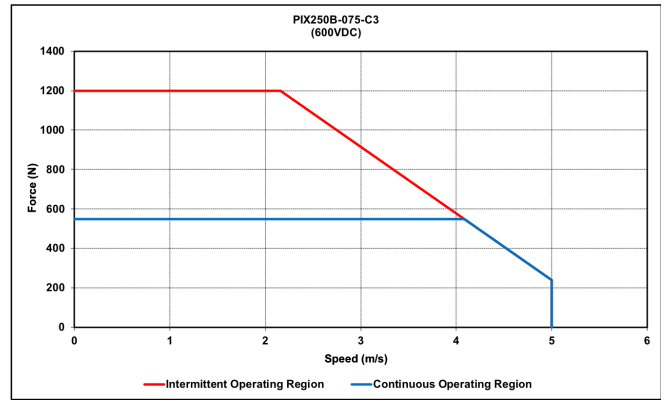
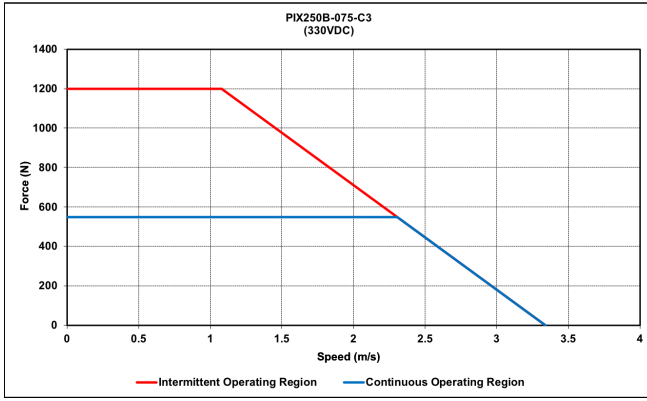

PIX250B-075-C4

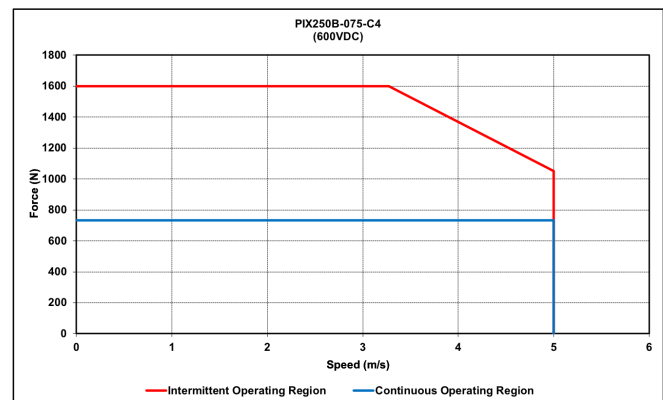
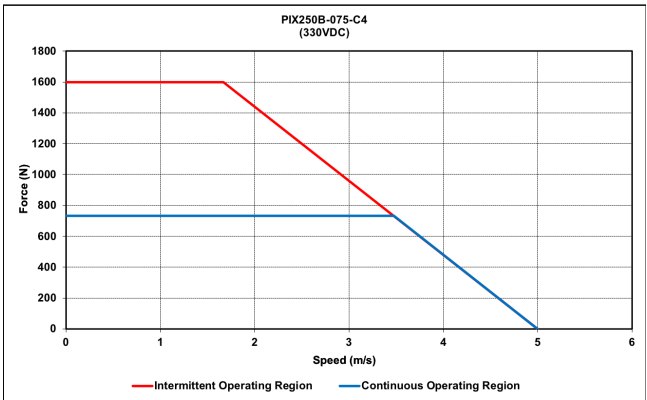

PIX250B-075-C6

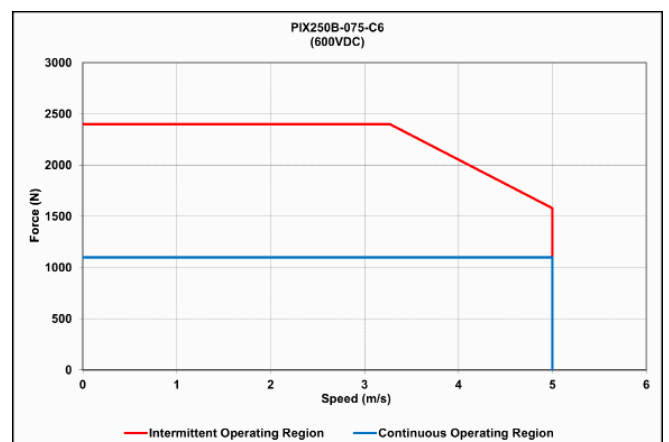
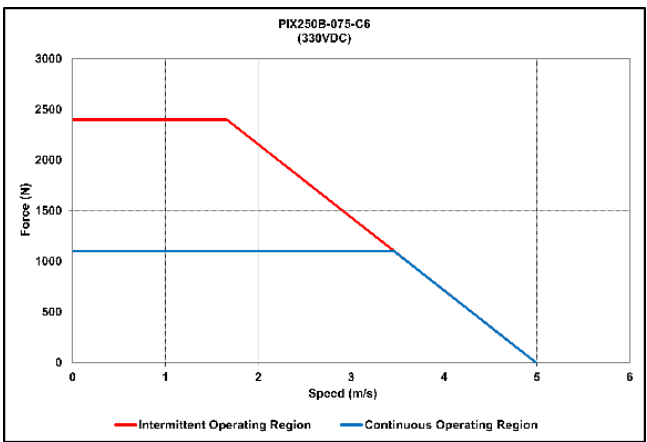

PIX250B SERIES

IRONCORE LINEAR MOTOR

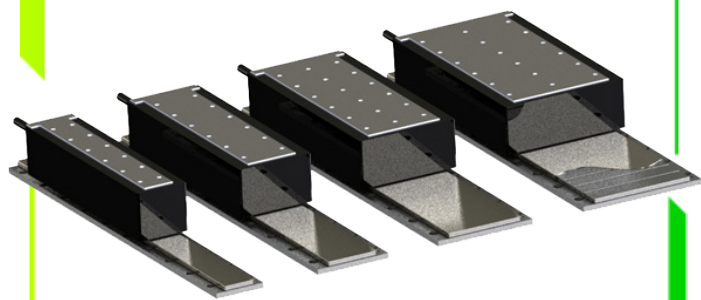

PIX250B - 100

- Peak force up to 3600N, Continuous force up to 1645N
- Hall Sensor (Optional)

SPECIFICATION	MODEL					
	PIX250B-100-C1	PIX250B-100-C2	PIX250B-100-C3	PIX250B-100-C4	PIX250B-100-C6	
Performance	Unit					
Peak Force	N	600	1200	1800	2400	3600
Continuous Force @ 100°C*	N	274	548	823	1097	1645
Continuous Stall Force @ 100°C*	N	194	388	582	776	1164
Peak Power @ 100°C	W	734	1467	2201	2934	4402
Continuous Power @ 100°C*	W	82	163	245	326	489
Electrical						
Peak Current	A ^{pk}	20.4	20.4	20.4	40.7	61.1
Continuous Current @ 100°C*	A ^{pk}	6.8	6.8	6.8	13.6	20.4
Continuous Stall Current @ 100°C*	Arms	4.8	4.8	4.8	9.6	14.4
Force Constant	N/A ^{pk}	40.4	80.8	121.2	80.8	80.8
Back EMF Constant	V ^{pk} /m/s	46.7	93.3	140.0	93.3	93.3
Coil Resistance L-L @ 25°C	ohm	1.8	3.6	5.4	1.8	1.2
Coil Resistance L-L @ 100°C*	ohm	2.4	4.7	7.1	2.4	1.6
Inductance L-L @ 1kHz	mH	28.2	56.3	84.5	28.2	18.8
Motor Constant @ 25°C*	N//W	34.7	49.0	60.1	69.3	84.9
Motor Constant @ 100°C*	N//W	30.4	43.0	52.6	60.8	74.4
Max. Terminal Voltage	Vdc	600				
Thermal						
Thermal Resistance @ 100°C*	°C/W	0.92	0.46	0.31	0.23	0.15
Max. Winding Temperature	°C	100				
Mechanical						
Coil Weight	kg	2.7	4.8	6.9	9.0	13.2
Attractive Force	kN	1.24	2.48	3.72	4.96	7.44
Electrical Cycle Length	mm	42				

- Notes:
1. $A_{pk} = 1.414 \cdot I_{rms}$; $V_{pk} = 1.414 \cdot V_{rms}$
 2. * Ambient temperature 25°C, natural convection, with heat sink of size L x 2W x 12mm. (L = length of coil, W = width of coil)
 3. Specifications tolerance : +/-10%
 4. Peak force and current : 4% duty ratio and 1 second duration
 5. Motor Insulation Class : Class B (130°C)
 6. IP Rating : IP00
 7. IEC Protection Class : Class 1
 8. Compliance Standards : CE, RoHS
 9. Ambient Operating Temperature : 0 - 40°C
 10. Ambient Operating Humidity : 10 - 90% RH
 11. Specifications are subject to change without prior notice.

DXB/BT
 PIX
 PSM/PSME
 CVC
 CVCA
 RVCA
 PDDR
 PCA
 PWA
 PLA
 PDAB
 PIAB
 OCTO
 PRG
 LINEAR ENCODER
 SERVO AMPLIFIER

PIX250B-100

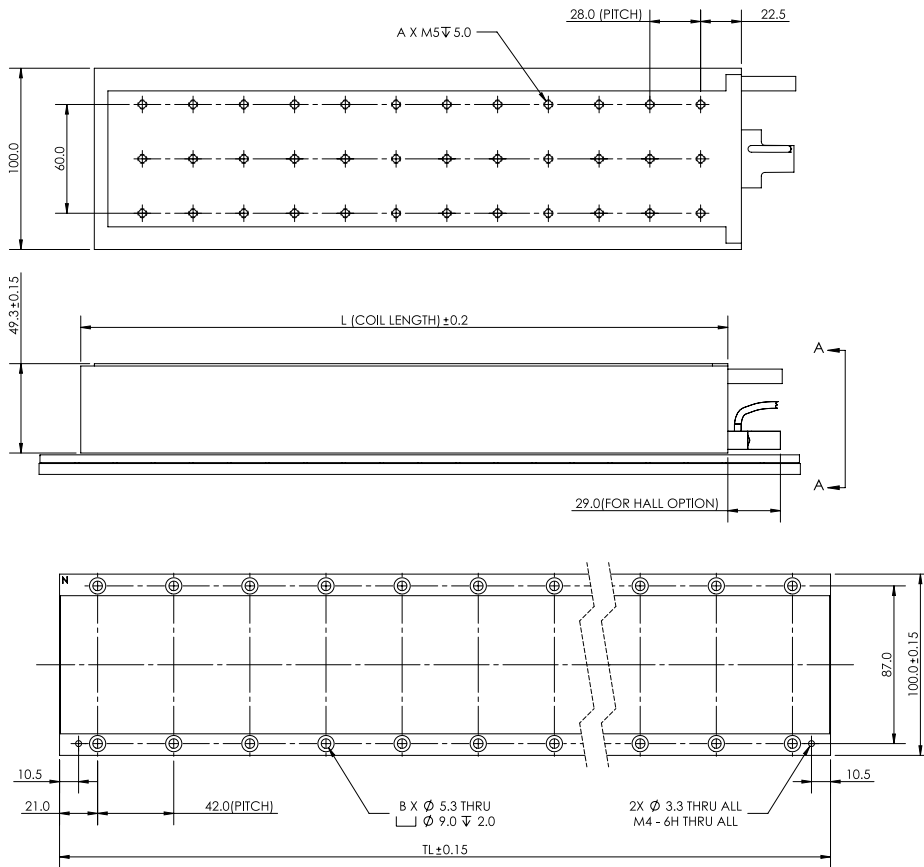

COIL	L	A
PIX250B-100-C1	105	9
PIX250B-100-C2	189	18
PIX250B-100-C3	273	27
PIX250B-100-C4	357	36
PIX250B-100-C6	525	54

MAGNET TRACK	TL	B	WEIGHT (kg)
PIXM250-100-TL168-NC/C	168	8	1.25
PIXM250-100-TL252-NC/C	252	12	1.90
PIXM250-100-TL420-NC/C	420	20	3.10

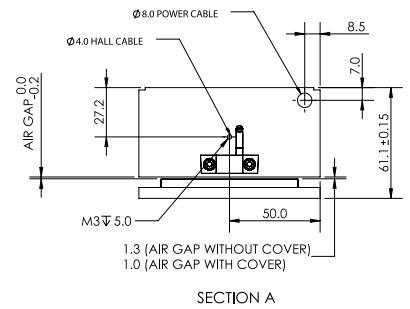

NOTE:
 MOTOR AND HALL CABLES TO OBSERVE:
 FIXED INSTALLATION: STATIC BEND RADIUS $R > 3 \times$ CABLE DIAMETER
 FLEXING INSTALLATION: DYNAMIC BEND RADIUS $R > 10 \times$ CABLE DIAMETER

GRAPH: Force VS Speed

PIX250B-100-C1

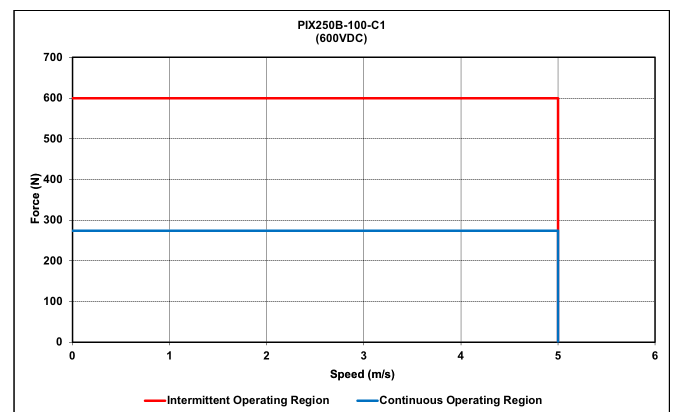
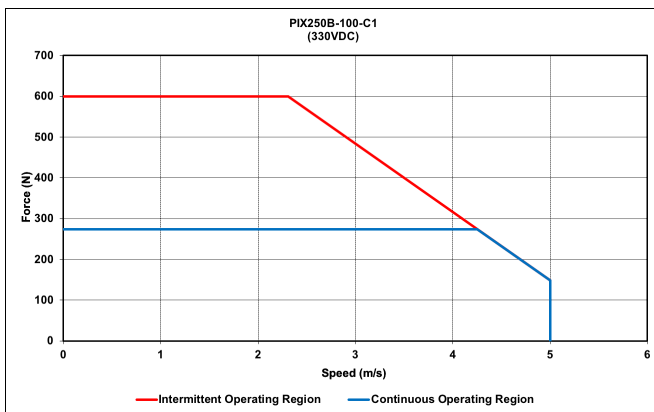

PIX250B-100-C2

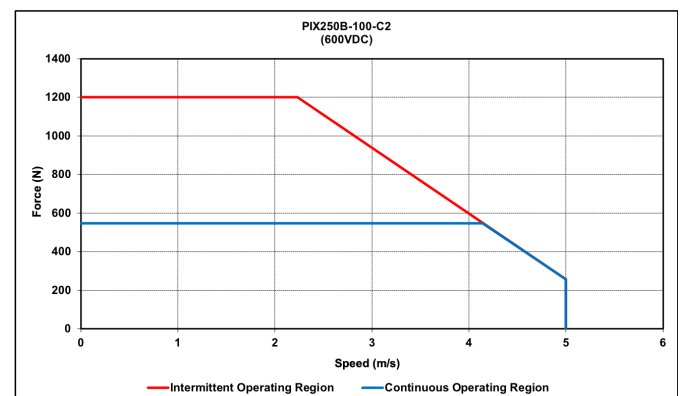
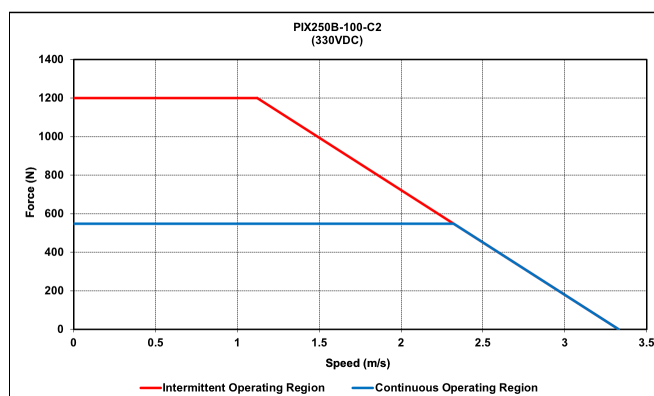

PIX250B-100-C3

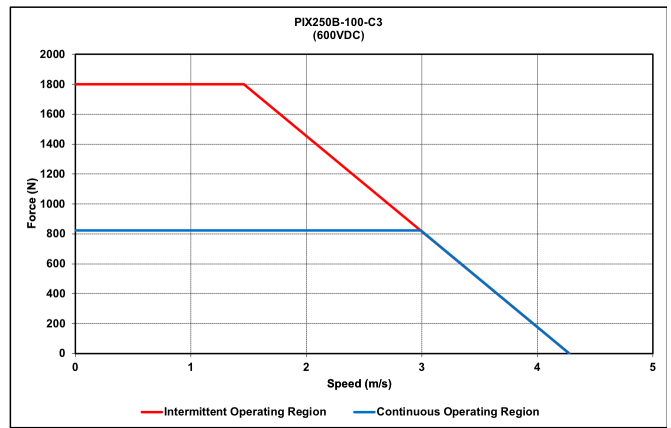
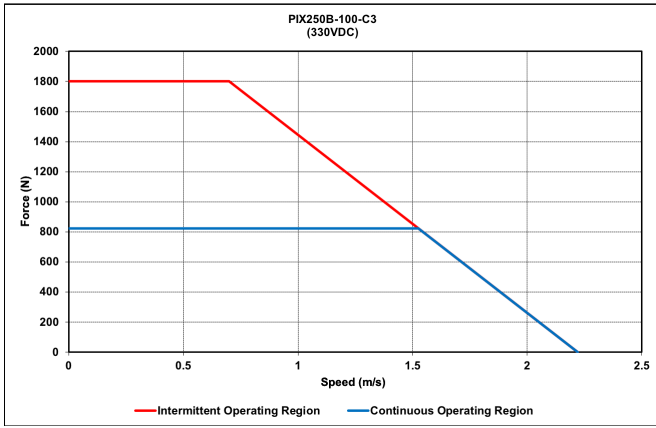

PIX250B-100-C4

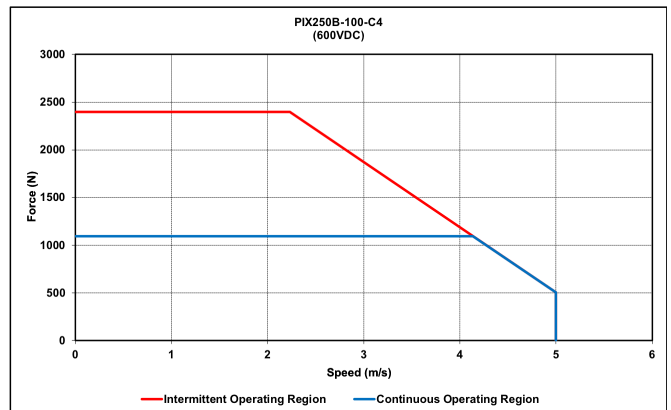
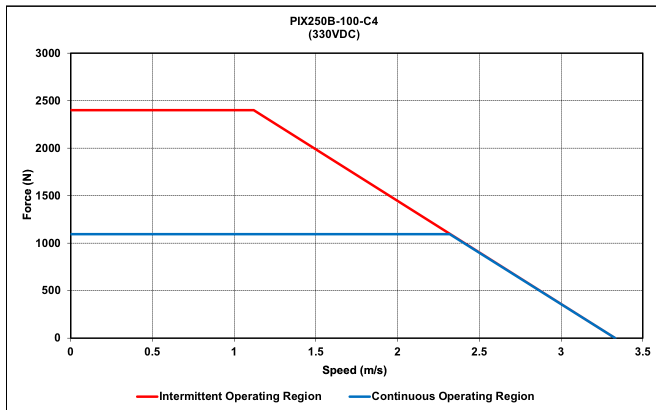

PIX250B-100-C6

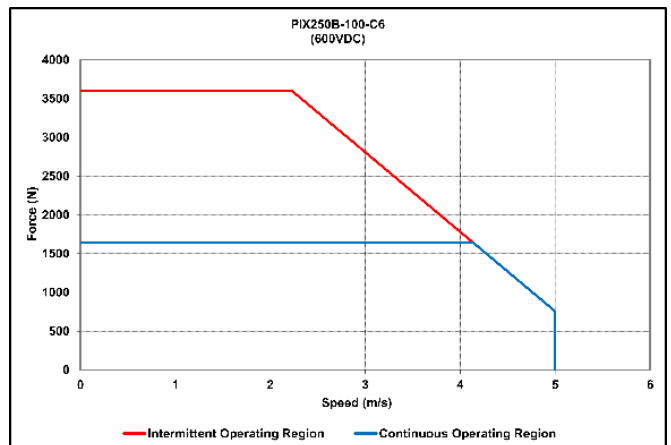
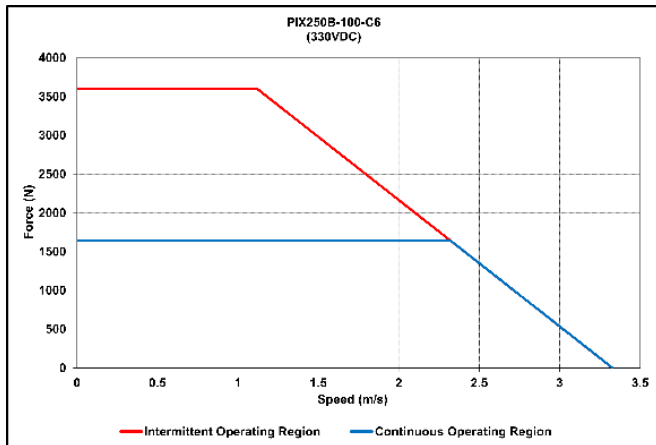

- DXB/BT
- PIX**
- PSM/PSME
- CVC
- CVCA
- RVCA
- PDDR
- PCA
- PWA
- PLA
- PDAB
- PIAB
- OCTO
- PRG
- LINEAR ENCODER
- SERVO AMPLIFIER

PIX250B SERIES

IRONCORE LINEAR MOTOR

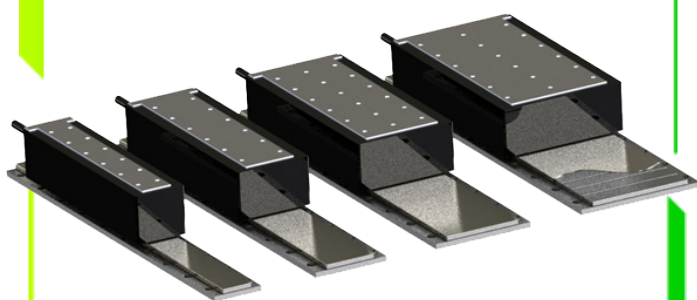

PIX250B - 125

- Peak force up to 4800N, Continuous force up to 1194N
- Hall Sensor (Optional)

SPECIFICATION	MODEL					
	PIX250B-125-C1	PIX250B-125-C2	PIX250B-125-C3	PIX250B-125-C4	PIX250B-125-C6	
Performance		Unit				
Peak Force	N	800	1600	2400	3200	4800
Continuous Force @ 100°C*	N	366	731	1097	1463	2194
Continuous Stall Force @ 100°C*	N	259	517	776	1034	1551
Peak Power @ 100°C	W	892	1783	2675	3567	5350
Continuous Power @ 100°C*	W	99	198	297	396	594
Electrical						
Peak Current	A ^{pk}	20.4	20.4	20.4	40.7	61.1
Continuous Current @ 100°C*	A ^{pk}	6.8	6.8	6.8	13.6	20.4
Continuous Stall Current @ 100°C*	Arms	4.8	4.8	4.8	9.6	14.4
Force Constant	N/A ^{pk}	53.9	107.7	161.6	107.7	107.7
Back EMF Constant	V ^{pk} /m/s	62.2	124.4	186.6	124.4	124.4
Coil Resistance L-L @ 25°C	ohm	2.2	4.4	6.6	2.2	1.5
Coil Resistance L-L @ 100°C*	ohm	2.9	5.7	8.6	2.9	1.9
Inductance L-L @ 1kHz	mH	35.5	70.9	106.4	35.5	23.6
Motor Constant @ 25°C*	N//W	41.9	59.3	72.6	83.9	102.7
Motor Constant @ 100°C*	N//W	36.7	52.0	63.6	73.5	90.0
Max. Terminal Voltage	Vdc	600				
Thermal						
Thermal Resistance @ 100°C*	°C/W	0.76	0.38	0.25	0.19	0.13
Max. Winding Temperature	°C	100				
Mechanical						
Coil Weight	kg	3.9	7.3	10.7	14.0	27.0
Attractive Force	kN	1.65	3.3	4.95	6.6	9.9
Electrical Cycle Length	mm	42				

Notes:

1. $A_{pk} = 1.414 * Arms$; $V_{pk} = 1.414 * V_{rms}$
2. * Ambient temperature 25°C, natural convection, with heat sink of size L x 2W x 12mm. (L = length of coil, W = width of coil)
3. Specifications tolerance : +/- 10%
4. Peak force and current : 4% duty ratio and 1 second duration
5. Motor Insulation Class : Class B (130°C)
6. IP Rating : IP00
7. IEC Protection Class : Class 1
8. Compliance Standards : CE, RoHS
9. Ambient Operating Temperature : 0 - 40°C
10. Ambient Operating Humidity : 10 - 90% RH
11. Specifications are subject to change without prior notice.

PIX250B-125

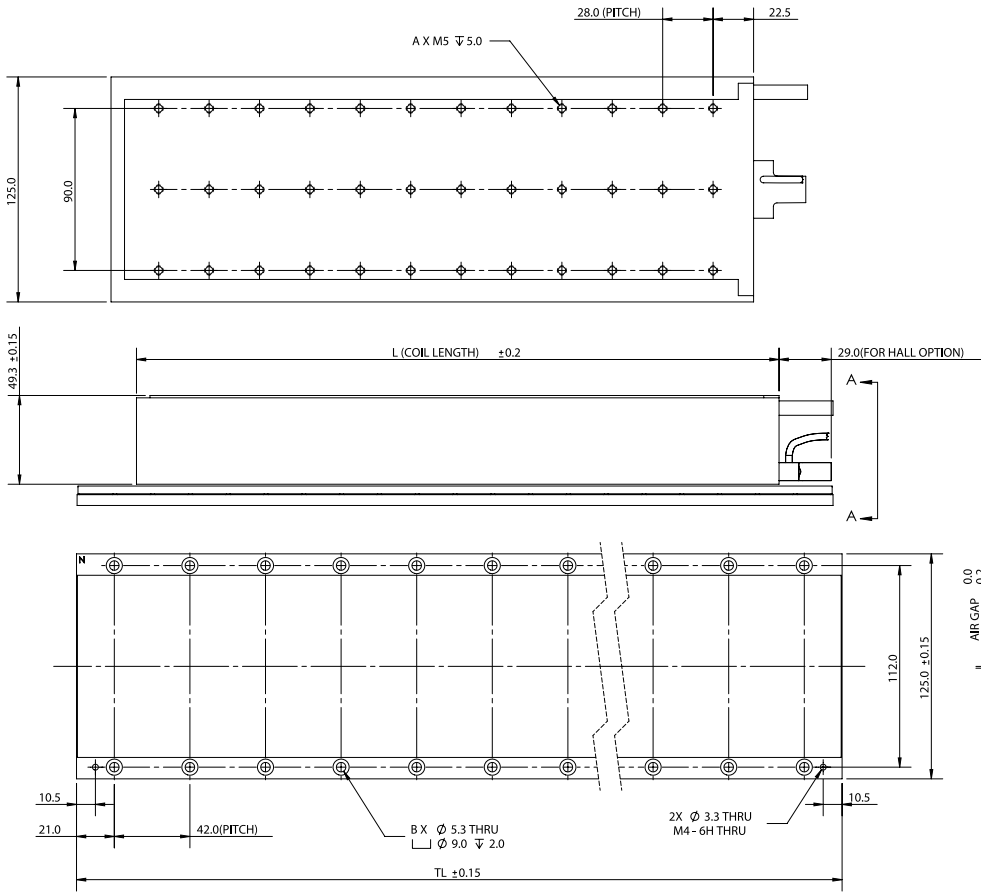

COIL	L	A
PIX250B-125-C1	105	9
PIX250B-125-C2	189	18
PIX250B-125-C3	273	27
PIX250B-125-C4	357	36
PIX250B-125-C6	525	54

MAGNET TRACK	TL	B	WEIGHT (kg)
PIXM250-125-TL168-NC/C	168	8	1.50
PIXM250-125-TL252-NC/C	252	12	2.24
PIXM250-125-TL420-NC/C	420	20	3.74

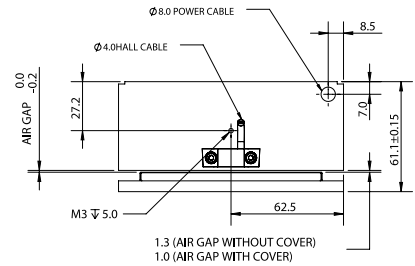

NOTE:
 MOTOR AND HALL CABLES TO OBSERVE:
 FIXED INSTALLATION: STATIC BEND RADIUS $R > 3 \times$ CABLE DIAMETER
 FLEXING INSTALLATION: DYNAMIC BEND RADIUS $R > 10 \times$ CABLE DIAMETER

GRAPH: Force VS Speed

PIX250B-125-C1

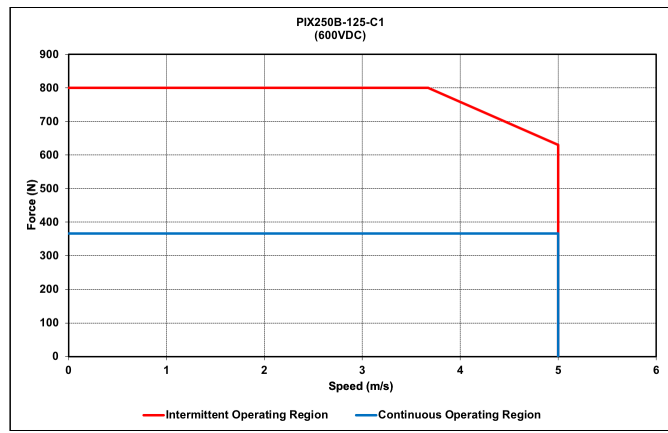
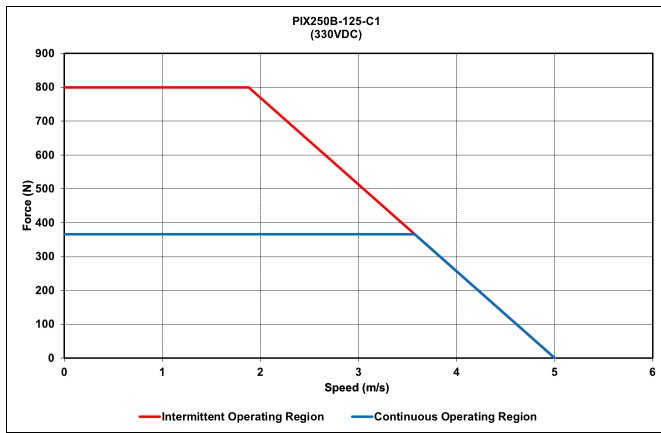

PIX250B-125-C2

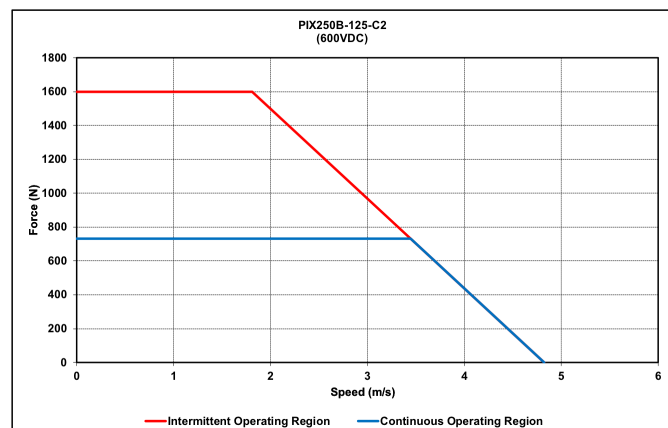
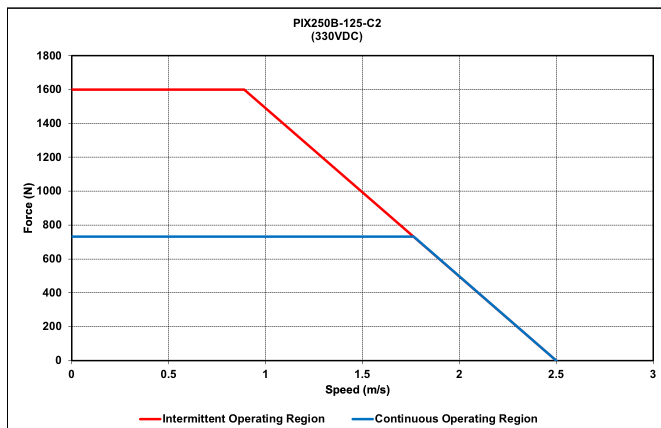

DXB/BT
 PIX
 PSM/PSME
 CVC
 CVCA
 RVCA
 PDDR
 PCA
 PWA
 PLA
 PDAB
 PIAB
 OCTO
 PRG
 LINEAR ENCODER
 SERVO AMPLIFIER

PIX250B-125-C3

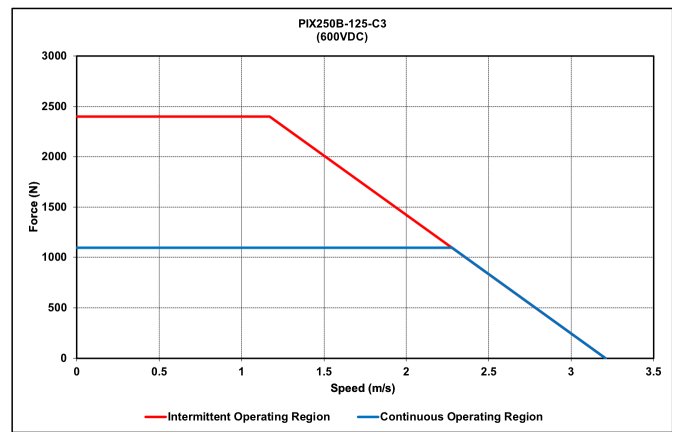
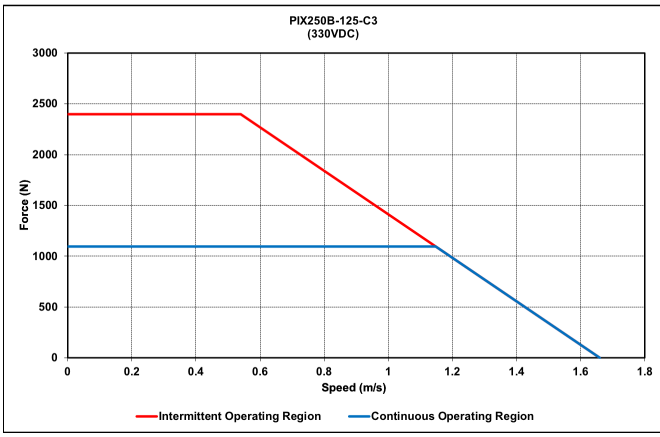

PIX250B-125-C4

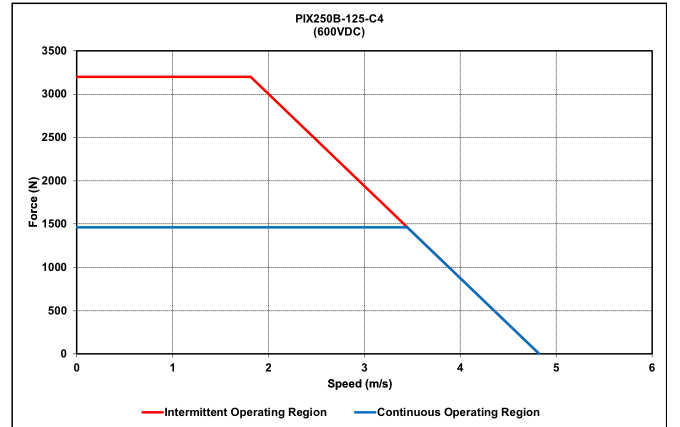
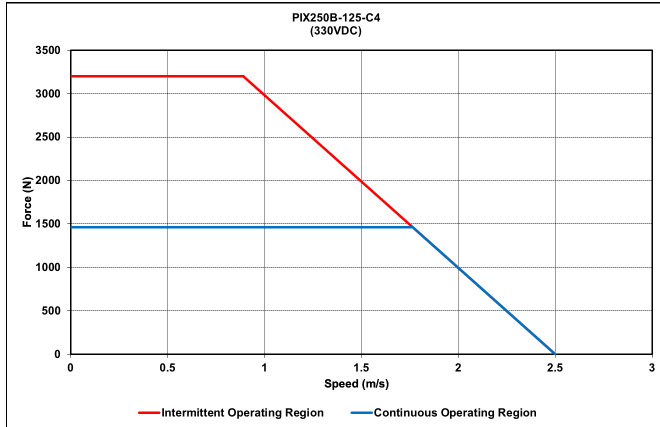

PIX250B-125-C

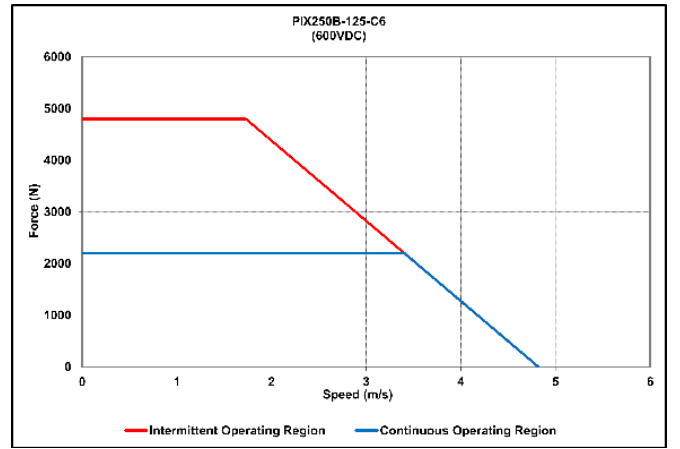
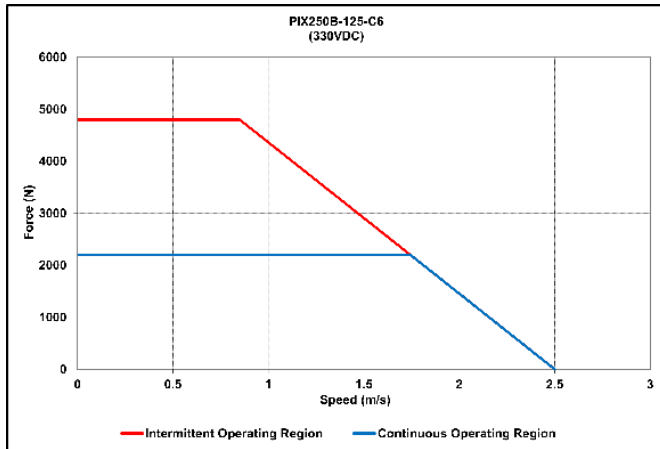

CABLE OPTION

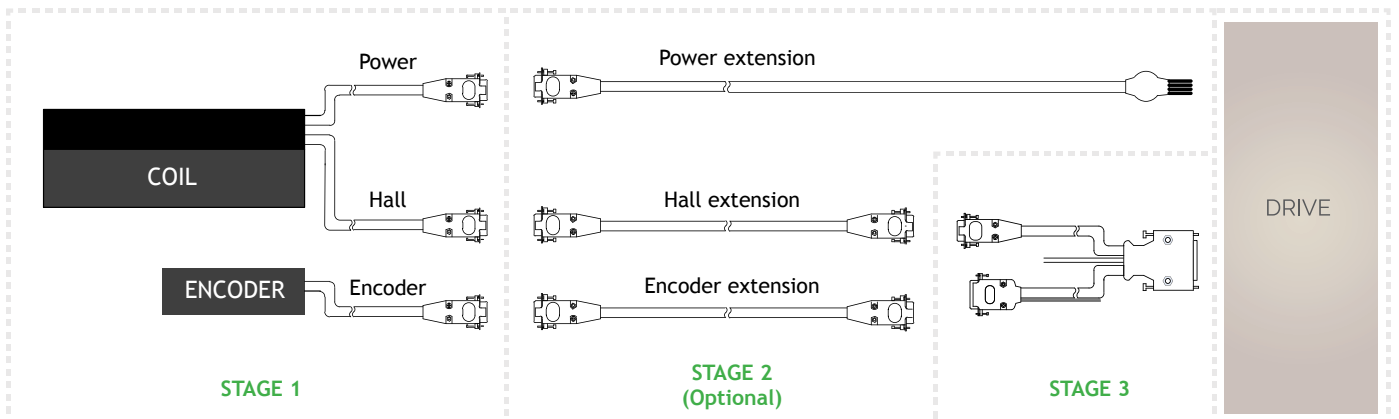

THERMAL PROTECTION

The temperature at which the thermal device is activated is shown below

MODEL	THERMAL DEVICE TYPE	
PIX250B	PT100	TC: Refer to note 1
PIX250B	THERMOSTAT	TM: (NC) Opens at 100°C

Note 1:

- Programmable and can be used where there are temperature controllers or drivers/motion controllers with analog inputs.
- Recommended to set cut-off temperature to 100°C (max) to prevent coil damage.
- User has to ensure that the thermal protection devices are wired to appropriate electronics to ensure that the motor power cutoff is active when temperature reaches its allowable limit.

STAGE 1 | POWER AND HALL CABLE OPTION

PIX250B-050-C1-TM-O.5-NC-NF-HC-00

POWER CABLE OPTIONS		HALL SENSOR OPTIONS																			
NF																					
FC	PIX250B-XXX-C1 to C3	<table border="1"> <tr><td>M1</td><td>Red</td></tr> <tr><td>M2</td><td>Blue</td></tr> <tr><td>M3</td><td>Brown</td></tr> <tr><td>PE</td><td>Yellow</td></tr> <tr><td>TS1</td><td>Red</td></tr> <tr><td>TS2</td><td>Black</td></tr> </table>	M1	Red	M2	Blue	M3	Brown	PE	Yellow	TS1	Red	TS2	Black							
	M1	Red																			
M2	Blue																				
M3	Brown																				
PE	Yellow																				
TS1	Red																				
TS2	Black																				
	PIX250B-XXX-C4 to C6																				
9NF		<table border="1"> <tr><td>A1</td><td>M1</td><td>Red</td></tr> <tr><td>A2</td><td>M2</td><td>Blue</td></tr> <tr><td>A3</td><td>M3</td><td>Brown</td></tr> <tr><td>P1</td><td>TS1</td><td>Red</td></tr> <tr><td>P3</td><td>TS2</td><td>Black</td></tr> <tr><td>A4</td><td>PE</td><td>Yellow</td></tr> </table>	A1	M1	Red	A2	M2	Blue	A3	M3	Brown	P1	TS1	Red	P3	TS2	Black	A4	PE	Yellow	
	A1	M1	Red																		
A2	M2	Blue																			
A3	M3	Brown																			
P1	TS1	Red																			
P3	TS2	Black																			
A4	PE	Yellow																			
H		<table border="1"> <tr><td>Hall A</td><td>White</td></tr> <tr><td>Hall B</td><td>Green</td></tr> <tr><td>Hall C</td><td>Blue</td></tr> <tr><td>5V</td><td>Red</td></tr> <tr><td>0V</td><td>Black</td></tr> </table>	Hall A	White	Hall B	Green	Hall C	Blue	5V	Red	0V	Black									
	Hall A	White																			
Hall B	Green																				
Hall C	Blue																				
5V	Red																				
0V	Black																				
HC		<table border="1"> <tr><td>P1</td><td>Hall A</td><td>White</td></tr> <tr><td>P2</td><td>Hall B</td><td>Green</td></tr> <tr><td>P3</td><td>Hall C</td><td>Blue</td></tr> <tr><td>P4</td><td>5V</td><td>Red</td></tr> <tr><td>P5</td><td>0V</td><td>Black</td></tr> </table>	P1	Hall A	White	P2	Hall B	Green	P3	Hall C	Blue	P4	5V	Red	P5	0V	Black				
	P1	Hall A	White																		
P2	Hall B	Green																			
P3	Hall C	Blue																			
P4	5V	Red																			
P5	0V	Black																			
CHC		<table border="1"> <tr><td>P1</td><td>Hall A</td><td>White</td></tr> <tr><td>P2</td><td>Hall B</td><td>Green</td></tr> <tr><td>P3</td><td>Hall C</td><td>Blue</td></tr> <tr><td>P4</td><td>5V</td><td>Red</td></tr> <tr><td>P5</td><td>0V</td><td>Black</td></tr> </table>	P1	Hall A	White	P2	Hall B	Green	P3	Hall C	Blue	P4	5V	Red	P5	0V	Black				
	P1	Hall A	White																		
P2	Hall B	Green																			
P3	Hall C	Blue																			
P4	5V	Red																			
P5	0V	Black																			
HCL		<table border="1"> <tr><td>P1</td><td>Hall A+</td></tr> <tr><td>P2</td><td>Hall A-</td></tr> <tr><td>P3</td><td>Hall B+</td></tr> <tr><td>P4</td><td>Hall B-</td></tr> <tr><td>P5</td><td>Hall C+</td></tr> <tr><td>P6</td><td>Hall C-</td></tr> <tr><td>P7</td><td>5V</td></tr> <tr><td>P8</td><td>0V</td></tr> </table>	P1	Hall A+	P2	Hall A-	P3	Hall B+	P4	Hall B-	P5	Hall C+	P6	Hall C-	P7	5V	P8	0V			
	P1	Hall A+																			
P2	Hall A-																				
P3	Hall B+																				
P4	Hall B-																				
P5	Hall C+																				
P6	Hall C-																				
P7	5V																				
P8	0V																				

Notes: All connectors shown are front view

DXB/BT
 PIX
 PSM/PSME
 CVC
 CVCA
 RVCA
 PDDR
 PCA
 PWA
 PLA
 PDAB
 PIAB
 OCTO
 PRG
 LINEAR ENCODER
 SERVO AMPLIFIER

STAGE 2 | PIX250B SERIES EXTENSION CABLE

Connection example: PIX250B-□-□-□-□-□-9NF-HC-00

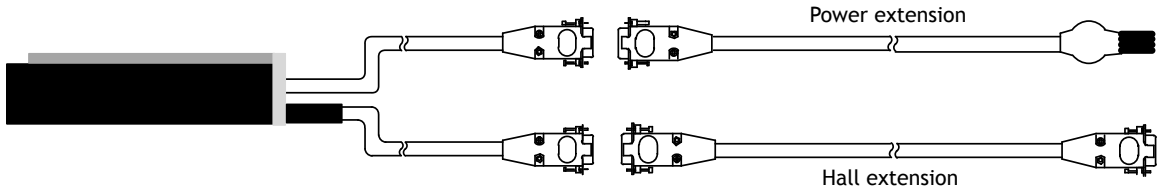

	Extension Cable	Part Number
Power Extension Cable		CBL_EXT_PWR3_X.X (PIX250B-XXX-C1 to C3)
		CBL_EXT_PWR4_X.X (PIX250B-XXX-C4)
		CBL_EXT_PWR5_X.X (PIX250B-XXX-C6)
Hall Sensor Extension Cable		CBL_EXT_HALL0_X.X
		CBL_EXT_HALL0_CC_X.X
		CBL_EXT_HALL0_DIF_X.X
Encoder Extension Cable		CBL_EXT_REN00_X.X
		CBL_EXT_REN00A_X.X
		CBL_EXT_REN01_X.X
		CBL_EXT_REN01B_X.X
		CBL_EXT_REN05_X.X
		CBL_EXT_REN05A_X.X

	CABLE	CABLE LENGTH (X.X)	
00	RGH41, VIONIC, QUANTIC Digital	0.5	0.5 meter
		1.0	1.0meter
00A	RGH41 Analog	2.0	2.0 meter
01	RH200 Digital	3.0	3.0 meter (standard)
01B	PH200 Analog		
05	ATOM Ri Interface Digital		
05A	ATOM Ri Interface Analog		

Notes: 1. X.X is the length of the cable in meters. 2. For customized cable length, contact PBA

HALL SENSOR MODULE PART NUMBERING SYSTEM

Hall Sensor Module Assembly

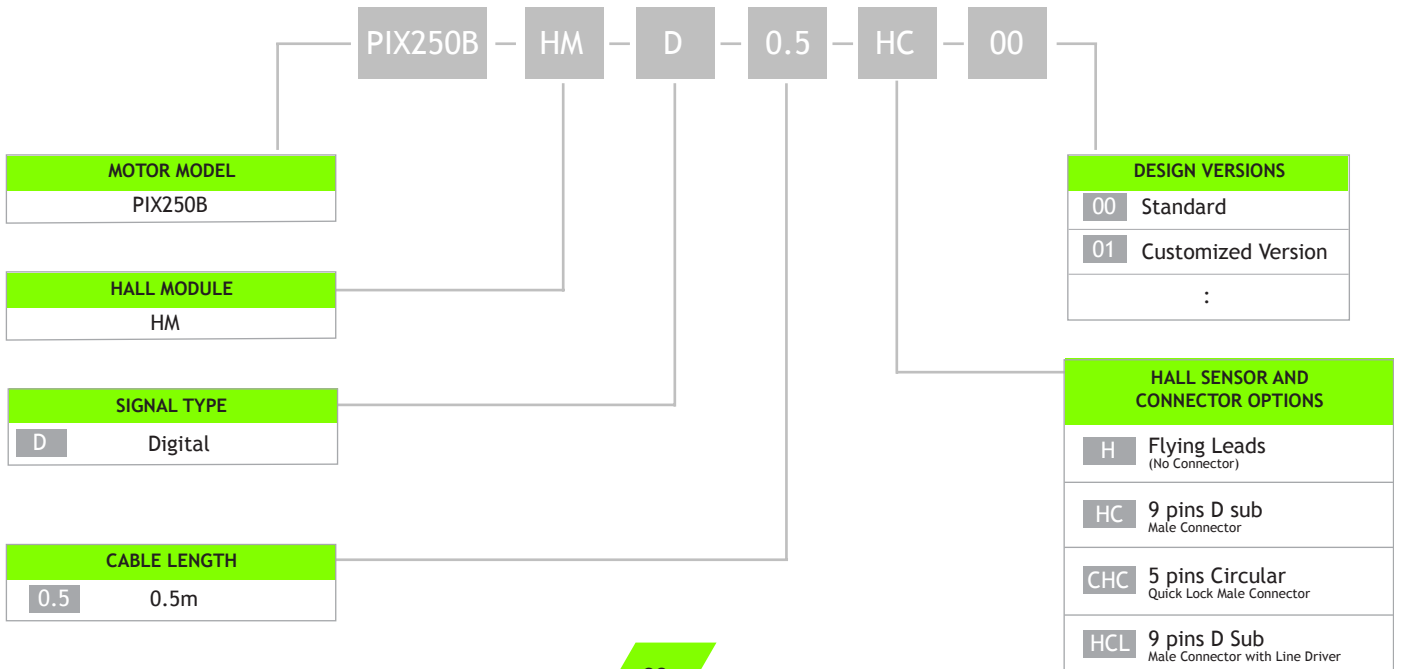

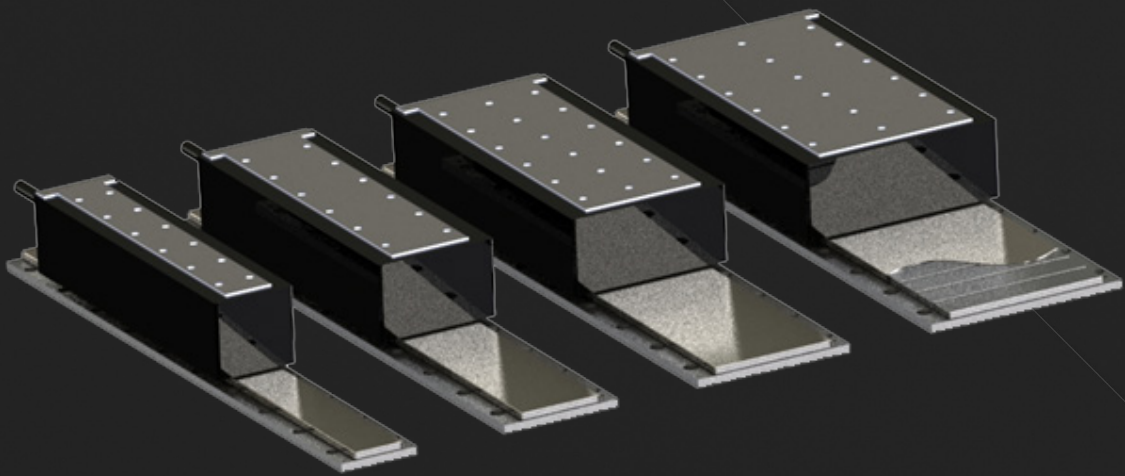

PIX350B SERIES
IRONCORE LINEAR MOTOR



PIX350B SERIES

IRONCORE LINEAR MOTOR

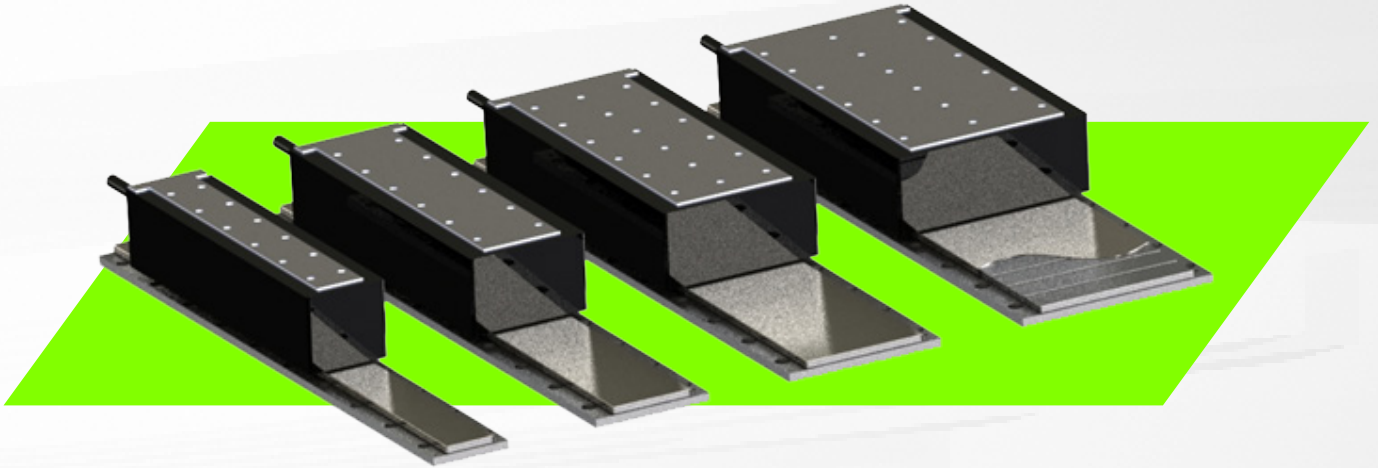

PIX B Iron core motors offer an affordable high force solution to demanding linear applications with an anti-cogging effect that is associated with traditional iron core linear motors.

Our Ironcore is designed for optimal dissipation of heat and thus capable of extremely high forces. These motor coils are manufactured with high flex cables and optional external hall effect attachments widely used in multiple general automation applications.

Modular Flat Magnet tracks are available in different length increments to complete this product selection and allow for easy assembly of un-restricted effective stroke by butting tracks of different lengths together.

- High Power Density
- Anti-cogging design for smooth operation
- Efficient cooling system
- High speed, acceleration and fast response
- High Synchronous run
- Zero backlash - direct drive technology
- Maintenance-free operation - mechanical simplicity due to reduced component count
- Long travels without performance loss

APPLICATION

- Material Transfer/Pick and place
- Packaging
- Semiconductor Machine
- Photovoltaic
- Laser Cutting
- Lithium battery production
- Machine Tools
- Large format printing
- Glass and LCD transfer

**Technical specifications subject to change without prior notice*

PART NUMBERING SYSTEM

43

PIX350B - 180

44

PIX350B - 250

47

Motor Model	Coil Size	Continuous Force (N)	Peak Force (N)	Continuous Current (A ^{pk})	Peak Current (A ^{pk})	Coil Weight (Kg)	Motor Dimensions without Hall Sensor LxWxH (mm)	Motor Dimensions with Hall Sensor LxWxH (mm)
PIX350B-180	C4	2052	4800	12.7	40.8	17.6	357 x 180 x 64.1	386 x 180 x 64.1
	C6	3078	7200	19.1	61.1	25.9	525 x 180 x 64.1	554 x 180 x 64.1
	C8	4104	9600	25.5	81.5	34.2	693 x 180 x 64.1	722 x 180 x 64.1
PIX350B-250	C4	2736	6400	12.7	40.8	24.4	357 x 250 x 64.1	386 x 250 x 64.1
	C6	4101	9600	19.1	61.1	35.9	525 x 250 x 64.1	554 x 250 x 64.1
	C8	5471	12800	25.5	81.5	47.4	693 x 250 x 64.1	722 x 250 x 64.1

Note: Continuous force is measured under natural convection, refer to the detail parameters table for more information

DXB/BT
PIX
PSM/PSME
CVC
CVCA
RVCA
PDDR
PCA
PVA
PLA
PDAB
PIAB
OCTO
PRG
LINEAR ENCODER
SERVO AMPLIFIER

Force Chart for PIX350B Linear Motor

Force Chart For PIX350B Motors

PIX350B Product Series

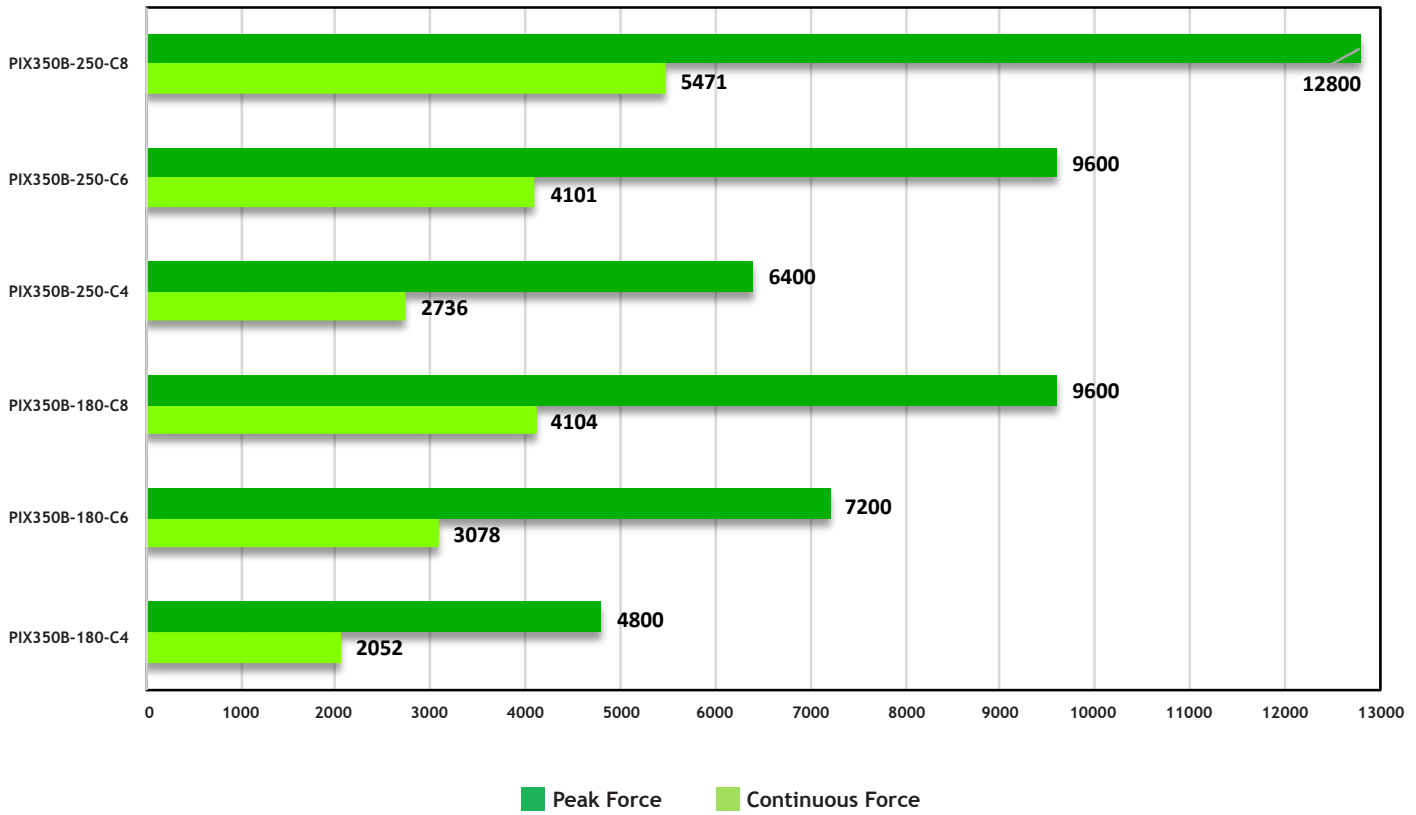

PART NUMBERING SYSTEM

COIL ASSEMBLY

PIX350B-180 - C4 - TM - 0.5 - NC - 9NF - HC - 00

MOTOR MODEL	
PIX350B-180	
PIX350B-250	

MOTOR COIL SIZE	
C4	
C6	
C8	

THERMAL PROTECTION	
TC*	PT100 Sensor
TM**	Thermostat

CABLE LENGTH	
0.5	Power and Hall sensor cable

COOLING TYPE	
NC	Normal Convection

DESIGN VERSIONS	
00	Standard
01	Customised Version
:	

HALL SENSOR AND CONNECTOR OPTIONS	
NH	No Hall Sensor
H	Hall Sensor With Flying Leads
HC	Hall Sensor with 9 D sub Male Connector
CHC	Hall Sensor with 5 pins Circular Quick Lock Male Connector
HCL	9 pins D Sub Male Connector with Line Driver

POWER CABLE OPTIONS	
NF	No Ferrite Core (Flying Leads)
9NF	No Ferrite Core, D Sub 9 pins Female Connector

* TC - Sensor output to temperature controller
 ** TM - On/Off switch, triggers at 100° C

MAGNET TRACK

PIXM350-180 - TL420 - C -

MOTOR MODEL	
PIXM350-180	
PIXM350-250	

TRACK LENGTH	
TL168	168mm
TL252	252mm
TL420	420mm

TRACK COVER	
NC	No Cover
C	With Cover

DESIGN VERSIONS	
	Standard
01	Customized Version
:	

DXB/BT
 PIX
 PSM/PSME
 CVC
 CVCA
 RVCA
 PDDR
 PCA
 PWA
 PLA
 PDAB
 PIAB
 OCTO
 PRG
 LINEAR ENCODER
 SERVO AMPLIFIER

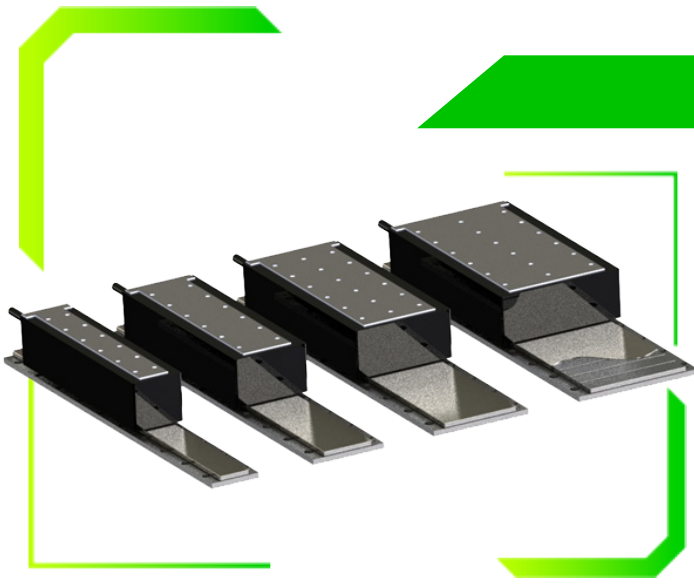

PIX350B SERIES

IRONCORE LINEAR MOTOR

PIX350B - 180

- Peak force up to 9600N, Continuous force up to 4104N
- Hall Sensor (Optional)

SPECIFICATION		MODEL		
		PIX350B-180-C4	PIX350B-180-C6	PIX350B-180-C8
Performance		Unit		
Peak Force	N	4800	7200	9600
Continuous Force @ 100°C*	N	2052	3078	4104
Continuous Stall Force @ 100°C*	N	1256	1885	2513
Peak Power @ 100°C	W	4839	7258	9677
Continuous Power @ 100°C*	W	473	709	945
Electrical				
Peak Current	A ^{pk}	40.8	61.1	81.5
Continuous Current @ 100°C*	A ^{pk}	12.7	19.1	25.5
Continuous Stall Current @ 100°C*	Arms	7.8	11.7	15.6
Force Constant	N/A ^{pk}	161.1	161.1	161.1
Back EMF Constant	V ^{pk} /m/s	186.0	186.0	186.0
Coil Resistance L-L @ 25°C	ohm	3.0	2.0	1.5
Coil Resistance L-L @ 100°C*	ohm	3.9	2.6	1.9
Inductance L-L @ 1kHz	mH	50.2	33.5	25.1
Motor Constant @ 25°C*	N/√W	107.7	132.0	152.4
Motor Constant @ 100°C*	N/√W	94.4	115.6	133.5
Max. Terminal Voltage	Vdc	600		
Thermal				
Thermal Resistance @ 100°C*	°C/W	0.16	0.11	0.08
Max. Winding Temperature	°C	120		
Mechanical				
Coil Weight	kg	17.6	25.9	34.2
Attractive Force	kN	9.92	14.88	19.84
Electrical Cycle Length	mm	42		

Notes:

1. $A_{pk} = 1.414 \cdot I_{rms}$; $V_{pk} = 1.414 \cdot V_{rms}$
2. * Ambient temperature 25°C, natural convection, with heat sink of size L x 2W x 12mm. (L = length of coil, W = width of coil)
3. Specifications tolerance : +/- 10%
4. Peak force and current : 4% duty ratio and 1 second duration
5. Motor Insulation Class : Class B (130°C)
6. IP Rating : IP00
7. IEC Protection Class : Class 1
8. Compliance Standards : CE, RoHS
9. Ambient Operating Temperature : 0 - 40°C
10. Ambient Operating Humidity : 10 - 90% RH
11. Specifications are subject to change without prior notice.

PIX350B-180

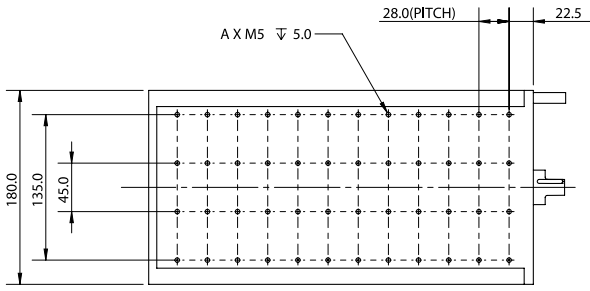

COIL	L	A
PIX350B-180-C4	357	48
PIX350B-180-C6	525	72
PIX350B-180-C8	693	96

MAGNET TRACK	TL	B	WEIGHT (kg)
PIXM350-180-TL168-NC/C	168	8	2.6
PIXM350-180-TL252-NC/C	252	12	3.8
PIXM350-180-TL420-NC/C	420	20	6.4

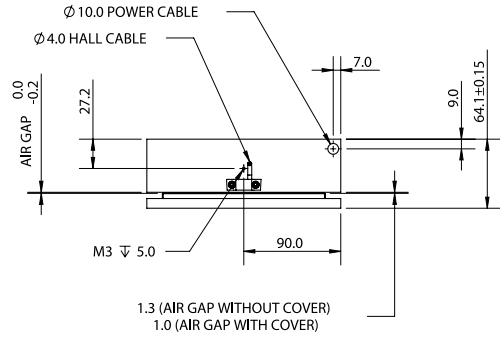
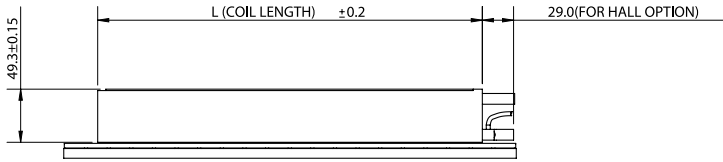

NOTE:
 MOTOR AND HALL CABLES TO OBSERVE:
 FIXED INSTALLATION : STATIC BEND RADIUS $R > 3 \times$ CABLE DIAMETER
 FLEXING INSTALLATION : DYNAMIC BEND RADIUS $R > 10 \times$ CABLE DIAMETER

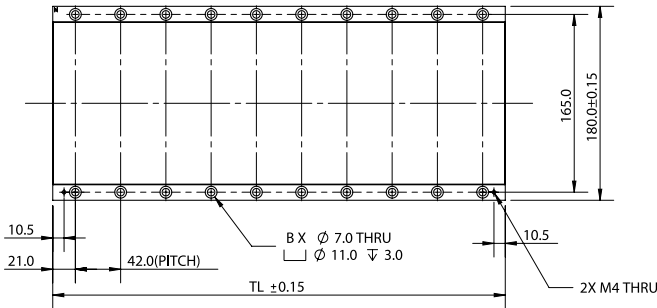

GRAPH: Force VS Speed

PIX350B-180-C4

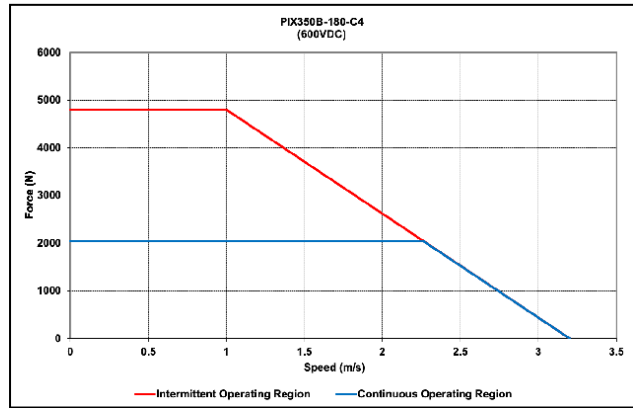
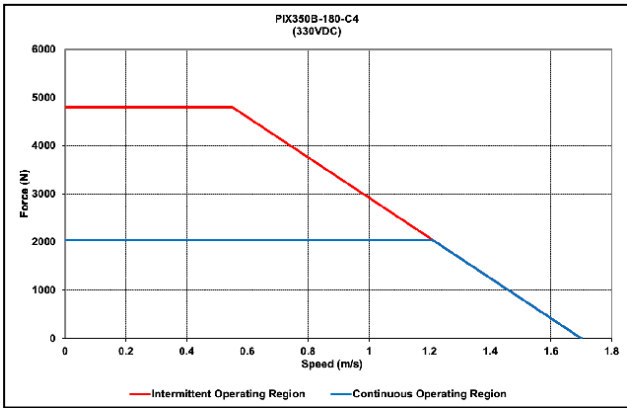

PIX350B-180-C6

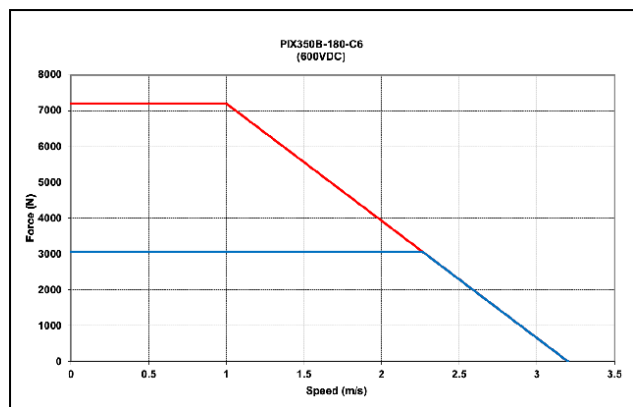
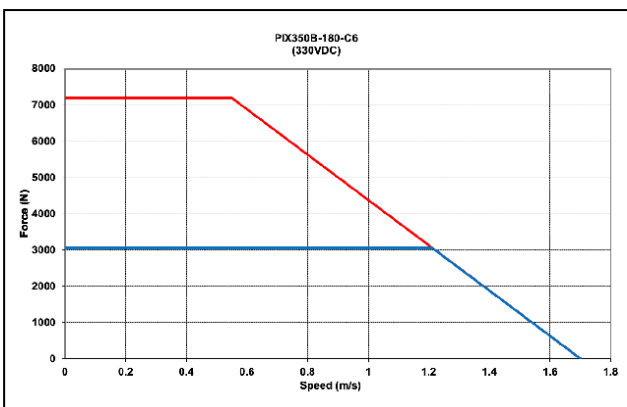

PIX350B-180-C8

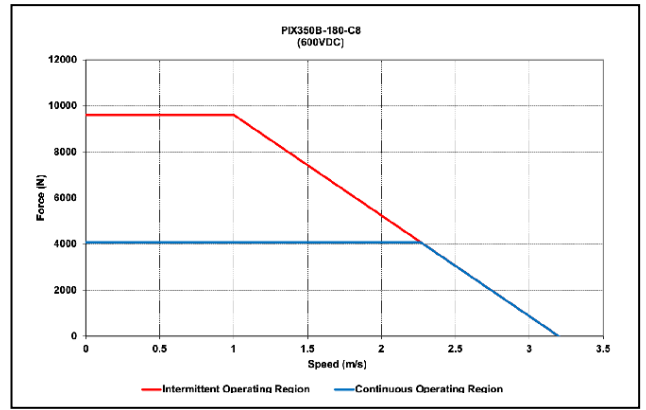
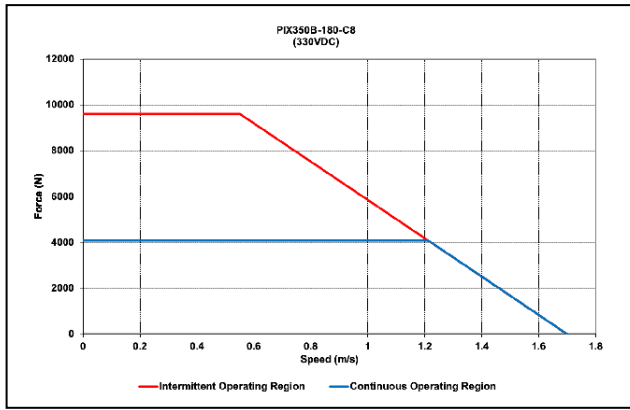

DXB/BT

PIX

PSM/PSME

CVC

CVCA

RVCA

PDDR

PCA

PWA

PLA

PDAB

PIAB

OCTO

PRG

LINER ENCODER

SERVO AMPLIFIER

PIX350B SERIES

IRONCORE LINEAR MOTOR

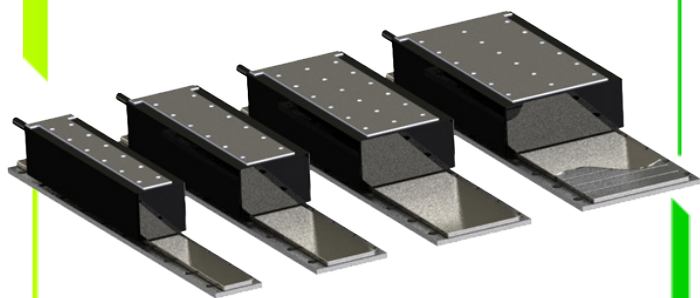

PIX350B - 250

- Peak force up to 12800N, Continuous force up to 5471N
- Hall Sensor (Optional)

SPECIFICATION	MODEL			
	PIX350B-250-C4	PIX350B-250-C6	PIX350B-250-C8	
Performance	Unit			
Peak Force	N	6400	9600	12800
Continuous Force @ 100°C*	N	2736	4104	5471
Continuous Stall Force @ 100°C*	N	1675	2513	3350
Peak Power @ 100°C	W	6283	9424	12565
Continuous Power @ 100°C*	W	618	928	1237
Electrical				
Peak Current	A ^{pk}	40.6	60.9	81.2
Continuous Current @ 100°C*	A ^{pk}	12.7	19.1	25.5
Continuous Stall Current @ 100°C*	Arms	7.8	11.7	15.6
Force Constant	N/A ^{pk}	214.8	214.8	214.8
Back EMF Constant	V ^{pk} /m/s	248.0	248.0	248.0
Coil Resistance L-L @ 25°C	ohm	3.9	2.6	2.0
Coil Resistance L-L @ 100°C*	ohm	5.1	3.4	2.5
Inductance L-L @ 1kHz	mH	66.9	44.6	33.5
Motor Constant @ 25°C*	N//W	125.6	153.8	177.6
Motor Constant @ 100°C*	N//W	110.0	134.7	155.6
Max. Terminal Voltage	Vdc	600		
Thermal				
Thermal Resistance @ 100°C*	°C/W	0.12	0.08	0.06
Max. Winding Temperature	°C	120		
Mechanical				
Coil Weight	kg	24.4	35.9	47.4
Attractive Force	kN	13.2	39.6	26.4
Electrical Cycle Length	mm	42		

Notes:

1. $A_{pk} = 1.414 \cdot I_{rms}$; $V_{pk} = 1.414 \cdot V_{rms}$
2. * Ambient temperature 25°C, natural convection, with heat sink of size L x 2W x 12mm. (L = length of coil, W = width of coil)
3. Specifications tolerance : +/-10%
4. Peak force and current : 4% duty ratio and 1 second duration
5. Motor Insulation Class : Class B (130°C)
6. IP Rating : IP00
7. IEC Protection Class : Class 1
8. Compliance Standards : CE, RoHS
9. Ambient Operating Temperature : 0 - 40°C
10. Ambient Operating Humidity : 10 - 90% RH
11. Specifications are subject to change without prior notice.

PIX350B-250

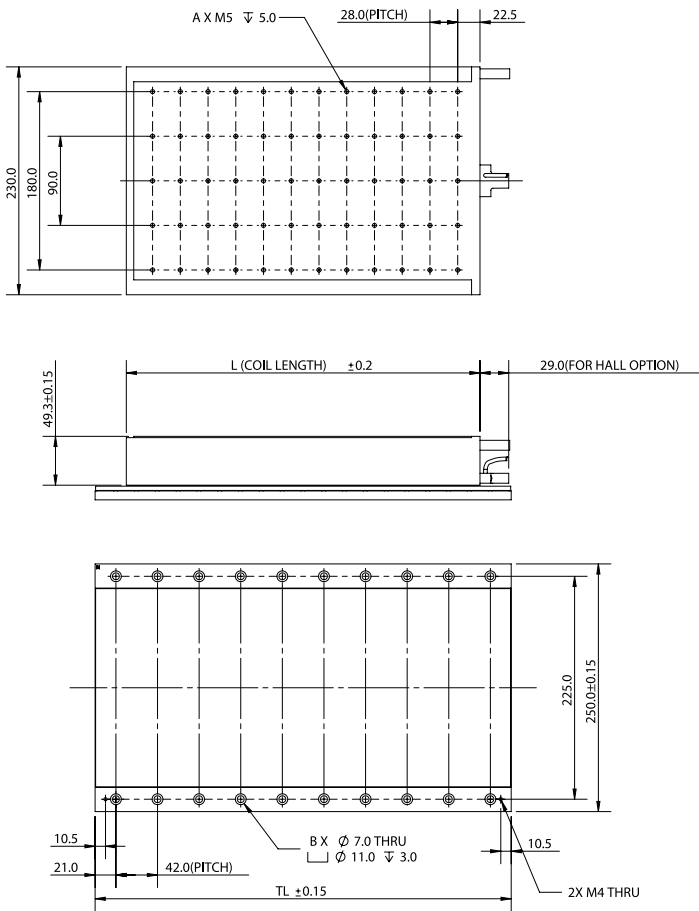

COIL	L	A
PIX350B-250-C4	357	60
PIX350B-250-C6	525	90
PIX350B-250-C8	693	120

MAGNET TRACK	TL	B	WEIGHT (kg)
PIXM350-250-TL168-NC/C	168	8	3.8
PIXM350-250-TL252-NC/C	252	12	5.7
PIXM350-250-TL420-NC/C	420	20	9.4

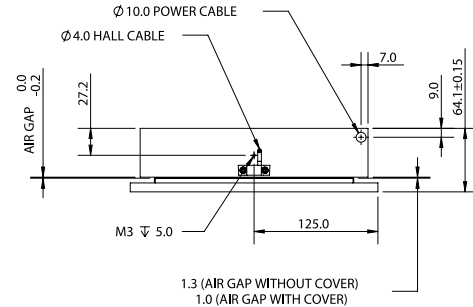

NOTE:
 MOTOR AND HALL CABLES TO OBSERVE:
 FIXED INSTALLATION - STATIC BEND RADIUS $R > 3 \times$ CABLE DIAMETER
 FLEXING INSTALLATION - DYNAMIC BEND RADIUS $R > 10 \times$ CABLE DIAMETER

GRAPH: Force VS Speed

PIX350B-250-C4

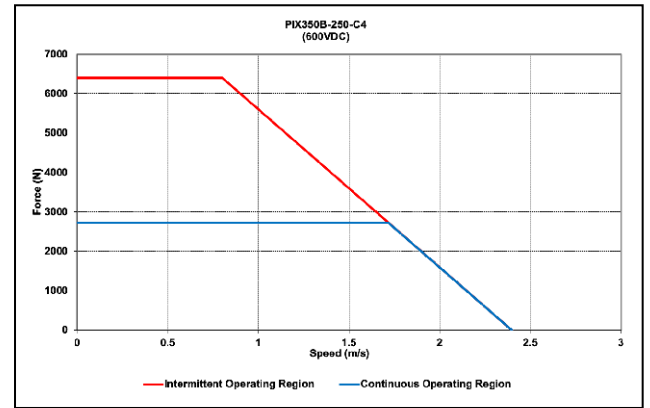
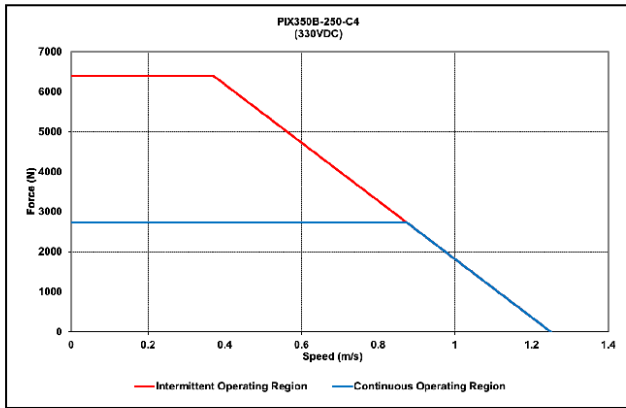

PIX350B-250-C6

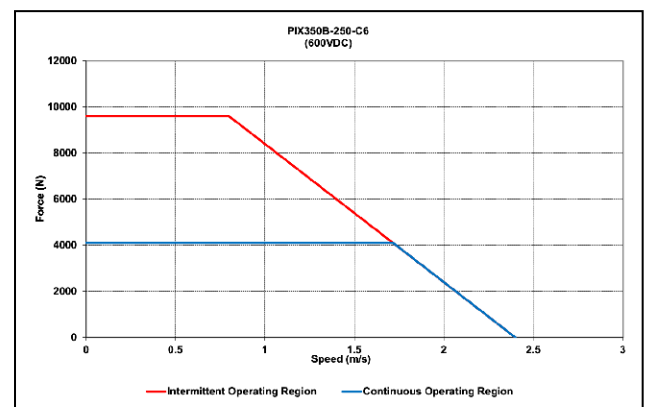
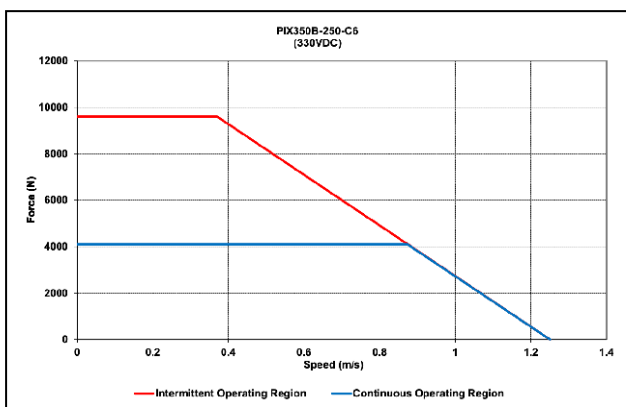

PIX350B-250-C8

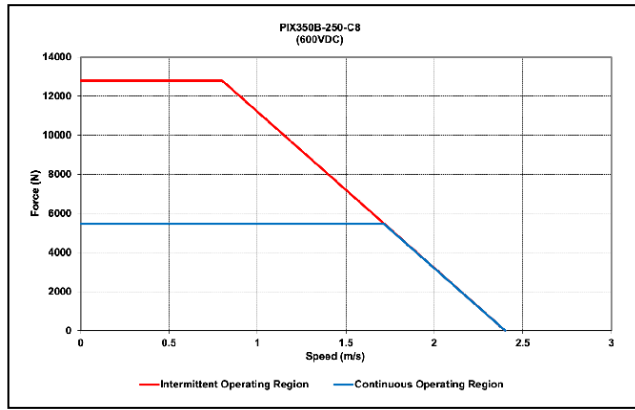
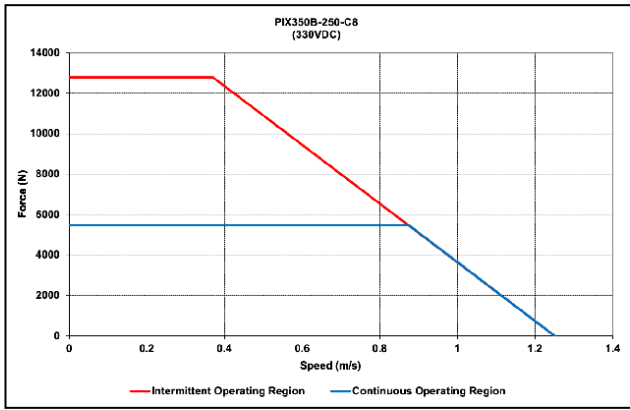

- DXB/BT
- PIX**
- PSM/PSME
- CV/C
- CVCA
- RVCA
- PDDR
- PCA
- PWA
- PLA
- PDAB
- PIAB
- OCTO
- PRG
- LINEAR ENCODER
- SERVO AMPLIFIER

CABLE OPTION

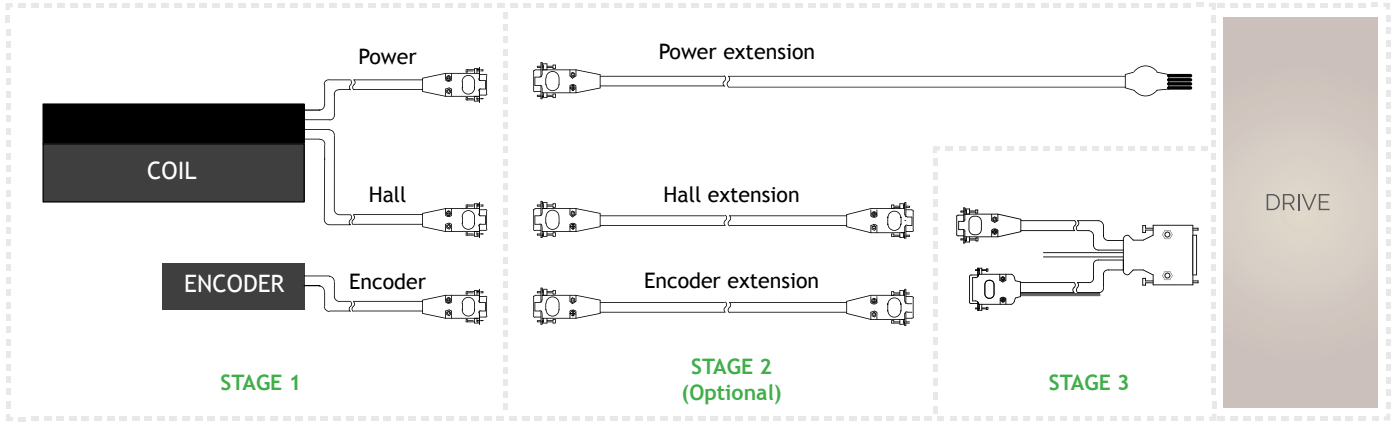

THERMAL PROTECTION

The temperature at which the thermal device is activated is shown below

MODEL	THERMAL DEVICE TYPE	
PIX350B	PT100	TC: Refer to note 1
PIX350B	THERMOSTAT	TM: (NC) Opens at 100 °C

Note 1:

- Programmable and can be used where there are temperature controllers or drivers/motion controllers with analog inputs.
- Recommended to set cut-off temperature to 100 °C (max) to prevent coil damage.
- User has to ensure that the thermal protection devices are wired to appropriate electronics to ensure that the motor power cutoff is active when temperature reaches its allowable limit.

STAGE 1 | POWER AND HALL CABLE OPTION

PIX350B-180-C4-TM-0.5-NC-NF-HC-00

POWER CABLE OPTIONS		HALL SENSOR OPTIONS																																		
NF		H	<table border="1"> <tr><td>Hall A</td><td>White</td></tr> <tr><td>Hall B</td><td>Green</td></tr> <tr><td>Hall C</td><td>Blue</td></tr> <tr><td>5V</td><td>Red</td></tr> <tr><td>0V</td><td>Black</td></tr> </table>	Hall A	White	Hall B	Green	Hall C	Blue	5V	Red	0V	Black																							
Hall A	White																																			
Hall B	Green																																			
Hall C	Blue																																			
5V	Red																																			
0V	Black																																			
FC	<table border="1"> <tr><td>M1</td><td>Red</td></tr> <tr><td>M2</td><td>Blue</td></tr> <tr><td>M3</td><td>Brown</td></tr> <tr><td>PE</td><td>Yellow</td></tr> <tr><td>TS1</td><td>Red</td></tr> <tr><td>TS2</td><td>Black</td></tr> </table>	M1	Red	M2	Blue	M3	Brown	PE	Yellow	TS1	Red	TS2	Black	HC	<table border="1"> <tr><td>P1</td><td>Hall A</td><td>White</td></tr> <tr><td>P2</td><td>Hall B</td><td>Green</td></tr> <tr><td>P3</td><td>Hall C</td><td>Blue</td></tr> <tr><td>P4</td><td>5V</td><td>Red</td></tr> <tr><td>P5</td><td>0V</td><td>Black</td></tr> </table> <p>9 Pin D-Sub Male</p>	P1	Hall A	White	P2	Hall B	Green	P3	Hall C	Blue	P4	5V	Red	P5	0V	Black						
M1	Red																																			
M2	Blue																																			
M3	Brown																																			
PE	Yellow																																			
TS1	Red																																			
TS2	Black																																			
P1	Hall A	White																																		
P2	Hall B	Green																																		
P3	Hall C	Blue																																		
P4	5V	Red																																		
P5	0V	Black																																		
9NF	<table border="1"> <tr><td>A1</td><td>M1</td><td>Red</td></tr> <tr><td>A2</td><td>M2</td><td>Blue</td></tr> <tr><td>A3</td><td>M3</td><td>Brown</td></tr> <tr><td>P1</td><td>TS1</td><td>Red</td></tr> <tr><td>P3</td><td>TS2</td><td>Black</td></tr> <tr><td>A4</td><td>PE</td><td>Yellow</td></tr> </table> <p>9 Pin D-Sub Female</p>	A1	M1	Red	A2	M2	Blue	A3	M3	Brown	P1	TS1	Red	P3	TS2	Black	A4	PE	Yellow	CHC	<table border="1"> <tr><td>P1</td><td>Hall A</td><td>White</td></tr> <tr><td>P2</td><td>Hall B</td><td>Green</td></tr> <tr><td>P3</td><td>Hall C</td><td>Blue</td></tr> <tr><td>P4</td><td>5V</td><td>Red</td></tr> <tr><td>P5</td><td>0V</td><td>Black</td></tr> </table> <p>Push Pull 5 Pin Male</p> <p>9 Pin D-sub Female</p>	P1	Hall A	White	P2	Hall B	Green	P3	Hall C	Blue	P4	5V	Red	P5	0V	Black
A1	M1	Red																																		
A2	M2	Blue																																		
A3	M3	Brown																																		
P1	TS1	Red																																		
P3	TS2	Black																																		
A4	PE	Yellow																																		
P1	Hall A	White																																		
P2	Hall B	Green																																		
P3	Hall C	Blue																																		
P4	5V	Red																																		
P5	0V	Black																																		
		HCL	<table border="1"> <tr><td>P1</td><td>Hall A+</td></tr> <tr><td>P2</td><td>Hall A-</td></tr> <tr><td>P3</td><td>Hall B+</td></tr> <tr><td>P4</td><td>Hall B-</td></tr> <tr><td>P5</td><td>Hall C+</td></tr> <tr><td>P6</td><td>Hall C-</td></tr> <tr><td>P7</td><td>5V</td></tr> <tr><td>P8</td><td>0V</td></tr> </table> <p>9 Pin D-Sub Male</p>	P1	Hall A+	P2	Hall A-	P3	Hall B+	P4	Hall B-	P5	Hall C+	P6	Hall C-	P7	5V	P8	0V																	
P1	Hall A+																																			
P2	Hall A-																																			
P3	Hall B+																																			
P4	Hall B-																																			
P5	Hall C+																																			
P6	Hall C-																																			
P7	5V																																			
P8	0V																																			

Notes: All connectors shown are front view

STAGE 2 | PIX350B SERIES EXTENSION CABLE

Connection example: PIX350B-□-□-□-□-□-9NF-HC-00

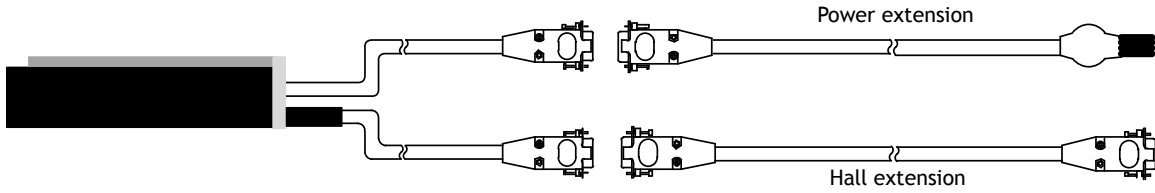

Extension Cable		Part Number																				
Power Extension Cable		CBL_EXT_PWR5_X.X																				
Hall Sensor Extension Cable		CBL_EXT_HALL0_X.X																				
		CBL_EXT_HALL0_CC_X.X																				
		CBL_EXT_HALL0_DIF_X.X																				
Encoder Extension Cable	<table border="1"> <thead> <tr> <th>CABLE</th> <th>CABLE LENGTH (X.X)</th> </tr> </thead> <tbody> <tr> <td rowspan="2">00 RGH41, VIONIC, QUANTIC Digital</td> <td>0.5</td> <td>0.5 meter</td> </tr> <tr> <td>1.0</td> <td>1.0meter</td> </tr> <tr> <td>00A RGH41 Analog</td> <td>2.0</td> <td>2.0 meter</td> </tr> <tr> <td>01 RH200 Digital</td> <td rowspan="2">3.0</td> <td rowspan="2">3.0 meter (standard)</td> </tr> <tr> <td>01B PH200 Analog</td> </tr> <tr> <td>05 ATOM Ri Interface Digital</td> <td colspan="2"></td> </tr> <tr> <td>05A ATOM Ri Interface Analog</td> <td colspan="2"></td> </tr> </tbody> </table>	CABLE	CABLE LENGTH (X.X)	00 RGH41, VIONIC, QUANTIC Digital	0.5	0.5 meter	1.0	1.0meter	00A RGH41 Analog	2.0	2.0 meter	01 RH200 Digital	3.0	3.0 meter (standard)	01B PH200 Analog	05 ATOM Ri Interface Digital			05A ATOM Ri Interface Analog			CBL_EXT_REN00_X.X
		CABLE	CABLE LENGTH (X.X)																			
		00 RGH41, VIONIC, QUANTIC Digital	0.5	0.5 meter																		
			1.0	1.0meter																		
		00A RGH41 Analog	2.0	2.0 meter																		
		01 RH200 Digital	3.0	3.0 meter (standard)																		
		01B PH200 Analog																				
05 ATOM Ri Interface Digital																						
05A ATOM Ri Interface Analog																						
CBL_EXT_REN00A_X.X																						
CBL_EXT_REN01_X.X																						
CBL_EXT_REN01B_X.X																						
CBL_EXT_REN05_X.X																						
CBL_EXT_REN05A_X.X																						

Notes: 1. X.X is the length of the cable in meters. 2. For customized cable length, contact PBA

HALL SENSOR MODULE PART NUMBERING SYSTEM

Hall Sensor Module Assembly

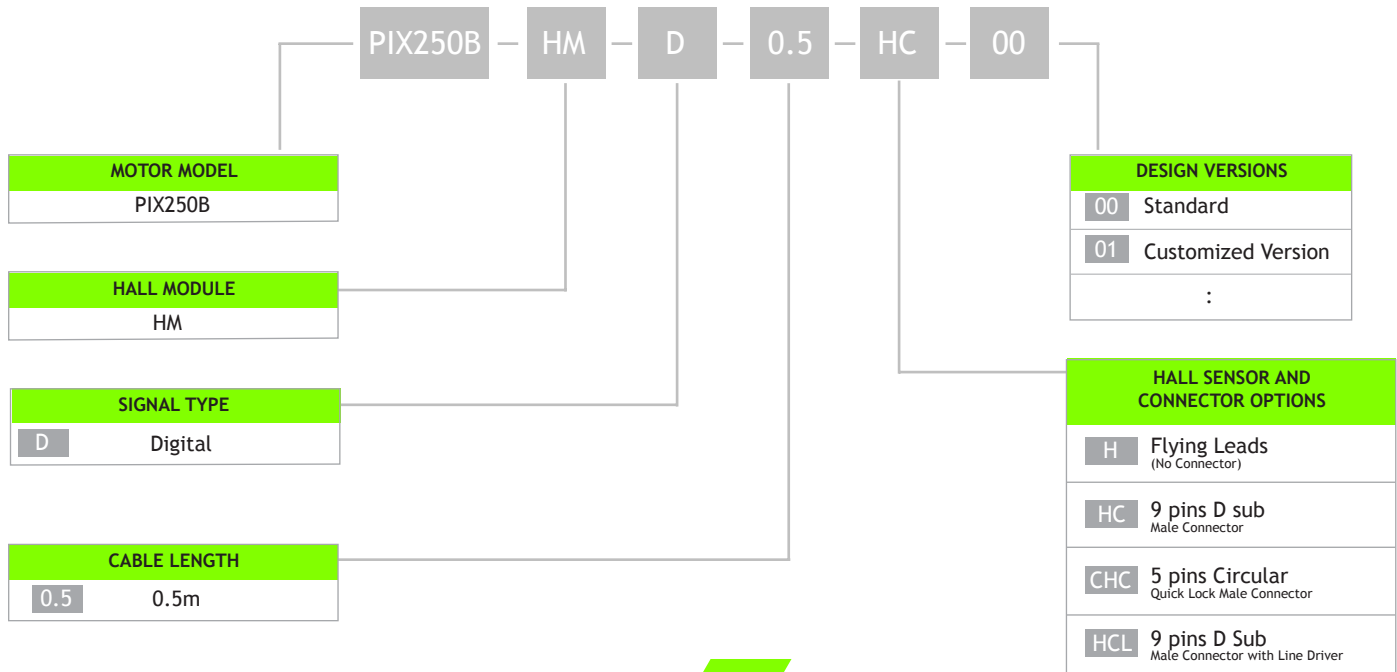

DXB/BT
 PIX
 PSM/PSME
 CVC
 CVCA
 RVCA
 PDDR
 PCA
 PWA
 PLA
 PDAB
 PIAB
 OCTO
 PRG
 LINEAR ENCODER
 SERVO AMPLIFIER

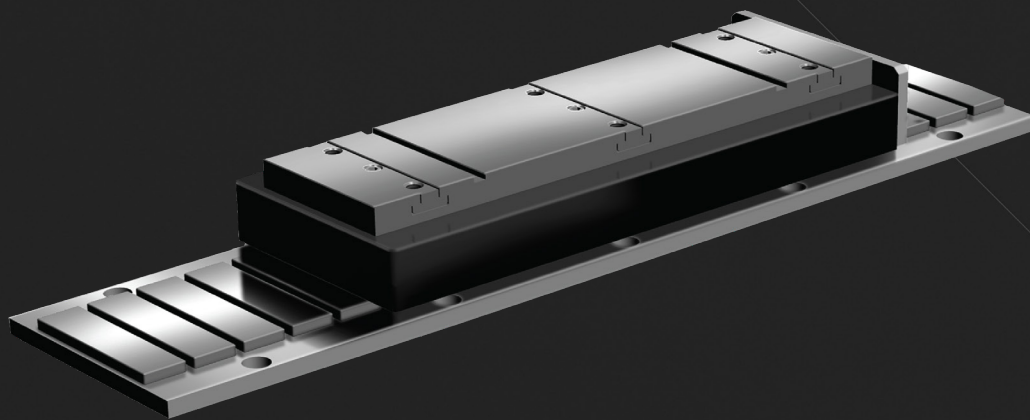

PIX200 SERIES
IRONCORE LINEAR MOTOR

PIX200 SERIES

IRONCORE LINEAR MOTOR

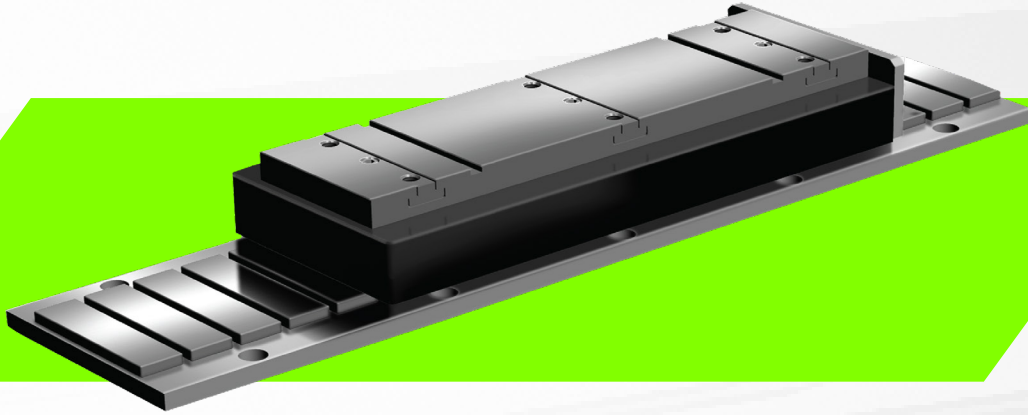

Heavy Duty Motors For Hi-Speed Point-To-Point Applications

PIX Ironcore motors offer an affordable high force solution to demanding linear applications with a minimal cogging effect that is associated with traditional iron core linear motors.

Our Ironcore design is designed for optimal dissipation of heat and thus capable of extremely high forces (>9000N). These motors coils are manufactured with high flex cables and optional external hall effect attachments widely used in multiple general automation applications.

Modular Flat Magnet tracks are available in different length increments to complete this product selection and allow for easy assembly of un-restricted effective stroke by butting tracks of different lengths together.

- High force / thrust
- Maintenance Free
- High stiffness
- Compact size
- Minimal cogging

APPLICATION

- Material Transfer / Pick and place
- Laser cutting
- Extruders
- Machine Tools
- Large format printing
- Textile printing
- Digital printing

**Technical specifications subject to change without prior notice*

PIX200-027	56
PIX200-040	58
Power & Hall Cable Option	60
Cable Option	61

Force Chart for PIX200 Linear Motor

Force Chart For PIX200 Motors

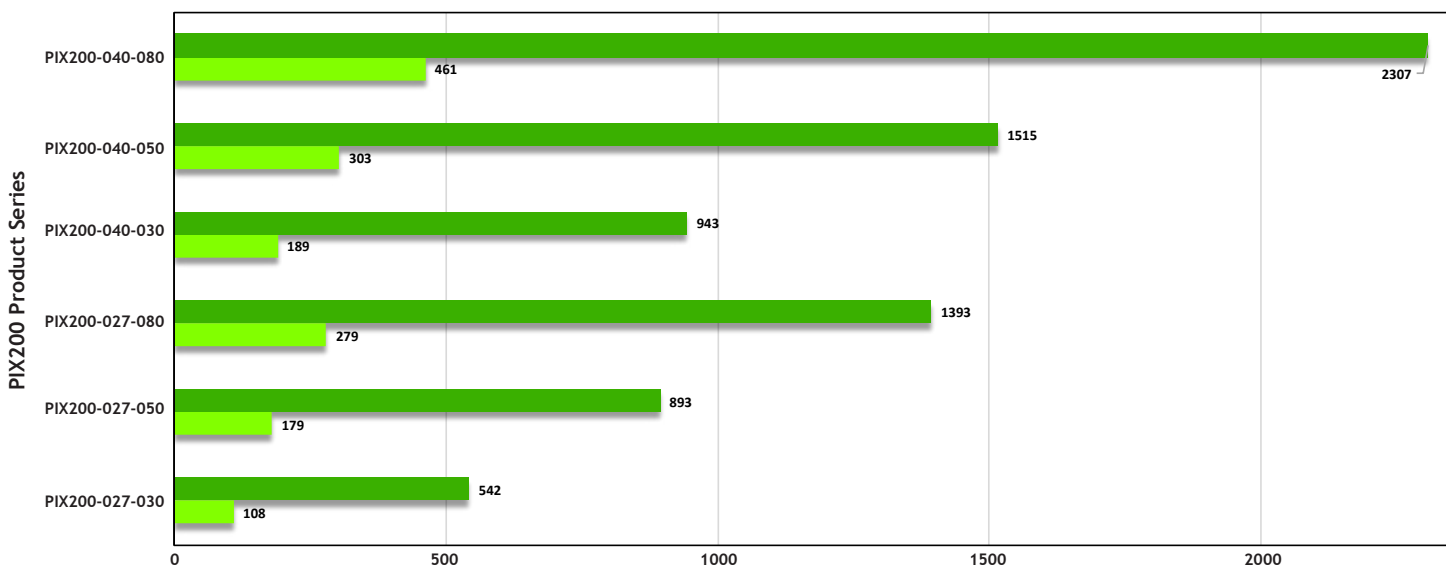

Motor Model	Continuous Force (N)	Peak Force (N)	Coil Weight (Kg)	Motor Dimensions without Hall Sensor LxWxH (mm)	Motor Dimensions with Hall Sensor LxWxH (mm)
PIX200-027-030	108	542	1.3	193 x 55 x 38	223.7 x 55 x 38
PIX200-027-050	179	893	2	193 x 75 x 38	223.7 x 75 x 38
PIX200-027-080	279	1393	3.1	193 x 105 x 38	223.7 x 105 x 38
PIX200-040-030	189	943	2.1	193 x 55 x 51	223.7 x 55 x 51
PIX200-040-050	303	151	3.1	193 x 75 x 51	223.7 x 75 x 51
PIX200-040-080	461	2307	4.6	193 x 105 x 51	223.7 x 105 x 51

PART NUMBERING SYSTEM

COIL ASSEMBLY

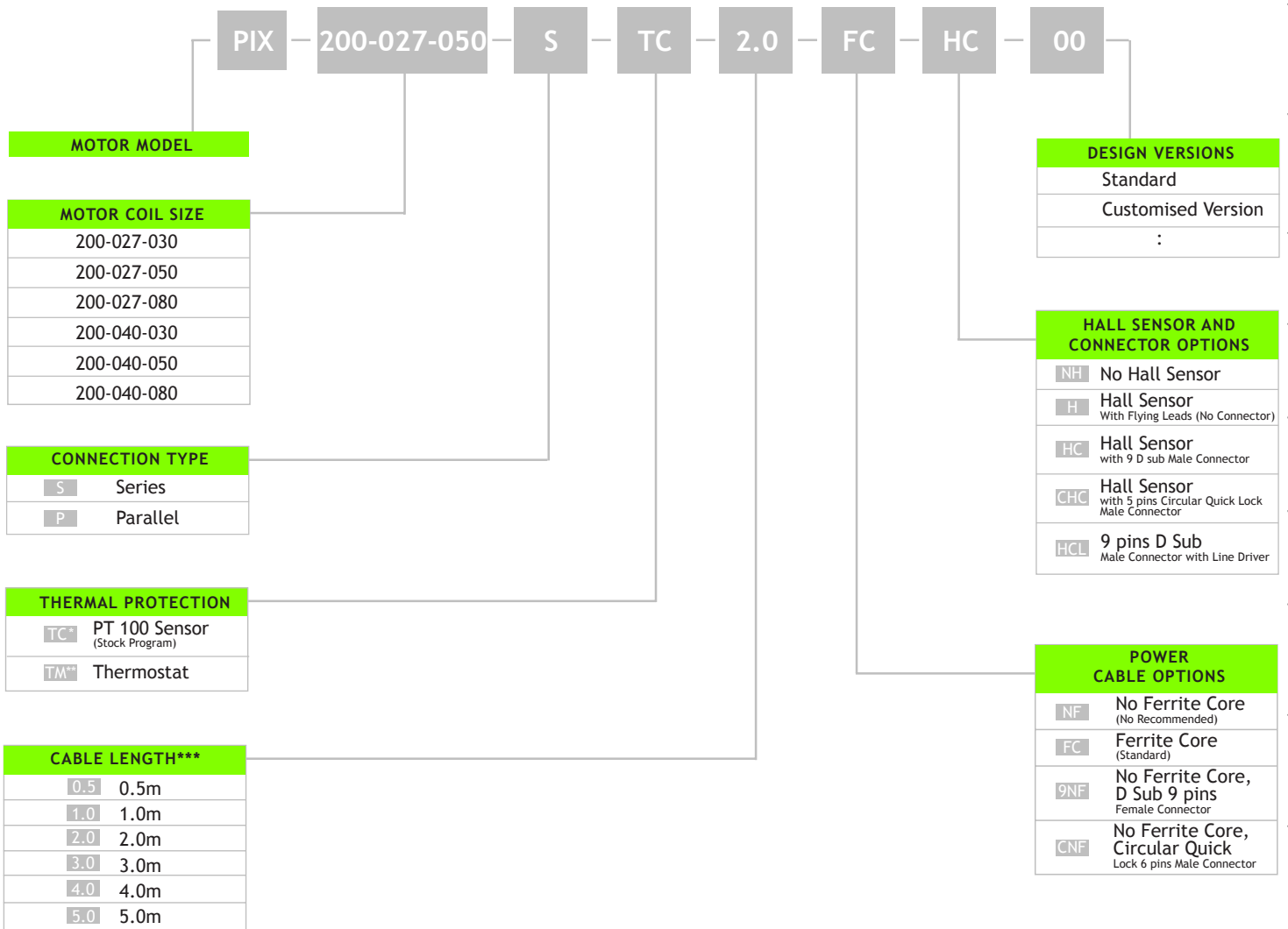

* TC - Sensor output to temperature controller
 ** TM - On/Off switch, trigger at 100°C
 *** Minimum Bending Radius - 10 times of cable diameter

MAGNET TRACK

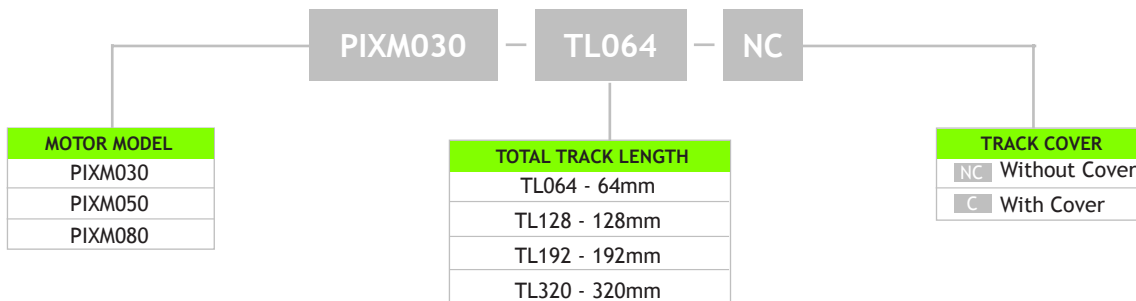

PIX200 SERIES

IRONCORE LINEAR MOTOR

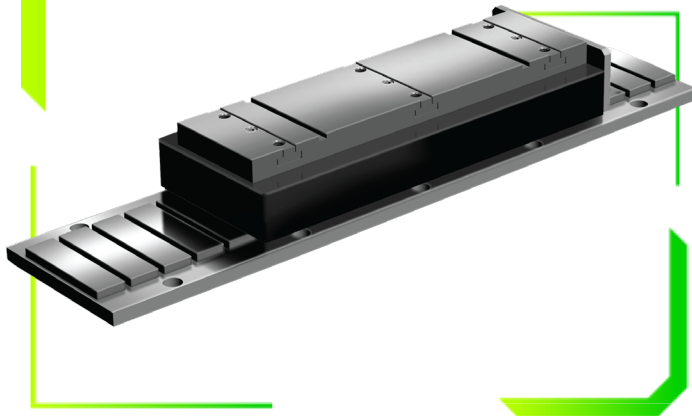

PIX200-027

- Peak force up to 1393N, Continuous force up to 279N
- Hall Sensor (Optional)

SPECIFICATION		MODEL					
		PIX200-027-030		PIX200-027-050		PIX200-027-080	
		S	P	S	P	S	P
Performance		Unit					
Peak Force	N	542		893		1393	
Continuous Force @ 100°C*	N	108		179		279	
Continuous Stall Force @ 100°C*	N	77		126		197	
Peak Power @ 100°C	W	1823		2323		2932	
Continuous Power @ 100°C*	W	73		93		117	
Electrical							
Peak Current	A ^{pk}	30.4	60.8	29.3	58.7	27.9	55.7
Continuous Current @ 100°C*	A ^{pk}	6.1	12.2	5.9	11.7	5.6	11.1
Continuous Stall Current @ 100°C*	Arms	4.30	8.60	4.15	8.30	3.94	7.88
Force Constant	N/A ^{pk}	17.8	8.9	30.4	15.2	50.0	25.0
Back EMF Constant	V ^{pk} /m/s	20.5	10.3	35	17.5	57.5	28.8
Coil Resistance L-L @ 25°C	ohm	1.9	0.5	2.6	0.7	3.6	0.9
Coil Resistance L-L @ 100°C*	ohm	2.6	0.7	3.6	0.9	5.0	1.3
Inductance L-L @ 1kHz	mH	4.9	1.2	7.1	1.8	10.5	2.6
Motor Constant @ 25°C*	N//W	14.9		21.8		30.3	
Motor Constant @ 100°C*	N//W	12.7		18.5		25.7	
Max. Terminal Voltage	Vdc	600					
Thermal							
Thermal Resistance @ 100°C*	°C/W	1.3		1.02		0.81	
Max. Winding Temperature	°C	120					
Mechanical							
Coil Weight	kg	1.3		2.0		3.1	
Attractive Force	kN	1.56		2.6		4.16	
Electrical Cycle Length	mm	32					

- Notes:
1. $A_{pk} = 1.414 * I_{rms}$; $V_{pk} = 1.414 * V_{rms}$.
 2. * Ambient temperature 25°C, heat dissipation by natural convection, without heat sink attached.
 3. Specifications tolerance $\pm 10\%$.
 4. Peak force and current :4% duty ratio and 1 second duration.
 5. Specifications are subject to change without prior notice.

PIX200-027

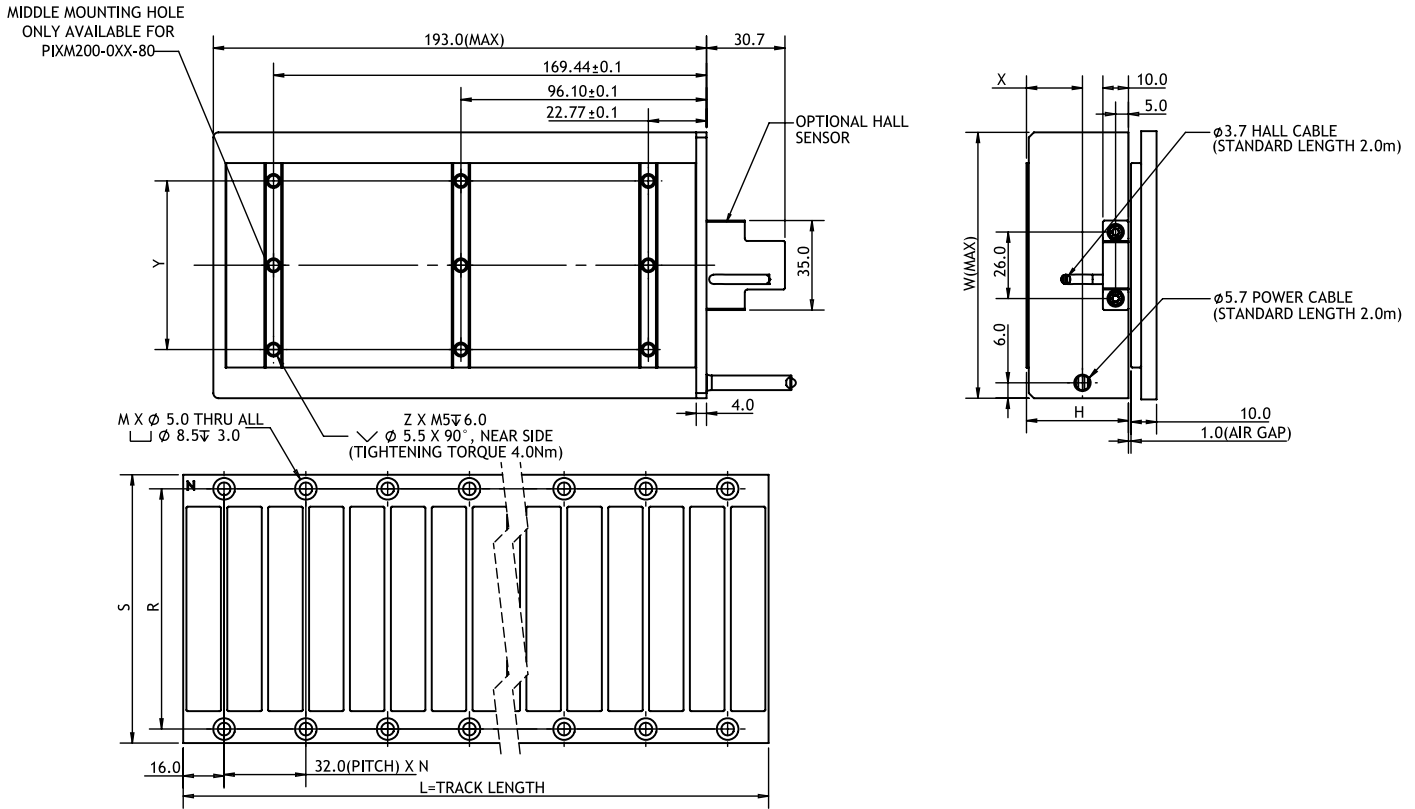

COIL	H (mm)	W (mm)	X (mm)	Y (mm)	NUMBER OF MOUNTING HOLE Z	COMPATIBLE TRACK
PIX200-027-030	27	54	14	16	6	PIXM030-TLXXX
PIX200-027-050	27	74	14	36	6	PIXM050-TLXXX
PIX200-027-080	27	104	14	66	9	PIXM080-TLXXX

MAGNET TRACK		L (mm)	S (mm)	R (mm)	N	M	WEIGHT (g)	COMPATIBLE COIL
PIXM030	TL064	64	55	44	1	4	207	PIX200-027-030 PIX200-040-030
	TL128	128			3	8	415	
	TL192	192			5	12	622	
	TL320	320			9	20	1038	
PIXM050	TL064	64	75	64	1	4	300	PIX200-027-050 PIX200-040-050
	TL128	128			3	8	600	
	TL192	192			5	12	901	
	TL320	320			9	20	1501	
PIXM080	TL064	64	105	94	1	4	439	PIX200-027-080 PIX200-040-080
	TL128	128			3	8	878	
	TL192	192			5	12	1318	
	TL320	320			9	20	2197	

PIX200 SERIES

IRONCORE LINEAR MOTOR

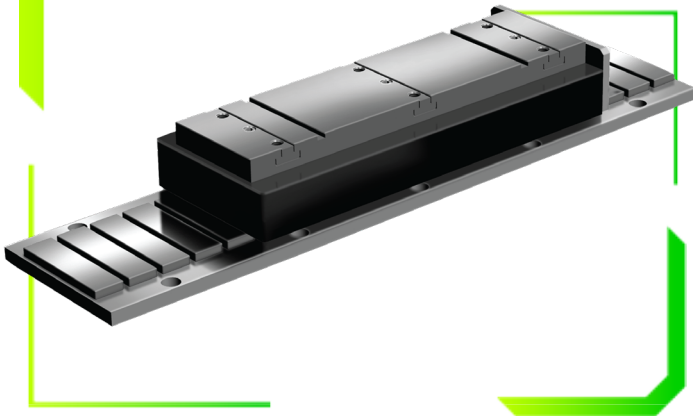

PIX200-040

- Peak force up to 2307N, Continuous force up to 461N
- Hall Sensor (Optional)

SPECIFICATION		MODEL					
		PIX200-040-030		PIX200-040-050		PIX200-040-080	
		S	P	S	P	S	P
Performance		Unit					
Peak Force	N	943		1515		2307	
Continuous Force @ 100°C*	N	189		303		461	
Continuous Stall Force @ 100°C*	N	133		214		326	
Peak Power @ 100°C	W	2144		2662		3457	
Continuous Power @ 100°C*	W	86		106		138	
Electrical							
Peak Current	A ^{pk}	21.9	43.8	20.5	41.0	19.8	39.6
Continuous Current @ 100°C*	A ^{pk}	4.4	8.8	4.1	8.2	4.0	7.9
Continuous Stall Current @ 100°C*	Arms	3.10	6.20	2.90	5.80	2.80	5.60
Force Constant	N/A ^{pk}	43.0	21.5	73.9	37.0	116.5	58.3
Back EMF Constant	V ^{pk} /m/s	49.5	24.8	85.0	42.5	134.0	67.0
Coil Resistance L-L @ 25°C	ohm	4.3	1.1	6.1	1.5	8.5	2.1
Coil Resistance L-L @ 100°C*	ohm	6.0	1.5	8.4	2.1	11.8	2.9
Inductance L-L @ 1kHz	mH	39.4	9.9	60.6	15.1	88.7	22.2
Motor Constant @ 25°C*	N/√W	24.0		34.6		46.1	
Motor Constant @ 100°C*	N/√W	20.4		29.4		39.2	
Max. Terminal Voltage	Vdc	600					
Thermal							
Thermal Resistance @ 100°C*	°C/W	1.11		0.89		0.69	
Max. Winding Temperature	°C	120					
Mechanical							
Coil Weight	kg	2.1		3.1		4.6	
Attractive Force	kN	1.56		2.6		4.16	
Electrical Cycle Length	mm	32					

Notes:
 1. A^{pk} = 1.414 * Arms; V^{pk} = 1.414 * Vrms.
 2. * Ambient temperature 25°C, heat dissipation by natural convection, without heat sink attached.
 3. Specifications tolerance :±10%.
 4. Peak force and current :4% duty ratio and 1 second duration.
 5. Specifications are subject to change without prior notice.

PIX200-040

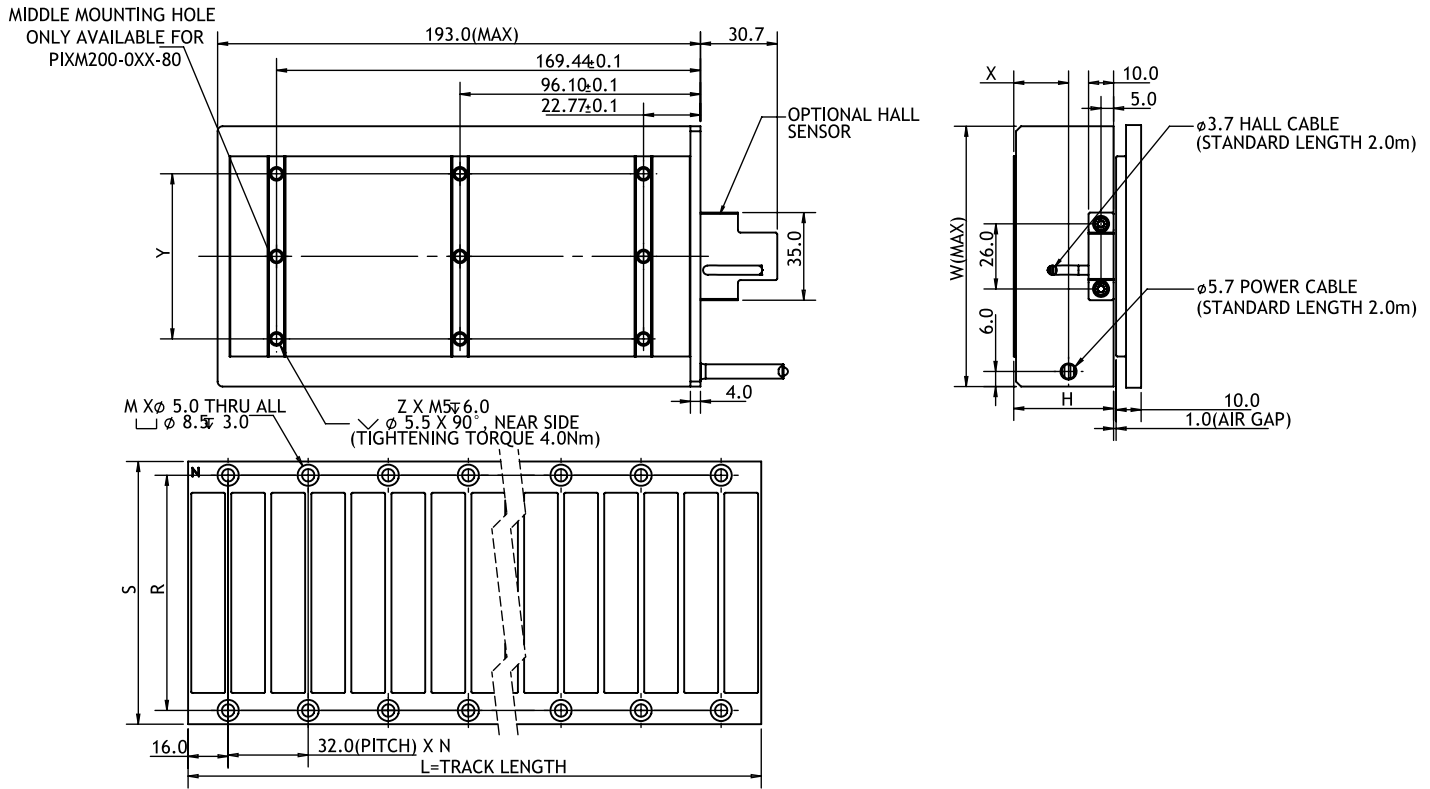

COIL	H (mm)	W (mm)	X (mm)	Y (mm)	NUMBER OF MOUNTING HOLE Z	COMPATIBLE TRACK
PIX200-040-030	40	54	22	16	6	PIXM030-TLXXX
PIX200-040-050	40	74	22	36	6	PIXM050-TLXXX
PIX200-040-080	40	104	22	66	9	PIXM080-TLXXX

MAGNET TRACK		L (mm)	S (mm)	R (mm)	N	M	WEIGHT (g)	COMPATIBLE COIL
PIXM030	TL064	64	55	44	1	4	207	PIX200-027-030 PIX200-040-030
	TL128	128			3	8	415	
	TL192	192			5	12	622	
	TL320	320			9	20	1038	
PIXM050	TL064	64	75	64	1	4	300	PIX200-027-050 PIX200-040-050
	TL128	128			3	8	600	
	TL192	192			5	12	901	
	TL320	320			9	20	1501	
PIXM080	TL064	64	105	94	1	4	439	PIX200-027-080 PIX200-040-080
	TL128	128			3	8	878	
	TL192	192			5	12	1318	
	TL320	320			9	20	2197	

THERMAL PROTECTION

The temperature at which the thermal device is activated is shown below

MODEL	THERMAL DEVICE TYPE	
PIX200	PT100	TC: Refer to note 1
PIX200	THERMOSTAT	TM: (NC) Opens at 100°C

Note 1:

- Programmable and can be used where there are temperature controllers or drivers/motion controllers with analog inputs.
- Recommended to set cut-off temperature to 100°C (max) to prevent coil damage.
- User has to ensure that the thermal protection devices are wired to appropriate electronics to ensure that the motor power cutoff is active when temperature reaches its allowable limit.

CABLE OPTION

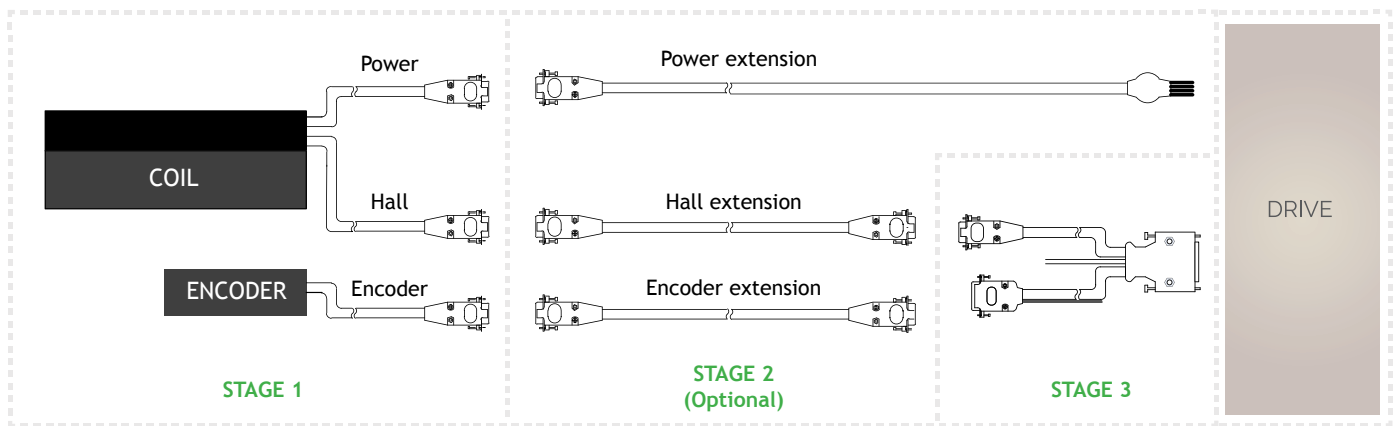

STAGE 1 | POWER AND HALL CABLE OPTION

PIX200-027-050-S-TC-2.0-FC-HC-00

POWER CABLE OPTIONS		HALL SENSOR OPTIONS																																													
NF		<table border="1"> <tr><td>M1</td><td>Grey</td></tr> <tr><td>M2</td><td>Brown</td></tr> <tr><td>M3</td><td>Black</td></tr> <tr><td>PE</td><td>Yellow</td></tr> <tr><td>Temp sensor 1</td><td>Black</td></tr> <tr><td>Temp sensor 2</td><td>Orange</td></tr> </table>	M1	Grey	M2	Brown	M3	Black	PE	Yellow	Temp sensor 1	Black	Temp sensor 2	Orange	H		<table border="1"> <tr><td>Hall A</td><td>White</td></tr> <tr><td>Hall B</td><td>Green</td></tr> <tr><td>Hall C</td><td>Blue</td></tr> <tr><td>5V</td><td>Red</td></tr> <tr><td>0V</td><td>Black</td></tr> </table>	Hall A	White	Hall B	Green	Hall C	Blue	5V	Red	0V	Black																				
	M1	Grey																																													
M2	Brown																																														
M3	Black																																														
PE	Yellow																																														
Temp sensor 1	Black																																														
Temp sensor 2	Orange																																														
Hall A	White																																														
Hall B	Green																																														
Hall C	Blue																																														
5V	Red																																														
0V	Black																																														
FC		<table border="1"> <tr><td>P1</td><td>M1</td><td>Grey</td></tr> <tr><td>P2</td><td>M1</td><td>Black (Jumper)</td></tr> <tr><td>P3</td><td>M3</td><td>Black</td></tr> <tr><td>P4</td><td>M3</td><td>Black (Jumper)</td></tr> <tr><td>P5</td><td>M2</td><td>Brown</td></tr> <tr><td>P6</td><td>M2</td><td>Black (Jumper)</td></tr> <tr><td>P7</td><td>Temp sensor 1</td><td>Black</td></tr> <tr><td>P8</td><td>Temp sensor 2</td><td>Orange</td></tr> <tr><td>P9</td><td>PE</td><td>Yellow</td></tr> </table>	P1	M1	Grey	P2	M1	Black (Jumper)	P3	M3	Black	P4	M3	Black (Jumper)	P5	M2	Brown	P6	M2	Black (Jumper)	P7	Temp sensor 1	Black	P8	Temp sensor 2	Orange	P9	PE	Yellow	HC		<table border="1"> <tr><td>P1</td><td>Hall A</td><td>White</td></tr> <tr><td>P2</td><td>Hall B</td><td>Green</td></tr> <tr><td>P3</td><td>Hall C</td><td>Blue</td></tr> <tr><td>P4</td><td>5V</td><td>Red</td></tr> <tr><td>P5</td><td>0V</td><td>Black</td></tr> </table>	P1	Hall A	White	P2	Hall B	Green	P3	Hall C	Blue	P4	5V	Red	P5	0V	Black
P1	M1	Grey																																													
P2	M1	Black (Jumper)																																													
P3	M3	Black																																													
P4	M3	Black (Jumper)																																													
P5	M2	Brown																																													
P6	M2	Black (Jumper)																																													
P7	Temp sensor 1	Black																																													
P8	Temp sensor 2	Orange																																													
P9	PE	Yellow																																													
P1	Hall A	White																																													
P2	Hall B	Green																																													
P3	Hall C	Blue																																													
P4	5V	Red																																													
P5	0V	Black																																													
9NF		<table border="1"> <tr><td>P1</td><td>M1</td><td>Grey</td></tr> <tr><td>P2</td><td>M1</td><td>Black (Jumper)</td></tr> <tr><td>P3</td><td>M3</td><td>Black</td></tr> <tr><td>P4</td><td>M3</td><td>Black (Jumper)</td></tr> <tr><td>P5</td><td>M2</td><td>Brown</td></tr> <tr><td>P6</td><td>M2</td><td>Black (Jumper)</td></tr> <tr><td>P7</td><td>Temp sensor 1</td><td>Black</td></tr> <tr><td>P8</td><td>Temp sensor 2</td><td>Orange</td></tr> <tr><td>P9</td><td>PE</td><td>Yellow</td></tr> </table>	P1	M1	Grey	P2	M1	Black (Jumper)	P3	M3	Black	P4	M3	Black (Jumper)	P5	M2	Brown	P6	M2	Black (Jumper)	P7	Temp sensor 1	Black	P8	Temp sensor 2	Orange	P9	PE	Yellow	CHC		<table border="1"> <tr><td>P1</td><td>Hall A</td><td>White</td></tr> <tr><td>P2</td><td>Hall B</td><td>Green</td></tr> <tr><td>P3</td><td>Hall C</td><td>Blue</td></tr> <tr><td>P4</td><td>5V</td><td>Red</td></tr> <tr><td>P5</td><td>0V</td><td>Black</td></tr> </table>	P1	Hall A	White	P2	Hall B	Green	P3	Hall C	Blue	P4	5V	Red	P5	0V	Black
	P1	M1	Grey																																												
P2	M1	Black (Jumper)																																													
P3	M3	Black																																													
P4	M3	Black (Jumper)																																													
P5	M2	Brown																																													
P6	M2	Black (Jumper)																																													
P7	Temp sensor 1	Black																																													
P8	Temp sensor 2	Orange																																													
P9	PE	Yellow																																													
P1	Hall A	White																																													
P2	Hall B	Green																																													
P3	Hall C	Blue																																													
P4	5V	Red																																													
P5	0V	Black																																													
CNF		<table border="1"> <tr><td>P1</td><td>M1</td><td>Grey</td></tr> <tr><td>P2</td><td>M2</td><td>Brown</td></tr> <tr><td>P3</td><td>M3</td><td>Black</td></tr> <tr><td>P4</td><td>Temp Sensor 1</td><td>Black</td></tr> <tr><td>P5</td><td>Temp Sensor 2</td><td>Orange</td></tr> <tr><td>P6</td><td>PE</td><td>Yellow</td></tr> </table>	P1	M1	Grey	P2	M2	Brown	P3	M3	Black	P4	Temp Sensor 1	Black	P5	Temp Sensor 2	Orange	P6	PE	Yellow	HCL		<table border="1"> <tr><td>P1</td><td>Hall A+</td></tr> <tr><td>P2</td><td>Hall A-</td></tr> <tr><td>P3</td><td>Hall B+</td></tr> <tr><td>P4</td><td>Hall B-</td></tr> <tr><td>P5</td><td>Hall C+</td></tr> <tr><td>P6</td><td>Hall C-</td></tr> <tr><td>P7</td><td>5V</td></tr> <tr><td>P8</td><td>0V</td></tr> </table>	P1	Hall A+	P2	Hall A-	P3	Hall B+	P4	Hall B-	P5	Hall C+	P6	Hall C-	P7	5V	P8	0V								
P1	M1	Grey																																													
P2	M2	Brown																																													
P3	M3	Black																																													
P4	Temp Sensor 1	Black																																													
P5	Temp Sensor 2	Orange																																													
P6	PE	Yellow																																													
P1	Hall A+																																														
P2	Hall A-																																														
P3	Hall B+																																														
P4	Hall B-																																														
P5	Hall C+																																														
P6	Hall C-																																														
P7	5V																																														
P8	0V																																														

Notes: All connectors shown are front view

STAGE 2 | PIX200 SERIES EXTENSION CABLE

Connection example: PIX200-□-□-□-□-□-9NF-HC-00

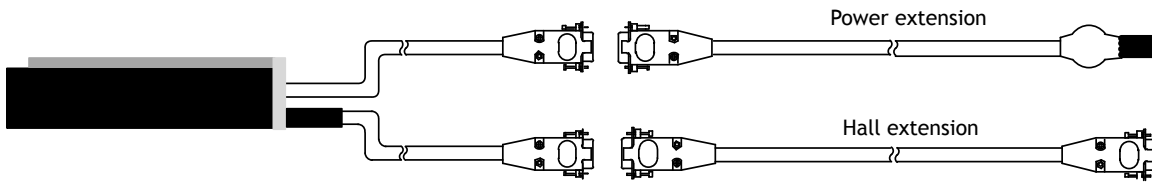

Extension Cable		Part Number																									
Power Extension Cable		CBL_EXT_PWR1_X.X																									
		CBL_EXT_PWR1_CC_X.X																									
Hall Sensor Extension Cable		CBL_EXT_HALLO_X.X																									
		CBL_EXT_HALLO_CC_X.X																									
		CBL_EXT_HALLO_DIF_X.X																									
Encoder Extension Cable		CBL_EXT_REN00_X.X																									
	<table border="1"> <thead> <tr> <th>CABLE</th> <th>CABLE LENGTH (X.X)</th> </tr> </thead> <tbody> <tr> <td>00</td> <td>RGH41, VIONIC, QUANTIC Digital</td> </tr> <tr> <td>00A</td> <td>RGH41 Analog</td> </tr> <tr> <td>01</td> <td>RH200 Digital</td> </tr> <tr> <td>01B</td> <td>PH200 Analog</td> </tr> <tr> <td>05</td> <td>ATOM Ri Interface Digital</td> </tr> <tr> <td>05A</td> <td>ATOM Ri Interface Analog</td> </tr> </tbody> </table>	CABLE	CABLE LENGTH (X.X)	00	RGH41, VIONIC, QUANTIC Digital	00A	RGH41 Analog	01	RH200 Digital	01B	PH200 Analog	05	ATOM Ri Interface Digital	05A	ATOM Ri Interface Analog	<table border="1"> <thead> <tr> <th>CABLE LENGTH (X.X)</th> <th>Length</th> </tr> </thead> <tbody> <tr> <td>0.5</td> <td>0.5 meter</td> </tr> <tr> <td>1.0</td> <td>1.0 meter</td> </tr> <tr> <td>2.0</td> <td>2.0 meter</td> </tr> <tr> <td>3.0</td> <td>3.0 meter (standard)</td> </tr> </tbody> </table>	CABLE LENGTH (X.X)	Length	0.5	0.5 meter	1.0	1.0 meter	2.0	2.0 meter	3.0	3.0 meter (standard)	CBL_EXT_REN00A_X.X
	CABLE	CABLE LENGTH (X.X)																									
	00	RGH41, VIONIC, QUANTIC Digital																									
	00A	RGH41 Analog																									
	01	RH200 Digital																									
	01B	PH200 Analog																									
05	ATOM Ri Interface Digital																										
05A	ATOM Ri Interface Analog																										
CABLE LENGTH (X.X)	Length																										
0.5	0.5 meter																										
1.0	1.0 meter																										
2.0	2.0 meter																										
3.0	3.0 meter (standard)																										
		CBL_EXT_REN01_X.X																									
		CBL_EXT_REN01B_X.X																									
		CBL_EXT_REN05_X.X																									
		CBL_EXT_REN05A_X.X																									

DXB/BT
PIX
PSM/PSME
CVC
CVC/A
RVCA
PDDR
PCA
PVA
PLA
PDAB
PIAB
OCTO
PRG
LINEAR ENCODER
SERVO AMPLIFIER

Application Form - Linear Motor Selection

Customer Name:	Date (DD/MM/YY):
Contact Email:	

PBA LINEAR MOTOR SELECTION QUESTIONNAIRE

1. Application Description

1a. Application Sketch With Approx Dimensions

2. Load Parameter

Moving mass (without motor coil)	kg	
Frictional force	N	
Oposing force	N	
Mx	N.m	My
		N.m
		MZ
		N.m

Stage Requirements

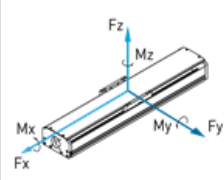

<input type="checkbox"/> Horizontal	<input type="checkbox"/> Vertical
<input type="checkbox"/> Sidewall	<input type="checkbox"/> Upside-down

3. Motion Parameter

	Profile 1	Profile 2	Profile 3
Moving distance	mm		
Moving time	s		
Moving velocity	m/s		
Acceleration	m/s ²		
Dwell time	s		

4. Command/Bus (Please Circle Accordingly)

Pulse and direction / Analog / EtherCAT / IO trigger / Other : _____

5. Encoder (Please Circle Accordingly)

Resolution	um	
Incremental / Absolute / Analog		

6. Motion Precision

Accuracy	um/mm	
Repeatability	um	

7. Mechanical Specification

Effective stroke	mm	
Flatness	um/mm	
Straightness	um/mm	
Space constraints (L x W x H)	mm	



8. Working Environment

Room temperature	°C	
Clean room class		

9. Additional Requirements (Please Tick () Accordingly)

Motor cable length	Controller	Amplifier	Encoder	Other: _____
m				

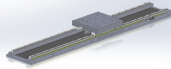
10. Actuator

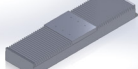
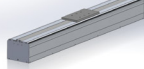
Open Frame	Enclosed			
	PARTIAL		BELLOW	
			STRIP SEAL	

11. Remarks: If you have any special motion request for sizing procedure, please specify your requirement in below remarks.

PBA SYSTEMS LINEAR MOTOR SIZER SOFTWARE



PBA Systems is a one-stop robotics provider with a focus on the development of core technology to offer a robust range of products and solutions in precision robotics and general robotics - enabling companies to thrive by making Industry 4.0 technology accessible to the market.

Our core strength is in design, development, and manufacturing of direct drive motor design and manufacturing, motion control, and precision modular assemblies.

Address:
**505 Yishun Industrial Park, A,
 Singapore 768733**

Contact Us:
**Tel: +(65) 6576 6766
 Fax: +(65) 6576 6768**



PBA SYSTEMS LINEAR MOTOR SIZER SOFTWARE

PBA Systems Motor Sizer Software is available to download from our website to assist in the calculation and selection.

Kindly visit us at www.pbasystems.com.sg or simply scan the QR CODE

SIMULATED PERFORMANCE CHARTS

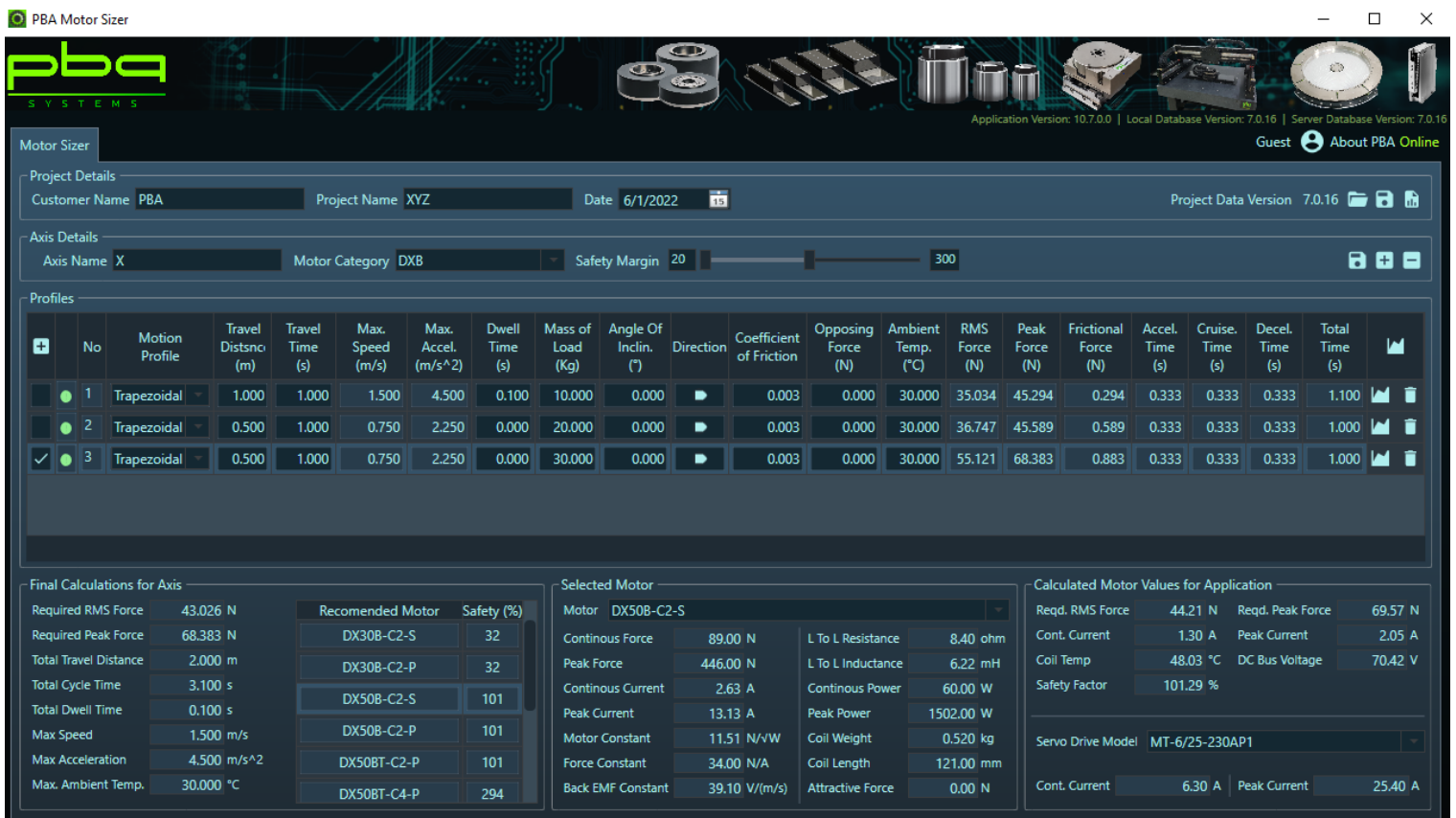

Motor Sizer

Project Details: Customer Name: PBA, Project Name: XYZ, Date: 6/1/2022, Project Data Version: 7.0.16

Axis Details: Axis Name: X, Motor Category: DXB, Safety Margin: 20 (slider to 300)

No	Motion Profile	Travel Distnnc (m)	Travel Time (s)	Max. Speed (m/s)	Max. Accel. (m/s^2)	Dwell Time (s)	Mass of Load (Kg)	Angle Of Incln. (°)	Direction	Coefficient of Friction	Opposing Force (N)	Ambient Temp. (°C)	RMS Force (N)	Peak Force (N)	Frictional Force (N)	Accel. Time (s)	Cruise. Time (s)	Decel. Time (s)	Total Time (s)
1	Trapezoidal	1.000	1.000	1.500	4.500	0.100	10.000	0.000	▶	0.003	0.000	30.000	35.034	45.294	0.294	0.333	0.333	0.333	1.100
2	Trapezoidal	0.500	1.000	0.750	2.250	0.000	20.000	0.000	▶	0.003	0.000	30.000	36.747	45.589	0.589	0.333	0.333	0.333	1.000
3	Trapezoidal	0.500	1.000	0.750	2.250	0.000	30.000	0.000	▶	0.003	0.000	30.000	55.121	68.383	0.883	0.333	0.333	0.333	1.000

Final Calculations for Axis

Required RMS Force	43.026 N	Recommended Motor	Safety (%)
Required Peak Force	68.383 N	DX30B-C2-S	32
Total Travel Distance	2.000 m	DX30B-C2-P	32
Total Cycle Time	3.100 s	DX50B-C2-S	101
Total Dwell Time	0.100 s	DX50B-C2-P	101
Max Speed	1.500 m/s	DX50BT-C2-P	101
Max Acceleration	4.500 m/s^2	DX50BT-C4-P	294
Max. Ambient Temp.	30.000 °C		

Selected Motor

Motor	DX50B-C2-S		
Continuous Force	89.00 N	L To L Resistance	8.40 ohm
Peak Force	446.00 N	L To L Inductance	6.22 mH
Continuous Current	2.63 A	Continuous Power	60.00 W
Peak Current	13.13 A	Peak Power	1502.00 W
Motor Constant	11.51 N/A/W	Coil Weight	0.520 kg
Force Constant	34.00 N/A	Coil Length	121.00 mm
Back EMF Constant	39.10 V/(m/s)	Attractive Force	0.00 N

Calculated Motor Values for Application

Reqd. RMS Force	44.21 N	Reqd. Peak Force	69.57 N
Cont. Current	1.30 A	Peak Current	2.05 A
Coil Temp	48.03 °C	DC Bus Voltage	70.42 V
Safety Factor	101.29 %		

Servo Drive Model: MT-6/25-230AP1

Cont. Current: 6.30 A | Peak Current: 25.40 A

APPENDIX

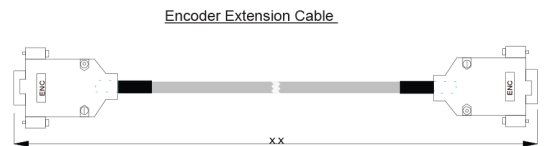
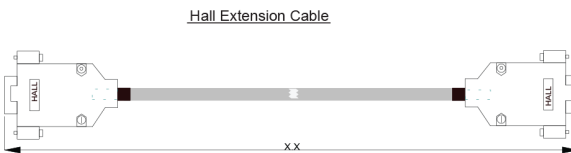
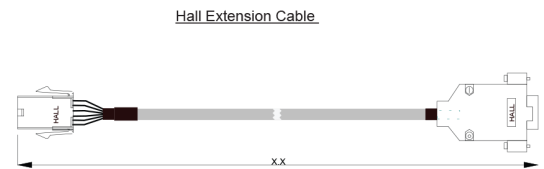
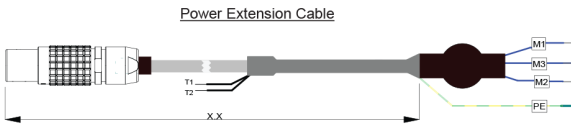
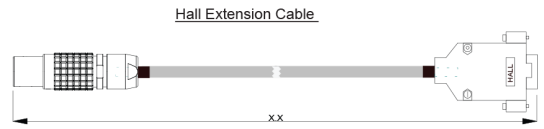
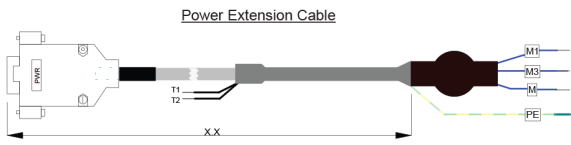

MOTOR POWER HALL CABLE

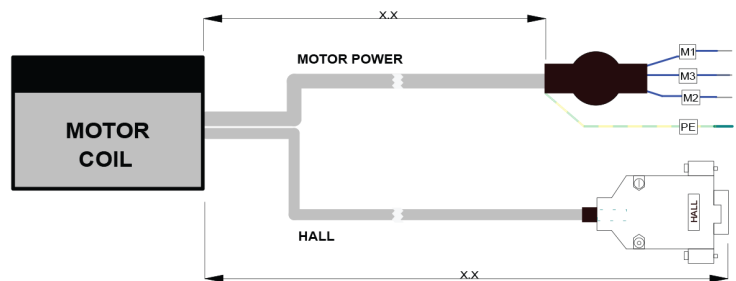

MAXTUNE FEEDBACK CABLE

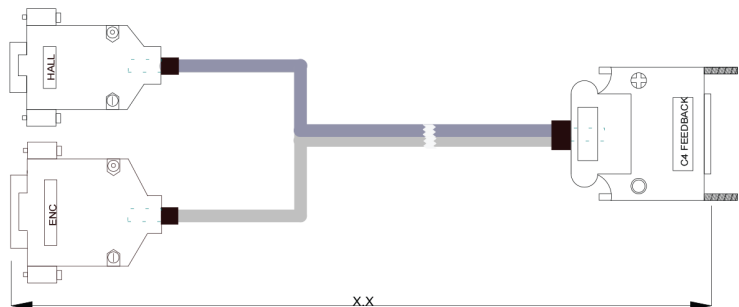

Notes:

1. X.X is the length of the cable in meter with a tolerance of $+ 0.10$ / $- 0$
2. All measurements are in meters (m) unless stated