



ZEF005042908

For Iron and Steel Industry

VARILIMIT[®]
Electronic Limit Switch
VS-10GH Series
Extended function version
Specifications and Instruction Manual



100VAC Model
VS-10GH-D-[]
VS-10GH-A-[]

24VDC Model
VS-10GH-D-1-[]
VS-10GH-A-1-[]
VS-10GH-C-1-[]

This manual describes the specifications and operating instructions of the extended function version of VS-10GH Series.

For the specifications and operating instruction of the basic function version, read the manual of the basic function version (separated manual).

CONTENTS

INTRODUCTION	i
HOW TO READ THIS MANUAL	i
RELATED MANUAL	i
COPYRIGHT	i
GENERAL SAFETY RULES	ii
REVISION HISTORY	v

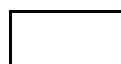

OVERVIEW

Describes about overview.

1. OVERVIEW	2
1-1. Overview	2
1-2. Features	2
1-3. Nomenclature	4
1-4. Terminology and Functions	6
1-4-1. VARILIMIT function list	6
1-4-2. Terminology and functions	7

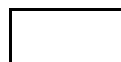

SPECIFICATION

Describes about specifications and outer dimensions.

2. VARILIMIT SPECIFICATIONS AND DIMENSIONS	22
2-1. Outer Dimensions	22
2-2. General Specification	25
2-3. Performance Specification	26
2-4. I/O Connector Specifications	27
2-4-1. Connector names and functions	27
2-4-2. I/O specification	28
2-4-3. Signal names and descriptions	34
2-4-4. I/O signal condition in the each mode	35
2-4-5. I/O Connector Pin Arrangement	36
2-5. Serial Communication Connector Specifications	42
2-5-1. Connector names and functions	42
2-5-2. Communication interface specification	42
2-5-3. Communication connector pin arrangement	42
2-6. Signal Timing Patterns	43
2-6-1. Power on/off timing	43
2-6-2. Program number change timing	43
2-6-3. Current position preset timing	45
2-6-4. Current position output timing	46
2-6-5. Multi-Origin timing	49
2-6-6. Error cancel input timing	49

CONTENTS

OPERATION

Describes about the operation of product.

3. OPERATION FLOW	52
3-1. Procedure Before the Operation	52
3-2. Nomenclature and Function of the Panel Side.....	54
3-3. Operation Flows in Different Modes	56
3-4. Turn ON the Power Supply.....	58
4. USE IN THE EXTENDED MODE	60
4-1. Setting the VARILIMIT Mode Selection Parameter	60
4-2. Parameter List	64
4-3. Basic Parameter Setting Procedure	76
4-4. Setting the Direction of ABSOCODER Rotation (Travel).....	77
4-5. Decimal Point Position Setting	79
4-6. Detection Range ("Scale") Setting	80
4-6-1. Multi-turn type ABSOCODER (MRE) setting description	81
4-6-2. Single-turn type ABSOCODER (VRE) setting description	82
4-6-3. CYLNUC/Rod sensor (VLS-12.8) setting description	83
4-6-4. CYLNUC Mark II / Inrodsensor (IRS-51.2P) setting description	84
4-6-5. Detection range ("scale") setting procedure	85
4-7. Current Position Preset Setting	88
4-8. Program Number Input Method Selection	94
4-9. Setting the Number of Protected Switches	95
4-10. Protected Switch Suspended Setting	96
4-11. Motion Detection Direction and Speed Setting	97
4-12. Current Position Output Setting.....	99
4-13. Setting the Output Status in Non-Run Modes.....	104
4-14. Measuring Function Setting.....	105
4-14-1. Definitions of current position value and measuring value	107
4-14-2. Measuring selection setting	108
4-14-3. Current position value/measuring value output selection	109
4-14-4. HOLD clear threshold setting	110
4-14-5. HOLD measuring stable width setting	111
4-14-6. HOLD measuring stable time setting	112
4-14-7. HOLD Measuring Completed Signal Output Enabled/Disabled Setting	113
4-15. Setting the Motion Recording Function	114
4-16. Sensor Filter Setting	118
4-17. Hysteresis Function	119
4-18. Setting the Switch Output Enabling Function	120
4-19. Setting the Multi-Origin Function	122
4-20. Setting the Preset Error Absorption Function	126
4-21. Setting the Limitswitchless Preset Function.....	129
4-22. Setting the Limitswitch Timer Function.....	136
4-23. Setting Analog Position/Speed Output.....	141
4-23-1. Selecting the position output or the speed output.....	147
4-23-2. Setting the output voltage range	149
4-23-3. Setting the position/speed range	151

CONTENTS

4-23-4. Setting the deadband position (speed) and width	153
4-23-5. Setting the speed sampling time and the number of speed gates	155
4-24. Selecting to Permit/Prohibit All-data Downloading	157
4-25. Communication Baud Rate Setting	158
4-26. Communication Protocol Setting	159
4-27. Node Number Setting	160
4-28. Device Selection Setting	161
4-29. Device Number Setting	162
4-30. Communication Dog Number Setting	163
5. Switch Output Setting	164
5-1. Switch output setting	164
5-2. Setting by teaching	167
5-3. Multi-dog setting	169
5-4. Deleting Switch Output Settings	172
5-4-1. Deleting a single dog	173
5-4-2. Deleting a single switch	175
5-4-3. Deleting a single program	177
6. Operation	180
6-1. Starting operation	180
6-2. Changing the monitor types	182
6-3. Monitors	183
7. TROUBLE SHOOTING	192
7-1. Error Displays and Countermeasures	192
7-2. Output Status upon Error Occurrence	195
7-3. Procedure Contents after Replacing	196
7-4. Initialization Operation	197
APPENDIX 1. DATA SHEET	200
APPENDIX 1-1. Extended Mode Data Sheet	200
APPENDIX 1-1-1. Parameter data sheet	200
APPENDIX 1-1-2. Multi-origin data sheet	205
APPENDIX 1-1-3. Limitswitch timer data sheet	206
APPENDIX 1-2. Switch Output Data Sheet	207

<input type="checkbox"/>	MAINTANANCE	Describes about countermeasures for errors.
--------------------------	-------------	---

<input type="checkbox"/>	APPENDIX	Attaches descriptions of the data sheets.
--------------------------	----------	---

INTRODUCTION

Thank you very much for purchasing our product.

Before operating this product, be sure to carefully read this manual so that you may fully understand the product, safety instructions and precautions.

- Please submit this manual to the operators actually involved in operation.
- Please keep this manual in a handy place.

HOW TO READ THIS MANUAL

Please read this manual when using the Extended mode.

This manual is composed as follows by each purpose.

- OVERVIEW : Describes about overview.
- SPECIFICATION : Describes about specifications and outer dimensions.
- OPERATION : Describes about the operation of product
- MAINTENANCE : Describes about countermeasures for errors.
- APPENDIX : Attaches descriptions of the data sheets.

RELATED MANUAL

Other specifications & instruction manuals related to this product are listed follows.

If necessary, please refer to this list to order the desired manual.

Detailed manual

Specification and Instruction Manual	Document No.
VS-10GH Series Basic function version	ZEF0050417**

** : Revision number

COPYRIGHT

Microsoft Windows is either a trademark or registered trademark of Microsoft Corporation in the United States and/or other countries.

MELSEC is the trademark or registered trademark of Mitsubishi Electric Corporation.

OMRON is the trademark or registered trademark of Omron Corporation.

Other companies' and products' names are the trademark or registered trademark of each company.

GENERAL SAFETY RULES



● Application Limitation

This product is not designed to be used under any situation affecting human life. When you are considering using this product for special purposes such as medical equipment, aerospace equipment, nuclear power control systems, traffic systems, and etc., please consult with NSD.

This product is designed to be used under the industrial environments categorized in Class A device. The supplier and user may be required to take appropriate measures.



● Signal Words

Safety precautions in this guide are classified into DANGER and CAUTION.



Symbol	Meaning
 DANGER	Incorrect handling may cause a hazardous situation that will result in death or serious injury.
 CAUTION	Incorrect handling may cause a hazardous situation that will result in moderate injury or physical damage.



Instructions accompanied by a symbol  **CAUTION** may also result in serious damage or injury. Be sure to follow the all instructions accompanied by the symbol.

● Graphic Symbols



Symbol	Meaning
	Indicates prohibited items.
	Indicates items that must be performed to.

1. Handling Precautions



 DANGER	
	- Do not touch components inside of VARILIMIT; otherwise, it will cause electric shock. - Do not damage the cable by applying excessive load, placing heavy objects on it, or clamping; otherwise, it will cause electric shock or fire.
	- Turn the power supply OFF before wiring, transporting, and inspecting VARILIMIT; otherwise, it may cause electric shock. - Provide an external safety circuit so that the entire system functions safely even when VARILIMIT is faulty. - Connect the grounding terminal of VARILIMIT; otherwise, it may cause electric shock or malfunction.

 CAUTION	
	- Do not use VARILIMIT in the following places; water splashes, the atmosphere of the corrosion, the atmosphere of the flammable vapor, and the side of the combustibility. Doing so may result in fire or VARILIMIT may become faulty.
	- Be sure to use VARILIMIT and the ABSOCODER in the environment designated by the general specifications in the manual. Failure to do so may result in electric shock, fire, malfunction or unit failure. - Be sure to use the specified combination of the ABSOCODER, VARILIMIT and sensor cable; otherwise, it may cause fire or VARILIMIT malfunction.



2. Storage

 CAUTION	
	- Do not store VARILIMIT in a place exposed to water, or toxic gas and liquid.
	- Be sure to store VARILIMIT in designed temperature and humidity range, and do not expose to direct sunlight. - Be sure to consult with NSD when VARILIMIT is stored for long periods.



3. Transport



 CAUTION	
	- Do not hold the cable or shaft of ABSOCODER during transport; otherwise, it will cause injury or malfunction.

4. Installation



 CAUTION	
	- Do not step on ABSOCODER or place heavy objects on VARILIMIT; otherwise, it will cause injury or malfunction. - Do not block the exhaust port or allow any foreign matter to enter VARILIMIT; otherwise, it will cause fire or VARILIMIT failure.
	- Be sure to secure VARILIMIT and ABSOCODER with the provided brackets; otherwise, it may cause malfunction, injury, or drop. - Be sure to secure the specified distance between VARILIMIT and the control panel or other equipment; otherwise, it may cause malfunction.

5. Wiring



 DANGER	
	- Be sure to secure the terminal block firmly; otherwise, it will cause fire. - Be sure to mount the terminal cover provided with VARILIMIT, before supplying the power, starting operation after the installation, and wiring; otherwise, it may cause electric shock.

 CAUTION	
	- Be sure to keep the sensor cable, control cable, and communication cable at least 300 mm away from the main circuit and power line; otherwise it may cause injury or malfunction. - Be sure to connect all cables correctly; otherwise, it may cause injury or malfunction. - Be sure to firmly connect the external I/O connectors and sensor connectors; otherwise, it may cause incorrect inputs and outputs or injury.



6. Operation

 CAUTION	
	<ul style="list-style-type: none">- Do not change the VARILIMIT's function switch settings during the operation; otherwise, it will cause injury.- Do not approach the machine after instantaneous power failure has been recovered. Doing so may result in injury if the machine starts abruptly.
	<ul style="list-style-type: none">- Be sure to check that the power supply specifications are correct; otherwise, it may cause VARILIMIT failure.- Be sure to provide an external emergency stop circuit so that operation can be stopped with power supply terminated immediately.- Be sure to conduct independent trial runs for VARILIMIT before mounting ABSOCODER to the machine; otherwise, it may cause injury.- When an error occurs, be sure to eliminate the cause, ensure safety, and reset the error before restarting operation; otherwise, it may cause injury.

7. Maintenance and Inspection

 CAUTION	
	<ul style="list-style-type: none">- Do not disassemble, remodel, or repair the unit; otherwise, it will cause electric shock, fire, and unit malfunction.
	<ul style="list-style-type: none">- The capacitor of the power line deteriorates through prolonged use. We recommended that the capacitor be replaced every five years to prevent secondary damage.

8. Disposal

 CAUTION	
	<ul style="list-style-type: none">- Be sure to handle VARILIMIT and ABSOCODER as industrial waste while disposing of it.

REVISION HISTORY

The Document No. appears at the upper right of this manual's cover page.

Document No.	Date	Revision Description
ZEF005042900	17, July, 2012	1st Edition Japanese document: ZEF005042600
ZEF005042901	19, Jun., 2013	2nd Edition Japanese document: ZEF005042601
ZEF005042902	30, Jan., 2015	3rd Edition Japanese document: ZEF005042602
ZEF005042903	23, Mar., 2016	4th Edition Japanese document: ZEF005042603
ZEF005042904	6, Jun., 2022	5th Edition Japanese document: ZEF005042604
ZEF005042905	21, Jul., 2022	6th Edition Japanese document: ZEF005042605
ZEF005042906	23, May, 2023	7th Edition Japanese document: ZEF005042606
ZEF005042907	6, May, 2024	8th Edition Japanese document: ZEF005042607
ZEF005042908	14, Jun., 2024	9th Edition Japanese document: ZEF005042608

OVERVIEW

Describes about overview.

1. OVERVIEW



1. OVERVIEW

1-1. Overview

This manual explains the Extended mode of VS-10GH.

Specify the Extended Mode when the VS-10GH Series is newly employed or its new functions will be newly added.

In addition to the existing position decision functions such as Switch Output and Current Position Output, many new functions such as Measuring and Communication are added in the Extended mode.

Refer to Chapter 1-4 for details of the functions.

1-2. Features

(1) Automated setup change

The VS-10GH Series can register up to 32 programs for each product in advance.
The setup can be easily changed by selecting program numbers.

(2) Current Position Output function

VARILIMIT's current position value can be output in BCD or binary code.
Applicable models: VS-10GH-D, VS-10GH-D-1

(3) Analog Output function

This is a function to enable analog voltage output that corresponds to the current position value or the speed.
A deadband can be set to slowdown response at an origin or any other specified point.

Some models are specified for analog current output
Applicable models: VS-10GH-A, VS-10GH-A-1, VS-10GH-C-1

	NOTES
Do not control by the speed output. Use the speed output for monitoring.	

(4) Measuring function

This is a function to obtain position measurement and output the result as a numerical value. Can be easily used for machining-end position measurement.

(5) Motion Recording function

Machine trajectories can be recorded in graph form using VARIMONI or any other setting and editing software. Motion analysis becomes easy.

(6) Motion Detection function

This is a function to detect the direction and speed of machine travel to output signals. Machine stop can be easily confirmed using this function.

(7) Switch Output Enabling function

By turning ON/OFF the Switch Output Enabling function for input signals, the switch output set at its parameter can be forced to go ON/OFF.

(8) Multi-Origin function

As a current position value can be set for each program, a machine can store multiple origin positions.

(9) Limitswitchless Preset function

No limitswitch is needed for the current position preset. This function is effective for the use in an adverse environment where a limitswitch is not available.

(10) Preset Error Absorption function

Even when a workpiece cannot move to the movable end or the origin, its correct position can be detected without a position gap, as long as the workpiece stays within the range of error absorption.

(11) Limitswitch Timer function

In addition to ON/OFF positions, ON delay times and ON times can be set for the switch output data. After the machine arrives at the set position, the actuator which is used to open and close the valve can run in a certain period of time.

(12) Sensor Filter function

Current position values can be filtered. Fluctuations of current position values, which occur due to machine vibration or other factors, can be reduced.

(13) Hysteresis function

Current position values may fluctuate even when the machine is stopped. The fluctuations can be reduced by using this function.



1-3. Nomenclature

●Front side

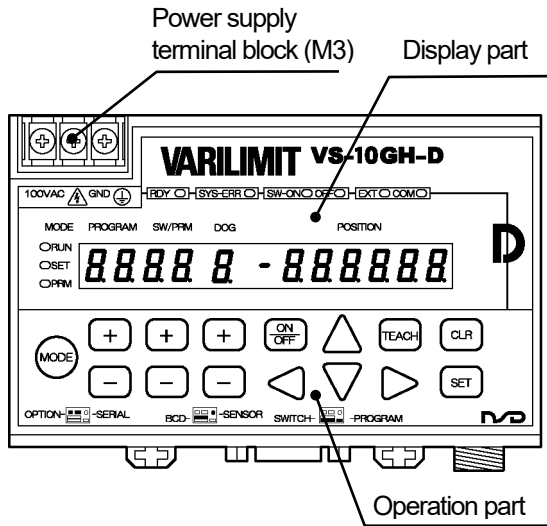

●Right side

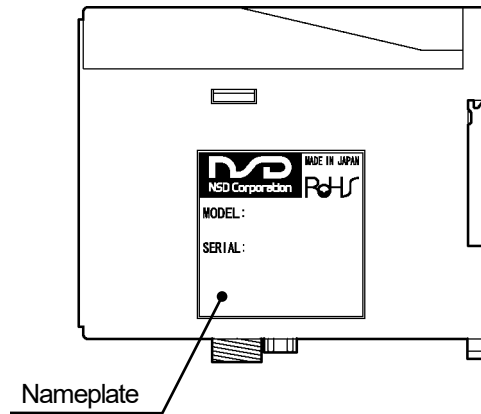

●Bottom side VS-10GH-D, VS-10GH-D-1

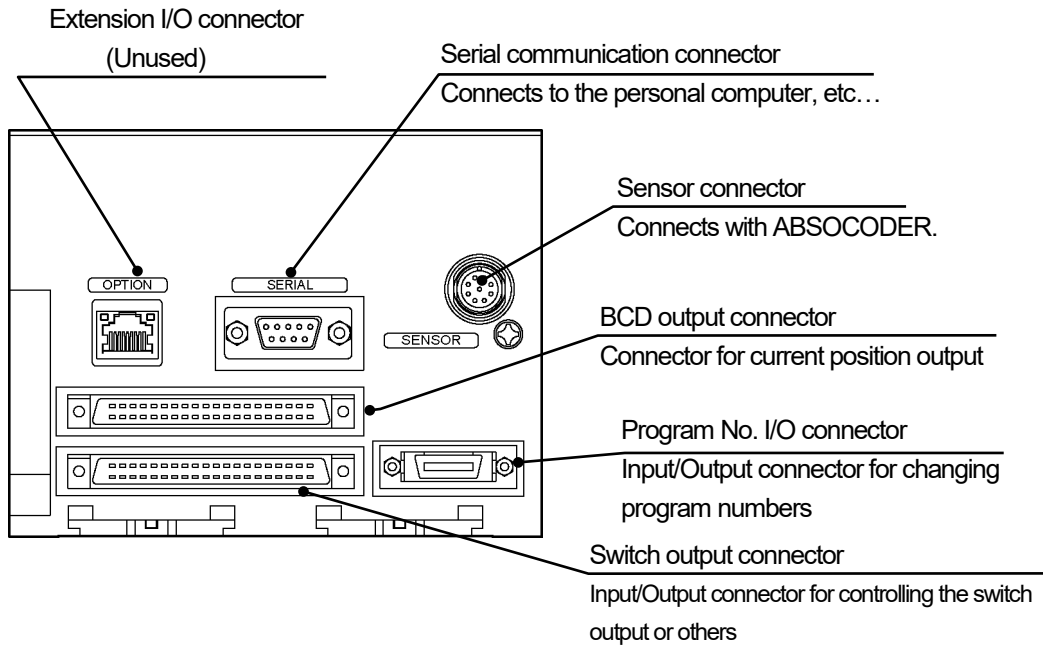

●Bottom side VS-10GH-A, VS-10GH-A-1, VS-10GH-C-1

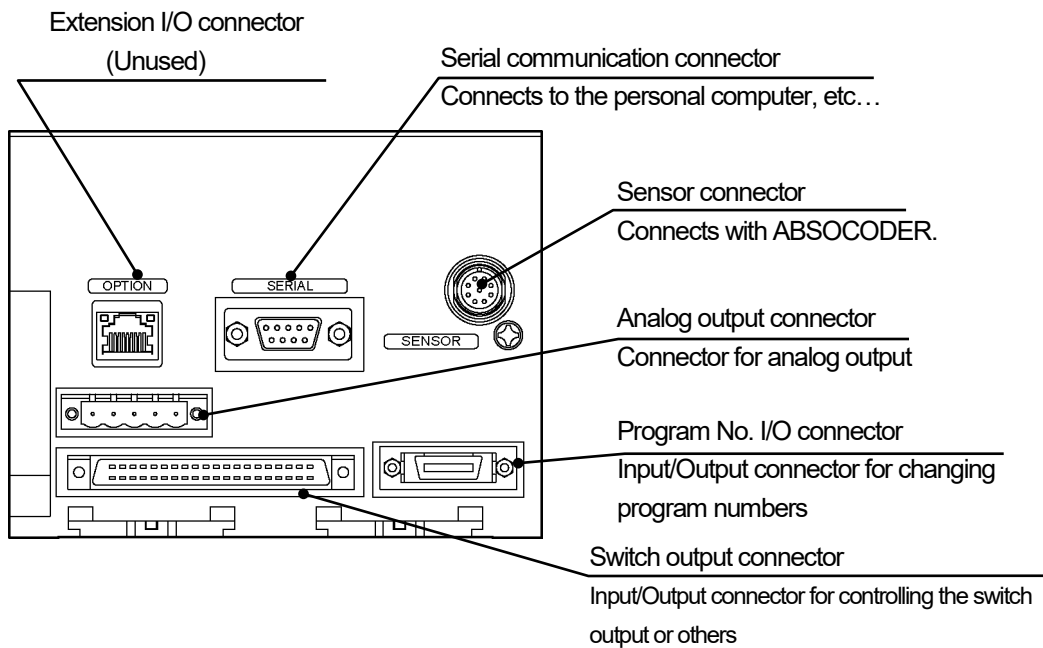

1-4. Terminology and Functions

1-4-1. VARILIMIT function list

This section shows functions of each product model of the VARILIMIT VS-10GH Series. The functions differ depending on the operation mode. It can be switched using Parameter E0 for the VARILIMIT Mode Selection.

Refer to the following sections for details of the operation modes: Extended Mode: Chapter 4-1, VS-10B Mode: Basic function version of the manual.

	Model	VS-10GH-D VS-10GH-D-1 (with Current Position Value output)		VS-10GH-A VS-10GH-A-1 (with voltage output)		VS-10GH-C-1 (with current output)	
		VS-10B Mode	Extended Mode	VS-10B Mode	Extended Mode	VS-10B Mode	Extended Mode
Existing Functions	Switch Output	○	○	○	○	○	○
	Protected Switch	○	○	○	○	○	○
	Multi-Dog	○	○	○	○	○	○
	Program	○	○	○	○	○	○
	TEACH Setting	○	○	○	○	○	○
	Current Position Output	○	○				
	Current Position Preset by Travel Direction Input	○		○		○	
	Position Analog Output			○	○	○	○
New Functions	Current Position Preset by Auto-detecting Travel Direction		○		○		○
	Speed Analog Output				○		○
	Output HOLD		○		○		○
	Measuring		○		○		○
	Motion Recording		○		○		○
	Motion Detection		○		○		○
	Sensor Filter		○		○		○
	Hysteresis		○		○		○
	Switch Output Enabling		○		○		○
	External Error Cancel Input	○	○	○	○	○	○
	Multi-Origin		○		○		○
	Limitswitchless Preset *1		○		○		○
	Preset Error Absorption *1		○		○		○
	Limitswitch Timer		○		○		○
	Serial Communication	○	○	○	○	○	○
Password	○	○	○	○	○	○	

*1: This function cannot use when connecting to the single-turn type ABSOCODER (VRE).

1-4-2. Terminology and functions

This section explains about product functions and the related terminology.

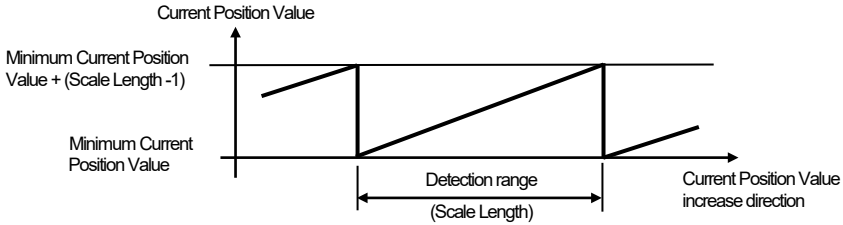
Item	Description
ABSOCODER	<p>"ABSOCODER" is a generic name referring to the type of sensing devices that detects rotational and linear displacement as well as speed and acceleration in an absolute format and outputs them digitally (or analogously). "ABSOCODER" comprises a detection unit that converts displacement into a variation in magnetic resistance and a conversion unit that inputs an alternating-current energization signal into the detection unit and then issues an absolute-format data according to the output signal returned from the detection unit.</p> <p>ABSOCODER sensors can be divided into two types, the rotary type that detects rotational position and the linear type that detects linear position.</p> <p>VARILIMIT has a built-in conversion unit so as to be able to use an ABSOCODER sensor.</p>
Scale Length	<p>"Scale Length" refers to the "longest distance that the ABSOCODER sensor will be able to detect in an absolute format". The scale length can be set using a unit of length appropriate for the amounts of travel involved (millimeter, centimeter, inch etc.).</p> <p>Parameter 99 (Scale Length [L]) can be used for Scale Length setting.</p> <p>●With the Multi-turn type ABSOCODER (MRE)</p> <p>The "Scale Length" is the amount of machine travel attained after the sensor shaft has completed a total number of turns (32, 64, 128, 160, 256, 320, 512, 1280, 2048, 2560).</p> <p>Example: If a 32-turn MRE is directly connected to the feed mechanism of a 10 mm-lead ball screw, the detection range can be calculated by the following equation.</p> <p>Detection range: [10 mm/turn] x 32 turns = 320 mm</p> <p>If the number of decimals to shown on the VARILIMIT display is set to two ("0.01 mm"), the Scale Length [L] should be as follows:</p> $\text{Scale Length [L]} = \frac{\text{Detection range}}{\text{Smallest unit of length}} \quad L = \frac{320}{0.01} = 32000$ <p>Set the number of decimals to be shown using Parameter 90 (Decimal Point Position).</p> <p>To display in inches, convert the scale length in millimeters into that in inches.</p> <p>Example: Scale Length [L] should be as follows:</p> $\text{Scale Length [L]} = 320 \div 25.4 = 12.598$ <p>The Scale Length value should be set "12.598".</p> <p>Set the number of decimals to be shown using Parameter 90 (Decimal Point Position).</p> <div data-bbox="389 1617 1418 2033" style="border: 1px solid black; padding: 5px;"> <p>NOTES</p> <p>As soon as the machine travels out of the detection range, the VARILIMIT display value (Current Position Value) will jump by the whole Scale Length.</p> <p>Make sure that the machine never travels beyond the detection range.</p>  </div>

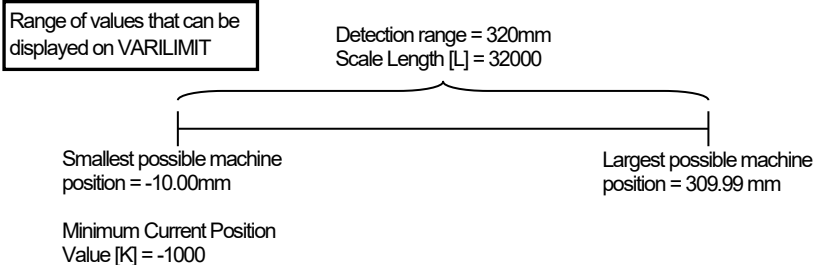
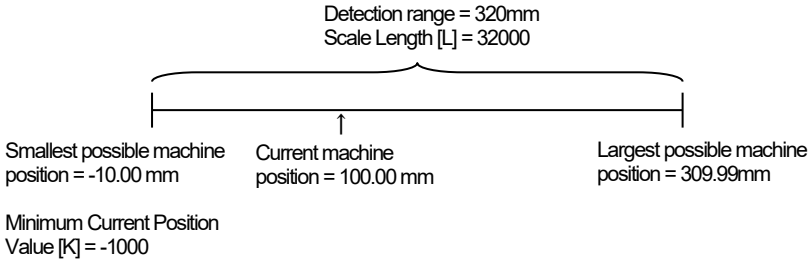
Item	Description
<p>Minimum Current Position Value</p>	<p>"Minimum Current Position Value" is the smallest possible Current Position Value that can be displayed on the VARILIMIT and can be set to any given value in the range of [-999999 to (1000000 - Scale Length)]. Set the value using Parameter 98 (Minimum Current Position Value [K]).</p> <p>Example: If the smallest possible machine position is -10 mm and all the other conditions are the same as those described in the previous Scale Length of the Multi-turn type ABSOCODER example, the Minimum Current Position Value [K] should be as follows:</p> $\text{Minimum Current Position Value [K]} = \frac{\text{Smallest possible machine position}}{\text{Smallest unit of length}} \quad K = \frac{-10}{0.01} = -1000$ 
<p>Current Position Value</p>	<p>"Current Position Value" is a value that represents where in the detection range the machine is currently located. The Current Position Value can be set to any given value within the range of [Minimum Current Position Value to (Minimum Current Position Value + Scale Length - 1)]. Set the value using Parameter 97 (Current Position Setting).</p> <p>Example: If the Current Position Value is set to "10000" (arrowed position) under the same conditions as those described in the previous Scale Length of the Multi-turn type ABSOCODER example:</p> 
<p>ABSOCODER Rotation (Travel) Direction</p>	<p>The current position value increases or decreases depending on <u>the ABSOCODER sensor's rotation direction (or on the rod travel direction when a linear-type ABSOCODER sensor is used).</u> The current position value increase direction can be set according to a specified ABSOCODER sensor <u>rotation (travel) direction.</u> Set the direction using Parameter 91 (Sensor Selection / Sensor Rotation (Travel) Direction). For setting details, refer to Chapter 4-4.</p>

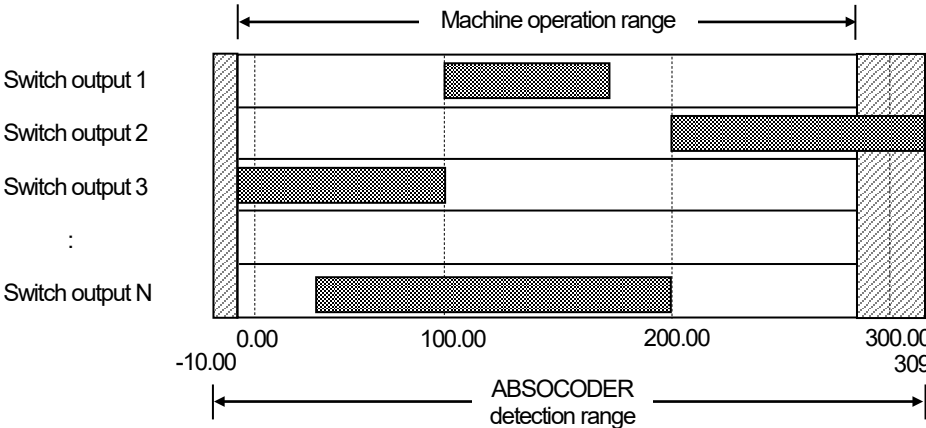
Item	Description																		
<p>Switch Output</p>	<p>The Switch Output function works in the same way as outputs from a mechanical limit switch or proximity switch. With ON and OFF positions registered to the VARILIMIT, the switch output will come on or go off depending on the machine position detected by the ABSOCODER.</p> <table border="1" data-bbox="491 412 1088 622"> <thead> <tr> <th><Setting example></th> <th>ON position</th> <th>OFF position</th> </tr> </thead> <tbody> <tr> <td>Switch output 1</td> <td>100.00</td> <td>170.00</td> </tr> <tr> <td>Switch output 2</td> <td>200.00</td> <td>309.99</td> </tr> <tr> <td>Switch output 3</td> <td>-5.00</td> <td>100.00</td> </tr> <tr> <td>:</td> <td></td> <td></td> </tr> <tr> <td>Switch output N</td> <td>30.00</td> <td>200.00</td> </tr> </tbody> </table> <p>● Described below is the relationship between the Switch Output setting values and the actual output.</p> <ul style="list-style-type: none"> - In the above example, Switch Output 1 ON and OFF positions are set to 100.00 and 170.00, respectively. With this, the switch output will remain on through the range of $100.00 \leq \text{Current position} < 170.00$. This means that, when the Current Position Value increases from "0.00", the switch output will come on as soon as the displayed Current Position Value has reached "100.00" to remain on up to "169.99", and then will go off as soon as the value reaches "170.00". When the Current Position Value decreases, the switch output will remain off through to "170.00" and then will come on as soon as the value goes down to "169.99". The output will go off again when the value has further decreased to "99.99". 	<Setting example>	ON position	OFF position	Switch output 1	100.00	170.00	Switch output 2	200.00	309.99	Switch output 3	-5.00	100.00	:			Switch output N	30.00	200.00
<Setting example>	ON position	OFF position																	
Switch output 1	100.00	170.00																	
Switch output 2	200.00	309.99																	
Switch output 3	-5.00	100.00																	
:																			
Switch output N	30.00	200.00																	
<p>Protected Switch</p>	<p>One of the advantages of VARILIMIT is that the switch output settings can be entered and changed easily. Depending on the machine application, however, critical switch outputs may need to be guarded against careless changes. The Protected Switch function is provided to serve such needs.</p> <p>Settings of a Protected Switch cannot be entered or changed by regular steps. Before a Protected Switch's output settings can be entered, changed or deleted, the switch protection needs to be canceled first.</p> <p>For setting details, refer to Chapter 4-9.</p>																		
<p>Multi-Dog</p>	<p>Up to ten or four ON and OFF positions ("Dogs") can be set for each switch output.</p> <p>8-program mode (Parameter E0: 1): The Dogs are numbered from 1 to A (10).</p> <p>32-program mode (Parameter E0: 2): The Dogs are numbered from 1 to 4.</p> <p>Switch output ON OFF <table border="1" data-bbox="667 1944 1252 2000"> <tr> <td>1</td> <td>2</td> <td>3</td> <td>4</td> <td>5</td> <td>6</td> <td>7</td> <td>8</td> <td>9</td> <td>A(10)</td> </tr> </table></p> <p>For setting details, refer to Chapter 5-3.</p>	1	2	3	4	5	6	7	8	9	A(10)								
1	2	3	4	5	6	7	8	9	A(10)										

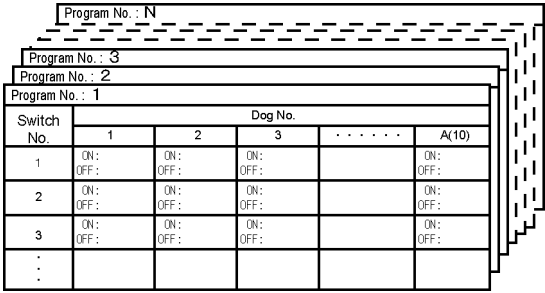
Item	Description
<p>Program</p>	<p>This function registers one switch output pattern as a program. The setup is easily changed by switching this Program.</p>  <ul style="list-style-type: none"> ● Number of Programs <ul style="list-style-type: none"> 8-program mode (Parameter E0: 1): Up to 30 switch data for each program can be set with up to 10 Dogs for each switch 32-program mode (Parameter E0: 2): Up to 30 switch data for each program can be set with up to 4 Dogs for each switch ● Method to Input the Program Number <ul style="list-style-type: none"> 8-program mode (Parameter E0: 1): Input each of 8 points signals individually. 1 input = 1 program 32-program mode (Parameter E0: 2): Input 5 points data in binary code.
<p>TEACH Setting</p>	<p>TEACH setting is able to set ON/OFF position of each switch by actually moving the machine. For setting details, refer to Chapter 5-2.</p>
<p>Current Position Output</p>	<p>For external display devices or for control purposes, the VARILIMIT current position value output is made in binary or BCD code.</p> <ul style="list-style-type: none"> ● In the Extended Mode (Parameter E0: 1 or 2): The logic and the update cycle of this Current Position Output can be set using Parameters 94 and 74. For setting details, refer to Chapter 4-12. <p>When the Measuring function is used, either the current position value or the measuring value can be chosen for the Current Position Output at Parameter 68 (Current Position Value/Measuring Value Output Selection). For setting details, refer to Chapter 4-14-3.</p> <p>Applicable models: VS-10GH-D, VS-10GH-D-1</p>
<p>Output Hold</p>	<p>The Output HOLD function applies only to the Extended Mode (Parameter E0: 1 or 2). This causes the present switch output state to be held as it is when the mode is switched from the "RUN" to another. While program number change is executed, the output status is maintained until the new program number becomes established. Enter the Output HOLD setting using Parameter 78 (with output status in other than the RUN mode). For setting details, refer to Chapter 4-13.</p>

Item	Description
<p>Analog Position Output</p>	<p>This function outputs positions using voltage or current signals. Two channels are provided for this output.</p> <p>● In the Extended Mode (Parameter E0: 1 or 2): The position/voltage range can be set as desired. The deadband position and its width can be set for analog output as well.</p> <p>Set items for each channel output using parameters.</p> <p>Channel 1</p> <ol style="list-style-type: none"> 1. Use Parameter 26 to set the minimum output voltage (Vmin) 2. Use Parameter 27 to set the maximum output voltage (Vmax) 3. Use Parameter 29 to set the minimum output position/speed 4. Use Parameter 30 to set the maximum output position/speed 5. Use Parameter 25 to set the deadband position/speed 6. Use Parameter 24 to set the deadband width <p>Channel 2</p> <ol style="list-style-type: none"> 1. Use Parameter 34 to set the minimum output voltage (Vmin) 2. Use Parameter 35 to set the maximum output voltage (Vmax) 3. Use Parameter 37 to set the minimum output position/speed 4. Use Parameter 38 to set the maximum output position/speed 5. Use Parameter 33 to set the deadband position/speed 6. Use Parameter 32 to set the deadband width <p>For setting details, refer to Chapter 4-23.</p> <p>Applicable models: VS-10GH-A, VS-10GH-A-1 for analog voltage output VS-10GH-C-1 for analog current output</p>
<p>Analog Speed Output</p>	<p>This function applies only to the Extended Mode (Parameter E0: 1 or 2).</p> <p>This is a function to output speeds using voltage or current. Two channels are provided for this output. Positions and speeds can be switched using Parameters 28 and 36. The speed/voltage range can be set as desired. The deadband position and its width can be set for analog output as well. Share parameters for settings with the Analog Position Output function.</p> <p>For setting details, refer to Chapter 4-23.</p> <p>Applicable models: VS-10GH-A, VS-10GH-A-1 for analog voltage output VS-10GH-C-1 for analog current output</p> <div data-bbox="475 1630 1177 1803" style="border: 1px solid black; padding: 5px;"> <p> NOTES</p> <p>Do not control by the speed output. Use the speed output for monitoring.</p> </div>

Item	Description
<p>Current Position Preset by Auto-detecting Travel Direction</p>	<p>This function applies only to the Extended Mode (Parameter E0: 1 or 2).</p> <p>When an error is found between the actual machine position and the displayed VARILIMIT Current Position Value, the Current Position Value can be corrected to a predetermined value by way of external input ("Current Position Preset input").</p> <p>Two Current Position Preset Values, one forward and one reverse, can be set.</p> <p>The VARILIMIT will automatically determine the machine travel direction based on the variation in the Current Position Value inside the system. The Current Position Preset activates at the leading edge where the input state changes from OFF to ON.</p> <p>The current position preset can be made at two points as follows. Set these five items for each input.</p> <p>Current position preset input 1</p> <ol style="list-style-type: none"> 1. Parameter 92 (Current Position Preset Function Selection) 2. Parameter 82 (Current Position Preset Error Selection) 3. Parameter 7 ("FWD Current Position Preset" Value 1) 4. Parameter 6 ("RVS Current Position Preset" Value 1) 5. Parameter 8 (Permissible Correction Amount 1) <p>Current position preset input 2</p> <ol style="list-style-type: none"> 1. Parameter 92 (Current Position Preset Function Selection) 2. Parameter 82 (Current Position Preset Error Selection) 3. Parameter 10 ("FWD Current Position Preset" Value 2) 4. Parameter 9 ("RVS Current Position Preset" Value 2) 5. Parameter 11 (Permissible Correction Amount 2) <div data-bbox="539 1111 1270 1485" data-label="Diagram"> <p>The diagram illustrates the current position preset function. On the left, a machine with an ABSOCODER and a VS-10GH display is shown. The display shows a value of 171.5, while the actual machine position is 180.0. An arrow points to the right, where the display now shows 180.0, indicating a correction to a predetermined value. A dashed box highlights the display and the text 'Preset input: Correction to a predetermined value'.</p> </div> <p>With an error between the Current Position Value and the actual machine position</p> <p>For setting details, refer to Chapter 4-7.</p>

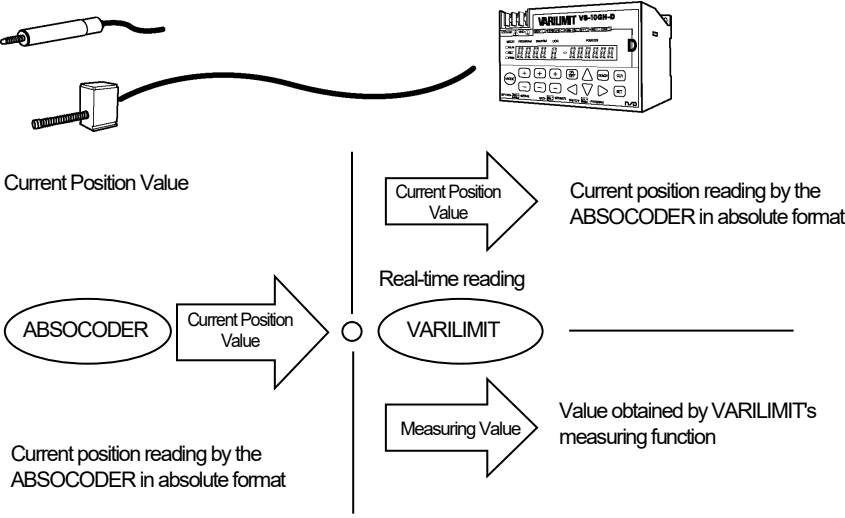
Item	Description
<p>Measuring</p>	<p>This function applies only to the Extended Mode (Parameter E0: 1 or 2).</p> <p>The Measuring function is provided for machining-end position measurement and other similar purposes. The Measuring function can work in either the External Trigger mode or the HOLD Measuring mode. Select one of the two modes using Parameter 67 (Measuring Selection).</p> <ol style="list-style-type: none"> 1. External Trigger Mode An external measuring trigger signal input from the host controller into the switch output connector will cause the Current Position Value to be "held" so that it can be read as a measuring value. 2. HOLD Measuring Mode "HOLD Measuring" refers to a function where the Current Position Value will be automatically held so that it can be read as a measuring value when the Current Position Value has remained within the Stable Width for the duration of the Stable Time after passing the HOLD Clear Threshold. This monitors the Current Position Value behavior, so measurement can be obtained after current position value fluctuations have ceased. For the monitoring of Current Position Value behavior, set Parameters 64 (HOLD Measuring Stable Time) and 65 (HOLD Measuring Stable Width). The completion signal can be sent out when HOLD measuring is completed by setting Parameter 62 (HOLD Measuring Completed Output (Approved/Disapproved)). <p>For Measuring function details, refer to Chapter 4-14.</p>
<p>Current Position Value/Measuring Value Output Selection</p>	<p>This function applies only to the Extended Mode (Parameter E0:1 or 2).</p> <p>When using the Measuring function, selection can be made whether to use the "Current Position Value" or "Measuring Value" for switch output control. In the case of VS-10GH-D and VS-10GH-D-1, it is also possible to select whether to use the Current Position Value or the Measuring Value for current position output.</p> <p>Enter the selection using Parameter 68 (Current Position Value/Measuring Value Output Selection). For setting details, refer to Chapter 4-14-3.</p> <p>● Definition of "Current Position Value" and "Measuring Value"</p>  <p>The diagram illustrates the data flow between an ABSOCODER and a VARILIMIT unit. On the left, an ABSOCODER provides a 'Current Position Value' (Current position reading by the ABSOCODER in absolute format). This value is sent to the VARILIMIT unit. The VARILIMIT unit then outputs a 'Current Position Value' (Current position reading by the ABSOCODER in absolute format) and a 'Measuring Value' (Value obtained by VARILIMIT's measuring function). A 'Real-time reading' is also shown.</p>

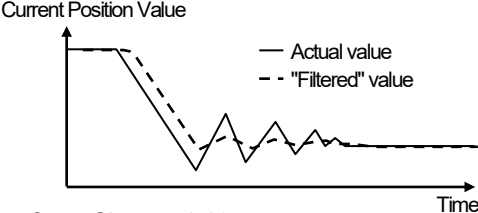
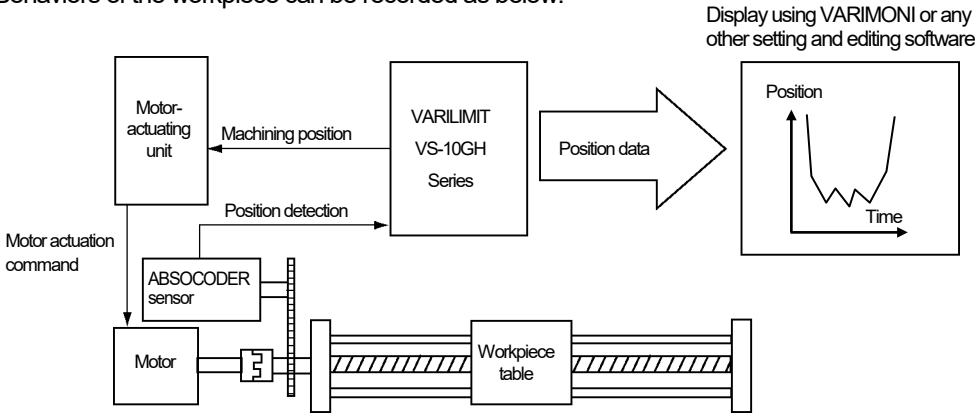
Item	Description
<p>Sensor Filter</p>	<p>This function applies only to the Extended Mode (Parameter E0:1 or 2).</p> <p>The Sensor Filter function can be used when the Current Position Value tends to fluctuate, for example due to machine vibration.</p> <p>With the Sensor Filter on, the displayed Current Position Value will actually be an average of a number of Current Position Value samplings.</p> <p>The number of samplings can be selected from 4, 8, 16, 32, 64 and 128.</p> <p>Enter the Sensor Filter setting using Parameter 63 (Sensor Filter).</p>  <p>For setting details, refer to Chapter 4-16.</p>
<p>Motion Recording</p>	<p>This function applies only to the Extended Mode (Parameter E0:1 or 2).</p> <p>Machine trajectories can be recorded in graph form using VARIMONI or any other setting and editing software. The machine moves in the preset direction. After passing the start position for Motion Recording, 100 current position values can be recorded for each specified sampling cycle.</p> <p>Behaviors of the workpiece can be recorded as below:</p>  <p>For the Motion Recording function, specify the following three items:</p> <ol style="list-style-type: none"> 1. Parameter 67 (Measuring / Motion Recording Selection) 2. Parameter 66 (Motion Recording Start Position) 3. Parameter 64 (Motion Recording Sampling Cycle) <p>For setting details, refer to Chapter 4-15.</p>
<p>Motion Detection</p>	<p>This function applies only to the Extended Mode (Parameter E0:1 or 2).</p> <p>As soon as the machine travels in the predetermined direction and above the predetermined travel speed, the Motion Detection output will come on.</p> <p>Machine travel speed is calculated every 10 ms to determine whether or not to issue a Motion Detection output. The travel speed is actually determined based on the Current Position Value variation compared to 100 ms before.</p> <p>The following two Motion Detection parameters are provided.</p> <ol style="list-style-type: none"> 1. Parameter 77 (Motion Detection: Direction) 2. Parameter 76 (Motion Detection: Speed) <p>For setting details, refer to Chapter 4-11.</p>

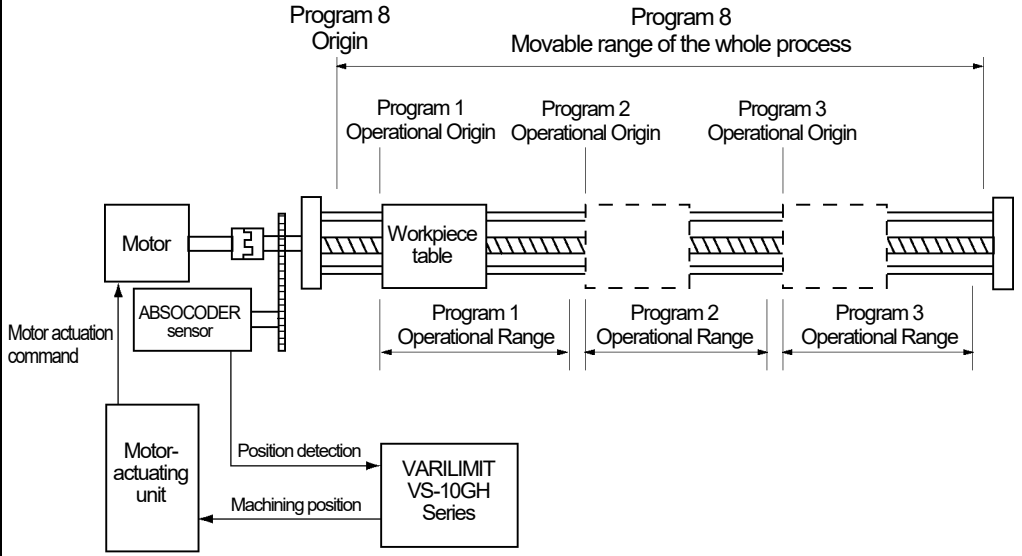
Item	Description
<p>Switch Output Enabling</p>	<p>This function applies only to the Extended Mode (Parameter E0: 1 or 2). By turning off the Switch Output Enabling input signal, the switch output set at its parameter can be forced to go OFF. Turning off of the switch output without a workpiece can be easier. For setting details, refer to Chapter 4-18.</p>
<p>External Error Cancel Input</p>	<p>Cancels an error by inputting the external signal.</p>
<p>Multi-Origin</p>	<p>This function applies only to the Extended Mode (Parameter E0: 1 or 2).</p> <p>The Multi-Origin function enables settings of origins (current position values) for each program.</p> <p>For example: When there are several processes to complete by a machine, an operational origin can be set for each process.</p>  <p>The diagram illustrates the Multi-Origin function. It shows a Motor connected to a Workpiece table via a drive mechanism. An ABSOCODER sensor is mounted on the table to detect its position. A Motor-actuating unit sends a Motor actuation command to the motor and receives Position detection from the ABSOCODER sensor. A VARILIMIT VS-10GH Series sensor is also connected to the Motor-actuating unit, providing Machining position feedback. The diagram shows Program 8 Origin at the start of the process. Below it, Program 1, Program 2, and Program 3 have their own Operational Origins and Operational Ranges. A dashed line indicates the Movable range of the whole process.</p> <p>Set the Multi-Origin function at Parameter 5 (Multi-Origin Selection). A common origin (current position value) is applied to the programs from the top to what is set at Parameter 5. For each of subsequent programs, an individual origin (current position value) can be set separately.</p> <p>Set the origin (current position value) at Parameter 97 (Current Position Setting). The Current Position Preset by Auto-detecting Travel Direction function enables the preset of the current position value for each program as well.</p> <p>For setting details, refer to Chapter 4-19.</p>

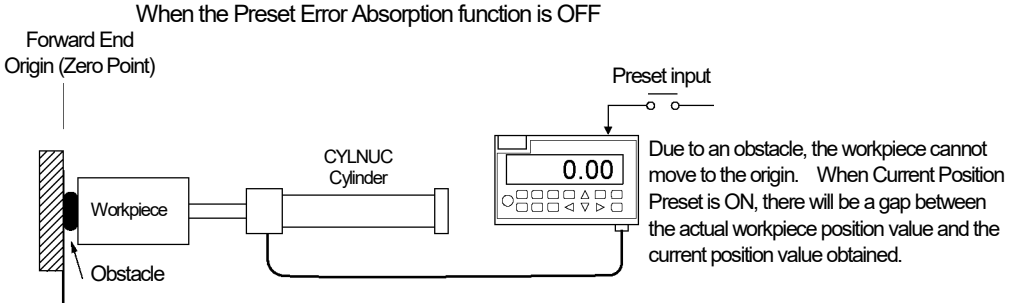
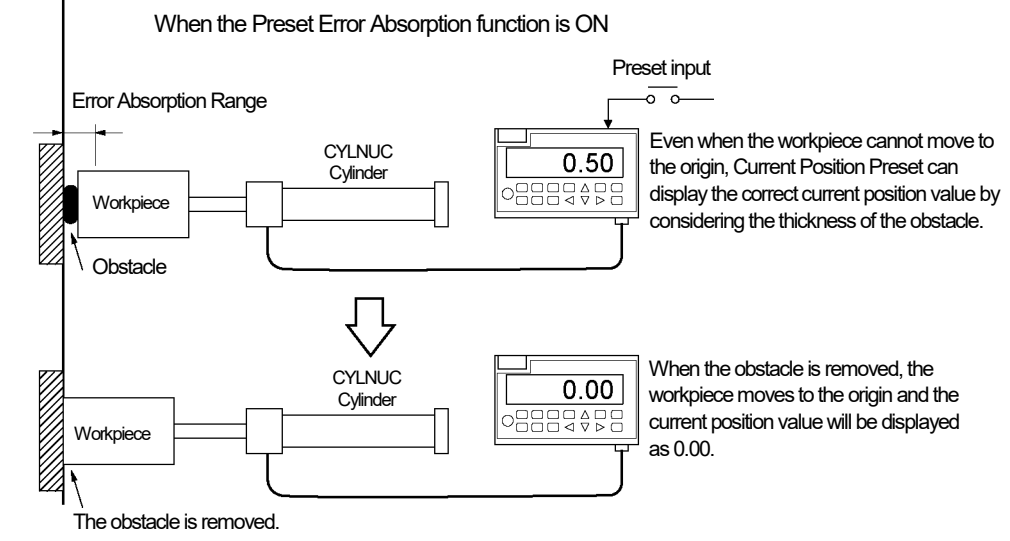
Item	Description
<p>Preset Error Absorption</p>	<p>This function applies only to the Extended Mode (Parameter E0: 1 or 2).</p> <p>The Preset Error Absorption function enables detection of the correct position of the workpiece without a position gap. This can be completed even when the workpiece cannot move to the movable end or the origin, as long as it stays within the range of error absorption.</p> <p>For example: When using the CYLNUC cylinder, an origin (zero position) is set by holding a workpiece at the forward end or the backward end. Even when the workpiece cannot move to the end due to any obstacle, the Current Position Preset enables detection of the correct position by considering the thickness of the obstacle.</p> <div style="text-align: center;"> <p>When the Preset Error Absorption function is OFF</p>  </div> <hr style="border-top: 1px dashed black;"/> <div style="text-align: center;"> <p>When the Preset Error Absorption function is ON</p>  </div> <p>When Parameter 12 is set to 1, the Preset Error Absorption function becomes enabled. Turn on the current position preset input after moving the workpiece into the error absorption range. The current position value will be changed by absorbing the error.</p> <p>For setting details, refer to Chapter 4-20.</p> <div style="border: 1px solid black; padding: 5px; margin-top: 10px;"> <p>NOTES</p> <p>The preset error absorption function cannot use when connecting to the single-turn type ABSOCODER (VRE).</p> </div>

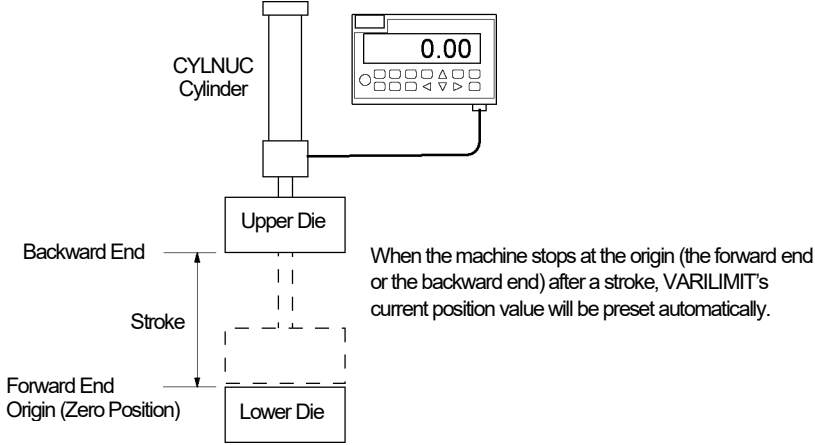
Item	Description
<p>Limitswitchless Preset</p>	<p>This function applies only to the Extended Mode (Parameter E0: 1 or 2).</p> <p>The Limitswitchless Preset function can be used for such processes, where a cylinder is used, for injection molding, die-casting, low-pressure casting and hydraulic press.</p> <p>Even when a limitswitch is not available due to high-temperature or any other adverse circumstances, a stroke of the machine enables the origin setting at the stroke end (forward or backward).</p> <p>For example: During a test run, confirmation of a machine stroke and a setting of the origin can be performed at the same time. Furthermore, the combination use with the Preset Error Absorption function will eliminate the position gap due to trapped obstacles.</p>  <p>When the machine stops at the origin (the forward end or the backward end) after a stroke, VARILIMIT's current position value will be preset automatically.</p> <p>For details of this function, consult our representative.</p> <p>For setting details instead, refer to Chapter 4-21.</p> <div data-bbox="483 1489 1361 1653" style="border: 1px solid black; padding: 5px;"> <p>NOTES</p> <p>The limitswitchless preset function cannot use when connecting to the single-turn type ABSOCODER (VRE).</p> </div>

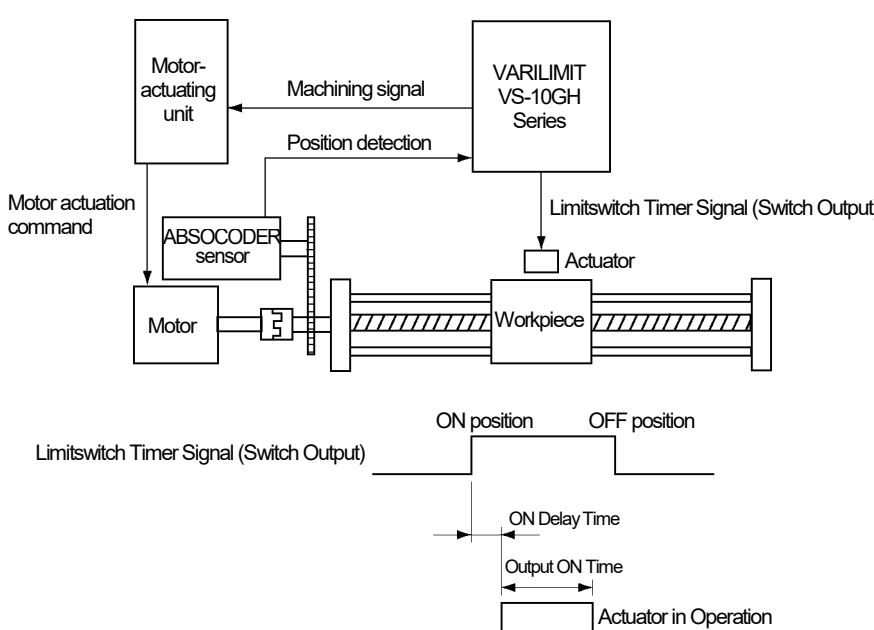
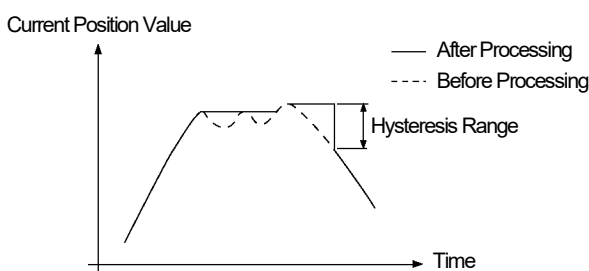
Item	Description
<p>Limitswitch Timer</p>	<p>This function applies only to the Extended Mode (Parameter E0: 1 or 2).</p> <p>The Limitswitch Timer function enables settings of ON/OFF positions, ON delay timer and ON time in the switch output data.</p> <p>When a workpiece comes to the zone between the ON and OFF positions that are set beforehand, an actuator can start for processing for a certain period.</p>  <p>Set this function using Parameter 21 (Number of Switches Valid for Limitswitch Timer Function). The switch outputs from 1 to what is set at Parameter 21 become enabled for the Limitswitch Timer Function.</p> <p>For setting details, refer to Chapter 4-22.</p>
<p>Hysteresis</p>	<p>This function applies only to the Extended Mode (Parameter E0: 1 or 2).</p> <p>When the direction of ABSOCODER's shaft rotation (travel) is reversed, the current position value before the reversal will be valid as long as remaining under the set value. This function is useful when the current position value fluctuates. Repeated switching to/from ON and OFF can be reduced.</p>  <p>For setting details, refer to Chapter 4-17.</p>

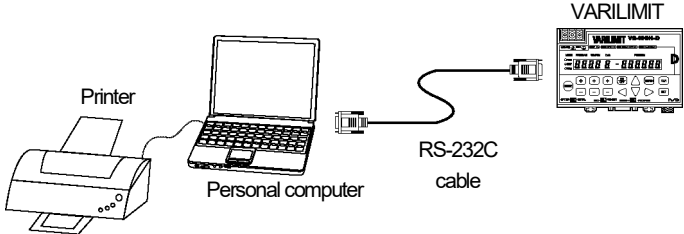
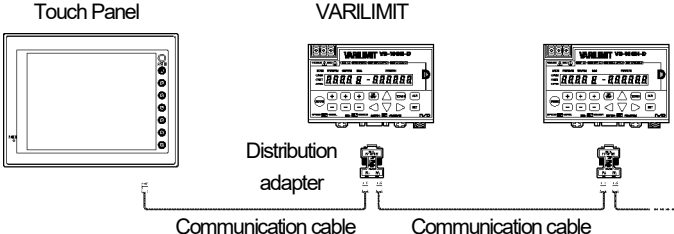
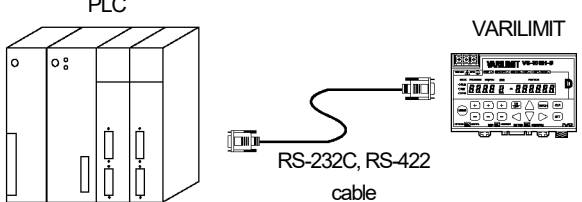
Item	Description
<p style="text-align: center;">Serial Communication</p>	<p>Following connections are available since the serial communication connector is equipped. Contact our sales representative for serial communication details.</p> <p>(1) Setting and editing software (VS-10F/G-EDW2) This software makes a computer enable to read, edit, write, and print of the VARILIMIT setting data.</p>  <p>(2) Connectable with Touch Panel (VARIMONI) VARILIMIT setting data is able to read, edit, write, and print by using the Touch Panel. Touch Panel can control centrally maximum 16 units of VARILIMIT.</p>  <p style="text-align: right;">Connectable max. 16 units by multi-drop connection</p> <p>(3) Connectable with programmable controllers (PLC) which are made by Mitsubishi Electric Co. or OMRON Corporation.</p>  <p>(4) RS-232C communication Connecting with a personal computer or programmable controller (PLC), data is able to read, edit, write, and print by a communication program that is made by the customer.</p>
<p style="text-align: center;">Password</p>	<p>This section applies all the VS-10GH Series models.</p> <p>This is the function to ask inputting the password when the mode of VARILIMIT changes from the operation (RUN) mode. Customers can pick and set the password which consists of 3 digits of numeric values. The mode cannot be changed without the password after setting numbers; therefore, the value of "switch setting" and "parameter setting" can be protected. It can also be protected from changing the program No. from panel side. If the password is not set, the mode could be changed by conventional operation.</p> <p>For setting details, refer to the basic function version of the manual.</p>



OVERVIEW



OVERVIEW

- MEMO -

SPECIFICATION

Describes about specifications and outer dimensions.

2. VARILIMIT SPECIFICATIONS AND DIMENSIONS

2. VARILIMIT SPECIFICATIONS AND DIMENSIONS

2-1. Outer Dimensions

●VS-10GH-D

Units: mm

(VS-10GH-D-1 is same size as VS-10GH-D.)

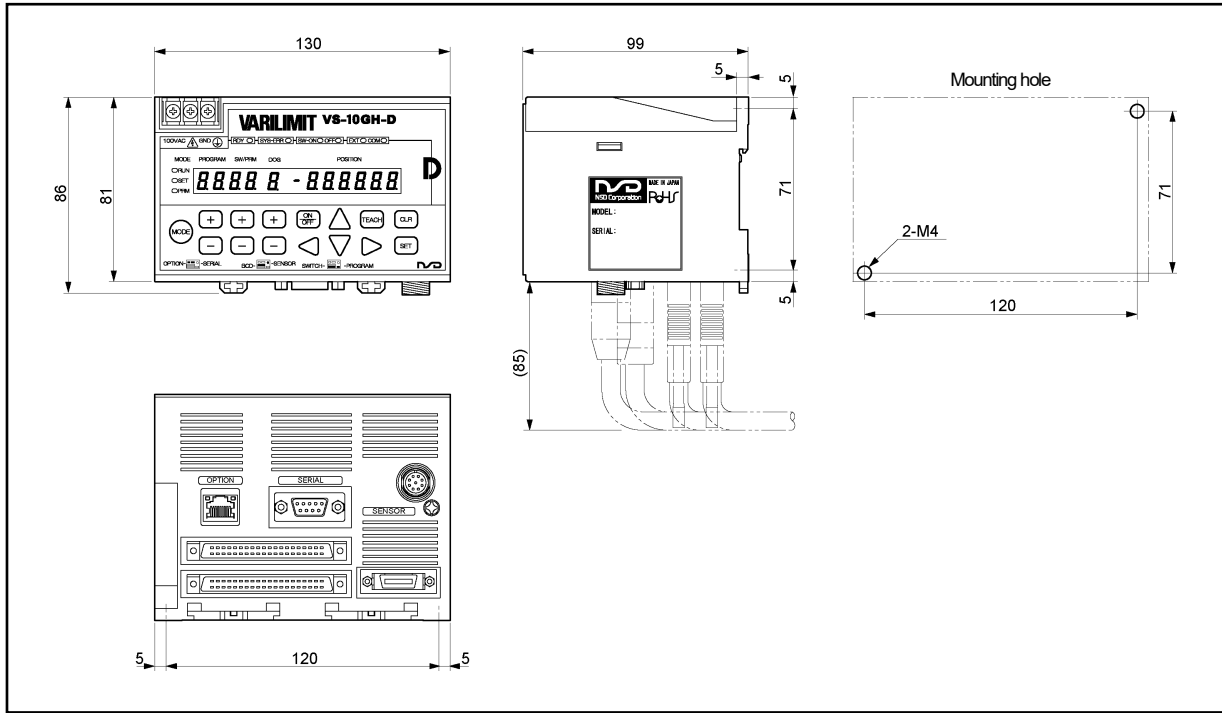

●VS-10GH-A

Units: mm

(VS-10GH-A-1 is same size as VS-10GH-A.)

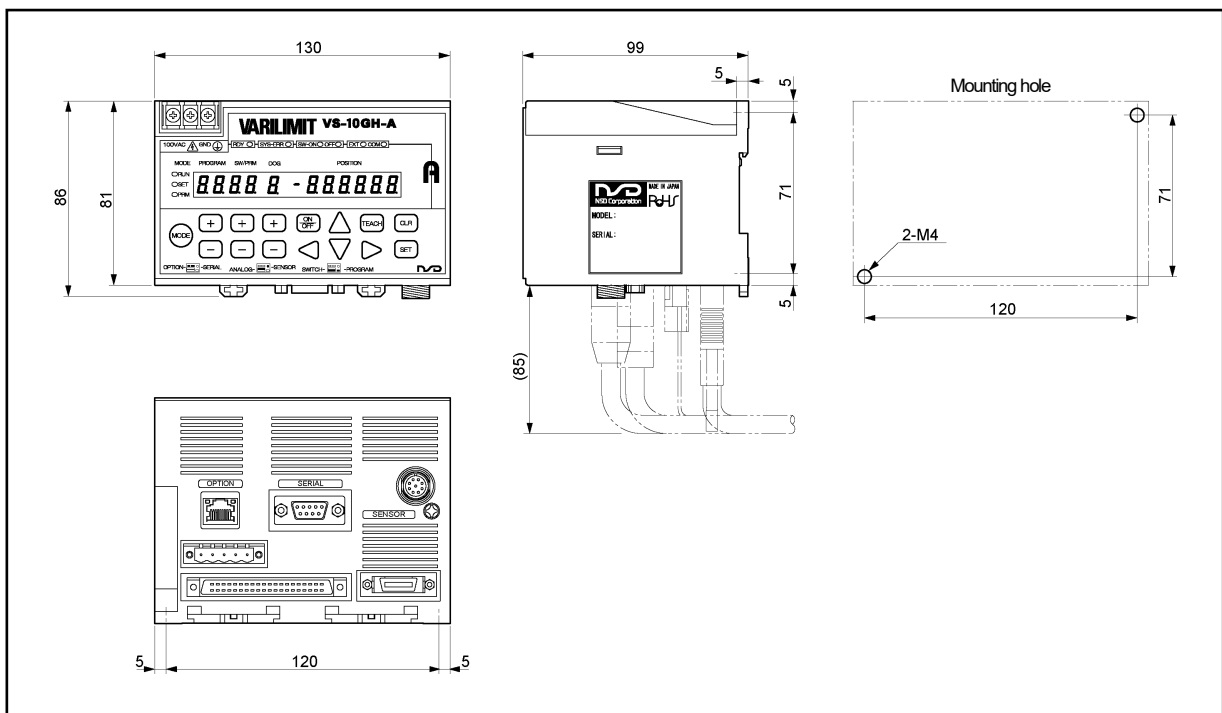

SPECIFICATION

SPECIFICATIONS AND DIMENSIONS

●VS-10GH-C-1

Units: mm

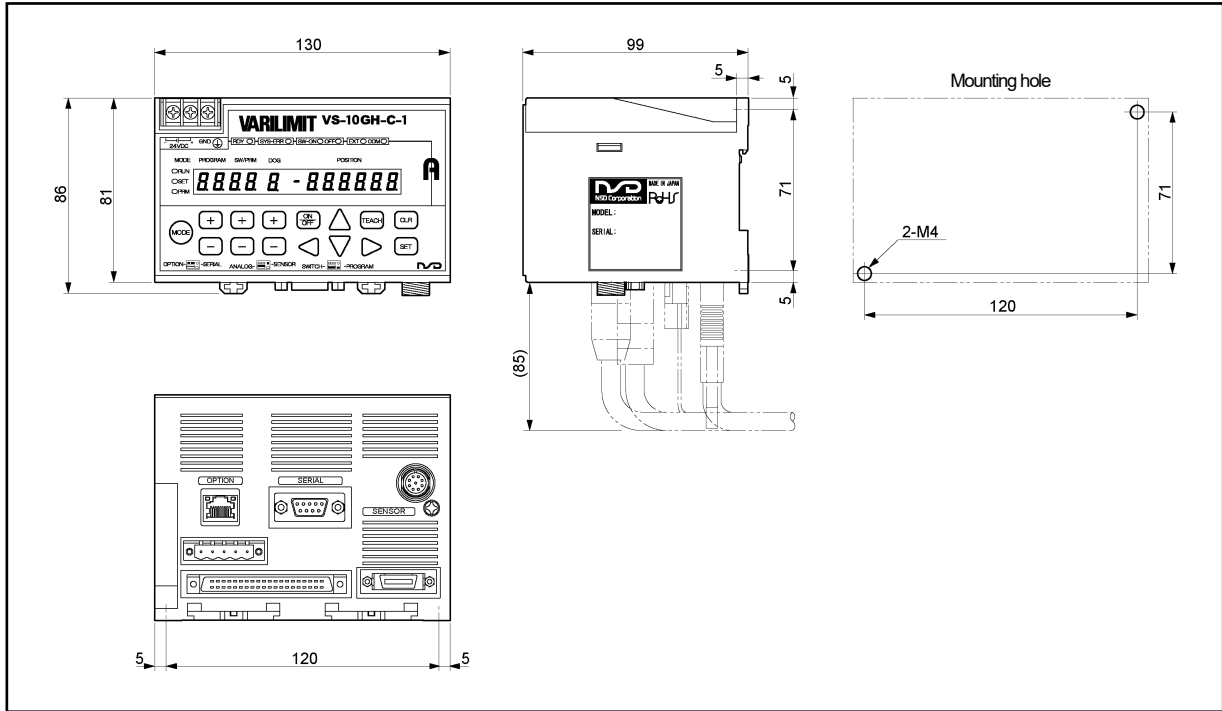

●VS-K-F (Panel-mounting fixture)

Units: mm

VS-K-F can be used with all VS-10GH series.

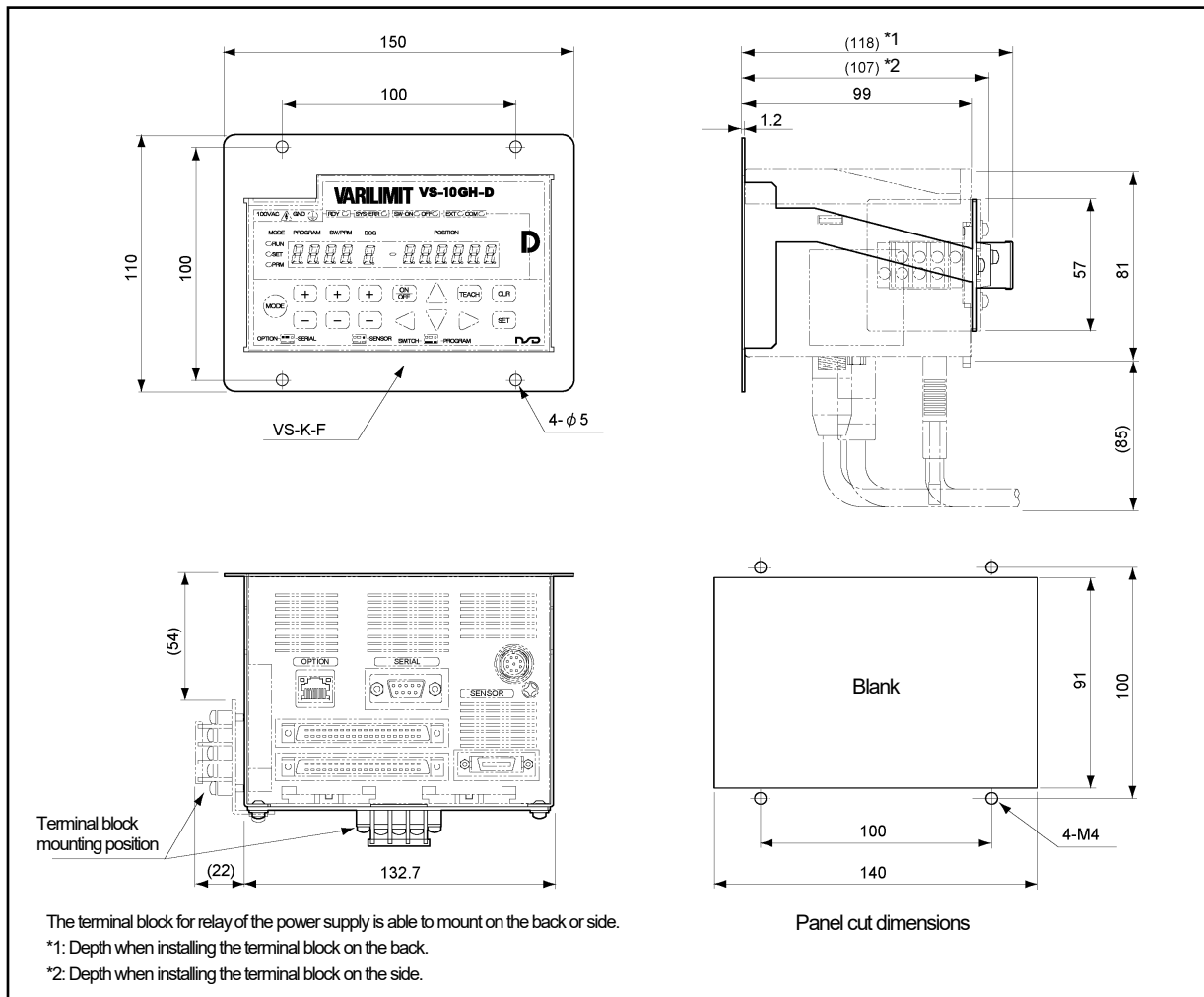

2-2. General Specification

Items	Specifications	
Model	VS-10GH-D, VS-10GH-A	VS-10GH-D-1, VS-10GH-A-1, VS-10GH-C-1
Power supply voltage	100VAC 50/60Hz	24VDC
Permissible power voltage range	85 to 132VAC	21.6 to 30VDC
Power consumption	20VA or less	10W or less
Insulation resistance	20 MΩ or more between external AC power terminals and ground (by 500 VDC insulation resistance tester)	20 MΩ or more between external DC power terminals and ground (by 500 VDC insulation resistance tester)
Withstand voltage	1500 VAC, 60Hz for 1 minute between external AC power terminals and ground	500 VAC, 60Hz for 1 minute between external DC power terminals and ground
Vibration resistance	20m/s ² 10 to 500Hz, 10cycles of 5 minutes in 3 directions, conforms to JIS C 0040 standard	
Surrounding operating air temperature	0 to +55°C (No freezing)	
Surrounding operating humidity	20 to 95 %RH (No condensation)	
Surrounding operating environment	Free from corrosive gases and excessive dust	
Surrounding storage air temperature	-25 to +70°C	
Grounding	Must be securely grounded (ground resistance of 100Ω or less)	
Construction	Inside control panel	
Mounting	<ul style="list-style-type: none"> - Two-point screws mounting - DIN rail mounting - It is possible to mount on the panel when using a panel mounting fixture "VS-K-F". Choose the method either one.	
Outside dimension (mm)	130(W) × 81(H) × 99(D) [Refer to dimensions for details.]	
Mass	Approx. 0.7kg	

2-3. Performance Specification

Items	Specifications		
	VS-10GH-D VS-10GH-D-1	VS-10GH-A VS-10GH-A-1	VS-10GH-C-1
Number of programs	Extended mode: 8 (1-8) or 32 (0-31)		
Number of switches	30		
Number of Multi-dogs	8-program mode: 10 (1-A) (Extended mode) 32-program mode: 4 (1-4) (Extended mode)		
Position detection format	- Absolute position detection MRE-[]SP, VRE-P, VRE-16TS - Semi-absolute position detection CYLNUC, CYLNUC Mark II, IRS-51.2P, VLS-12.8		
Number of detection axes	1		
Output signal updating cycle	Switch output signal: 1ms		
Switch output setting method	Numeric setting with keys, or teaching setting by manual machine operation		
Minimum setting unit	0.00001		
Position data valid digit numbers	6 digits (—999999 to 999999)		
Setting value memory	Non-volatile memories (FRAM), (no battery)		
Display description	- Number display (7 segments LED: 5digits) Program No., Parameter No., switch No., dog No. - Data display (7 segments LED: 6 digits + sign) Setting value, current position value, error code, I/O states, measuring value, measuring value history - Operation state indicator System ready, system error, mode selection, ON/OFF selection when setting the switch, communication state, program selecting method		
Input description from panel side	- Program No. - Switch No. - Dog No. - Parameter data, switch data - Error cancel - TEACH input - Mode selection		
Auxiliary functions	●Functions Related Current Position Preset - Current Position Preset -Preset Error Absorption - Limitswitchless Preset - Multi-Origin		
	●Functions Related Switch Output - Protected Switch - Limitswitch Timer - Output HOLD - Switch Output Enabling		
Auxiliary functions	●Functions Related Measuring - Measuring - Motion Recording - Sensor Filter		
	●Other Functions - Motion Detection - External Error Cancel Input - Hysteresis - Password		
	Current Position Output	Voltage Ouput for Position or Speed	Current Ouput for Position or Speed
Communication functions	- RS-232 communication (The setting value can be saved, loaded, or monitored. Moreover, RUN operation is available.) - Connectable with the Touch Panel (VARIMONI) - Connects with MELSEC or MELSEC-A protocol - Connects with OMRON protocol		
Applicable standard	UL508 CSA C22.2 No.142 (Compliance with c-UL standard) CE Marking (EMC directive) KC mark (Korea Certification Mark)		

 NOTES

Do not control by the speed output.
Use the speed output for monitoring.

2-4. I/O Connector Specifications

This section describes about I/O connectors.

2-4-1. Connector names and functions

●VS-10GH-D, VS-10GH-D-1

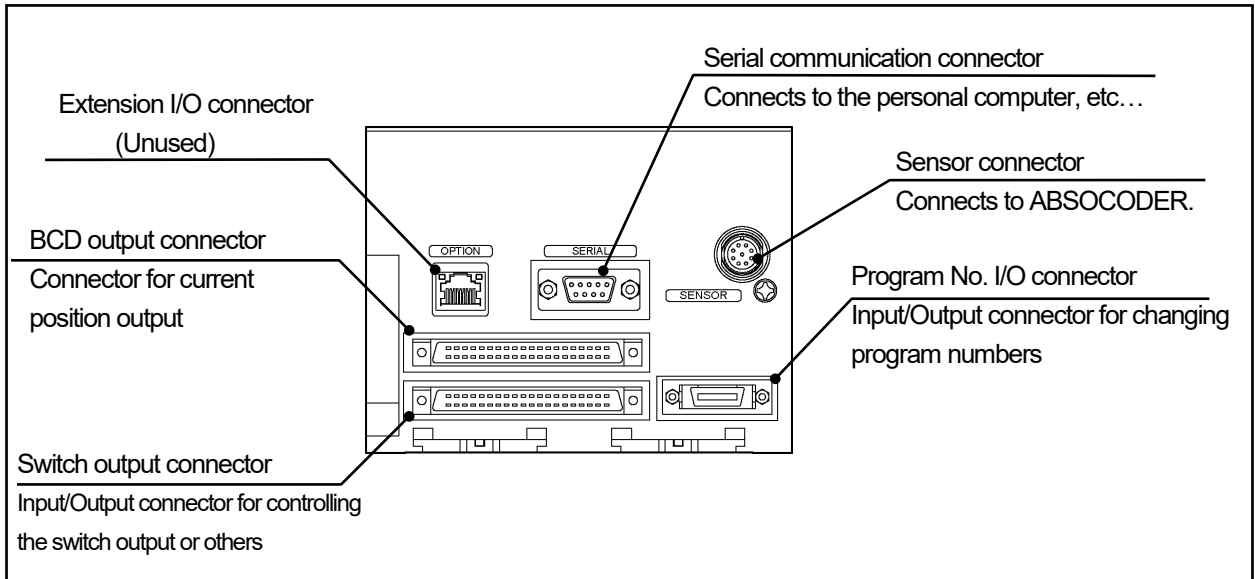

●VS-10GH-A, VS-10GH-A-1
VS-10GH-C-1

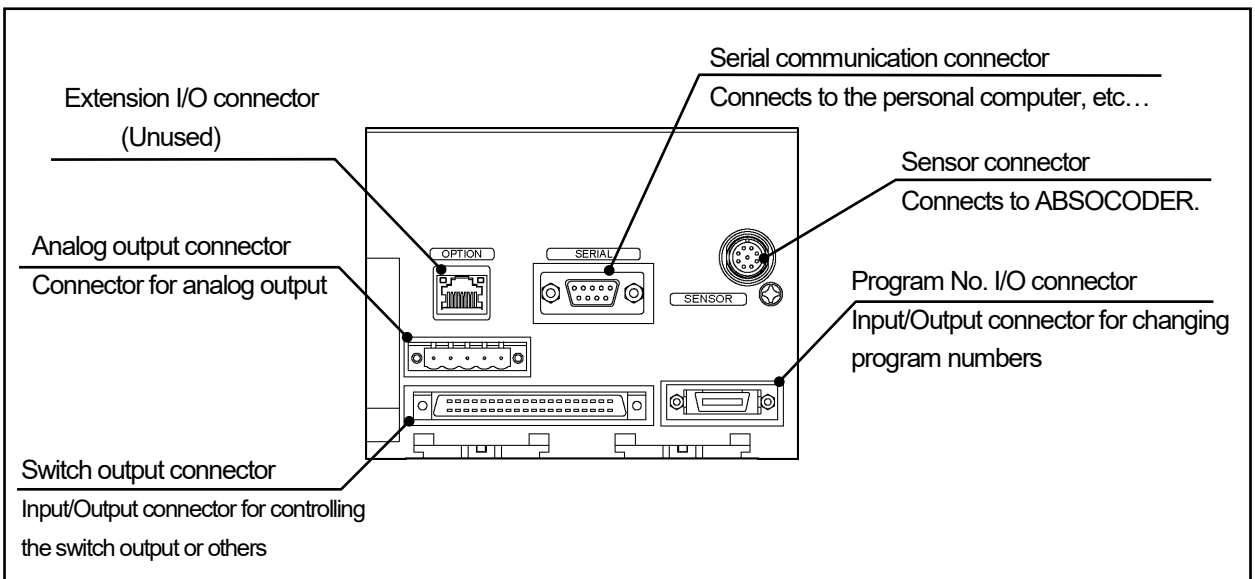

2-4-2. I/O specification

Items		Specifications			
Model		VS-10GH-D VS-10GH-D-1	VS-10GH-A VS-10GH-A-1	VS-10GH-C-1	
Input signals	Switch output connector	Current position preset	Extended Mode: 2 points (auto-detect of preset direction)		
		Error cancel	1 point		
		Switch output enabling	1 point (Enabled by parameter setting)		
		External measuring trigger	1 point (Enabled by parameter setting)		
	Program No. I/O connector	Program No.	8-program mode: 8 points (1-8 bit input) 32-program mode: 5 points (0-31) (switchable by parameter setting)		
	BCD output connector	DTC	1 point	—	—
Output signals	Switch output connector	Switch	Max. 30 points The signals below can be used when changed from switch output. - Motion detection: 1 point - Hold measuring completion: 1 point - Preset error: 1 point		
		System ready	1 point		
	Program No. I/O connector	Program No.	8-program mode: 8 points (1-8 bit input) 32-program mode: 5 points (0-31) (switchable by parameter setting)		
	BCD output connector	Current position value (BCD / binary)	- BCD: 24 points - Binary: 23 points + Binary sign	—	—
		BCD minus sign / Binary sign	1 point	—	—
		Latch pulse	1 point	—	—
		Decimal point	3 points $\left(\begin{array}{c} 10^1 \text{ or } 10^4 \\ 10^2 \text{ or } 10^5 \\ 10^3 \\ *1 \end{array} \right)$	—	—
Analog output connector	Analog output	—	Voltage 2-Channel	Current 2-Channel	

*1: The position of decimal points can be set at Parameter 90 (Decimal Point Position).
The decimal point signals of the fifth and the second digits are in common use.
The decimal point signals of the sixth and the third digits are in common use.

● Switch output connector

Input specification			Output specification	
Items	Specifications		Items	Specifications
Isolation format	Photo-coupler isolation		Isolation format	Photo-coupler isolation
Rated input voltage	12VDC	24VDC	Rated load voltage	12/24VDC
Rated input current	4mA	10mA	Load voltage range	10.2 to 30VDC
Input voltage range	10.2 to 30VDC		Max. load current	100mA
ON voltage	10VDC or more		Current leakage when OFF	0.1mA or less
OFF voltage	4VDC or less		Max. voltage drop when ON	2.0V (at 100mA)
Response time	OFF→ON	0.04ms (input voltage 24V)	Response time	OFF→ON 1ms (at 100mA, resistance load)
	ON→OFF	0.2ms (input voltage 24V)		ON→OFF 1ms (at 100mA, resistance load)
Cable connection format	40 pins connector (FCN-361J040-AU / FCN-360C040-E, manufacturer: FUJITSU COMPONENT LIMITED or N361J040AU / N360C040E, manufacturer: OTAX CO.,LTD.)			
Compatible wire size	0.3 mm ²			

Circuit

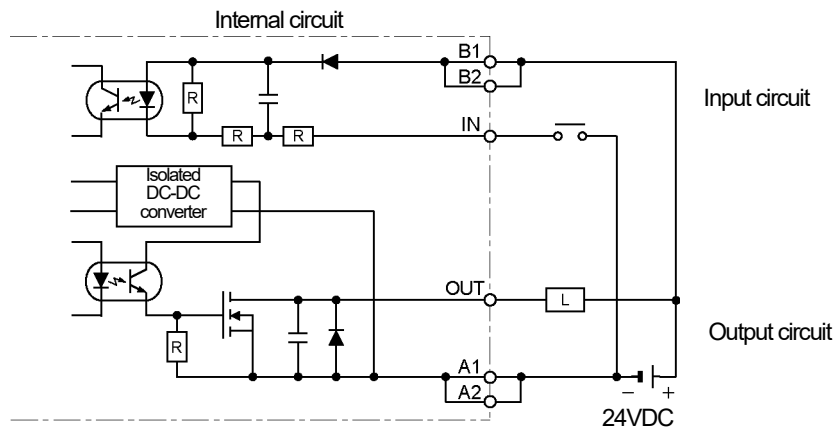

* Note that the total load current should not exceed 1A when using the I/O cable VS-C05-[L].

● Program No. I/O connector

Input specification			Output specification	
Items	Specifications		Items	Specifications
Isolation format	Photo-coupler isolation		Isolation format	Photo-coupler isolation
Rated input voltage	12VDC	24VDC	Rated load voltage	12/24VDC
Rated input current	4mA	10mA	Load voltage range	10.2 to 30VDC
Input voltage range	10.2 to 30VDC		Max. load current	100mA
ON voltage	10VDC or more		Current leakage when OFF	0.1mA or less
OFF voltage	4VDC or less		Max. voltage drop when ON	2.0V (at 100mA)
Response time	OFF→ON	0.04ms (input voltage 24V)	Response time	OFF→ON 1ms (at 100mA, resistance load)
	ON→OFF	0.2ms (input voltage 24V)		ON→OFF 1ms (at 100mA, resistance load)
Cable connection format	20 pins connector (PCR-S20FS+/PCR-LS20LA1, manufacturer: HONDA TSUSHIN KOGYO CO., LTD)			
Compatible wire size	0.5 mm ²			

Circuit

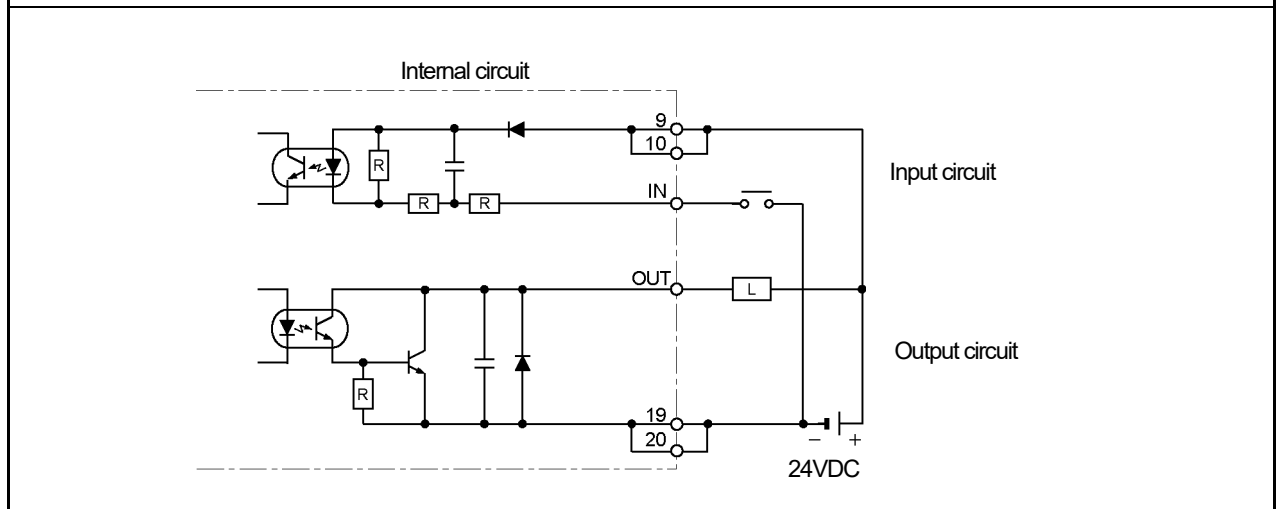

● BCD output connector

Input specification			Output specification		
Items	Specifications		Items	Specifications	
Isolation format	Photo-coupler isolation		Isolation format	Photo-coupler isolation	
Rated input voltage	12VDC	24VDC	Rated load voltage	12/24VDC	
Rated input current	4mA	10mA	Load voltage range	10.2 to 30VDC	
Input voltage range	10.2 to 30VDC		Current leakage when OFF	0.1mA or less	
ON voltage	10VDC or more		- Current position value - Minus sign - Decimal point	Max. load current	20mA
OFF voltage	4VDC or less			Max. voltage drop when ON	1.5V (at 20mA)
			Latch pulse	Max. load current	100mA
				Max. voltage drop when ON	1.5V (at 100mA)
Response time	OFF→ON	0.04ms (input voltage 24V)	Response time	OFF→ON	1ms (at 100mA, resistance load)
	ON→OFF	0.2ms (input voltage 24V)		ON→OFF	1ms (at 100mA, resistance load)
Cable connection format	40 pins connector (FCN-361J040-AU / FCN-360C040-E, manufacturer: FUJITSU COMPONENT LIMITED or N361J040AU / N360C040E, manufacturer: OTAX CO.,LTD.)				
Compatible wire size	0.3 mm ²				

Circuit

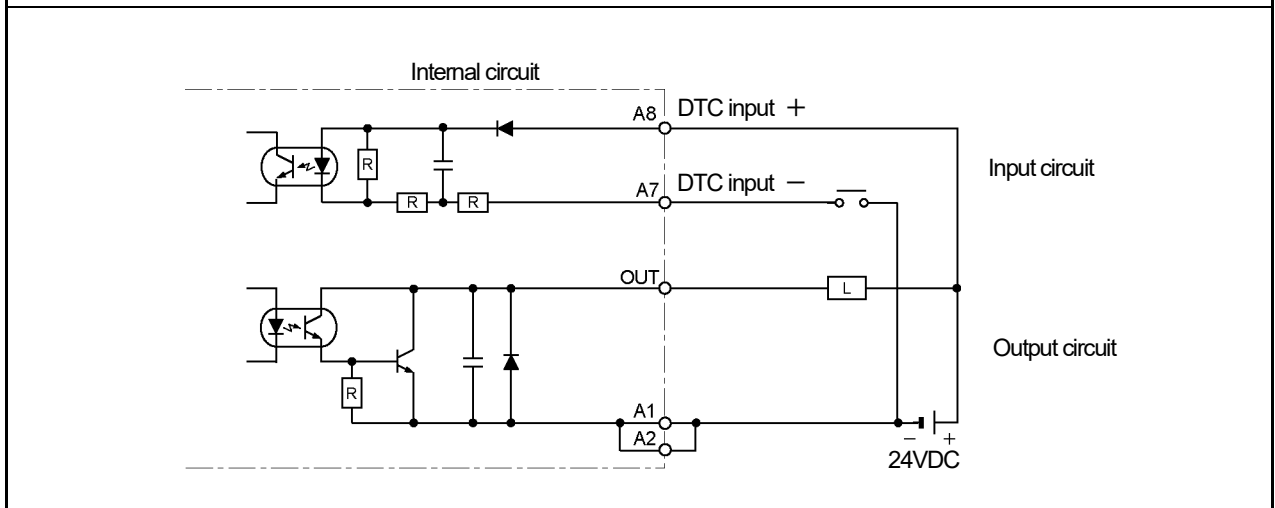

* Note that the total load current should not exceed 1A when using the I/O cable VS-C05-[L].

● Analog output connector Position/Speed Voltage Output

Output specification	
Items	Specifications
Output voltage range	-10V to +10VDC
Setting range	Extended Mode Position/Speed and voltage can be set as required at the Parameter.
External load resistance	1kΩ to 1MΩ
Output voltage resolution	0.3051 mV (-10V to +10V / 65536 divisions)
Output voltage accuracy	100 mV (0 to 55°C)
Analog response time	Max. 100 μs (Switching between 10V and 0V)
Updating cycle	1ms
Isolation format	Insulated between control and output circuits
Cable connection format	Connector model: HR31-5.08P-5SC(72) Crimp contact: HR31-SC-121(71) Manufacturer: HIROSE ELECTRIC CO., LTD
Compatible wire size	0.25 to 1.65 mm ²
External power supply	Not required

Circuit

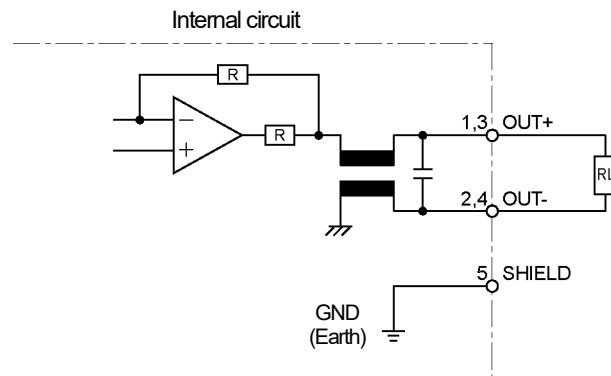

● Analog output connector Position/Speed Current Output

Output specification	
Items	Specifications
Output current range	4mA to 20mADC
Setting range	Extended Mode Position/Speed data for 4mADC and Position/Speed data for 20mADC can be set as required at the Parameter.
External load resistance	510Ω or less
Output current resolution	0.24 μA (4mA to 20mA / 65536 divisions)
Output current accuracy	200 μA (0 to 55°C)
Analog response time	Max. 100μs (Switching between 20mA and 4mA)
Updating cycle	1ms
Isolation format	Insulated between control and output circuits
Cable connection format	Connector model: HR31-5.08P-5SC(72) Crimp contact: HR31-SC-121(71) Manufacturer: HIROSE ELECTRIC CO., LTD
Compatible wire size	0.25 to 1.65 mm ²
External power supply	Not required

Circuit

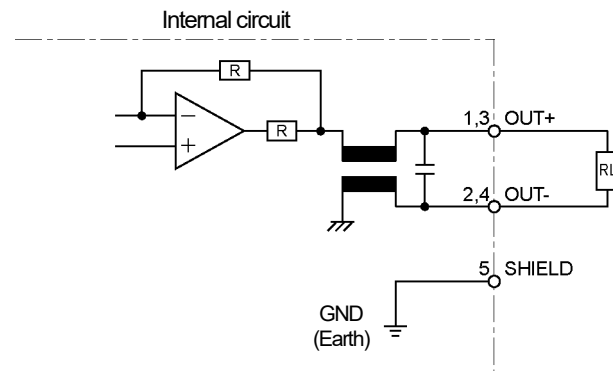

2-4-3. Signal names and descriptions

	Name	Description	Applicable model		
			VS-10GH-D	VS-10GH-A	VS-10GH-C
Output	Switch	Outputs ON/OFF signal outputs according to the switch output setting values.	○	○	○
	System ready	If VARILIMIT and ABSOCODER operate normally during selecting RUN mode, the system ready signal is output. Use this signal as the interlock signal.	○	○	○
	Program No.	The currently selected program No. is output.	○	○	○
	Current position value (BCD / Binary)	Outputs current position or measuring values in BCD or binary code.	○		
	Decimal point	Outputs decimal points when current position or measuring values are output in BCD code.	○		
	BCD minus sign / Binary sign	Outputs when negative current position or measuring values are output in BCD code or binary code of the sign magnitude.	○		
	Binary sign	Outputs when negative current position or measuring values are output in the binary code of two's complement.	○		
	Latch pulse	This is updating timing signal of the current position outputs.	○		
	Motion detection	Outputs when the detected travel direction and speed match the predetermined values.	○	○	○
	HOLD measuring completed	Turns on when the HOLD measuring is completed and its current position value is held.	○	○	○
	Preset error	Extended Mode (Parameter E0: 1 or 2) When using the Current Position Preset by Auto-detecting Travel Direction function - Outputs when tuning on the current position preset input by setting a preset value outside the detection range at the parameter. - Outputs when tuning on the current position preset input beyond the Permissible Correction Amount set at the parameter. When using the Limitswitchless Preset function - Outputs when the current position preset is turned off during a stroke after turning ON the input signal.	○	○	○
Analog output	A voltage output model outputs voltage according to the machine position or speed. A current output model outputs current according to the machine position or speed.		○	○	
Input	Program No.	Inputs Program Numbers. When using in the 8-program mode: Inputs each of 8 points signals individually. When using in the 32-program mode: Inputs 5 points data in binary code.	○	○	○
	Current position preset	This is a signal to externally change Current Position Value to the preset value.	○	○	○
	External measuring trigger	When this signal is input from the host controller, the Current Position Value will be held so that it can be read as a measuring value.	○	○	○
	Switch output enabling	Turning on of this input enables Switch Output.	○	○	○
	DTC	Be used to read the Current Position Output into the host controller. While this signal is on, updating of the Current Position Output will be suspended.	○		
	Error cancel	Cancels an error when this input is turned ON.	○	○	○

2-4-4. I/O signal condition in the each mode

Indicates connector's I/O signal condition in each mode.

Signal name \ Mode		RUN mode (RUN)	Switch setting mode (SET)	Parameter setting mode (PRM)
Output	Switch	Valid	●Extended Mode Depending on the parameter 78 setting, determines whether output is OFF or HOLD. For more details, refer to "4-13".	●Extended Mode Depending on the parameter 78 setting, determines whether output is OFF or HOLD. For more details, refer to "4-13".
	System ready	Valid (output ON)	Valid (output OFF)	Valid (output OFF)
	Program No.	Valid	Invalid The Program Number that has been last selected in the RUN mode will be output.	Invalid The Program Number that has been last selected in the RUN mode will be output.
	Current position value (BCD / binary)	Valid	Valid (It is same as RUN mode.)	Valid (It is same as RUN mode.)
	Decimal point	Valid	Valid (It is same as RUN mode.)	Valid (It is same as RUN mode.)
	BCD minus sign / Binary sign	Valid	Valid (It is same as RUN mode.)	Valid (It is same as RUN mode.)
	Binary sign	Valid	Valid (It is same as RUN mode.)	Valid (It is same as RUN mode.)
	Latch pulse	Valid	Valid (It is same as RUN mode.)	Valid (It is same as RUN mode.)
	Motion detection	Valid	Valid (It is same as RUN mode.)	Valid (It is same as RUN mode.)
	HOLD measuring completed	Valid	Valid (It is same as RUN mode.)	Valid (It is same as RUN mode.)
	Preset error	Valid	Valid (It is same as RUN mode.)	Valid (It is same as RUN mode.)
	Analog output	Valid	Valid (It is same as RUN mode.)	Valid (It is same as RUN mode.)
	Input	Program No.	Valid	Invalid
Current position preset		Valid	Valid	Valid
External measuring trigger		Valid	Valid	Valid
Switch output enabling		Valid	Valid	Valid
DTC		Valid	Valid	Valid
Error cancel		Valid	Valid	Valid

2-4-5. I/O Connector Pin Arrangement

Pin arrangement of input/output connectors is described in this section.

(1) VS-10GH-D, VS-10GH-D-1

① Switch output connector

[Connector model: FCN-361J040-AU / FCN-360C040-E (FUJITSU COMPONENT LIMITED)
or N361J040AU / N360C040E (OTAX CO.,LTD.)]

Pin No.	Signal name	Pin No.	Signal name
B20	Switch output 1	A20	Switch output 17
B19	Switch output 2	A19	Switch output 18
B18	Switch output 3	A18	Switch output 19
B17	Switch output 4	A17	Switch output 20
B16	Switch output 5	A16	Switch output 21
B15	Switch output 6	A15	Switch output 22
B14	Switch output 7	A14	Switch output 23
B13	Switch output 8	A13	Switch output 24
B12	Switch output 9	A12	Switch output 25
B11	Switch output 10	A11	Switch output 26
B10	Switch output 11	A10	Switch output 27
B9	Switch output 12	A9*1	Switch output 28
B8	Switch output 13	A8*2	Switch output 29
B7	Switch output 14	A7*3	Switch output 30
B6	Switch output 15	A6	System ready output
B5	Switch output 16	A5	External measuring trigger input
B4	Error cancel input	A4	Current position preset input 1
B3	Switch output enabling input	A3	Current position preset input 2
B2	+24V input common	A2	0V output common
B1		A1	

Shows the pin arrangement as viewed from the soldering terminals side.

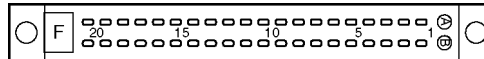

Remarks

Contents to output

- *1: Can be changed by the setting at Parameter 62
- *2: Can be changed by the setting at Parameter 77
- *3: Can be changed by the setting at Parameter 82

● Circuit

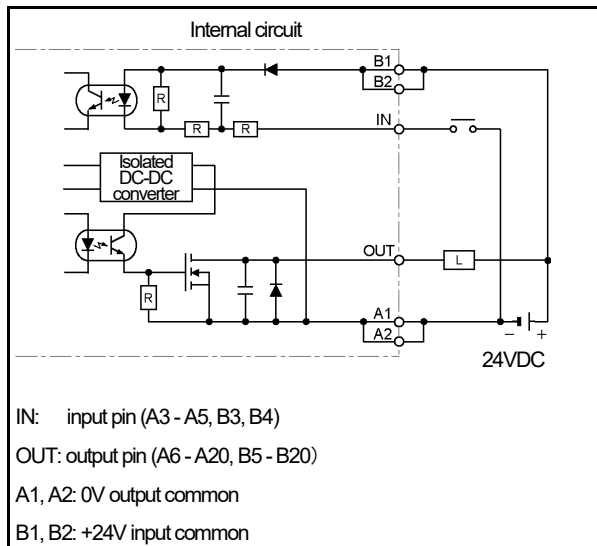

● External cable (VS-C05)

Indicates external cable wire colors and markings.

Pin No.	Wire colors & markings	Pin No.	Wire colors & markings
B20	Pink (Black ■■■■■)	A20	Pink (Red ■■■■■)
B19	Yellow (Black ■■■■■)	A19	Yellow (Red ■■■■■)
B18	White (Black ■■■■■)	A18	White (Red ■■■■■)
B17	Gray (Black ■■■■■)	A17	Gray (Red ■■■■■)
B16	Orange (Black ■■■■■)	A16	Orange (Red ■■■■■)
B15	Pink (Black ■■■■)	A15	Pink (Red ■■■■)
B14	Yellow (Black ■■■■)	A14	Yellow (Red ■■■■)
B13	White (Black ■■■■)	A13	White (Red ■■■■)
B12	Gray (Black ■■■■)	A12	Gray (Red ■■■■)
B11	Orange (Black ■■■■)	A11	Orange (Red ■■■■)
B10	Pink (Black ■■■)	A10	Pink (Red ■■■)
B9	Yellow (Black ■■■)	A9	Yellow (Red ■■■)
B8	White (Black ■■■)	A8	White (Red ■■■)
B7	Gray (Black ■■■)	A7	Gray (Red ■■■)
B6	Orange (Black ■■■)	A6	Orange (Red ■■■)
B5	Pink (Black ■■)	A5	Pink (Red ■■)
B4	Yellow (Black ■■)	A4	Yellow (Red ■■)
B3	White (Black ■■)	A3	White (Red ■■)
B2	Gray (Black ■■)	A2	Gray (Red ■■)
B1	Orange (Black ■■)	A1	Orange (Red ■■)

② Program No. I/O connector

[Connector model: PCR-S20FS+ / PCR-LS20LA1 (HONDA TSUSHIN KOGYO CO., LTD)]

Pin No.	Signal name	Pin No.	Signal name
1 *1	Program No. input 1 (2 ⁰)	11 *1	Program No. output 1 (2 ⁰)
2 *1	Program No. input 2 (2 ¹)	12 *1	Program No. output 2 (2 ¹)
3 *1	Program No. input 3 (2 ²)	13 *1	Program No. output 3 (2 ²)
4 *1	Program No. input 4 (2 ³)	14 *1	Program No. output 4 (2 ³)
5 *1	Program No. input 5 (2 ⁴)	15 *1	Program No. output 5 (2 ⁴)
6	Program No. input 6	16	Program No. output 6
7	Program No. input 7	17	Program No. output 7
8	Program No. input 8	18	Program No. output 8
9	+24V input common	19	0V output common
10		20	

Shows the pin arrangement as viewed from the soldering terminals side.

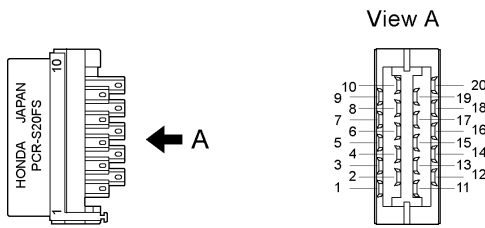

Remarks

*1: The signal name differs depending on the Parameter E0 setting.

When E0=1 (8-program mode), each of program numbers are individually input at 8 points.

When E0=2 (32-program mode), program numbers are input in binary code at 5 points.

● Circuit

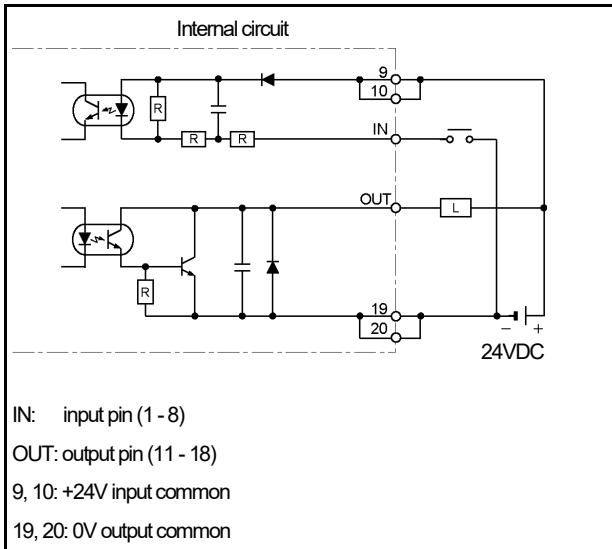

● External cable (VS-C10G)

Indicates external cable wire colors and markings.

Pin No.	Wire colors & markings
20	Pink (Black ■■)
19	Pink (Red ■■)
18	Yellow (Black ■■)
17	Yellow (Red ■■)
16	White (Black ■■)
15	White (Red ■■)
14	Gray (Black ■■)
13	Gray (Red ■■)
12	Orange (Black ■■)
11	Orange (Red ■■)
10	Pink (Black ■)
9	Pink (Red ■)
8	Yellow (Black ■)
7	Yellow (Red ■)
6	White (Black ■)
5	White (Red ■)
4	Gray (Black ■)
3	Gray (Red ■)
2	Orange (Black ■)
1	Orange (Red ■)

③ BCD output connector

[Connector model: FCN-361J040-AU / FCN-360C040-E (FUJITSU COMPONENT LIMITED)
or N361J040AU / N360C040E (OTAX CO.,LTD.)]

Pin No.	Signal name		Pin No.	Signal name	
B20*1	BCD output 1×10^0	Binary output 2^0	A20*1	BCD output 4×10^4	Binary output 2^{18}
B19*1	BCD output 2×10^0	Binary output 2^1	A19*1	BCD output 8×10^4	Binary output 2^{19}
B18*1	BCD output 4×10^0	Binary output 2^2	A18*1	BCD output 1×10^5	Binary output 2^{20}
B17*1	BCD output 8×10^0	Binary output 2^3	A17*1	BCD output 2×10^5	Binary output 2^{21}
B16*1	BCD output 1×10^1	Binary output 2^4	A16*1	BCD output 4×10^5	Binary output 2^{22}
B15*1	BCD output 2×10^1	Binary output 2^5	A15*1	BCD output 8×10^5	Binary sign output *3
B14*1	BCD output 4×10^1	Binary output 2^6	A14*2	Decimal point 10^1	Decimal point 10^4
B13*1	BCD output 8×10^1	Binary output 2^7	A13*2	Decimal point 10^2	Decimal point 10^5
B12*1	BCD output 1×10^2	Binary output 2^8	A12	Decimal point 10^3	
B11*1	BCD output 2×10^2	Binary output 2^9	A11	BCD minus sign output	Binary sign output *3
B10*1	BCD output 4×10^2	Binary output 2^{10}	A10	Latch pulse output	
B9*1	BCD output 8×10^2	Binary output 2^{11}	A9		
B8*1	BCD output 1×10^3	Binary output 2^{12}	A8	DTC input +	
B7*1	BCD output 2×10^3	Binary output 2^{13}	A7	DTC input -	
B6*1	BCD output 4×10^3	Binary output 2^{14}	A6		
B5*1	BCD output 8×10^3	Binary output 2^{15}	A5		
B4*1	BCD output 1×10^4	Binary output 2^{16}	A4		
B3*1	BCD output 2×10^4	Binary output 2^{17}	A3		
B2	Not used		A2	0V output common	
B1	(Do not connect anything.)		A1		

Shows the pin arrangement as viewed from the soldering terminals side.

Remarks

- *1: Contents to output
 - Can be either in BCD code or in binary code depending on the selection at Parameter 94.
 - Can be either current position values or measuring values depending on the selection at Parameter 68.
- *2: Contents to output
 - The position of decimal points can be changed by the setting of Parameter 90.

NOTES *3: Binary sign output method

- A11 pin is the sign output when selecting the binary output of the sign magnitude code (the setting value is 4 or 5) at Parameter 94.
- A15 pin is the sign output when selecting the binary output of the two's complement (the setting value is 6 or 7) at Parameter 94.

● Circuit

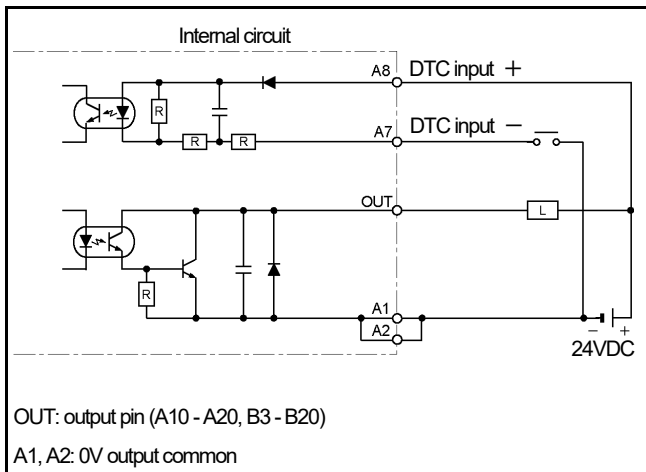

● External cable (VS-C05)

Indicates external cable wire colors and markings.

Pin No.	Wire colors & markings	Pin No.	Wire colors & markings
B20	Pink (Black■■■■■)	A20	Pink (Red■■■■■)
B19	Yellow (Black■■■■■)	A19	Yellow (Red■■■■■)
B18	White (Black■■■■■)	A18	White (Red■■■■■)
B17	Gray (Black■■■■■)	A17	Gray (Red■■■■■)
B16	Orange (Black■■■■■)	A16	Orange (Red■■■■■)
B15	Pink (Black■■■■■)	A15	Pink (Red■■■■■)
B14	Yellow (Black■■■■■)	A14	Yellow (Red■■■■■)
B13	White (Black■■■■■)	A13	White (Red■■■■■)
B12	Gray (Black■■■■■)	A12	Gray (Red■■■■■)
B11	Orange (Black■■■■■)	A11	Orange (Red■■■■■)
B10	Pink (Black■■■■■)	A10	Pink (Red■■■■■)
B9	Yellow (Black■■■■■)	A9	Yellow (Red■■■■■)
B8	White (Black■■■■■)	A8	White (Red■■■■■)
B7	Gray (Black■■■■■)	A7	Gray (Red■■■■■)
B6	Orange (Black■■■■■)	A6	Orange (Red■■■■■)
B5	Pink (Black■■■■■)	A5	Pink (Red■■■■■)
B4	Yellow (Black■■■■■)	A4	Yellow (Red■■■■■)
B3	White (Black■■■■■)	A3	White (Red■■■■■)
B2	Gray (Black■■■■■)	A2	Gray (Red■■■■■)
B1	Orange (Black■■■■■)	A1	Orange (Red■■■■■)

(2) VS-10GH-A, VS-10GH-A-1, VS-10GH-C-1

① Switch output connector

[Connector model: FCN-361J040-AU / FCN-360C040-E (FUJITSU COMPONENT LIMITED)
or N361J040AU / N360C040E (OTAX CO.,LTD.)]

Pin No.	Signal name	Pin No.	Signal name
B20	Switch output 1	A20	Switch output 17
B19	Switch output 2	A19	Switch output 18
B18	Switch output 3	A18	Switch output 19
B17	Switch output 4	A17	Switch output 20
B16	Switch output 5	A16	Switch output 21
B15	Switch output 6	A15	Switch output 22
B14	Switch output 7	A14	Switch output 23
B13	Switch output 8	A13	Switch output 24
B12	Switch output 9	A12	Switch output 25
B11	Switch output 10	A11	Switch output 26
B10	Switch output 11	A10	Switch output 27
B9	Switch output 12	A9*1	Switch output 28
B8	Switch output 13	A8*2	Switch output 29
B7	Switch output 14	A7*3	Switch output 30
B6	Switch output 15	A6	System ready output
B5	Switch output 16	A5	External measuring trigger input
B4	Error cancel input	A4	Current position preset input 1
B3	Switch output enabling input	A3	Current position preset input 2
B2	+24V input common	A2	0V output common
B1		A1	

Shows the pin arrangement as viewed from the soldering terminals side.

Remarks

Contents to output

- *1: Can be changed by the setting at Parameter 62
- *2: Can be changed by the setting at Parameter 77
- *3: Can be changed by the setting at Parameter 82

● Circuit

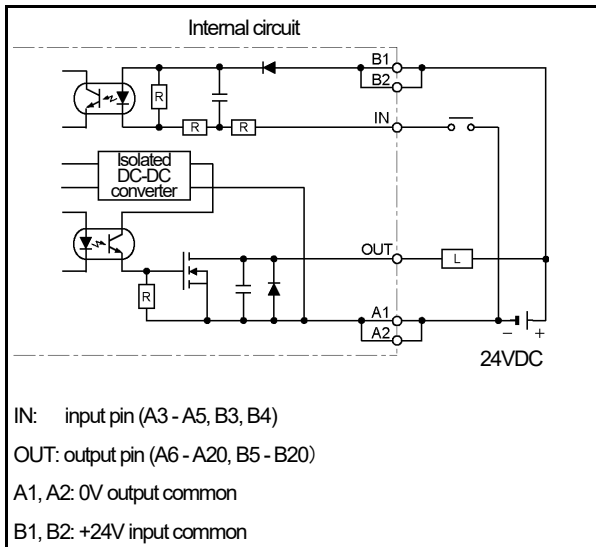

● External cable (VS-C05)

Indicates external cable wire colors and markings.

Pin No.	Wire colors & markings	Pin No.	Wire colors & markings
B20	Pink (Black ■■■■■)	A20	Pink (Red ■■■■■)
B19	Yellow (Black ■■■■■)	A19	Yellow (Red ■■■■■)
B18	White (Black ■■■■■)	A18	White (Red ■■■■■)
B17	Gray (Black ■■■■■)	A17	Gray (Red ■■■■■)
B16	Orange (Black ■■■■■)	A16	Orange (Red ■■■■■)
B15	Pink (Black ■■■■)	A15	Pink (Red ■■■■)
B14	Yellow (Black ■■■■)	A14	Yellow (Red ■■■■)
B13	White (Black ■■■■)	A13	White (Red ■■■■)
B12	Gray (Black ■■■■)	A12	Gray (Red ■■■■)
B11	Orange (Black ■■■■)	A11	Orange (Red ■■■■)
B10	Pink (Black ■■■■)	A10	Pink (Red ■■■■)
B9	Yellow (Black ■■■■)	A9	Yellow (Red ■■■■)
B8	White (Black ■■■■)	A8	White (Red ■■■■)
B7	Gray (Black ■■■■)	A7	Gray (Red ■■■■)
B6	Orange (Black ■■■■)	A6	Orange (Red ■■■■)
B5	Pink (Black ■■■■)	A5	Pink (Red ■■■■)
B4	Yellow (Black ■■■■)	A4	Yellow (Red ■■■■)
B3	White (Black ■■■■)	A3	White (Red ■■■■)
B2	Gray (Black ■■■■)	A2	Gray (Red ■■■■)
B1	Orange (Black ■■■■)	A1	Orange (Red ■■■■)

② Program No. I/O connector

[Connector model: PCR-S20FS+ / PCR-LS20LA1 (HONDA TSUSHIN KOGYO CO., LTD)]

Pin No.	Signal name	Pin No.	Signal name
1 *1	Program No. input 1 (2 ⁰)	11 *1	Program No. output 1 (2 ⁰)
2 *1	Program No. input 2 (2 ¹)	12 *1	Program No. output 2 (2 ¹)
3 *1	Program No. input 3 (2 ²)	13 *1	Program No. output 3 (2 ²)
4 *1	Program No. input 4 (2 ³)	14 *1	Program No. output 4 (2 ³)
5 *1	Program No. input 5 (2 ⁴)	15 *1	Program No. output 5 (2 ⁴)
6	Program No. input 6	16	Program No. output 6
7	Program No. input 7	17	Program No. output 7
8	Program No. input 8	18	Program No. output 8
9	+24V input common	19	0V output common
10		20	

Shows the pin arrangement as viewed from the soldering terminals side.

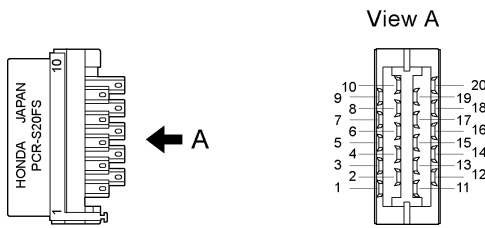

Remarks

*1: The signal name differs depending on the Parameter E0 setting.

When E0=1 (8-program mode), each of program numbers are individually input at 8 points.

When E0=2 (32-program mode), program numbers are input in binary code at 5 points.

● Circuit

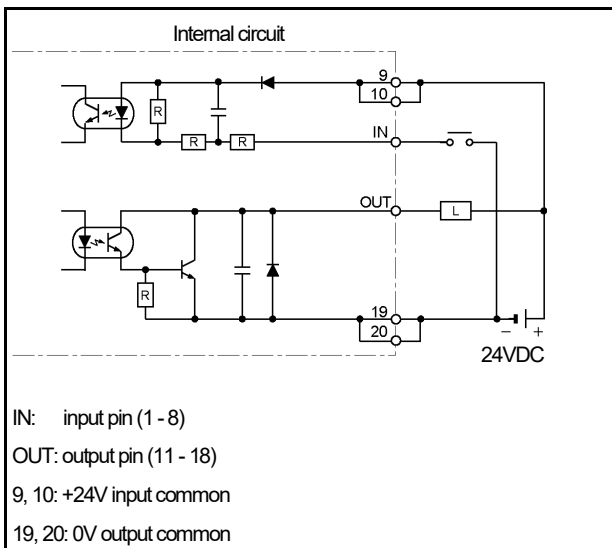

● External cable (VS-C10G)

Indicates external cable wire colors and markings.

Pin No.	Wire colors & markings
20	Pink (Black ■■)
19	Pink (Red ■■)
18	Yellow (Black ■■)
17	Yellow (Red ■■)
16	White (Black ■■)
15	White (Red ■■)
14	Gray (Black ■■)
13	Gray (Red ■■)
12	Orange (Black ■■)
11	Orange (Red ■■)
10	Pink (Black ■)
9	Pink (Red ■)
8	Yellow (Black ■)
7	Yellow (Red ■)
6	White (Black ■)
5	White (Red ■)
4	Gray (Black ■)
3	Gray (Red ■)
2	Orange (Black ■)
1	Orange (Red ■)

③ Analog output connector

[Connector model: HR31-5.08P-5SC(72), Crimp contact: HR31-SC-121(71), (HIROSE ELECTRIC CO., LTD)]

Pin No.	Signal name	Description	
1 *1	CH1+	Voltage output	Current output
2 *1	CH1-	Voltage output common	Current output common
3 *1	CH2+	Voltage output	Current output
4 *1	CH2-	Voltage output common	Current output common
5	SHIELD	Shield	

Crimp contact size 1.25 mm²

Crimp tool Use crimp tool conforming to JIS C 9711 standards.

Applicable conductor cross area ... 0.25 to 1.65 mm²

For details, refer to the manufacturer's instructions.

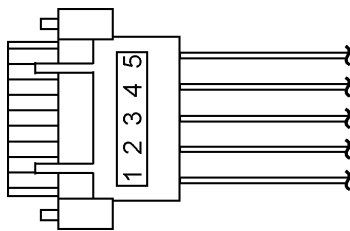

Remarks

*1: Contents to output

- Can be made in voltage using VS-10GH-A and VS-10GH-A-1.
- Can be made in current using VS-10GH-C-1.

● Circuit

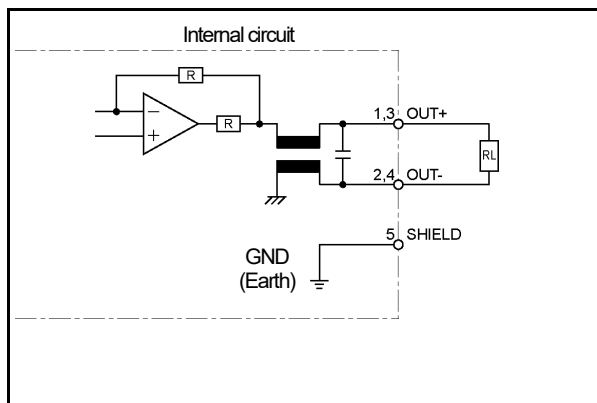

2-5. Serial Communication Connector Specifications

Contact our sales representative for serial communication details.

2-5-1. Connector names and functions

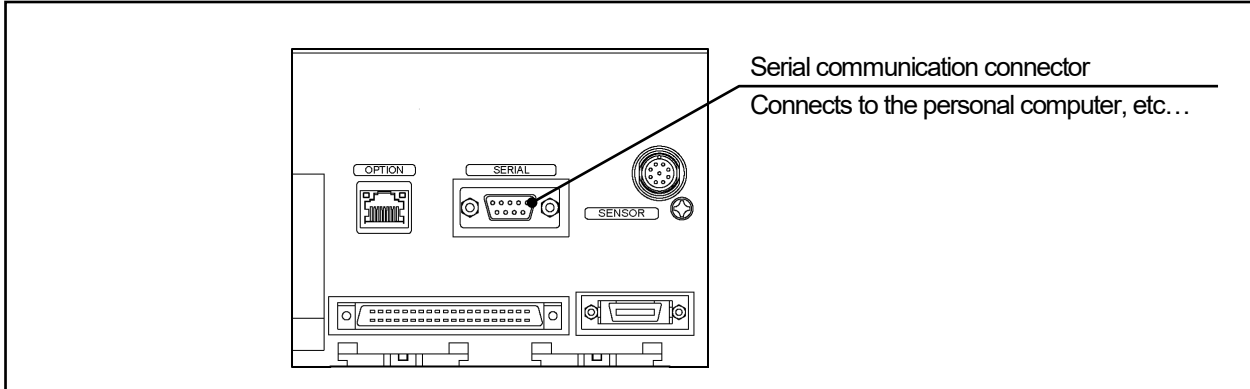

2-5-2. Communication interface specification

Items	Specifications	
	RS-232C	RS-485
Interface	RS-232C	RS-485
Communication format	Full duplex, start stop synchronization	Half duplex, start stop synchronization
Transmission speed	2400, 4800, 9600, 19200, 38400, 57600 bps	
Communication signal	TXD, RXD, RTS, CTS, SG	DATA+, DATA-, SG
Connector format	9-pin connector (D-sub male)	

2-5-3. Communication connector pin arrangement

Uses the serial communication connector when connecting the PLC, computer, or peripheral device.

◎Serial connector (SERIAL)

[Connector: D-Sub 9-pin]

Pin No.	Signal name	Description	Notes
1	DATA-	-	
2	RXD	Receive Data	
3	TXD	Send Data	
4	DTR	Data Terminal Ready	
5	SG	Signal Ground	
6	DSR	Data Set Ready	
7	RTS	Request To Send	
8	CTS	Clear To Send	
9	DATA+	-	
Mounting screw	SHIELD	Cable shield	Shield must be connected.

Connector on the VARILIMIT side

Model : DELC-J9PAF-13L6E (9-pin male)

Manufacturer : Japan Aviation Electronics Industry, Ltd.

2-6. Signal Timing Patterns

2-6-1. Power on/off timing

This is the timing pattern where power is turned on and off in RUN mode.

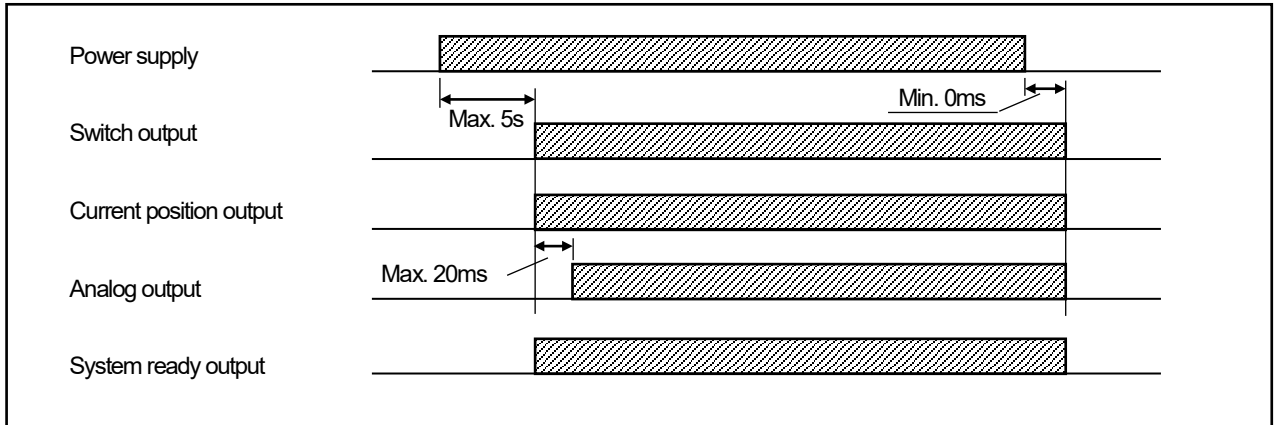

2-6-2. Program number change timing

This is the timing pattern where program numbers are changed in the RUN mode.

The timing pattern differs depending on the setting of Parameter No. E0 (VARILIMIT Mode Selection).

(1) Parameter No. E0: 1 (8-program mode)

For the program No., input each of 8 points signals individually.

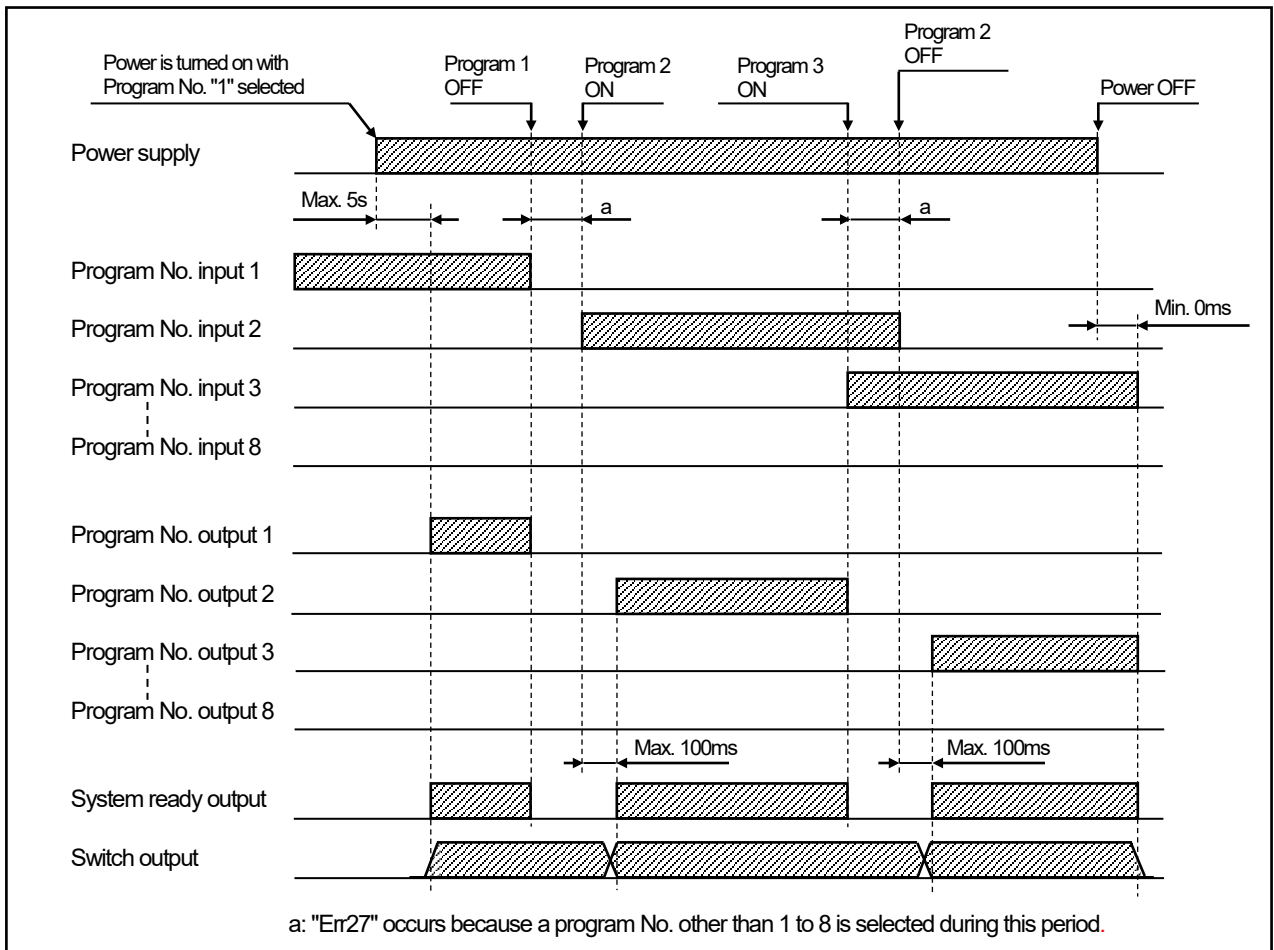

(2) Parameter No. E0: 2 (32-program mode)

For the program No., input 5 points data in binary code.

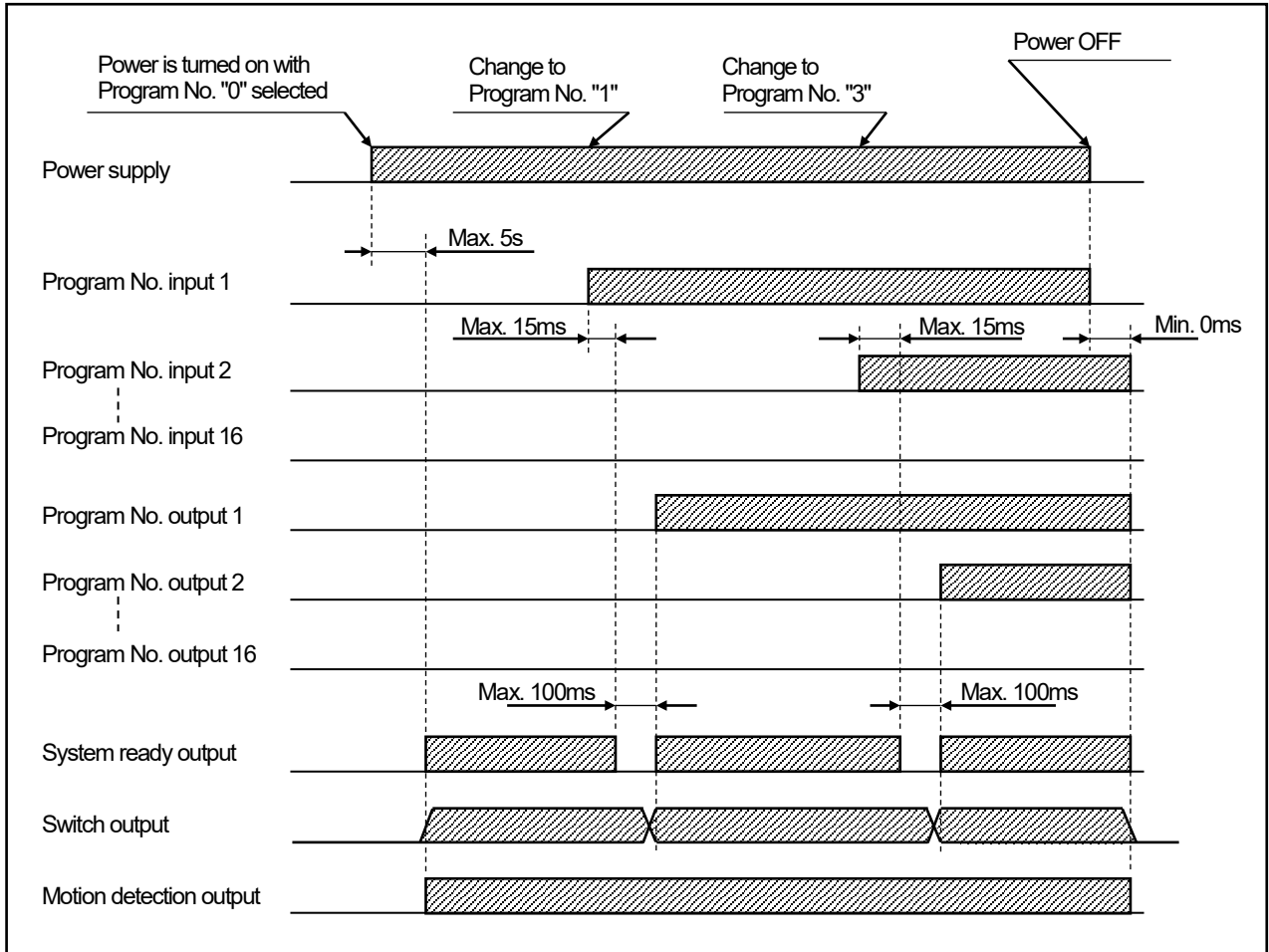

2-6-3. Current position preset timing

This is an example where "Current Position Preset Value" is set to "200".

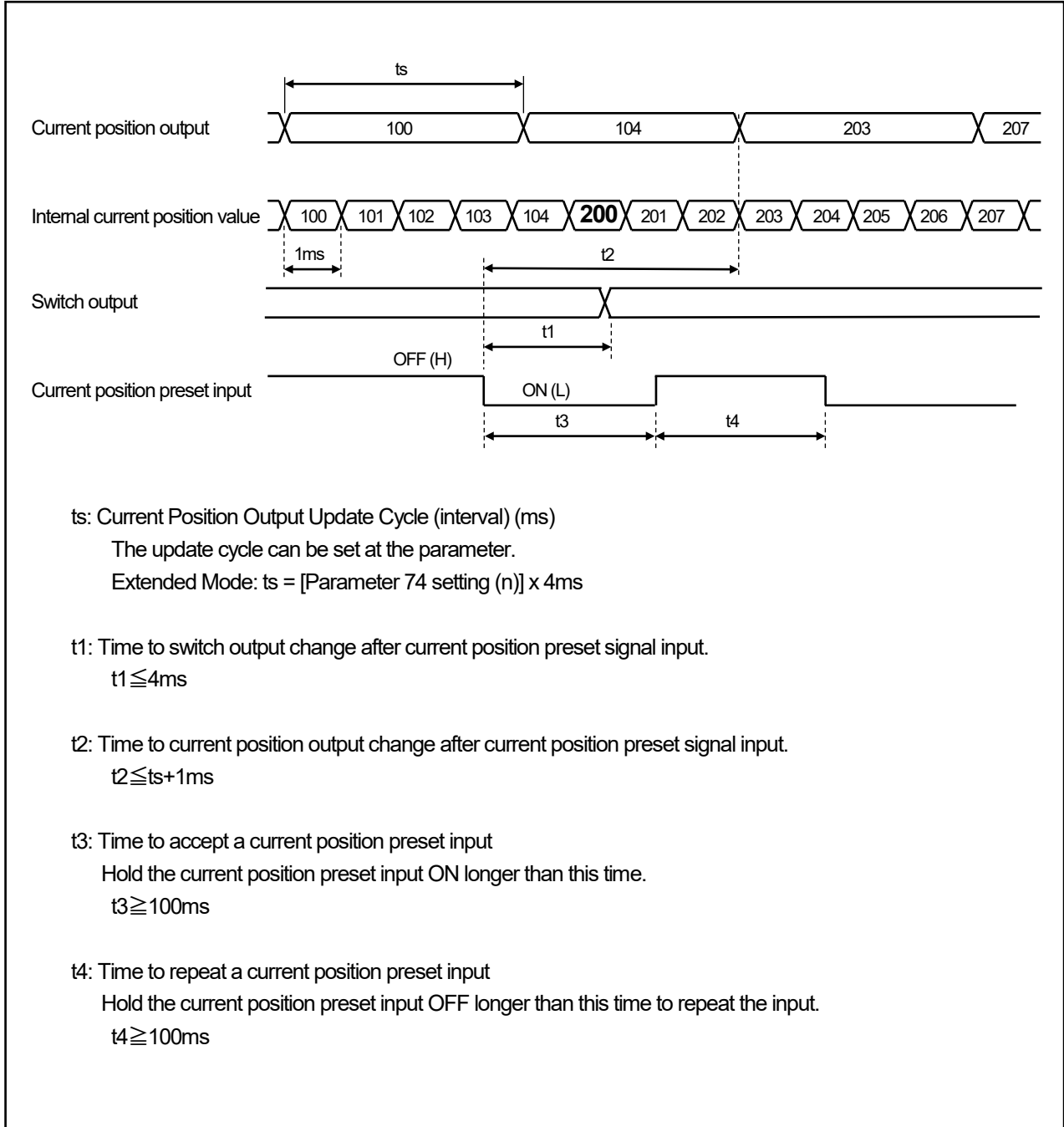

2-6-4. Current position output timing

This timing pattern applies to VS-10GH-D and VS-10GH-D-1. These VARILIMIT models will output the current position value on a real-time basis. When a continuously changing current position value needs to be read, use of the latch pulse signal and the DTC signal will allow stable reading: The following section explains about the relationship between these signals and about related parameter settings and functions.

Positive and negative logics registered to Parameter 94 ("Current Position Output Code/Logic")

Current Position Output Code/Logic (Parameter 94)	Logic values for the following timings		Signals controlled
	0	1	
Positive logic	Transistor on (low level)	Transistor off (high level)	Current Position Value Minus sign Latch pulse
Negative logic	Transistor off (high level)	Transistor on (low level)	

Note: Regardless of the above settings, the DTC signal logic will work in the following timing patterns:

(1) Reading the current position output in synchronization with the latch pulse signal

There are two ways for reading, either at edge timing or at level timing of the latch pulse output.

Set the latch pulse output timing at the parameter75.

① Edge Timing (stable output when the latch pulse changes from 0 to 1)

When Parameter 75 is set to 0

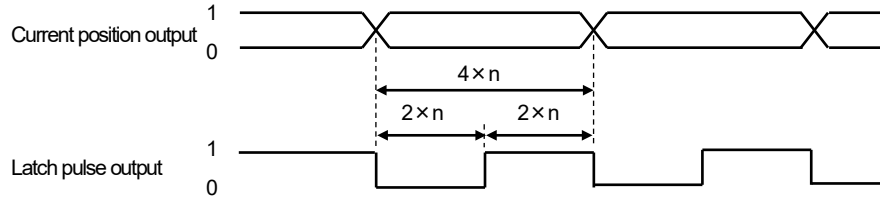

n: Time for updating current position output (n: 1-128 [ms] , setting range at Parameter 74)
While the latch pulse output is changing from 0 to 1, the current position output is stable.
Read the output during this time.

② Edge Timing (stable output when the latch pulse changes from 1 to 0)

When Parameter 75 is set to 1

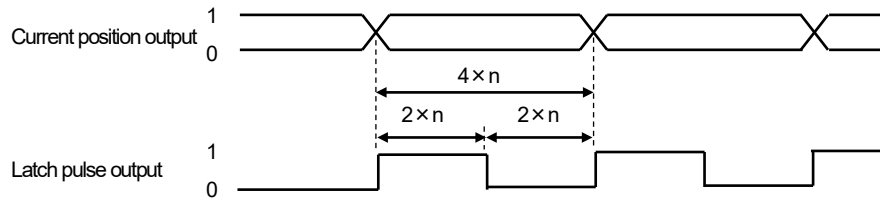

n: Time for updating current position output (n: 1-128 [ms] , setting range at Parameter 74)
While the latch pulse output is changing from 1 to 0, the current position output is stable.
Read the output during this time.

③ Level Timing (stable output when the latch pulse is 0)

When Parameter 75 is set to 2

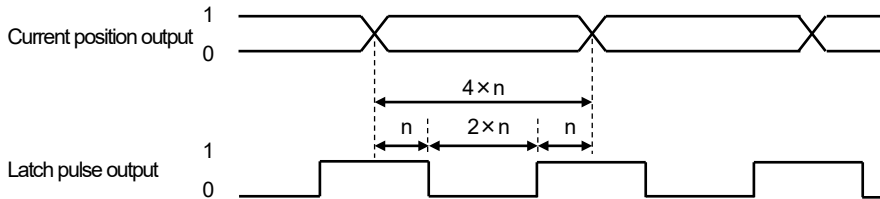

n: Time for updating current position output (n: 1-128 [ms] , setting range at Parameter 74)
While the latch pulse output is 0, the current position output is stable.
Read the output during this time.

④ Level Timing (stable output when the latch pulse is 1)

When Parameter 75 is set to 3

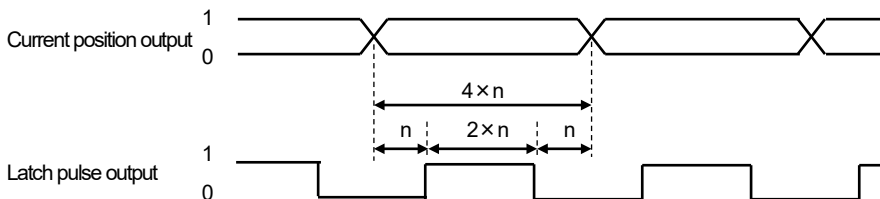

n: Time for updating current position output (n: 1-128 [ms] , setting range at Parameter 74)
While the latch pulse output is 1, the current position output is stable.
Read the output during this time.

(2) Reading current position output using DTC signal

There are two ways for reading current position output using DTC signal.

- ① Transparent Method
- ② PC Synchronization Method

① Transparent Method

In this method, Parameter 74 should be set to "1" in advance. (factory setting)

While the DTC signal is ON, updating of the current position output will be suspended to hold the data. Have the host controller read in the output during this time.

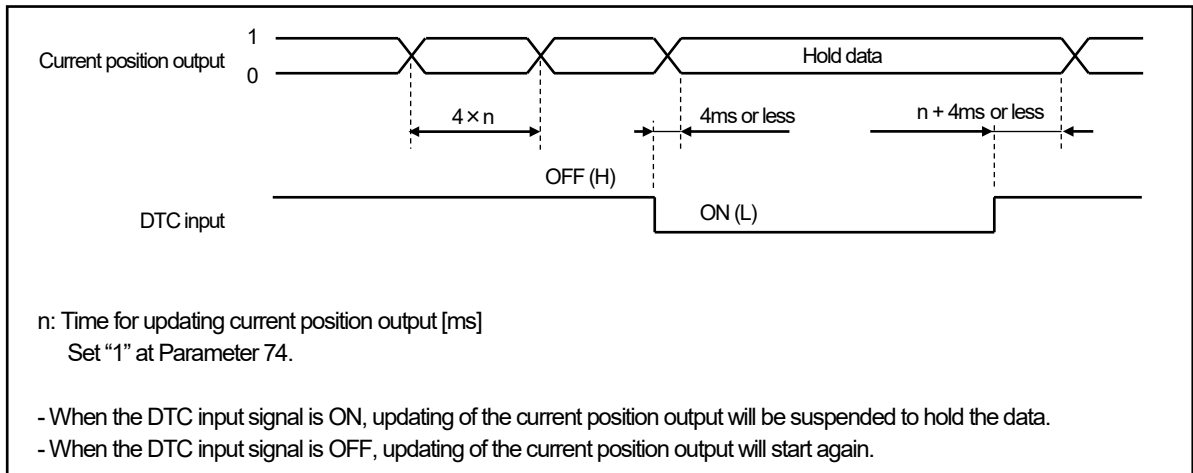

② PC Synchronization Method

In this method, Parameter 74 should be set to "0" in advance.

The current position output will be updated when the DTC signal state changes (at leading and trailing edges). Have the host controller read in the output during this time.

This enables the current position output to be read in synchronization with the host controller's scan time.

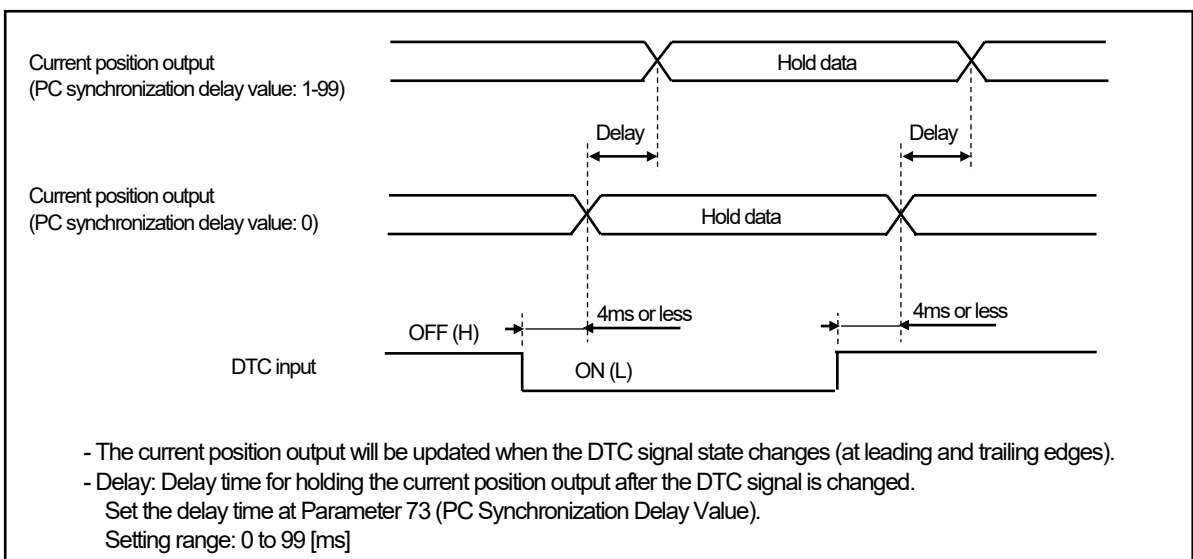

2-6-5. Multi-Origin timing

This timing pattern applies to the Extended Mode of VS-10GH-D and VS-10GH-D-1.
The VS-10B Mode is not equipped with this function.

Described below is the current position output timing when a program number is externally changed using the Multi-Origin function. In the example below, the program number is changed from 1 to 8 when the current position value of Program 1 is 104 and that of Program 8 is 203.

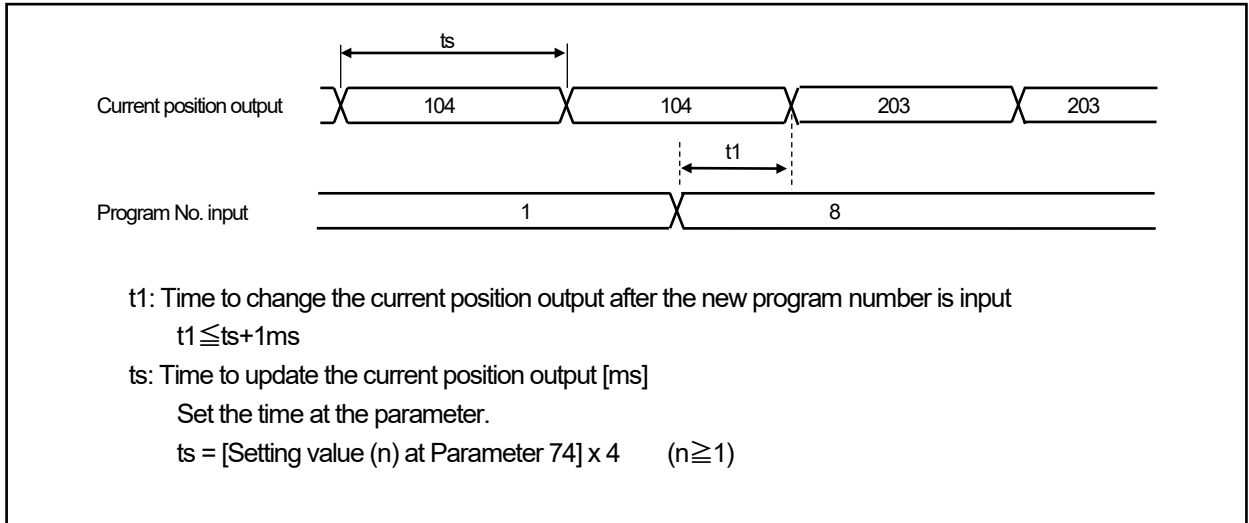

2-6-6. Error cancel input timing

This timing applies to all models of the VS-10GH Series.

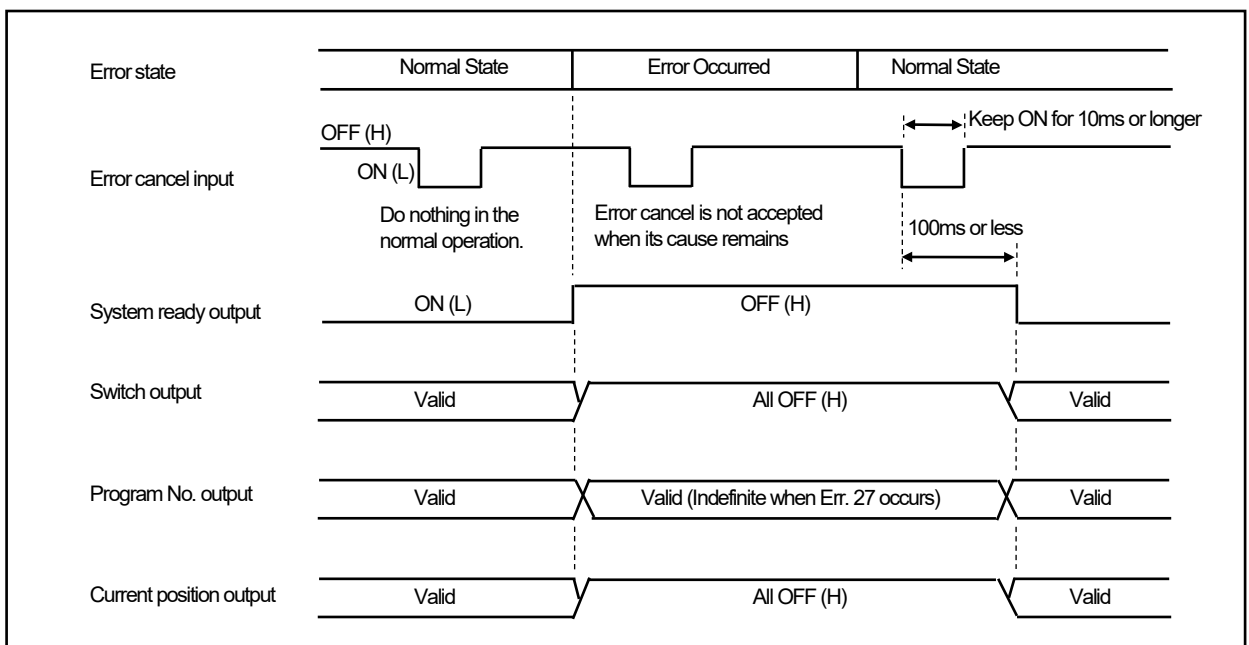



SPECIFICATION



SPECIFICATIONS AND DIMENSIONS

- MEMO -

OPERATION

Describes about the operation of product.

- 3. OPERATION FLOW
- 4. USE IN THE EXTENDED MODE
- 5. SWITCH OUTPUT SETTING
- 6. OPERATION

3. OPERATION FLOW

3-1. Procedure Before the Operation

The following chart shows the steps before starting VARILIMIT operation.

1. Parameter setting

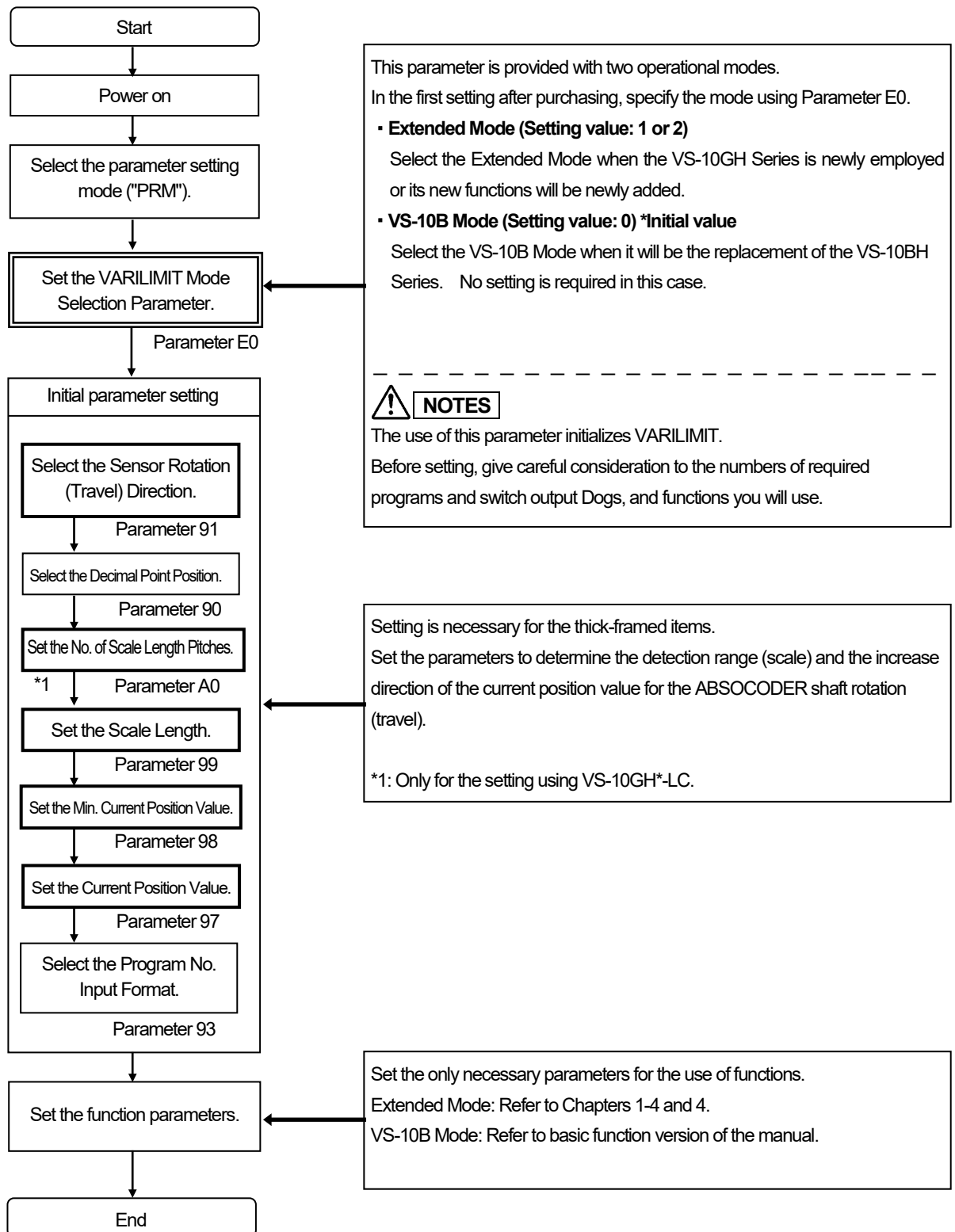



2. Switch output setting

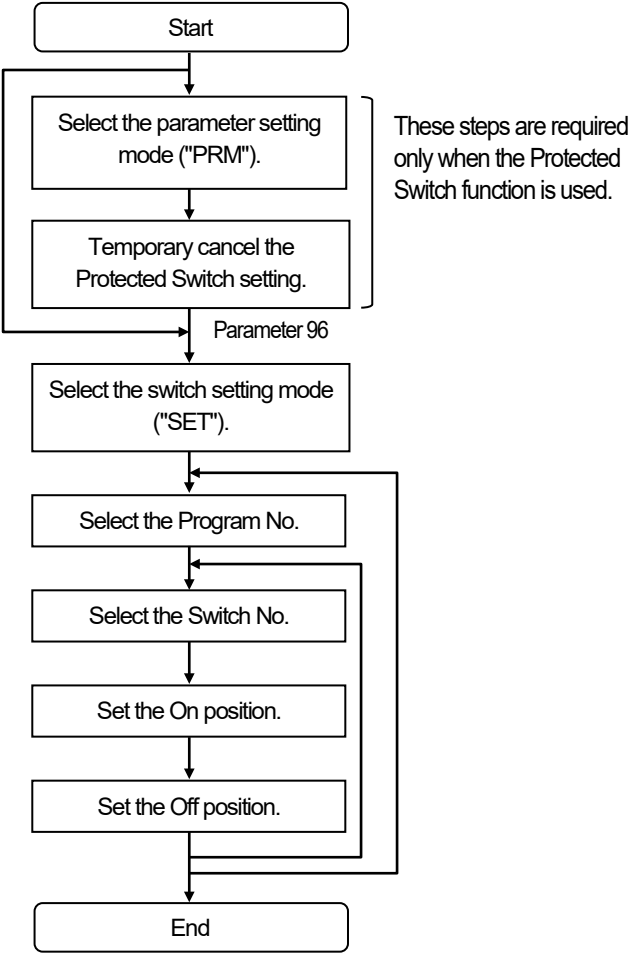

3. Unit operation

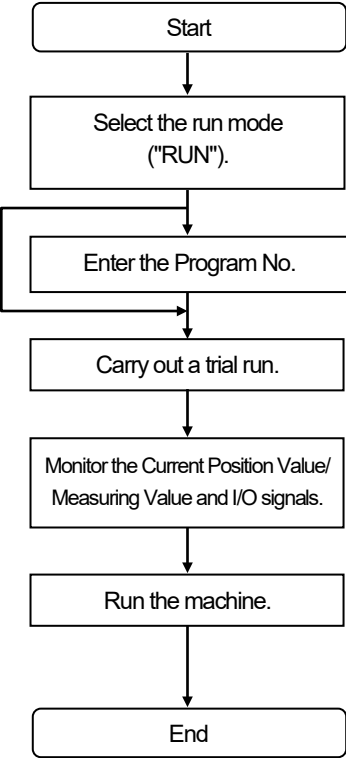



3-2. Nomenclature and Function of the Panel Side

Describes nomenclatures and functions of the panel side.

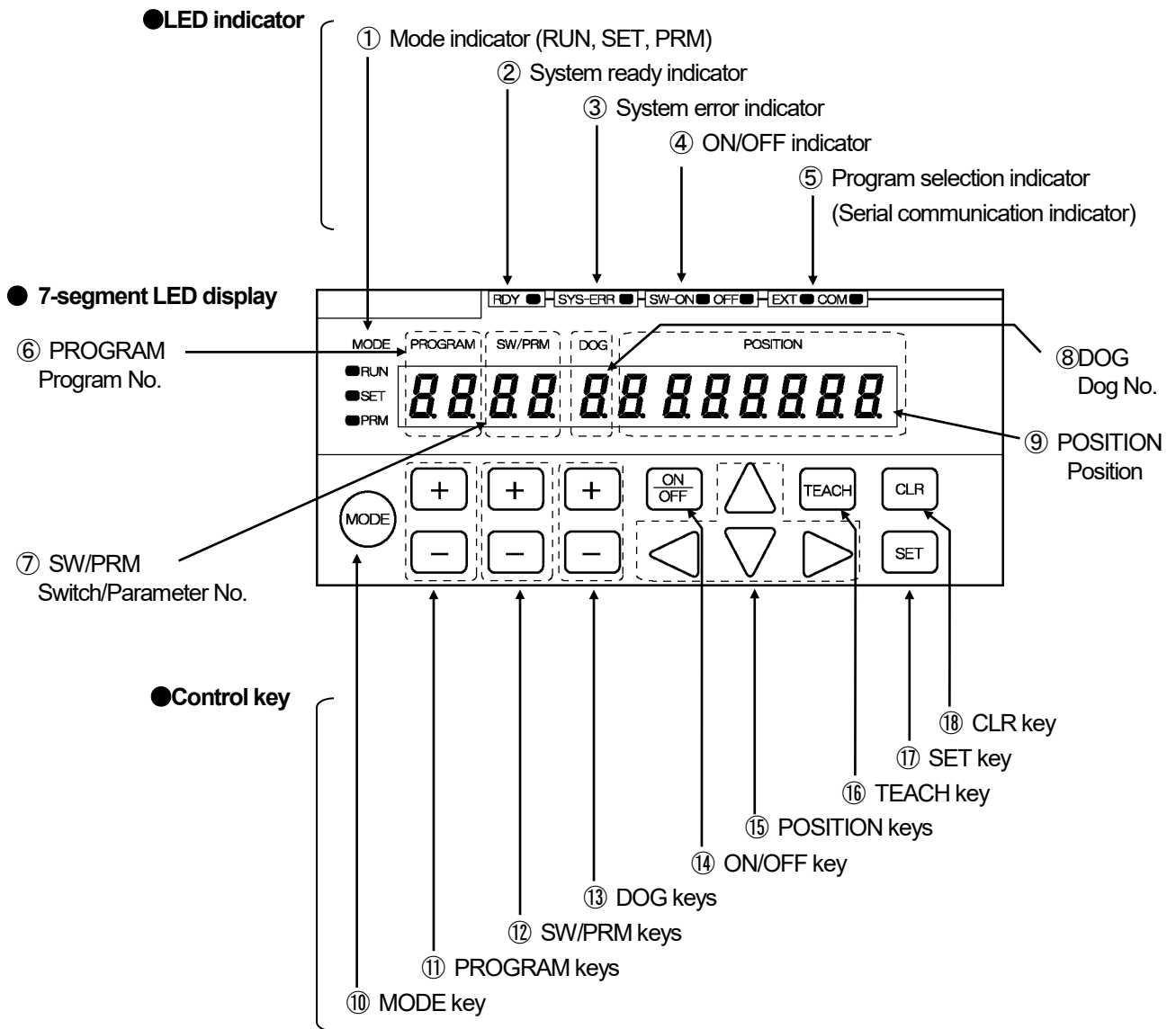

● Indicators

No.	Name	Descriptions
①	Mode indicator RUN, SET, PRM	Indicates selecting mode. RUN LED is ON: The run mode ("RUN") is selected. SET LED is ON: The switch setting mode ("SET") is selected. PRM LED is ON: The parameter setting mode ("PRM") is selected.
②	System ready indicator RDY	RDY LED is ON: Indicates that there is no error during selecting the run mode ("RUN"). This indicator is same condition as "System ready output signal" of the output connector.
③	System error indicator SYS-ERR	SYS-ERR LED is ON: Indicates that VARILIMIT hardware has a malfunction.
④	ON / OFF indicator SW-ON, OFF	SW-ON LED is ON: Displays ON setting value of the switch output on the display area ⑨ "POSITION" OFF LED is ON: Displays OFF setting value of the switch output on the display area ⑨ "POSITION"
⑤	Program selection indicator (Serial communication indicator) EXT, COM	(1) Indicates the program No. input method. Both EXT LED and COM LED are OFF: Selecting key input on the panel EXT LED is ON: Selecting the input from the program No. I/O connector COM LED is ON: Selecting following contents: - Inputs by the serial communication - Sets "2" or "3" at the parameter 54 (protocol)
		(2) Monitors the serial communication EXT LED is flickering : Sending the data COM LED is flickering: Receiving the data
⑥	Program No. display PROGRAM	Displays selecting program No..
⑦	Switch No. / parameter No. display SW / PRM	A switch No. is displayed when selecting the switch setting mode ("SET") or run mode ("RUN"). A parameter No. is displayed when selecting the parameter setting mode ("PRM").
⑧	Dog No. display DOG	A dog No. of the switch output is displayed.
⑨	Position display POSITION	A setting value is displayed when selecting the switch setting mode ("SET") or parameter setting mode ("PRM"). A current position value or an error code is displayed when selecting the run mode ("RUN").

● Control keys

No.	Name	Descriptions
⑩	MODE key	Selects the mode from the run mode ("RUN"), switch setting mode ("SET"), and parameter setting mode ("PRM").
⑪	PROGRAM keys	Selects the program No..
⑫	SW/PRM keys	Selects the switch No. in the switch setting mode ("SET") or run mode ("RUN"). Selects the parameter No. in the parameter setting mode ("PRM").
⑬	DOG keys	Selects the dog No. of the switch output.
⑭	ON/OFF key	Changes either ON or OFF setting value of the switch output. Changes ④ "ON / OFF indicator" when pressing this key.
⑮	POSITION keys	Increases or decreases the setting value that is displayed at ⑨ "POSITION".
⑯	TEACH key	Uses this key when setting the switch output by the teaching. Reads the machine's current position by pressing this key when selecting the switch setting mode ("SET").
⑰	SET key	Confirms the mode by pressing this key when selecting a mode. Confirms the setting value by pressing this key when selecting the switch setting mode ("SET") or parameter setting mode ("PRM"). Changes the monitor types by pressing this key when selecting the run mode ("RUN").
⑱	CLR key	Uses this key following case: - Cancel the setting value when specifying the switch output or parameter. - Cancel the error.

3-3. Operation Flows in Different Modes

An operation flowchart is shown below.

● Operation Flow for VARILIMIT Mode Selection (Parameter E0)

The VARILIMIT VS-10GH Series is provided with two operational modes.

In the first setting after purchasing, set this parameter for VARILIMIT Mode Selection.

- Extended Mode: Specify the Extended Mode when the VS-10GH Series is newly employed or its new functions will be newly added.
- VS-10B Mode: Refer to the basic function version of the manual.

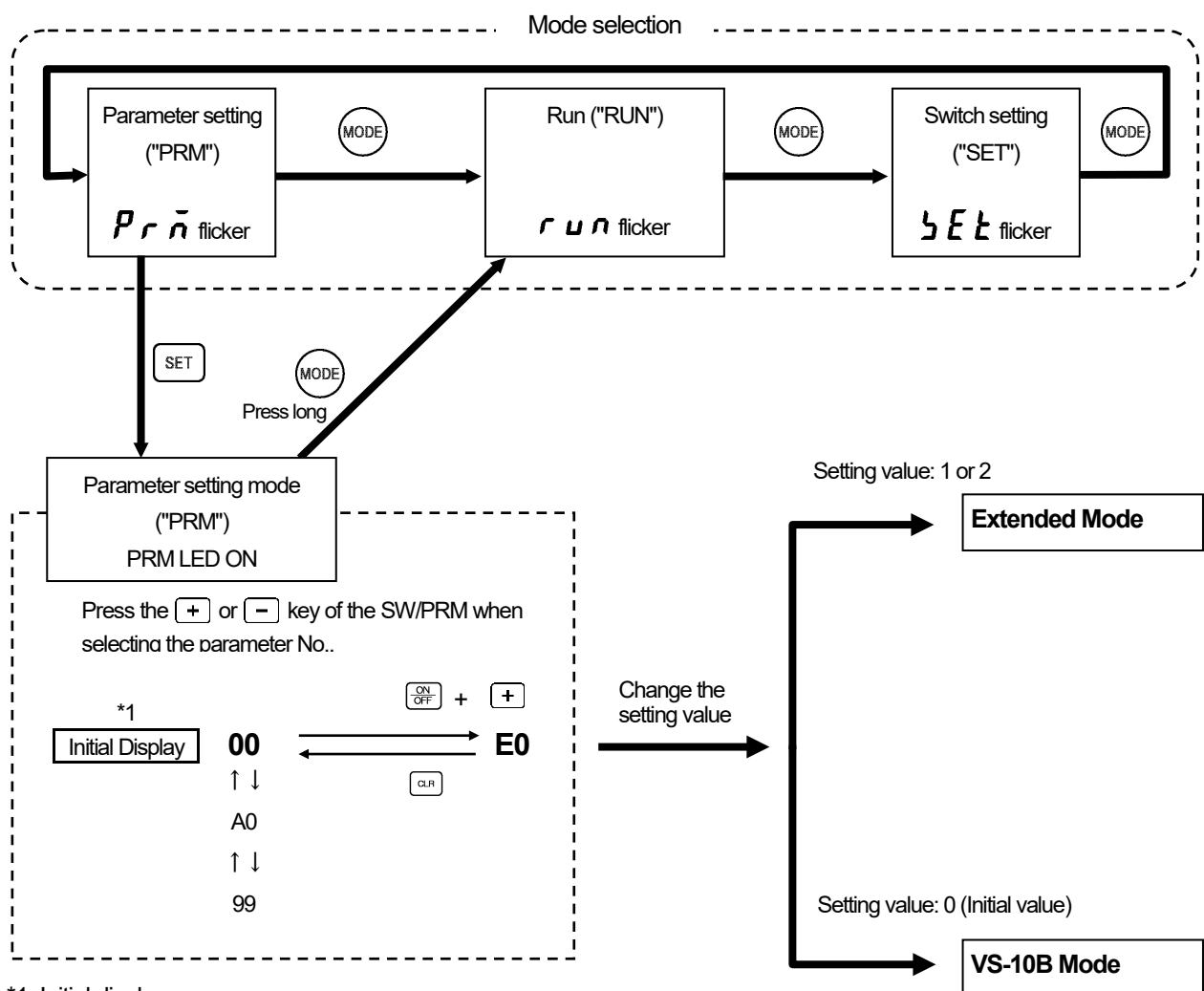

*1: Initial display

99 is displayed when the power is turned on for the first time after the purchase.
When the Extended Mode is selected, the initial display becomes 00.

⚠ NOTES

When the setting at the VARILIMIT Mode Selection parameter (E0) is changed, VARILIMIT will be initialized. All setting values of parameters and switch output will be erased. Not to change this parameter in mid-course, give careful consideration to the numbers of required programs and functions to use before setting.



OPERATION



OPERATION FLOW

● Operation Flow in the Extended Mode

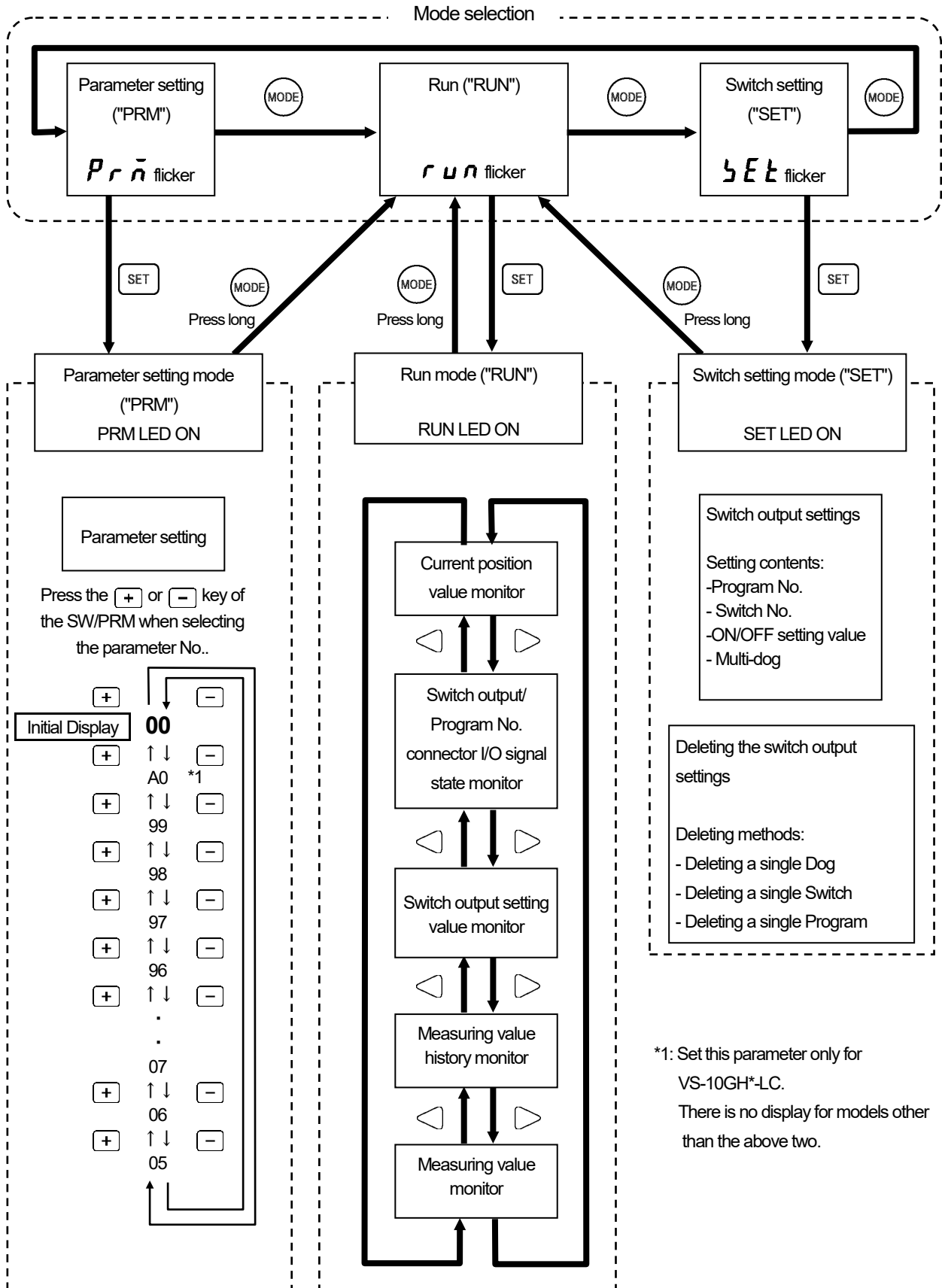

3-4. Turn ON the Power Supply

The VS-10GH Series doesn't have any power supply switch; therefore, use external switch for turning ON / OFF the power supply.

Before turning ON the power supply, be sure that the wiring is correct and the screws of terminal block are securely tightened.

The screen displays as below figure when turning ON the power supply for the first time after delivery.
 After turning ON the power supply, the screen below is displayed one second.

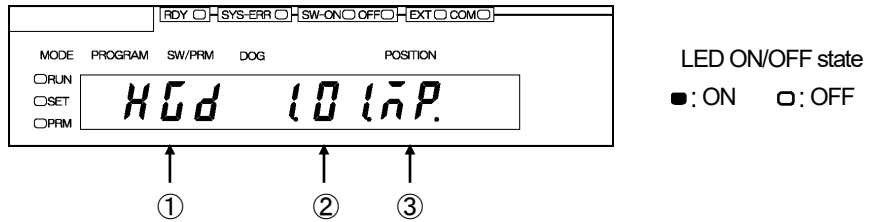

① : VARILIMIT model

GD: VS-10GH-D, VS-10GH-D-1

GA: VS-10GH-A, VS-10GH-A-1 **GC**: VS-10GH-C-1

② : Software version

③ : ABSOCODER type:

nr: MRE-[JSP061, 074, 097, 101 **Pr**: VRE-P061, 074, 097, 101

LC: CYLNUC, CYLNUC Mark II, VLS-12.8, IRS-51.2P

82: VRE-16TS100

8P: VRE-P100



Changes the Parameter setting mode ("PRM") automatically.

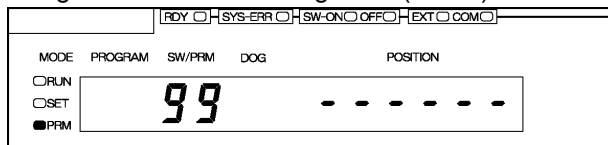

The screen displays below figure when changing mode to Run mode ("RUN") or Switch setting mode ("SET").

In the case of restarting the power supply, keeps the mode just before turning OFF.

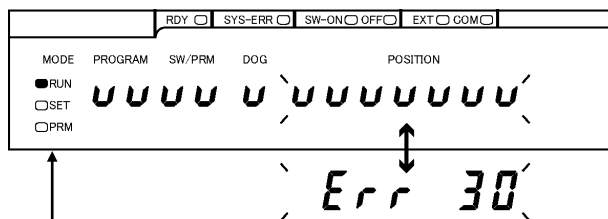

"UUU...UUU" and Err 30 (31) alternately flicker.

Run mode ("RUN") : RUN LED is ON

Switch setting mode ("SET") : SET LED is ON



OPERATION



OPERATION FLOW

- MEMO -

4. USE IN THE EXTENDED MODE

Functions and settings in the Extended Mode are described in this section.
 Refer to the basic function version of the manual for details of the VS-10B Mode.

4-1. Setting the VARILIMIT Mode Selection Parameter

Select 1 or 2 at Parameter E0 (VARILIMIT Mode Selection) for the Extended Mode. Set this parameter only in the first parameter setting after purchasing.

In the Extended Mode, many new functions can be used in addition to the existing positioning functions such as Switch Output and Current Position Output. Refer to “1-4-1. VARILIMIT function list” for the function details. In this mode, an appropriate combination of numbers of programs, switches and Dogs can be selected.

●Numbers of programs, switches and Multi-Dogs

The number of available Multi-Dogs will change depending on the selected number of programs.

Item	Setting Value at Parameter E0		
	1 (Extended Mode)	2 (Extended Mode)	0 (VS-10B Mode) Refer to the basic function version of the manual.
Number of Programs *1	8	32	8
Number of Switches	30	30	30
Number of Multi-Dogs for all switches	10	4	10

Remarks

- *1: Note that the method to input program numbers is different by mode.
 8-program mode (Parameter E0: 0 or 1): Input each of 8 points signals individually.
 1 input =1 program
 32-program mode (Parameter E0: 2): Input 5 points data in binary code.

NOTES

When the setting at the VARILIMIT Mode Selection parameter (E0) is changed, VARILIMIT will be initialized. All setting values of parameters and switch output will be erased. Not to change this parameter in mid-course, give careful consideration to the numbers of required programs and functions to use before setting.

Perform the following steps to set the VARILIMIT Mode Selection parameter.

① Select the parameter setting mode ("PRM").

Press and hold down the **MODE** key (more than 1 second).

The POSITION display will flicker to indicate mode selection is possible.

Press the **MODE** key a number of times until the parameter setting mode ("PRM") is shown.

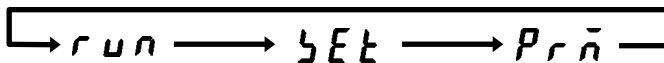
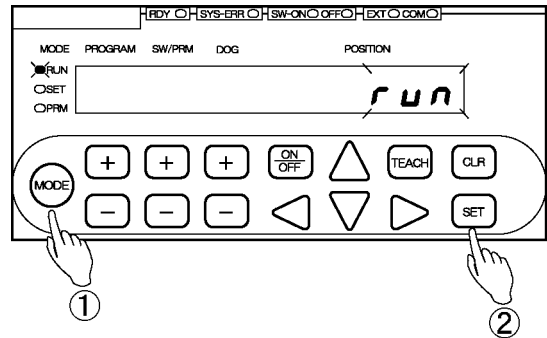

Run mode ("RUN")	Switch setting mode ("SET")	Parameter setting mode ("PRM")
MODE	MODE	MODE
<input checked="" type="checkbox"/> RUN	<input type="checkbox"/> RUN	<input type="checkbox"/> RUN
<input type="checkbox"/> SET	<input checked="" type="checkbox"/> SET	<input type="checkbox"/> SET
<input type="checkbox"/> PRM	<input type="checkbox"/> PRM	<input checked="" type="checkbox"/> PRM

② Confirm the mode selection

Press the **SET** key.

The mode is now set to the parameter setting mode ("PRM").

③ Select Parameter 00.

Use the **+** and **-** keys under the SW/PRM display to select "00".

The numbers in the POSITION display indicate the setting values at Parameters E0 and 5. and the number of usable programs.

3rd digit: Setting value at Parameter E0

2nd and 1st digits: Setting value at Parameter 5

PRM LED is ON
LED ON/OFF state
■: ON □: OFF

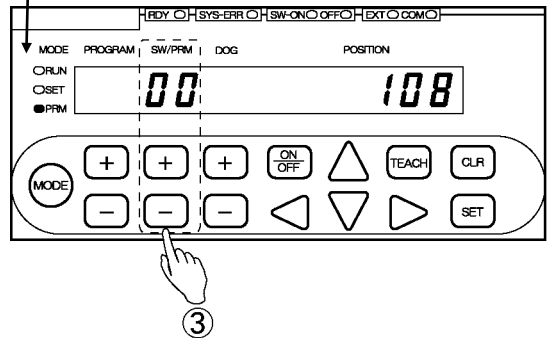

④ Select Parameter E0.

Press the **+** key under the SW/PRM display by holding down the **ON/OFF** key.

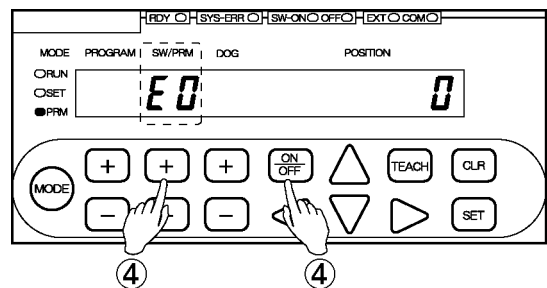

⑤ Select the setting value.

Use the \triangle and ∇ keys under the POSITION display to select the setting value.

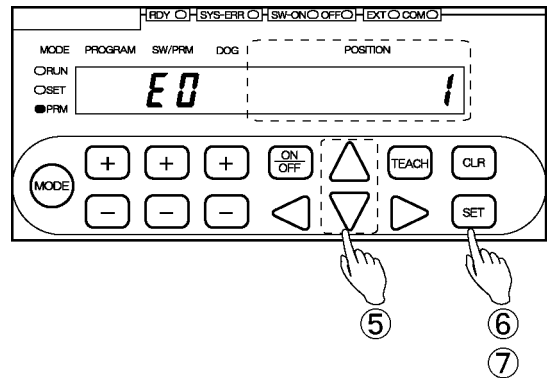

Options:

0: VS-10B Mode *1
(8 programs, 30 switches, 10 Dogs)

1: Extended Mode
(8 programs, 30 switches, 10 Dogs)

2: Extended Mode
(32 programs, 30 switches, 4 Dogs)

NOTES

*1: Never to select the VS-10B Mode.
For VS-10B Mode details, refer to the basic function version of the manual.

The entered value can be canceled by pressing the CLR key at this point.

⑥ Check the entered value. *2

Press the SET key.
The POSITION display will flicker more quickly.
Check the entered value again carefully.

The entered value can be canceled by pressing the CLR key at this point.

POINT:

*2: As changing the setting value will initialize VARILIMIT settings, the SET key is required to be pressed twice to urge caution.

⑦ Confirm the entered value *2

Press the SET key again.
The POSITION display will show "CLEAR".
After confirming it, determine the entered value.

⑧ Return to Parameter 00

Press the CLR key and return to Parameter 00.

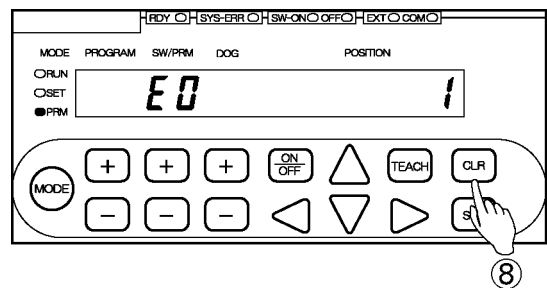



OPERATION

EXTENDED MODE (Pr. E0=1, 2)

- MEMO -

4-2. Parameter List

This parameter list describes details of each function.
 Values shown in are the initial (factory setting) values.
 Parameters that do not need to be changed can be left as they are.

●VARILIMIT Mode Selection Parameter

(1/1)

No.	Name	Description and setting range	Applicable model			Reference (Chapter No.)
			10GH -D	10GH -A	10GH -C	
E0	VARILIMIT Mode Selection	Selects the VARILIMIT Mode. <input type="checkbox"/> : VS-10B Mode 8 programs, 30 switches, 10 Dogs Select "0" when the VS-10GH Series will be the replacement of the VS-10BH Series. 1: Extended Mode 8 programs, 30 switches, 10 Dogs Select "1" when the VS-10GH Series is newly employed. 2: Extended Mode 32 programs, 30 switches, 4 Dogs Select "2" when the VS-10GH Series is newly employed.	○	○	○	4-1



NOTES

When the setting at the VARILIMIT Mode Selection parameter (E0) is changed, VARILIMIT will be initialized. All setting values of parameters and switch output will be erased. Not to change this parameter in mid-course, give careful consideration to the numbers of required programs and functions to use before setting.

●Initial Parameters

(1/1)

No.	Name	Description and setting range	Applicable model			Reference (Chapter No.)
			10GH -D	10GH -A	10GH -C	
00	Initial Display	The items selected using Parameter E0 will be shown.	<input type="radio"/>	<input type="radio"/>	<input type="radio"/>	
A0	Number of Scale Length Pitches[n] *1	Set the number of pitches to be detected. Setting range: 1 to 9999 <input type="text"/>	<input type="radio"/>	<input type="radio"/>	<input type="radio"/>	4-6
99	Scale Length [L]	Set the longest distance that should be detectable by the ABSOCODER. Setting range: 10 to 999999 <input type="text"/>	<input type="radio"/>	<input type="radio"/>	<input type="radio"/>	4-6
98	Minimum Current Position Value [K]	Set the smallest possible Current Position Value. Setting range: -999999 to (1000000-L) <input type="text"/>	<input type="radio"/>	<input type="radio"/>	<input type="radio"/>	4-6
97	Current Position Setting	Set a value that represents the current machine position. Setting range: K to (K+L-1) <input type="text"/>	<input type="radio"/>	<input type="radio"/>	<input type="radio"/>	4-6
91	Sensor Selection / Sensor Rotation (Travel) Direction	Select the ABSOCODER model and the direction of rotation (travel). The current position value will increase in the selected direction. 0: CW 1: CCW <input type="text"/>	<input type="radio"/>	<input type="radio"/>	<input type="radio"/>	4-4
90	Decimal Point Position	Select the decimal point position. <input type="radio"/> : 000000. 1: 00000. 0 2: 0000. 00 3: 000. 000 4: 00. 0000 5: 0. 00000	<input type="radio"/>	<input type="radio"/>	<input type="radio"/>	4-5
93	Program No. Input Method	Select the method to enter the Program Number to be run. <input type="radio"/> : Panel key input 1: External input via connector 2: Serial communication	<input type="radio"/>	<input type="radio"/>	<input type="radio"/>	4-8
78	Output Status in Other Than RUN Mode	Select the desired switch output status for when the mode has been changed from the Run mode to either the switch setting mode ("SET") or the parameter setting mode ("PRM"). <input type="radio"/> : Output Hold 1: Output Off	<input type="radio"/>	<input type="radio"/>	<input type="radio"/>	4-13

Remarks

*1: Set this parameter when using VS-10GH**-LC.

Any other VARILIMIT model does not display this number.

●Current Position Output Function Parameters

(1/1)

No.	Name	Description and setting range	Applicable model			Reference (Chapter No.)
			10GH -D	10GH -A	10GH -C	
94	Current Position Output Code/Logic	Select the output code and logic for the Current Position Output. 0: BCD output (negative logic) / decimal point output (positive logic) 1: BCD output (positive logic) / decimal point output (negative logic) 2: BCD output (negative logic) / decimal point output (negative logic) 3: BCD output (positive logic) / decimal point output (positive logic) 4: Binary output (sign magnitude code, negative logic), decimal point output (positive logic) 5: Binary output (sign magnitude code, positive logic), decimal point output (negative logic) 6: Binary output (two's complement, negative logic), decimal point output (positive logic) 7: Binary output (two's complement, positive logic), decimal point output (negative logic)	○			4-12
75	Latch Pulse Timing	Select the timing for stable current position output when reading in the current position value using latch pulse output. 0: Current position output is stable when changing from 0 to 1. 1: Current position output is stable when changing from 1 to 0. 2: Current position output is stable at Level 0. 3: Current position output is stable at Level 1.	○			4-12
74	Current Position Output Update Cycle [n] / HOLD Method Selection	Choose the method to read the output while the current position update is suspended by the DTC input signal. In doing so, specify the current position output and latch pulse timing. 0: PC Synchronization Method Updates the current position output by changing the DTC input signal. 1 to 128: Transparent Method The current position output is updated while the DTC signal is OFF. The updating will be suspended when turning on the DTC signal. Setting Value [n] × 4 = Current Position Output Update Cycle [ms]	○			4-12
73	PC Synchronization Delay Value	Set the delay time for holding the current position output after the DTC signal is changed. Before setting this parameter, choose "0: PC Synchronization Method" at Parameter 74. Setting range: 0 to 99 [ms] 0	○			4-12

●Hysteresis Function Parameter

(1/1)

No.	Name	Description and setting range	Applicable model			Reference (Chapter No.)
			10GH -D	10GH -A	10GH -C	
71	Hysteresis Width	Designates a hysteresis width when controlling flickers of the current position value. Setting range: 0 to 999999 0	○	○	○	4-17

●Parameters Related Current Position Preset Function

(1) Parameters for Current Position Preset by Auto-detecting Travel Direction Function

(1/1)

No.	Name	Description and setting range	Applicable model			Reference (Chapter No.)
			10GH -D	10GH -A	10GH -C	
92	Current Position Preset Function Selection	Select whether to enable or disable the Current Position Preset function. 0: Preset Disabled 1: Preset Enabled	<input type="radio"/>	<input type="radio"/>	<input type="radio"/>	4-7 4-21
82	Current Position Preset Error Selection	Select the setting to enable or disable the current position preset error detection function. 0: Disabled SW30: Switch output, System ready output ON in case of errors, No error display 1: Enabled SW30: Error output, System ready output ON in case of errors, No error display 2: Enabled SW30: Switch output, System ready output OFF in case of errors, Error display (Err23 or Err50) 3: Enabled SW30: Error output, System ready output OFF in case of errors, Error display (Err23 or Err50)	<input type="radio"/>	<input type="radio"/>	<input type="radio"/>	4-7 4-21
11	Permissible Correction Amount 2	Set the acceptable range of the current position preset input 2. The Current Position Preset signal will only be valid when the Current Position Value is within the range of intended preset value \pm this value [P]. Setting range: 0 to 999999 999999	<input type="radio"/>	<input type="radio"/>	<input type="radio"/>	4-7
10	"FWD Current Position Preset" Value 2	Set the current position preset value for forward-direction travel when turning on the current position preset input 2. Setting range: -999999 to 999999 0	<input type="radio"/>	<input type="radio"/>	<input type="radio"/>	4-7
9	"RVS Current Position Preset" Value 2	Set the current position preset value for reverse-direction travel when turning on the current position preset input 2. Setting range: -999999 to 999999 0	<input type="radio"/>	<input type="radio"/>	<input type="radio"/>	4-7
8	Permissible Correction Amount 1	Set the acceptable range of the current position preset input 1. The Current Position Preset signal will only be valid when the Current Position Value is within the range of intended preset value \pm this value [P]. Setting range: 0 to 999999 999999	<input type="radio"/>	<input type="radio"/>	<input type="radio"/>	4-7
7	"FWD Current Position Preset" Value 1	Set the current position preset value for forward-direction travel when turning on the current position preset input 1. Setting range: -999999 to 999999 0	<input type="radio"/>	<input type="radio"/>	<input type="radio"/>	4-7
6	"RVS Current Position Preset" Value 1	Set the current position preset value for reverse-direction travel when turning on the current position preset input 1. Setting range: -999999 to 999999 0	<input type="radio"/>	<input type="radio"/>	<input type="radio"/>	4-7

(2) Limitswitchless Preset Function Parameters

(1/1)

No.	Name	Description and setting range	Applicable model			Reference (Chapter No.)
			10GH -D	10GH -A	10GH -C	
19	Limitswitchless Preset Stroke 2	Set the limitswitchless preset stroke when the current position preset input 2 is turned on. Setting range: 0 to 999999 <input type="text" value="0"/>	<input type="radio"/>	<input type="radio"/>	<input type="radio"/>	4-21
18	Limitswitchless Preset Value 2	Set the limitswitchless preset value when the current position preset input 2 is turned on. Setting range: -999999 to 999999 <input type="text" value="0"/>	<input type="radio"/>	<input type="radio"/>	<input type="radio"/>	4-21
17	Stop Decision Time 2 during Limitswitchless Preset	Set the time to determine the stoppage when the current position preset input 2 is turned on. Setting range: 0.100 to 9.999 [S] <input type="text" value="0.100"/>	<input type="radio"/>	<input type="radio"/>	<input type="radio"/>	4-21
16	Limitswitchless Preset Stroke 1	Set the limitswitchless preset stroke when the current position preset input 1 is turned on. Setting range: 0 to 999999 <input type="text" value="0"/>	<input type="radio"/>	<input type="radio"/>	<input type="radio"/>	4-21
15	Limitswitchless Preset Value 1	Set the limitswitchless preset value when the current position preset input 1 is turned on. Setting range: -999999 to 999999 <input type="text" value="0"/>	<input type="radio"/>	<input type="radio"/>	<input type="radio"/>	4-21
14	Stop Decision Time 1 during Limitswitchless Preset	Set the time to determine the stoppage when the current position preset input 1 is turned on. Setting range: 0.100 to 9.999 [S] <input type="text" value="0.100"/>	<input type="radio"/>	<input type="radio"/>	<input type="radio"/>	4-21
13	Limitswitchless Preset Function Enabled/Disabled *1	Select whether or not to enable the limitswitchless preset function. <input type="radio"/> : Disabled 1: Enabled	<input type="radio"/>	<input type="radio"/>	<input type="radio"/>	4-21

*1: When the Limitswitchless Preset function is enabled, “(1) Current Position Preset by Auto-detecting Travel Direction function” will be disabled.

To activate the Limitswitchless Preset function, it is necessary to set Parameters 92 and 82 in addition to the above parameters.

(3) Preset Error Absorption Function Parameter

(1/1)

No.	Name	Description and setting range	Applicable model			Reference (Chapter No.)
			10GH -D	10GH -A	10GH -C	
12	Preset Error Absorption Function Enabled/Disabled	Select whether or not to enable the preset error absorption function. <input type="radio"/> : Disabled 1: Enabled	<input type="radio"/>	<input type="radio"/>	<input type="radio"/>	4-20

To activate the Preset Error Absorption function, it is necessary to set the parameters for “(1) Current Position Preset by Auto-detecting Travel Direction” function in addition to the above parameter.

●Motion Detection Output Function Parameters

(1/1)

No.	Name	Description and setting range	Applicable model			Reference (Chapter No.)
			10GH -D	10GH -A	10GH -C	
77	Motion Detection Direction	<p>Select whether or not to enable the motion detection output function and set the travel direction in which the motion detection output is turned on.</p> <p>When one of the setting values 1 to 3 is selected, the motion detection function becomes enabled. The switch output 29 starts to send the motion detection output signal.</p> <p>0: Motion Detection Output disabled (SW29 operates for switch output.) 1: Both directions 2: Forward direction 3: Reverse direction</p>	○	○	○	4-11
76	Motion Detection Speed	<p>Set the travel speed for turning on the motion detection output.</p> <p>Setting range: 0 to 999999 500/s</p>	○	○	○	4-11

●Parameters Related Switch Output Function

(1) Protected Switch Function Parameters

(1/1)

No.	Name	Description and setting range	Applicable model			Reference (Chapter No.)
			10GH -D	10GH -A	10GH -C	
20	Number of Protected Switches	Set the number of switches that serve as protected switches. <input type="checkbox"/> : No Protected Switch 1 to 30: Switches from 1 to what is set at the parameter will serve as protected switches.	○	○	○	4-9
96	Protected Switch Suspended	Suspend the protected switch function. Select "1: Protected Switch function suspended" to change the setting value for switch output. The protected switch function becomes active again by changing the RUN Mode or by restarting the power. <input type="checkbox"/> : Protected Switch function enabled 1: Protected Switch function suspended	○	○	○	4-10

(2) Switch Output Enabling Function Parameters

(1/1)

No.	Name	Description and setting range	Applicable model			Reference (Chapter No.)
			10GH -D	10GH -A	10GH -C	
70	Switch Output Enabling Range	At Switch output connector B3-pin Set the number of switch output for controlling by the switch output enabling signal. <input type="checkbox"/> : Disabled Switch output signals will be sent regardless of the switch output enabling signal. 1 to 30: Enabled Switch outputs from 1 to what is set at the parameter will be enabled only when the switch output enabling signal is ON.	○	○	○	4-18

(3) Limitswitch Timer Function Parameters

(1/1)

No.	Name	Description and setting range	Applicable model			Reference (Chapter No.)
			10GH -D	10GH -A	10GH -C	
21	Number of Limitswitch Timer Switches	Set the number of switches appointed as limitswitch timers. <input type="checkbox"/> : Disabled 1 to 30: Enabled The switch outputs from 1 to what is set at the parameter will serve as limitswitch timers. Once the switch outputs are set as limitswitch timers, all the data set for the switch outputs will be cleared.	○	○	○	4-22

●Motion Detection Function parameters

(1/1)

No.	Name	Description and setting range	Applicable model			Reference (Chapter No.)
			10GH -D	10GH -A	10GH -C	
67	Measuring/Motion Recording Selection	The Measuring/Motion Recording is enable when the parameter is set. Select the type of trigger to initiate measuring or motion recording. In measuring, either an external measurement trigger signal of the switch output connector or Parameter 66's "HOLD Clear Threshold" can be selected as a measurement trigger. (Setting value 1 to 4) In motion recording, either a trigger signal of communication or Parameter 66's "Motion Recording Start Position" can be selected as a motion recording trigger. (Setting value 5 to 8)				4-14-2 4-15
		<input type="checkbox"/> : Measuring/Motion Record is disable. 1: Start measurement upon external measurement trigger OFF 2: Start measurement upon external measurement trigger ON 3: HOLD Clear Threshold/Current Position Value increase direction 4: HOLD Clear Threshold/Current Position Value decrease direction 5: Motion Recording position/During traveling in the increase direction 6: Motion Recording position/During traveling in the decrease direction 7: Motion Recording communication and position/During traveling in the increase direction 8: Motion Recording communication and position/During traveling in the decrease direction	○	○	○	
68	Current Position Value/Measuring Value Output Selection	Select whether to use the Current Position Value or the Measuring Value for switch output and current position output.				4-14-3
		<input type="checkbox"/> : Switch output - Measuring Value 1 : Switch output - Current Position Value Set "1" when selecting a value from "5 to 8" at the parameter No.67. <input type="checkbox"/> : Switch output - Measuring Value/ Current position output - Measuring Value 1 : Switch output - Current Position Value/ Current position output - Measuring Value 2 : Switch output - Measuring Value / Current position output - Current Position Value 3 : Switch output - Current Position Value / Current position output - Current Position Value Set "3" when selecting a value from "5 to 8" at the parameter No.67.	○	○	○	
66	HOLD Clear Threshold / Motion Recording Start Position	HOLD Clear Threshold specifies the threshold value to initiate measurement. The current position value will be read as a measuring value when it has remained within the stable width range (Parameter 65) for the duration of the stable time (Parameter 64) after passing the threshold value. Motion Recording Start Position specifies the position to start recording. Setting range: -999999 to 999999 <input type="text" value="0"/>	○	○	○	4-14-4 4-15
65	HOLD Measuring Stable Width	Specify the stable width range to complete a measurement. Setting range: 0 to 999999 <input type="text" value="0"/>	○	○	○	4-14-5
64	HOLD Measuring Stable Time / Motion Recording Sampling Cycle	HOLD Measuring Stable Time specifies the stable time to complete measurement. Motion Recording Sampling Cycle specifies the cycle for sampling. Setting range: 0.001 to 9.999 [s] <input type="text" value="0.001"/>	○	○	○	4-14-6 4-15
63	Sensor Filter	Set the Sensor Filter parameter when the Current Position Value tends to fluctuate, for example due to machine vibration. The displayed Current Position Value will actually be an average of the parameter-specified number of samplings. <input type="checkbox"/> : None 1 : Four samplings 2 : Eight samplings 3 : 16 samplings 4 : 32 samplings 5 : 64 samplings 6 : 128 samplings	○	○	○	4-16
62	HOLD Measuring Completed Output (Approved /Disapproved)	Choose whether or not to approve the switch output 28 signal as the HOLD measuring completed output. <input type="checkbox"/> : Disapproved (Used as Switch output 28) 1: Approved (Used as output HOLD measuring completed output)	○	○	○	4-14-7

●Serial Communication Function Parameters

(1/1)

No.	Name	Description and setting range	Applicable model			Reference (Chapter No.)
			10GH -D	10GH -A	10GH -C	
59	Downloading Enabled Selection	Use this parameter when data needs to be written into VARILIMIT by communication (downloading). 0: Prohibited 1: Permitted The setting will automatically return to "Prohibited" in the following events: - Changing the mode from the parameter setting mode ("PRM") to another mode. - Turning the Power off and then on again.	○	○	○	4-24
58	Baud Rate	Select the communication baud rate. 0: 2400bps 3: 19200bps 1: 4800bps 4: 38400bps 2: 9600bps 5: 57600bps	○	○	○	4-25
56	Node Number	Specify this parameter when "9 (VARIMONI)" is selected at the parameter 54. Specify the node number to VARILIMIT. Setting range: 0 to 15 1	○	○	○	4-27
54	Protocol	Select the communication protocol. 0: NSD 1: MELSEC-A 2: MELSEC 3: OMRON 9: VARIMONI	○	○	○	4-26
53	Device Selection	Use this parameter when "2: MELSEC" is selected at the parameter 54. Selects the device of programmable controller. 0: D (Data register) 1: R (File register)	○	○	○	4-28
52	Device No.	Use this parameter when the following protocol is selected at the parameter 54. - 2: MELSEC - 3: OMRON Specify the first number of selected device. Setting range: 0 to 9000 0	○	○	○	4-29
51	Communication Dog No.	Use this parameter when the following protocol is selected at the parameter 54. - 2: MELSEC - 3: OMRON Specify the last dog number of switch output data which reading by the programmable controller. When Parameter E0 is set to 1 Setting range: 1 to A (1 to 10) 1 When Parameter E0 is set to 2 Setting range: 1 to 4 1	○	○	○	4-30
50 40	Reserved	Do not change these setting values. Irregularities may occur if the initial setting value is changed. 0	○	○	○	—

●Analog Output Function Parameters (CH2)

(1/3)

No.	Name	Description and setting range	Applicable model			Reference (Chapter No.)
			10GH -D	10GH -A	10GH -C	
38	Ch. 2 Maximum Output Position/Speed	<p>●With VS-10GH-A(-1) (voltage output model) Set the position or speed corresponding to the maximum output voltage at Ch. 2.</p> <p>●With VS-10GH-C-1 (current output model) Set the position or speed corresponding to 20mA at Ch. 2.</p> <p>Setting range: -999999 to 999999 <input type="text" value="999999"/></p> <p>Position setting unit: Current Position Value (scale value) Speed setting unit: Current Position Value (scale value)/s</p>		○	○	4-23 4-23-3
37	Ch. 2 Minimum Output Position/Speed	<p>●With VS-10GH-A(-1) (voltage output model) Set the position or speed corresponding to the minimum output voltage at Ch. 2.</p> <p>●With VS-10GH-C-1 (current output model) Set the position or speed corresponding to 4mA at Ch. 2.</p> <p>Setting range: -999999 to 999999 <input type="text" value="-999999"/></p> <p>Position setting unit: Current Position Value (scale value) Speed setting unit: Current Position Value (scale value)/s</p>		○	○	4-23 4-23-3
36	Ch. 2 Output Selection	<p>Choose the output at Ch. 2.</p> <p>●With VS-10GH-A(-1) (voltage output model) <input type="checkbox"/>: Position voltage output 1: Speed voltage output (for monitoring)</p> <p>●With VS-10GH-C-1 (current output model) <input type="checkbox"/>: Position current output 1: Speed current output (for monitoring)</p>		○	○	4-23 4-23-1
35	Ch. 2 Maximum Output Voltage (Vmax)	<p>This parameter applies to VS-10GH-A(-1) (voltage output model) only. Set the maximum output voltage at Ch. 2.</p> <p>Setting range: Vmin to 10.00 [V] <input type="text" value="10.00"/></p>		○		4-23 4-23-2
34	Ch. 2 Minimum Output Voltage (Vmin)	<p>This parameter applies to VS-10GH-A(-1) (voltage output model) only. Set the minimum output voltage at Ch. 2.</p> <p>Setting range: -10.00 to Vmax [V] <input type="text" value="-10.00"/></p>		○		4-23 4-23-2
33	Ch. 2 Deadband Position/Speed	<p>Specify the position (speed) of the deadband at Ch. 2.</p> <p>Setting range: -999999 to 999999 <input type="text" value="0"/></p> <p>Position setting unit: Current Position Value (scale value) Speed setting unit: Current Position Value (scale value)/s</p>		○	○	4-23 4-23-4
32	Ch. 2 Deadband Width	<p>Specify the deadband width range at Ch. 2.</p> <p>Set the range around the deadband position (speed) specified at Parameter 33.</p> <p>Setting range: 0 to 999999 <input type="text" value="0"/></p>		○	○	4-23 4-23-4

●Analog Output Function Parameters (CH1)

(2/3)

No.	Name	Description and setting range	Applicable model			Reference (Chapter No.)
			10GH -D	10GH -A	10GH -C	
30	Ch. 1 Maximum Output Position/Speed	<p>●With VS-10GH-A(-1) (voltage output model) Set the position or speed corresponding to the maximum output voltage at Ch. 1.</p> <p>●With VS-10GH-C-1 (current output model) Set the position or speed corresponding to 20mA at Ch. 1.</p> <p>Setting range: -999999 to 999999 <input type="text" value="999999"/></p> <p>Position setting unit: Current Position Value (scale value) Speed setting unit: Current Position Value (scale value)/s</p>		○	○	4-23 4-23-3
29	Ch. 1 Minimum Output Position/Speed	<p>●With VS-10GH-A(-1) (voltage output model) Set the position or speed corresponding to the minimum output voltage at Ch. 1.</p> <p>●With VS-10GH-C-1 (current output model) Set the position or speed corresponding to 4mA at Ch. 1.</p> <p>Setting range: -999999 to 999999 <input type="text" value="-999999"/></p> <p>Position setting unit: Current Position Value (scale value) Speed setting unit: Current Position Value (scale value)/s</p>		○	○	4-23 4-23-3
28	Ch. 1 Output Selection	<p>Choose the output at Ch. 1.</p> <p>●With VS-10GH-A(-1) (voltage output model) <input type="checkbox"/>: Position voltage output 1: Speed voltage output (for monitoring)</p> <p>●With VS-10GH-C-1 (current output model) <input type="checkbox"/>: Position current output 1: Speed current output (for monitoring)</p>		○	○	4-23 4-23-1
27	Ch. 1 Maximum Output Voltage (Vmax)	<p>This parameter applies to VS-10GH-A(-1) (voltage output model) only. Set the maximum output voltage at Ch. 1.</p> <p>Setting range: Vmin to 10.00 [V] <input type="text" value="10.00"/></p>		○		4-23 4-23-2
26	Ch. 1 Minimum Output Voltage (Vmin)	<p>This parameter applies to VS-10GH-A(-1) (voltage output model) only. Set the minimum output voltage at Ch. 1.</p> <p>Setting range: -10.00 to Vmax [V] <input type="text" value="-10.00"/></p>		○		4-23 4-23-2
25	Ch. 1 Deadband Position/Speed	<p>Specify the position (speed) of the deadband at Ch. 1.</p> <p>Setting range: -999999 to 999999 <input type="text" value="0"/></p> <p>Position setting unit: Current Position Value (scale value) Speed setting unit: Current Position Value (scale value)/s</p>		○	○	4-23 4-23-4
24	Ch. 1 Deadband Width	<p>Specify the deadband width range at Ch. 1.</p> <p>Set the range around the deadband position (speed) specified at Parameter 25.</p> <p>Setting range: 0 to 999999 <input type="text" value="0"/></p>		○	○	4-23 4-23-4

●Analog Output Function Parameters

(3/3)

No.	Name	Description and setting range	Applicable model			Reference (Chapter No.)
			10GH -D	10GH -A	10GH -C	
23	Speed Sampling Time	Specify the time for sampling speeds. Setting range: 0.001 to 9.999 [S] 0.001		<input type="radio"/>	<input type="radio"/>	4-23 4-23-5
22	Number of Speed Gate	Specify the number of speed gates. Setting range: 1 to 99 1		<input type="radio"/>	<input type="radio"/>	4-23 4-23-5

●Multi-Origin Function Parameters

(1/1)

No.	Name	Description and setting range	Applicable model			Reference (Chapter No.)
			10GH -D	10GH -A	10GH -C	
5	Multi-Origin Selection	The common origin is applied to the programs from the top to what is set at this parameter. For each of subsequent programs, an individual origin can be set separately. When Parameter E0 is set to 1 Setting range: 1 to 8 8 When Parameter E0 is set to 2 Setting range: 0 to 31 31	<input type="radio"/>	<input type="radio"/>	<input type="radio"/>	4-19

4-3. Basic Parameter Setting Procedure

① Select the parameter setting mode ("PRM").

Press and hold down the **(MODE)** key (more than 1 second).

The POSITION display will flicker to indicate mode selection is possible.

Press the **(MODE)** key a number of times until the parameter setting mode ("PRM") is shown.

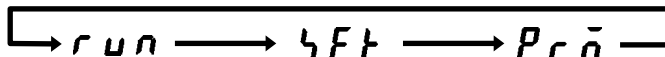
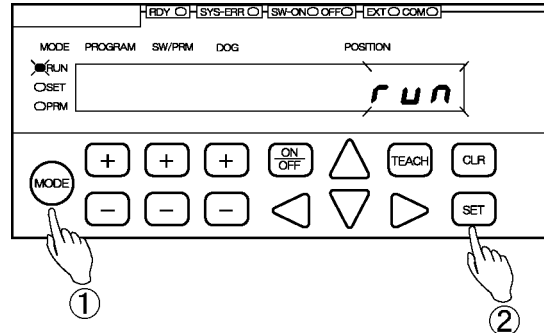

Run mode ("RUN") Switch setting mode ("SET") Parameter setting mode ("PRM")

MODE
 RUN
 SET
 PRM

MODE
 RUN
 SET
 PRM

MODE
 RUN
 SET
 PRM

② Confirm the mode selection

Press the **(SET)** key.

The mode is now set to the parameter setting mode ("PRM").

③ Select the required Parameter Number.

- (+)** : The Parameter Number will increase.
- (-)** : The Parameter Number will decrease

④ Enter the setting value. *1

- (Left/Right)** : Select a digit position in the setting value.
- (Up/Down)** : Enter a figure into the selected digit position.

The entered value can be canceled by pressing the **(CLR)** key at this point.

⑤ Confirm the entered value. *2

Press the **(SET)** key.

The POSITION display will become solidly on, indicating that parameter setting is complete.

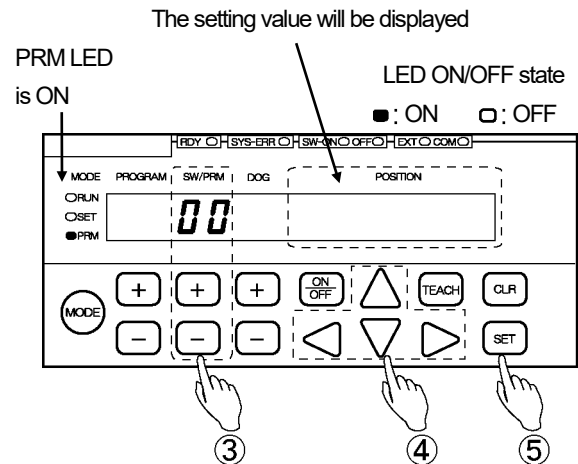

POINT:

*1: Pressing and holding down the **(Up)** or **(Down)** key under the POSITION display will cause the value to be fast-forwarded or fast-reversed.

*2: When setting Parameter A0 (No. of Scale Length Pitches), 99 (Scale Length) or 98 (Minimum Current Position Value):
 Pressing the **(SET)** key once will cause the POSITION display to flicker more quickly. Check the entered value again carefully.
 Complete the setting by pressing the **(SET)** key one more time.

4-4. Setting the Direction of ABSOCODER Rotation (Travel)

This parameter defines the ABSOCODER rotation (travel) direction in which the Current Position Value should increase. The increase direction can be specified in CW and CCW.

Set the parameter in the following steps:

① Select the parameter setting mode ("PRM").

Press and hold down the **MODE** key (more than 1 second).

The POSITION display will flicker to indicate mode selection is possible.

Press the **MODE** key a number of times until the parameter setting mode ("PRM") is shown.

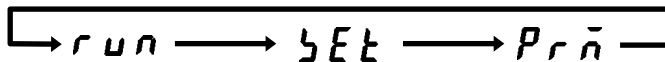
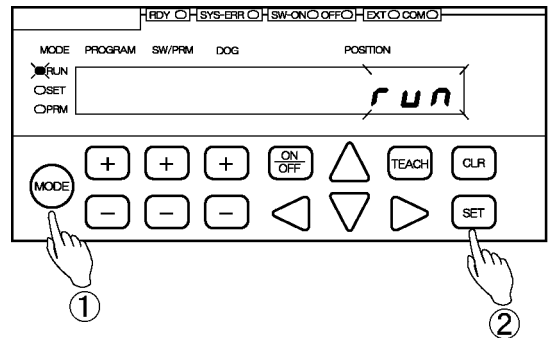

Run mode ("RUN")	Switch setting mode ("SET")	Parameter setting mode ("PRM")
MODE	MODE	MODE
<input checked="" type="checkbox"/> RUN	<input type="checkbox"/> RUN	<input type="checkbox"/> RUN
<input type="checkbox"/> SET	<input checked="" type="checkbox"/> SET	<input type="checkbox"/> SET
<input type="checkbox"/> PRM	<input type="checkbox"/> PRM	<input checked="" type="checkbox"/> PRM

② Confirm the mode selection

Press the **SET** key.

The mode is now set to the parameter setting mode ("PRM").

③ Select Parameter 91.

Use the \oplus and \ominus keys under the SW/PRM display to select "91".

④ Select the direction in which the Current Position Value should increase.

Use the \triangle and ∇ keys under the display to select the Current Position Value increase direction

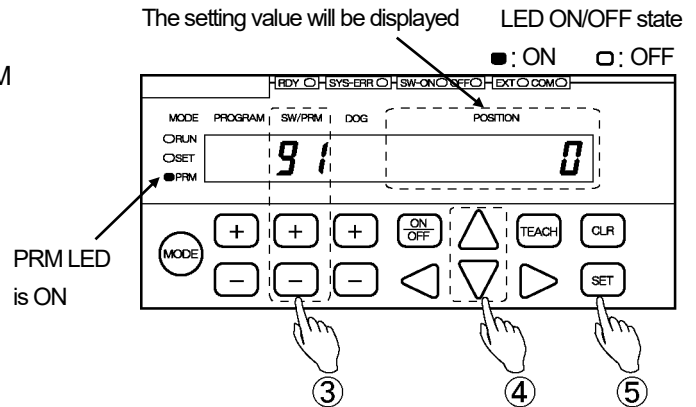

The selected value can be canceled by pressing the CLR key at this point.

Options:

0: CW

1: CCW

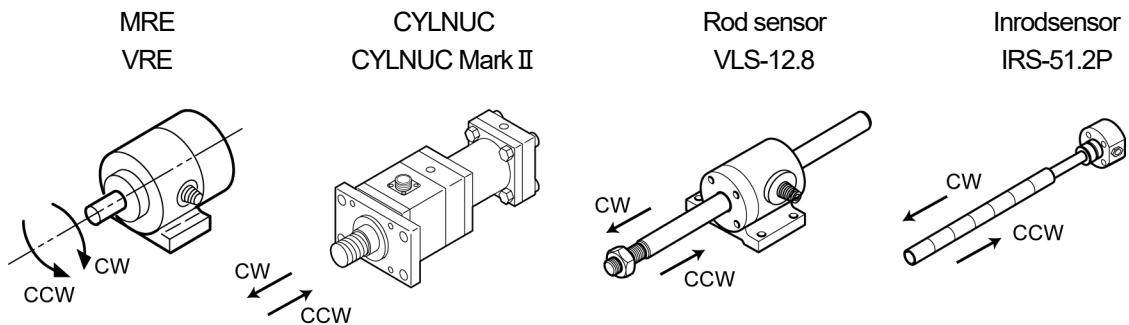

⑤ Confirm the selected value.

Press the SET key.

The POSITION display will become solidly on, indicating that parameter setting is complete.

NOTES

About Parameter 91 (Sensor Selection / Sensor Travel Direction) setting:

1. If the parameter is left unset, a "No Current Position Value Increase Direction Setting" error (Err17) will occur. Make sure to set the parameter once.
2. Once this parameter is changed, Parameter 97 (Current Position Setting) will be in a no-setting status and a "No Current Position Setting" error (Err19) will occur. Record the Current Position Value and carry out the Current Position Setting procedure again.
 For the Current Position Setting details, refer to "4-6-5. Detection Range (Scale) Setting Procedure".

4-5. Decimal Point Position Setting

Define how many decimals should be shown to display the VARILIMIT Current Position Value or other setting values.

Set the parameter in the following steps:

① Select the parameter setting mode ("PRM").

Press and hold down the **(MODE)** key (more than 1 second).

The POSITION display will flicker to indicate mode selection is possible.

Press the **(MODE)** key a number of times until the parameter setting mode ("PRM") is shown.

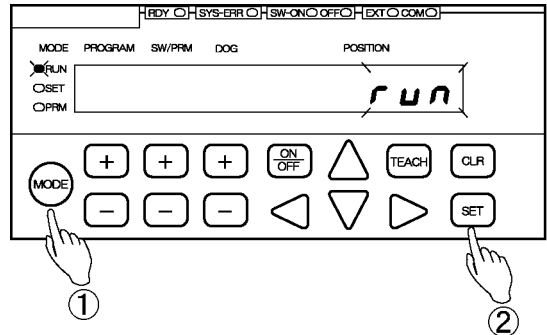

Run mode ("RUN")	Switch setting mode ("SET")	Parameter setting mode ("PRM")
MODE	MODE	MODE
<input checked="" type="checkbox"/> RUN	<input type="checkbox"/> RUN	<input type="checkbox"/> RUN
<input type="checkbox"/> SET	<input checked="" type="checkbox"/> SET	<input type="checkbox"/> SET
<input type="checkbox"/> PRM	<input type="checkbox"/> PRM	<input checked="" type="checkbox"/> PRM

② Confirm the mode selection

Press the **(SET)** key.

The mode is now set to the parameter setting mode ("PRM").

③ Select Parameter 90.

Use the **(+)** and **(-)** keys under the SW/PRM display to select "90".

④ Select the Decimal Point Position (number of decimals to be shown).

Use the **(◀)** and **(▶)** keys under the POSITION display to specify how many decimals should be shown.

The selected value can be canceled by pressing the **(CLR)** key at this point.

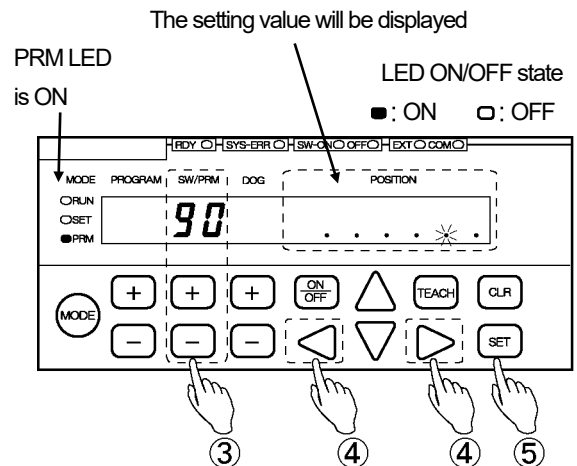

⑤ Confirm the Decimal Point Position setting.

Press the **(SET)** key.

The POSITION display will become solidly on, indicating that parameter setting is complete.

4-6. Detection Range ("Scale") Setting

"Detection range (= scale) setting" refers to defining the ABSOCODER detection range as appropriate for the subject machine.

The following four parameters need to be set to define the detection range.

1. Parameter 99 (Scale Length, [L])

The Scale Length is the longest distance that the ABSOCODER sensor will be able to detect in an absolute format. Set the Scale Length in a unit of length (millimeter, inch) appropriate for the amounts of machine travel involved.

2. Parameter A0 (Number of Scale Length Pitches, [n])

With the CYLNUC Cylinder, rod sensor, and Inrodsensor, position detection will be done in a semi-absolute format. In this format, the pitch of absolute detection will be used as the "standard pitch" by having the software count the number of pitches.

The Number of Scale Length Pitches, [n], should be set to the number of standard pitches contained in the Scale Length [L].

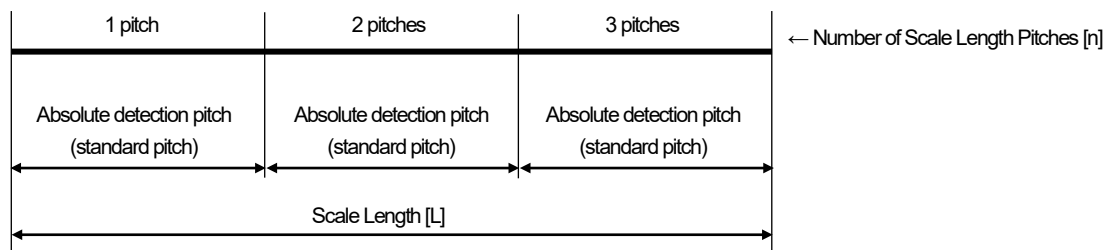

3. Parameter 98 (Minimum Current Position Value, [K])

The Minimum Current Position Value is the smallest possible position value which is detected by ABSOCODER sensor (it can be a value below zero).

This will be the smallest possible Current Position Value that can be shown on the VARILIMIT.

4. Parameter 97 (Current Position Setting)

The Current Position Value is a value that represents where in the detection range the machine is currently located. Once the above all three parameters are set, the Current Position Value can be separately entered.

NOTES

1. The following three parameters cannot be set separately. Be sure to set them together, in the order of ① before ③. If separate setting is attempted, a "No Setting" error will occur (Err 29 to 33).

- ① Parameter A0 (Number of Scale Length Pitches, [n])
- ② Parameter 99 (Scale Length)
- ③ Parameter 98 (Minimum Current Position Value)

2. Once the above three parameters are changed, Parameter 97 (Current Position Setting) will be in a no-setting status and a "No Current Position Setting" error (Err 19) will occur.

If the pre-change Current Position Value needs to be saved, record the Current Position Value and repeat the Detection Range setting procedure again.

3. Switch Output and other parameter setting values

Even after the above three parameters are changed, switch output and other parameter settings will remain as they were before the change.

If necessary, re-enter the switch output and other necessary parameter settings as appropriate for the new detection range.

4-6-1. Multi-turn type ABSOCODER (MRE) setting description

① Scale Length, [L] (Parameter 99)

The required Scale Length is determined based on the ABSOCODER's (MRE's) total number of turns and the travel amount per rotation, which depends on the machine.

● If set in millimeters:

Example: If a 32-turn MRE-32SP101 is used and the amount of machine travel per revolution is 10 mm, the detection range will be 320 mm.

$$\begin{aligned} \text{Detection range} &= \text{Total number of turns} \times \text{amount of travel per revolution} \\ &= 32 \times 10 = 320 \text{ mm} \end{aligned}$$

The Scale Length [L] should be set as follows according to the resolution:

- With a 1 mm resolution: "320"
- With a 0.1 mm resolution: "320.0".

Set the number of decimals to be shown using Parameter 90 (Decimal Point Position).

● If set in inches:

The detection range value in millimeters should be converted into inches.

Example: Scale Length [L] should be as follows:

$$\text{Scale Length [L]} = 320 \div 25.4 = 12.598$$

The Scale Length value should be set "12.598".

Set the number of decimals to be shown using Parameter 90 (Decimal Point Position).

② Minimum Current Position Value, [K] (Parameter 98)

The Minimum Current Position Value is the smallest possible position value which is detected by ABSOCODER sensor (it can be a value below zero).

The valid indication range will be determined according to the Scale Length and the Minimum Current Position Value settings.

$$\text{Indication range} = [\text{Minimum Current Position Value}] \text{ to } (\text{Minimum Current Position Value} + \text{Scale Length} - 1)$$

③ Current Position Setting (Parameter 97)

Enter a value to represent where the machine is currently located.

Once ① and ② are set, the Current Position Setting can be separately entered.

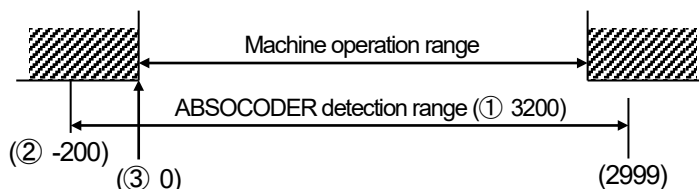

① Scale Length [L] : 3200

Define the total length of the "ruler".

② Minimum Current Position Value [K] : -200

Define the ruler's indication range.

③ Current Position Setting : 0

Set the value so that the VARILIMIT's Current Position Value display matches the actual machine position.

4-6-2. Single-turn type ABSOCODER (VRE) setting description

① Scale Length, [L] (Parameter 99)

If shown in degrees ($^{\circ}$), the Scale Length is 360.

When using VRE-P[], Scale Length should be set "360.0" because the resolution can be set to the first decimal place.

When using VRE-16TS100, Scale Length should be set "360.00" because the resolution can be set to the second decimal place.

Set the number of decimals to be shown using Parameter 90 (Decimal Point Position).

② Minimum Current Position Value, [K] (Parameter 98)

The Minimum Current Position Value is the smallest possible position value which is detected by ABSOCODER sensor (it can be a value below zero).

The detection range will be determined according to the Scale Length and the Minimum Current Position Value settings.

Detection range = [Minimum Current Position Value] to (Minimum Current Position Value + Scale Length - 1)

③ Current Position Setting (Parameter 97)

Enter a value to represent where the machine is currently located.

Once ① and ② are set, the Current Position Setting can be separately entered.

● Setting example:

For a Current Position Value indication range of 0.0° to 359.9° :

① Scale Length, [L]: 360.0

② Minimum Current Position Value, [K]: 0.0

Decimal Point Position: 1 (0.1-degree resolution)

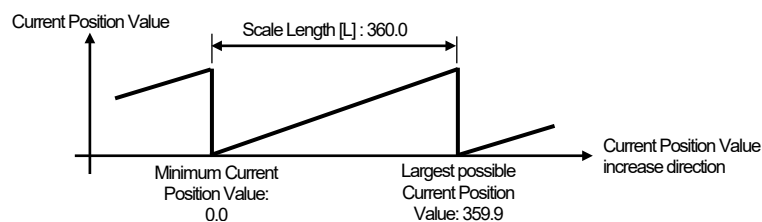

For a Current Position Value indication range of -180.0° to 179.9° :

① Scale Length, [L]: 360.0

② Minimum Current Position Value, [K]: -180.0

Decimal Point Position: 1 (0.1-degree resolution)

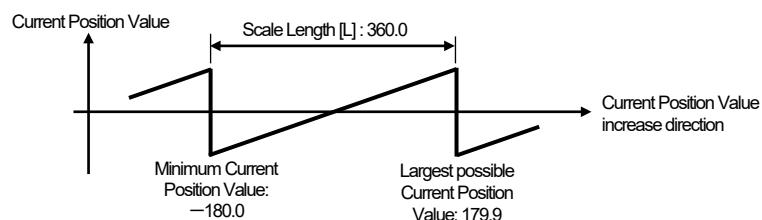

4-6-3. CYLNUC/Rod sensor (VLS-12.8) setting description

The required detection range settings depend on the rod sensor model being used. Define the detection range by setting the following parameters.

● Detection range setting values

Parameter No.	Name	Setting value
		VLS-12.8PRA28-50-LAB5
A0	Number of Scale Length Pitches [n]	4
99	Scale Length [L]	51.2
90	Decimal Point Position	1: □□□□. □

● Example of detection range calculation

Shown below is the example of VLS-12.8PRA28-50-LAB5.

① Parameter A0 (Number of Scale Length Pitches, [n])

Enter the number of pitches to be detected by your ABSOCODER model.

In the case of VLS-12.8PRA28-50-LAB5, the absolute detection pitch (= standard pitch) is 12.8mm and the maximum stroke is 50 mm.

The No. of Scale Length Pitches, [n], can be determined by the following equation.

$$\text{No. of Scale Length Pitches [n]} = \frac{\text{Maximum stroke}}{\text{Absolute detection pitch}} \quad n = \frac{50}{12.8} = 3.9 \text{ pitches}$$

As the No. of Scale Length Pitches [n] must be set as a whole number, the nearest whole number larger than 3.9, or 4, should be selected.

② Parameter 99 (Scale Length, [L])

The Scale Length, [L], can be determined by the following equation:

$$\begin{aligned} \text{Scale Length [L]} &= [\text{Absolute detection pitch}] \times [\text{No. of Scale Length Pitches}] \\ &= 12.8\text{mm} \times 4 \\ &= 51.2 \end{aligned}$$

③ Parameter 90 (Decimal Point Position)

This parameter should be set depending on the Scale Length ([L]) value obtained.

As the Scale Length value in this example has one digit after the decimal point, the Decimal Point Position should be set to "1".

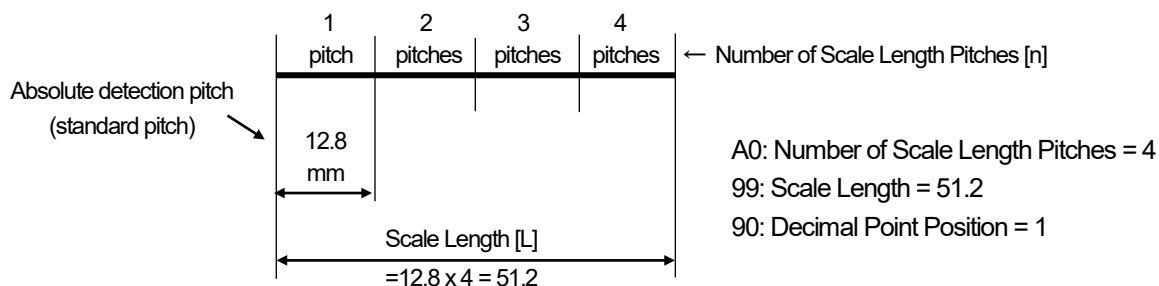

4-6-4. CYLNUC Mark II / Inroadsensor (IRS-51.2P) setting description

The required detection range settings depend on the Inroadsensor model being used. Define the detection range by setting the following parameters.

● Detection range setting values

Parameter No.	Name	Setting value
		IRS-51.2P18D128P0PAB5
A0	Number of Scale Length Pitches [n]	3
99	Scale Length [L]	153.6
90	Decimal Point Position	1: □□□□. □

● Example of detection range calculation

Shown below is the example of IRS-51.2P18D128P0PAB5.

① Parameter A0 (Number of Scale Length Pitches, [n])

Enter the number of pitches to be detected by your ABSOCODER model.

In the case of IRS-51.2P18D128P0PAB5, the absolute detection pitch (= standard pitch) is 51.2mm and the maximum stroke is 128 mm.

The No. of Scale Length Pitches, [n], can be determined by the following equation.

$$\text{No. of Scale Length Pitches [n]} = \frac{\text{Maximum stroke}}{\text{Absolute detection pitch}} \quad n = \frac{128}{51.2} = 2.5 \text{ pitches}$$

As the No. of Scale Length Pitches [n] must be set as a whole number, the nearest whole number larger than 2.5, or 3, should be selected.

② Parameter 99 (Scale Length, [L])

The Scale Length, [L], can be determined by the following equation:

$$\begin{aligned} \text{Scale Length [L]} &= [\text{Absolute detection pitch}] \times [\text{No. of Scale Length Pitches}] \\ &= 51.2\text{mm} \times 3 \\ &= 153.6 \end{aligned}$$

③ Parameter 90 (Decimal Point Position)

This parameter should be set depending on the Scale Length ([L]) value obtained.

As the Scale Length value in this example has one digit after the decimal point, the Decimal Point Position should be set to "1".

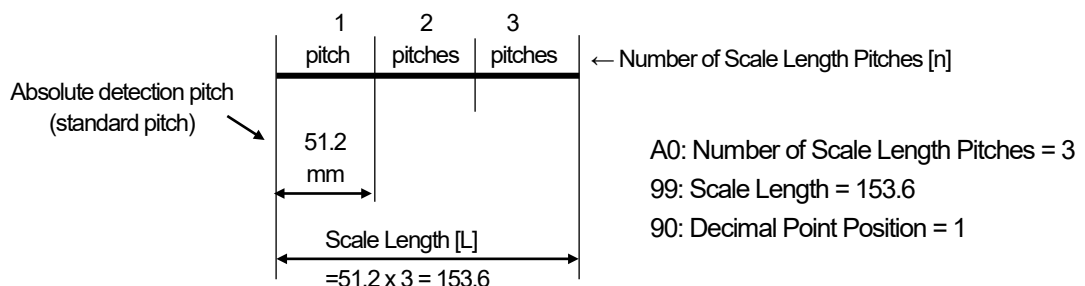

4-6-5. Detection range ("scale") setting procedure

(1) Parameter setting mode ("PRM") selection

① Select the parameter setting mode ("PRM").

Press and hold down the **MODE** key (more than 1 second).

The POSITION display will flicker to indicate mode selection is possible.

Press the **MODE** key a number of times until the parameter setting mode ("PRM") is shown.

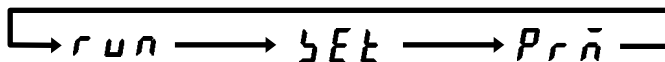
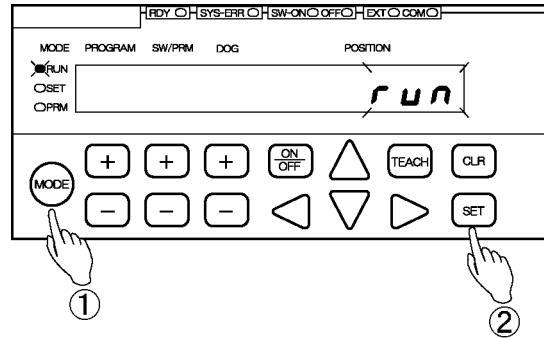

Run mode ("RUN")	Switch setting mode ("SET")	Parameter setting mode ("PRM")
MODE	MODE	MODE
<input checked="" type="checkbox"/> RUN	<input type="checkbox"/> RUN	<input type="checkbox"/> RUN
<input type="checkbox"/> SET	<input checked="" type="checkbox"/> SET	<input type="checkbox"/> SET
<input type="checkbox"/> PRM	<input type="checkbox"/> PRM	<input checked="" type="checkbox"/> PRM

② Confirm the mode selection

Press the **SET** key.

The mode is now set to the parameter setting mode ("PRM").

(2) Setting the No. of Scale Length Pitches

① Select Parameter A0.

Use the **+** and **-** keys under the SW/PRM display to select "A0".

② Enter the setting value.

Use the **<**, **>**, **▲** and **▼** keys under the POSITION display to enter the setting value.

The entered value can be canceled by pressing the **CLR** key at this point.

③ Check the entered value.

Press the **SET** key.

The POSITION display will flicker more quickly.

Check the entered value again carefully.

④ Confirm the entered value.

Press the **SET** key again.

The POSITION display will become solidly on, indicating that the setting value has been confirmed.

POINT:

The setting of the number of the scale length pitches applies to VS-10GH**-LC only.

No setting is required for the other models.

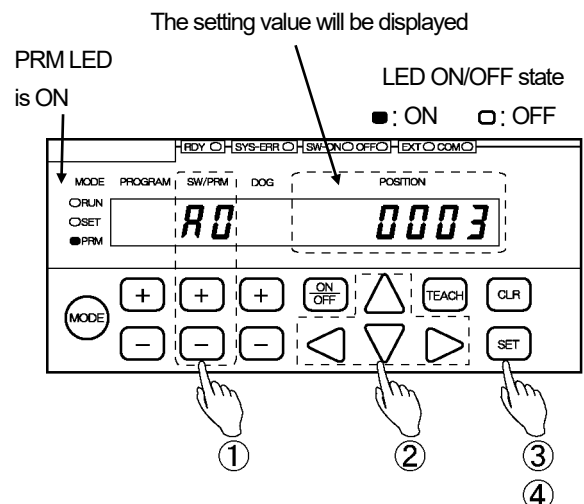

(3) Scale Length setting

① Select Parameter 99.

Use the **[+]** and **[-]** keys under the SW/PRM display to select "99".

② Enter the setting value.

Use the **[<]**, **[>]**, **[△]** and **[▽]** keys under the POSITION display to enter the setting value.

The entered value can be canceled by pressing the **[CLR]** key at this point.

③ Check the entered value.

Press the **[SET]** key.
The POSITION display will flicker more quickly.
Check the entered value again carefully.

④ Confirm the entered value.

Press the **[SET]** key again.
The POSITION display will become solidly on, indicating that the setting value has been confirmed.

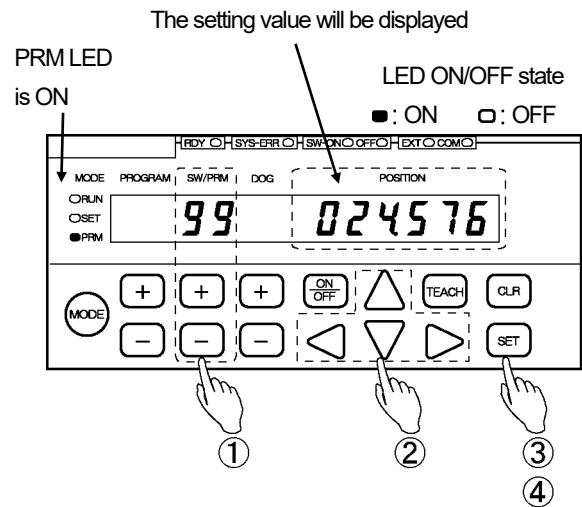

POINT:

As changing this parameter will nullify other parameter settings, the **[SET]** key is required to be pressed twice to urge caution.

(4) Minimum Current Position Value setting

① Select Parameter 98.

Use the **[+]** and **[-]** keys under the SW/PRM display to select "98".

② Enter the setting value.

Use the **[<]**, **[>]**, **[△]** and **[▽]** keys under the POSITION display to enter the setting value.

The entered value can be canceled by pressing the **[CLR]** key at this point.

③ Check the entered value.

Press the **[SET]** key.
The POSITION display will flicker more quickly.
Check the entered value again carefully.

④ Confirm the entered value.

Press the **[SET]** key again.
The POSITION display will become solidly on, indicating that the setting value has been confirmed.

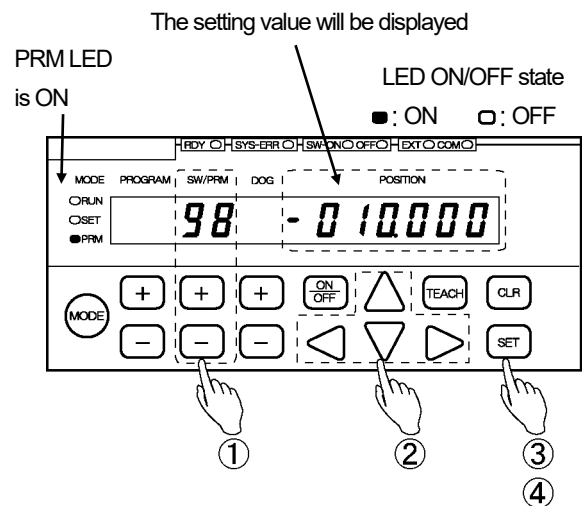

(5) Current Position Value setting

① Select Parameter 97.

Use the **+** and **-** keys under the SW/PRM display to select "97".

② Enter the setting value.

Use the **◀**, **▶**, **▲** and **▼** keys under the POSITION display to enter the setting value.

The entered value can be canceled by pressing the **CLR** key at this point.

③ Confirm the entered value.

Press the **SET** key.

The POSITION display becomes solidly on, indicating that parameter setting is complete.

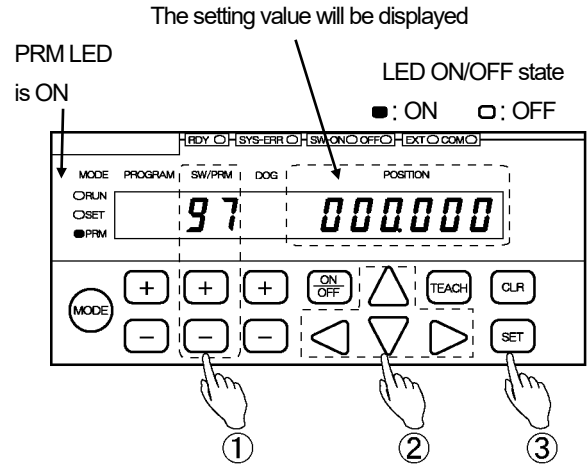

NOTES

1. If selection of the Run mode is attempted without setting Parameter 97, a "No Current Position Setting" error (Err19) will occur.
2. Parameter 97 cannot be set without setting Parameters 91, 98, 99 and A0 first.

4-7. Current Position Preset Setting

Specify the required settings to use the Current Position Preset by Auto-detecting Travel Direction function.

The Current Position Preset by Auto-detecting Travel Direction function refers to correcting a current position value to a predetermined value by way of external input (current position preset) when a gap is found between the actual machine position and the VARILIMIT's current position display value.

Two Current Position Preset Values, one forward and one reverse, can be set, and the travel direction will be automatically determined based on the Current Position Value variation inside the VARILIMIT.

The Current Position Preset activates at the signal leading edge, when the input state changes from OFF to ON. For more details about Current Position Preset input/output timing, refer to "2-6-3. Current position preset timing".

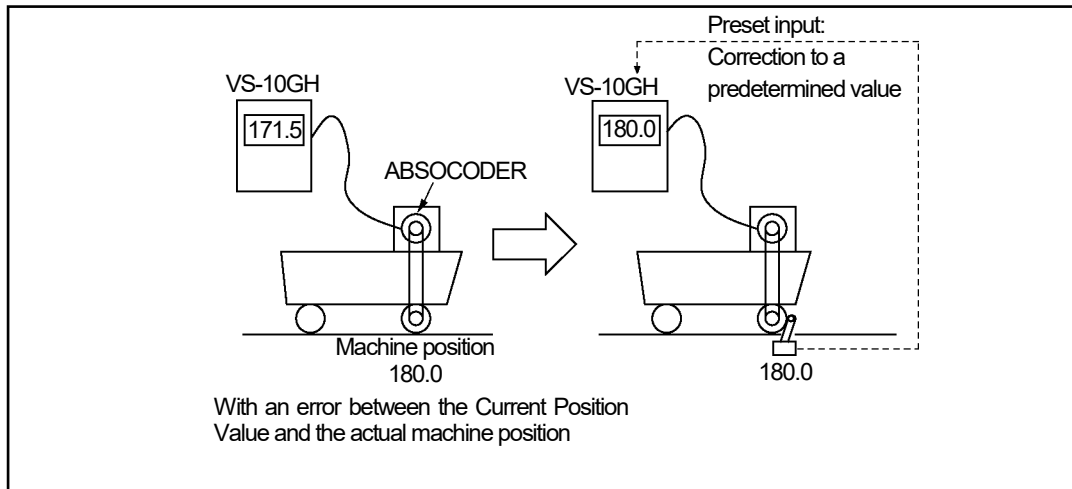

The automatic travel direction determination by VARILIMIT is made by successively comparing the Current Position Values at a 100 ms interval.

However, if the reverse speed is below the levels shown below, the VARILIMIT will determine that the current travel is in forward direction.

Turn-type ABSOCODER	Speed(r/min)
MRE-32SP	0.44
MRE-G64SP	0.88
MRE-G128SP	1.76
MRE-G160SP	2.20
MRE-G256SP	3.52
MRE-G320SP	4.40
MRE-G512SP	7.03
MRE-G1280SP	17.58
MRE-G2048SP	28.13
MRE-G2560SP	35.16
VRE-P	0.22
VRE-16TS100	0.03

CYLNUC/Rod sensor	Speed(r/min)
SCM, SCJ, SCMJ, SCJJ, SCHH, SCAH, CSAH VLS-12.8	0.05

Inrodsensor	Speed(r/min)
M I I M, M I I J, M I I M J, M I I J J IRS-51.2P	0.19

**NOTES**

1. The Current Position Value will not be changed if the Current Position Preset input is already on at the time of power on.
2. When the current position preset input 1 or 2 is turned on while the machine is stopped, the current position value will be changed to the forward-direction preset value.
When the current position preset input 1 is turned on, should be changed to the Parameter 7 (FWD Current Position Preset" Value 1) value.
When the current position preset input 2 is turned on, should be changed to the Parameter 10 (FWD Current Position Preset" Value 2) value.

The following five parameters are provided in relation to the Current Position Preset function.

1. Parameter 92 (Current Position Preset Function Selection)
2. Parameter 82 (Current Position Preset Error Selection)
3. Parameter 7, 10 ("FWD Current Position Preset" Value 1, 2)
4. Parameter 6, 9 ("RVS Current Position Preset" Value 1, 2)
5. Parameter 8, 11 (Permissible Correction Amount 1, 2)

POINT:

1. Parameters 8 and 11 specify the threshold values to monitor the amount of current position value correction. Set the parameters as required.
2. Parameter 82 changes the switch output 30 signal to the preset error output signal. Set the parameter as required.
3. The Current Position Preset function stores two setting values. One value can be set by the combined use of Parameters 92, 82, 7, 6, 8 and the other can be set by the combined use of Parameters 92, 82, 10, 9, 11.

The following steps (1)-(6) describe an example of the former combination.

(1) Parameter setting mode ("PRM") selection

① Select the parameter setting mode ("PRM").

Press and hold down the **(MODE)** key (more than 1 second).

The POSITION display will flicker to indicate mode selection is possible.

Press the **(MODE)** key a number of times until the parameter setting mode ("PRM") is shown.

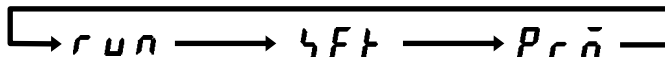
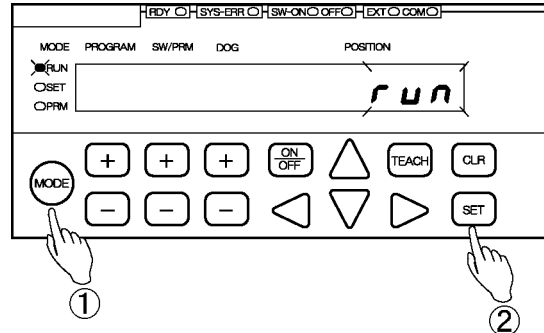

Run mode ("RUN") Switch setting mode ("SET") Parameter setting mode ("PRM")

MODE
 RUN
 SET
 PRM

MODE
 RUN
 SET
 PRM

MODE
 RUN
 SET
 PRM

② Confirm the mode selection

Press the **(SET)** key.

The mode is now set to the parameter setting mode ("PRM").

(2) Selection to enable/disable the Current Position Preset function

① Select Parameter 92.

Use the **(+)** and **(-)** keys under the SW/PRM display to select "92".

② Select the setting value.

Use the **(Δ)** and **(▽)** keys under the POSITION display to select the setting value.

Options:

0: Preset Disabled

1: Preset Enabled

The selected value can be canceled by pressing the **(CLR)** key at this point.

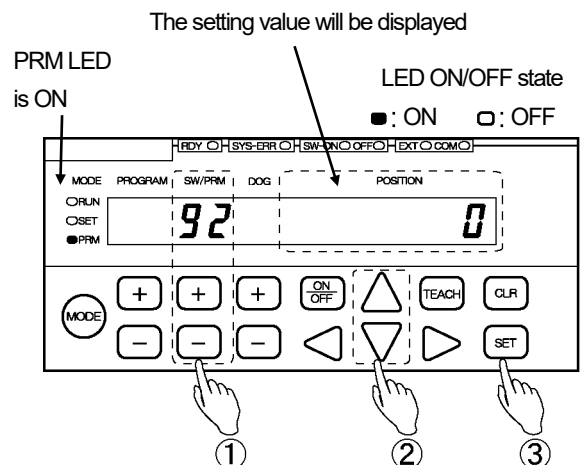

③ Confirm the selected value.

Press the **(SET)** key.

The POSITION display will become solidly on, indicating that parameter setting is complete.

(3) FWD Current Position Preset Value setting

① Select Parameter 7 (10).

Use the **+** and **-** keys under the SW/PRM display to select "7 (10)".

② Enter the setting value.

Use the **◀**, **▶**, **▲** and **▼** keys under the POSITION display to enter the setting value.

Setting range:

-999999 to 999999

The entered value can be canceled by pressing the **CLR** key at this point.

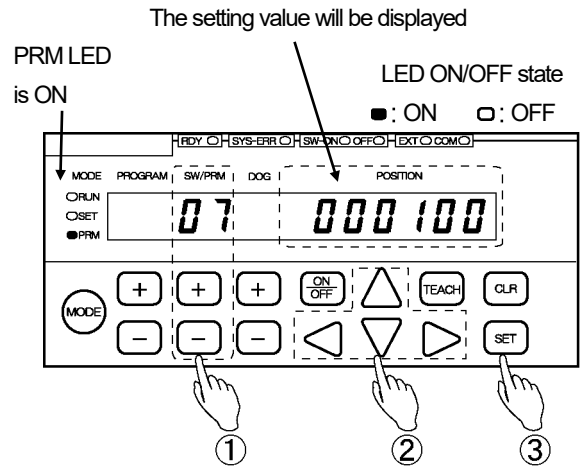

③ Confirm the entered value.

Press the **SET** key.

The POSITION display becomes solidly on, indicating that parameter setting is complete.

(4) RVS Current Position Preset Value setting

① Select Parameter 6 (9).

Use the **+** and **-** keys under the SW/PRM display to select "6 (9)".

② Enter the setting value.

Use the **◀**, **▶**, **▲** and **▼** keys under the POSITION display to enter the setting value.

Setting range:

-999999 to 999999

The entered value can be canceled by pressing the **CLR** key at this point.

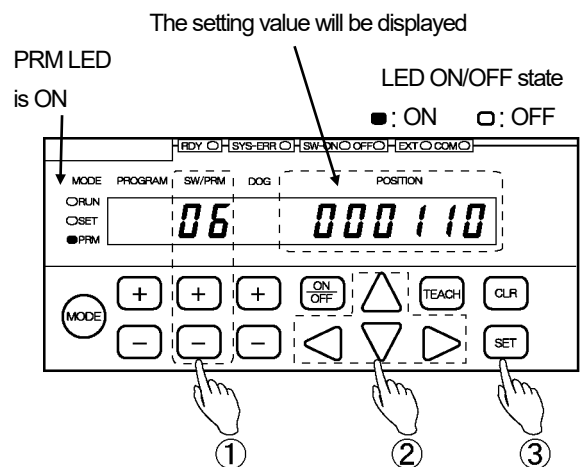

③ Confirm the entered value.

Press the **SET** key.

The POSITION display becomes solidly on, indicating that parameter setting is complete.

(5) Permissible Correction Amount setting

POINT:

Parameters 8 and 11 specify the threshold values to monitor the amount of current position value correction. Set the parameters as required.

① Select Parameter 8 (11).

Use the **[+]** and **[-]** keys under the SW/PRM display to select "8 (11)".

② Enter the setting value.

Use the **[<]**, **[>]**, **[▲]** and **[▼]** keys under the POSITION display to enter the setting value.

Setting range:

-999999 to 999999

The entered value can be canceled by pressing the **[CLR]** key at this point.

③ Confirm the entered value.

Press the **[SET]** key.

The POSITION display becomes solidly on, indicating that parameter setting is complete.

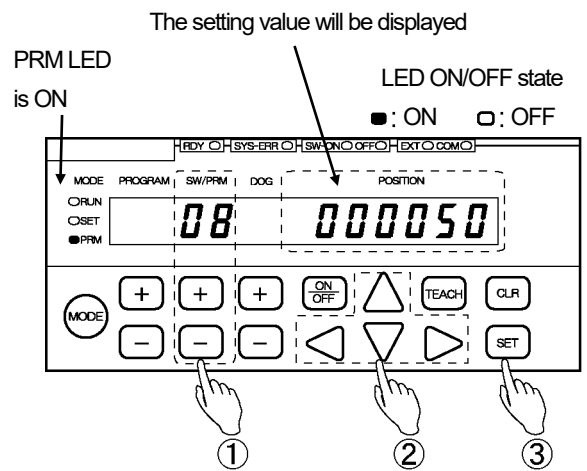

(6) Current Position Preset Error Selection setting

POINT:

Parameter 82 changes the switch output 30 signal to the preset error output signal.
Set the parameter as required.

The preset error output signals will be ON when the Preset Error (Err23) or the Preset Data Error (Err50) occurs.

① Select Parameter 82.

Use the **+** and **-** keys under the SW/PRM display to select "82".

② Select the setting value.

Use the **△** and **▽** keys under the POSITION display to select the setting value.

Options:

□: Disabled

SW30: Switch output, System ready output ON in case of errors, No error display

1: Enabled

SW30: Error output, System ready output ON in case of errors, No error display

2: Enabled

SW30: Switch output, System ready output OFF in case of errors, Error display ([Err23 or Err50])

3: Enabled

SW30: Error output, System ready output OFF in case of errors, Error display ([Err23 or Err50])

The selected value can be canceled by pressing the **CLR** key at this point.

③ Confirm the selected value.

Press the **SET** key.

The POSITION display will become solidly on, indicating that parameter setting is complete.

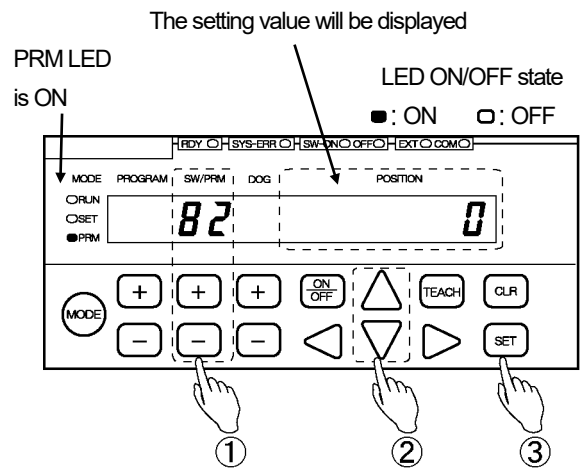

4-8. Program Number Input Method Selection

Select the method to input program numbers to run.

To input the Program Numbers through the program No. I/O connector, refer to "2-6-2. Program Number Change Timing".

To select Program Numbers via serial communication, consult our sales representative.

NOTES

If Parameter 54 for serial communication ("Protocol") is set to "2" or "3", Parameter 93 (Program Number Input Format) will be invalid and the Program Number will be fixed to "0".

Set the parameter in the following steps.

① Select the parameter setting mode ("PRM").

Press and hold down the **MODE** key (more than 1 second).

The POSITION display will flicker to indicate mode selection is possible.

Press the **MODE** key a number of times until the parameter setting mode ("PRM") is shown.

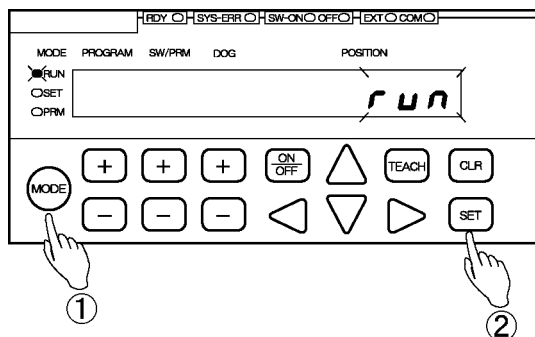

Run mode ("RUN")	Switch setting mode ("SET")	Parameter setting mode ("PRM")
MODE	MODE	MODE
<input checked="" type="checkbox"/> RUN	<input type="checkbox"/> RUN	<input type="checkbox"/> RUN
<input type="checkbox"/> SET	<input checked="" type="checkbox"/> SET	<input type="checkbox"/> SET
<input type="checkbox"/> PRM	<input type="checkbox"/> PRM	<input checked="" type="checkbox"/> PRM

② Confirm the mode selection

Press the **SET** key.

The mode is now set to the parameter setting mode ("PRM").

③ Select Parameter 93.

Use the **+** and **-** keys under the SW/PRM display to select "93".

④ Select the setting value.

Use the **△** and **▽** keys under the POSITION display to select the setting value.

Options:

- 0: Panel key input
- 1: External input via connector
- 2: Serial communication

The selected value can be canceled by pressing the **CLR** key at this point.

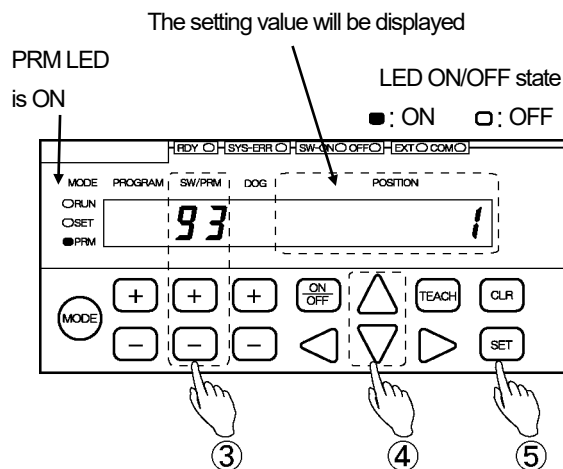

⑤ Confirm the selected value.

Press the **SET** key.

The POSITION display will become solidly on, indicating that parameter setting is complete.

4-9. Setting the Number of Protected Switches

The Protected Switch function makes the specified switch output settings not enterable or changeable by regular steps.

All the switches from Switch 1 through to the selected switch number will be controlled as Protected Switches. If this parameter is set to "0", there will be no Protected Switches.

Set the parameter in the following steps.

① Select the parameter setting mode ("PRM").

Press and hold down the **(MODE)** key (more than 1 second).

The POSITION display will flicker to indicate mode selection is possible.

Press the **(MODE)** key a number of times until the parameter setting mode ("PRM") is shown.

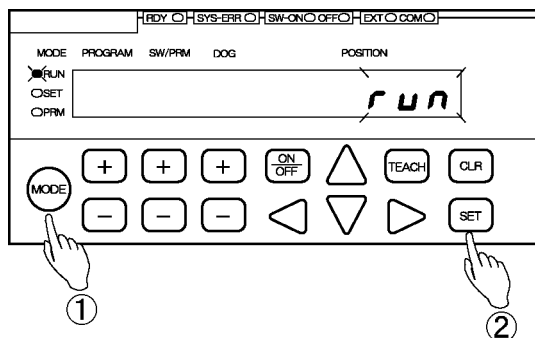

Run mode ("RUN")	Switch setting mode ("SET")	Parameter setting mode ("PRM")
MODE	MODE	MODE
<input checked="" type="checkbox"/> RUN	<input type="checkbox"/> RUN	<input type="checkbox"/> RUN
<input type="checkbox"/> SET	<input checked="" type="checkbox"/> SET	<input type="checkbox"/> SET
<input type="checkbox"/> PRM	<input type="checkbox"/> PRM	<input checked="" type="checkbox"/> PRM

② Confirm the mode selection

Press the **(SET)** key.

The mode is now set to the parameter setting mode ("PRM").

③ Select Parameter 20.

Use the **(+)** and **(-)** keys under the SW/PRM display to select "21" or "19".

To shift to "20", press the **(+)** or **(-)** key under the SW/PRM display while pressing the **(ON/OFF)** key.

④ Enter the setting value.

Use the **(<)**, **(>)**, **(△)** and **(▽)** keys under the POSITION display to enter the setting value.

Setting range: 0 to 30

Switch outputs 1 to what is set at the parameter will serve as protected switches.

The entered value can be canceled by pressing the **(CLR)** key at this point.

⑤ Confirm the entered value.

Press the **(SET)** key.

The POSITION display becomes solidly on, indicating that parameter setting is complete.

POINT:

To shift to Parameter 20 from 21, press the **(-)** key under the SW/PRM display while holding down the **(ON/OFF)** key.

To shift to Parameter 20 from 19, press the **(+)** key under the SW/PRM display while holding down the **(ON/OFF)** key.

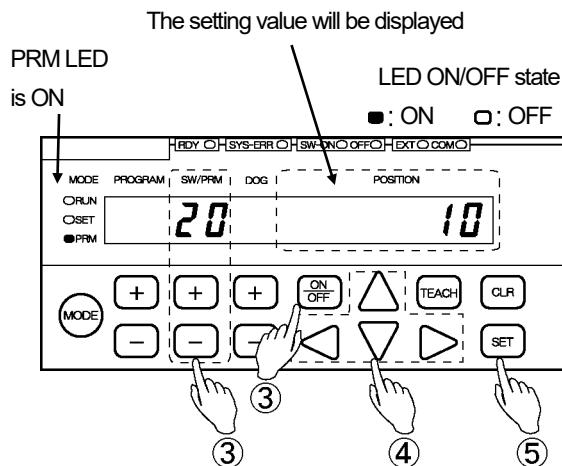

4-10. Protected Switch Suspended Setting

This parameter can be suspended the Protected Switch setting, which is entered by the steps described in 4-9, "Setting the Number of Protected Switches".

The setting will automatically return to "Enabled" when one of the following actions has been taken.

- Changing the mode to the Run mode ("RUN").
- Turning the power off and then on again.

Temporarily cancel the Protected Switch setting in the following steps:

① Select the parameter setting mode ("PRM").

Press and hold down the **MODE** key (more than 1 second).

The POSITION display will flicker to indicate mode selection is possible.

Press the **MODE** key a number of times until the parameter setting mode ("PRM") is shown.

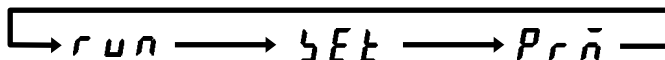
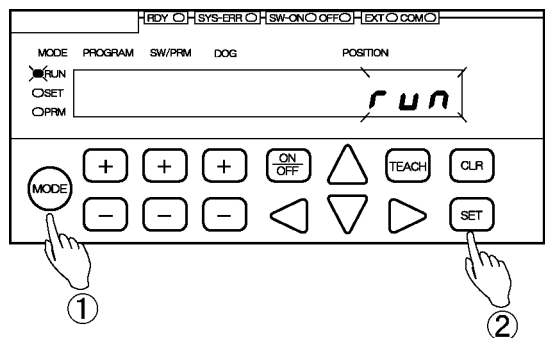

Run mode ("RUN")	Switch setting mode ("SET")	Parameter setting mode ("PRM")
MODE	MODE	MODE
<input checked="" type="checkbox"/> RUN	<input type="checkbox"/> RUN	<input type="checkbox"/> RUN
<input type="checkbox"/> SET	<input checked="" type="checkbox"/> SET	<input type="checkbox"/> SET
<input type="checkbox"/> PRM	<input type="checkbox"/> PRM	<input checked="" type="checkbox"/> PRM

② Confirm the mode selection

Press the **SET** key.
The mode is now set to the parameter setting mode ("PRM").

③ Select Parameter 96.

Use the **+** and **-** keys under the SW/PRM display to select "96".

④ Change the setting value to "1".

Press the **△** key under the POSITION display to change the setting value to "1".

The selected value can be canceled by pressing the **CLR** key at this point.

⑤ Confirm the selected value.

Press the **SET** key.
The POSITION display will become solidly on, indicating that parameter setting is complete.

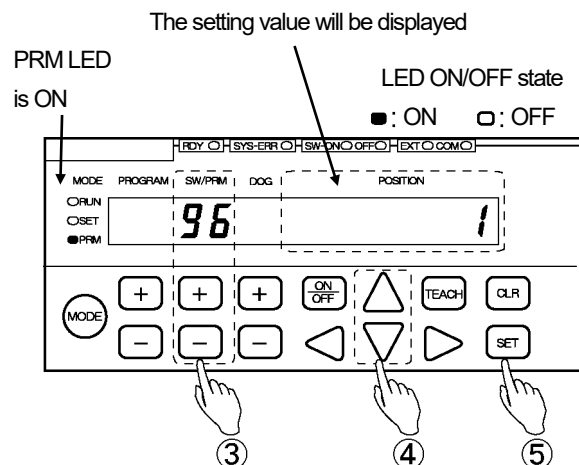

4-11. Motion Detection Direction and Speed Setting

"Motion Detection" refers to a function where a Motion Detection output will come on when the machine travels in the predetermined direction and above the predetermined travel speed. Set the detection direction and speed in the following steps.

While the Motion Detection Output is issued based on 10 ms-interval speed calculation, the travel speed is determined by continually comparing the Current Position Value with that of 100 ms before.

Select either of the setting values 1-3 to activate the Motion Detection function. The switch output 29 signals will serve as the motion detection output signals.

(1) Motion Detection direction setting

① Select the parameter setting mode ("PRM").

Press and hold down the **MODE** key (more than 1 second).

The POSITION display will flicker to indicate mode selection is possible.

Press the **MODE** key a number of times until the parameter setting mode ("PRM") is shown.

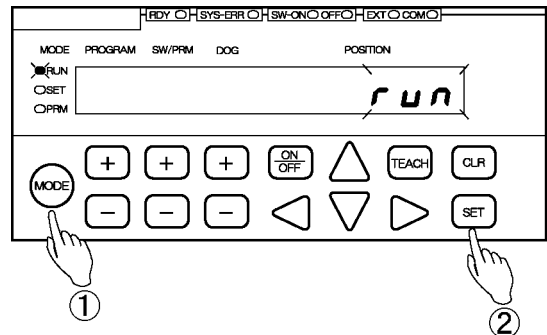

Run mode ("RUN")	Switch setting mode ("SET")	Parameter setting mode ("PRM")
MODE	MODE	MODE
<input checked="" type="checkbox"/> RUN	<input type="checkbox"/> RUN	<input type="checkbox"/> RUN
<input type="checkbox"/> SET	<input checked="" type="checkbox"/> SET	<input type="checkbox"/> SET
<input type="checkbox"/> PRM	<input type="checkbox"/> PRM	<input checked="" type="checkbox"/> PRM

② Confirm the mode selection

Press the **SET** key.

The mode is now set to the parameter setting mode ("PRM").

③ Select Parameter 77.

Use the **+** and **-** keys under the SW/PRM display to select "77".

④ Select the setting value.

Use the **△** and **▽** keys under the POSITION display to select the setting value.

Options:

- 0: Motion Detection Output disabled
- 1: Both directions
- 2: Forward
- 3: Reverse

The selected value can be canceled by pressing the **CLR** key at this point.

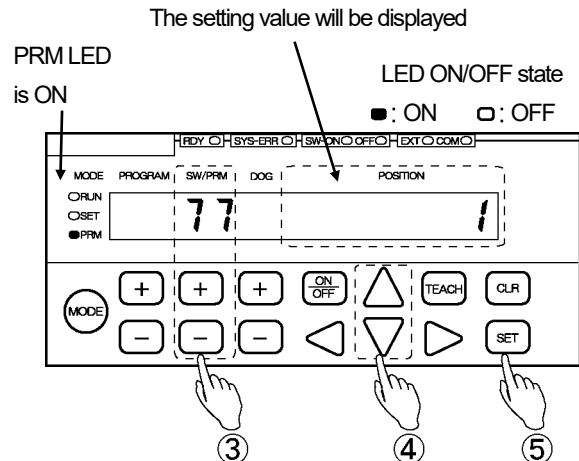

⑤ Confirm the selected value.

Press the **SET** key.

The POSITION display will become solidly on, indicating that parameter setting is complete.

(2) Motion Detection speed setting

① Select Parameter 76.

Use the $\boxed{+}$ and $\boxed{-}$ keys under the SW/PRM display to select "76".

② Enter the setting value.

Use the \triangleleft , \triangleleft , \triangleleft and ∇ keys under the POSITION display to enter the setting value.

The unit of speed is:

"Current Position Value (scale value)/s.

Example:

If the Current Position Value display resolution is 0.1 mm, the speed will be set to 10 mm/s when "10.0" is entered.

The entered value can be canceled by pressing the $\boxed{\text{CLR}}$ key at this point.

③ Confirm the entered value.

Press the $\boxed{\text{SET}}$ key.

The POSITION display becomes solidly on, indicating that parameter setting is complete.

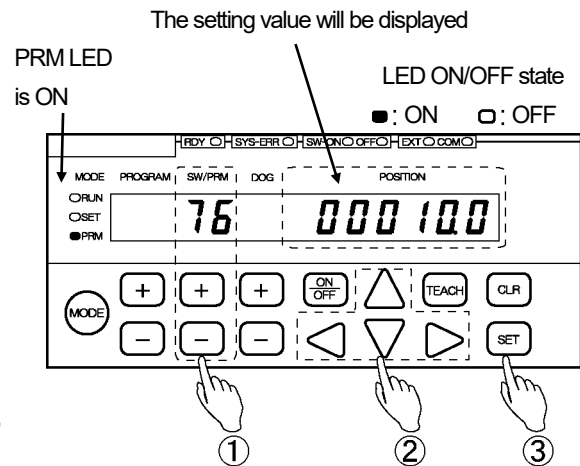

4-12. Current Position Output Setting

This section applies to VS-10GH-D and VS-10GH-D-1.

Set this parameter if the Current Position Output needs to be used.

About input/output timing related to the Current Position Output, refer to "2-6-4. Current Position Output timing".

(1) Parameter setting mode ("PRM") selection

① Select the parameter setting mode ("PRM").

Press and hold down the  key (more than 1 second).

The POSITION display will flicker to indicate mode selection is possible.

Press the  key a number of times until the parameter setting mode ("PRM") is shown.

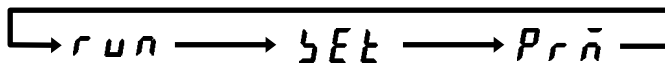
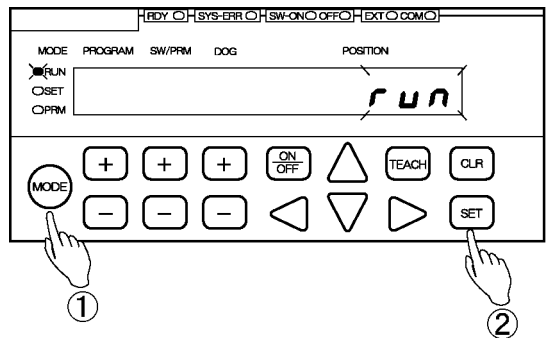

Run mode ("RUN")	Switch setting mode ("SET")	Parameter setting mode ("PRM")
MODE	MODE	MODE
<input checked="" type="checkbox"/> RUN	<input type="checkbox"/> RUN	<input type="checkbox"/> RUN
<input type="checkbox"/> SET	<input checked="" type="checkbox"/> SET	<input type="checkbox"/> SET
<input type="checkbox"/> PRM	<input type="checkbox"/> PRM	<input checked="" type="checkbox"/> PRM

② Confirm the mode selection

Press the  key.

The mode is now set to the parameter setting mode ("PRM").

(2) Current Position Output Code and Logic setting

① Select Parameter 94.

Use the \oplus and \ominus keys under the SW/PRM display to select "94".

② Select the setting value.

Use the \triangle and ∇ keys under the POSITION display to select the setting value.

Options:

- 0: BCD output (negative logic) / decimal point output (positive logic)
- 1: BCD output (positive logic) / decimal point output (negative logic)
- 2: BCD output (negative logic) / decimal point output (negative logic)
- 3: BCD output (positive logic) / decimal point output (positive logic)
- 4: Binary output (sign magnitude code, negative logic), decimal point output (positive logic)
- 5: Binary output (sign magnitude code, positive logic), decimal point output (negative logic)
- 6: Binary output (two's complement, negative logic), decimal point output (positive logic)
- 7: Binary output (two's complement, positive logic), decimal point output (negative logic)

The selected value can be canceled by pressing the \square key at this point.

③ Confirm the selected value.

Press the \square key.

The POSITION display will become solidly on, indicating that parameter setting is complete.

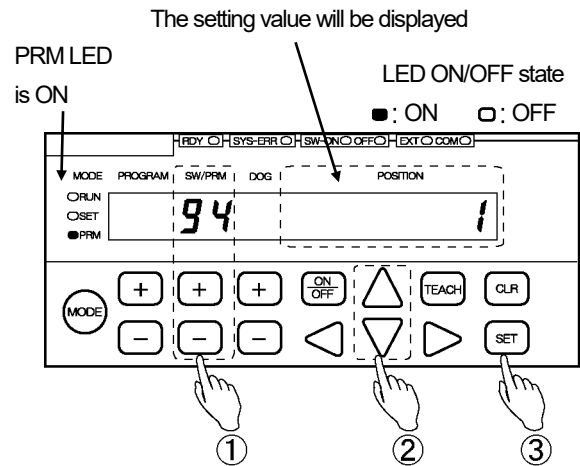

(3) Latch Pulse Timing setting

① Select Parameter 75.

Use the \oplus and \ominus keys under the SW/PRM display to select "75".

② Select the setting value.

Use the \triangle and ∇ keys under the POSITION display to select the setting value.

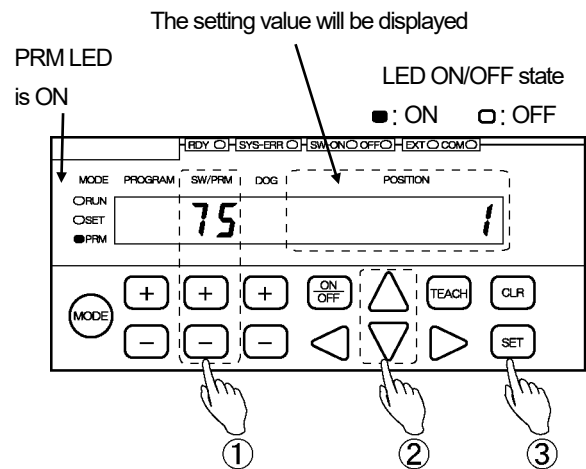

Options:

- Edge Timing

0: Current position output is stable when changing from 0 to 1.

1: Current position output is stable when changing from 1 to 0.

- Level Timing

2: Current position output is stable at Level 0.

3: Current position output is stable at Level 1.

The selected value can be canceled by pressing the \square key at this point.

③ Confirm the selected value.

Press the \square key.

The POSITION display will become solidly on, indicating that parameter setting is complete.

(4) Current Position Output Update Cycle [n] and HOLD Method setting

① Select Parameter 74.

Use the **+** and **-** keys under the SW/PRM display to select "74".

② Enter the setting value.

Use the **◀**, **▶**, **▲** and **▼** keys under the POSITION display to enter the setting value.

Setting range:

0: PC Synchronization Method (Updating is triggered by the DTC input signal change.)

1 to 128 : Transparent Method (Updating is suspended with the DTC signal ON)

Setting Value [n] x 4 = Current Position Value update cycle (ms)

The entered value can be canceled by pressing the **CLR** key at this point.

③ Confirm the entered value.

Press the **SET** key.

The POSITION display becomes solidly on, indicating that parameter setting is complete.

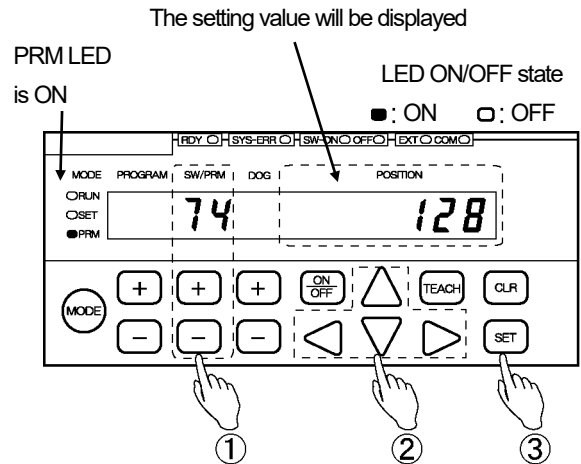

(5) PC Synchronization Delay Value setting

① Select Parameter 73.

Use the **[+]** and **[-]** keys under the SW/PRM display to select "73".

② Enter the setting value.

Use the **[<]**, **[>]**, **[△]** and **[▽]** keys under the POSITION display to enter the setting value.

Setting range:
0 to 99 [ms]

The entered value can be canceled by pressing the **[CLR]** key at this point.

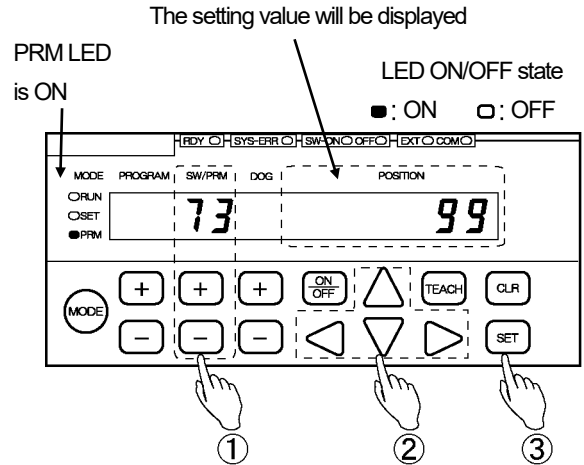

③ Confirm the entered value.

Press the **[SET]** key.

The POSITION display becomes solidly on, indicating that parameter setting is complete.

4-13. Setting the Output Status in Non-Run Modes

This parameter specifies what the switch output status should be when the mode has been changed from the Run mode ("RUN") to the switch setting mode ("SET") or the parameter setting mode ("PRM").

In the factory setting, this parameter is set to "0: Output Hold"

Change the parameter if the output status needs to be "Off".

Set the parameter in the following steps.

① Select the parameter setting mode ("PRM").

Press and hold down the **MODE** key (more than 1 second).

The POSITION display will flicker to indicate mode selection is possible.

Press the **MODE** key a number of times until the parameter setting mode ("PRM") is shown.

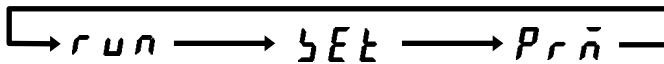
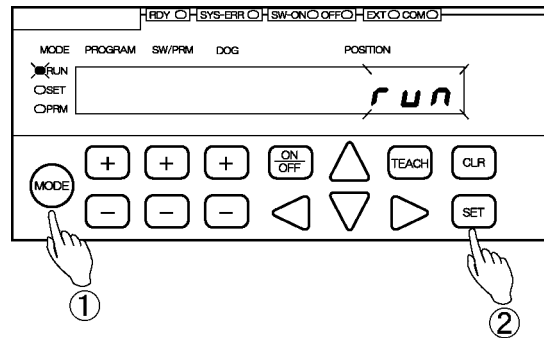

Run mode ("RUN")	Switch setting mode ("SET")	Parameter setting mode ("PRM")
MODE	MODE	MODE
<input checked="" type="checkbox"/> RUN	<input type="checkbox"/> RUN	<input type="checkbox"/> RUN
<input type="checkbox"/> SET	<input checked="" type="checkbox"/> SET	<input type="checkbox"/> SET
<input type="checkbox"/> PRM	<input type="checkbox"/> PRM	<input checked="" type="checkbox"/> PRM

② Confirm the mode selection

Press the **SET** key.

The mode is now set to the parameter setting mode ("PRM").

③ Select Parameter 78.

Use the **+** and **-** keys under the SW/PRM display to select "78".

④ Select the setting value.

Use the **△** and **▽** keys under the POSITION display to select the setting value.

- Options:
- 0: Output Hold
 - 1: Output Off

The selected value can be canceled by pressing the **CLR** key at this point.

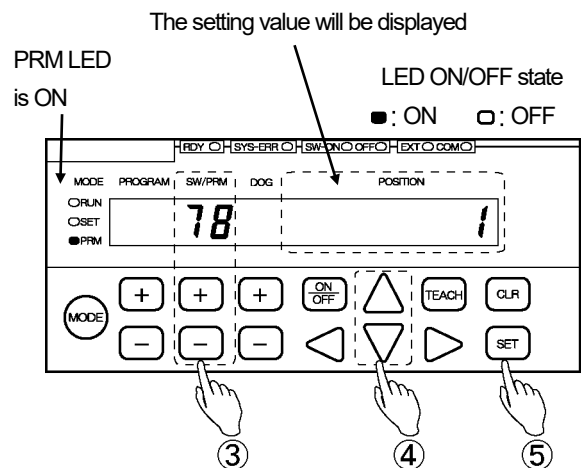

⑤ Confirm the selected value.

Press the **SET** key.

The POSITION display will become solidly on, indicating that parameter setting is complete.

4-14. Measuring Function Setting

The Measuring Function can be used for machining-end position measurement and other similar purposes. This function can work in either the External Trigger mode or the Hold Measuring mode.

1. External Trigger Mode

An external measuring trigger signal input from the host controller into the switch output connector will cause the Current Position Value to be "held" so that it can be read as a measuring value.

2. HOLD Measuring Mode

"HOLD Measuring" refers to a function where the Current Position Value will be automatically held so that it can be read as a measuring value when the Current Position Value has remained within the Stable Width for the duration of the Stable Time after passing the HOLD Clear Threshold.

This monitors the Current Position Value behavior, so measurement can be obtained after current position value fluctuations have ceased.

For the monitoring of Current Position Value behavior, set Parameters 64 (HOLD Measuring Stable Time) and 65 (HOLD Measuring Stable Width).

The completion signal can be sent out when HOLD measuring is completed by setting Parameter 62 (HOLD Measuring Completed Output (Approved/Disapproved)).

● External Trigger mode

(1) Start measurement upon external trigger off.

When Parameter 67 (Measuring Selection) is set to "1":

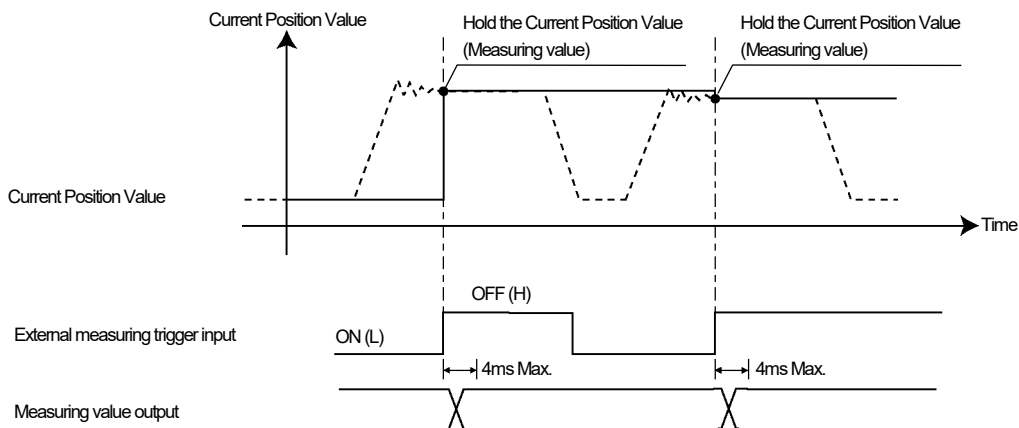

(2) Start measurement upon external trigger on

When Parameter 67 (Measuring Selection) is set to "2":

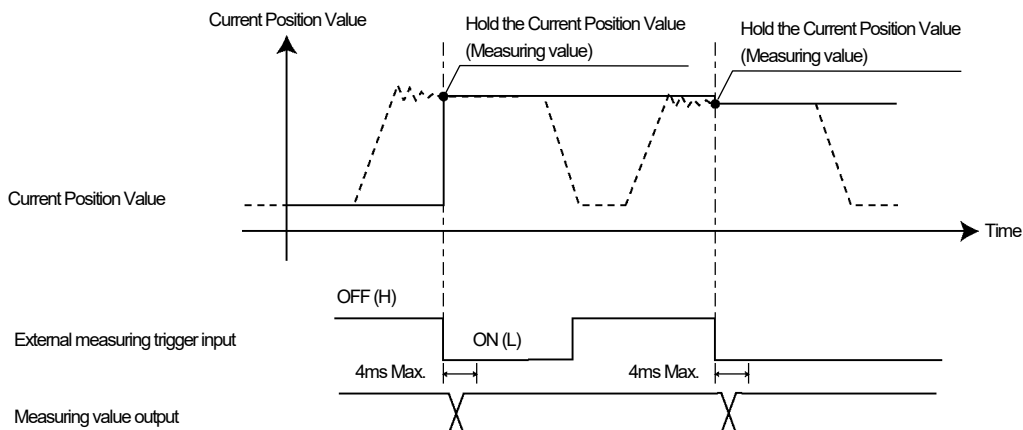



● HOLD Measuring mode

(1) HOLD Measuring (HOLD Clear Threshold/Current Position Value increase direction)

When Parameter 67 (Measuring Selection) is set to "3":

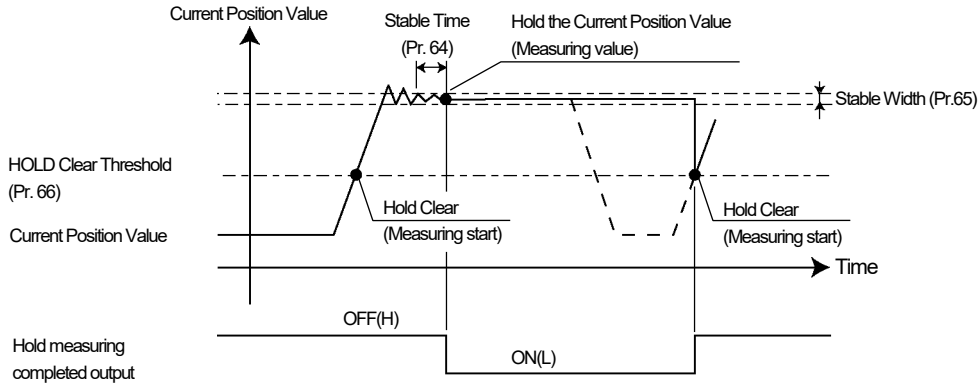

(2) HOLD Measuring (HOLD Clear Threshold/Current Position Value decrease direction)

When Parameter 67 (Measuring Selection) is set to "4":

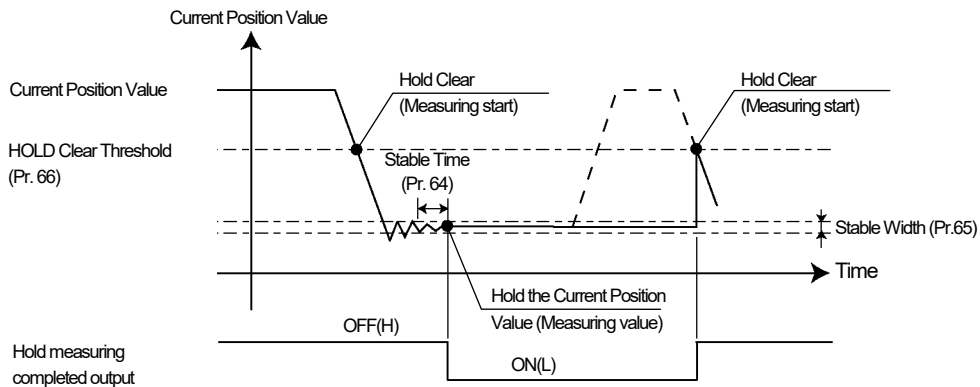

● If the Current Position Value does not stabilize:

If the Current Position Value does not remain inside the Stable Width and passes the Hold Clear Threshold again, a "no Hold" message will appear on the Measuring Value Monitor screen.

For Measuring Value Monitor screen details, refer to (5) of "6-3. Monitors".

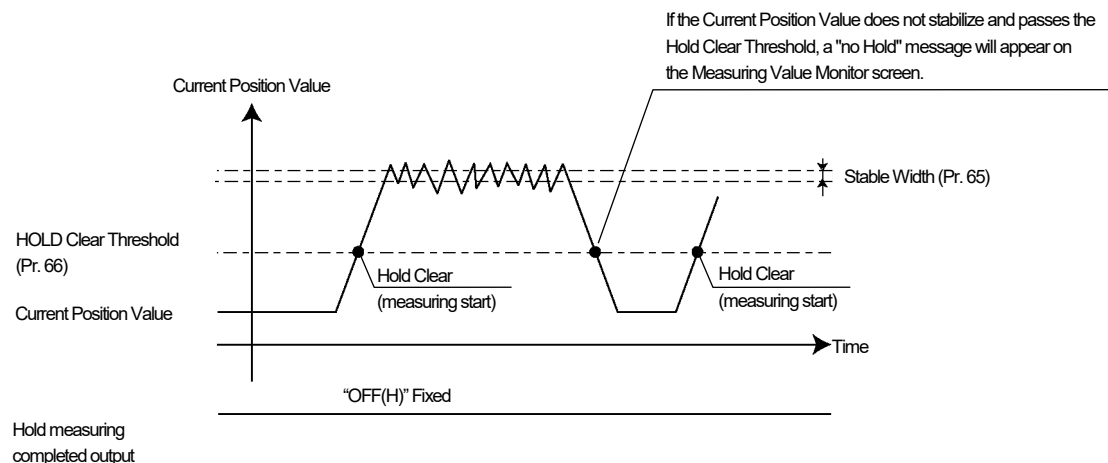



4-14-1. Definitions of current position value and measuring value

Two terms, "Current Position Value" and "Measuring Value", are used in relation to Measuring Function settings. Differences between the two values are illustrated below, which should be understood before carrying out the settings.

Current Position Value and Measuring Value concept



Current Position Value

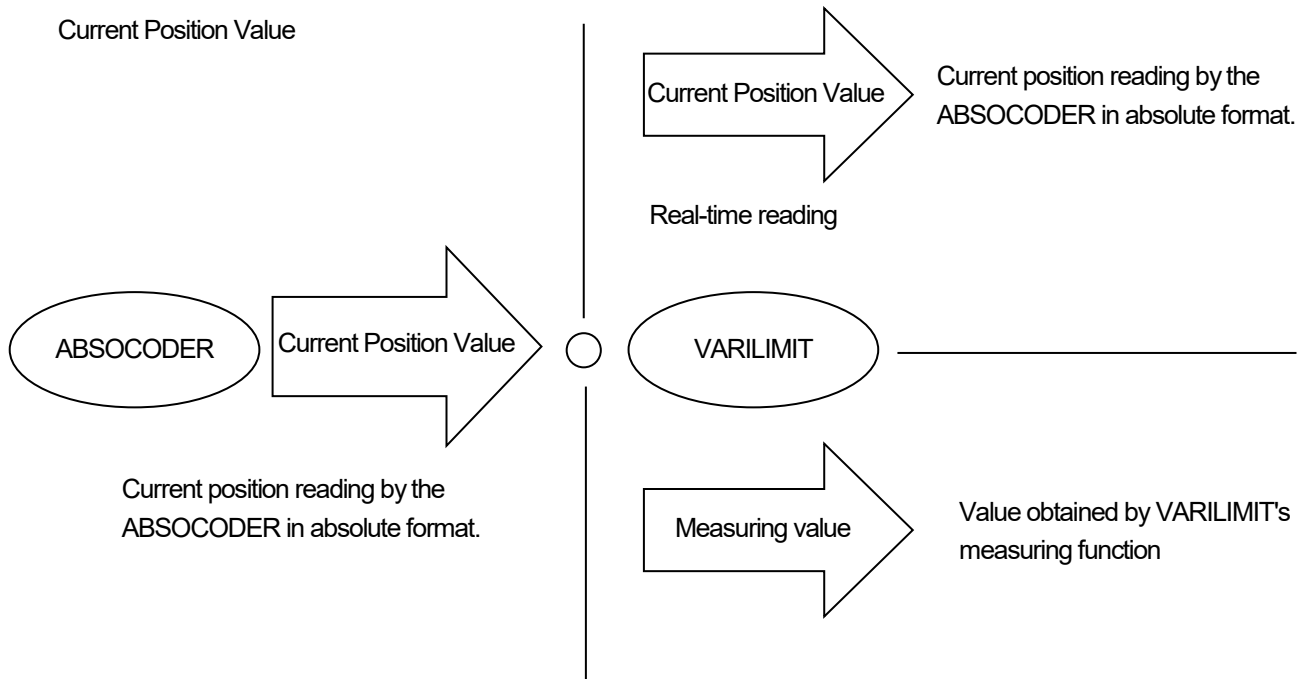

4-14-2. Measuring selection setting

The measurement start trigger can be selected.

Either an External measuring trigger signal of the switch output connector or Parameter 66's Hold Clear Threshold can be used as the measurement trigger.

Set the parameter in the following steps.

① Select the parameter setting mode ("PRM").

Press and hold down the **MODE** key (more than 1 second).

The POSITION display will flicker to indicate mode selection is possible.

Press the **MODE** key a number of times until the parameter setting mode ("PRM") is shown.

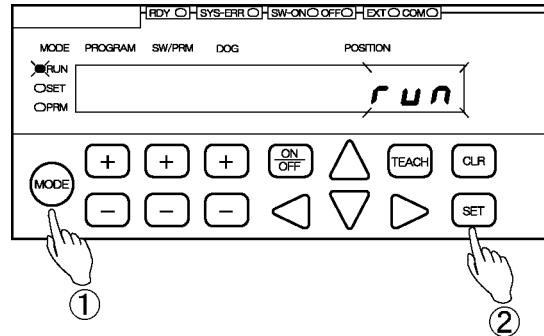

Run mode ("RUN")	Switch setting mode ("SET")	Parameter setting mode ("PRM")
MODE	MODE	MODE
<input checked="" type="checkbox"/> RUN	<input type="checkbox"/> RUN	<input type="checkbox"/> RUN
<input type="checkbox"/> SET	<input checked="" type="checkbox"/> SET	<input type="checkbox"/> SET
<input type="checkbox"/> PRM	<input type="checkbox"/> PRM	<input checked="" type="checkbox"/> PRM

② Confirm the mode selection

Press the **SET** key.

The mode is now set to the parameter setting mode ("PRM").

③ Select Parameter 67.

Use the **+** and **-** keys under the SW/PRM display to select "67".

④ Select the setting value.

Use the **△** and **▽** keys under the POSITION display to select the setting value.

Options:

- 0: Measuring/Motion Record is disable
- 1: Start measurement upon external measuring trigger off
- 2: Start measurement upon external measuring trigger on
- 3: HOLD Clear Threshold/Current Position Value increase direction
- 4: HOLD Clear Threshold/Current position Value decrease direction

5 to 8: Motion Recording function *1

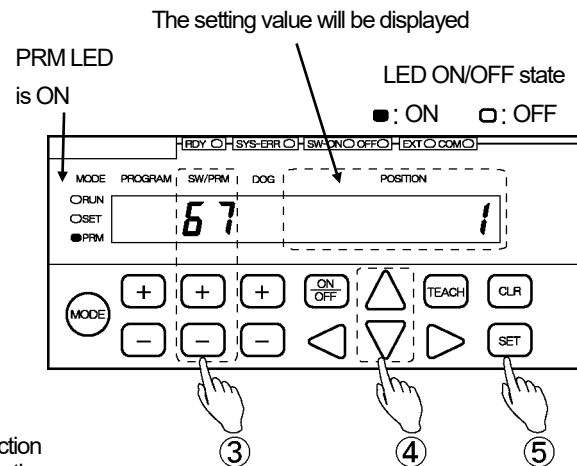

The selected value can be canceled by pressing the **CLR** key at this point.

NOTES

*1: Do not select 5 to 8.
For Motion Recording function details, refer to Chapter 4-15.

⑤ Confirm the selected value.

Press the **SET** key.

The POSITION display will become solidly on, indicating that parameter setting is complete.

4-14-3. Current position value/measuring value output selection

This parameter specifies whether to use the Current Position Value or the Measuring Value for switch output control. In the case of VS-10GH-D or VS-10GH-D-1, it is also possible to select whether to use the Current Position Value or the Measuring Value for current position output.

Set the parameter in the following steps.

① Select the parameter setting mode ("PRM").

Press and hold down the **MODE** key (more than 1 second).

The POSITION display will flicker to indicate mode selection is possible.

Press the **MODE** key a number of times until the parameter setting mode ("PRM") is shown.

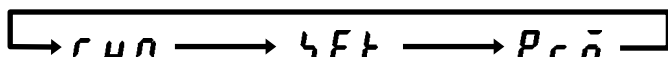
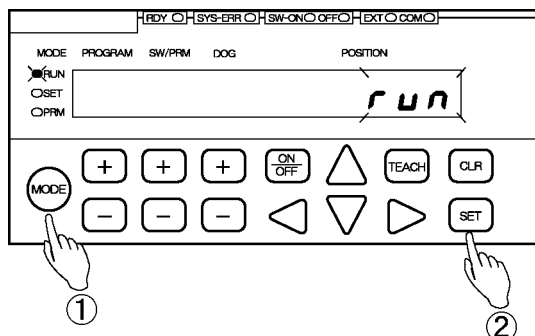

Run mode ("RUN")	Switch setting mode ("SET")	Parameter setting mode ("PRM")
MODE	MODE	MODE
<input checked="" type="checkbox"/> RUN	<input type="checkbox"/> RUN	<input type="checkbox"/> RUN
<input type="checkbox"/> SET	<input checked="" type="checkbox"/> SET	<input type="checkbox"/> SET
<input type="checkbox"/> PRM	<input type="checkbox"/> PRM	<input checked="" type="checkbox"/> PRM

② Confirm the mode selection

Press the **SET** key.

The mode is now set to the parameter setting mode ("PRM").

③ Select Parameter 68.

Use the **+** and **-** keys under the SW/PRM display to select "68".

④ Select the setting value.

Use the **△** and **▽** keys under the POSITION display to select the setting value.

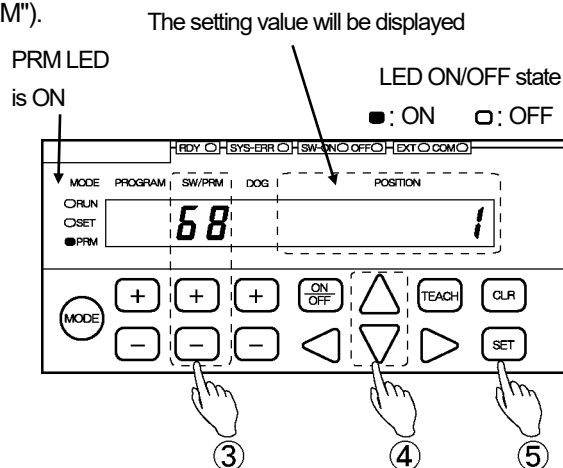

Options:

VS-10GH-A, VS-10GH-A-1, VS-10GH-C-1

0: Switch output - Measuring Value

1: Switch output - Current Position Value

Set "1" when selecting a value from "5 to 8" at the parameter No.67.

VS-10GH-D, VS-10GH-D-1

0: Switch output - Measuring Value / Current position output - Measuring Value

1: Switch output - Current Position Value / Current position output - Measuring Value

2: Switch output - Measuring Value / Current position output - Current Position Value

3: Switch output - Current Position Value / Current position output - Current Position Value

Set "3" when selecting a value from "5 to 8" at the parameter No.67.

The selected value can be canceled by pressing the **CLR** key at this point.

⑤ Confirm the selected value.

Press the **SET** key.

The POSITION display will become solidly on, indicating that parameter setting is complete.

4-14-4. HOLD clear threshold setting

The measurement start threshold can be set.

The Current Position Value will be read as a measuring value when the Current Position Value has remained within the Stable Width range (Parameter 65) for the duration of the Stable Time (Parameter 64) after passing the Hold Clear Threshold.

Set the parameter in the following steps.

① Select the parameter setting mode ("PRM").

Press and hold down the **(MODE)** key (more than 1 second).

The POSITION display will flicker to indicate mode selection is possible.

Press the **(MODE)** key a number of times until the parameter setting mode ("PRM") is shown.

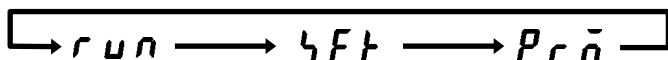
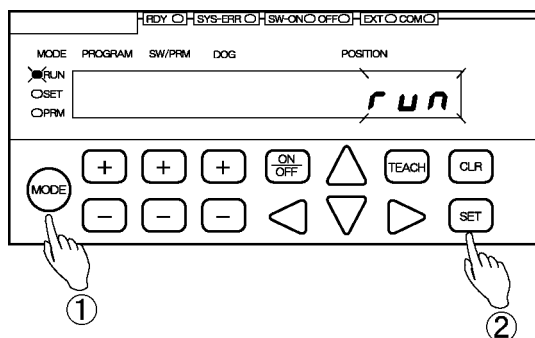

Run mode ("RUN")	Switch setting mode ("SET")	Parameter setting mode ("PRM")
MODE	MODE	MODE
<input checked="" type="checkbox"/> RUN	<input type="checkbox"/> RUN	<input type="checkbox"/> RUN
<input type="checkbox"/> SET	<input checked="" type="checkbox"/> SET	<input type="checkbox"/> SET
<input type="checkbox"/> PRM	<input type="checkbox"/> PRM	<input checked="" type="checkbox"/> PRM

② Confirm the mode selection

Press the **(SET)** key.

The mode is now set to the parameter setting mode ("PRM").

③ Select Parameter 66.

Use the **(+)** and **(-)** keys under the SW/PRM display to select "66".

④ Enter the setting value.

Use the **(←)**, **(→)**, **(△)** and **(▽)** keys under the POSITION display to enter the setting value.

Setting range:

—999999 to 999999

The entered value can be canceled by pressing the **(CLR)** key at this point.

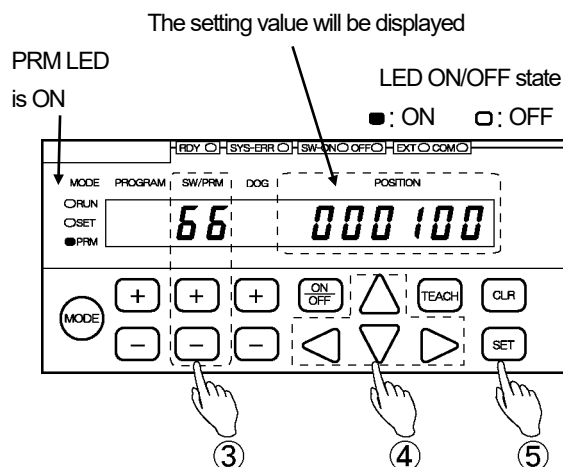

⑤ Confirm the entered value.

Press the **(SET)** key.

The POSITION display becomes solidly on, indicating that parameter setting is complete.

4-14-5. HOLD measuring stable width setting

Set the required Stable Width to complete a measurement.

Set the parameter in the following steps.

① Select the parameter setting mode ("PRM").

Press and hold down the **(MODE)** key (more than 1 second).

The POSITION display will flicker to indicate mode selection is possible.

Press the **(MODE)** key a number of times until the parameter setting mode ("PRM") is shown.

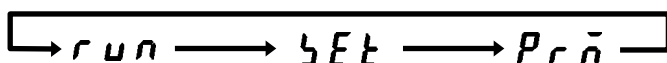
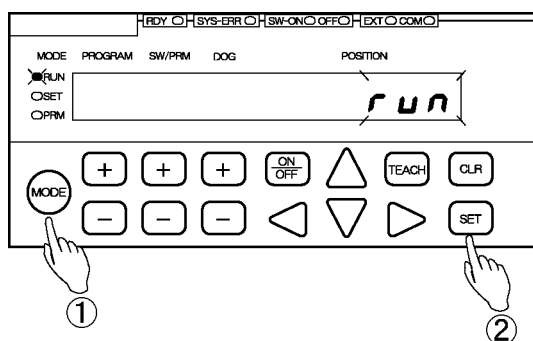

Run mode ("RUN") Switch setting mode ("SET") Parameter setting mode ("PRM")

MODE	MODE	MODE
<input checked="" type="checkbox"/> RUN	<input type="checkbox"/> RUN	<input type="checkbox"/> RUN
<input type="checkbox"/> SET	<input checked="" type="checkbox"/> SET	<input type="checkbox"/> SET
<input type="checkbox"/> PRM	<input type="checkbox"/> PRM	<input checked="" type="checkbox"/> PRM

② Confirm the mode selection

Press the **(SET)** key.

The mode is now set to the parameter setting mode ("PRM").

③ Select Parameter 65.

Use the **(+)** and **(-)** keys under the SW/PRM display to select "65".

④ Enter the setting value.

Use the **(←)**, **(→)**, **(△)** and **(▽)** keys under the POSITION display to enter the setting value.

Setting range:
0 to 999999

The entered value can be canceled by pressing the **(CLR)** key at this point.

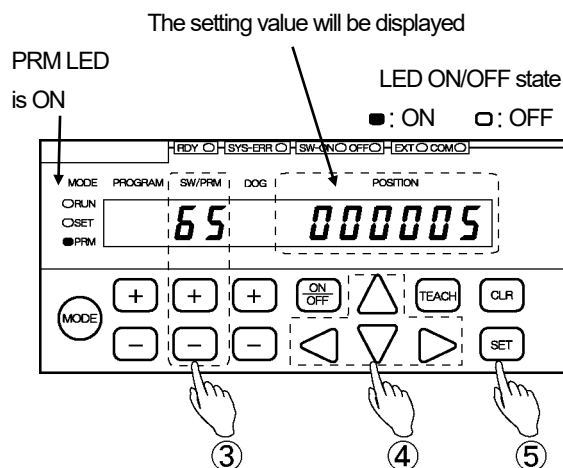

⑤ Confirm the entered value.

Press the **(SET)** key.

The POSITION display becomes solidly on, indicating that parameter setting is complete.

4-14-6. HOLD measuring stable time setting

Set the required Stable Time to complete a measurement.
Unit of setting value : [s]

Set the parameter in the following steps.

① Select the parameter setting mode ("PRM").

Press and hold down the **(MODE)** key (more than 1 second).

The POSITION display will flicker to indicate mode selection is possible.

Press the **(MODE)** key a number of times until the parameter setting mode ("PRM") is shown.

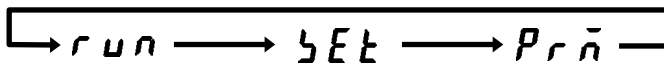
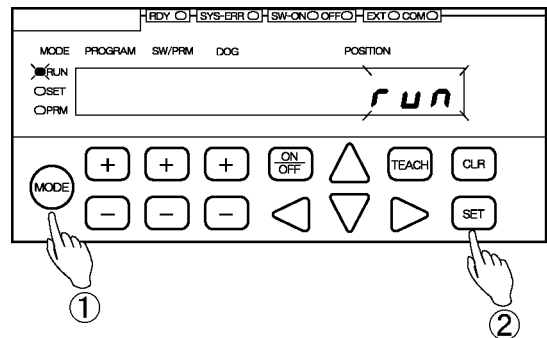

Run mode ("RUN")	Switch setting mode ("SET")	Parameter setting mode ("PRM")
MODE	MODE	MODE
<input checked="" type="checkbox"/> RUN	<input type="checkbox"/> RUN	<input type="checkbox"/> RUN
<input type="checkbox"/> SET	<input checked="" type="checkbox"/> SET	<input type="checkbox"/> SET
<input type="checkbox"/> PRM	<input type="checkbox"/> PRM	<input checked="" type="checkbox"/> PRM

② Confirm the mode selection

Press the **(SET)** key.
The mode is now set to the parameter setting mode ("PRM").

③ Select Parameter 64.

Use the **(+)** and **(-)** keys under the SW/PRM display to select "64".

④ Enter the setting value.

Use the **(←)**, **(→)**, **(△)** and **(▽)** keys under the POSITION display to enter the setting value.

Setting range:
0.001 to 9.999 [s]

The entered value can be canceled by pressing the **(CLR)** key at this point.

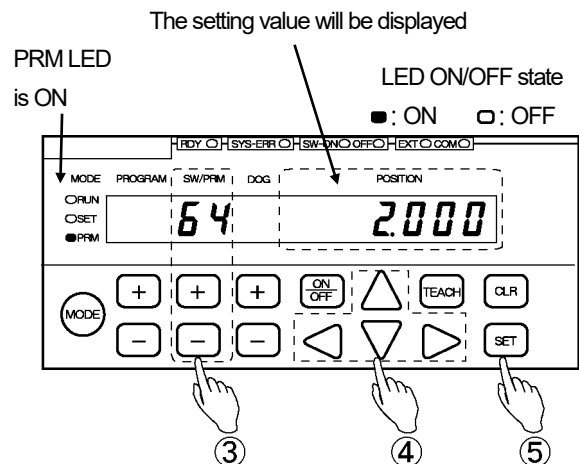

⑤ Confirm the entered value.

Press the **(SET)** key.
The POSITION display becomes solidly on, indicating that parameter setting is complete.

4-14-7. HOLD Measuring Completed Signal Output Enabled/Disabled Setting

This parameter can change the signal status of Pin A9 at the switch output connector from the switch output 28 to the HOLD measuring completed output.

When the current position value is held after completing the HOLD measuring, this signal will be turned on.

Set the parameter in the following steps.

① Select the parameter setting mode ("PRM").

Press and hold down the **(MODE)** key (more than 1 second).

The POSITION display will flicker to indicate mode selection is possible.

Press the **(MODE)** key a number of times until the parameter setting mode ("PRM") is shown.

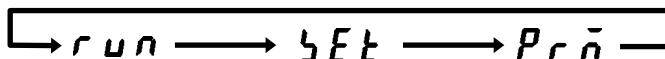
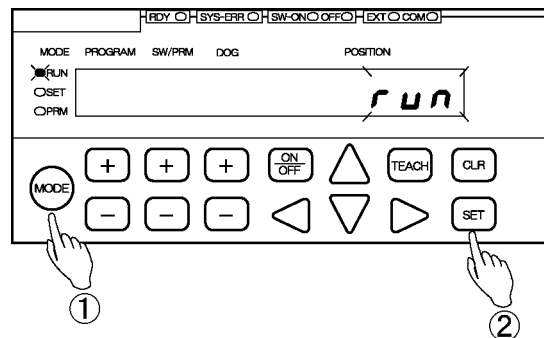

Run mode ("RUN")	Switch setting mode ("SET")	Parameter setting mode ("PRM")
MODE	MODE	MODE
<input checked="" type="checkbox"/> RUN	<input type="checkbox"/> RUN	<input type="checkbox"/> RUN
<input type="checkbox"/> SET	<input checked="" type="checkbox"/> SET	<input type="checkbox"/> SET
<input type="checkbox"/> PRM	<input type="checkbox"/> PRM	<input checked="" type="checkbox"/> PRM

② Confirm the mode selection

Press the **(SET)** key.

The mode is now set to the parameter setting mode ("PRM").

③ Select Parameter 62.

Use the **(+)** and **(-)** keys under the SW/PRM display to select "62".

④ Select the setting value.

Use the **(△)** and **(▽)** keys under the POSITION display to select the setting value.

Options:

0: Disapproved (Used as Switch output 28)

1: Approved (Used as output HOLD measuring completed output)

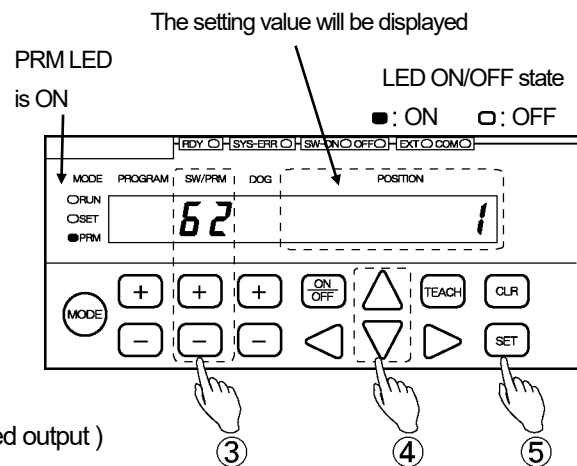

The selected value can be canceled by pressing the **(CLR)** key at this point.

⑤ Confirm the selected value.

Press the **(SET)** key.

The POSITION display will become solidly on, indicating that parameter setting is complete.

4-15. Setting the Motion Recording Function

Machine trajectories can be recorded in graph form using VARIMONI or any other setting and editing software. The machine moves to the direction that is specified by the parameter After passing the start position for Motion Recording, 100 current position values can be recorded for each specified sampling cycle.

The Motion Recording function refers to three settings as follows:

1. Parameter 67 (Measuring/Motion Recording Selection)
2. Parameter 66 (Motion Recording Start Position)
3. Parameter 64 (Motion Recording Sampling Cycle)

Behaviors of the workpiece can be recorded as below:

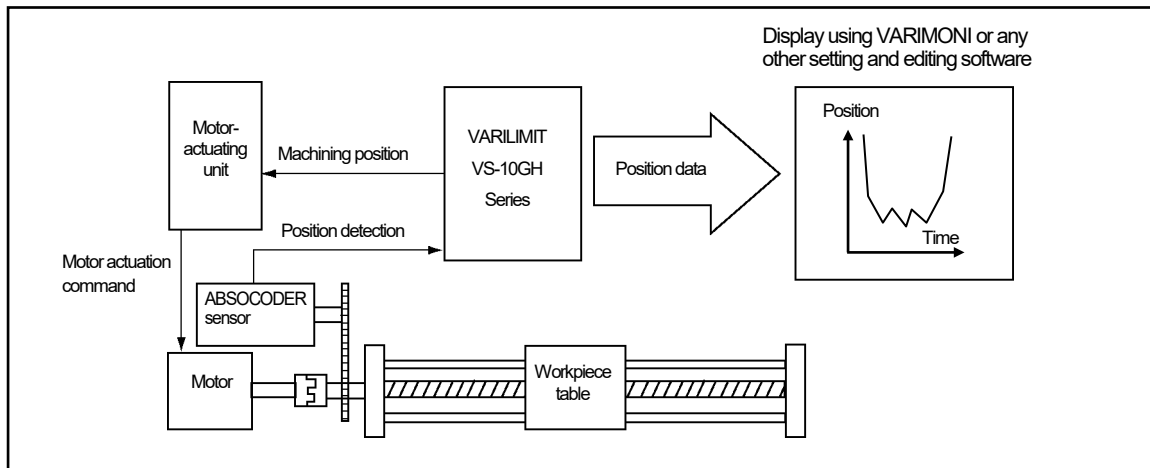

Example of motion recording operation

Parameter 67 (Measuring Selection) is set to 5 (Motion Recording Position/ During Travel in Increase Direction). When a machine traveling in the current position value increase direction passes the motion recording start position (Parameter 66), the motion recording will start at the intervals predetermined as the motion recording sampling cycle (Parameter 64).

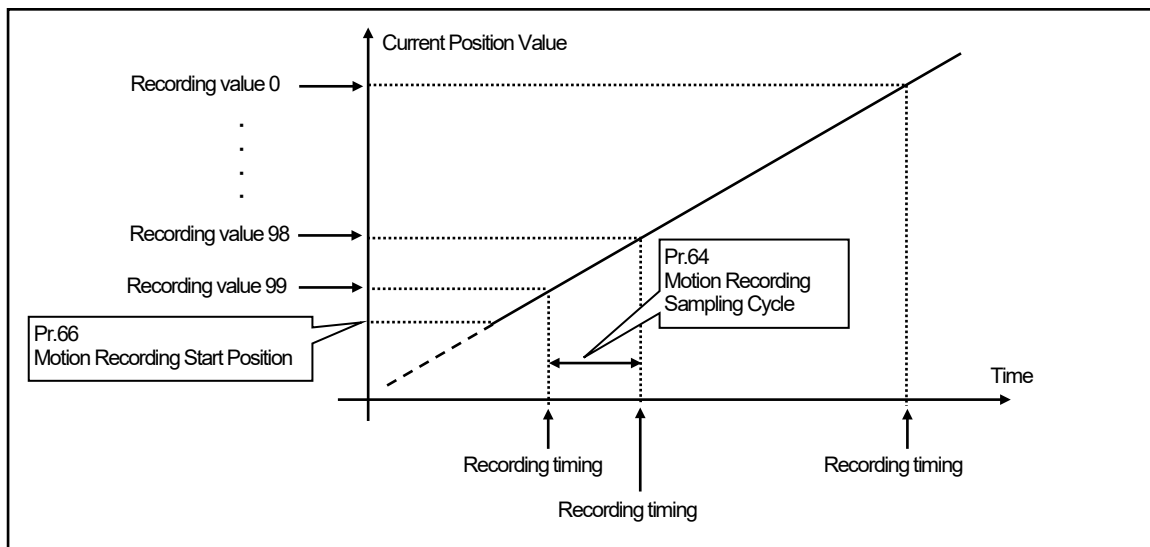

(1) Motion Recording Selection setting

① Select the parameter setting mode ("PRM").

Press and hold down the **MODE** key (more than 1 second).

The POSITION display will flicker to indicate mode selection is possible.

Press the **MODE** key a number of times until the parameter setting mode ("PRM") is shown.

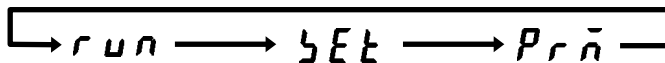
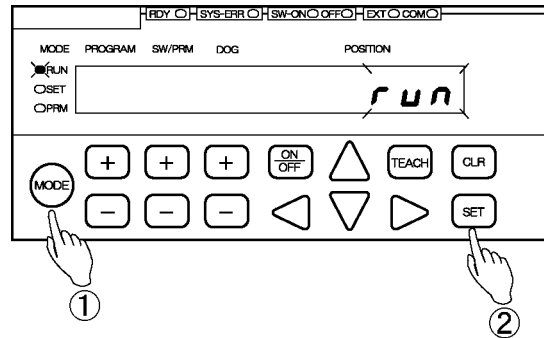

Run mode ("RUN")	Switch setting mode ("SET")	Parameter setting mode ("PRM")
MODE	MODE	MODE
<input checked="" type="checkbox"/> RUN	<input type="checkbox"/> RUN	<input type="checkbox"/> RUN
<input type="checkbox"/> SET	<input checked="" type="checkbox"/> SET	<input type="checkbox"/> SET
<input type="checkbox"/> PRM	<input type="checkbox"/> PRM	<input checked="" type="checkbox"/> PRM

② Confirm the mode selection

Press the **SET** key.

The mode is now set to the parameter setting mode ("PRM").

③ Select Parameter 67.

Use the **+** and **-** keys under the SW/PRM display to select "67".

④ Select the setting value.

Use the **△** and **▽** keys under the POSITION display to select the setting value.

Options:

0 to 4: Measuring function *1

- 5: Motion Recording position/During traveling in the increase direction
- 6: Motion Recording position/During traveling in the decrease direction
- 7: Motion Recording communication and position/During traveling in the increase direction
- 8: Motion Recording communication and position/During traveling in the decrease direction

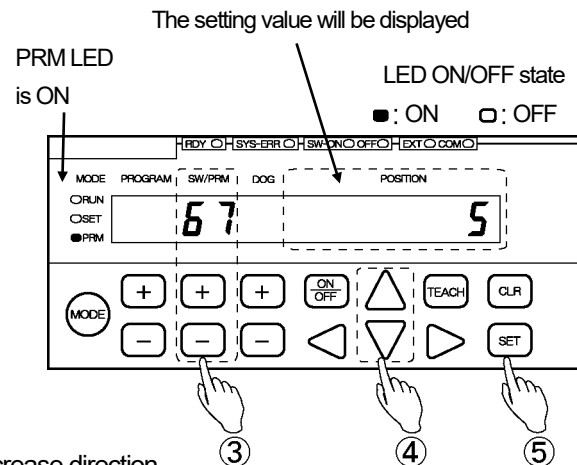

The selected value can be canceled by pressing the **CLR** key at this point.

⑤ Confirm the selected value.

Press the **SET** key.

The POSITION display will become solidly on, indicating that parameter setting is complete.

NOTES

*1: Do not select 1 to 4.
For Measuring function details, refer to Chapter 4-14.

(2) Motion Recording Start Position setting

① Select the parameter setting mode ("PRM").

Press and hold down the **MODE** key (more than 1 second).

The POSITION display will flicker to indicate mode selection is possible.

Press the **MODE** key a number of times until the parameter setting mode ("PRM") is shown.

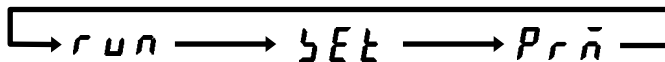
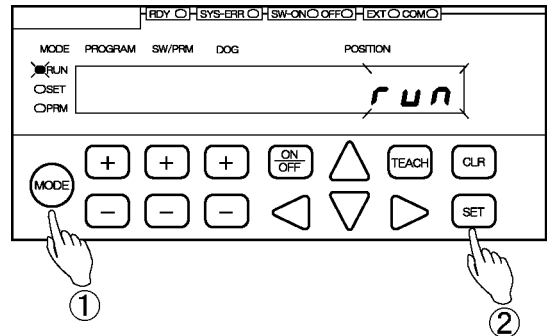

Run mode ("RUN")	Switch setting mode ("SET")	Parameter setting mode ("PRM")
MODE	MODE	MODE
<input checked="" type="checkbox"/> RUN	<input type="checkbox"/> RUN	<input type="checkbox"/> RUN
<input type="checkbox"/> SET	<input checked="" type="checkbox"/> SET	<input type="checkbox"/> SET
<input type="checkbox"/> PRM	<input type="checkbox"/> PRM	<input checked="" type="checkbox"/> PRM

② Confirm the mode selection

Press the **SET** key.

The mode is now set to the parameter setting mode ("PRM").

③ Select Parameter 66.

Use the **+** and **-** keys under the SW/PRM display to select "66".

④ Enter the setting value.

Use the **<**, **>**, **▲** and **▼** keys under the POSITION display to enter the setting value.

Setting range:

-999999 to 999999

The entered value can be canceled by pressing the **CLR** key at this point.

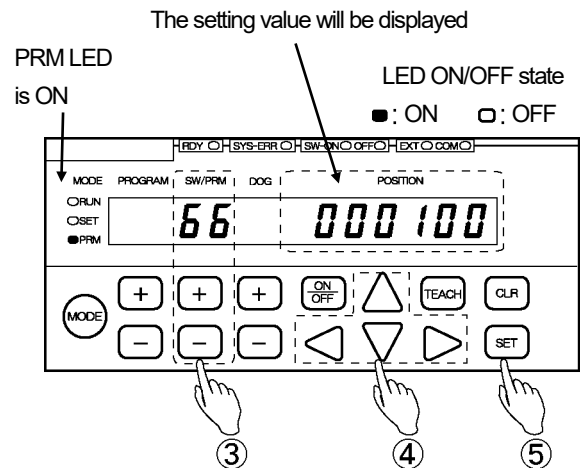

⑤ Confirm the entered value.

Press the **SET** key.

The POSITION display becomes solidly on, indicating that parameter setting is complete.

(3) Motion Recording Sampling Cycle setting

① Select the parameter setting mode ("PRM").

Press and hold down the **MODE** key (more than 1 second).
The POSITION display will flicker to indicate mode selection is possible.

Press the **MODE** key a number of times until the parameter setting mode ("PRM") is shown.

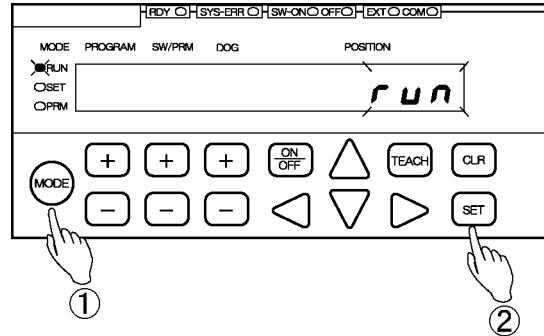

Run mode ("RUN")	Switch setting mode ("SET")	Parameter setting mode ("PRM")
MODE	MODE	MODE
<input checked="" type="checkbox"/> RUN	<input type="checkbox"/> RUN	<input type="checkbox"/> RUN
<input type="checkbox"/> SET	<input checked="" type="checkbox"/> SET	<input type="checkbox"/> SET
<input type="checkbox"/> PRM	<input type="checkbox"/> PRM	<input checked="" type="checkbox"/> PRM

② Confirm the mode selection

Press the **SET** key.
The mode is now set to the parameter setting mode ("PRM").

③ Select Parameter 64.

Use the **+** and **-** keys under the SW/PRM display to select "64".

④ Enter the setting value.

Use the **◀**, **▶**, **▲** and **▼** keys under the POSITION display to enter the setting value.

Setting range:
0.001 to 9.999 [s]

The entered value can be canceled by pressing the **CLR** key at this point.

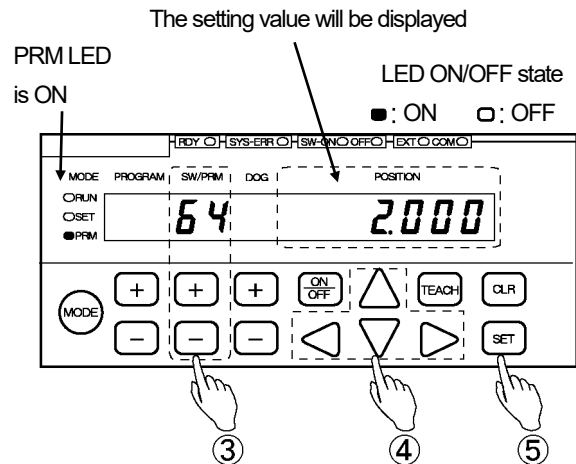

⑤ Confirm the entered value.

Press the **SET** key.
The POSITION display becomes solidly on, indicating that parameter setting is complete.

4-16. Sensor Filter Setting

The Sensor Filter parameter can be used when the Current Position Value tends to fluctuate, for example due to machine vibration. The displayed Current Position Value will actually be an average of the parameter-specified number of samplings. The sampling interval is 1 ms.

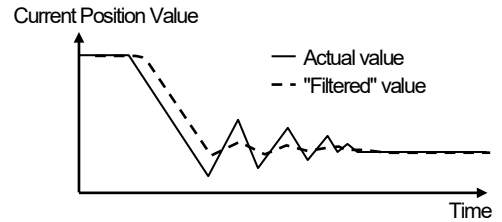

Set the parameter in the following steps.

① Select the parameter setting mode ("PRM").

Press and hold down the **MODE** key (more than 1 second).

The POSITION display will flicker to indicate mode selection is possible.

Press the **MODE** key a number of times until the parameter setting mode ("PRM") is shown.

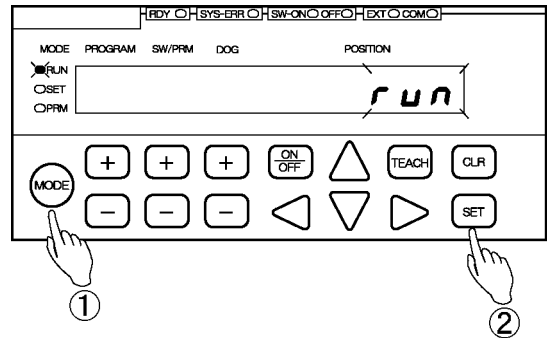

Run mode ("RUN")	Switch setting mode ("SET")	Parameter setting mode ("PRM")
MODE	MODE	MODE
<input checked="" type="radio"/> RUN	<input type="radio"/> RUN	<input type="radio"/> RUN
<input type="radio"/> SET	<input checked="" type="radio"/> SET	<input type="radio"/> SET
<input type="radio"/> PRM	<input type="radio"/> PRM	<input checked="" type="radio"/> PRM

② Confirm the mode selection

Press the **SET** key.

The mode is now set to the parameter setting mode ("PRM").

③ Select Parameter 63.

Use the **+** and **-** keys under the SW/PRM display to select "63".

④ Select the setting value.

Use the **△** and **▽** keys under the POSITION display to select the setting value.

Options:

- 0: None
- 1: Four samplings
- 2: Eight samplings
- 3: 16 samplings
- 4: 32 samplings
- 5: 64 samplings
- 6: 128 samplings

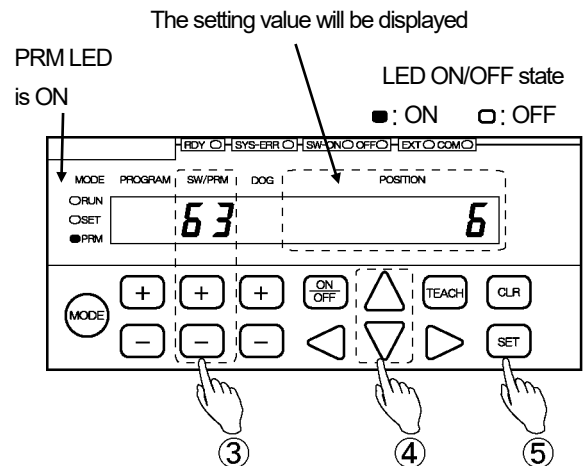

The selected value can be canceled by pressing the **CLR** key at this point.

⑤ Confirm the selected value.

Press the **SET** key.

The POSITION display will become solidly on, indicating that parameter setting is complete.

4-17. Hysteresis Function

When the direction of ABSOCODER's shaft rotation (travel) is reversed, the current position value before the reversal will be valid as long as remaining under the set value. This function is useful when the current position value fluctuates. Repeated switching to/from ON and OFF can be reduced.

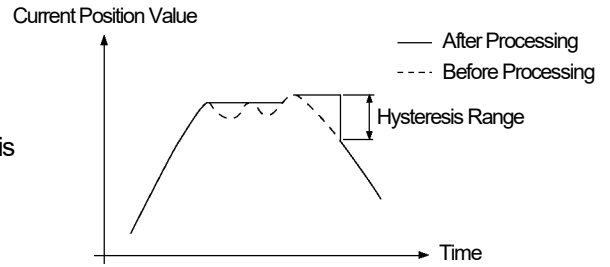

Set the parameter in the following steps.

① Select the parameter setting mode ("PRM").

Press and hold down the **MODE** key (more than 1 second).

The POSITION display will flicker to indicate mode selection is possible.

Press the **MODE** key a number of times until the parameter setting mode ("PRM") is shown.

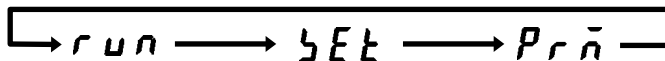
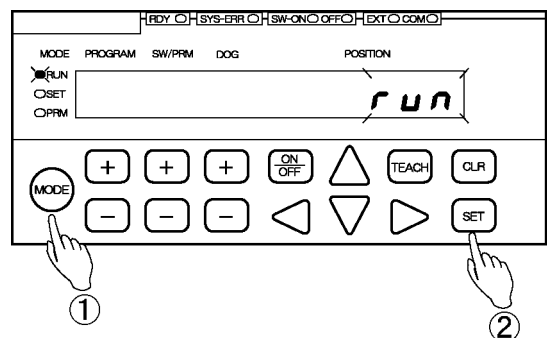

Run mode ("RUN")	Switch setting mode ("SET")	Parameter setting mode ("PRM")
MODE	MODE	MODE
<input checked="" type="checkbox"/> RUN	<input type="checkbox"/> RUN	<input type="checkbox"/> RUN
<input type="checkbox"/> SET	<input checked="" type="checkbox"/> SET	<input type="checkbox"/> SET
<input type="checkbox"/> PRM	<input type="checkbox"/> PRM	<input checked="" type="checkbox"/> PRM

② Confirm the mode selection

Press the **SET** key.

The mode is now set to the parameter setting mode ("PRM").

③ Select Parameter 71.

Use the **+** and **-** keys under the SW/PRM display to select "71".

④ Enter the setting value.

Use the **<**, **>**, **△** and **▽** keys under the POSITION display to enter the setting value.

Setting range:
0 to 999999

The entered value can be canceled by pressing the **CLR** key at this point.

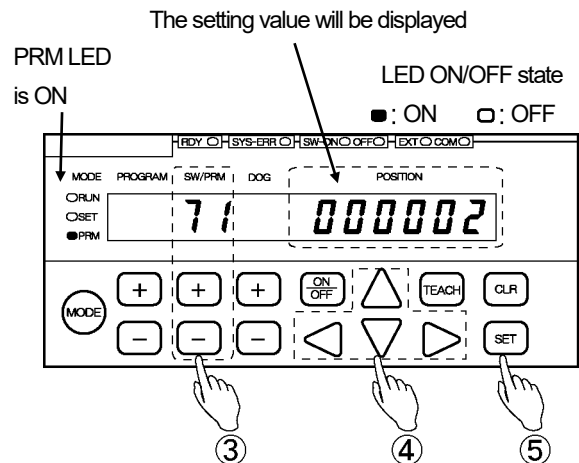

⑤ Confirm the entered value.

Press the **SET** key.

The POSITION display becomes solidly on, indicating that parameter setting is complete.

4-18. Setting the Switch Output Enabling Function

This is a function that controls whether or not to permit switch output by sending the signal to B3 pin of the switch output connector. This function is convenient to turn off the switch outputs when there is no workpiece, and not to malfunction during the machine is suspended.

When setting the parameter to 0 to disable this function, switch signals will be output regardless of the switch output enabling signal.

When setting the parameter to any of 1-30 to enable this function, switch signals from 1 to what is set will be output only when the Switch Output Enabling signal is turned on.

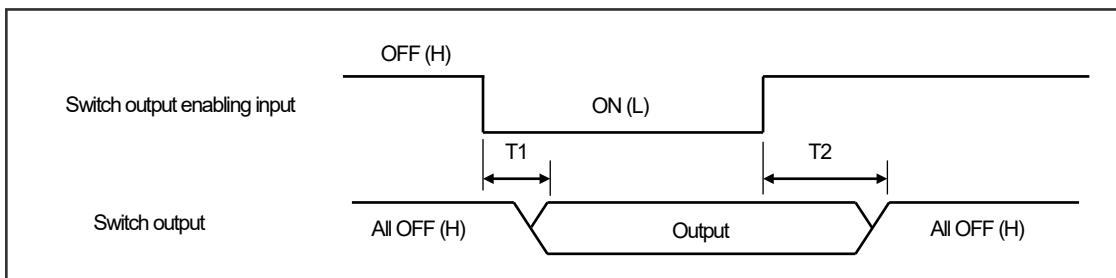

T1: Time from turning on the switch output enabling input to enabling the switch output
 $T1 \leq 3ms$

T2: Time from turning off the switch output enabling input to disabling the switch output
 $T2 \leq 3ms$

Set the parameter in the following steps.

① Select the parameter setting mode ("PRM").

Press and hold down the **MODE** key (more than 1 second).

The POSITION display will flicker to indicate mode selection is possible.

Press the **MODE** key a number of times until the parameter setting mode ("PRM") is shown.

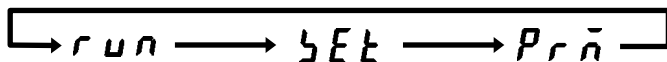
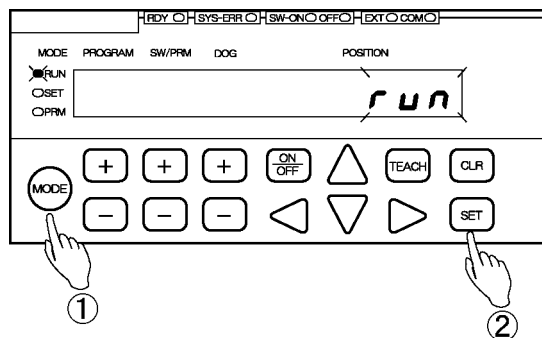

Run mode ("RUN")	Switch setting mode ("SET")	Parameter setting mode ("PRM")
MODE	MODE	MODE
<input checked="" type="radio"/> RUN	<input type="radio"/> RUN	<input type="radio"/> RUN
<input type="radio"/> SET	<input checked="" type="radio"/> SET	<input type="radio"/> SET
<input type="radio"/> PRM	<input type="radio"/> PRM	<input checked="" type="radio"/> PRM

② Confirm the mode selection

Press the **SET** key.

The mode is now set to the parameter setting mode ("PRM").

③ Select Parameter 70.

Use the **+** and **-** keys under the SW/PRM display to select "70".

④ Enter the setting value.

Use the **<**, **>**, **△** and **▽** keys under the POSITION display to enter the setting value.

Setting range:

- 0: Disabled
- 1 to 30: Enabled

The entered value can be canceled by pressing the **CLR** key at this point.

⑤ Confirm the entered value.

Press the **SET** key.

The POSITION display becomes solidly on, indicating that parameter setting is complete.

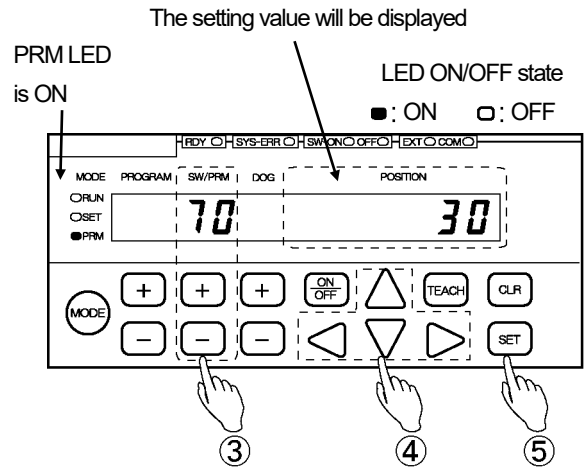

4-19. Setting the Multi-Origin Function

The Multi-Origin function enables settings of an origin (current position value) for each program.

For example:

When there are several processes to complete by a machine, an operational origin can be set for each process.

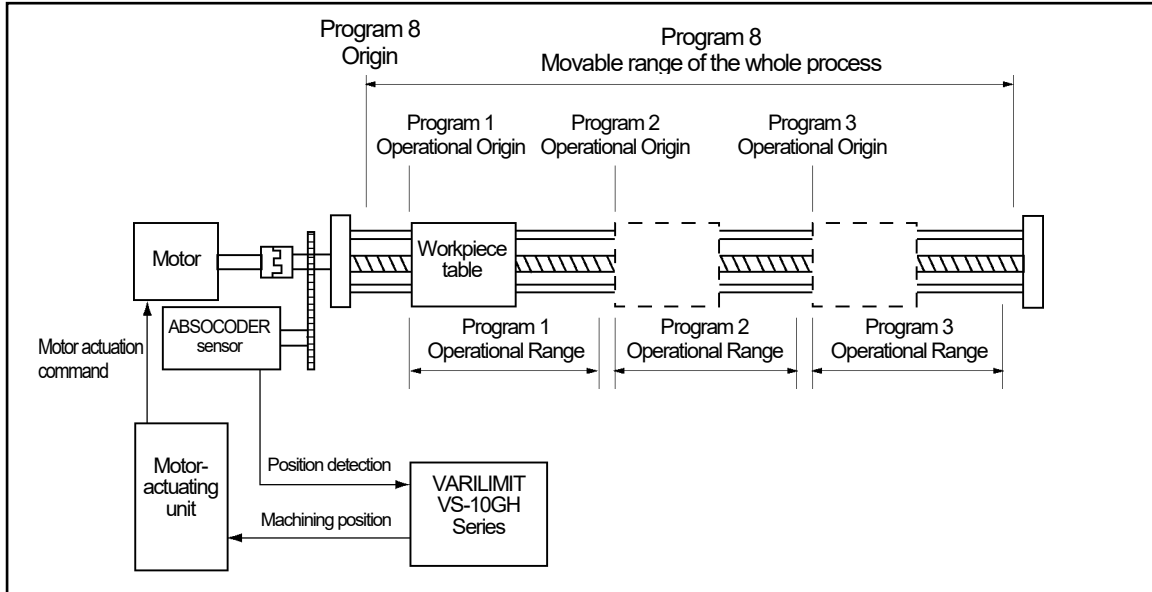

Set the Multi-Origin function at Parameter 5 (Multi-Origin Selection). A common origin (current position value) is applied to the programs from the top to what is set at Parameter 5. For each of subsequent programs, an individual origin (Current Position Value) can be set separately.

Example:

When Parameter 5 is set to 3, origins (Current Position Values) can be set as below.

Program No.	Origin (Current Position Value) Setting Value	Description
1	0	Common Origin When the Program number is set at "1", Programs 2 and 3 share it as the common origin.
2		
3		
4	100	Programs 4 to 8 allow the individual origin setting.
5	200	
6	300	
7	400	
8	500	

NOTES

In order to set Parameter 5 (Multi-Origin Selection), specify the current position value at Parameter 97 in advance. For the Current Position Setting details, refer to "4-6. Detection Range ("Scale") Setting".

●Origin Setting Methods

Origins can be set in the following two ways.

1. Using Parameter 97 (Current Position Setting)

Set an origin (current position value) for each program at Parameter 97.

For setting details, refer to “(2) Origin (Current Position Value) Setting by the Parameter”.

2. Using communication

Set an origin (current position value) using the host PLC.

For the communication function details, consult our representatives.

●Current Position Preset Measures

Current position values can be the Current Position Preset by Auto-detecting Travel Direction function.

The current position values specified as a common origin for some programs can be changed at once.

The current position values individually set for each program need to be preset separately.

In the above example, the current position values for Programs 1 to 3 will be changed together.

The values for Programs 4 to 8 need to be individually preset.

(1) Multi-Origin Function setting

① Select the parameter setting mode ("PRM").

Press and hold down the **MODE** key (more than 1 second).
The POSITION display will flicker to indicate mode selection is possible.

Press the **MODE** key a number of times until the parameter setting mode ("PRM") is shown.

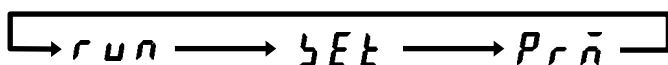
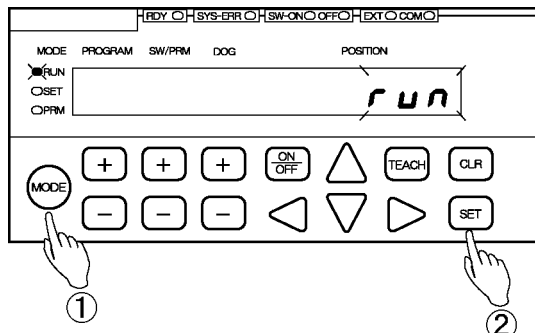

Run mode ("RUN") Switch setting mode ("SET") Parameter setting mode ("PRM")

MODE
 RUN
 SET
 PRM

MODE
 RUN
 SET
 PRM

MODE
 RUN
 SET
 PRM

② Confirm the mode selection

Press the **SET** key.
The mode is now set to the parameter setting mode ("PRM").

③ Select Parameter 5.

Use the **+** and **-** keys under the SW/PRM display to select "5".

④ Enter the setting value.

Use the **◀**, **▶**, **▲** and **▼** keys under the POSITION display to enter the setting value.

Setting range:
 The setting range can be selected at Parameter E0 (VARILIMIT Model Selection).
 E0 = 1 (8-program): 1 to 8
 E0 = 2 (32-program): 0 to 31

The entered value can be canceled by pressing the **CLR** key at this point.

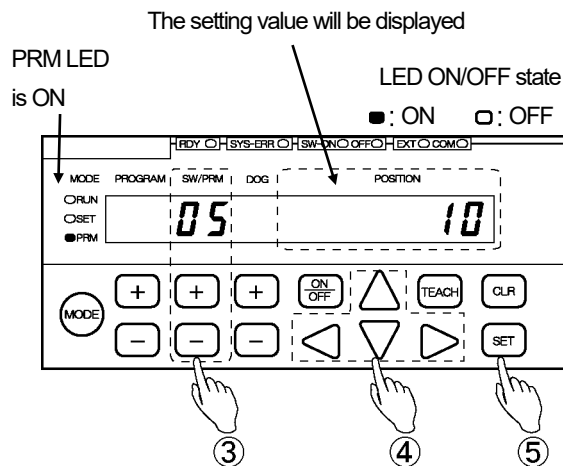

⑤ Confirm the entered value.

Press the **SET** key.
The POSITION display becomes solidly on, indicating that parameter setting is complete.

	NOTES
<p>In order to set Parameter 5 (Multi-Origin Selection), specify the current position value at Parameter 97 in advance. For the Current Position Setting details, refer to "4-6. Detection Range ("Scale") Setting".</p>	

(2) Origin (Current Position Value) Setting by the Parameter

① Select the parameter setting mode ("PRM").

Press and hold down the **MODE** key (more than 1 second).

The POSITION display will flicker to indicate mode selection is possible.

Press the **MODE** key a number of times until the parameter setting mode ("PRM") is shown.

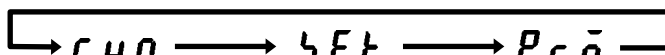
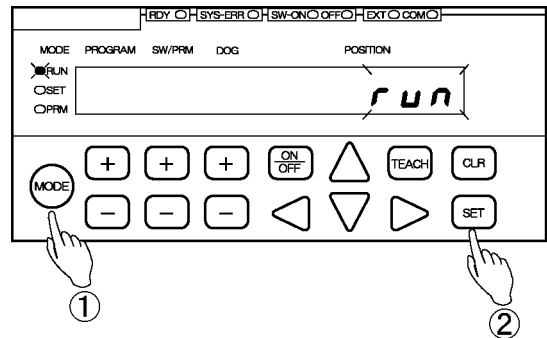

Run mode ("RUN")	Switch setting mode ("SET")	Parameter setting mode ("PRM")
MODE	MODE	MODE
<input checked="" type="checkbox"/> RUN	<input type="checkbox"/> RUN	<input type="checkbox"/> RUN
<input type="checkbox"/> SET	<input checked="" type="checkbox"/> SET	<input type="checkbox"/> SET
<input type="checkbox"/> PRM	<input type="checkbox"/> PRM	<input checked="" type="checkbox"/> PRM

② Confirm the mode selection

Press the **SET** key.

The mode is now set to the parameter setting mode ("PRM").

③ Select Parameter 97.

Use the **+** and **-** keys under the SW/PRM display to select "97".

④ Select the program No.

Press the **+** or the **-** key under the PROGRAM display to select the program No. for setting the origin (current position value).

⑤ Enter the origin (current position value)

Use the **<**, **>**, **△** and **▽** keys under the POSITION display to enter the setting value.

The entered value can be canceled by pressing the **CLR** key at this point.

When a common origin is set, a dot "." will be solidly on.

The setting value will be displayed

LED ON/OFF state
 : ON
 : OFF

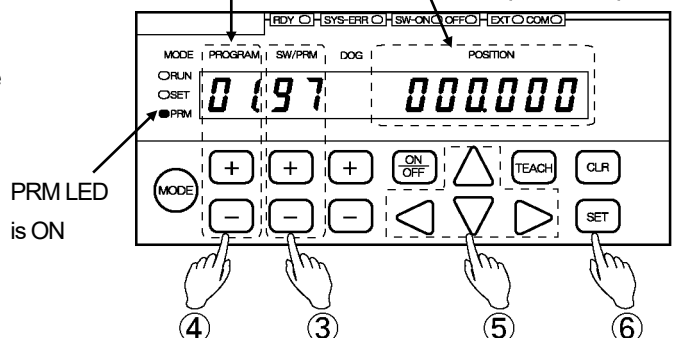

⑥ Confirm the entered value.

Press the **SET** key.

The POSITION display becomes solidly on, indicating that parameter setting is complete.

4-20. Setting the Preset Error Absorption Function

The Preset Error Absorption function enables detection of the correct position of the workpiece without a position gap. This can be completed even when the workpiece cannot move to the movable end or the origin, as long as it stays within the range of error absorption.

For example:

When using the CYLNUC cylinder, an origin (zero position) is set by holding a workpiece at the forward end or the backward end. Even when the workpiece cannot move to the end due to any obstacle, the Current Position Preset enables detection of the correct position by considering the thickness of the obstacle.

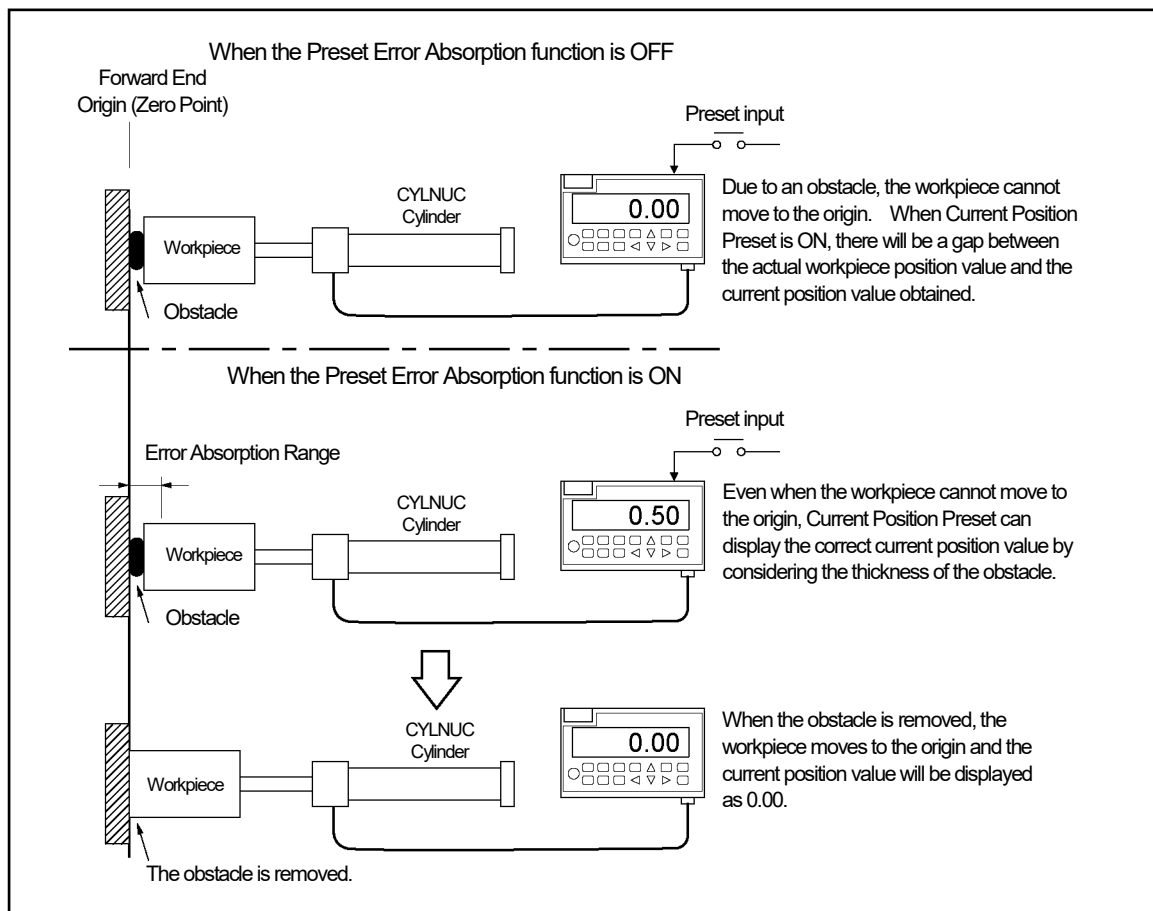

When Parameter 12 is set to 1, the Preset Error Absorption function becomes enabled.

Turn on the current position preset input after moving the workpiece into the error absorption range. The current position value will be changed by absorbing the error.

NOTES

The preset error absorption function cannot use when connecting to the single-turn type ABSOCODER (VRE).

● **Error Absorption Range**

The range for accepting error absorption changes depending on the ABSOCODER type you use.

ABSOCODER	Error Absorption Range	Remarks
MRE-32	±(Scale Length/64)	
MRE-G[]		[]: Number of rotation
CYLNUC/Rod sensor (VLS-12.8)	±6.4mm	
CYLNUC/Inrodsensor (IRS-51.2P)	±25.6mm	

● **Conceptual Diagram**

This is a conceptual diagram of operation using CYLNUC.

Described below is an example of the preset within and outside the error absorption range. A machine is moved to current position value 0 either in ① or ② direction.

Conditions

- Current Position Preset function: Selection (Parameter 92) 1 (Enabled)
- Preset Error Absorption function: Enabled/Disabled (Parameter 12) 1 (Enabled)
- "FWD Current Position Preset" Value 1 (Parameter 7) 0
- "RVS Current Position Preset" Value 1 (Parameter 6) 0

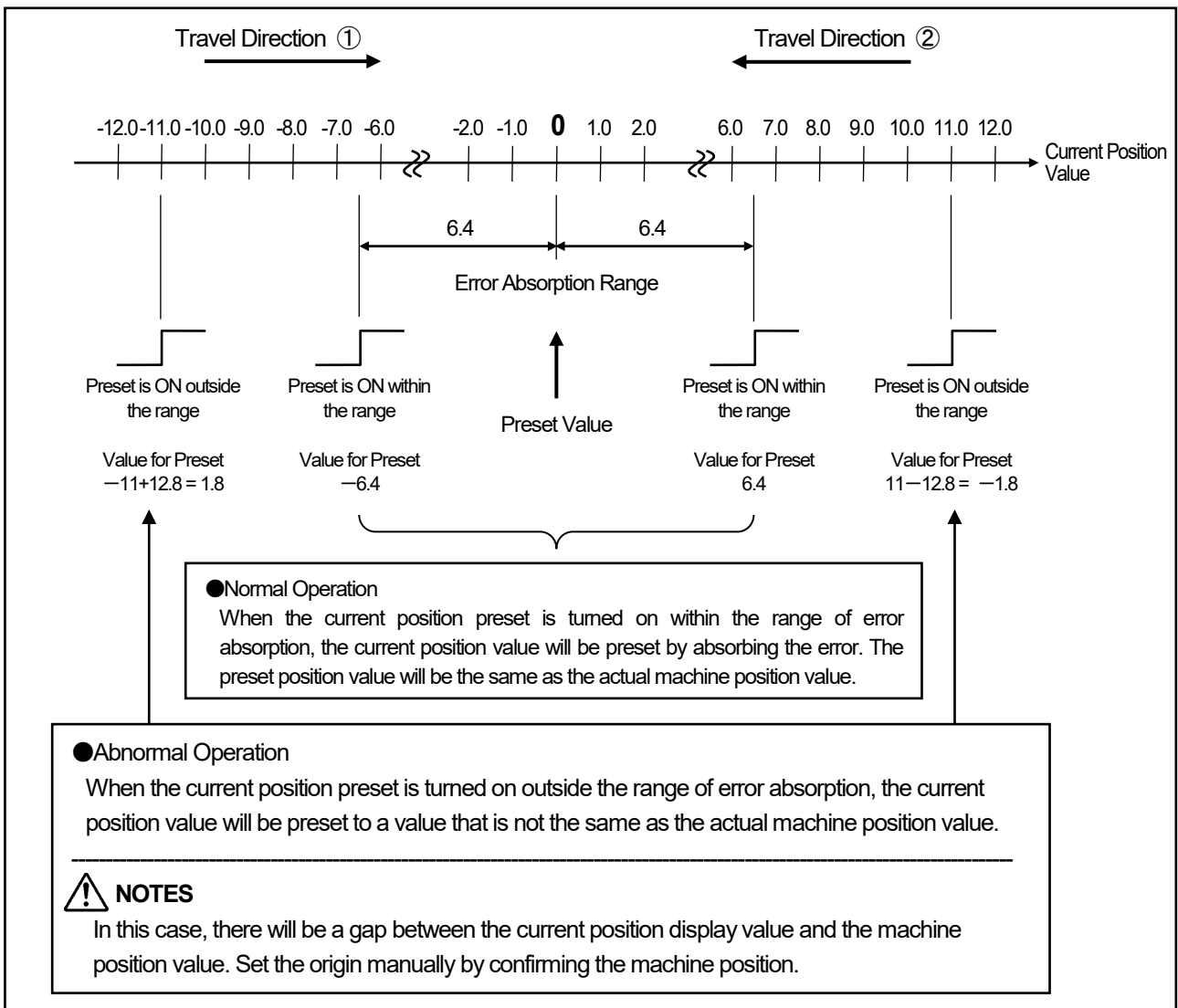

(1) Preset Error Absorption Function Setting

① Select the parameter setting mode ("PRM").

Press and hold down the **MODE** key (more than 1 second).

The POSITION display will flicker to indicate mode selection is possible.

Press the **MODE** key a number of times until the parameter setting mode ("PRM") is shown.

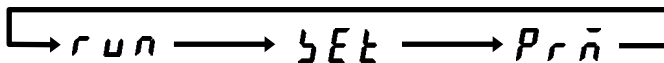
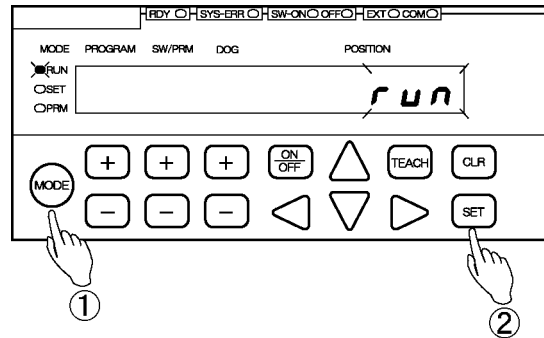

Run mode ("RUN")	Switch setting mode ("SET")	Parameter setting mode ("PRM")
MODE	MODE	MODE
<input checked="" type="checkbox"/> RUN	<input type="checkbox"/> RUN	<input type="checkbox"/> RUN
<input type="checkbox"/> SET	<input checked="" type="checkbox"/> SET	<input type="checkbox"/> SET
<input type="checkbox"/> PRM	<input type="checkbox"/> PRM	<input checked="" type="checkbox"/> PRM

② Confirm the mode selection

Press the **SET** key.

The mode is now set to the parameter setting mode ("PRM").

③ Select Parameter 12.

Use the **+** and **-** keys under the SW/PRM display to select "12".

④ Select the setting value.

Use the **△** and **▽** keys under the POSITION display to select the setting value.

Options:

- 0: Disabled
- 1: Enabled

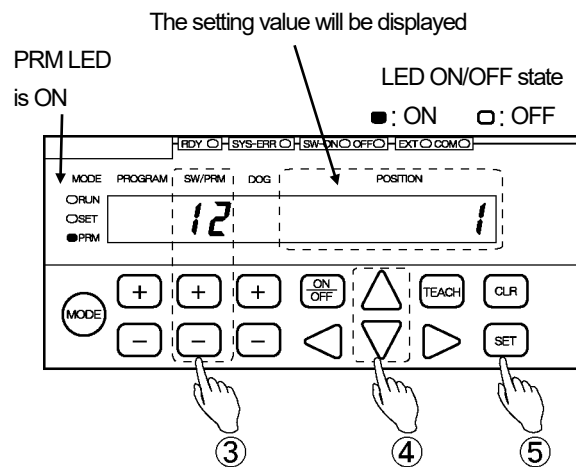

The selected value can be canceled by pressing the **CLR** key at this point.

⑤ Confirm the selected value.

Press the **SET** key.

The POSITION display will become solidly on, indicating that parameter setting is complete.

4-21. Setting the Limitswitchless Preset Function

The Limitswitchless Preset function can be used for such processes, where cylinders are used for injection molding, die-casting, low-pressure casting, and hydraulic press.

Even when a limitswitch is not available due to high-temperature or any other adverse circumstances, a stroke of the machine enables the origin setting at the stroke end (forward or backward).

For example:

During a test run, confirmation of the machine stroke and the origin setting can be performed at the same time. Furthermore, a combination use with the Preset Error Absorption function will eliminate the position gap due to trapped obstacles.

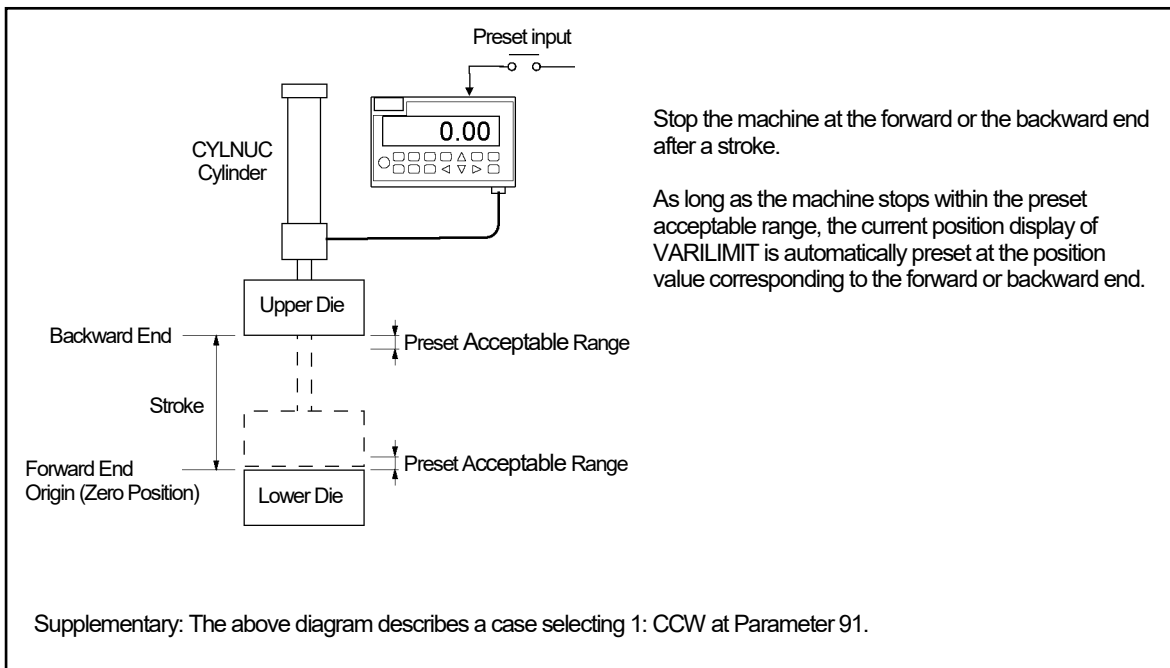

NOTES

The limitswitchless preset function cannot use when connecting to the single-turn type ABSOCODER (VRE).



●Preset Acceptable Range

The range for accepting preset changes depending on the ABSOCODER type you use.

ABSOCODER	Error Absorption Range	Remarks
MRE-32	±(Scale Length/64)	
MRE-G[]		[]: Number of rotation
CYLNUC/Rod sensor (VLS-12.8)	±6.4mm	
CYLNUC/Inrodsensor (IRS-51.2P)	±25.6mm	

●Parameter Setting

Specify the following six items at parameters.

1. Parameter 92 (Current Position Preset Function Selection)
2. Parameter 82 (Current Position Preset Error Selection)
3. Parameter 13 (Limitswitchless Preset Function: Enabled/Disabled)

4. Parameter 14, 17 (Stop Decision Time 1, 2 during Limitswitchless Preset)
To specify the time to confirm if the machine stops after a stroke within the preset range.

5. Parameter 15, 18 (Limitswitchless Preset Value 1, 2)
To specify the minimum position value of a stroke (the forward end value in the above diagram).

6. Parameter 16, 19 (Limitswitchless Preset Stroke 1, 2)
To specify the value of the machine's stroke.



●Limitswitchless Preset Operational Procedures

Described under the conditions below using the above diagram as an example.

Conditions

- Stop Decision Time 1 during Limitswitchless Preset (Parameter 14)..... 1s
- Limitswitchless Preset Value 1 (Parameter 15)..... 0.0
- Limitswitchless Preset Stroke 1 (Parameter 16)..... 500.0

(1) When activating the preset at the backward end after a stroke from the forward end

- ① Turn on the current position preset input 1 and start the machine.
 - ② Stop the machine after a stroke within the preset range.
 - ③ Confirm that the machine is stopped. (Parameter: Stop Decision Time during Limitswitchless Preset)
 - ④ The current position value will be preset at the backward end.
The current position value will be preset to the value predetermined at the parameter as follows:
[Limitswitchless Preset Value] + [Limitswitchless Preset Stroke Value]
 - ⑤ Turn off the current position preset input.
- The limitswitchless preset operation will be completed.

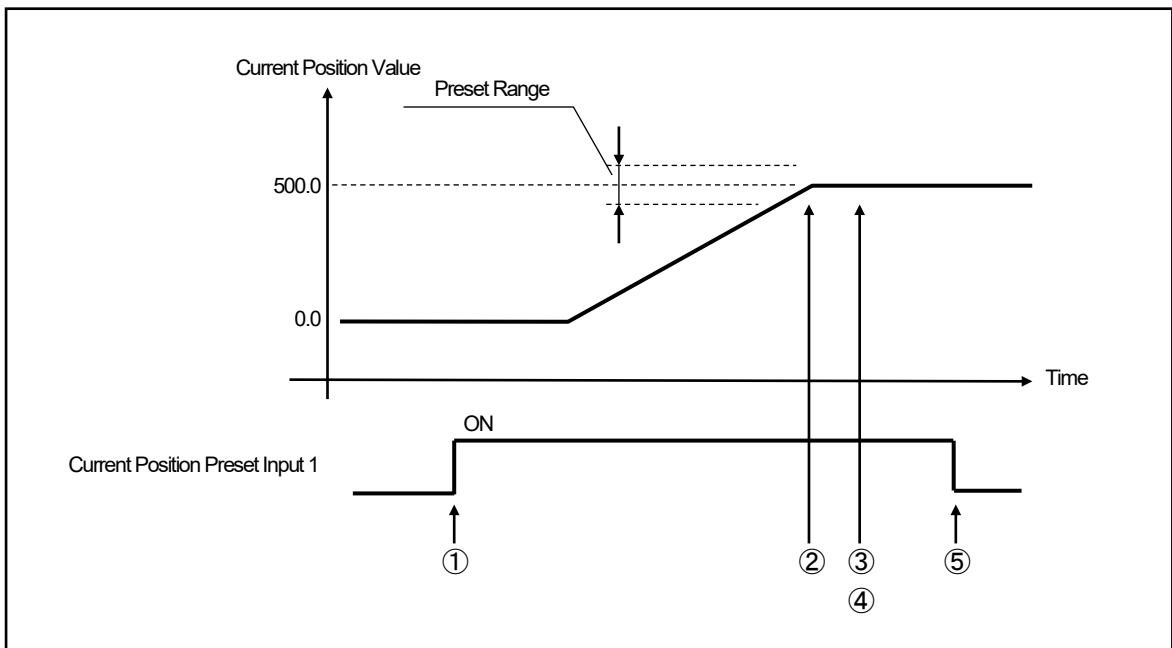



(2) When activating preset at the forward end after a stroke from the forward end

- ① Turn on the current position preset input 1 and start the machine.
 - ② Stop the machine after a to-and-from stroke within the preset range.
 - ③ Confirm that the machine is stopped. (Parameter: Stop Decision Time during Limitswitchless Preset)
 - ④ The current position value will be preset at the forward end.
The current position value will be preset to the value predetermined at the parameter as follows:
[Limitswitchless Preset Value]
 - ⑤ Turn off the current position preset input.
- The limitswitchless preset operation will be completed.

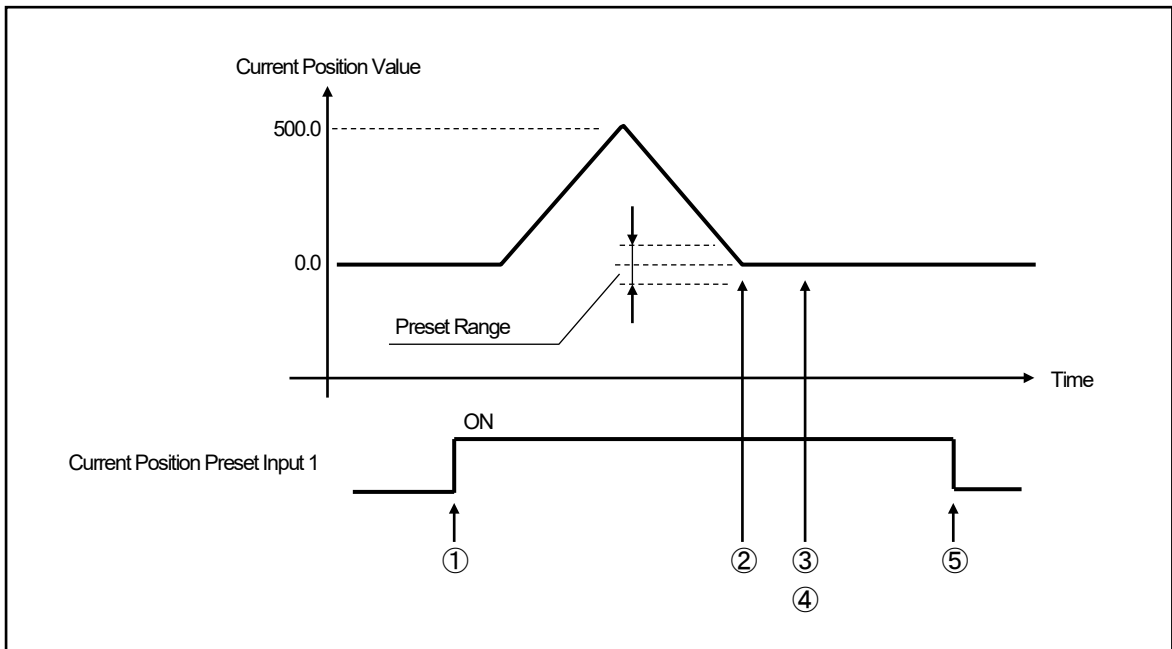

●Preset Error

Preset Error (En23) will occur when turning off the current position preset input during operation.

Specify the following six items for setting the Limitswitchless Preset function.

1. Parameter 92 (Current Position Preset Function Selection)
2. Parameter 82 (Current Position Preset Error Selection)
3. Parameter 13 (Limitswitchless Preset function: Enabled/Disabled)
4. Parameters 14, 17 (Stop Decision Times 1, 2 during Limitswitchless Preset)
5. Parameters 15, 18 (Limitswitchless Preset Values 1, 2)
6. Parameters 16, 19 (Limitswitchless Preset Strokes 1, 2)

POINT:

The Limitswitchless Preset function stores two setting values. One value can be set by the combined use of Parameters 92, 82, 13, 14, 15, 16 and the other can be set by Parameters 92, 82, 13, 17, 18, 19.

The following steps (1)-(5) describe an example of the former combination.

For setting Parameters 92 and 82, refer to "4-7. Current Position Preset Setting".

(1) Parameter setting mode ("PRM") selection

① Select the parameter setting mode ("PRM").

Press and hold down the  key (more than 1 second).

The POSITION display will flicker to indicate mode selection is possible.

Press the  key a number of times until the parameter setting mode ("PRM") is shown.

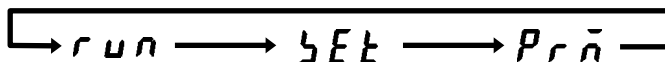
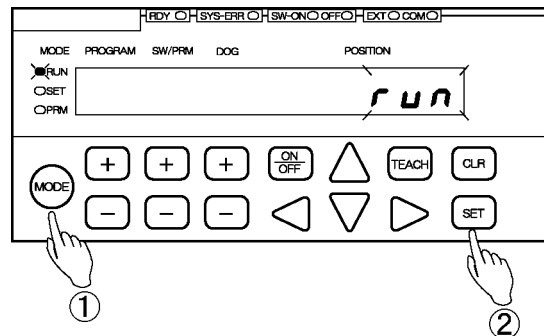

Run mode ("RUN")	Switch setting mode ("SET")	Parameter setting mode ("PRM")
MODE	MODE	MODE
<input checked="" type="radio"/> RUN	<input type="radio"/> RUN	<input type="radio"/> RUN
<input type="radio"/> SET	<input checked="" type="radio"/> SET	<input type="radio"/> SET
<input type="radio"/> PRM	<input type="radio"/> PRM	<input checked="" type="radio"/> PRM

② Confirm the mode selection

Press the  key.

The mode is now set to the parameter setting mode ("PRM").

(2) Limitswitchless Preset Enabled/Disabled setting

① Select Parameter 13.

Use the **+** and **-** keys under the SW/PRM display to select "13".

② Select the setting value.

Use the **△** and **▽** keys under the POSITION display to select the setting value.

Options:

- 0: Disabled
- 1: Enabled

The selected value can be canceled by pressing the **CLR** key at this point.

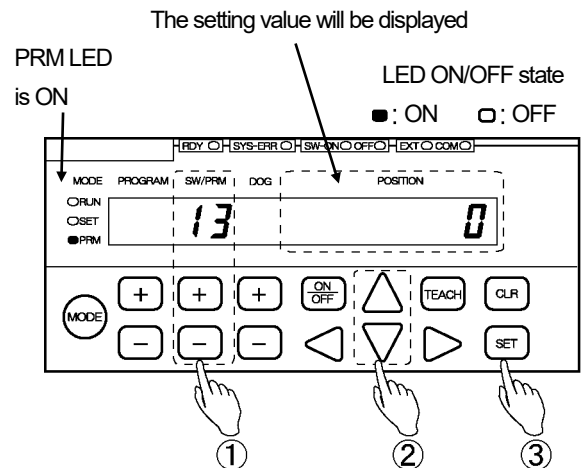

③ Confirm the selected value.

Press the **SET** key.

The POSITION display will become solidly on, indicating that parameter setting is complete.

(3) Stop Decision Times during Limitswitchless Preset setting

① Select Parameter 14 (17).

Use the **+** and **-** keys under the SW/PRM display to select "14 (17)".

② Enter the setting value.

Use the **◀**, **▶**, **△** and **▽** keys under the POSITION display to enter the setting value.

Setting range:
0.100 to 9.999 [s]

The entered value can be canceled by pressing the **CLR** key at this point.

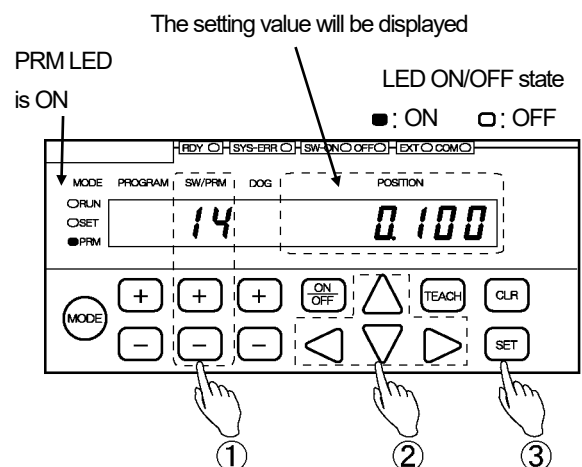

③ Confirm the entered value.

Press the **SET** key.

The POSITION display becomes solidly on, indicating that parameter setting is complete.

(4) Limitswitchless Preset Value setting

① Select Parameter 15 (18).

Use the **+** and **-** keys under the SW/PRM display to select "15 (18)".

② Enter the setting value.

Use the **◀**, **▶**, **▲** and **▼** keys under the POSITION display to enter the setting value.

Setting range:

-999999 to 999999

The entered value can be canceled by pressing the **CLR** key at this point.

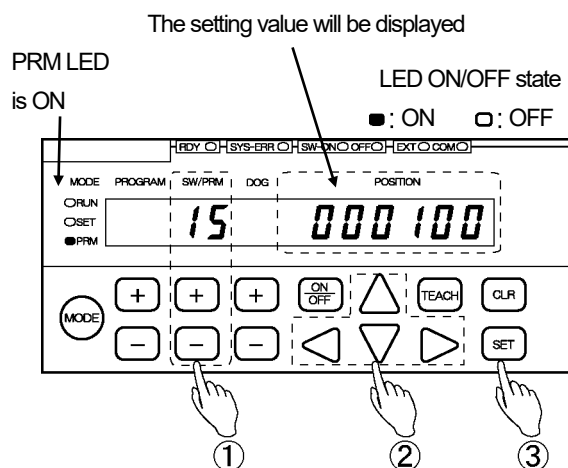

③ Confirm the entered value.

Press the **SET** key.

The POSITION display becomes solidly on, indicating that parameter setting is complete.

(5) Limitswitchless Preset Stroke setting

① Select Parameter 16 (19).

Use the **+** and **-** keys under the SW/PRM display to select "16 (19)".

② Enter the setting value.

Use the **◀**, **▶**, **▲** and **▼** keys under the POSITION display to enter the setting value.

Setting range:

0 to 999999

The entered value can be canceled by pressing the **CLR** key at this point.

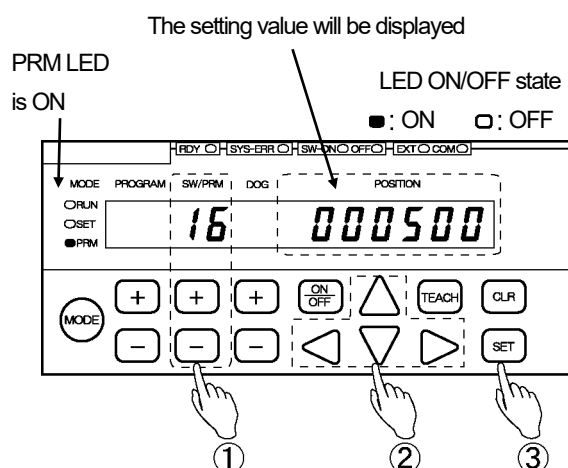

③ Confirm the entered value.

Press the **SET** key.

The POSITION display becomes solidly on, indicating that parameter setting is complete.

4-22. Setting the Limitswitch Timer Function

The Limitswitch Timer function enables settings of the ON/OFF positions, the ON delay timer and ON time in the switch output data.

When a workpiece comes to the zone between ON and OFF positions that are predetermined, an actuator can start for processing for a certain period.

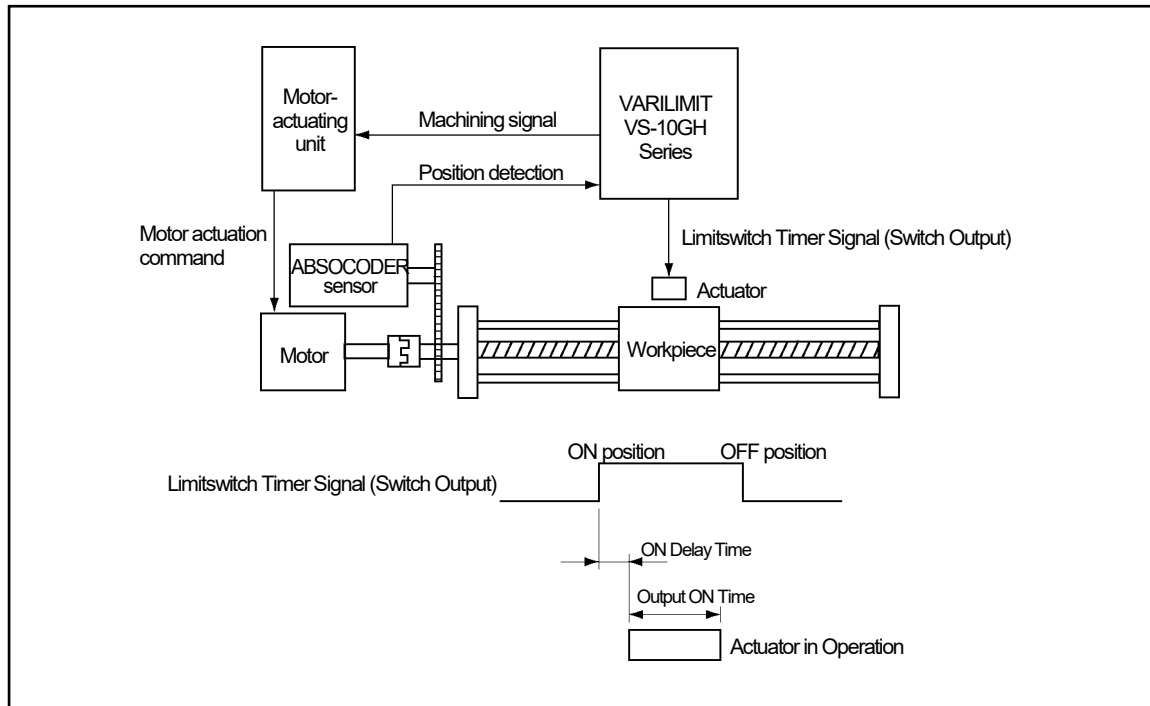

Set this function at Parameter 21 (Number of Switches Valid for Limitswitch Timer Function). The switch outputs from 1 to what is set at Parameter 21 are enabled for the Limitswitch Timer function.

● Limitswitch Timer Function

When a workpiece comes to the zone between ON and OFF positions that are predetermined, the ON delay timer will be activated. After the period of time specified with the ON delay timer, an actuator will be ON for processing limitswitch timer signals for the specified period.

When the workpiece travels while the limitswitch timer signal is ON and comes out of the zone between the ON and OFF positions, the limitswitch timer signal will turn OFF.

(1) Limitswitch Timer Function setting

① Select the parameter setting mode ("PRM").

Press and hold down the **MODE** key (more than 1 second).
The POSITION display will flicker to indicate mode selection is possible.

Press the **MODE** key a number of times until the parameter setting mode ("PRM") is shown.

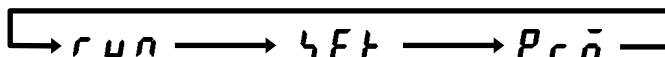
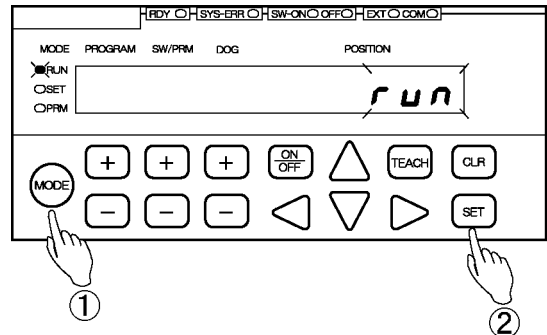

Run mode ("RUN") Switch setting mode ("SET") Parameter setting mode ("PRM")

MODE	MODE	MODE
<input checked="" type="checkbox"/> RUN	<input type="checkbox"/> RUN	<input type="checkbox"/> RUN
<input type="checkbox"/> SET	<input checked="" type="checkbox"/> SET	<input type="checkbox"/> SET
<input type="checkbox"/> PRM	<input type="checkbox"/> PRM	<input checked="" type="checkbox"/> PRM

② Confirm the mode selection

Press the **SET** key.
The mode is now set to the parameter setting mode ("PRM").

③ Select Parameter 21.

Use the **+** and **-** keys under the SW/PRM display to select "21".

④ Enter the setting value.

Use the **◀**, **▶**, **▲** and **▼** keys under the POSITION display to enter the setting value.

Setting range:
Switches from 1 to what is set at the parameter will be enabled.
0: Disabled
1 to 30: Enabled

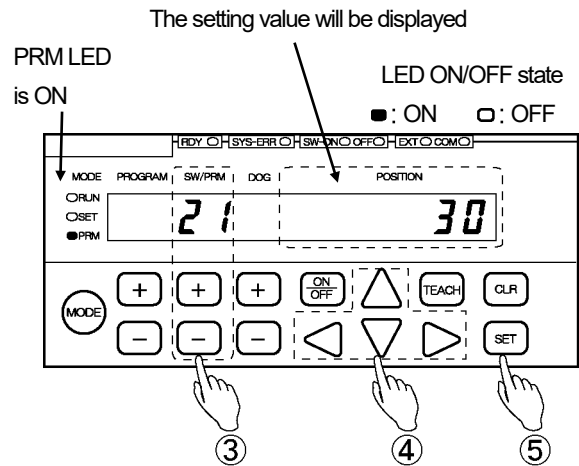

The entered value can be canceled by pressing the **CLR** key at this point.

⑤ Confirm the entered value.

Press the **SET** key.
The POSITION display becomes solidly on, indicating that parameter setting is complete.

(2) Limitswitch Timer Value setting

① Select the switch setting mode ("SET").

Press and hold down the **(MODE)** key (more than 1 second).

The POSITION display will flicker to indicate mode selection is possible.

Press the **(MODE)** key a number of times until the switch setting mode ("SET") is shown.

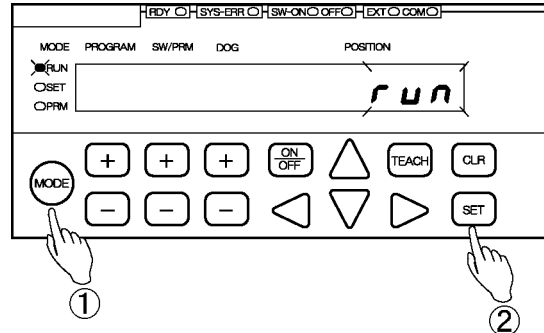

Run mode ("RUN") Switch setting mode ("SET") Parameter setting mode ("PRM")

MODE
 RUN
 SET
 PRM

MODE
 RUN
 SET
 PRM

MODE
 RUN
 SET
 PRM

② Confirm the mode selection.

Press the **(SET)** key.

The mode is now set to the switch setting mode ("SET").

③ Select the Program Number.

Use the **(+)** and **(-)** keys under the PROGRAM display to select the Program Number.

Selection Range:

Depends on the setting at Parameter E0 (VARILIMIT Mode Selection).

E0 = 1 (8 programs): 1 to 8

E0 = 2 (32 programs): 0 to 31

SET LED is ON

LED ON/OFF state
 : ON : OFF

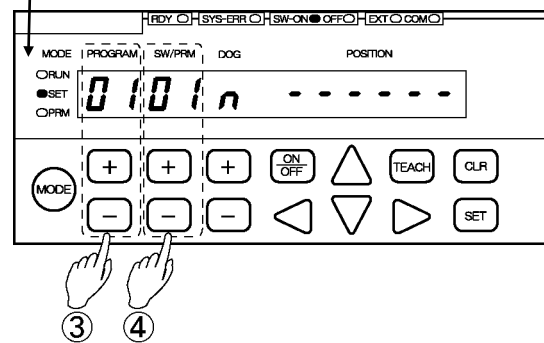

④ Select the Switch Number. *1

Press the **(+)** or **(-)** key under the SW/PRM display and select the switch number specified for the Limitswitch Timer function.

POINT:

*1: "n" will be shown in the DOG display of the switch output that is assigned for the Limitswitch Timer function.

- ⑤ To specify the position to start operation for the limitswitch timer output (ON position), show "n" in the DOG display. *2
 Press the $\boxed{+}$ or $\boxed{-}$ key under the DOG display to show "n" in the DOG display.

POINT:

*2: Each time the $\boxed{+}$ or $\boxed{-}$ key under the DOG display is pressed, the display will show "n" and "d" alternately.

- ⑥ Enter the value of the position to start operation
 Use \triangleleft , \triangle , \triangleup , \triangledown keys under the POSITION display to enter the value of the position to start operation.
 The POSITION display will flicker with the entered value.

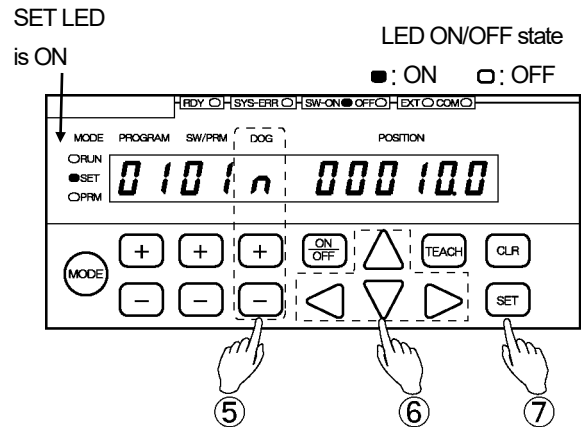

Setting Range: -999999 to 999999

The entered value can be canceled by pressing the \boxed{CLR} key at this point.

- ⑦ Confirm the value of the position to start operation

Press the \boxed{SET} key.

The POSITION display will become solidly on, indicating that the setting is complete.

- ⑧ To specify the position to finish operation for the limitswitch timer output (OFF position), show "F" in the DOG display. *3
 Press the $\boxed{ON/OFF}$ key to show "F" in the DOG display.

POINT:

*3: Each time the $\boxed{ON/OFF}$ key is pressed when "n" is shown in the display, the DOG display will show "n" and "F" alternately.

- ⑨ Enter the value of the position to finish operation
 Use \triangleleft , \triangle , \triangleup , \triangledown keys under the POSITION display to enter the value of the position to finish operation.
 The POSITION display will flicker with the entered value.

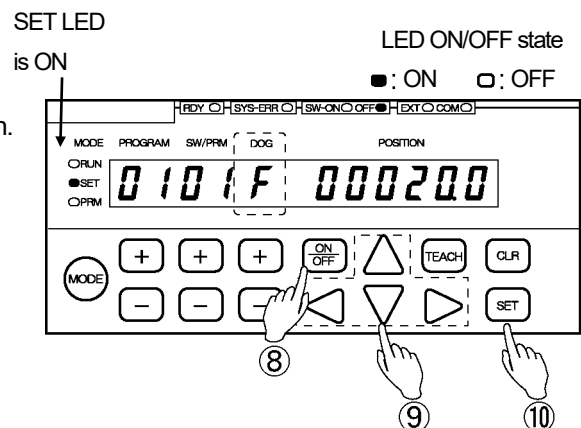

Setting Range: -999999 to 999999

The entered value can be canceled by pressing the \boxed{CLR} key at this point.

- ⑩ Confirm the value of the position to finish operation

Press the \boxed{SET} key.

The POSITION display will become solidly on, indicating that the setting is complete.

- ⑪ To set the ON delay timer, show “d” in the DOG display.

Use the **+** or **-** key under the DOG display to show “d” in the DOG display.

POINT:

*4: Each time the **+** or **-** key under the DOG display is pressed, the display will show “n” and “d” alternately.

- ⑫ Enter the value of the ON delay timer

Use **◀**, **▶**, **▲**, **▼** keys under the POSITION display to enter the value of the ON delay timer.

The POSITION display will flicker with the entered value.

Setting Range: 0 to 999999 [ms]

The entered value can be canceled by pressing the **CLR** key at this point.

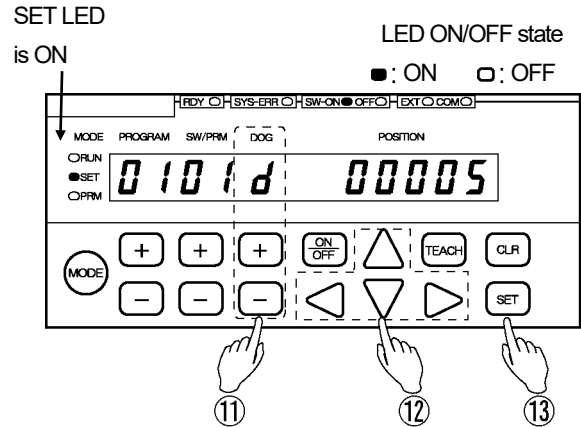

- ⑬ Confirm the value of the ON delay timer

Press the **SET** key.

The POSITION display will become solidly on, indicating that the setting is complete.

- ⑭ To specify the output time, show “t” in the DOG display.

Press the **ON/OFF** key to show “t” in the DOG display.

POINT:

*5: Each time the **ON/OFF** key is pressed when “d” is shown in the display, the DOG display will show “d” and “t” alternately.

- ⑮ Enter the value of the output time

Use **◀**, **▶**, **▲**, **▼** keys under the POSITION display to enter the value of the output time.

The POSITION display will flicker with the entered value.

Setting Range: 0 to 999999 [ms]

The entered value can be canceled by pressing the **CLR** key at this point.

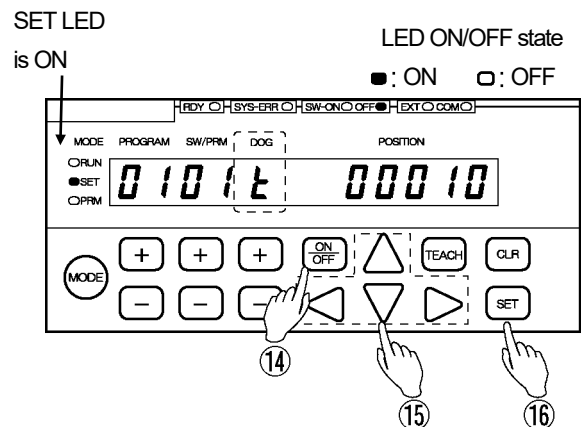

- ⑯ Confirm the value of the output time

Press the **SET** key.

The POSITION display will become solidly on, indicating that the setting is complete.

- ⑰ Repeat the above steps as required

Repeat steps ③-⑯ according to the number of switches specified for the Limitswitch Timer function.

4-23. Setting Analog Position/Speed Output

This setting applies to the following voltage and current output models:

Applicable models: VS-10GH-A, VS-10GH-A-1 (voltage output models) and VS-10GH-C-1 (current output models)

This is a function to output positions (speeds) using voltage (current) signals.

Two channels are provided for the analog output. The output item can be specified for each channel.

With the voltage output models, the range of positions (speeds) and voltage can be specified as required.

With the current output models, the range of positions (speeds) can be specified as required. The current range is fixed to 4-20mA.

Deadbands can be set for the both.



NOTES

Do not control by the speed output.
Use the speed output for monitoring.

(1) Parameter Setting

Specify the following 5 items at parameters.

● Selecting either position output or speed output

The parameters below are common to the voltage and current output models.

The output item can be selected either the position or the speed.

For Channel 1: Parameter 28 (Ch. 1 Output Selection)

For Channel 2: Parameter 36 (Ch. 2 Output Selection)

● Setting the voltage range

The parameters below apply to the setting of voltage output models only.

The voltage range where setting is possible is between -10.00V and +10.00V.

The current range is fixed to 4-20mA for the current output models. No parameter setting is required for the current range.

For Channel 1: Parameter 26 (Ch. 1 Minimum Output Voltage (Vmin)), Parameter 27 (Ch. 1 Maximum Output Voltage (Vmax))

For Channel 2: Parameter 34 (Ch. 2 Minimum Output Voltage (Vmin)), Parameter 35 (Ch. 2 Maximum Output Voltage (Vmax))

●Setting the position/speed range

The parameters below are common to the voltage and current output models.

For the position output, the position range where setting is possible should be within the detection range specified at Scale Length (Parameter 99) and Minimum Current Position Value (Parameter 98).

For the speed output, the setting unit is "Current Position Value (Scale Value)/s".

For example, when the resolution of the current position value display is in 0.1mm, the input of 10.0 will result in the speed of 10mm/s.

For Channel 1: Parameter 29 (Ch. 1 Minimum Output Position/Speed), Parameter 30 (Ch. 1 Maximum Output Position/Speed)

For Channel 2: Parameter 37 (Ch. 2 Minimum Output Position/Speed), Parameter 38 (Ch. 2 Maximum Output Position/Speed)

●Setting the Deadband Position (Speed) and Width

The parameters below are common to voltage and current output models.

For Ch. 1: Parameter 24 (Ch. 1 Deadband Width), Parameter 25 (Ch. 1 Deadband Position/Speed)

For Ch. 2: Parameter 32 (Ch. 2 Deadband Width), Parameter 33 (Ch. 2 Deadband Position/Speed)

●Setting the Speed Sampling Time and Number of Speed Gates

The parameters below are common to voltage and current output models.

The parameters are also common to Channels 1 and 2.

Parameter 23 (Speed Sampling Time), Parameter 22 (Number of Speed Gates)

Set this parameter for the speed output.

Specify this setting if required.

During updating the speed output, sampling of the current position values is performed at the specified speed sampling time.

As the speed gates increase, the more stable speed will be detected.

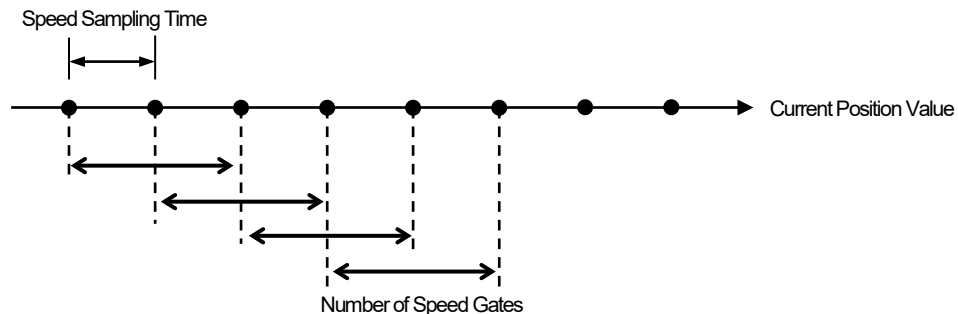

(2) Example of Setting a Voltage Output Model

- When [Minimum Output Position/Speed] < [Maximum Output Position/Speed]
Output from -8.00V to +8.00V at from Point A to Point B

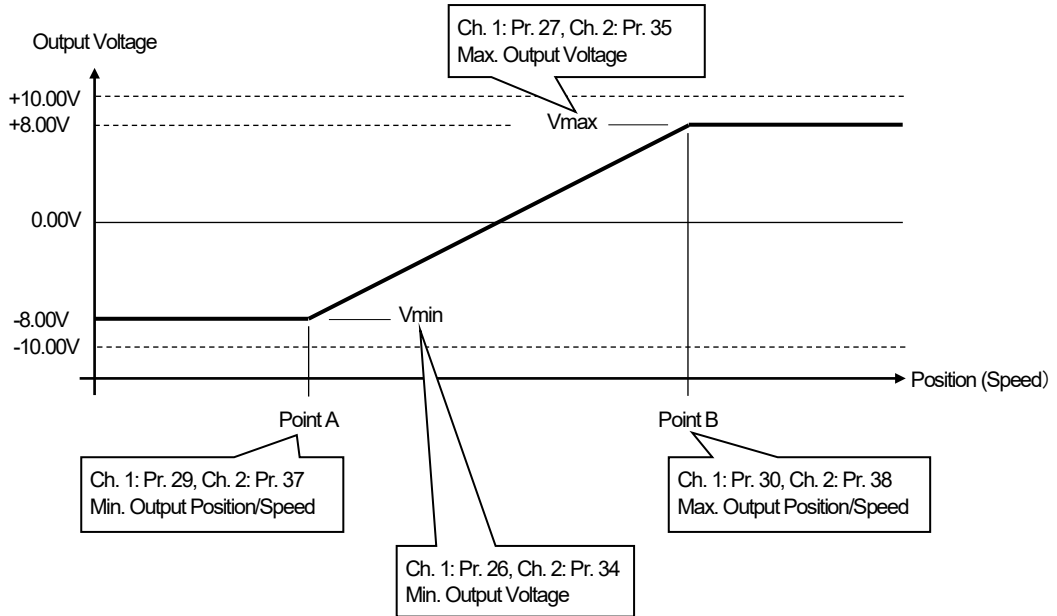

- When [Minimum Output Position/Speed] > [Maximum Output Position/Speed]
Output from +8.00V to -8.00V at from Point C to Point D

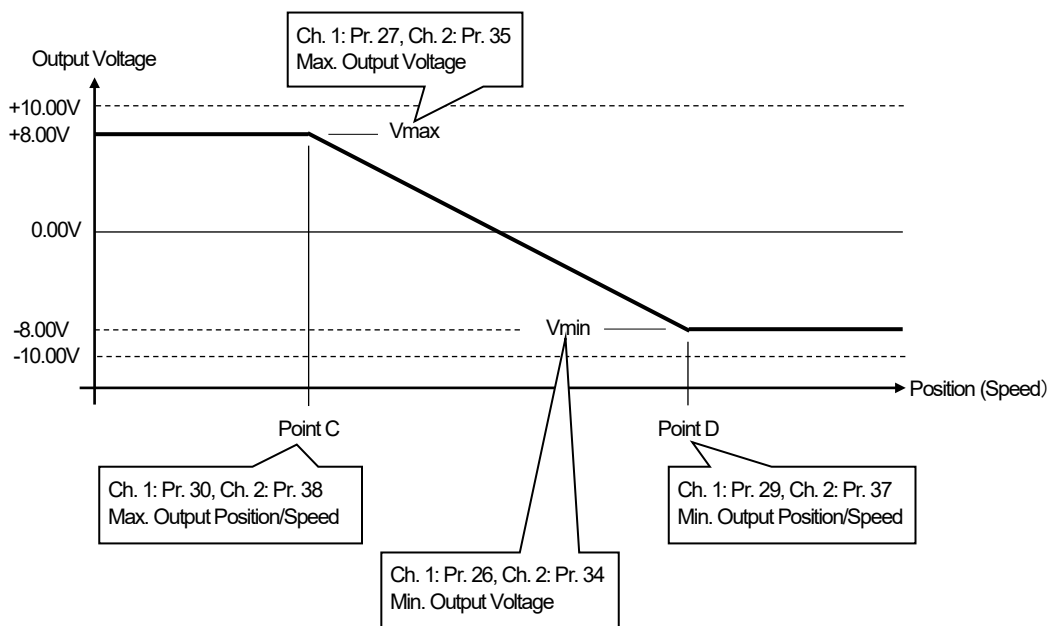

- When specifying the deadband width and position (speed)
Setting the deadband at Point E (0V)

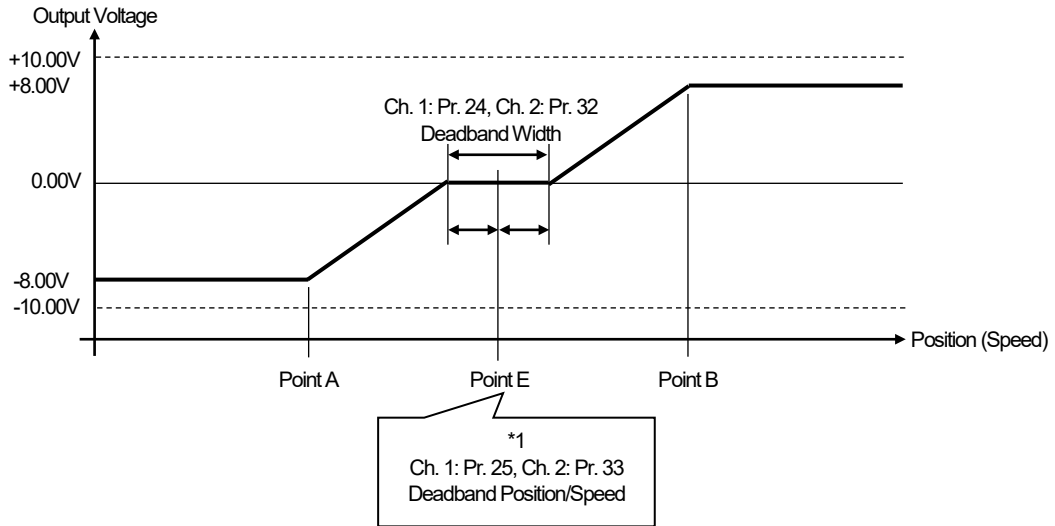

*1: The deadband position/speed is set at the center of the deadband width.

NOTES

Note that the output voltage will change at once when the minimum output position/speed (Parameters 29, 37) or the maximum output position/speed (Parameters 30, 38) is specified outside the detection range. Remember to set those values within the detection range.

Example of output from -8.00V to +8.00V at from Point A to Point B

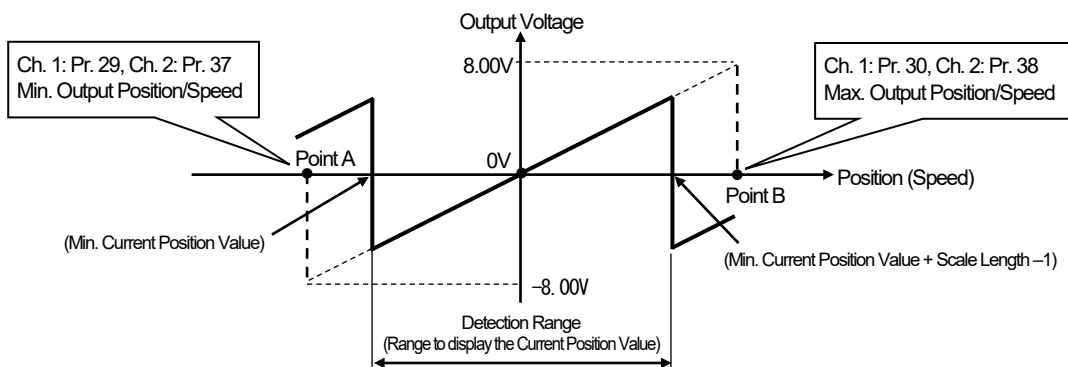



OPERATION

EXTENDED MODE (Pr. E0=1, 2)

(3) Example of Setting a Current Output Model

The current range is fixed to 4mA - 20mA.

- When [Minimum Output Position/Speed] < [Maximum Output Position/Speed]
Output from Point A to Point B

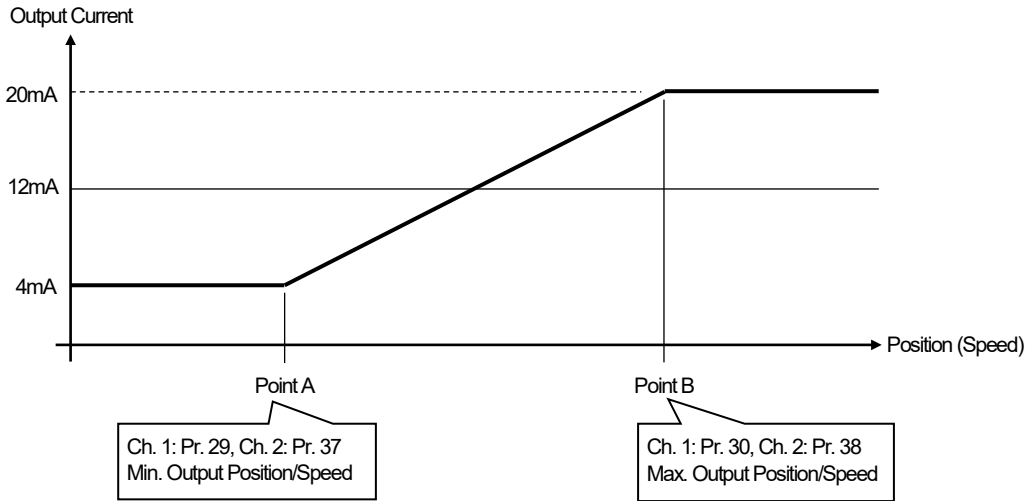

- When [Minimum Output Position/Speed] > [Maximum Output Position/Speed]
Output from Point C to Point D

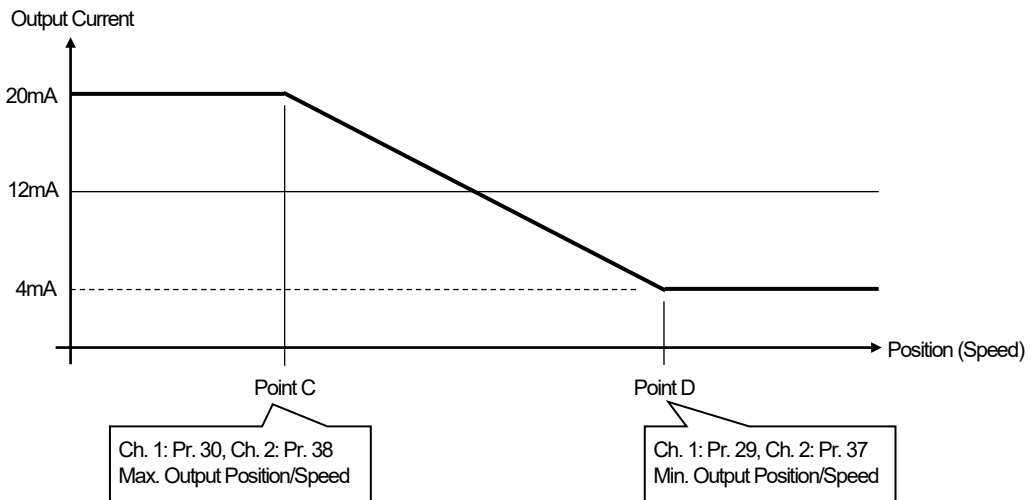



OPERATION

EXTENDED MODE (Pr. E0=1, 2)

●When specifying the deadband width and position (speed)

Setting the deadband at Point E (12mA)

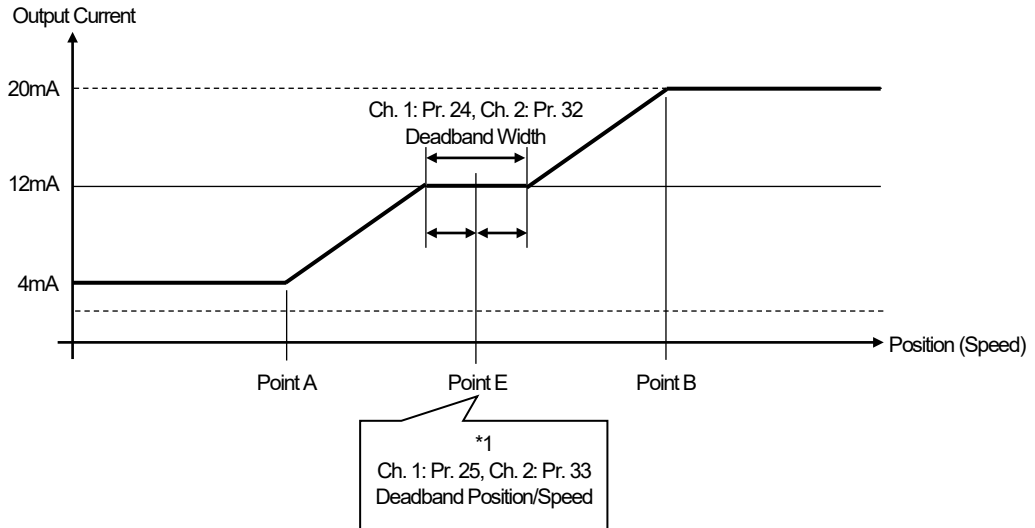

*1: The deadband position/speed is set at the center of the deadband width.



NOTES

Note that the output current will change at once when the minimum output position/speed (Parameters 29, 37) or the maximum output position/speed (Parameters 30, 38) is specified outside the detection range. Remember to set those values within the detection range.

Example of output from -8.00V to +8.00V, from Point A to Point B

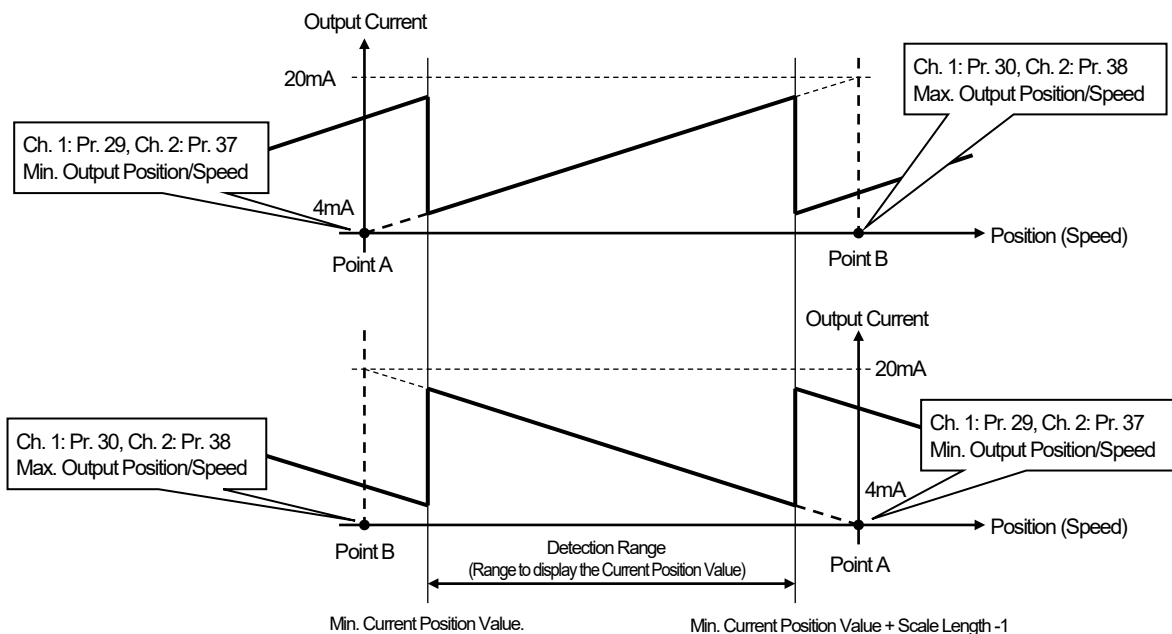

4-23-1. Selecting the position output or the speed output

This setting applies to the following models:

Voltage Output Models: VS-10GH-A, VS-10GH-A-1

Current Output Model: VS-10GH-C-1

The signal type can be chosen for the analog output connector.

- Position Output
- Speed Output

POINT:

Two channels are provided for the analog output. The signal type can be specified for each channel.

Ch. 1: Set it at Parameter 28.

Ch. 2: Set it at Parameter 36.

In the steps below, the setting of Ch. 1 using Parameter 28 is described.

Set the parameter in the following steps.

① Select the parameter setting mode ("PRM").

Press and hold down the **MODE** key (more than 1 second).

The POSITION display will flicker to indicate mode selection is possible.

Press the **MODE** key a number of times until the parameter setting mode ("PRM") is shown.

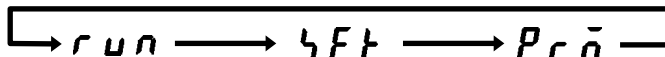
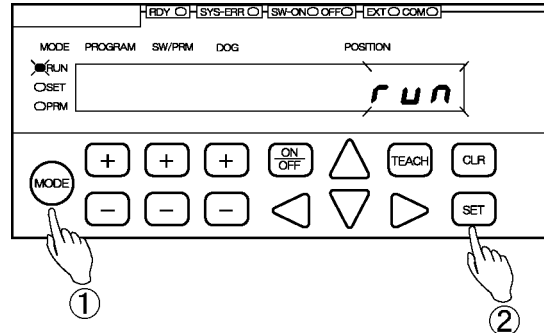

Run mode ("RUN") Switch setting mode ("SET") Parameter setting mode ("PRM")

MODE
 RUN
 SET
 PRM

MODE
 RUN
 SET
 PRM

MODE
 RUN
 SET
 PRM

② Confirm the mode selection

Press the **SET** key.

The mode is now set to the parameter setting mode ("PRM").

③ Select Parameter 28.

Use the **+** and **-** keys under the SW/PRM display to select "28".

④ Select the setting value.

Use the **△** and **▽** keys under the POSITION display to select the setting value.

Options:

- VS-10GH-A (-1)
- 0: Position Voltage Output
- 1: Speed Voltage Output (for monitoring)

- VS-10GH-C-1
- 0: Position Current Output
- 1: Speed Current Output (for monitoring)

The selected value can be canceled by pressing the **CLR** key at this point.

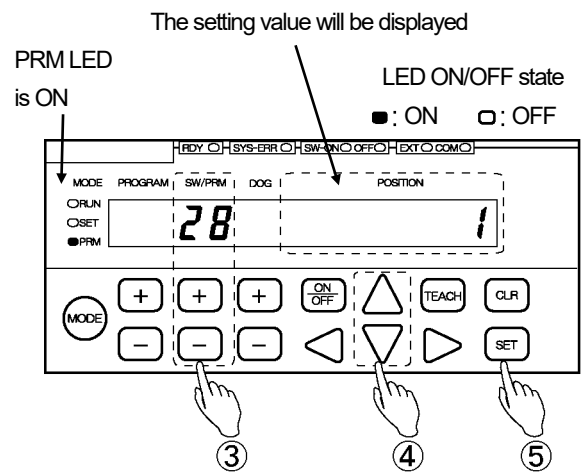

⑤ Confirm the selected value.

Press the **SET** key.

The POSITION display will become solidly on, indicating that parameter setting is complete.

4-23-2. Setting the output voltage range

This setting applies to the voltage output models, VS-10GH-A and VS-10GH-A-1.
The voltage for the minimum or the maximum position (speed) can be specified.

For the current output model, VS-10GH-C-1, the output current is limited to 4-20mA.
No such setting is required.

POINT:

Two channels are provided for the analog output. The setting value of the output voltage range can be specified for each channel.

Ch. 1: Set it by combined use of Parameters 26 and 27.

Ch. 2: Set it by combined use of Parameters 34 and 35.

In the steps (1) to (3) below, the setting of Ch. 1 by combined use of Parameters 26 and 27 is described.

(1) Parameter setting mode ("PRM") selection

① Select the parameter setting mode ("PRM").

Press and hold down the  key (more than 1 second).

The POSITION display will flicker to indicate mode selection is possible.

Press the  key a number of times until the parameter setting mode ("PRM") is shown.

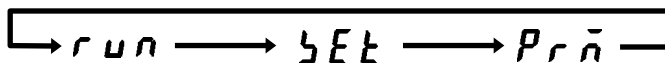
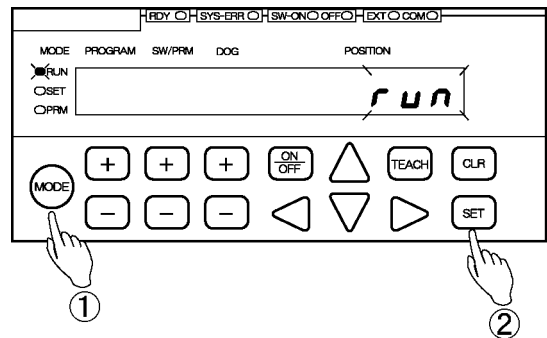

Run mode ("RUN")	Switch setting mode ("SET")	Parameter setting mode ("PRM")
MODE	MODE	MODE
<input checked="" type="checkbox"/> RUN	<input type="checkbox"/> RUN	<input type="checkbox"/> RUN
<input type="checkbox"/> SET	<input checked="" type="checkbox"/> SET	<input type="checkbox"/> SET
<input type="checkbox"/> PRM	<input type="checkbox"/> PRM	<input checked="" type="checkbox"/> PRM

② Confirm the mode selection

Press the  key.

The mode is now set to the parameter setting mode ("PRM").

(2) Minimum Output Voltage (V min) Setting

① Select Parameter 26 (34).

Use the **+** and **-** keys under the SW/PRM display to select "26 (34)".

② Enter the setting value.

Use the **<**, **>**, **△** and **▽** keys under the POSITION display to enter the setting value.

Setting range:

-10.00 to Vmax [V] (Voltage value set at Parameter 27)

The entered value can be canceled by pressing the **CLR** key at this point.

③ Confirm the entered value.

Press the **SET** key.

The POSITION display becomes solidly on, indicating that parameter setting is complete.

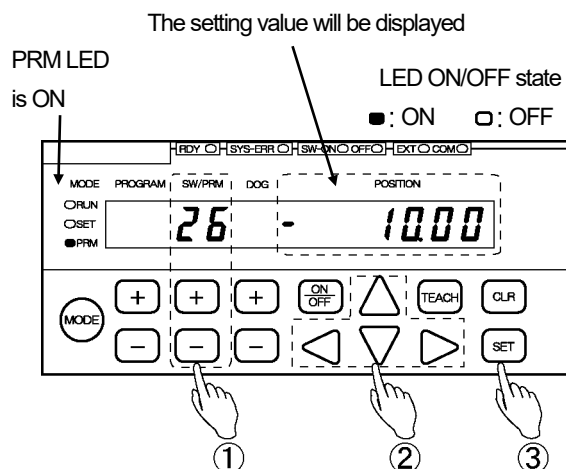

(3) Maximum Output Voltage (V max) Setting

① Select Parameter 27 (35).

Use the **+** and **-** keys under the SW/PRM display to select "27 (35)".

② Enter the setting value.

Use the **<**, **>**, **△** and **▽** keys under the POSITION display to enter the setting value.

Setting range:

Vmin (Voltage value set at Parameter 26) to 10.00 [V]

The entered value can be canceled by pressing the **CLR** key at this point.

③ Confirm the entered value.

Press the **SET** key.

The POSITION display becomes solidly on, indicating that parameter setting is complete.

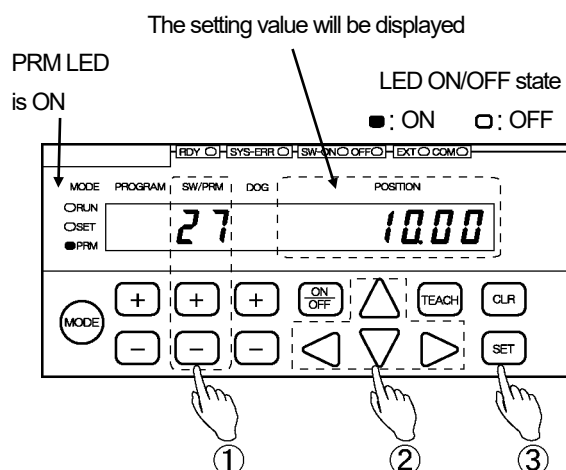

4-23-3. Setting the position/speed range

With the voltage output models, VS-10GH-A, VS-10GH-A-1, the position (speed) for the minimum and the maximum voltage can be specified.

With the current output model, VS-10GH-C-1, the position (speed) for the minimum value of 4mA and the maximum value of 20mA can be specified.

POINT:

Two channels are provided for the analog output. The setting value of the position (speed) range can be specified for each channel.

Ch. 1: Set it by the combined use of Parameters 29 and 30.

Ch. 2: Set it by the combined use of Parameters 37 and 38.

In the steps (1) to (3) below, the setting of Ch. 1 by the combined use of Parameters 29 and 30 is described.

(1) Parameter setting mode ("PRM") selection

① Select the parameter setting mode ("PRM").

Press and hold down the  key (more than 1 second).

The POSITION display will flicker to indicate mode selection is possible.

Press the  key a number of times until the parameter setting mode ("PRM") is shown.

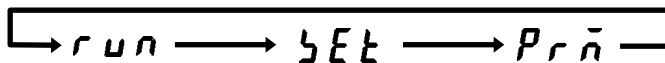
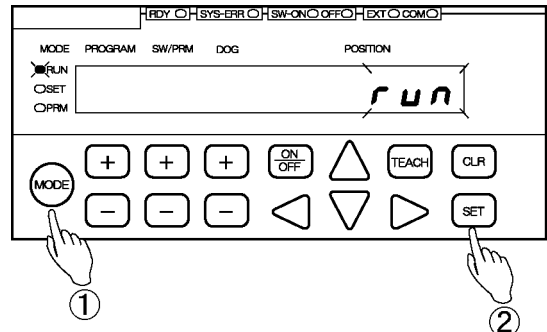

Run mode ("RUN")	Switch setting mode ("SET")	Parameter setting mode ("PRM")
MODE	MODE	MODE
<input checked="" type="checkbox"/> RUN	<input type="checkbox"/> RUN	<input type="checkbox"/> RUN
<input type="checkbox"/> SET	<input checked="" type="checkbox"/> SET	<input type="checkbox"/> SET
<input type="checkbox"/> PRM	<input type="checkbox"/> PRM	<input checked="" type="checkbox"/> PRM

② Confirm the mode selection

Press the  key.

The mode is now set to the parameter setting mode ("PRM").

(2) Minimum Output Position (Speed) Setting

① Select Parameter 29 (37).

Use the **[+]** and **[-]** keys under the SW/PRM display to select "29 (37)".

② Enter the setting value.

Use the **[<]**, **[>]**, **[△]** and **[▽]** keys under the POSITION display to enter the setting value.

Setting range: -999999 to 999999

The unit of speed is:

"Current Position Value (scale value)/s.

Example:

If the Current Position Value display resolution is 0.1 mm, the speed will be set to 10 mm/s when "10.0" is entered.

The entered value can be canceled by pressing the **[CLR]** key at this point.

③ Confirm the entered value.

Press the **[SET]** key.

The POSITION display becomes solidly on, indicating that parameter setting is complete.

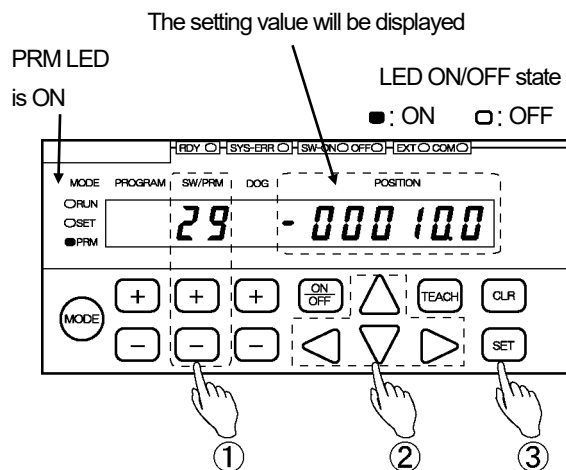

(3) Maximum Output Position (Speed) Setting

① Select Parameter 30 (38).

Use the **[+]** and **[-]** keys under the SW/PRM display to select "30 (38)".

② Enter the setting value.

Use the **[<]**, **[>]**, **[△]** and **[▽]** keys under the POSITION display to enter the setting value.

Setting range: -999999 to 999999

The unit of speed is:

"Current Position Value (scale value)/s.

Example:

If the Current Position Value display resolution is 0.1 mm, the speed will be set to 10 mm/s when "10.0" is entered.

The entered value can be canceled by pressing the **[CLR]** key at this point.

③ Confirm the entered value.

Press the **[SET]** key.

The POSITION display becomes solidly on, indicating that parameter setting is complete.

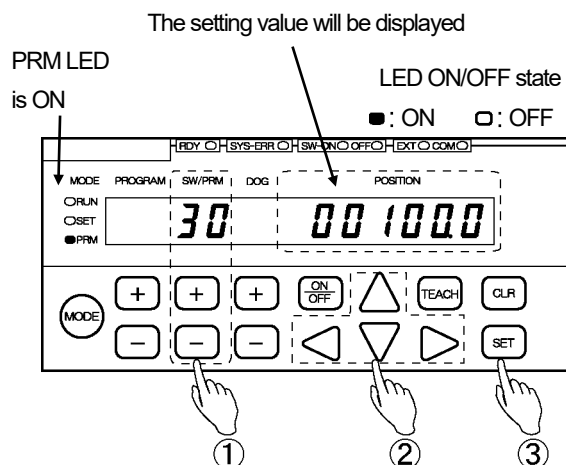

4-23-4. Setting the deadband position (speed) and width

This setting applies to the following models:

Voltage output models: VS-10GH-A, VS-10GH-A-1

Current output model: VS-10GH-C-1

The deadband position (speed) and width can be specified.

Use this setting when required.

POINT:

Two channels are provided for the analog output. The setting value of the deadband position (speed) and width can be specified for each channel.

Ch. 1: Set it by the combined use of Parameters 25 and 24.

Ch. 2: Set it by the combined use of Parameters 33 and 32.

In the steps (1) to (3) below, the setting of Ch. 1 by the combined use of Parameters 25 and 24 is described.

(1) Parameter setting mode ("PRM") selection

① Select the parameter setting mode ("PRM").

Press and hold down the **MODE** key (more than 1 second).

The POSITION display will flicker to indicate mode selection is possible.

Press the **MODE** key a number of times until the parameter setting mode ("PRM") is shown.

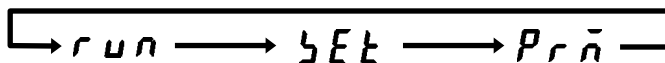
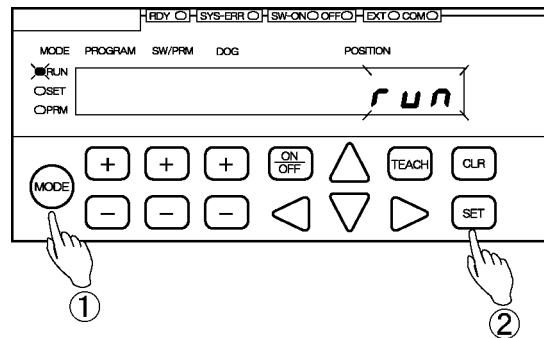

Run mode ("RUN")	Switch setting mode ("SET")	Parameter setting mode ("PRM")
MODE	MODE	MODE
<input checked="" type="checkbox"/> RUN	<input type="checkbox"/> RUN	<input type="checkbox"/> RUN
<input type="checkbox"/> SET	<input checked="" type="checkbox"/> SET	<input type="checkbox"/> SET
<input type="checkbox"/> PRM	<input type="checkbox"/> PRM	<input checked="" type="checkbox"/> PRM

② Confirm the mode selection

Press the **SET** key.

The mode is now set to the parameter setting mode ("PRM").

(2) Deadband Position (Speed) Setting

① Select Parameter 25 (33).

Use the **[+]** and **[-]** keys under the SW/PRM display to select "25 (33)".

② Enter the setting value.

Use the **[<]**, **[>]**, **[▲]** and **[▼]** keys under the POSITION display to enter the setting value.

Setting range: -999999 to 999999

The unit of speed is:

"Current Position Value (scale value)/s.

Example:

If the Current Position Value display resolution is 0.1 mm, the speed will be set to 10 mm/s when "10.0" is entered.

The entered value can be canceled by pressing the **[CLR]** key at this point.

③ Confirm the entered value.

Press the **[SET]** key.

The POSITION display becomes solidly on, indicating that parameter setting is complete.

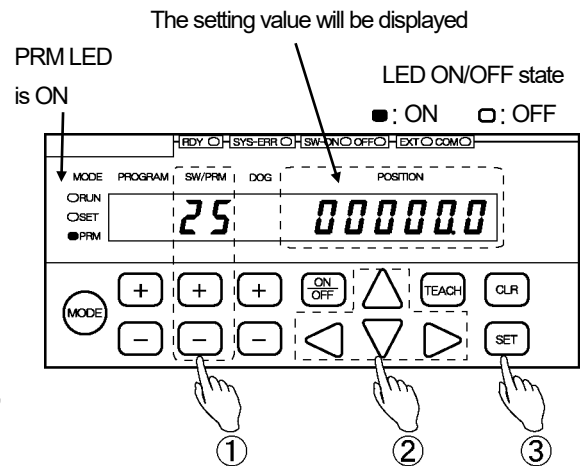

(3) Deadband Width Setting

① Select Parameter 24 (32).

Use the **[+]** and **[-]** keys under the SW/PRM display to select "24 (32)".

② Enter the setting value.

Use the **[<]**, **[>]**, **[▲]** and **[▼]** keys under the POSITION display to enter the setting value.

Setting range: -999999 to 999999

The unit of speed is:

"Current Position Value (scale value)/s.

Example:

If the Current Position Value display resolution is 0.1 mm, the speed will be set to 10 mm/s when "10.0" is entered.

The entered value can be canceled by pressing the **[CLR]** key at this point.

③ Confirm the entered value.

Press the **[SET]** key.

The POSITION display becomes solidly on, indicating that parameter setting is complete.

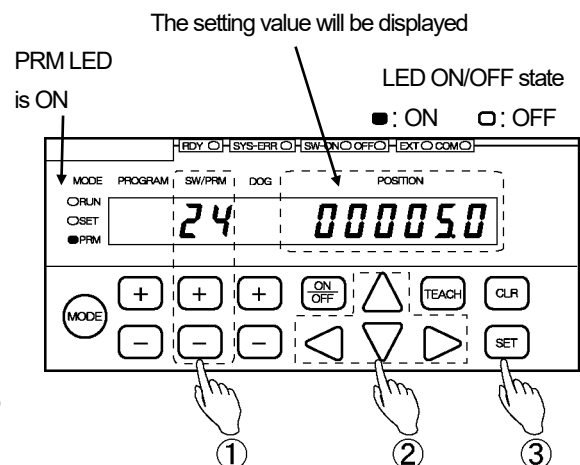

4-23-5. Setting the speed sampling time and the number of speed gates

This setting applies to the following models:

Voltage output models: VS-10GH-A, VS-10GH-A-1

Current output model: VS-10GH-C-1

The time for speed sampling and the number of speed gates can be specified.

Use this setting when required.

POINT:

The setting value of the speed sampling time and the number of speed gates are common to Channels 1 and 2.

Set them by combined use of Parameters 23 and 22.

(1) Parameter setting mode ("PRM") selection

① Select the parameter setting mode ("PRM").

Press and hold down the  key (more than 1 second).

The POSITION display will flicker to indicate mode selection is possible.

Press the  key a number of times until the parameter setting mode ("PRM") is shown.

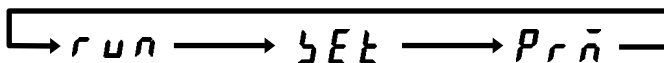
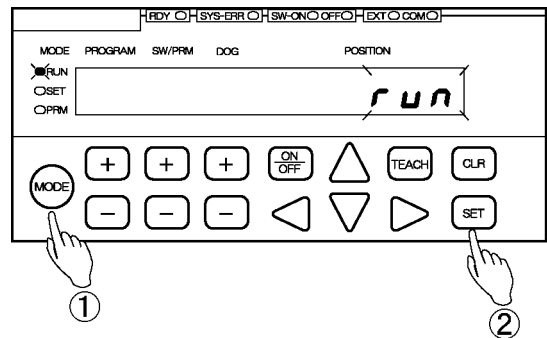

Run mode ("RUN")	Switch setting mode ("SET")	Parameter setting mode ("PRM")
MODE	MODE	MODE
<input checked="" type="checkbox"/> RUN	<input type="checkbox"/> RUN	<input type="checkbox"/> RUN
<input type="checkbox"/> SET	<input checked="" type="checkbox"/> SET	<input type="checkbox"/> SET
<input type="checkbox"/> PRM	<input type="checkbox"/> PRM	<input checked="" type="checkbox"/> PRM

② Confirm the mode selection

Press the  key.

The mode is now set to the parameter setting mode ("PRM").

(2) Speed Sampling Time Setting

① Select Parameter 23.

Use the **[+]** and **[-]** keys under the SW/PRM display to select "23".

② Enter the setting value.

Use the **[<]**, **[>]**, **[▲]** and **[▼]** keys under the POSITION display to enter the setting value.

Setting range: 0.001 to 9.999 [s]

The entered value can be canceled by pressing the **[CLR]** key at this point.

③ Confirm the entered value.

Press the **[SET]** key.

The POSITION display becomes solidly on, indicating that parameter setting is complete.

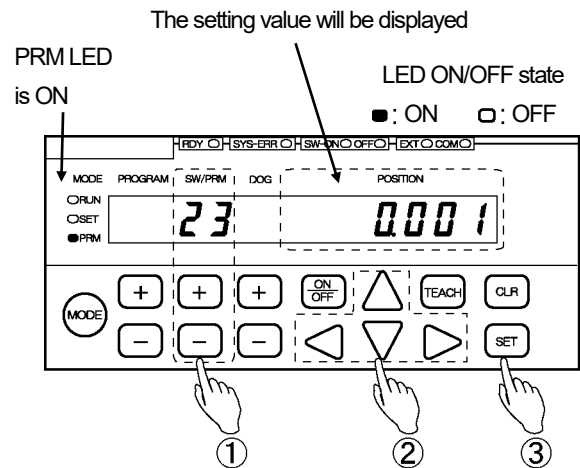

(3) "Number of Speed Gates" Setting

① Select Parameter 22.

Use the **[+]** and **[-]** keys under the SW/PRM display to select "22".

② Enter the setting value.

Use the **[<]**, **[>]**, **[▲]** and **[▼]** keys under the POSITION display to enter the setting value.

Setting range: 1 to 99

The entered value can be canceled by pressing the **[CLR]** key at this point.

③ Confirm the entered value.

Press the **[SET]** key.

The POSITION display becomes solidly on, indicating that parameter setting is complete.

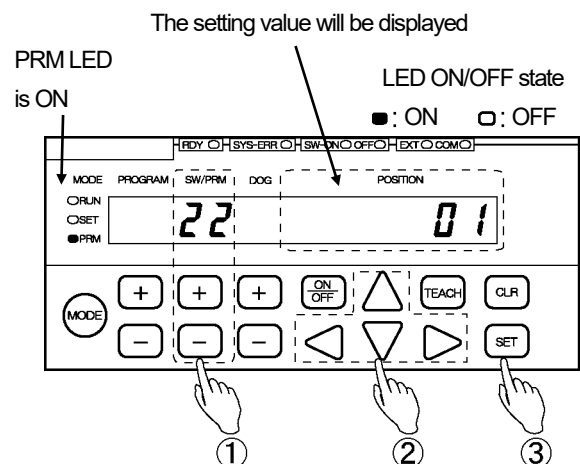

4-24. Selecting to Permit/Prohibit All-data Downloading

This parameter can be used when switch outputs and parameter setting values need to be written (downloaded) into the VARILIMIT by serial communication.

Contact our sales representative for serial communication details.

Select "1 : Permitted" to allow downloading.

The setting will automatically return to "Prohibit" after one of the following actions had been taken.

- Changing the mode from the parameter setting mode ("PRM") to another mode.
- Turning the power off and then on again.

NOTES

The Parameter 97 (Current Position Setting) cannot be written into the VARILIMIT by serial communication. Be sure to set this parameter on the VARILIMIT side. If the parameter is not set, a "No Current Position Setting" error (Err19) will occur.

Set the parameter in the following steps.

① Select the parameter setting mode ("PRM").

Press and hold down the **MODE** key (more than 1 second).

The POSITION display will flicker to indicate mode selection is possible.

Press the **MODE** key a number of times until the parameter setting mode ("PRM") is shown.

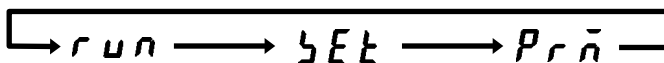
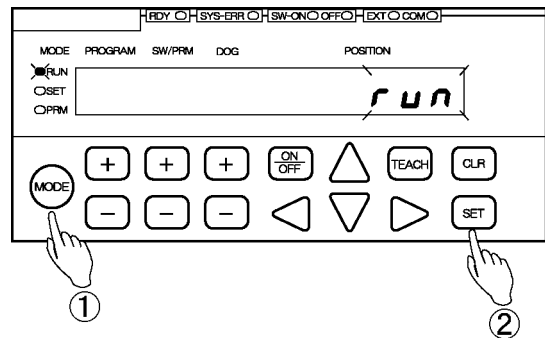

Run mode ("RUN")	Switch setting mode ("SET")	Parameter setting mode ("PRM")
MODE	MODE	MODE
<input checked="" type="radio"/> RUN	<input type="radio"/> RUN	<input type="radio"/> RUN
<input type="radio"/> SET	<input checked="" type="radio"/> SET	<input type="radio"/> SET
<input type="radio"/> PRM	<input type="radio"/> PRM	<input checked="" type="radio"/> PRM

② Confirm the mode selection

Press the **SET** key.

The mode is now set to the parameter setting mode ("PRM").

③ Select Parameter 59.

Use the **+** and **-** keys under the SW/PRM display to select "59".

④ Change the setting value to "1".

Use the **△** or **▽** key under the POSITION display to change the setting value to "1".

The selected value can be canceled by pressing the **CLR** key at this point.

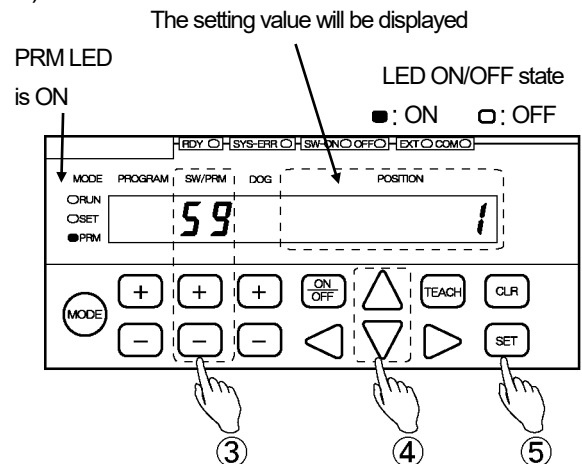

⑤ Confirm the selected value.

Press the **SET** key.

The POSITION display will become solidly on, indicating that parameter setting is complete.

4-25. Communication Baud Rate Setting

The communication baud rate (communication speed) can be selected.

Contact our sales representative for serial communication details.

Set the parameter in the following steps.

① Select the parameter setting mode ("PRM").

Press and hold down the **(MODE)** key (more than 1 second).

The POSITION display will flicker to indicate mode selection is possible.

Press the **(MODE)** key a number of times until the parameter setting mode ("PRM") is shown.

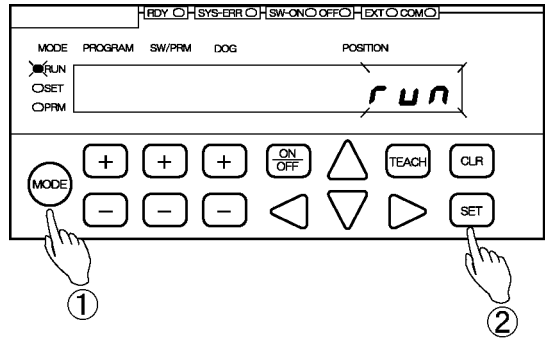

Run mode ("RUN")	Switch setting mode ("SET")	Parameter setting mode ("PRM")
MODE	MODE	MODE
<input checked="" type="checkbox"/> RUN	<input type="checkbox"/> RUN	<input type="checkbox"/> RUN
<input type="checkbox"/> SET	<input checked="" type="checkbox"/> SET	<input type="checkbox"/> SET
<input type="checkbox"/> PRM	<input type="checkbox"/> PRM	<input checked="" type="checkbox"/> PRM

② Confirm the mode selection

Press the **(SET)** key.
The mode is now set to the parameter setting mode ("PRM").

③ Select Parameter 58.

Use the **(+)** and **(-)** keys under the SW/PRM display to select "58".

④ Select the setting value.

Use the **(Δ)** and **(▽)** keys under the POSITION display to select the setting value.

Options:

- 0: 2400bps 1: 4800bps
- 2: 9600bps 3: 19200bps
- 4: 38400bps 5: 57600bps

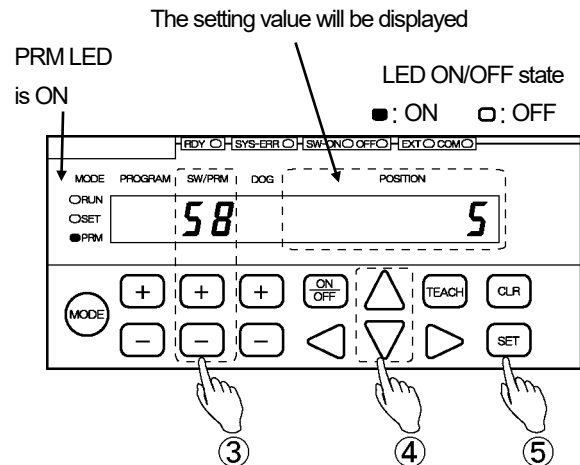

The selected value can be canceled by pressing the **(CLR)** key at this point.

⑤ Confirm the selected value.

Press the **(SET)** key.
The POSITION display will become solidly on, indicating that parameter setting is complete.

4-26. Communication Protocol Setting

The communication protocol can be selected.

Contact our sales representative for serial communication details.

Set the parameter in the following steps.

① Select the parameter setting mode ("PRM").

Press and hold down the **MODE** key (more than 1 second).

The POSITION display will flicker to indicate mode selection is possible.

Press the **MODE** key a number of times until the parameter setting mode ("PRM") is shown.

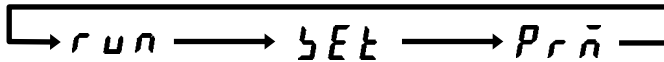
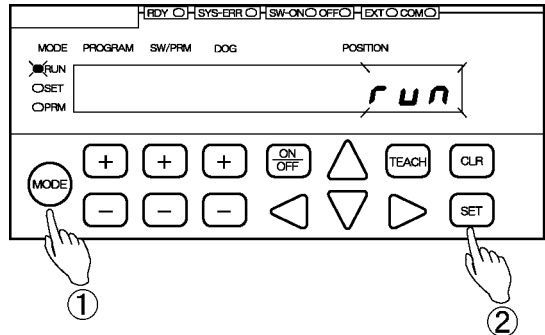

Run mode ("RUN")	Switch setting mode ("SET")	Parameter setting mode ("PRM")
MODE	MODE	MODE
<input checked="" type="checkbox"/> RUN	<input type="checkbox"/> RUN	<input type="checkbox"/> RUN
<input type="checkbox"/> SET	<input checked="" type="checkbox"/> SET	<input type="checkbox"/> SET
<input type="checkbox"/> PRM	<input type="checkbox"/> PRM	<input checked="" type="checkbox"/> PRM

② Confirm the mode selection

Press the **SET** key.
The mode is now set to the parameter setting mode ("PRM").

③ Select Parameter 54.

Use the **+** and **-** keys under the SW/PRM display to select "54".

④ Select the setting value.

Use the **△** and **▽** keys under the POSITION display to select the setting value.

- Options:
- 0: NSD
 - 1: MELSEC-A
 - 2: MELSEC
 - 3: OMRON
 - 9: VARIMONI

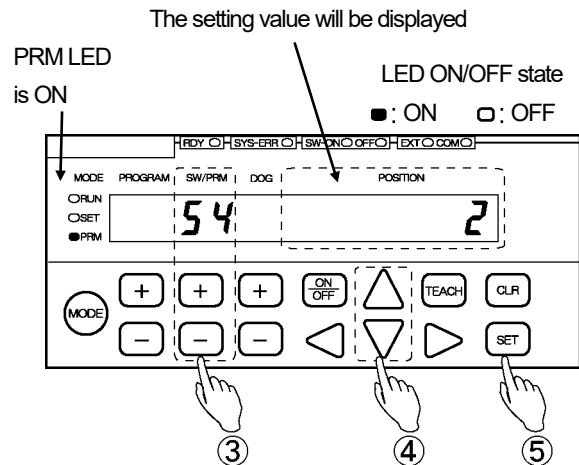

The selected value can be canceled by pressing the **CLR** key at this point.

⑤ Confirm the selected value.

Press the **SET** key.
The POSITION display will become solidly on, indicating that parameter setting is complete.

4-27. Node Number Setting

This parameter can be used to allocate a node number to VARILIMIT.
Node number setting is required when Parameter 54 (Protocol) is set to "9: VARIMONI".

Contact our sales representative for serial communication details.

Set the parameter in the following steps.

① Select the parameter setting mode ("PRM").

Press and hold down the **MODE** key (more than 1 second).

The POSITION display will flicker to indicate mode selection is possible.

Press the **MODE** key a number of times until the parameter setting mode ("PRM") is shown.

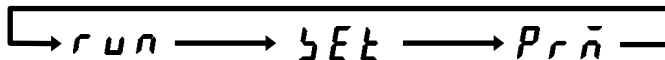
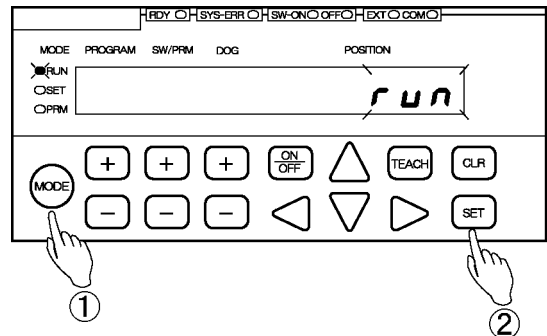

Run mode ("RUN")	Switch setting mode ("SET")	Parameter setting mode ("PRM")
MODE	MODE	MODE
<input checked="" type="checkbox"/> RUN	<input type="checkbox"/> RUN	<input type="checkbox"/> RUN
<input type="checkbox"/> SET	<input checked="" type="checkbox"/> SET	<input type="checkbox"/> SET
<input type="checkbox"/> PRM	<input type="checkbox"/> PRM	<input checked="" type="checkbox"/> PRM

② Confirm the mode selection

Press the **SET** key.

The mode is now set to the parameter setting mode ("PRM").

③ Select Parameter 56.

Use the **+** and **-** keys under the SW/PRM display to select "56".

④ Enter the setting value.

Use the **←**, **→**, **△** and **▽** keys under the POSITION display to enter the setting value.

Setting range: 0 to 15

The entered value can be canceled by pressing the **CLR** key at this point.

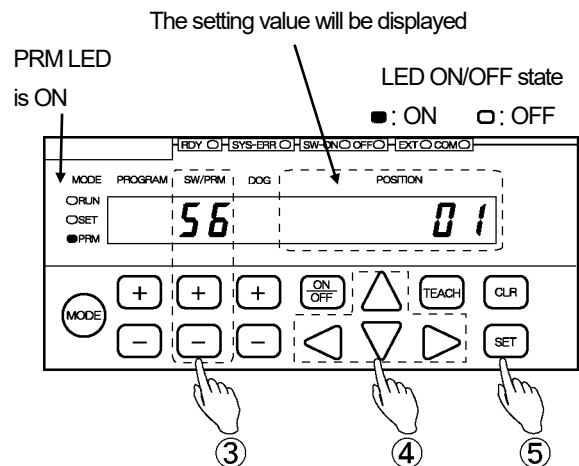

⑤ Confirm the entered value.

Press the **SET** key.

The POSITION display becomes solidly on, indicating that parameter setting is complete.

4-28. Device Selection Setting

The programmable controller's device type can be selected. Device type setting is required when Parameter 54 (Protocol) is set to "2: MELSEC".

Contact our sales representative for serial communication details.

Set the parameter in the following steps.

① Select the parameter setting mode ("PRM").

Press and hold down the **(MODE)** key (more than 1 second).

The POSITION display will flicker to indicate mode selection is possible.

Press the **(MODE)** key a number of times until the parameter setting mode ("PRM") is shown.

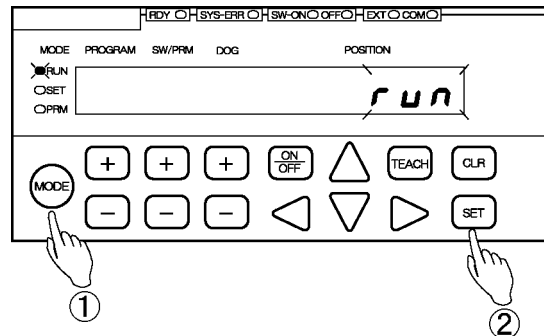

Run mode ("RUN")	Switch setting mode ("SET")	Parameter setting mode ("PRM")
MODE	MODE	MODE
<input checked="" type="checkbox"/> RUN	<input type="checkbox"/> RUN	<input type="checkbox"/> RUN
<input type="checkbox"/> SET	<input checked="" type="checkbox"/> SET	<input type="checkbox"/> SET
<input type="checkbox"/> PRM	<input type="checkbox"/> PRM	<input checked="" type="checkbox"/> PRM

② Confirm the mode selection

Press the **(SET)** key.

The mode is now set to the parameter setting mode ("PRM").

③ Select Parameter 53.

Use the **(+)** and **(-)** keys under the SW/PRM display to select "53".

④ Select the setting value.

Use the **(△)** and **(▽)** keys under the POSITION display to select the setting value.

Options:

- 0: D (Data Register)
- 1: R (File Register)

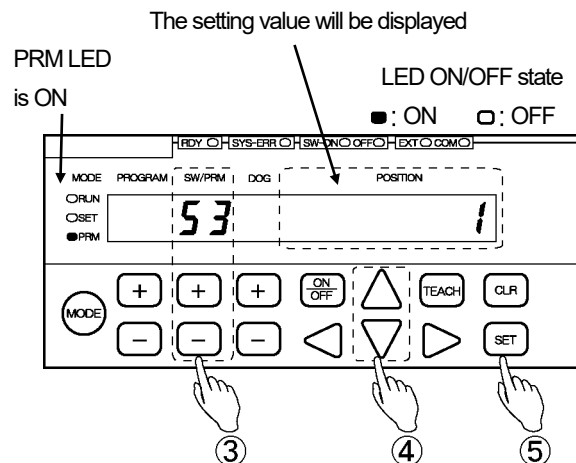

The selected value can be canceled by pressing the **(CLR)** key at this point.

⑤ Confirm the selected value.

Press the **(SET)** key.

The POSITION display will become solidly on, indicating that parameter setting is complete.

4-29. Device Number Setting

This parameter specifies the first device number to be used by the programmable controller.

Device number setting is required when Parameter 54 (Protocol) is set to either of the following options:

"2: MELSEC", or "3: OMRON".

Contact our sales representative for serial communication details.

Set the parameter in the following steps.

① Select the parameter setting mode ("PRM").

Press and hold down the **MODE** key (more than 1 second).

The POSITION display will flicker to indicate mode selection is possible.

Press the **MODE** key a number of times until the parameter setting mode ("PRM") is shown.

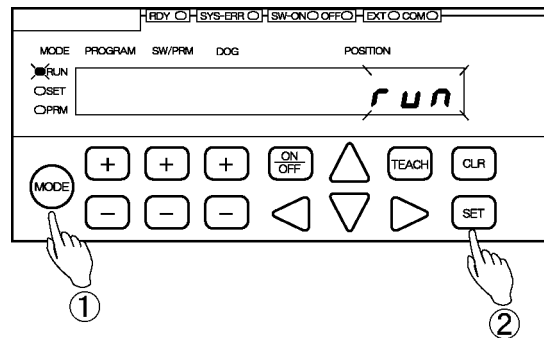

Run mode ("RUN")	Switch setting mode ("SET")	Parameter setting mode ("PRM")
MODE	MODE	MODE
<input checked="" type="checkbox"/> RUN	<input type="checkbox"/> RUN	<input type="checkbox"/> RUN
<input type="checkbox"/> SET	<input checked="" type="checkbox"/> SET	<input type="checkbox"/> SET
<input type="checkbox"/> PRM	<input type="checkbox"/> PRM	<input checked="" type="checkbox"/> PRM

② Confirm the mode selection

Press the **SET** key.

The mode is now set to the parameter setting mode ("PRM").

③ Select Parameter 52.

Use the **+** and **-** keys under the SW/PRM display to select "52".

④ Enter the setting value.

Use the **◀**, **▶**, **▲** and **▼** keys under the POSITION display to enter the setting value.

Setting range: 0 to 9000

The entered value can be canceled by pressing the **CLR** key at this point.

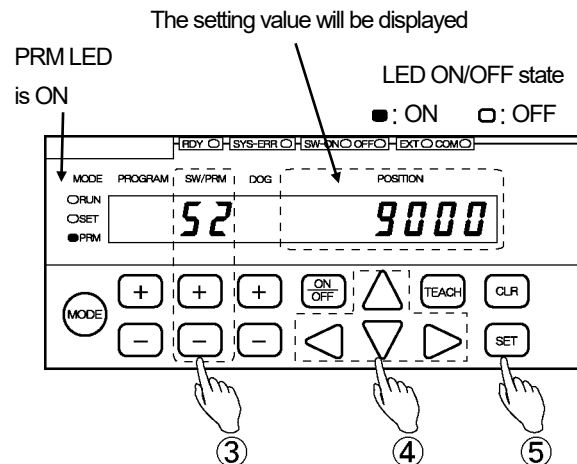

⑤ Confirm the entered value.

Press the **SET** key.

The POSITION display becomes solidly on, indicating that parameter setting is complete.

4-30. Communication Dog Number Setting

This parameter specifies the last switch-output Dog Number to be retrieved from the programmable controller.

Dog Number setting is required when Parameter 54 (Protocol) is set to either of the following options:

"2: MELSEC", or "3: OMRON".

Contact our sales representative for serial communication details.

Set the parameter in the following steps.

① Select the parameter setting mode ("PRM").

Press and hold down the **MODE** key (more than 1 second).

The POSITION display will flicker to indicate mode selection is possible.

Press the **MODE** key a number of times until the parameter setting mode ("PRM") is shown.

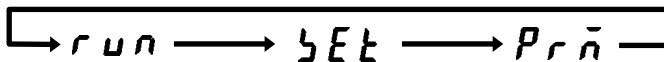
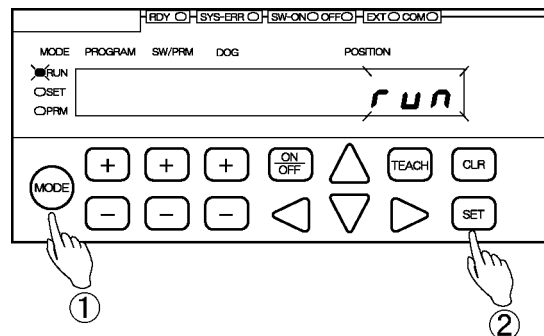

Run mode ("RUN")	Switch setting mode ("SET")	Parameter setting mode ("PRM")
MODE	MODE	MODE
<input checked="" type="checkbox"/> RUN	<input type="checkbox"/> RUN	<input type="checkbox"/> RUN
<input type="checkbox"/> SET	<input checked="" type="checkbox"/> SET	<input type="checkbox"/> SET
<input type="checkbox"/> PRM	<input type="checkbox"/> PRM	<input checked="" type="checkbox"/> PRM

② Confirm the mode selection

Press the **SET** key.

The mode is now set to the parameter setting mode ("PRM").

③ Select Parameter 51.

Use the **+** and **-** keys under the SW/PRM display to select "51".

④ Select the setting value.

Use the **△** and **▽** keys under the POSITION display to select the setting value.

Options:

When Parameter E0 is set to 1: 1 to A (1 to 10)

When Parameter E0 is set to 2: 1 to 4

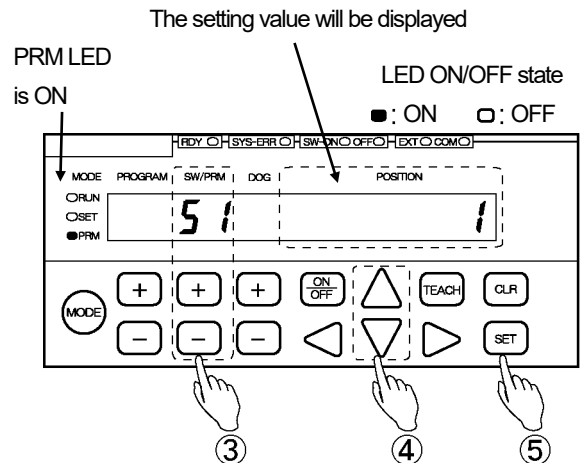

The selected value can be canceled by pressing the **CLR** key at this point.

⑤ Confirm the selected value.

Press the **SET** key.

The POSITION display will become solidly on, indicating that parameter setting is complete.

5. Switch Output Setting

This section explains the switch output setting procedure.

NOTES

When the number of switches (1 to 30) is specified at Parameter 21 (Number of Limitswitch Timer Switches), the switch outputs from 1 to what is set at the parameter will serve the Limitswitch Timer function.
For the Limitswitch Timer function details, refer to Chapter 4-22.

5-1. Switch output setting

Shown below is an example of switch setting.

Setting example
Program No.: 1, Switch No.: 1

ON position	50.0
OFF position	175.0

Enter the switch output settings in the following steps:

① Select the switch setting mode ("SET").

Press and hold down the **MODE** key (more than 1 second).

The POSITION display will flicker to indicate mode selection is possible.

Press the **MODE** key a number of times until the switch setting mode ("SET") is shown.

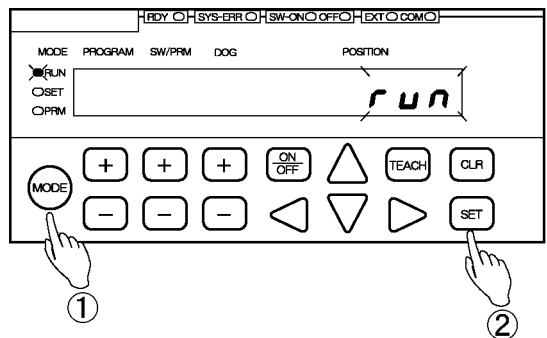

Run mode ("RUN")	Switch setting mode ("SET")	Parameter setting mode ("PRM")
MODE	MODE	MODE
<input checked="" type="checkbox"/> RUN	<input type="checkbox"/> RUN	<input type="checkbox"/> RUN
<input type="checkbox"/> SET	<input checked="" type="checkbox"/> SET	<input type="checkbox"/> SET
<input type="checkbox"/> PRM	<input type="checkbox"/> PRM	<input checked="" type="checkbox"/> PRM

② Confirm the mode selection.

Press the **SET** key.

The mode is now set to the switch setting mode ("SET").

③ Select the Program Number.

Use the (+) and (-) keys under the PROGRAM display to select the Program Number.

Program Number options:

When Parameter E0 is set to 1: 01 to 08

When Parameter E0 is set to 2: 00 to 31

④ Select the Switch Number.

Use the (+) and (-) keys under the SW/PRM display to select the Switch Number.

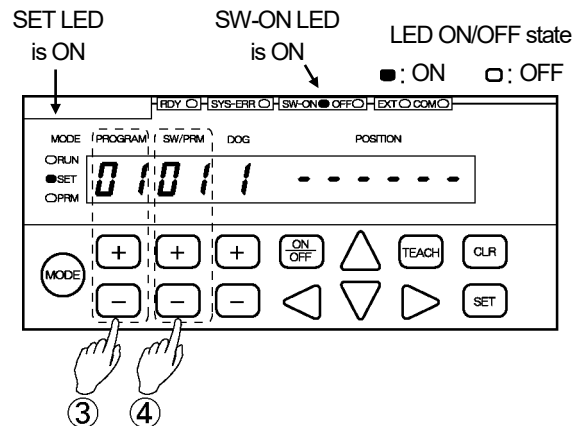

⑤ Enter the ON position value.

Use the ◀, ▶, △, and ▼ keys under the POSITION display to enter the ON position value. The POSITION display will flicker with the entered value.

The entered value can be canceled by pressing the CLR key at this point.

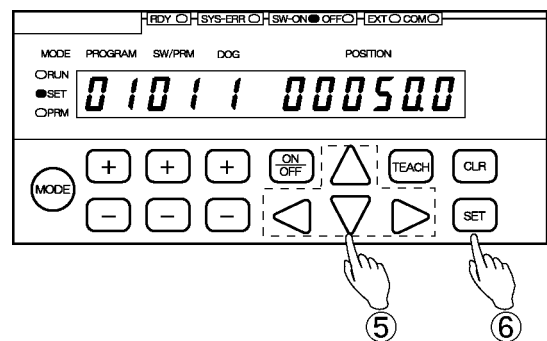

⑥ Confirm the ON position value.

Press the SET key. The POSITION display will become solidly on, indicating that ON position value has been accepted.

⑦ Turn the OFF LED on.

To enter an OFF position value, press the ON/OFF key so that the "OFF" LED comes on.

⑧ Enter the OFF position value.

Use the ◀, ▶, △, and ▼ keys to enter the OFF position value. The POSITION display will flicker with the entered value.

The entered value can be canceled by pressing the CLR key at this point.

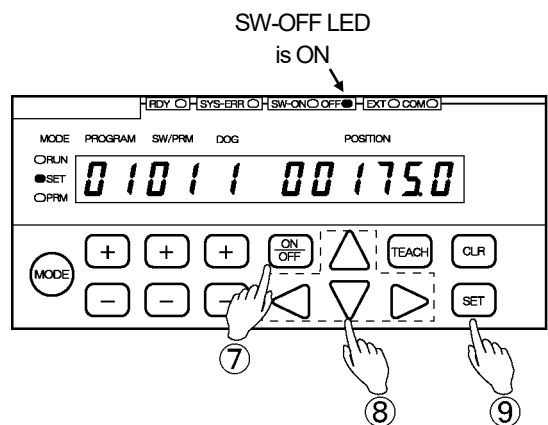

⑨ Confirm the OFF position value.

Press the SET key. The POSITION display will become solidly on, indicating that the OFF position value has been accepted.

⑩ Repeat the above steps as required.

Repeat Steps ④ to ⑨ for the number of switches.

To enter switch output settings for another Program, repeat the procedure from Step ③.

POINT:

1. If no switch output setting is registered, the POSITION display will show "- - - - -".
2. Each time  key is pressed, the LED light switches between "SW-ON" and "OFF".
 Turn the "SW-ON" LED on to enter an ON position value.
 Turn the "OFF" LED on to enter an OFF position value.
3. When each of the following types of settings has been entered, the switch output ON range will be as shown in the chart below:
 - Entering the ON position only.
 - Entering the OFF position only.
 - OFF position < ON position ("Type B", or normally closed, contact)

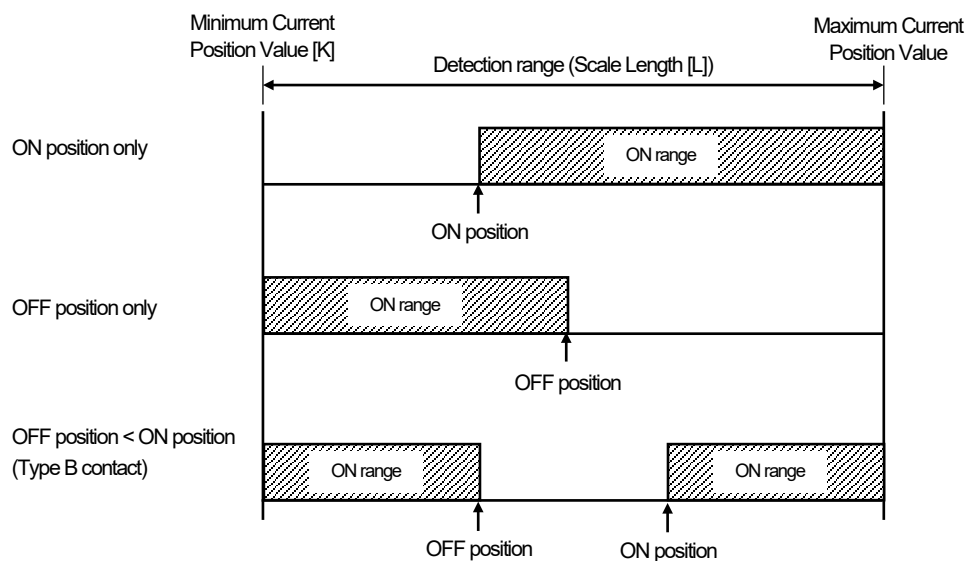

NOTES

When changing the scale length or the minimum current position value after the switch output has been set, the switch output value may fall outside the detection range. The switch output value cannot be corrected in this case.

Delete the setting value by switch or by program before resetting.

5-2. Setting by teaching

This section explains another switch output setting method.
In this method, the setting is entered by way of teaching.

Setting example

Program No.: 1, Switch No.: 1

ON position	50.0
OFF position	175.0

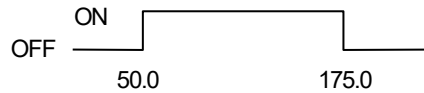

Switch output setting by teaching can be done in the following steps:

① Select the switch setting mode ("SET").

Press and hold down the **MODE** key (more than 1 second).

The POSITION display will flicker to indicate mode selection is possible.

Press the **MODE** key a number of times until the switch setting mode ("SET") is shown.

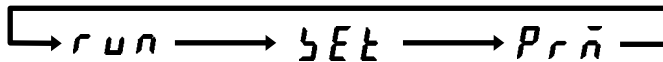
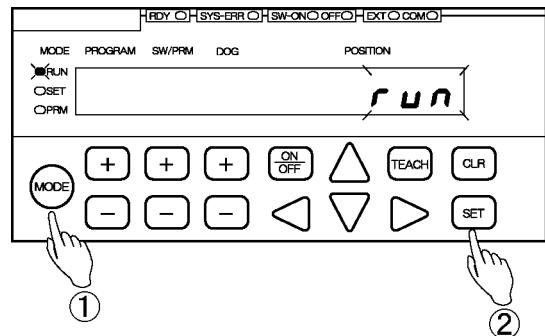

Run mode ("RUN") Switch setting mode ("SET") Parameter setting mode ("PRM")

MODE
 RUN
 SET
 PRM

MODE
 RUN
 SET
 PRM

MODE
 RUN
 SET
 PRM

② Confirm the mode selection.

Press the **SET** key.

The mode is now set to the switch setting mode ("SET").

③ Select the Program Number.

Use the (+) and (-) keys under the PROGRAM display to select the Program Number.

Program Number options:

When Parameter E0 is set to 1: 01 to 08

When Parameter E0 is set to 2: 00 to 31

④ Select the Switch Number.

Use the (+) and (-) keys under the SW/PRM display to select the Switch Number.

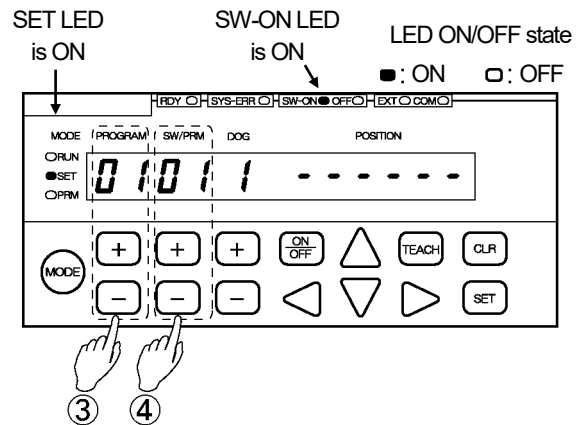

⑤ Select the teaching mode.

Press the TEACH key.

The POSITION display will flicker with the Current Position Value.

⑥ Move the machine to the target ON position.

Move the machine to the position where the switch output should come on.

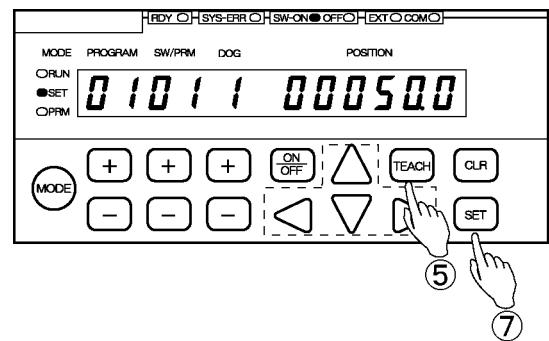

⑦ Confirm the ON position value shown.

Press the SET key.

The POSITION display will become solidly on, indicating that the ON position value has been accepted.

⑧ Turn the OFF LED on. *1

To enter an OFF position value, press the ON/OFF key so that the "OFF" LED comes on.

⑨ Repeat Step ⑤ to select the teaching mode again.

⑩ Move the machine to the target OFF position.

Move the machine to the position where the switch output should go off.

⑪ Confirm the OFF position value shown.

Press the SET key.

The POSITION display will become solidly on, indicating that the OFF position value has been accepted.

⑫ Repeat the above steps.

Repeat Steps ④ to ⑪ for the number of switches.

To enter switch output settings for another program, repeat the procedure from Step ③.

POINT:

*1: Each time the ON/OFF key is pressed, the LED light switches between "SW-ON" and "OFF".

Turn the "SW-ON" LED on to enter an ON position value.

Turn the "OFF" LED on to enter an OFF position value.

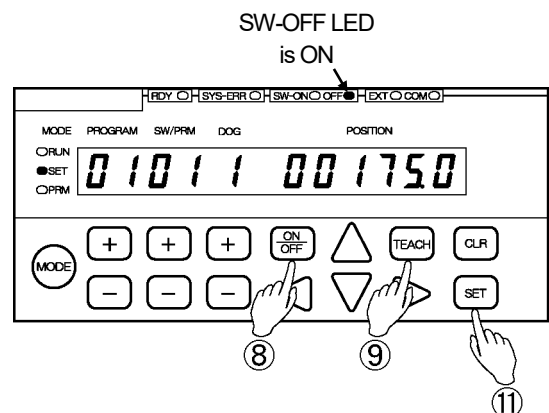

5-3. Multi-dog setting

Up to ten ON and OFF positions (Dogs) can be set for each switch output when Parameter E0 is set to 1. Up to four ON and OFF positions (Dogs) can be set when Parameter E0 is set to 2. The Dog numbers are 1 to A (1 to 10) or 1 to 4.

POINT:

The following should be considered when entering Multi-Dog settings.

1. Type A (= normally open) (ON position < OFF position) and type B (= normally closed) (OFF position < ON position) contact settings cannot be combined.

- If the first Dog (Dog 1) is a Type A contact, all the subsequent Dogs should also be Type A.

Example: Type A contacts

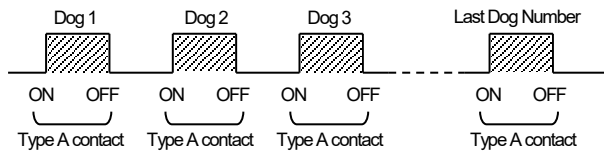

- If the first Dog (Dog 1) is a Type B contact, all the subsequent Dogs should also be Type B.

Example: Type B contacts

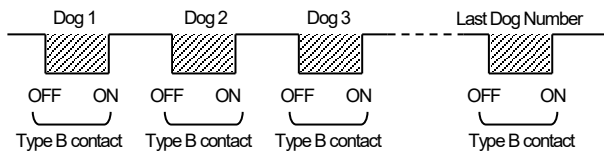

2. Or, when the first Dog (Dog 1) is a Type A contact, the last Dog may be ON position only.

Example: Type A contacts

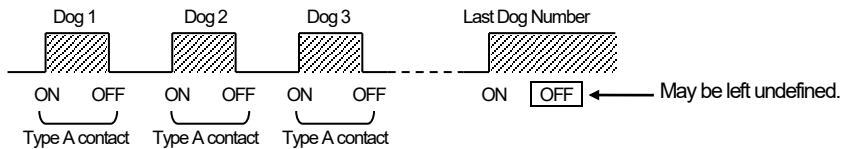

3. When the first Dog (Dog 1) is a Type B contact, the last Dog may be OFF position only.

Example: Type B contacts

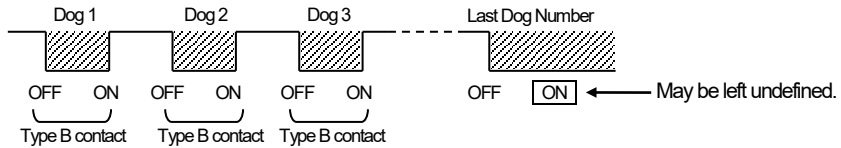

4. Correcting an existing Dog position

Dog positions can be corrected as long as no overlap with adjacent Dogs occurs.

Example: Correcting Dog 2

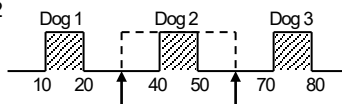

5. Inserting a new Dog

A new Dog can be inserted between existing Dogs.

Allocate an unused Largest Dog Number to the new Dog being inserted. Once the new Dog is accepted, the Dogs will be automatically rearranged and renumbered, in the order from the smallest to the largest position values.

Example: Inserting an ON-at-30, OFF-at-40 Dog:

To insert a new Dog here allocate an unused Largest Dog Number (Dog 3).

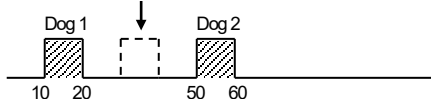

The Dogs will be rearranged and renumbered in the order from the smallest to the largest Position Values.

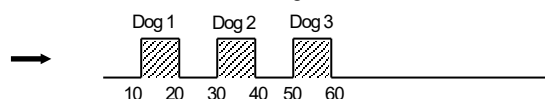

Enter Multi-Dog settings in the following steps:

① Select the switch setting mode ("SET").

Press and hold down the **(MODE)** key (more than 1 second).

The POSITION display will flicker to indicate mode selection is possible.

Press the **(MODE)** key a number of times until the switch setting mode ("SET") is shown.

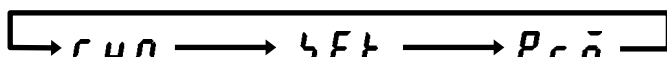
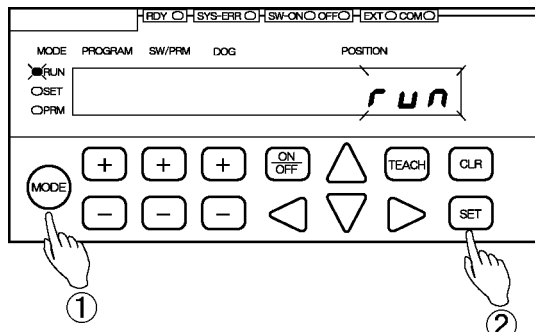

Run mode ("RUN") Switch setting mode ("SET") Parameter setting mode ("PRM")

MODE	MODE	MODE
<input checked="" type="radio"/> RUN	<input type="radio"/> RUN	<input type="radio"/> RUN
<input type="radio"/> SET	<input checked="" type="radio"/> SET	<input type="radio"/> SET
<input type="radio"/> PRM	<input type="radio"/> PRM	<input checked="" type="radio"/> PRM

② Confirm the mode selection.

Press the **(SET)** key.

The mode is now set to the switch setting mode ("SET").

③ Select the Program Number.

Use the **(+)** and **(-)** keys under the PROGRAM display to select the Program Number.

Program Number options:

When Parameter E0 is set to 1: 01 to 08

When Parameter E0 is set to 2: 00 to 31

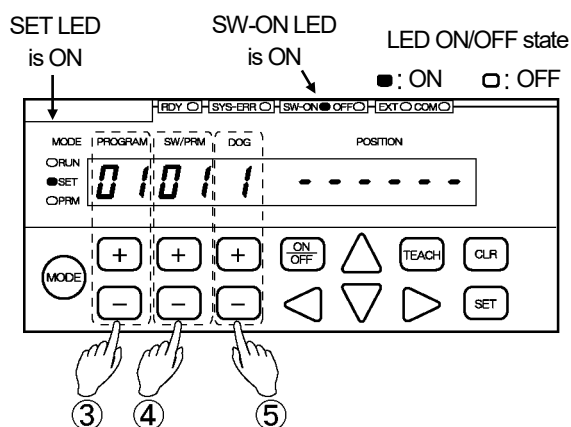

④ Select the Switch Number.

Use the **(+)** and **(-)** keys under the SW/PRM display to select the Switch Number.

⑤ Select the Dog Number. *1

Use the **(+)** and **(-)** keys under the "DOG" display to select the Dog Number.

Dog Number options:

When Parameter E0 is set to 1: 1 to A

When Parameter E0 is set to 2: 1 to 4

POINT:

*1: If no Dog is registered, the POSITION display will show "- - - - -".

If a new Dog Number is selected in this condition, a "Multi-Dog Setting" error (Err40) will occur.

⑥ Enter the ON position value.

Use the ◀, ▶, ▲, and ▼ keys under the POSITION display to enter the ON position value. The POSITION display will flicker with the entered value.

The entered value can be canceled by pressing the CLR key at this point.

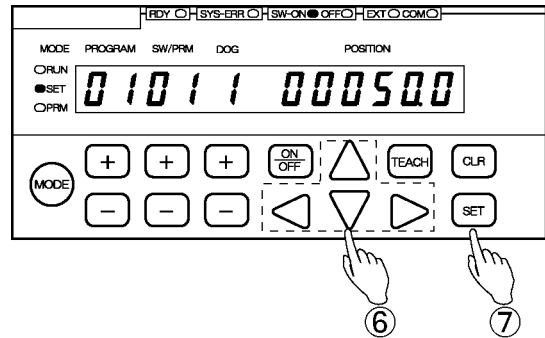

⑦ Confirm the ON position value.

Press the SET key. The POSITION display will become solidly on, indicating that the ON position value has been accepted.

⑧ Turn the OFF LED on. *2

To enter an OFF position value, press the ON/OFF key so that the "OFF" LED comes on.

⑨ Enter the OFF position value.

Use the ◀, ▶, ▲, and ▼ keys to enter the OFF position value. The POSITION display will flicker with the entered value.

The entered value can be canceled by pressing the CLR key at this point.

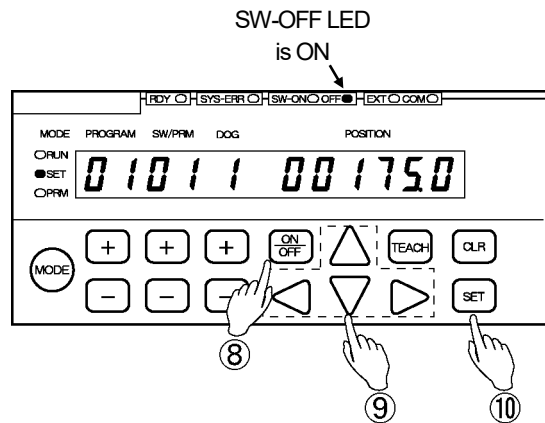

⑩ Confirm the OFF position value.

Press the SET key. The POSITION display will become solidly on, indicating that the OFF position value has been accepted.

⑪ Repeat the above steps as required.

Repeat Steps ⑤ to ⑩ for the number of Dogs.

POINT:

- *2: Each time the ON/OFF key is pressed, the LED light switches between "SW-ON" and "OFF".
- Turn the "SW-ON" LED on to enter an ON position value.
- Turn the "OFF" LED on to enter an OFF position value.



5-4. Deleting Switch Output Settings

Switch output settings can be deleted by the following three methods:

- (1) Deleting a single Dog
- (2) Deleting a single Switch
- (3) Deleting a single Program

For the specific deleting steps, refer to the following pages.

5-4-1. Deleting a single dog

To delete a single Dog, select the unnecessary Dog and enter the same value to the ON and OFF positions. Once a Dog is deleted, the remaining Dogs will be renumbered so as not to leave a blank Dog Number.

Deletion example:

Deleting Dog 2

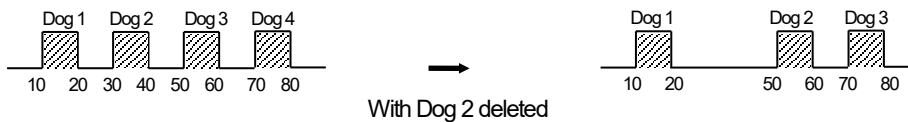

Single Dog deletion can be done in the following steps.

① Select the switch setting mode ("SET").

Press and hold down the **(MODE)** key (more than 1 second).

The POSITION display will flicker to indicate mode selection is possible.

Press the **(MODE)** key a number of times until the switch setting mode ("SET") is shown.

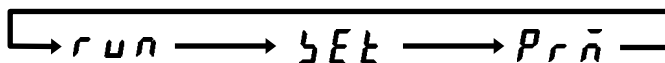
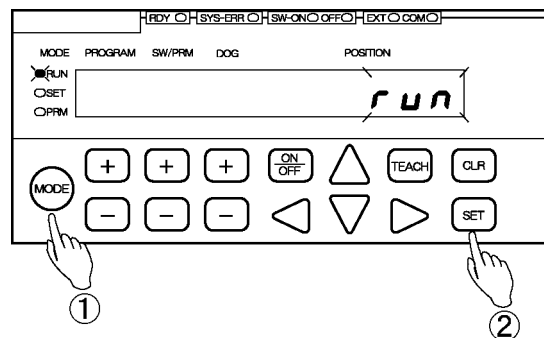

Run mode ("RUN")	Switch setting mode ("SET")	Parameter setting mode ("PRM")
MODE	MODE	MODE
<input checked="" type="radio"/> RUN	<input type="radio"/> RUN	<input type="radio"/> RUN
<input type="radio"/> SET	<input checked="" type="radio"/> SET	<input type="radio"/> SET
<input type="radio"/> PRM	<input type="radio"/> PRM	<input checked="" type="radio"/> PRM

② Confirm the mode selection.

Press the **(SET)** key.

The mode is now set to the switch setting mode ("SET").

③ Select the Program Number.

Use the (+) and (-) keys under the PROGRAM display to select the Program Number.

Program Number options:

When Parameter E0 is set to 1: 01 to 08

When Parameter E0 is set to 2: 00 to 31

④ Select the Switch Number.

Use the (+) and (-) keys under the SW/PRM display to select the Switch Number.

⑤ Select the Dog Number.

Use the (+) and (-) keys under the "DOG" display to select the Dog Number.

Dog Number options:

When Parameter E0 is set to 1: 1 to A

When Parameter E0 is set to 2: 1 to 4

⑥ Enter the same value to the ON and OFF positions. *1

Use the <, >, △, and ▽ keys to under the POSITION display to enter the same value to the ON and OFF positions.

The entered value can be canceled by pressing the CLR key at this point.

⑦ Check the deletion details.

Press the SET key.
The POSITION display will flicker more quickly.

Check carefully again if the settings for the selected Dog Number should really be deleted.

The Dog deletion can be canceled by pressing the CLR key at this point.

⑧ Execute deletion.

Press the SET key one more time.
The POSITION display will become solidly on, indicating that the settings for the selected Dog Number have been deleted.

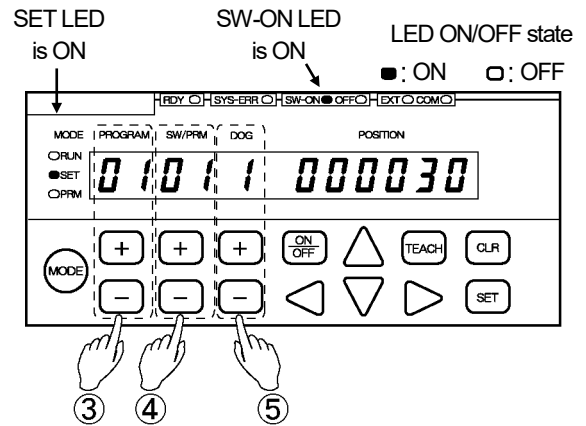

Step ⑦ will cause the display to flicker more quickly.

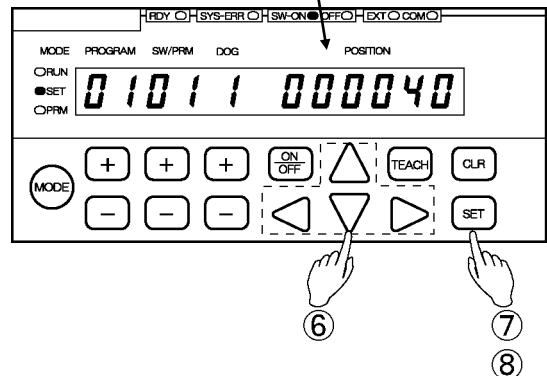

POINT:

*1: A single Dog can also be deleted in the steps below.

After Step ⑤, press the ON/OFF key by holding down the CLR key.

The POSITION display will flicker with "-----".

Then follow Steps ⑦ and ⑧ to complete deleting.

5-4-2. Deleting a single switch

Deleting a Switch Number will cause all the Dog settings registered to that Switch Number to be deleted.

Single Switch deletion can be done in the following steps.

① Select the switch setting mode ("SET").

Press and hold down the **MODE** key (more than 1 second).

The POSITION display will flicker to indicate mode selection is possible.

Press the **MODE** key a number of times until the switch setting mode ("SET") is shown.

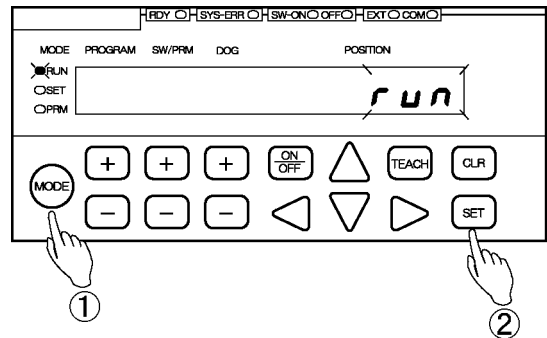

Run mode ("RUN")	Switch setting mode ("SET")	Parameter setting mode ("PRM")
MODE	MODE	MODE
<input checked="" type="checkbox"/> RUN	<input type="checkbox"/> RUN	<input type="checkbox"/> RUN
<input type="checkbox"/> SET	<input checked="" type="checkbox"/> SET	<input type="checkbox"/> SET
<input type="checkbox"/> PRM	<input type="checkbox"/> PRM	<input checked="" type="checkbox"/> PRM

② Confirm the mode selection.

Press the **SET** key.

The mode is now set to the switch setting mode ("SET").

③ Select the Program Number.

Use the **[+]** and **[-]** keys under the PROGRAM display to select the Program Number.

Program Number options:

When Parameter E0 is set to 1: 01 to 08

When Parameter E0 is set to 2: 00 to 31

④ Select the Switch Number.

Use the **[+]** and **[-]** keys under the SW/PRM display to select the Switch Number.

⑤ Select the deletion mode.

Press the **[+]** or **[-]** key under the SW/PRM display while pressing the **[CLR]** key.

The DOG and the POSITION displays will flicker.

The switch deletion can be canceled by pressing the **[CLR]** key at this point.

⑥ Check the deletion details.

Press the **[SET]** key.

The DOG and the POSITION displays will flicker more quickly.

Check carefully again if the settings for the selected Switch Number should really be canceled.

The switch deletion can be canceled by pressing the **[CLR]** key at this point.

⑦ Execute deletion.

Press the **[SET]** key one more time.

The DOG and the POSITION displays will become solidly on, indicating that the settings for the selected Switch Number have been deleted.

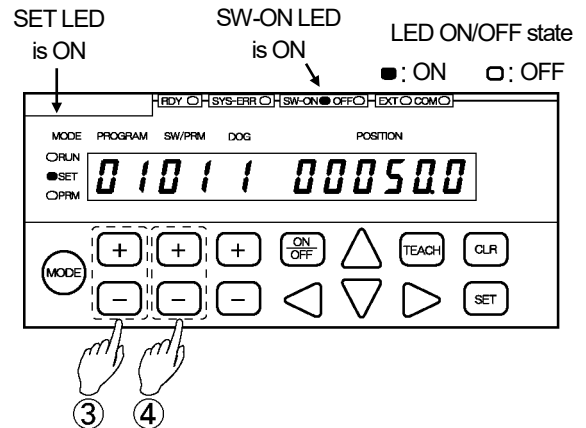

Step ⑤ will cause the display to start flickering.
Step ⑥ will cause the display to flicker more quickly.

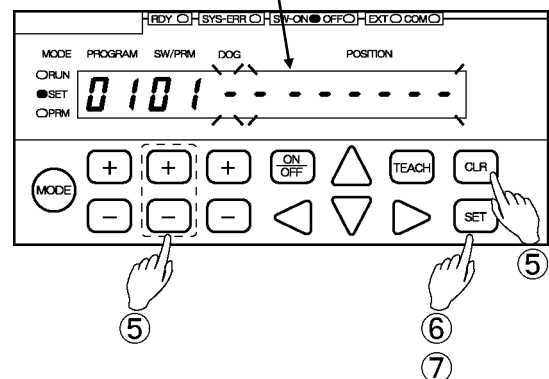

5-4-3. Deleting a single program

Deleting a Program will cause all the switch output settings registered to that Program to be deleted.

Single Program deletion can be done in the following steps:

① Select the switch setting mode ("SET").

Press and hold down the **(MODE)** key (more than 1 second).

The POSITION display will flicker to indicate mode selection is possible.

Press the **(MODE)** key a number of times until the switch setting mode ("SET") is shown.

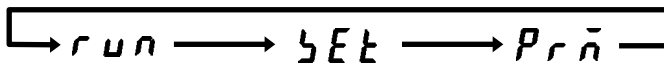
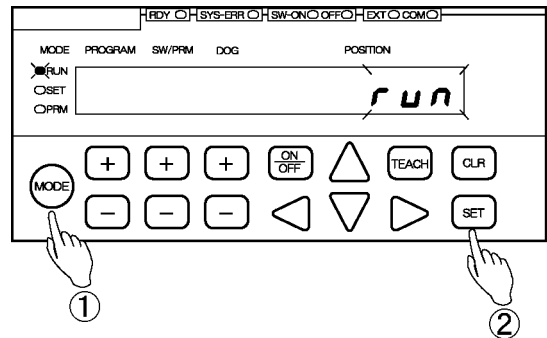

Run mode ("RUN")	Switch setting mode ("SET")	Parameter setting mode ("PRM")
MODE	MODE	MODE
<input checked="" type="checkbox"/> RUN	<input type="checkbox"/> RUN	<input type="checkbox"/> RUN
<input type="checkbox"/> SET	<input checked="" type="checkbox"/> SET	<input type="checkbox"/> SET
<input type="checkbox"/> PRM	<input type="checkbox"/> PRM	<input checked="" type="checkbox"/> PRM

② Confirm the mode selection.

Press the **(SET)** key.

The mode is now set to the switch setting mode ("SET").

③ Select the Program Number.

Use the **[+]** and **[-]** keys under the PROGRAM display to select the Program Number.

Program Number options:

When Parameter E0 is set to 1: 01 to 08

When Parameter E0 is set to 2: 00 to 31

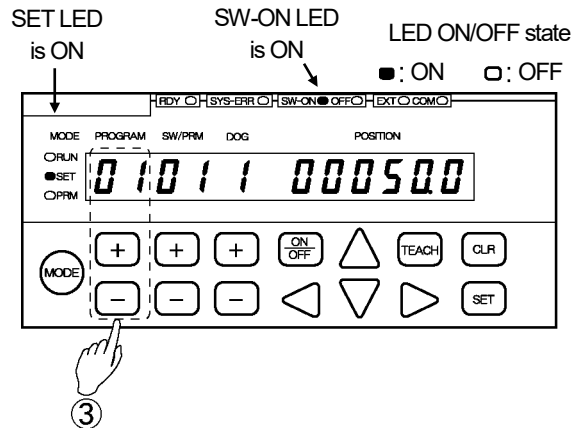

④ Select the deletion mode.

Press the **[+]** or **[-]** key under the PROGRAM display while pressing the **[CLR]** key. The SW/PRM and the POSITION displays will flicker.

The Program deletion can be canceled by pressing the **[CLR]** key at this point.

Step ④ will cause the display to start flickering.
Step ⑤ will cause the display to flicker more quickly.

⑤ Check the deletion details.

Press the **[SET]** key. The SW/PRM and the POSITION displays will flicker more quickly.

Check carefully again if the settings for the selected Program Number should really be deleted.

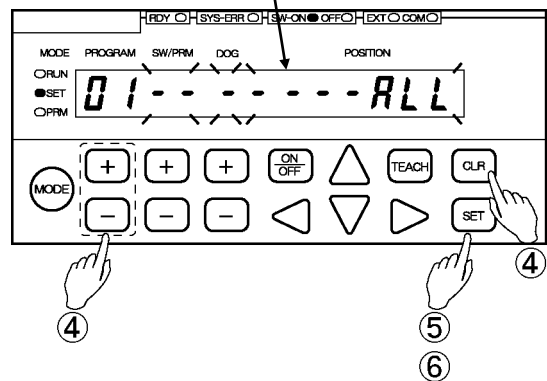

The Program deletion can be canceled by pressing the **[CLR]** key at this point.

⑥ Execute deletion.

Press the **[SET]** key one more time. The SW/PRM, DOG, and the POSITION displays will become solidly on, indicating that all the switch output settings registered to the selected Program Number have been deleted.



OPERATION



SWITCH OUTPUT SETTING

- MEMO -

6. Operation

6-1. Starting operation

VARILIMIT operation can be started in the following steps.

- [1] Select the switch setting mode ("SET").
- [2] Select the Program Number to be run.
- [3] Select the Run mode ("RUN").
- [4] Start operation.

[1] Select the switch setting mode ("SET").

- ① Press and hold down the **MODE** key (more than 1 second).

The POSITION display will flicker to indicate that mode selection is possible.

- ② Press the **MODE** key a number of times until the switch setting mode ("SET") is shown.

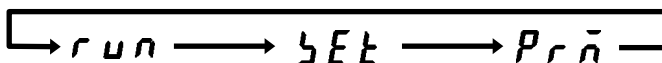
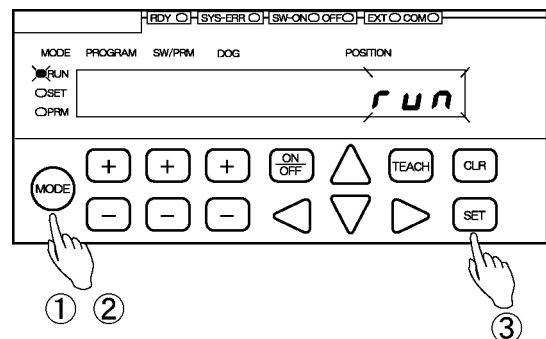

Run mode ("RUN")	Switch setting mode ("SET")	Parameter setting mode ("PRM")
MODE	MODE	MODE
<input checked="" type="checkbox"/> RUN	<input type="checkbox"/> RUN	<input type="checkbox"/> RUN
<input type="checkbox"/> SET	<input checked="" type="checkbox"/> SET	<input type="checkbox"/> SET
<input type="checkbox"/> PRM	<input type="checkbox"/> PRM	<input checked="" type="checkbox"/> PRM

- ③ Press the **SET** key.

The mode is now set to the switch setting mode ("SET").

[2] Select the Program Number to be run.

Use the **+** and **-** keys under the PROGRAM display to select the Program Number.

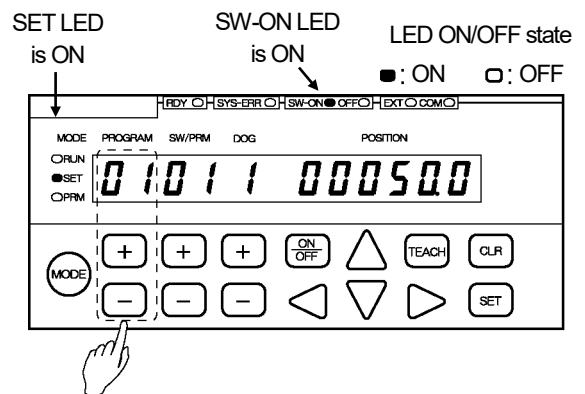

POINT:

To select a Program Number through I/O, refer to "4-8. Program Number Input Format Selection".



[3] Select the Run mode ("RUN").

Select the Run mode ("RUN") by the method described in Step [1].

[4] Start operation

During VARILIMIT operation, the switch outputs will come on or go off according to their respective setting values.

During unit operation, the Current Position Value will be shown in the POSITION display for monitoring. For monitor details, refer to "6-2. Changing the Monitor Types".

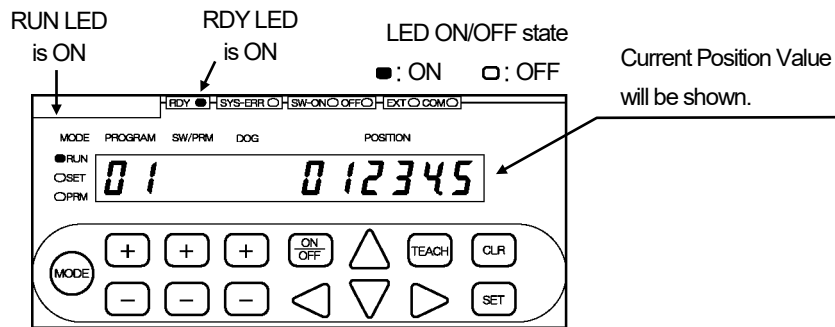

6-2. Changing the monitor types

In the Run mode ("RUN"), the following five types of monitors can be viewed.

- (1) Current Position Value monitor
- (2) I/O signal ON/OFF status monitor
- (3) Switch-output setting value monitor
- (4) Measuring Value history monitor
- (5) Measuring Value monitor

The monitor type can be changed by pressing the ◀ or ▶ key under the POSITION display.

To switch between subscreens of (2), "I/O Signal ON/OFF status monitor", press the ⊕ or ⊖ key under the SW/PRM display.

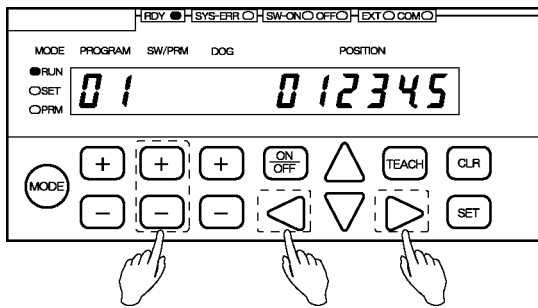

Shown below is the monitor screen configuration.

For monitor screen details, refer to "6-3. Monitors".

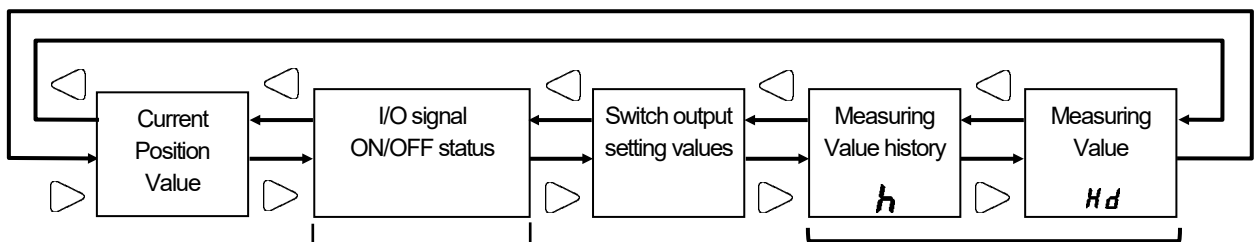

To shift to these modes, Parameter 67 (Measuring Selection) needs to be specified to any from 1 to 4.

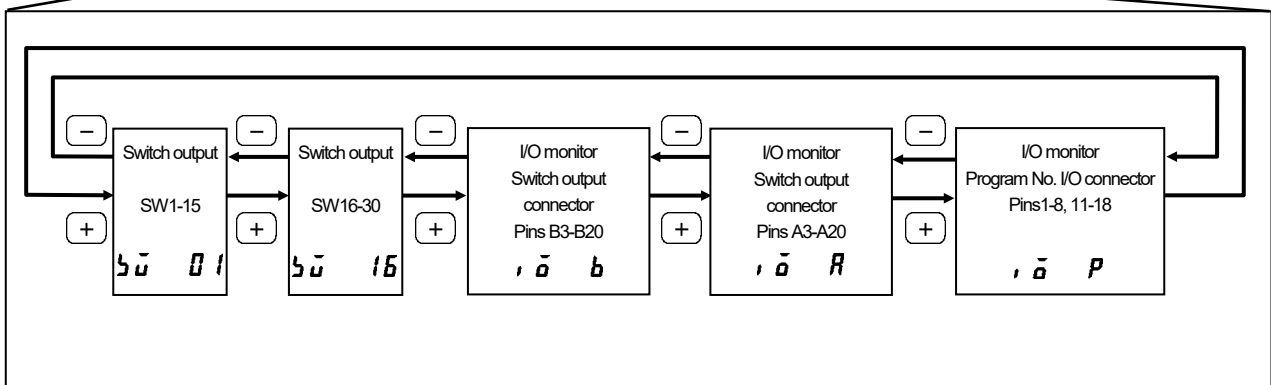



6-3. Monitors

(1) Current Position Value monitor

The Current Position Values can be viewed during unit operation.

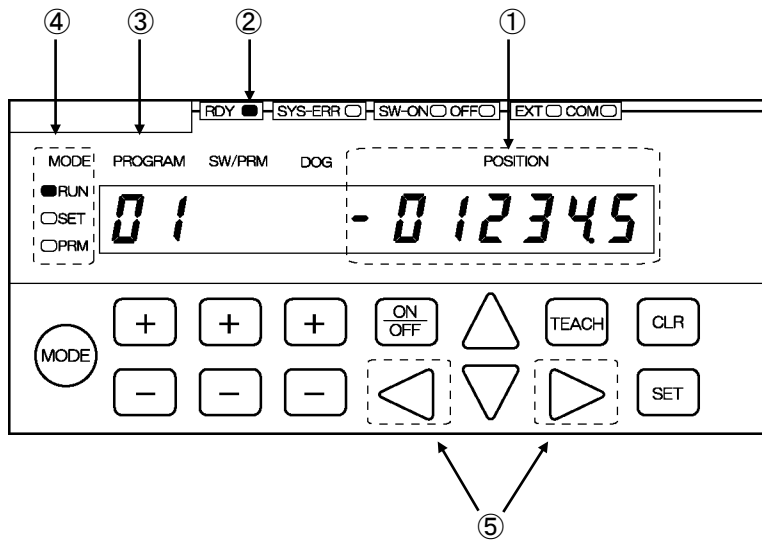

Component	Description
① POSITION display	The Current Position Value can be viewed.
② RDY indicator	The RDY indicator will be on when the unit is in Run mode and no error is present. The conditions are the same as the switch output connector's "System Ready" output.
③ PROGRAM display	The currently selected Program Number will be shown.
④ MODE indicator	When RUN is lit, it indicates that the unit is currently in the Run mode.
⑤ POSITION keys	Use these keys to change the monitor types.

(2) I/O signal ON/OFF status monitor

Each signal of the switch output connector and the program No. I/O connector can be viewed.

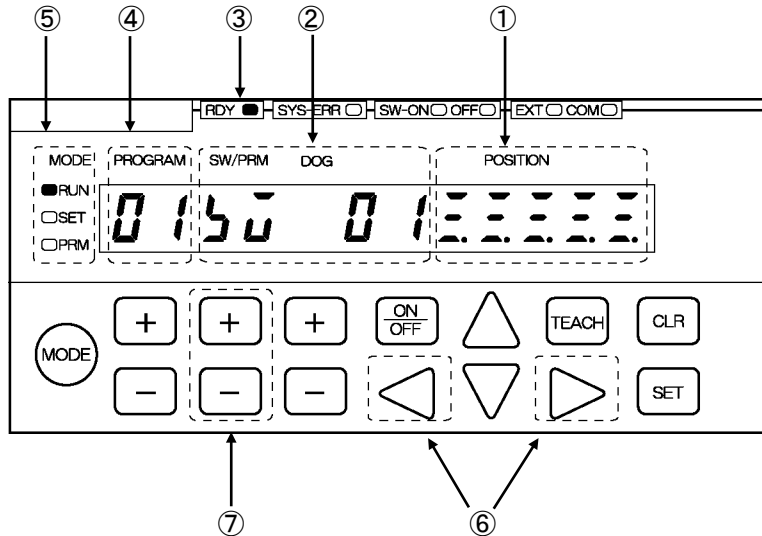

Component	Description
① POSITION display	This is the I/O monitor screen. For further monitor details, refer to the next page.
② SW/PRM display	Shows the title of the currently selected I/O monitor subscreen: 50 01 : Switch output monitor SW1-15 50 15 : Switch output monitor SW16-30 , 0 b : Switch output connector pin monitor B3-B20 , 0 R : Switch output connector pin monitor A3-A20 , 0 P : Program No. I/O connector pin monitor 1-8, 11-18
③ RDY indicator	The RDY indicator will be on when the unit is in Run mode and no error is present. The conditions are the same as the switch output connector's "System Ready" output.
④ PROGRAM display	The currently selected Program Number will be shown.
⑤ MODE indicator	When RUN is lit, it indicates that the unit is currently in the Run mode.
⑥ POSITION keys	Use these keys to change the monitor types.
⑦ SW/PRM keys	Use these keys to select the subscreen to be shown in the POSITION display. - Switch outputs SW1-15 - Switch outputs SW16-30 - Switch output connector pins B3-B20 - Switch output connector pins A3-A20 - Program No. I/O connector pins 1-8, 11-18



● POSITION display monitor details

Shown below are the images of Switch and Connector Pin Numbers that are shown in the POSITION display.

1. Switch output monitor SW1-15

ON : (LED is ON)
OFF : (LED is OFF)

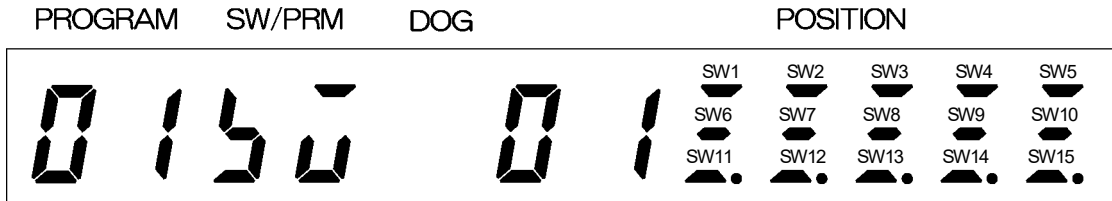

The LEDs under the currently-on Switch Numbers will be lit.

2. Switch output monitor SW16-30

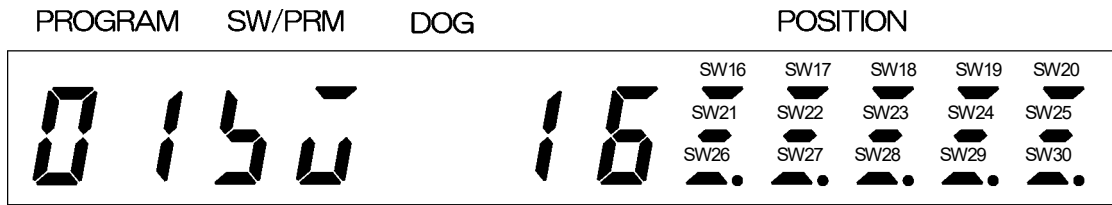

The LEDs under the currently-on Switch Numbers will be lit.

3. Switch output connector pin monitor B3-B20

For the signal names, refer to "2-4-5. I/O Connector Pin Arrangement".

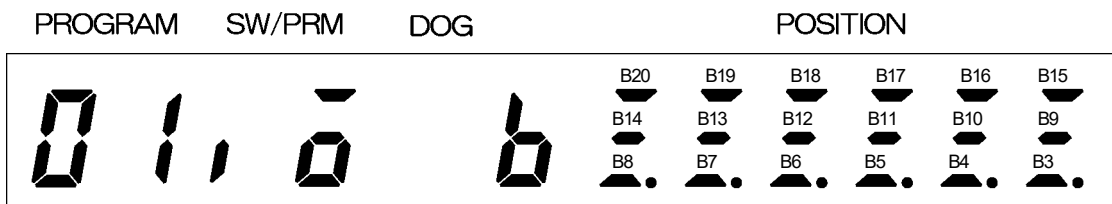

The LEDs under the currently-on Connector Pin Numbers will be lit.

4. Switch output connector pin monitor A3-A20

For the signal names, refer to "2-4-5. I/O Connector Pin Arrangement".

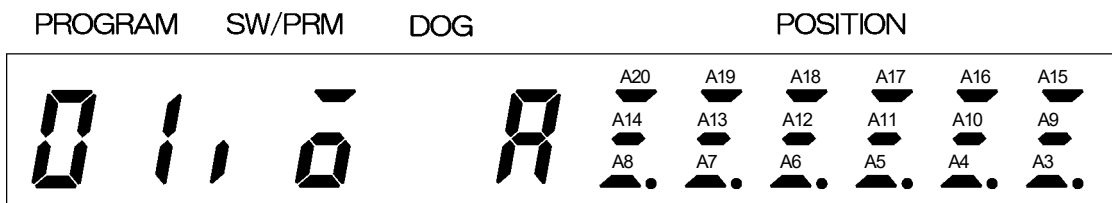

The LEDs under the currently-on Connector Pin Numbers will be lit.



OPERATION



OPERATION

5. Program No. I/O connector pin monitor 1-8, 11-18

For the signal names, refer to "2-4-5. I/O Connector Pin Arrangement".

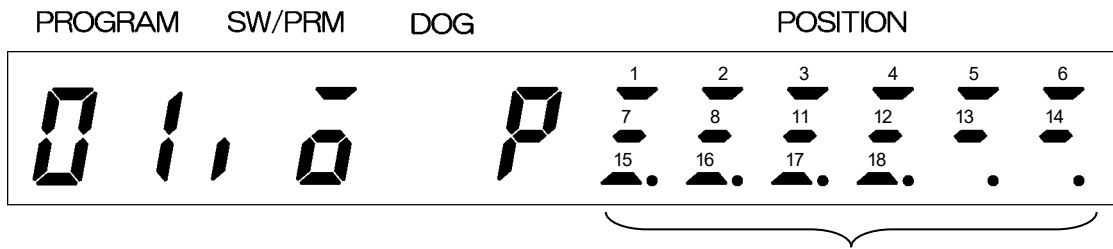

The LEDs under the currently-on Connector Pin Numbers will be lit.

(3) Switch output setting value monitor

The setting values associated with individual switch outputs can be viewed.

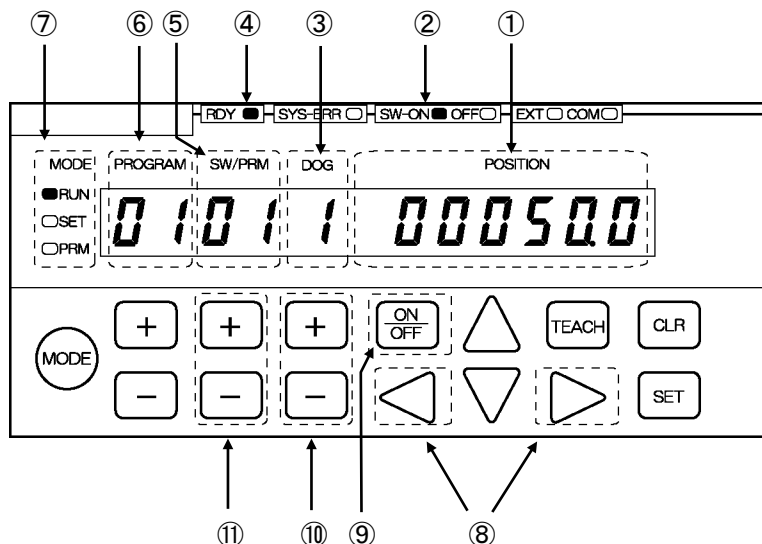

Component	Description
① POSITION display	The ON or OFF setting value will be shown.
② ON/OFF indicator	Indicates what is currently shown in the POSITION display: "SW-ON" lit : An ON setting value is displayed. "OFF" lit : An OFF setting value is displayed.
③ DOG display	The currently selected Dog Number is displayed.
④ RDY indicator	The RDY indicator will be on when the unit is in Run mode and no error is present. The conditions are the same as the switch output connector's "System Ready" output.
⑤ SW/PRM display	The currently selected Switch Number is displayed.
⑥ PROGRAM display	The currently selected Program Number is displayed.
⑦ MODE indicator	When RUN is lit, it indicates that the unit is currently in the Run mode.
⑧ POSITION keys	Use these keys to change the monitor types.
⑨ ON/OFF key	Use this key to switch between ON and OFF setting values.
⑩ DOG keys	Use these keys to select the required Dog Number to be viewed.
⑪ SW/PRM keys	Use these keys to select the required Switch Number to be viewed.



(4) Measuring Value history monitor

The hundred most recent Measuring Values obtained by the Measuring Function can be viewed.

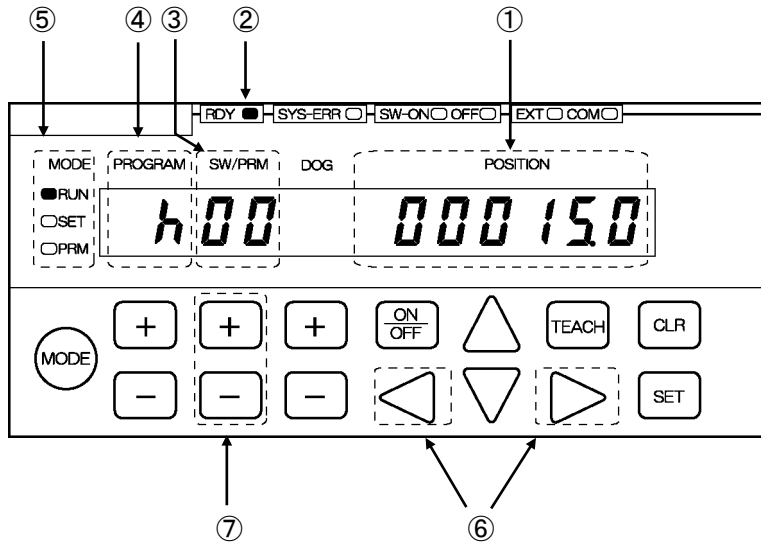

Component	Description
① POSITION display	A past Measuring Value will be shown. For further details, refer to the next page.
② RDY indicator	The RDY indicator will be on when the unit is in Run mode and no error is present. The conditions are the same as the switch output connector's "System Ready" output.
③ SW/PRM display	The Measuring Value History Number will be shown. Hundred History Numbers, from 00 to 99, are used.
④ PROGRAM display	"h" will be shown. It indicates that this is a display to monitor the measuring values.
⑤ MODE indicator	When RUN is lit, it indicates that the unit is currently in the Run mode.
⑥ POSITION keys	Use these keys to change the monitor types.
⑦ SW/PRM keys	Uses these keys to select the History Number to be viewed.



● History details

100 most recent Measuring Values will be stored.

The most recent data will always be stored as History Number 00.

After a second measurement has been taken, the first data will shift to History Number 01.

After a third measurement has been taken, the first data will shift to History Number 02 and the second data to History Number 01.

After a 101st measurement has been taken, the oldest data will start to be deleted.

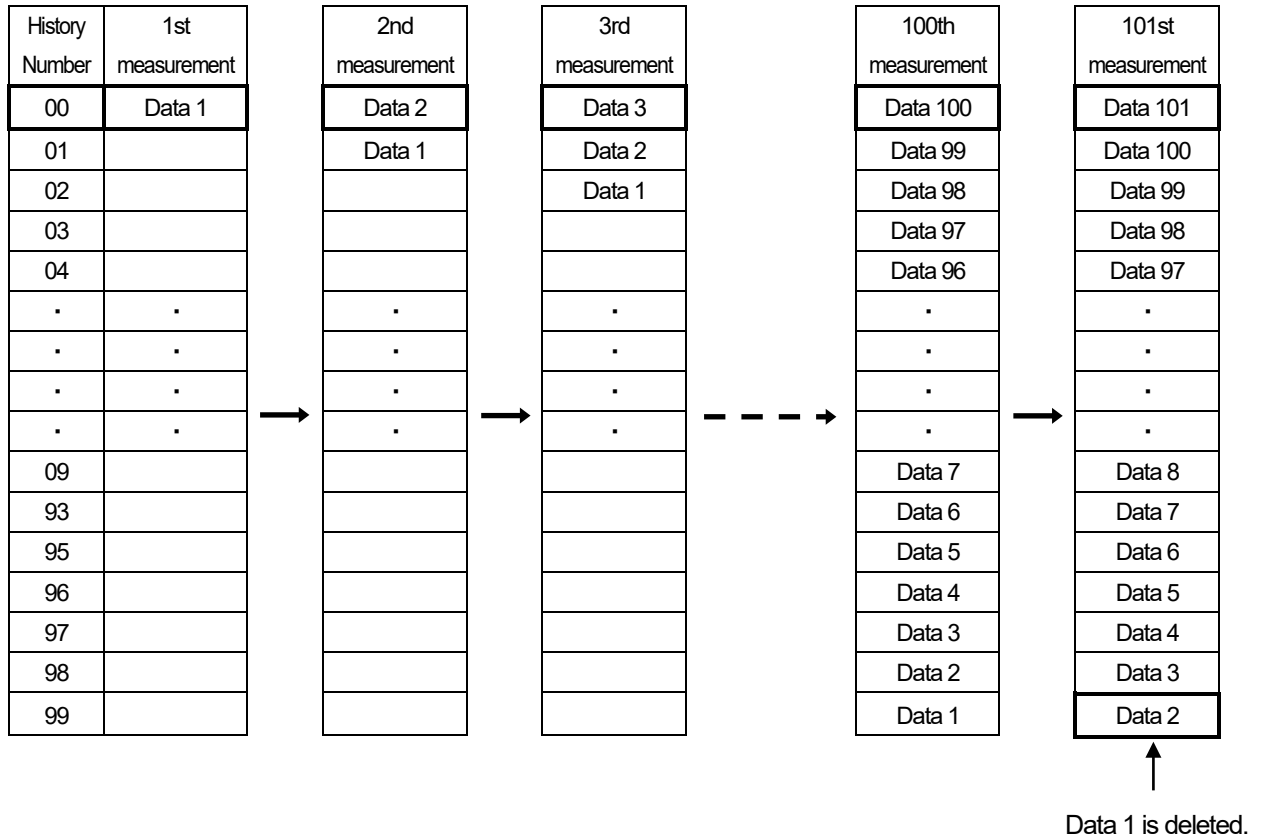

NOTES

The Measuring Value history will not be stored in the internal memory and will therefore be lost when the power is turned off.

If the Measuring Values need to be saved, record them separately.



(5) Measuring Value monitor

The Measuring Value obtained by the Measuring Function can be viewed.

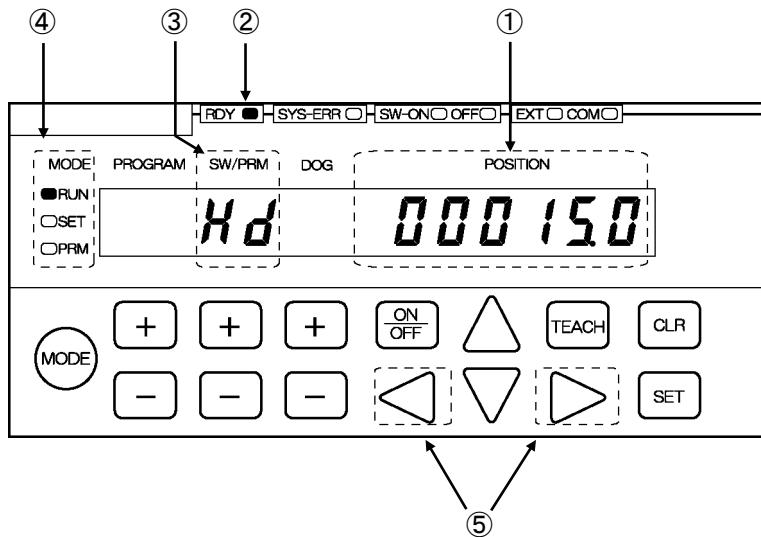

Component	Description
① POSITION display	The Measuring Value will be displayed. If measurement has failed, a " <i>no Hold</i> " message will be shown.
② RDY indicator	The RDY indicator will be on when the unit is in Run mode and no error is present. The conditions are the same as the switch output connector's "System Ready" output.
③ SW/PRM display	" <i>Hd</i> " will be shown, indicating that this is the Measuring Value Monitor screen.
④ MODE indicator	When RUN is lit, it indicates that the unit is currently in the Run mode.
⑤ POSITION keys	Use these keys to change the monitor types.

MAINTANANCE

Describes about countermeasures for errors.

7. TROUBLE SHOOTING

7. TROUBLE SHOOTING

Error causes and countermeasures are described below.

7-1. Error Displays and Countermeasures

Displays the error on VARILIMIT when VARILIMIT or ABSOCODER has an error.

Refer to the following list and implement appropriate countermeasures.

● Lists of the error displays, probable causes, and error cancel procedures

(1/3)

Error display	Name	Probable cause	Error cancel procedure
Err 05 flickers RDY.LED is OFF	Sensor Power Supply Error	The power supply inside of VARILIMIT for sensor breaks down.	Replace VARILIMIT. For more details, refer to the chapter "7-3".
Err 07 flickers RDY.LED is OFF	Sensor Data Error	Sensor connector is loose.	After connecting a connector tightly, cancels the error following methods: - Press the [CLR] key. - Input the error cancel signal from external. NOTE If the Current Position Value does not match the actual position, set Parameter 97 (Current Position Setting) again after the error status is canceled.
		Sensor cable is severed.	Replace the sensor cable. For more details, refer to the chapter "7-3".
		The ABSOCODER has received a severe impact.	After removing the error causes, cancels the error following methods: - Press the [CLR] key. - Input the error cancel signal from external. NOTE If the Current Position Value does not match the actual position, set Parameter 97 (Current Position Setting) again after the error status is canceled.
Err 08 flickers RDY.LED is OFF	Sensor Error	Sensor connector is disconnected and loose.	After removing the error causes, cancels the error following methods: - Press the [CLR] key. - Input the error cancel signal from external.
		Sensor cable is severed.	Replace the sensor cable. For more details, refer to the chapter "7-3".
		ABSOCODER failure	Replace ABSOCODER. For more details, refer to the chapter "7-3".
		VARILIMIT failure	Replace VARILIMIT. For more details, refer to the chapter "7-3".
Err 09 flickers RDY.LED is OFF	Memory Error	Memory data has been changed to due external noise, etc.	Do the initialization operation. For more details, refer to the chapter "7-4". NOTE Data needs to reset up because the parameter and switch output setting values are initialized.
Err 10	Reserved	Does not normally occur.	Contact us.
Err 17 flickers RDY.LED is OFF	No Current Position Value Increase Direction Setting Error	Parameter 91 is not set.	Set Parameter 91(Sensor Selection / Sensor Rotation (Travel) Direction).
Err 19 flickers RDY.LED is OFF	No Current Position Setting Error	Parameter 97 is not set.	Set Parameter 97 (Current Position Setting).

● Lists of the error displays, probable causes, and error cancel procedures

(2/3)

Error display	Name	Probable cause	Error cancel procedure
Err 23 flickers RDY.LED is OFF by parameter setting	Preset Error	<ul style="list-style-type: none"> ●When Parameter E0 is set to 1 or 2 The attempted preset exceeded the permissible correction amount. ●When Parameter E0 is set to 0 No preset has been attempted after the machine passed the preset zone. 	Cancel the error following methods: - Press the [CLR] key. - Input the error cancel signal from external. After the error status is canceled, change the preset signal input position. Or change the preset zone or the preset permissible correction amount setting at parameters.
Err 27 flickers RDY.LED is OFF	Program Number Input Error	A program number other than 1-8 has been input when Parameter E0 is set to 0 or 1.	Input an appropriate program number
Err 29 flickers RDY.LED is OFF	No Minimum Current Position Value Setting Error	Parameter 98 is not set.	Set Parameter 98 (Minimum Current Position Value).
Err 30 flickers RDY.LED is OFF	No Scale Length Setting Error	Parameter 99 is not set.	Set Parameter 99 (Scale Length).
Err 31 flickers RDY.LED is OFF	Scale Length and the Number of Pitches Setting Error	Parameters 99 and A0 are not set.	Set Parameters 99 (Scale Length) and A0 (No. of Scale Length Pitches).
Err 33 flickers RDY.LED is OFF	Number of Pitches Setting Error	Parameters A0 is not set.	Set Parameters A0 (No. of Scale Length Pitches).
Err 40 flickers for two seconds	Multi-Dog Setting Error	The selection of a new Dog Number has been attempted but the currently selected Dog Number has no ON and OFF setting.	Enter ON and OFF position settings to the currently selected Dog Number.
Err 41 flickers for two seconds	Multi-Dog Setting Error	The selection of a new Dog Number has been attempted but the currently selected Dog Number has no ON setting.	Enter an ON position setting to the currently selected Dog Number.
Err 42 flickers for two seconds	Multi-Dog Setting Error	The selection of a new Dog Number has been attempted but the currently selected Dog Number has no OFF setting.	Enter an OFF position setting to the currently selected Dog Number.
Err 43 flickers for two seconds	Multi-Dog Setting Error	A new Dog setting is attempted but it overlaps with an existing Dog range.	Change the setting values so that the Dog will not overlap with existing Dog ranges.
Err 44 flickers for two seconds	Multi-Dog Setting Error	The insertion of an ON-position-only data into between existing Dogs has been attempted.	Insert ON and OFF position settings together, or change the setting value.
Err 45 flickers for two seconds	Multi-Dog Setting Error	The insertion of an OFF-position-only data into between existing Dogs has been attempted.	Insert ON and OFF position settings together, or change the setting value.
Err 46 flickers for two seconds	Multi-Dog Setting Error	The insertion of an ON-position-only data has been attempted into a position where an OFF-position only data is allowed.	Enter an OFF-position-only setting or ON- and OFF-position settings together.
Err 47 flickers for two seconds	Multi-Dog Setting Error	The insertion of an OFF-position-only data has been attempted into a position where an ON-position only data is allowed.	Enter an ON-position-only setting or ON- and OFF-position settings together.
Err 50 flickers RDY.LED is OFF by parameter setting	Preset Data Error	A Current Position Preset is attempted but the Preset Value falls outside the detection range.	Change the current position preset value to a value within the detection range defined by Parameters 99 (Scale Length) and 98 (Minimum Current Position Value).

● Lists of the error displays, probable causes, and error cancel procedures

(3/3)

Error display	Name	Probable cause	Error cancel procedure
Err Hi ↑ Shown alternately ↓ at 2-sec interval Largest permissible setting value	Over the Upper Switch Setting Limit	The attempted setting value for switch output is larger than the upper setting limit.	Change the value to a value within the detection range defined by Parameters 99 (Scale Length) and 98 (Minimum Current Position Value).
Err Lo ↑ Shown alternately ↓ at 2-sec interval Smallest permissible setting value	Below the Lower Switch Setting Limit	The attempted setting value for switch output is smaller than the lower setting limit.	Change the value to a value within the detection range defined by Parameters 99 (Scale Length) and 98 (Minimum Current Position Value).
Err HL ↑ Shown alternately ↓ at 2-sec interval Disabled Setting Value	Switch Setting Value "Out of Detection Range" Error	The attempted value to change the setting value for switch output is out of the detection range.	Delete the setting value for switch output and reset it with a value within the detection range.
Err Eq ↑ Shown alternately ↓ at 2-sec interval Disabled Setting Value	Same Value Setting Not Accepted	The analog output setting has been attempted with the same maximum and minimum position values.	Enter a different value.
"uuuuuu" shown ↑ Shown alternately ↓ An error code	Necessary parameter missing	A parameter necessary for the RUN or the SET mode is not set.	Set the necessary parameter according to the error code shown.
SYS-ERR LED is ON	System Error	Power voltage is low.	Replace the power supply.
		VARILIMIT failure	Replace VARILIMIT. For more details, refer to the chapter "7-3".

7-2. Output Status upon Error Occurrence

Shown below are what the status of the output signals will be when various errors occur.

Output Item	Switch output	Program No. output	Motion detection output / HOLD measuring completed output	Preset error output	Current position output	System ready output	Analog output
Err 05 Sensor Power Supply Error	Output OFF	Output valid	Output OFF	Output OFF	Output OFF	Output OFF	Output 0V or 4mA
Err 07 Sensor Data Error	Output OFF	Output valid	Output OFF	Output OFF	Output OFF	Output OFF	Output 0V or 4mA
Err 08 Sensor Error	Output OFF	Output valid	Output OFF	Output OFF	Output OFF	Output OFF	Output 0V or 4mA
Err 09 Memory Error	Output OFF	Output OFF	Output OFF	Output OFF	Output OFF	Output OFF	Output 0V or 12mA
Err 10 Reserved	Output OFF	Output valid	Output OFF	Output OFF	Output OFF	Output OFF	Output 0V or 4mA
Err 17 No Current Position Value Increase Direction Setting Error	Output OFF	Output OFF	Output OFF	Output OFF	Output OFF	Output OFF	Output 0V or 4mA
Err 19 No Current Position Setting Error	Output OFF	Output valid	Output OFF	Output OFF	Output OFF	Output OFF	Output 0V or 4mA
Err 23 Preset Error	Output valid	Output valid	Output valid	Depends on Parameter Setting	Output valid	Depends on Parameter Setting	Output valid
Err27 Program Number Input Error	Indefinite output	Indefinite output		Output valid	Output valid	Output OFF	Output valid
Err 29 No Minimum Current Position Value Setting Error	Output OFF	Output OFF	Output OFF	Output OFF	Output OFF	Output OFF	Output 0V or 4mA
Err 30 No Scale Length Setting Error	Output OFF	Output OFF	Output OFF	Output OFF	Output OFF	Output OFF	Output 0V or 4mA
Err31 Scale Length and the Number of Pitches Setting Error	Output OFF	Output OFF	Output OFF	Output OFF	Output OFF	Output OFF	Output 0V or 4mA
Err33 No. of Pitches Setting Error	Output OFF	Output OFF	Output OFF	Output OFF	Output OFF	Output OFF	Output 0V or 4mA
Err 40 to Err 47 Multi-Dog Setting Error	This is an error that may occur upon a Multi-Dog setting attempt.						
Err 50 Preset Data Error	Output valid	Output valid	Output valid	Depends on Parameter Setting	Output valid	Depends on Parameter Setting	Output valid

7-3. Procedure Contents after Replacing

Carry out the following measures after replacing VARILIMIT, ABSOCODER, and sensor cable.

Replacing contents	Measures
In the case of replacing ABOSOCODER	Carry out the following steps after replacement: <ol style="list-style-type: none"> 1. Cancel the error status by one of the following methods: <ul style="list-style-type: none"> - Press the [CLR] key. - Input the error cancel signal from external. 2. Enter the Current Position Value to Parameter 97.
In the case of replacing the sensor cable	Carry out the following steps after replacement: <ol style="list-style-type: none"> 1. Cancel the error status by one of the following methods: <ul style="list-style-type: none"> - Press the [CLR] key. - Input the error cancel signal from external. 2. Enter the Current Position Value to Parameter 97.
In the case of replacing VARILIMIT	Set all the necessary parameters and switch outputs after replacement.

7-4. Initialization Operation

All the VARILIMIT setting contents are deleted after the initialization operation, and the setting is initialized as the factory setting value.

Initializes the setting in the following steps.

- ① Turn the power on with holding 3 keys (**MODE**, **+** of SW/PRM, and **SET**) at same time.
Holds 3 key more than 1 second, and the initialization will start.

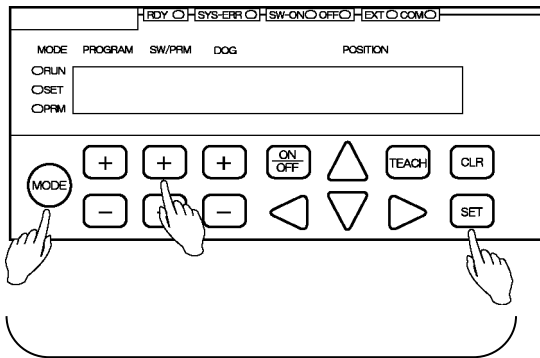

Presses 3 keys at same time.

- ② The display is following figure when the initialization starts.

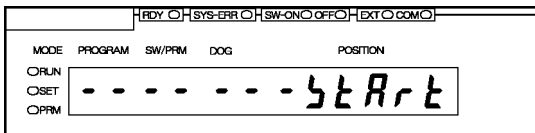

The display is following figure when the initialization finishes.

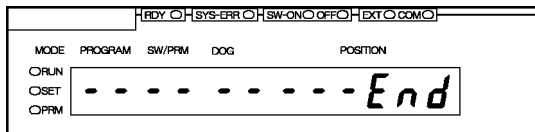

- ③ Turn the power off and then on again.
This is the end of the initialization operation.

NOTES

The parameter setting contents and switch output setting value are deleted after the initialization operation.
Before the initialization, check the machine position (origin point etc.) and setting contents and write it on data sheet which is attached with this manual.



MAINTANANCE



TROUBLE SHOOTING

- MEMO -

APPENDIX

Attaches descriptions of the the data sheets.

APPENDIX 1. DATA SHEET

APPENDIX 1. DATA SHEET

APPENDIX 1-1. Extended Mode Data Sheet

APPENDIX 1-1-1. Parameter data sheet

●When Parameter E0 is set to 1 or 2

(1/5)

No.	Name	Setting ranges and initial values: The initial values are shown inside "□".	Applicable model			Reference (Chapter No.)	Setting value
			10GH -D	10GH -A	10GH -C		
E0	VARILIMIT Mode Selection	<input type="checkbox"/> : VS-10B Mode 8 programs, 30 switches, 10 Dogs 1: Extended Mode 8 programs, 30 switches, 10 Dogs 2: Extended Mode 32 programs, 30 switches, 4 Dogs	○	○	○	4-1	
00	Initial Display	The items selected using Parameter E0 will be shown.	○	○	○		
A0	Number of Scale Length Pitches[n] *1	1 to 9999 □	○	○	○	4-6	
99	Scale Length [L]	10 to 999999 □	○	○	○	4-6	
98	Minimum Current Position Value [K]	-999999 to (1000000-L) □	○	○	○	4-6	
97	Current Position Setting	K to (K+L-1) □	○	○	○	4-6	
96	Protected Switch Suspended	<input type="checkbox"/> : Protected Switch function enabled 1: Protected Switch function suspended	○	○	○	4-10	
94	Current Position Output Code/Logic	<input type="checkbox"/> : BCD output (negative logic) / decimal point output (positive logic) 1: BCD output (positive logic) / decimal point output (negative logic) 2: BCD output (negative logic) / decimal point output (negative logic) 3: BCD output (positive logic) / decimal point output (positive logic) 4: Binary output (sign magnitude code, negative logic), decimal point output (positive logic) 5: Binary output (sign magnitude code, positive logic), decimal point output (negative logic) 6: Binary output (two's complement, negative logic), decimal point output (positive logic) 7: Binary output (two's complement, positive logic), decimal point output (negative logic)	○			4-12	
93	Program No. Input Method	<input type="checkbox"/> : Panel key input 1 : External input via connector 2 : Serial communication	○	○	○	4-6	
92	Current Position Preset Function Selection	<input type="checkbox"/> : Preset Disabled 1 : Preset Enabled	○	○	○	4-7 4-21	

Remarks

*1: Set this parameter when using VS-10GH**-LC.
Any other VARILIMIT model does not display this number.

●When Parameter E0 is set to 1 or 2

(2/5)

No.	Name	Setting ranges and initial values: The initial values are shown inside "□".	Applicable model			Reference (Chapter No.)	Setting value
			10GH -D	10GH -A	10GH -C		
91	Sensor Selection / Sensor Rotation (Travel) Direction	0: CW 1: CCW <input type="checkbox"/> □	<input type="checkbox"/>	<input type="checkbox"/>	<input type="checkbox"/>	4-4	
90	Decimal Point Position	<input type="checkbox"/> : [][][][][][] 1: [][][][] [] 2: [][][] [][] 3: [][] [][] 4: [][] [][] 5: [] [][][][]	<input type="checkbox"/>	<input type="checkbox"/>	<input type="checkbox"/>	4-5	
82	Current Position Preset Error Selection	<input type="checkbox"/> : Disabled SW30: Switch output, System ready output ON in case of errors, No error display 1: Enabled SW30: Error output, System ready output ON in case of errors, No error display 2: Enabled SW30: Switch output, System ready output OFF in case of errors, Error display ([Err23 or Err50]) 3: Enabled SW30: Error output, System ready output OFF in case of errors, Error display ([Err23 or Err50])	<input type="checkbox"/>	<input type="checkbox"/>	<input type="checkbox"/>	4-7 4-21	
78	Output Status in Other Than RUN Mode	<input type="checkbox"/> : Output Hold 1: Output Off	<input type="checkbox"/>	<input type="checkbox"/>	<input type="checkbox"/>	4-13	
77	Motion Detection Direction	<input type="checkbox"/> : Motion Detection Output disabled (SW29 operates for switch output.) 1: Both directions 2: Forward direction 3: Reverse direction	<input type="checkbox"/>	<input type="checkbox"/>	<input type="checkbox"/>	4-11	
76	Motion Detection Speed	0 to 999999 <input type="checkbox"/> 500/s	<input type="checkbox"/>	<input type="checkbox"/>	<input type="checkbox"/>	4-11	
75	Latch Pulse Timing	<input type="checkbox"/> : Current position output is stable when changing from 0 to 1. 1: Current position output is stable when changing from 1 to 0. 2: Current position output is stable at Level 0. 3: Current position output is stable at Level 1.	<input type="checkbox"/>			4-12	
74	Current Position Output Update Cycle [n] / HOLD Method Selection	0: PC Synchronization Method <input type="checkbox"/> 1 to 128: Transparent Method Setting Value [n] × 4 = Current Position Output Update Cycle [ms]	<input type="checkbox"/>			4-12	
73	PC Synchronization Delay Value	0 to 99 [ms] <input type="checkbox"/> 0	<input type="checkbox"/>			4-12	
71	Hysteresis Width	0 to 999999 <input type="checkbox"/> 0	<input type="checkbox"/>	<input type="checkbox"/>	<input type="checkbox"/>	4-17	
70	Switch Output Enabling Range	<input type="checkbox"/> : Disabled 1 to 30: Enabled	<input type="checkbox"/>	<input type="checkbox"/>	<input type="checkbox"/>	4-18	

●When Parameter E0 is set to 1 or 2

(3/5)

No.	Name	Setting ranges and initial values: The initial values are shown inside "□".	Applicable model			Reference (Chapter No.)	Setting value
			10GH -D	10GH -A	10GH -C		
67	Measuring/Motion Recording Selection	<input type="checkbox"/> : Measuring/Motion Record is disable 1: Start measurement upon external measurement trigger OFF 2: Start measurement upon external measurement trigger ON 3: HOLD Clear Threshold/Current Position Value increase direction 4: HOLD Clear Threshold/Current Position Value decrease direction 5: Motion Recording position/During traveling in the increase direction 6: Motion Recording position/During traveling in the decrease direction 7: Motion Recording communication and position/During traveling in the increase direction 8: Motion Recording communication and position/During traveling in the decrease direction	<input type="radio"/>	<input type="radio"/>	<input type="radio"/>	4-14-2 4-15	
68	Current Position Value/Measuring Value Output Selection	<input type="checkbox"/> : Switch output - Measuring Value 1 : Switch output - Current Position Value		<input type="radio"/>	<input type="radio"/>	4-14-3	
		<input type="checkbox"/> : Switch output - Measuring Value/ Current position output - Measuring Value 1 : Switch output - Current Position Value/ Current position output - Measuring Value 2 : Switch output - Measuring Value / Current position output - Current Position Value 3 : Switch output - Current Position Value / Current position output - Current Position Value	<input type="radio"/>				
66	HOLD Clear Threshold / Motion Recording Start Position	-999999 to 999999 <input type="text" value="0"/>	<input type="radio"/>	<input type="radio"/>	<input type="radio"/>	4-14-4 4-15	
65	HOLD Measuring Stable Width	0 to 999999 <input type="text" value="0"/>	<input type="radio"/>	<input type="radio"/>	<input type="radio"/>	4-14-5	
64	HOLD Measuring Stable Time / Motion Recording Sampling Cycle	0.001 to 9.999 [s] <input type="text" value="0.001"/>	<input type="radio"/>	<input type="radio"/>	<input type="radio"/>	4-14-6 4-15	
63	Sensor Filter	<input type="checkbox"/> : None 1 : Four samplings 2 : Eight samplings 3 : 16 samplings 4 : 32 samplings 5 : 64 samplings 6 : 128 samplings	<input type="radio"/>	<input type="radio"/>	<input type="radio"/>	4-16	
62	HOLD Measuring Completed Output (Approved/Disapproved)	<input type="checkbox"/> : Disapproved (Used as Switch output 28) 1: Approved (Used as output HOLD measuring completed output)	<input type="radio"/>	<input type="radio"/>	<input type="radio"/>	4-14-7	
59	Downloading Enabled Selection	<input type="checkbox"/> : Prohibited 1 : Permitted	<input type="radio"/>	<input type="radio"/>	<input type="radio"/>	4-24	
58	Baud Rate	0 : 2400bps 3 : 19200bps 1 : 4800bps 4 : 38400bps <input checked="" type="checkbox"/> : 9600bps 5 : 57600bps	<input type="radio"/>	<input type="radio"/>	<input type="radio"/>	4-25	
56	Node Number	0 to 15 <input type="text" value="1"/>	<input type="radio"/>	<input type="radio"/>	<input type="radio"/>	4-27	
54	Protocol	<input type="checkbox"/> : NSD 1 : MELSEC-A 2 : MELSEC 3 : OMRON 9 : VARIMONI	<input type="radio"/>	<input type="radio"/>	<input type="radio"/>	4-26	
53	Device Selection	<input type="checkbox"/> : D (Data register) 1 : R (File register)	<input type="radio"/>	<input type="radio"/>	<input type="radio"/>	4-28	
52	Device No.	0 to 9000 <input type="text" value="0"/>	<input type="radio"/>	<input type="radio"/>	<input type="radio"/>	4-29	

●When Parameter E0 is set to 1 or 2

(4/5)

No.	Name	Setting ranges and initial values: The initial values are shown inside "□".	Applicable model			Reference (Chapter No.)	Setting value
			10GH -D	10GH -A	10GH -C		
51	Communication Dog No.	When Parameter E0 is set to 1 1 to A (1 to 10) □ 1 When Parameter E0 is set to 2 1 to 4 □ 1	○	○	○	4-30	
50 40	Reserved	□ 0 Fixed	○	○	○	—	
38	Ch. 2 Maximum Output Position/Speed	—999999 to 999999 □ —999999		○	○	4-23 4-23-3	
37	Ch. 2 Minimum Output Position/Speed	—999999 to 999999 □ —999999		○	○	4-23 4-23-3	
36	Ch. 2 Output Selection	With VS-10GH-A(-1) (voltage output model) □: Position voltage output 1: Speed voltage output With VS-10GH-C-1 (current output model) □: Position current output 1: Speed current output		○	○	4-23 4-23-1	
35	Ch. 2 Maximum Output Voltage (Vmax)	Vmin to 10.00 [V] □ 10.00		○		4-23 4-23-2	
34	Ch. 2 Minimum Output Voltage (Vmin)	—10.00 to Vmax [V] □ —10.00		○		4-23 4-23-2	
33	Ch. 2 Deadband Position/Speed	—999999 to 999999 □ 0		○	○	4-23 4-23-4	
32	Ch. 2 Deadband Width	0 to 999999 □ 0		○	○	4-23 4-23-4	
30	Ch. 1 Maximum Output Position/Speed	—999999 to 999999 □ 999999		○	○	4-23 4-23-3	
29	Ch. 1 Minimum Output Position/Speed	—999999 to 999999 □ —999999		○	○	4-23 4-23-3	
28	Ch. 1 Output Selection	With VS-10GH-A(-1) (voltage output model) □: Position voltage output 1: Speed voltage output (for monitoring) With VS-10GH-C-1 (current output model) □: Position current output 1: Speed current output (for monitoring)		○	○	4-23 4-23-1	
27	Ch. 1 Maximum Output Voltage (Vmax)	Vmin to 10.00 [V] □ 10.00		○		4-23 4-23-2	
26	Ch. 1 Minimum Output Voltage (Vmin)	—10.00 to Vmax [V] □ —10.00		○		4-23 4-23-2	
25	Ch. 1 Deadband Position/Speed	—999999 to 999999 □ 0		○	○	4-23 4-23-4	

●When Parameter E0 is set to 1 or 2

(5/5)

No.	Name	Setting ranges and initial values: The initial values are shown inside "□".	Applicable model			Reference (Chapter No.)	Setting value
			10GH -D	10GH -A	10GH -C		
24	Ch. 1 Deadband Width	0 to 999999 □0		○	○	4-23 4-23-4	
23	Speed Sampling Time	0.001 to 9.999 [S] □0.001		○	○	4-23 4-23-5	
22	Number of Speed Gate	1 to 99 □1		○	○	4-23 4-23-5	
21	Number of Limitswitch Timer Switches	□: Disabled 1 to 30: Enabled	○	○	○	4-22	
20	Number of Protected Switch	□: No Protected Switch 1 to 30: Switches from 1 to what is set at the parameter will serve as protected switches.	○	○	○	4-9	
19	Limitswitchless Preset Stroke 2	0 to 999999 □0	○	○	○	4-21	
18	Limitswitchless Preset Value 2	—999999 to 999999 □0	○	○	○	4-21	
17	Stop Decision Time 2 during Limitswitchless Preset	0.100 to 9.999 [S] □0.100	○	○	○	4-21	
16	Limitswitchless Preset Stroke 1	0 to 999999 □0	○	○	○	4-21	
15	Limitswitchless Preset Value 1	—999999 to 999999 □0	○	○	○	4-21	
14	Stop Decision Time 1 during Limitswitchless Preset	0.100 to 9.999 [S] □0.100	○	○	○	4-21	
13	Limitswitchless Preset Function Enabled/Disabled	□: Disabled 1: Enabled	○	○	○	4-21	
12	Preset Error Absorption Function Enabled/Disabled	□: Disabled 1: Enabled	○	○	○	4-20	
11	Permissible Correction Amount 2	0 to 999999 □999999	○	○	○	4-7	
10	"FWD Current Position Preset" Value 2	—999999 to 999999 □0	○	○	○	4-7	
9	"RVS Current Position Preset" Value 2	—999999 to 999999 □0	○	○	○	4-7	
8	Permissible Correction Amount 1	0 to 999999 □999999	○	○	○	4-7	
7	"FWD Current Position Preset" Value 1	—999999 to 999999 □0	○	○	○	4-7	
6	"RVS Current Position Preset" Value 1	—999999 to 999999 □0	○	○	○	4-7	
5	Multi-Origin Selection	When Parameter E0 is set to 1 1 to 8 □8 When Parameter E0 is set to 2 0 to 31 □31	○	○	○	4-19	



APPENDIX 1-1-3. Limitswitch timer data sheet

The switch outputs from 1 to what is set at Parameter 21 will be valid for the Limitswitch Timer function.

Please copy required number of this data sheets.

Program No. :		Program Name :
Switch No.	Switch Name	Setting Value
		Start Position (ON Position) : _____ End Position (OFF Position) : _____ ON Delay Time : _____ Output ON Time : _____
		Start Position (ON Position) : _____ End Position (OFF Position) : _____ ON Delay Time : _____ Output ON Time : _____
		Start Position (ON Position) : _____ End Position (OFF Position) : _____ ON Delay Time : _____ Output ON Time : _____
		Start Position (ON Position) : _____ End Position (OFF Position) : _____ ON Delay Time : _____ Output ON Time : _____
		Start Position (ON Position) : _____ End Position (OFF Position) : _____ ON Delay Time : _____ Output ON Time : _____
		Start Position (ON Position) : _____ End Position (OFF Position) : _____ ON Delay Time : _____ Output ON Time : _____
		Start Position (ON Position) : _____ End Position (OFF Position) : _____ ON Delay Time : _____ Output ON Time : _____
		Start Position (ON Position) : _____ End Position (OFF Position) : _____ ON Delay Time : _____ Output ON Time : _____
		Start Position (ON Position) : _____ End Position (OFF Position) : _____ ON Delay Time : _____ Output ON Time : _____
		Start Position (ON Position) : _____ End Position (OFF Position) : _____ ON Delay Time : _____ Output ON Time : _____
		Start Position (ON Position) : _____ End Position (OFF Position) : _____ ON Delay Time : _____ Output ON Time : _____
		Start Position (ON Position) : _____ End Position (OFF Position) : _____ ON Delay Time : _____ Output ON Time : _____
		Start Position (ON Position) : _____ End Position (OFF Position) : _____ ON Delay Time : _____ Output ON Time : _____

APPENDIX 1-2. Switch Output Data Sheet

Please copy required number of this data sheets.

Program No. :		Program Name :												
Switch No.	Switch Name	Multi-dog No.										A		
		1	2	3	4	5	6	7	8	9				
		ON: OFF:	ON: OFF:	ON: OFF:	ON: OFF:	ON: OFF:	ON: OFF:	ON: OFF:	ON: OFF:	ON: OFF:	ON: OFF:	ON: OFF:	ON: OFF:	ON: OFF:
		ON: OFF:	ON: OFF:	ON: OFF:	ON: OFF:	ON: OFF:	ON: OFF:	ON: OFF:	ON: OFF:	ON: OFF:	ON: OFF:	ON: OFF:	ON: OFF:	ON: OFF:
		ON: OFF:	ON: OFF:	ON: OFF:	ON: OFF:	ON: OFF:	ON: OFF:	ON: OFF:	ON: OFF:	ON: OFF:	ON: OFF:	ON: OFF:	ON: OFF:	ON: OFF:
		ON: OFF:	ON: OFF:	ON: OFF:	ON: OFF:	ON: OFF:	ON: OFF:	ON: OFF:	ON: OFF:	ON: OFF:	ON: OFF:	ON: OFF:	ON: OFF:	ON: OFF:
		ON: OFF:	ON: OFF:	ON: OFF:	ON: OFF:	ON: OFF:	ON: OFF:	ON: OFF:	ON: OFF:	ON: OFF:	ON: OFF:	ON: OFF:	ON: OFF:	ON: OFF:
		ON: OFF:	ON: OFF:	ON: OFF:	ON: OFF:	ON: OFF:	ON: OFF:	ON: OFF:	ON: OFF:	ON: OFF:	ON: OFF:	ON: OFF:	ON: OFF:	ON: OFF:
		ON: OFF:	ON: OFF:	ON: OFF:	ON: OFF:	ON: OFF:	ON: OFF:	ON: OFF:	ON: OFF:	ON: OFF:	ON: OFF:	ON: OFF:	ON: OFF:	ON: OFF:
		ON: OFF:	ON: OFF:	ON: OFF:	ON: OFF:	ON: OFF:	ON: OFF:	ON: OFF:	ON: OFF:	ON: OFF:	ON: OFF:	ON: OFF:	ON: OFF:	ON: OFF:



NSD Group

Manufacturer

NSD Corporation 3-31-28, OSU, NAKA-KU, NAGOYA, JAPAN 460-8302

Distributor

NSD Trading Corporation 3-31-23, OSU, NAKA-KU, NAGOYA, JAPAN 460-8302

Phone: +81-52-261-2352 Facsimile: +81-52-252-0522

URL: www.nsdcorp.com E-mail: foreign@nsdcorp.com

Copyright©2024 NSD Corporation All rights reserved.