



ZEF005850106



EtherNet/IP™

ABSOCODER Converter

NCW-3DNIPMP

Specifications & Instruction Manual

Applicable sensor: MRE-32SP062

MRE-G[]SP062



CONTENTS

INTRODUCTION	i
COPYRIGHT	i
GENERAL SAFETY RULES	ii
REVISION HISTORY	iii
1. OVERVIEW	1
1-1. Features.....	2
2. MODEL SELECTION WHEN ORDERING	3
3. SPECIFICATIONS	4
3-1. Converter Specifications	4
3-2. ABSOCODER Sensor Specification.....	6
3-3. Extension Sensor Cable Specification.....	6
4. DIMENSIONS	7
4-1. Converter Dimension	7
4-2. ABSOCODER Sensor Dimensions	8
4-3. Extension Sensor Cable Dimension	10
5. CHECKING THE CONTENTS OF THE SHIPPING CASE	11
6. INSTALLATION	12
6-1. Converter Installation Conditions and Precautions.....	12
6-2. ABSOCODER Sensor Installation Conditions and Precautions.....	13
7. WIRING	16
7-1. Connection between Converter and ABSOCODER Sensor.....	16
7-2. Power Supply Connection.....	17
8. NOMENCLATURE	18
8-1. Part Identification	18
8-2. Function and Name of Indicator and Setting Area.....	19
8-2-1. Contents of the communication status indicator area.....	20
8-2-2. Contents of the data indicator area	21
8-2-3. Ethernet connector (LINK1/LINK2).....	23
8-2-4. Ethernet IP address setting switch (IP).....	23
9. EtherNet/IP COMMUNICATION SETUP	24
9-1. Procedure Before the Operation.....	24
9-2. Preparation.....	25
9-3. Communication Speed and Format Setting.....	26
9-4. Set the IP Address of NCW-3DNIP	27
9-4-1. Manual setting method of the IP address by IP address setting switch.....	27
9-4-2. Allocation method of an IP address by the BOOTP/DHCP server	28
9-5. Configure the EtherNet/IP Driver	35
9-6. Configuration of EtherNet/IP Network	39
9-6-1. Configuration procedure.....	39
9-6-2. Installation of the EDS file.....	40

9-6-3. Creation of a controller project.....	45
9-6-4. Adding NCW-3DNIP to the controller project.....	47
9-6-5. Download the project.....	54
9-7. Set Parameter of NCW-3DHIP	58
9-7-1. Parameter List	59
9-7-2. Parameters Setting Procedure	60
9-8. Confirm Position Data of NCW-3DNIP	67
9-9. CIP Implicit Messaging (I/O Connection).....	68
9-9-1. Exclusive-Owner Connection	68
9-10. Device Level Ring (DLR) Function.....	73
10. INSPECTION.....	74
11. TROUBLE SHOOTING.....	75
11-1. Check Methods during an Error Is Occurred	75
11-2. Measures when a Communication Error Occurs	75
11-3. CIP General Status Code.....	76
11-4. CIP Extended Status Code	79
11-4-1. Connection Manager Object Instance Extended Status Code	79
11-4-2. Extended status codes for protocol stack (communication control part)	81
11-5. NCW-3DNIP Indicator.....	82
11-5-1. Status indicator (MS/NS).....	82
11-5-2. Link status indicator (L/A1·L/A2).....	83
11-5-3. Converter status indicator.....	83
11-6. Reset Service.....	84
12. STORE OF MAINTENANCE INFORMATION.....	86
13. ABSOCODER SENSOR CHECK LIST	87
14. CE MARKING	89
14-1. EMC Directives.....	89
14-2. EMC Directive and Standards	89
14-3. Low Voltage Directive	89
14-4. Measures for EMC Compliance.....	90
14-5. Restrictions.....	90
APPENDIX 1. CIP OBJECT MODEL	91
APPENDIX 2. DETAILS OF CIP OBJECT.....	92
APPENDIX 2-1. Identity Object (Class ID: 0x01).....	92
APPENDIX 2-2. Message Router Object (Class ID: 0x02)	95
APPENDIX 2-3. Assembly Object (Class ID: 0x04)	96
APPENDIX 2-4. Connection Manager Object (Class ID: 0x06).....	98
APPENDIX 2-5. Parameter Object (Class ID: 0x0F).....	100
APPENDIX 2-6. ABSOCODER Object (Class ID: 0x64).....	106
APPENDIX 2-7. QoS Object (Class ID: 0x48)	108
APPENDIX 2-8. TCP/IP Interface Object (Class ID: 0xF5)	111
APPENDIX 2-9. Ethernet Link Object (Class ID: 0xF6)	115
APPENDIX 2-10. Info Log Object (Class ID: 0xC5)	119
APPENDIX 2-11. Info Diagnosis Object (Class ID: 0xC6).....	122
APPENDIX 2-12. Info Maintenance Object (Class ID: 0xC7)	123
APPENDIX 2-13. Device Level Ring (DLR) Object (Class ID: 0x47).....	124

APPENDIX 3. WEB SERVER FUNCTION	126
APPENDIX 3-1. Login Procedures	127
APPENDIX 3-2. User management function	128
APPENDIX 3-3. Setting / Reference display	129

INTRODUCTION

Thank you very much for purchasing our product.

Before operating this product, be sure to carefully read this manual so that you may fully understand the product, safety instructions and precautions.

- Please submit this manual to the operators actually involved in operation.
- Please keep this manual in a handy place.

COPYRIGHT

- EtherNet/IP and its logo are trademarks used under license by ODVA.
- Company and product names that appear in this manual are registered trademarks or trademarks of their respective holders.

GENERAL SAFETY RULES

● Application Limitation



This product is not designed to be used under any situation affecting human life. When you are considering using this product for special purposes such as medical equipment, aerospace equipment, nuclear power control systems, traffic systems, and etc., please consult with NSD.

This product is designed to be used under the industrial environments categorized in Class A device.

The supplier and user may be required to take appropriate measures.



● Signal Words

Safety precautions in this guide are classified into DANGER and CAUTION.

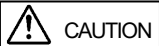

Symbol	Meaning
 DANGER	Incorrect handling may cause a hazardous situation that will result in death or serious injury.
 CAUTION	Incorrect handling may cause a hazardous situation that will result in moderate injury or physical damage.



Instructions accompanied by a symbol  CAUTION may also result in serious damage or injury. Be sure to follow the all instructions accompanied by the symbol.

● Graphic Symbols



Symbol	Meaning
	Indicates prohibited items.
	Indicates items that must be performed to.

1. Handling Precautions



 DANGER	
	<ul style="list-style-type: none"> - Do not touch components inside of the converter; otherwise, it will cause electric shock. - Do not damage the cable by applying excessive load, placing heavy objects on it, or clamping; otherwise, it will cause electric shock or fire.
	<ul style="list-style-type: none"> - Turn the power supply OFF before wiring, transporting, and inspecting the converter; otherwise, it may cause electric shock. - Provide an external safety circuit so that the entire system functions safely even when the converter is faulty. - Connect the grounding terminal of the converter; otherwise, it may cause electric shock or malfunction.

 CAUTION	
	<ul style="list-style-type: none"> - Do not use the converter in the following places; water splashes, the atmosphere of the corrosion, the atmosphere of the flammable vapor, and the side of the combustibility. Doing so may result in fire or the converter may become faulty.
	<ul style="list-style-type: none"> - Be sure to use the converter and the ABSOCODER sensor in the environment designated by the general specifications in the manual. Failure to do so may result in electric shock, fire, malfunction or unit failure. - Be sure to use the specified combination of the ABSOCODER sensor, the converter and sensor cable; otherwise, it may cause fire or the converter malfunction.



2. Storage

 CAUTION	
	<ul style="list-style-type: none"> - Do not store the converter in a place exposed to water, or toxic gas and liquid.
	<ul style="list-style-type: none"> - Be sure to store the converter in designed temperature and humidity range, and do not expose to direct sunlight. - Be sure to consult with NSD when the converter is stored for long periods.



3. Transport



 CAUTION	
	<ul style="list-style-type: none"> - Do not hold the cable or shaft of ABSOCODER sensor during transport; otherwise, it will cause injury or malfunction.

4. Installation



 CAUTION	
	<ul style="list-style-type: none"> - Do not step on ABSOCODER sensor or place heavy objects on the converter; otherwise, it will cause injury or malfunction. - Do not block the exhaust port or allow any foreign matter to enter the converter; otherwise, it will cause fire or the converter failure.
	<ul style="list-style-type: none"> - Be sure to secure the converter and ABSOCODER sensor with the provided brackets; otherwise, it may cause malfunction, injury, or drop. - Be sure to secure the specified distance between the converter and the control panel or other equipment; otherwise, it may cause malfunction.

5. Wiring



 DANGER	
	<ul style="list-style-type: none"> - Be sure to secure the terminal block firmly; otherwise, it will cause fire. - Be sure to mount the terminal cover provided with the converter, before supplying the power, starting operation after the installation, and wiring; otherwise, it may cause electric shock.

 CAUTION	
	<ul style="list-style-type: none"> - Be sure to keep the sensor cable, control cable, and communication cable at least 300 mm away from the main circuit and power line; otherwise it may cause injury or malfunction. - Be sure to connect all cables correctly; otherwise, it may cause injury or malfunction. - Be sure to firmly connect the external I/O connectors and sensor connectors; otherwise, it may cause incorrect inputs and outputs or injury.



6. Operation

 CAUTION	
	<ul style="list-style-type: none"> - Do not change the converter's function switch settings during the operation; otherwise, it will cause injury. - Do not approach the machine after instantaneous power failure has been recovered. Doing so may result in injury if the machine starts abruptly.
	<ul style="list-style-type: none"> - Be sure to check that the power supply specifications are correct; otherwise, it may cause the converter failure. - Be sure to provide an external emergency stop circuit so that operation can be stopped with power supply terminated immediately. - Be sure to conduct independent trial runs for the converter before mounting ABSOCODER sensor to the machine; otherwise, it may cause injury. - When an error occurs, be sure to eliminate the cause, ensure safety, and reset the error before restarting operation; otherwise, it may cause injury.

7. Maintenance and Inspection

 CAUTION	
	<ul style="list-style-type: none"> - Do not disassemble, remodel, or repair the unit; otherwise, it will cause electric shock, fire, and unit malfunction.
	<ul style="list-style-type: none"> - The capacitor of the power line deteriorates through prolonged use. We recommended that the capacitor be replaced every five years to prevent secondary damage.

8. Disposal

 CAUTION	
	<ul style="list-style-type: none"> - Be sure to handle the converter and ABSOCODER sensor as industrial waste while disposing of it.

REVISION HISTORY

The Document No. appears at the upper right of this manual's cover page.

Document No.	Date	Revision Description
ZEF005850100	8, Dec., 2016	1st Edition Japanese document: ZEF005850000
ZEF005850101	15, May, 2017	2nd Edition Japanese document: ZEF005850001
ZEF005850102	14, Dec., 2018	3rd Edition Japanese document: ZEF005850002
ZEF005850103	7, Nov., 2019	4th Edition Japanese document: ZEF005850003
ZEF005850104	20, Dec., 2021	5th Edition Japanese document: ZEF005850004
ZEF005850105	6, July, 2022	6th Edition Japanese document: ZEF005850005
ZEF005850106	29, Aug, 2023	7th Edition Japanese document: ZEF005850006

- MEMO -

1. OVERVIEW

NCW-3DNIPMP (hereinafter referred to as NCW-3DNIP) is an ABSOCODER converter, a slave unit for EtherNet/IP, can communicate with EtherNet/IP. With the use of NCW-3DNIP in combination with the multi-turn type of ABSOCODER sensor, the machine position can be detected. The detected position data can be transmitted to the programmable logic controller (PLC) and industrial computer through the EtherNet /IP communication. Or, the PLC and industrial computer can readout the converter status information and set parameters.

This manual assumes that NCW-3DNIP and a programmable controller which is manufactured by Rockwell Automation, Inc. are connected by the network. Therefore, we explain the manual by using the following software.

- ①BOOTP/DHCP Server
- ②RSLinx Classic
- ③RSLogix5000
- ④RSNetWorx

For details of software instruction, refer to each product manual.

If the configuration tool is needed the definition file (EDS file), download it from NSD website.

1-1. Features

(1) High reliability

An absolute position detection format ensures accurate position detection even if a power interruption or unexpected noise condition occurs. An origin returning operation is not required.

(2) Superior durability

ABSOCODER sensor is not used electronic parts except coils and resistance, and it features a no-contact construction excepting bearing. This sensor offers problem-free operation, even in environment where it is exposed to vibration, impact shocks, extreme temperatures, oil, and dust.

(3) Compact design

The unit's outside dimensions (39(W) x 155(H) x 93(D)) were miniaturized. DIN rail can be used, so mounting is much easier.

(4) EtherNet/IP communication

A position, preset, alarm, and parameter data can be transmitted through the EtherNet/IP network.

- The converter supports full duplex (100BASE-TX), so data can be transmitted faster.
- The minimum cycle for communication is 2ms.

(5) Two axes ABSOCODER sensor can connect

The machine positions for two axes can be detected by one converter. The space-saving in the control panel can be conducted.

(6) Diagnosis function

The error information can be expressed both by EtherNet/IP alarm data and by monitor LEDs on the converter's front panel.

(7) Preset function

The position data can be preset to the desired value from the EtherNet/IP master.

(8) Configuration tool (software for configuring the system)

Settings are available by using EtherNet/IP software.

(9) Supporting the device level ring function (DLR)

NCW-3DNIP can connect to the network by ring topology (redundancy) of EtherNet/IP network.

Products with the software version mark put on the products panel after "B" (Ver.2.01) support this function. Refer to "8-1." for the version mark.

(10) Compliance with CE standards

The converter complies with CE (EMC Directive) standards.

2. MODEL SELECTION WHEN ORDERING

The following figure indicates the connection configuration of NCW-3DNIP.

Before ordering, refer to the connection configuration and model list. Please prepare by customer except (1) to (6) in the connection configuration.

● Connection configuration

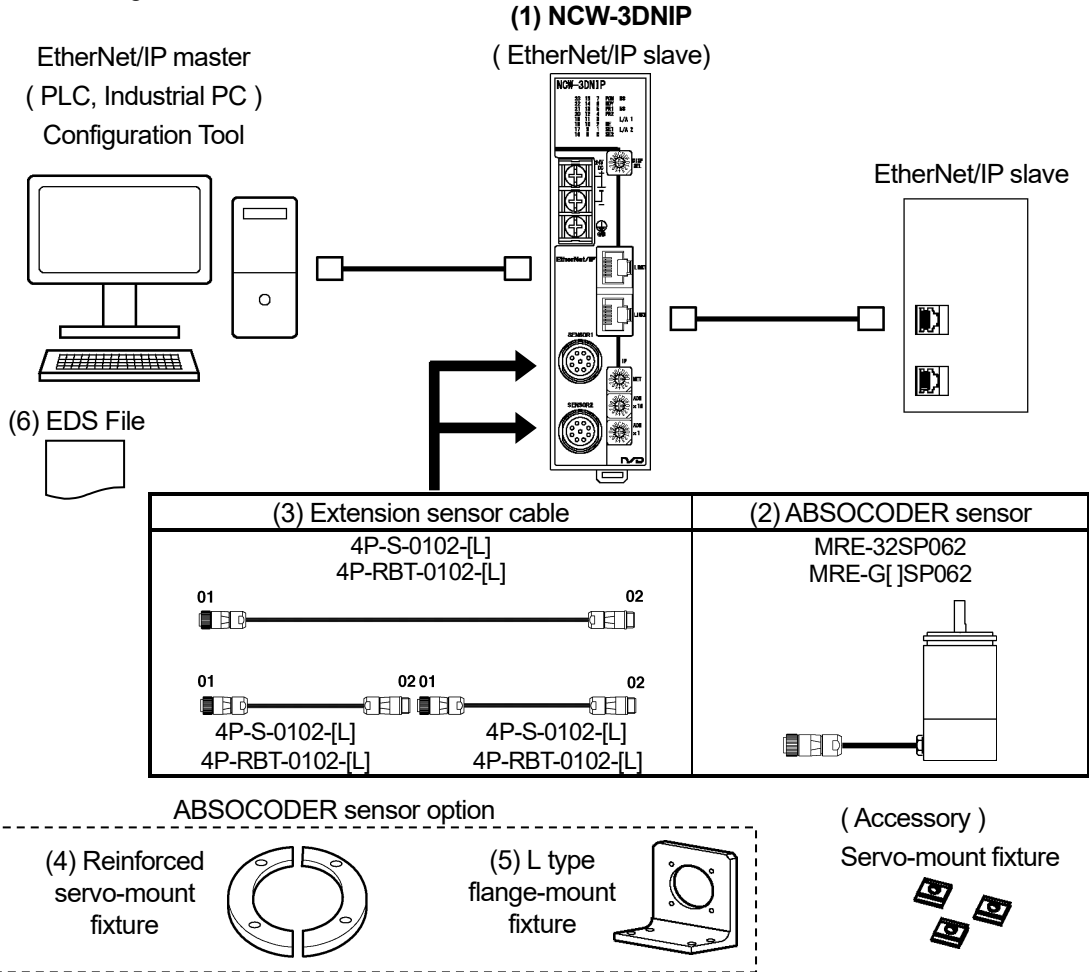

● Model List

No.	Items	Models	Descriptions
(1)	Converter	NCW-3DNIPMP	Position data binary code (17-bit)
(2)	ABSOCODER sensor	MRE-32SP062SAC	Total number of turns: 32, Diameter: ϕ 62, Servo-mount type, Flat shaft shape
		MRE-32SP062SBC	Total number of turns: 32, Diameter: ϕ 62, Servo-mount type, Key way shaft shape
		MRE-32SP062FAC	Total number of turns: 32, Diameter: ϕ 62, Flange-mount type, Flat shaft shape
		MRE-32SP062FBC	Total number of turns: 32, Diameter: ϕ 62, Flange-mount type, Key way shaft shape
		MRE-G[]SP062FAC	[] : Total number of turns: 64, 128, 160, 256, 320 Diameter: ϕ 62, Flange-mount type, Flat shaft shape
		MRE-G[]SP062FBC	[] : Total number of turns: 64, 128, 160, 256, 320 Diameter: ϕ 62, Flange-mount type, Key way shaft shape
(3)	Extension sensor cable	4P-S-0102-[L]	Standard cable [L] : Cable length(m) 2, 3, 5, 8, 10, 15, 20, 25, 30, 35, 40, 45, 50 (If a cable length is 50m or more, it can be selected by each 10m.)
		4P-RBT-0102-[L]	Robotic cable [L] : Cable length(m) 2, 3, 5, 8, 10, 15, 20, 25, 30, 35, 40, 45, 50 (If a cable length is 50m or more, it can be selected by each 10m.)
(4)	Reinforced servo-mount fixture	SH-01	Option for MRE-32SP062SAC, MRE-32SP062SBC
(5)	L type flange	RB-01	Option for flange-mount and reinforced servo-mount fixture
(6)	EDS File	File name: EDS_Rev000000**_NSD_ NCW-3D_IP_*****.eds	Download it from NSD website.

3. SPECIFICATIONS

3-1. Converter Specifications

(1) General specification

Items	Specifications
Power supply voltage	24VDC±10% (including ripple)
Power consumption	10W or less
Insulation resistance	20 M-Ohms or more between external DC power terminals and ground (by 500 VDC insulation resistance tester)
Withstand voltage	500 VAC, 60Hz for 1 minute between external DC power terminals and ground
Vibration resistance	20m/s ² 10 to 500Hz, 10cycles of 5 minutes in 3 directions, conforms to JIS C 0040 standard
Ambient operating temperature	0 to +55°C (No freezing)
Ambient operating humidity	20 to 90 %RH (No condensation)
Ambient operating environment	Free from corrosive gases and excessive dust
Ambient storage temperature	-25 to +70°C
Grounding	Must be securely grounded (ground resistance of 100 ohm or less)
Construction	Book-shelf type within enclosure, DIN rail mountable
Outside dimension (mm)	39(W) x 155(H) x 93(D) Refer to dimensions for details.
Mass	Approx. 0.4kg

(2) Performance specification

Items	Specifications	Notes
Converter model	NCW-3DNIPMP	
Applicable sensor	MRE-32SP062 MRE-G[]SP062 ([]: 64/128/160/256/320)	
Total number of divisions	131072 (2 ¹⁷)	
Number of effective bits	17 (D0 to D16)	
Position detection format	Absolute format	
Output code	Binary code	
Number of detection axes	2	
Position data update interval	Minimum 2 ms By RPI (EtherNet/IP communication cycle) setting	
Error detection	Sensor error, Memory error, Watchdog timer error, Internal I/F error	
Auxiliary functions	Preset function	
Monitor LED	MS: Module status	EtherNet/IP Communication monitor
	NS: Network status	
	L/A1/L/A2: Communication status	
	PON: Power ON	
	RDY: Converter normal (ready for operation)	
	PR1/PR2: Preset operation (Current position setting)	
	ME: Memory error	
	SE1/SE2: Sensor error	
	Position data: D0 to D23	LED display changes by selecting the DISP. SEL switch.
	Preset data: D0 to D23	
	Sensor code	
	Converter's diagnosis data	
	Parameter	
Communication diagnostic data		
LED display selecting: DISP SEL	Rotary switch	
Front panel operation	IP address setting (IP / NET): x1 IP address setting (IP / ADR): x16, x1	Rotary switch
Rear face operation	LINK1/LINK2 communication setting (Communication speed, Communication format)	DIP switch
Applicable standard	CE Marking (EMC directive)	

(3) Communication specification

	Items	Specifications
Communication	Physical layer	Ethernet 10Base-T, 100Base-TX, ISO/IEC 8802-3
	Number of communication ports	2 (connector: RJ45)
	Communication speed (Selectable)	100Mbit/s, 10Mbit/s, Auto-Negotiation
	Communication format (Selectable)	Full Duplex, Half Duplex, Auto-Negotiation
	Communication cycle time (RPI)	Minimum 2 ms
	Protocol	CIP Conformance Test CT-15
	Basic protocol	<ul style="list-style-type: none"> - Internet Protocol(IP version 4) (RFC 791) - User Datagram Protocol(UDP) (RFC 768) - Transfer Control Protocol(TCP) (RFC 793) - Address Resolution Protocol(ARP) (RFC 826) - Internet Control Message Protocol (ICMP) (RFC 792) - Bootstrap Protocol(BOOTP)(RFC951) - Dynamic Host Configuration Protocol(DHCP)(RFC2131)
	Network topology	<ul style="list-style-type: none"> - Star topology - Linear bus topology - Ring topology (DLR function)
	DLR function	Products with the software version mark put on the products panel after "[B]" (Ver.2.01) support these functions. Refer to "8-1." for the version mark.
	Web server function	
Recommended cable	CAT-5e STP straight cable	
Cable length	Between nodes: Max. 100m	
Function	IP address setting	<ul style="list-style-type: none"> - Sets manually by using switches on the NCW-3DNIP panel side. - Sets automatically from the BOOTP or DHCP server.
	Communication setting (Speed and format)	<ul style="list-style-type: none"> - Sets manually by using DIP switches on the NCW-3DNIP rear side. - Sets automatically by the Auto-Negotiation.
	Parameter settings	Axis Unavailable Error Clear Position Data Increase Direction Preset Value
	Control (OUTPUT)	Preset (PRESET) Error Clear (ERRCLR)
	Diagnosis status reference (INPUT)	Device Not Ready (NRDY) Device watchdog timer error (WDTE) Device memory error (ME) Internal I/F error (I/F ERR) Axis-n Sensor Error (SE) Axis-n Disconnected Sensor Error (SSE) Axis-n Sensor Circuit Power Error (SPF) Axis-n Sensor Data Error (DE) Axis-n Position Data
	Operation and abnormality occurrence history	Newest 32 error contents or operation histories
	Maintenance information	Cumulative energization time Writing in and reference of maintenance information
	Communication indicator	"MS" (Green / Red) : Module status "NS" (Green / Red) : Network status "L/A1" (Green) : Link status "L/A2" (Green) : Link status

3-2. ABSOCODER Sensor Specification

MRE-32SP062, MRE-G[]SP062

Items		Specifications					
Sensor model		MRE-32SP062	MRE-G[]SP062				
			[64]	[128]	[160]	[256]	[320]
Total number of turns		32	64	128	160	256	320
Divisions/Turn		4096	2048	1024	819.2	512	409.6
Total number of divisions		131072 (2 ¹⁷)					
Mass		1.5 kg	1.0 kg				
Linearity error		1° Max	2 Max.	4 Max.	5 Max.	8 Max.	10 Max.
Moment of inertia GD ² /4(J)		6.7 x 10 ⁻⁶ kg·m ² (6.8 x 10 ⁻⁵ kgf·cm·s ²)	3.9 x 10 ⁻⁶ kg·m ² (4.0 x 10 ⁻⁵ kgf·cm·s ²)				
Starting torque		4.9 x 10 ⁻² N·m or less (0.5 kgf·cm or less)					
Permissible shaft load	Radial	98 N (10 kgf)					
	Thrust	49 N (5 kgf)					
Permissible mechanical speed		3600 r/min					
Bearing life		3.0 x 10 ⁴ h (at 3600 r/min)	1.5 x 10 ⁴ h (at 3600 r/min)				
Ambient temperature	Operating	-20 to +60°C					
	Storage	-30 to +90°C					
Vibration resistance		2.0 x 10 ² m/s ² (20G) 200Hz, up/down 4 h, forward/back 2 h, conforms to JIS D 1601 standard					
Shock resistance		4.9 x 10 ³ m/s ² (500G) 0.5 ms, up/down/forward/back x 3 times each, conforms to JIS C 5026 standard					
Protection rating		IP52f, conforms to JEM 1030 standard					
Max. sensor cable length	Standard cable	100m					
	Robotic cable	40m	70m				
Interconnecting sensor cable length		2m					

3-3. Extension Sensor Cable Specification

4P-S, 4P-RBT

Items		Specifications	
Model code		4P-S	4P-RBT
Cable type		Standard cable	Robotic cable
Diameter		φ8	
Ambient temperature	Operating	-5 to +60°C	-5 to +60°C
	Storage	-5 to +60°C	-10 to +60°C
Insulator		Irradiated cross linked foamed polyethylene	ETFE plastic
Sheath		Polyvinyl chloride mixture	
Construction		8-core, 2 pairs without shield + 2 pairs with shield	
Color of sheath		Gray	Black
Advantage		Extensible for long distances	Superior flexibility; ideal for moving place

[Remark]

Contact your NSD representative when the extension cable combines the standard cable (4P-S) and the robotic cable (4P-RBT).

4. DIMENSIONS

4-1. Converter Dimension

Units: mm

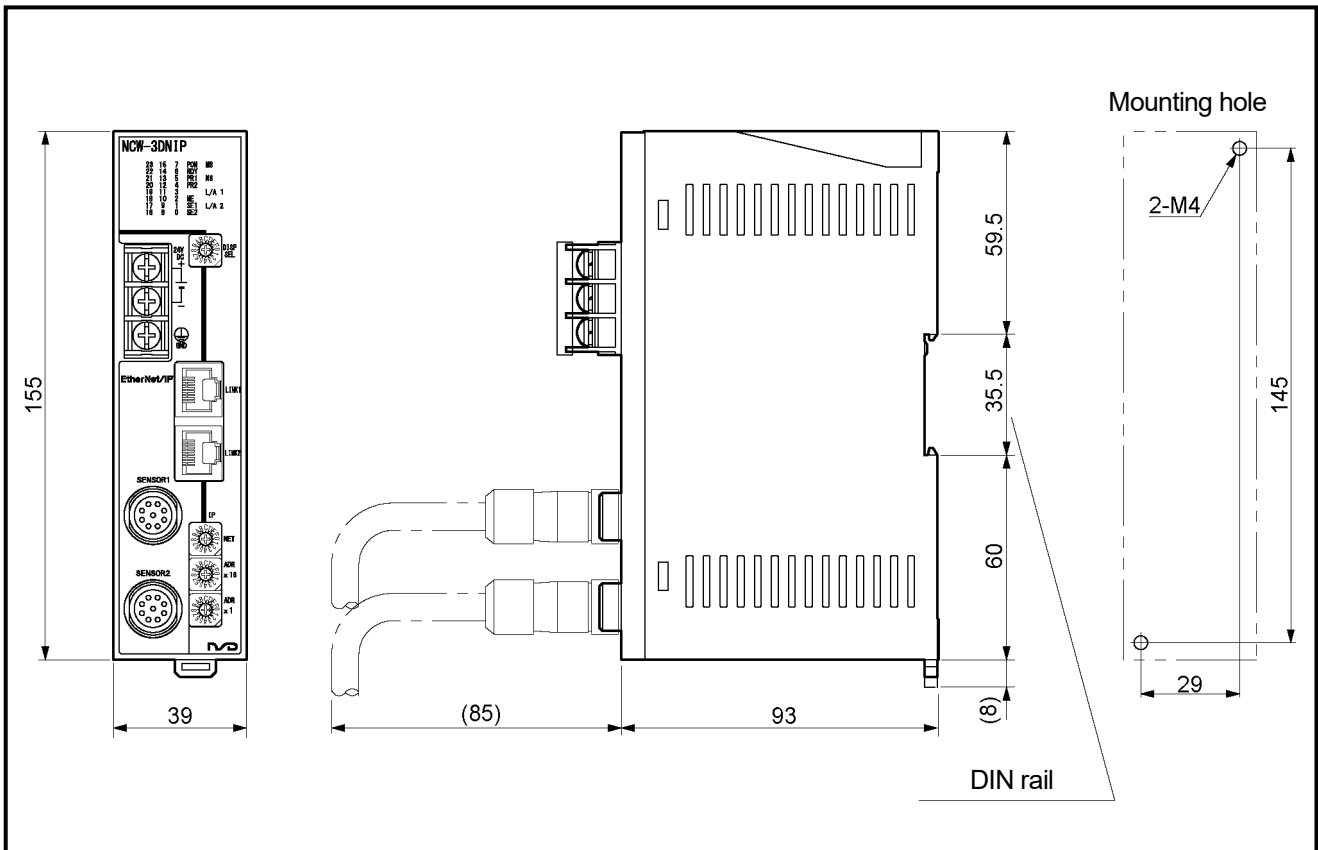

4-2. ABSOCODER Sensor Dimensions

Units: mm

■ MRE-32SP062SAC

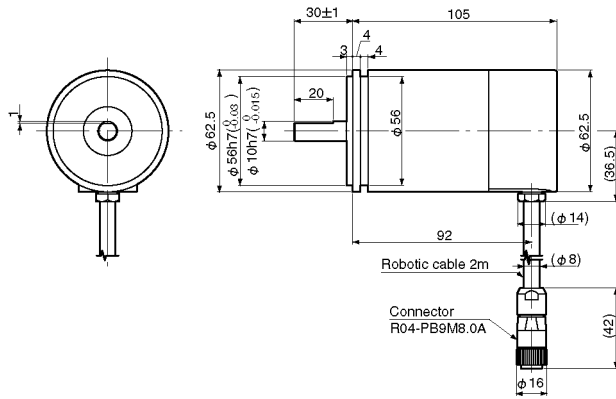

■ MRE-32SP062SBC

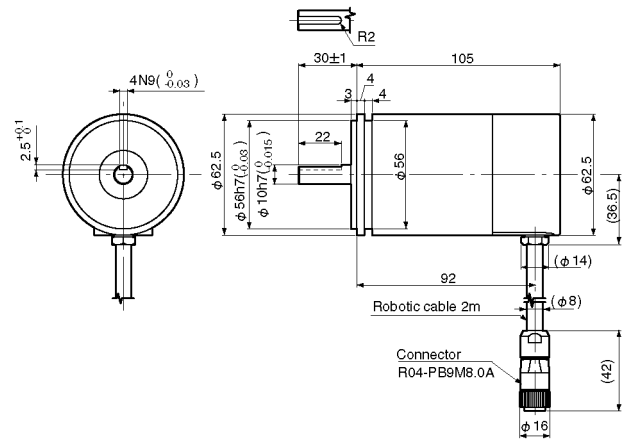

- Accessory Model: SB-01
Servo-mount fixtures for MRE-32SP062S[]C (3 pieces set)

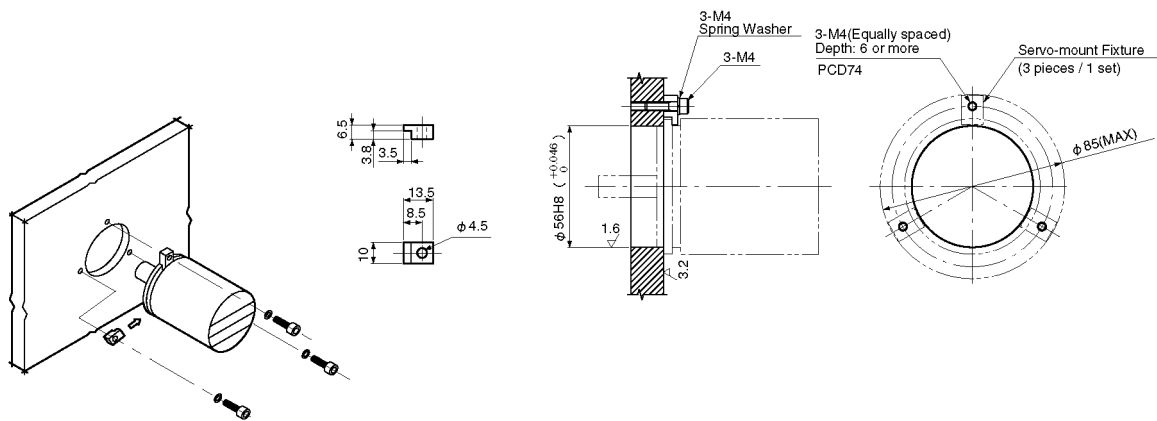

- Model: SH-01 (Option)
Reinforced servo-mount fixtures for MRE-32SP062S[]C (2 pieces set)

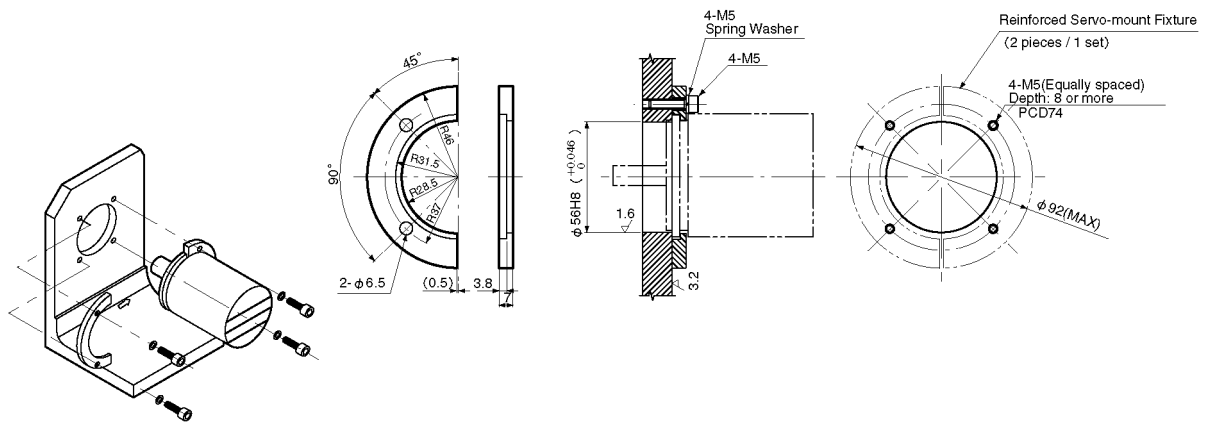

Units: mm

■ MRE-32SP062FAC

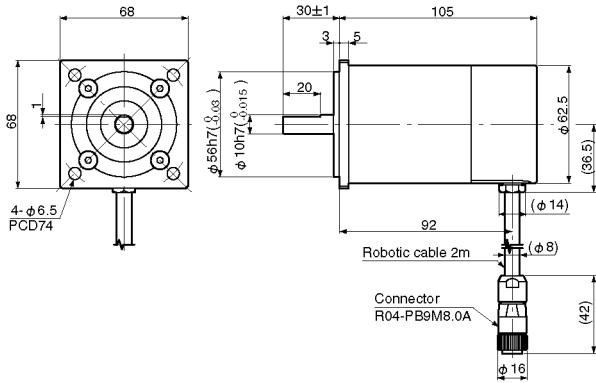

■ MRE-32SP062FBC

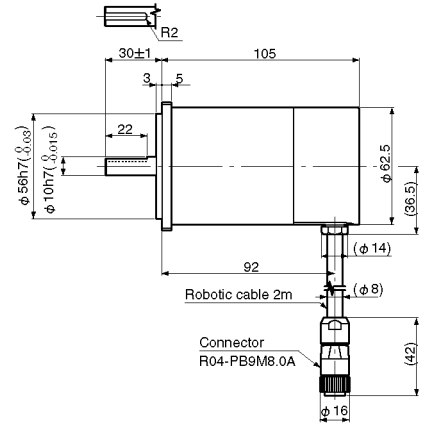

■ MRE-G[]SP062FAC ([]:64, 128, 160, 256, 320)

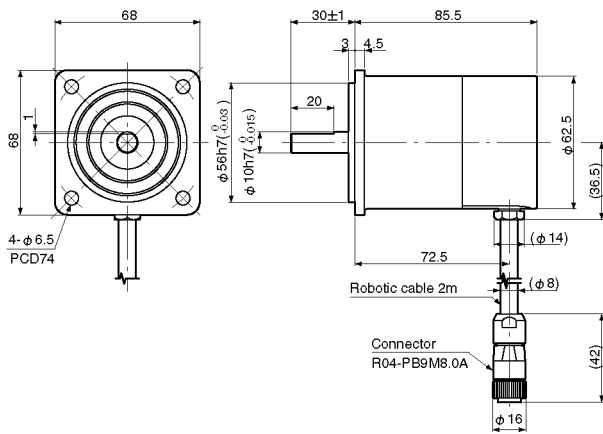

■ MRE-G[]SP062FBC ([]:64, 128, 160, 256, 320)

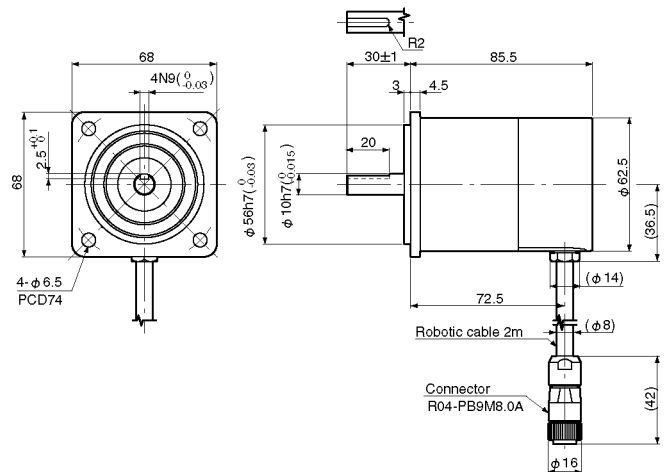

● Mounting hole dimensions for flange

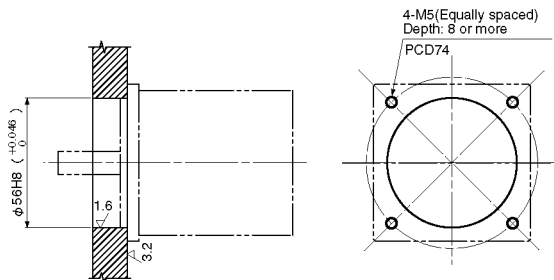

● Model: RB-01 (Option)

L-type flange for MRE-32SP062·MRE-G[]SP062

Applicable sensors are following.
MRE-32SP062S[]C + SH-01
MRE-32SP062F[]C
MRE-G[]SP062F[]C

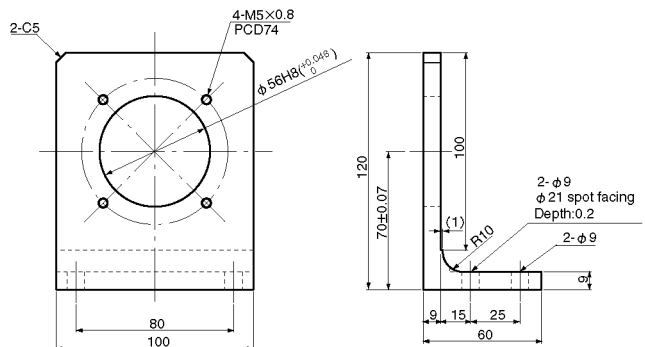

4-3. Extension Sensor Cable Dimension

● 4P-S-0102-[L], 4P-RBT-0102-[L]

Units: mm

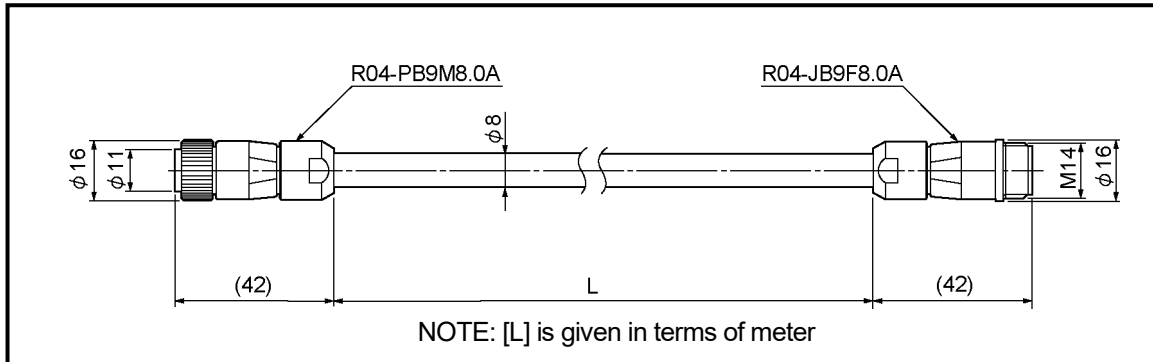

5. CHECKING THE CONTENTS OF THE SHIPPING CASE

Open the packing case, and verify that all items are present.

When extension sensor cables are ordered, they are packed separately.

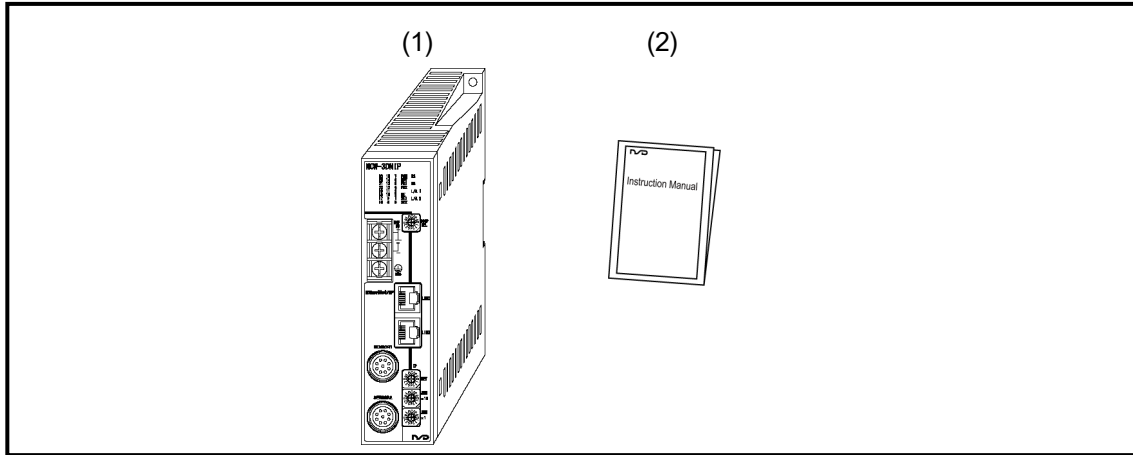

(1) Converter 1 unit

(2) Manual 1 piece

6. INSTALLATION

6-1. Converter Installation Conditions and Precautions

When installing the converter, the following conditions and precautions should be observed.

-Installation Site

- (1) Avoid sites where the unit is exposed to direct sunlight.
- (2) The ambient temperature should never exceed a 0 to 55°C range.
- (3) The ambient humidity should never exceed a 20 to 90% RH range.
- (4) Do not install the unit in areas where condensation is likely to occur (high humidity with extreme temperature changes).
- (5) Avoid sites where dust is excessive.
- (6) Do not install in areas with an excessive amount of salt and/or metal chips.
- (7) Do not install in areas where flammable and / or corrosive gases are present.
- (8) Avoid areas where splashing water, oil or chemicals are likely to occur.
- (9) Avoid areas where vibration and shocks are excessive.

-Installation cautions

- (1) Install inside the control cabinet.
- (2) Install in a vertical direction so that the characters are visible.
- (3) If a DIN rail mounting format is used, insert until the latch mechanism catches with an audible click.
Secure between end plates at both sides.
- (4) In high vibration areas, secure tightly with 2 M4 screws.
- (5) Install as far from high voltage lines and power lines as possible in order to minimize noise influences.
- (6) Allow 85mm or more space at the converter's front side for plugging in and unplugging the connector.
- (7) Peripheral components should be arranged so as not to obstruct converter installation, removal, and connector plugging/unplugging.
- (8) Space out 10mm or more between the converter and peripheral components in order not to obstruct the converter's heat dissipation.

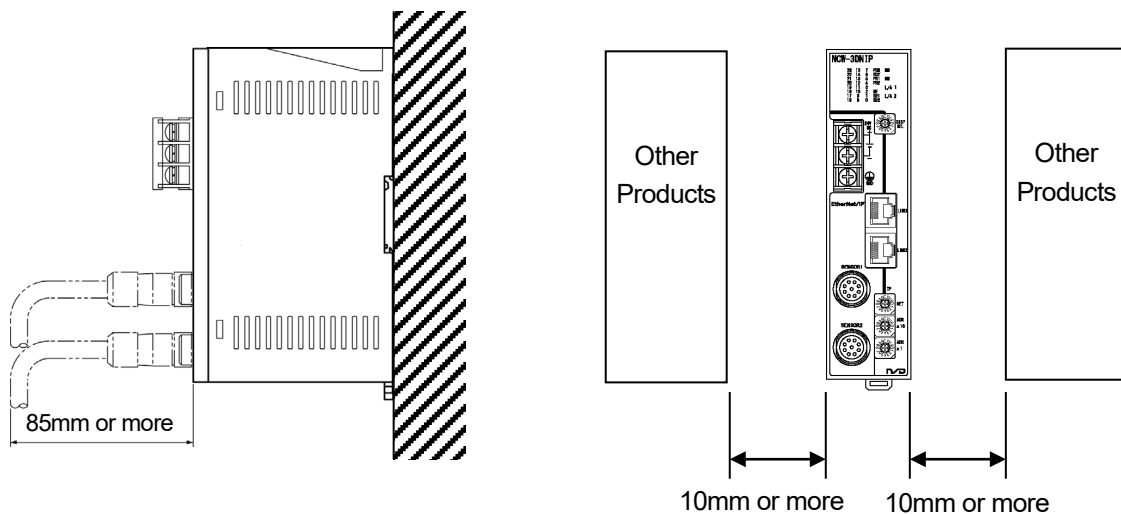

6-2. ABSOCODER Sensor Installation Conditions and Precautions

The ABSOCODER sensor installation procedures and precautions are described in this section.

● Handling of Turn-type ABSOCODER Sensor

Item	Explanation
(1) Main unit	<p>Never drop the Sensor, or subject it to excessive forces or shocks.</p>
(2) Cable	<p>Avoid stepping on, or applying excessive stress to the cable.</p>

● Mounting of Turn-type ABSOCODER Sensor

Item	Explanation	Precaution
(1) Mounting	For details regarding mounting dimensions, refer to each ABSOCODER sensor dimensions.	
(2) Cable port	<p>Cable port should face downward.</p>	
(3) Cable	<p>The bend radius for movable parts should never be less than 75 mm ($\phi 150$) (robotic cable).</p>	Do not use the standard cable for movable parts. (Use robotic cable.)
(4) Wiring	<p>The sensor cable should be located at least 300mm away from power lines and other lines which generate a high level of electrical noise.</p>	

● **Mounting of Turn-type ABSOCODER Sensor**

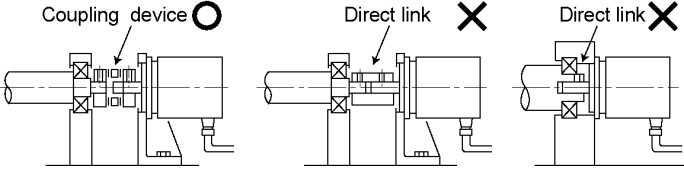
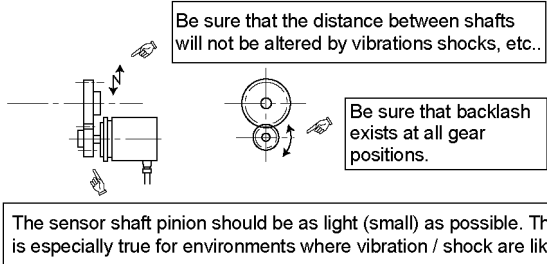
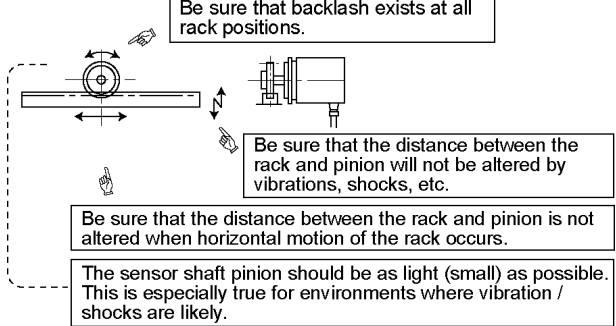
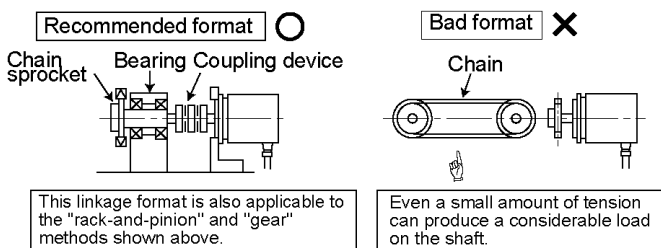
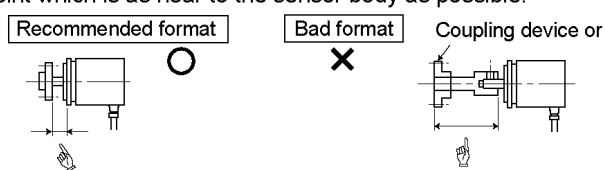
Item	Explanation	Precaution
(1) Coupling of machine shaft and sensor shaft	<p>Be sure to use a coupling device to link the 2 shafts.</p>  <p>Coupling device ○ Direct link ✕ Direct link ✕</p>	<p>A “direct-link” format will result in shaft fatigue and / or breakage after long periods.</p> <p>Therefore, be sure to use a coupling device to link the shafts.</p>
(2) For gear-type linkage	<p>If a gear linkage is used, be sure that some backlash exists.</p>  <p>Be sure that the distance between shafts will not be altered by vibrations shocks, etc..</p> <p>Be sure that backlash exists at all gear positions.</p> <p>The sensor shaft pinion should be as light (small) as possible. This is especially true for environments where vibration / shock are likely.</p>	<p>Incorrect gear mounting can result in shaft bending or breakage.</p>
(3) For rack and pinion type linkage	<p>Be sure that backlash exists at all rack positions.</p>  <p>Be sure that backlash exists at all rack positions.</p> <p>Be sure that the distance between the rack and pinion will not be altered by vibrations, shocks, etc.</p> <p>Be sure that the distance between the rack and pinion is not altered when horizontal motion of the rack occurs.</p> <p>The sensor shaft pinion should be as light (small) as possible. This is especially true for environments where vibration / shocks are likely.</p>	<p>Incorrect rack and pinion mounting can result in shaft bending or breakage.</p>
(4) Chain or timing belt linkage	<p>When a chain or timing belt linkage format is used, there is an inherent risk of the shaft's load being increased by the resulting tension. Therefore, a bearing should be used, with the shafts being linked by a coupling device immediately behind the bearing.</p>  <p>Recommended format ○ Bad format ✕</p> <p>Chain sprocket Bearing Coupling device Chain</p> <p>This linkage format is also applicable to the "rack-and-pinion" and "gear" methods shown above.</p> <p>Even a small amount of tension can produce a considerable load on the shaft.</p>	
(5) Shaft mounting position	<p>The shaft should be attached to the coupling device or gear at a point which is as near to the sensor body as possible.</p>  <p>Recommended format ○ Bad format ✕ Coupling device or</p> <p>This distance should be as short as possible. When this distance is short, the load placed on the bearing by vibrations / shocks is slight.</p> <p>Never use an extended shaft format.</p>	

● Coupling of Turn-type ABSOCODER Sensor

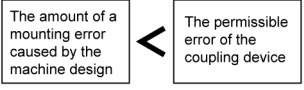
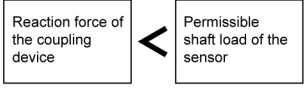
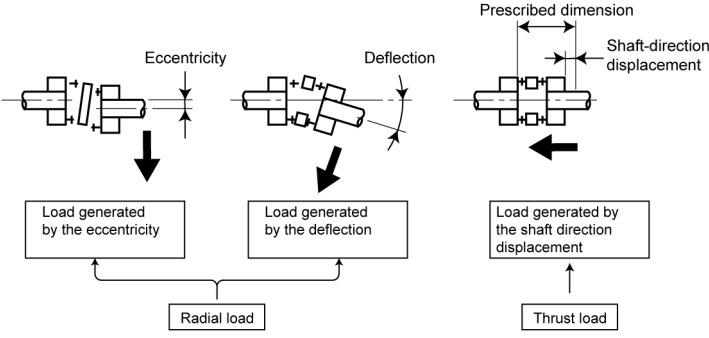
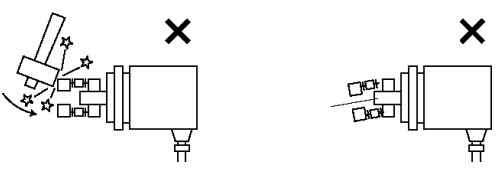
Item	Explanation	Precaution
<p>(1) Coupling device selection precaution</p>	<p>1. Selection of the coupling device should be based on the following factors;</p> <ul style="list-style-type: none"> - The amount of a mounting error caused by the machine design. - The permissible error of coupling device. - Reaction force of coupling device. - Permissible shaft load of the sensor. <div style="text-align: center; margin: 10px 0;">   </div> <p>Mounting error</p> <div style="text-align: center; margin: 10px 0;">  </div> <p>2. If the selected coupling device is larger than necessary (When used in high vibration/shock environments), the load which is applied to the shaft by the vibrations/shocks will be increased by the weight of the coupling device.</p> <p>3. Be sure to select a coupling device with an adequate transmission torque surplus relative to the sensor shaft's torque.</p>	<p>The selection of a larger coupling than necessary will increase the shaft load which is caused by the mounting error amount.</p> <p>Excessive force applied to the shaft can deform the coupling and reduce durability.</p>
<p>(2) Coupling device installation precaution</p>	<p>Avoid bending or damaging the coupling.</p> <div style="text-align: center; margin: 10px 0;">  </div>	

7. WIRING

7-1. Connection between Converter and ABSOCODER Sensor

The maximum extension sensor cable length varies according to the ABSOCODER sensor and cable model being used. For more details refer to "3-2. ABSOCODER Sensor Specifications".

-Wiring Precautions

- (1) The sensor cable should be clamped as shown in the right figure to prevent excessive tension from being applied to the cable connectors.
- (2) The sensor cable should be located at least 300mm away from power lines and other lines which generate a high level of electrical noise.
- (3) If the cable is moved under the state of bending like a horseshoe, a robotic cable should be used. The bend radius should never be less than 75 mm.

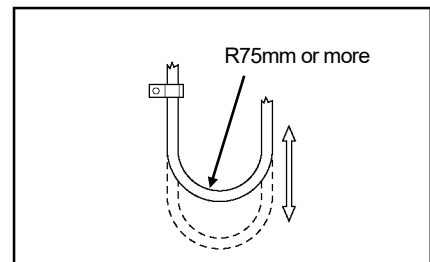
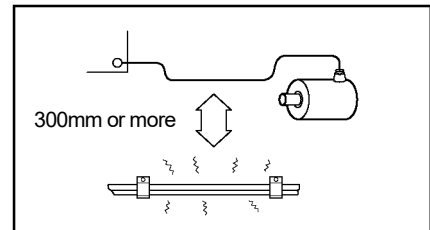
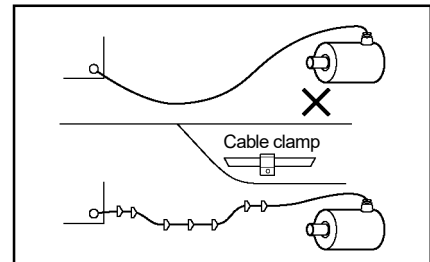

7-2. Power Supply Connection

The power supply should be connected as described below:

●Power Supply

- Choose the power supply capacity which is more than twice the power consumption of the converter.
The power consumption of the converter is 10W or less.

- The input power supply should be isolated from the commercial power supply.

- The power cable should be as thick as possible to minimize voltage drops.

- Twist the power cable for preventing noises.

- Use the M4 size crimp lug terminals with insulating sleeves in order to prevent short circuit caused by loose screws.

- The terminal block tightening torque is 1.8 N·m (16 lb·in).

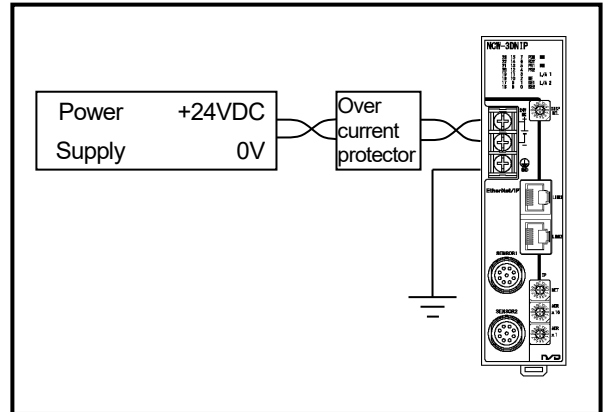

●Ground

- The unit should be securely grounded (ground resistance of 100ohm or less) to prevent electrical shocks.

- The ground wire should be connected to the ground terminal directly.

- The terminal block tightening torque is 1.8 N·m (16 lb·in).

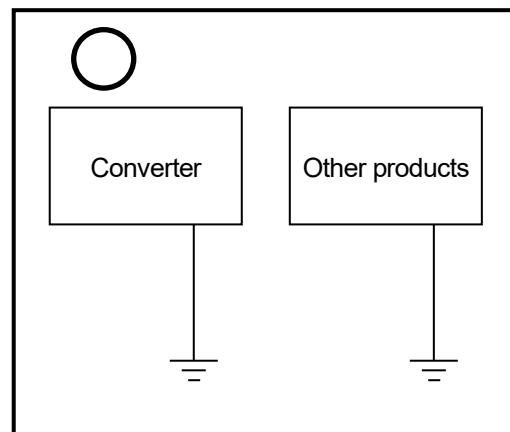
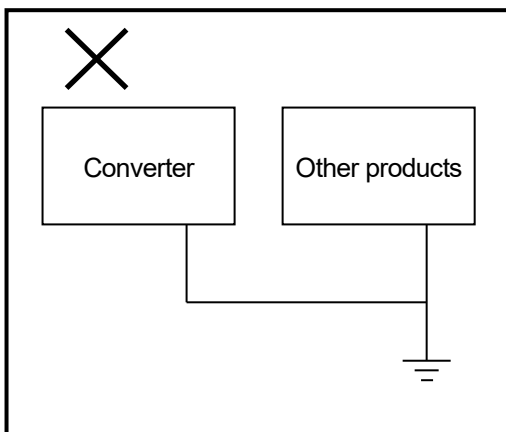

8. NOMENCLATURE

8-1. Part Identification

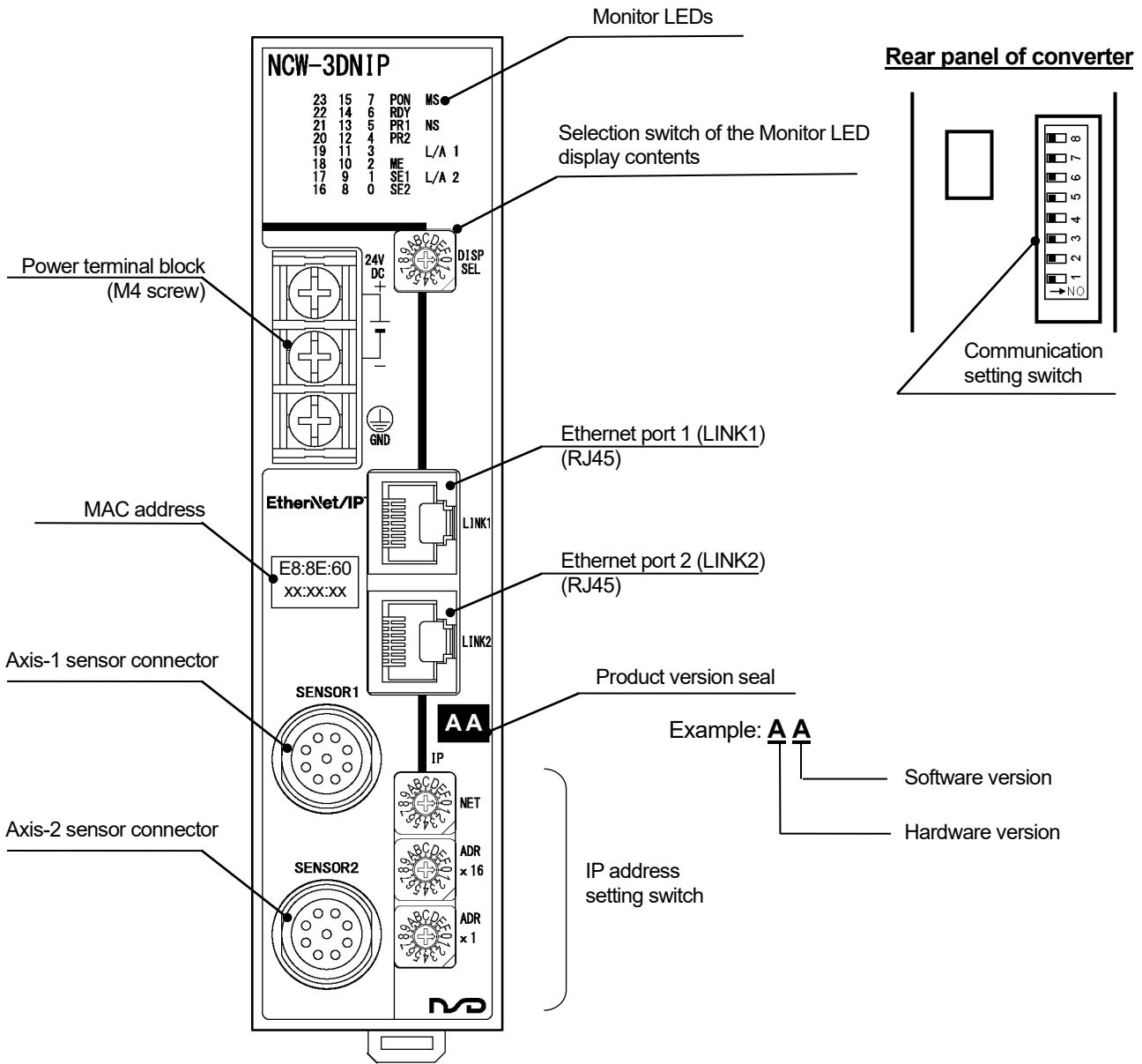

8-2. Function and Name of Indicator and Setting Area

Contents on the monitor LEDs are described in this section.

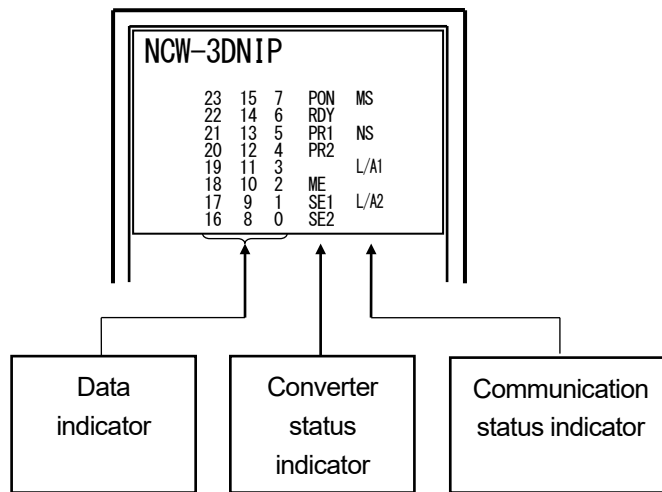

Indicator		LED color	Description
Communication status indicator *1	MS	Green / Red	Indicates the operation status of NCW-3DNIP.
	NS	Green / Red	Indicates the EtherNet/IP communication status of NCW-3DNIP.
	L/A1	Green	Indicates data sent and received status for the Ethernet port 1 (LINK 1).
	L/A2	Green	Indicates data sent and received status for the Ethernet port 2 (LINK 2).
Converter status indicator	PON	Green	ON when the power supply is functioning normally.
	RDY	Green	LED turns ON when Converter status is normal.
	PR1	Green	ON for approximately 1 second when the preset function (Current position setting) operation occurs with axis-1.
	PR2	Green	ON for approximately 1 second when the preset function (Current position setting) operation occurs with axis-2.
	ME	Red	ON when a memory error is occurred.
	SE1	Red	ON when the axis-1 sensor error is occurred.
	SE2	Red	ON when the axis-2 sensor error is occurred.
Data indicator *2	0 to 23	Green	Monitor LED displays the content which was selected by the selecting switch (DISP SEL).

*1: For the communication status indicator, refer to section 8-2-1.

*2: For the data indicator, refer to section 8-2-2.

8-2-1. Contents of the communication status indicator area

Explains the overview of the Ethernet/IP communication status indicator area.
For more details, refer to “11. TROUBLE SHOOTING”.

Indicator	Color	Light status	Description
MS	Green/Red	OFF	No power
		Steady Green	Normal operation
		Flashing Green	No IP address
		Flashing Red	A recoverable fault occurs
		Steady Red	An unrecoverable fault occurs
		Flashing Green / Red	Self test in progress
NS	Green/Red	OFF	Not powered, no IP address
		Flashing Green	No connection is established
		Steady Green	Connection is established
		Flashing Red	Connection timeout occurs
		Steady Red	IP address is duplicated
		Flashing Green / Red	Self test in progress
L/A1	Green	OFF	LINK1 port: No link
		ON	LINK1 port: Link
		Flashing	LINK1 port: Link (during the communication)
L/A2	Green	OFF	LINK2 port: No link
		ON	LINK2 port: Link
		Flashing	LINK2 port: Link (during the communication)

8-2-2. Contents of the data indicator area

The data indicator content is changed by the display selection switch (DISP SEL).

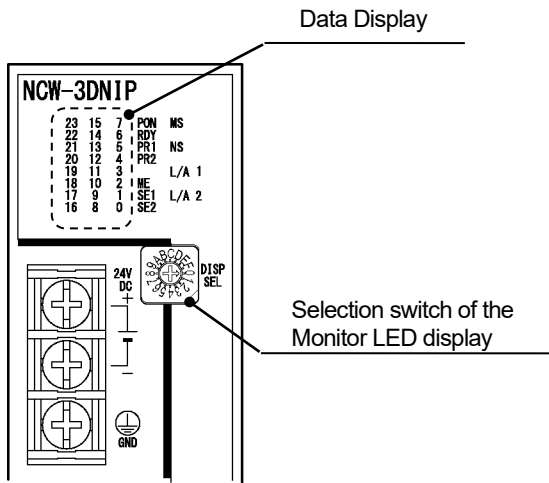

DISP SEL	Display content
0	Axis-1 position data D0-D23
1	Axis-2 position data D0-D23
2	Axis-1 preset data D0-D23 *1
3	Axis-2 preset data D0-D23 *1
4	Reserved
5	Reserved
6	Reserved
7	Converter diagnosis data *2
8	Parameter data *3
9	Ethernet network transmission setting *4
A	TCP/IP Interface object information 1 *5
B	TCP/IP Interface object information 2 *6
C	Reserved
D	Sensor circuit control information *7
E	Reserved
F	Reserved

*1: Displays the preset data which is transmitted from the master.

*2: Converter diagnosis data

	7	6	5	4	3	2	1	0
Axis-1 diagnosis data	DE1	SPF1	SSE1	0	0	0	0	SE1
	15	14	13	12	11	10	9	8
Axis-2 diagnosis data	DE2	SPF2	SSE2	0	0	0	0	SE2
	23	22	21	20	19	18	17	16
Converter diagnosis data	0	0	0	0	I/F ERR	ME	WDTE	NRDY

*3: Parameter data

	7	6	5	4	3	2	1	0
Axis-1 parameter data	Reserved					Position Data Increase Direction 1	Error Clear 1	Axis Unavailable 1
	15	14	13	12	11	10	9	8
Axis-2 parameter data	Reserved					Position Data Increase Direction 2	Error Clear 2	Axis Unavailable 2
	23	22	21	20	19	18	17	16
Unused	0							

*4: Ethernet network transmission setting

	7	6	5	4	3	2	1	0
LINK1	Reserved					Full Duplex	10 Mbps	100 Mbps
	15	14	13	12	11	10	9	8
LINK2	Reserved					Full Duplex	10 Mbps	100 Mbps
	23	22	21	20	19	18	17	16
IP address	IP Host address [IP.ADR] 8-bit							

- Lights status of the full duplex
Light turns ON: Full Duplex Light turns OFF: Half Duplex
- Either 10Mbps or 100Mbps light turns ON when it is normal. Lights turn OFF when an error occurs.

*5: TCP/IP Interface object information 1

Indicates the low-order 24-bit information of attribute 1 (Status) of instance 1 in TCP/IP interface object (0xF5). For more details, refer to "APPENDIX 2-8. TCP/IP Interface Object (Class ID: 0xF5)".

	7	6	5	4	3	2	1	0
Status (Bit0-7)	0	0	Interface Config Pending	Mcast Pending	Interface Configuration Status			
	15	14	13	12	11	10	9	8
Status (Bit8-15)	0	0	0	0	0	0	0	0
	23	22	21	20	19	18	17	16
Status (Bit16-23)	0	0	0	0	0	0	0	0

*6: TCP/IP Interface object information 2

Indicates the low-order 24-bit information of attribute 3 (Configuration Control) of instance 1 TCP/IP interface object (0xF5). For more details, refer to "APPENDIX 2-8. TCP/IP Interface Object (Class ID: 0xF5)".

	7	6	5	4	3	2	1	0
Config Control (Bit0-7)	0	0	0	DNS Enable	Startup Configuration			
	15	14	13	12	11	10	9	8
Config Control (Bit8-15)	0	0	0	0	0	0	0	0
	23	22	21	20	19	18	17	16
Config Control (Bit16-23)	0	0	0	0	0	0	0	0

*7: Sensor circuit control information

Indicates the low-order 8-bit information of Output data "Axis-1 control flag" and "Axis-2 control flag" in Exclusive-Owner Connection. For more details, refer to "9-9-1. Exclusive-Owner Connection".

	7	6	5	4	3	2	1	0
Axis-1 Control (Bit0-7)	PRESET	ERRCLR	0	0	0	0	0	0
	15	14	13	12	11	10	9	8
Axis-2 Control (Bit8-15)	PRESET	ERRCLR	0	0	0	0	0	0
	23	22	21	20	19	18	17	16
Reserved	0	0	0	0	0	0	0	0

8-2-3. Ethernet connector (LINK1/LINK2)

Ethernet communication cables are connected to these ports.

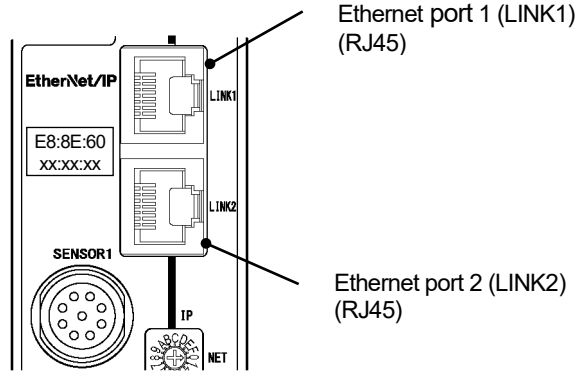

8-2-4. Ethernet IP address setting switch (IP)

The IP address is designated by "Subnet address [NET]" and "Host address [ADR]"

The Subnet address [NET] range is from 0 to F in the hex (0, ..., 15 in dec).

The Host address [ADR] range is from 0, ..., FF in the hex (0, ..., 255 in dec). The NCW-3DNIP obtains the IP address from the BOOTP/DHCP server when the switch is set to either "0" or "255".

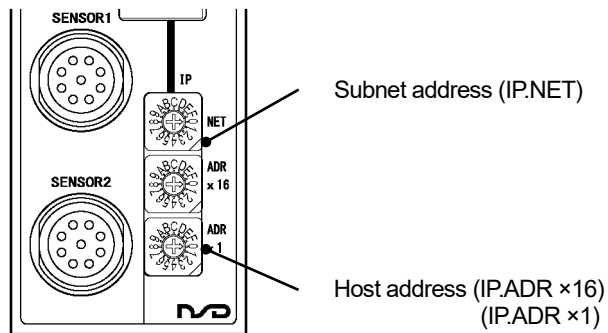

9. EtherNet/IP COMMUNICATION SETUP

9-1. Procedure Before the Operation

Indicates procedure before the operation

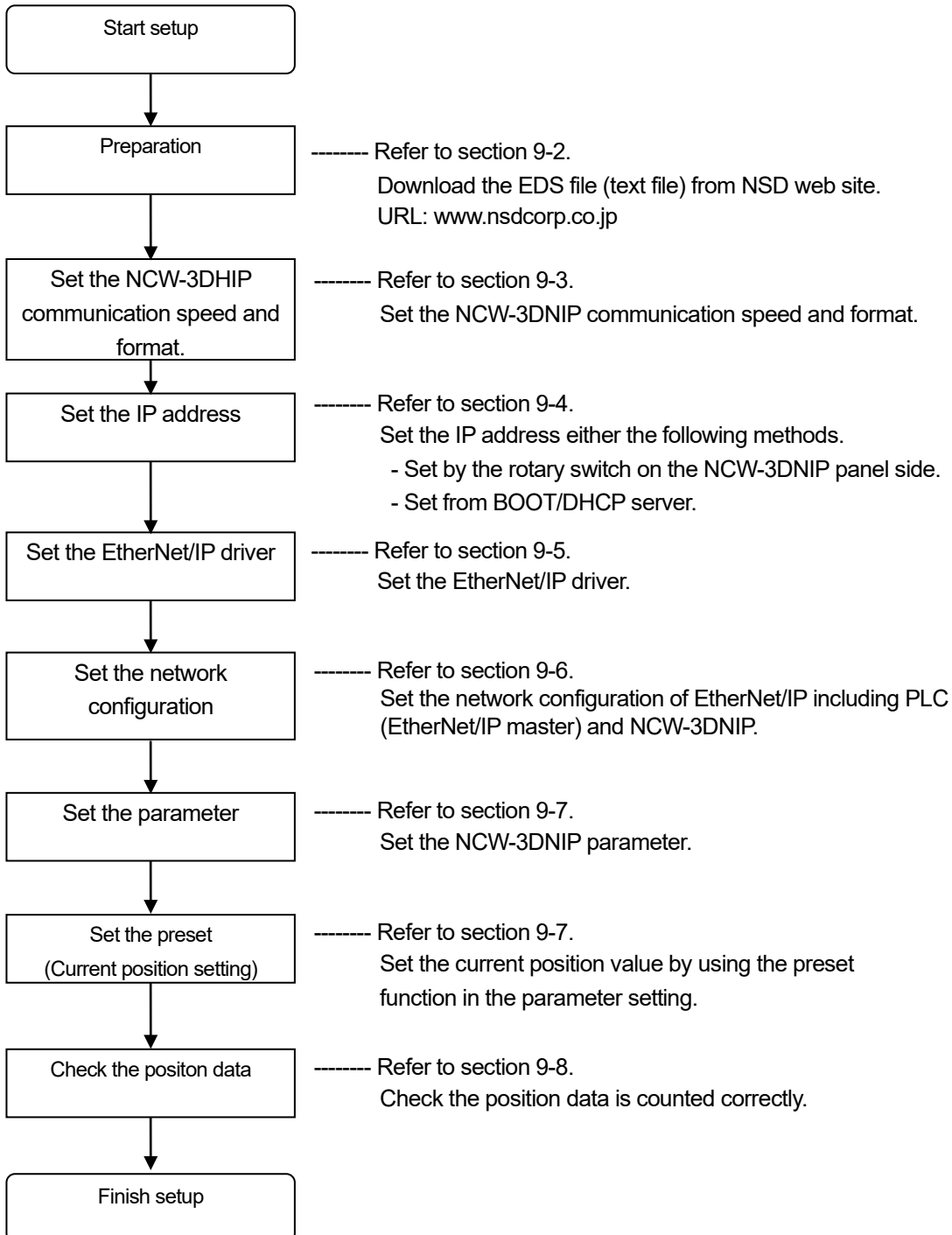

Note

When setting parameters, switch the operation mode of the host PLC to program mode (PROG). Cannot be set in run mode (RUN). This operation is performed by using the PLC's configuration tool (a PLC development tool software).
*: Depending on the PLC model, this operation can also be performed by the mode selection switch on the CPU card.

9-2. Preparation

Prepares that NCW-3DNIP connects the EtherNet/IP network

This manual assumes that NCW-3DNIP and a programmable controller which is manufactured by Rockwell Automation, Inc. are connected by the network. Therefore, this manual explains a connection method using following software.

- ①BOOTP/DHCP Server
- ②RSLinx Classic
- ③RSLogix5000
- ④RSNetWorx

For details of software instruction, refer to each product manual.

●EDS file

If the configuration tool is needed the definition file (EDS file), download it from NSD website.

URL: www.nsdcorp.com

File name: EDS_Rev000000**_NSD_NCW-3D_IP_*****.eds

●Hardware Setup

The following figure indicates the connection of NCW-3DNIP as an example.

The NCW-3DNIP is connected to the controller (1769-L30ERM CompactLogix5330ERM) through the EtherNet switch as shown below.

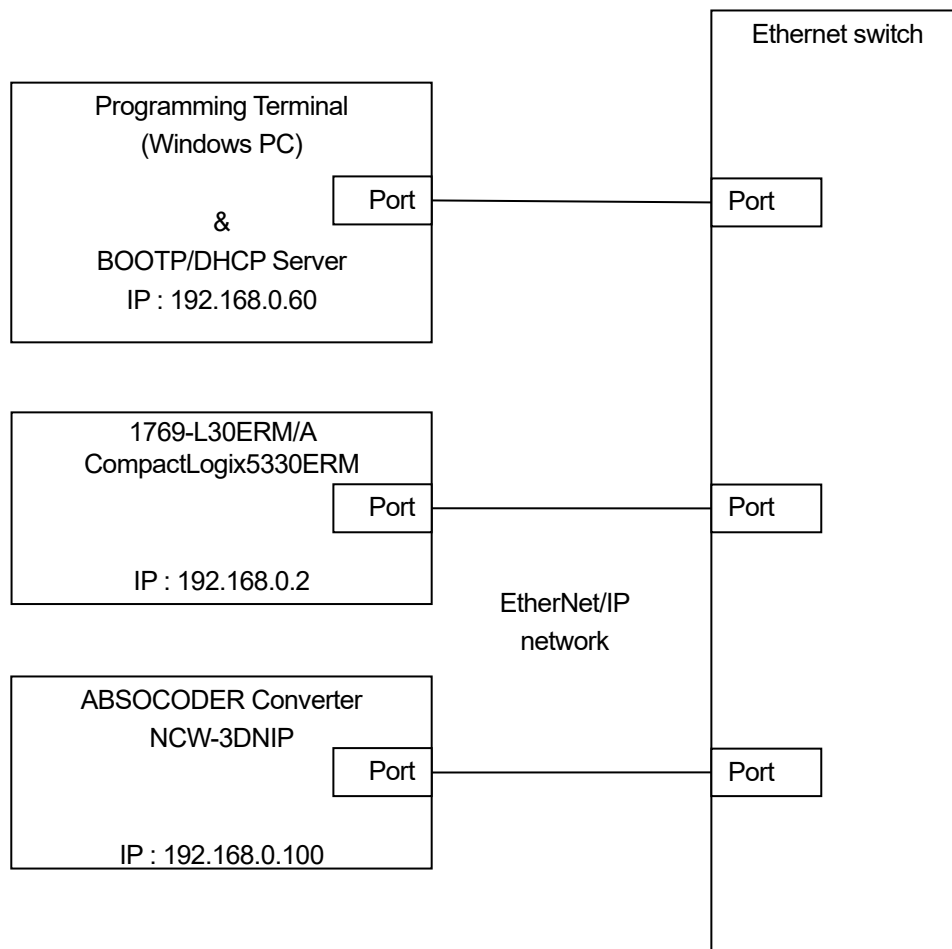

9-3. Communication Speed and Format Setting

Sets communication method for the Ethernet port (LINK1, LINK2) by the switch on the NCW-3DNIP's rear panel.

Rear panel of converter

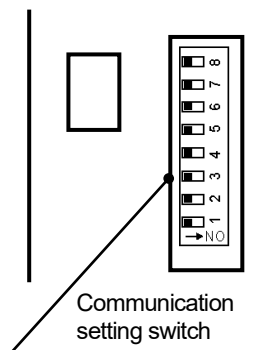

"AUTO (automatic detection)" is set before the shipment, so setting usually isn't required.

Set it manually (MANUAL) if the communication method of the PLC (EtherNet/IP master) cannot be changed.

*: The setting should be same as the communication method of the PLC (EtherNet/IP master).

The communication won't be available or will be unstable if the settings aren't matched between devices.

Switch No.	Item	Setting description	Factory setting
1	LINK1 communication method	OFF: AUTO (automatic detection) ON : MANUAL(Sets the switch No.2 and 3 manually.)	OFF
2	LINK1 communication speed	OFF: 100Mbps ON: 10Mbps	OFF
3	LINK1 communication format	OFF: Full-Duplex ON: Half-Duplex	OFF
4	Reserved	Fixed at OFF (Don't turn "ON".)	OFF
5	LINK2 communication method	OFF: AUTO (automatic detection) ON : MANUAL(Sets the switch No.6 and 7 manually .)	OFF
6	LINK2 communication speed	OFF: 100Mbps ON: 10Mbps	OFF
7	LINK2 communication format	OFF: Full-Duplex ON: Half-Duplex	OFF
8	Reserved	Fixed at OFF (Don't turn "ON".)	OFF

9-4. Set the IP Address of NCW-3DNIP

There are two methods for setting the IP address of NCW-3DNIP.

- ① Sets the subnet address "x" and host address "y" of (192.168.x.y) manually by the IP address setting switch on the NCW-3DNIP's front panel.
- ② Allocates the IP address for NCW-3DNIP automatically by the BOOTP/DHCP server.

9-4-1. Manual setting method of the IP address by IP address setting switch

The manual setting method of the IP address by the IP address setting switch on the front panel of NCW-3DNIP is described below.

The IP address is designated by "Subnet address [NET]" and "Host address [ADR]"

The Subnet address [NET] range is from 0 to F in the hex (0,...,15 in dec).

The Host address [ADR] range is from 0,...,FF in the hex (0,...,255 in dec). 0 and 255 are invalid values and are not able to use for the Host address.

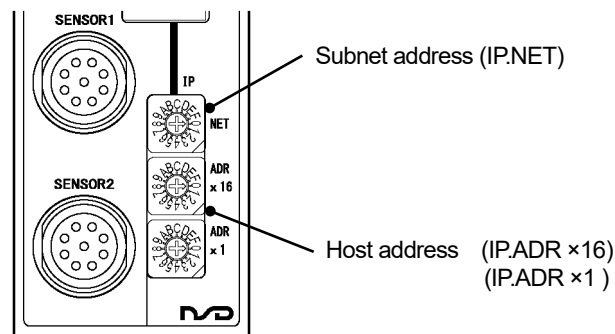

● Setting Method

- (1) Sets the Host Address rotary switch to "FF (255)".
- (2) Supplies power to NCW-3DNIP.
- (3) Sets the address switch in the following ranges.
Subnet address: from 0,...,F(0,...,15)
Host address: from 1,...,FE(1,...,254)
- (4) Supplies power to NCW-3DNIP once again.
- (5) NCW-3DNIP is accessible with IP address which was set.

9-4-2. Allocation method of an IP address by the BOOTP/DHCP server

The automatic allocation method of an IP address by the BOOTP/DHCP server is described below.

The BOOTP/DHCP server is a stand-alone server that can set an IP address and other Transport Control Protocol (TCP) parameters.

The factory setting of NCW-3DNIP is described below; therefore, the NCW-3DNIP can be allocated the IP address automatically by default.

IP address setting switch on the front panel: IP.NET=0, IP.ADR(x16)=0, IP.ADR(x1)=0

Indicates the flow chart when allocating an IP address.

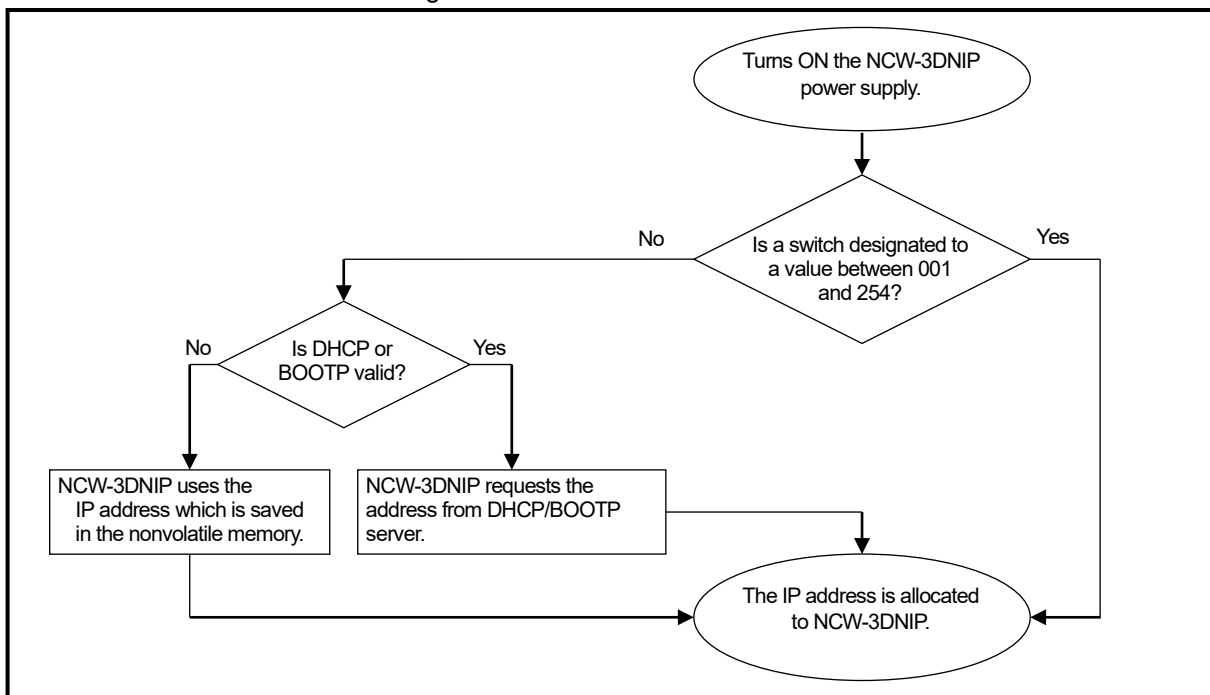

BOOTP/DHCP is selected by the attribute 3 (Configuration Control) of TCP/IP Interface object.

Overview of the TCP/IP Interface object "attribute 3 (Configuration Control)"

Bit	Name	Description
0-3	Startup Configuration	0: The device use the previously saved interface setting value. (Such as the value in the non-volatile memory or the value of the hardware switch) 1: The device obtain its interface configuration values via BOOTP. 2: The device obtain its interface configuration values via DHCP. (Default) 3-15: Reserved
4	DNS Enable	NCW-3DNIP doesn't support.

● Setting Method

Assign "Relation List" of the MAC address for NCW-3DNIP to the BOOTP/DHCP server before next procedures below.

Check the MAC address on the panel side of NCW-3DNIP.

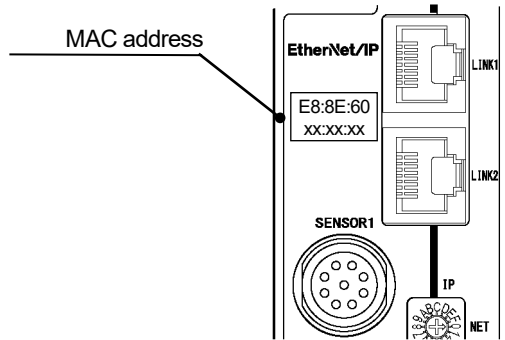

- (1) Set the Host Address rotary switch to FF (255), and then supply power to NCW-3DNIP.
- (2) Change the Host Address rotary switch to 00 (0), and then supply power to NCW-3DNIP once again.
- (3) NCW-3DNIP sends a request to receive an IP address from the BOOTP/DHCP server.
- (4) The BOOTP/DHCP server will allocate an IP address to NCW-3DNIP if it is on "Relation List" already.

The operation method of the detailed BOOTP/DHCP server is indicated from next page.

(1) Start "BOOTP/DHCP Server2.3 software" manufactured by Rockwell Automation, Inc.

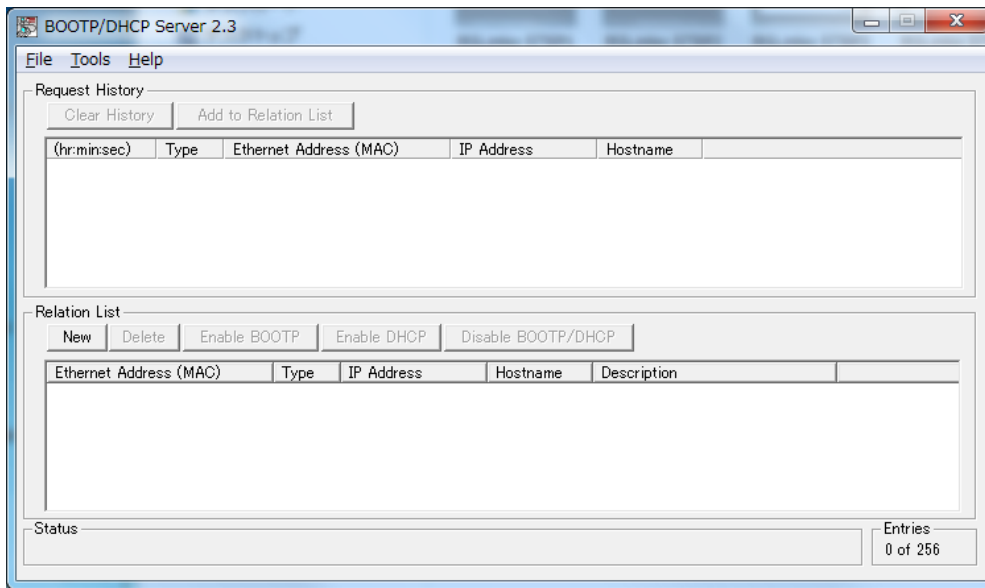

(2) Configure the TCP (Transport Control Protocol) parameters
From the Tools menu, choose "Network Settings".

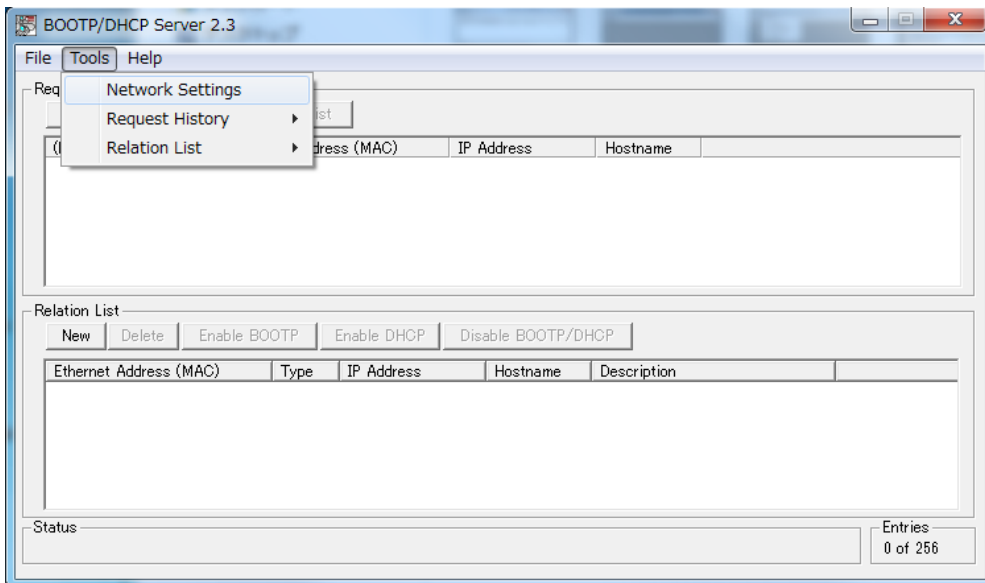

(3) Enter values on “Subnet Mask”

On the “Network Settings” dialog box, enter values on “Subnet Mask”, and then click “OK”.

The next items are options.

- Gateway - Primary DNS - Secondary DNS - Domain Name.

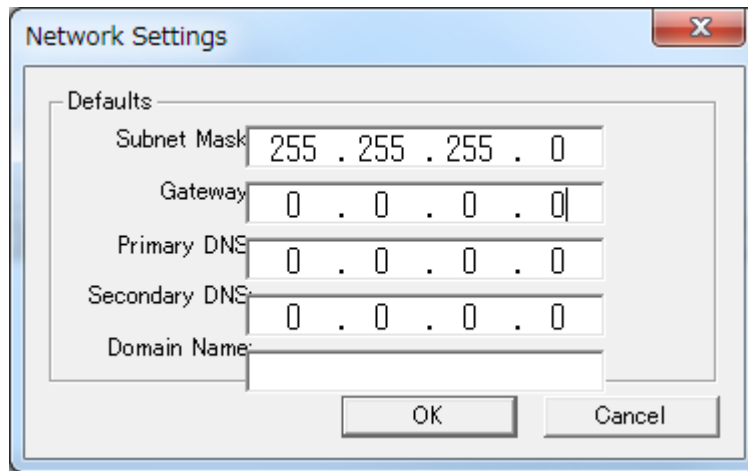

(4) BOOTP/DHCP request history display

The “Request History” field displays the hardware addresses (MAC addresses) of all modules that issue BOOTP/DHCP requests.

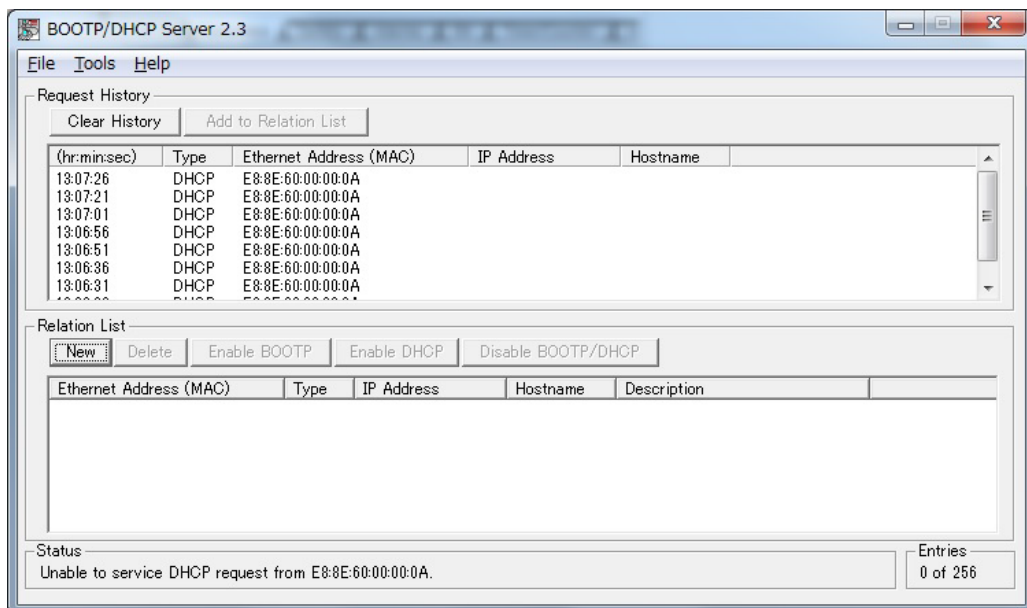

(5) Choose the appropriate module (NCW-3DNIP)

Choose the appropriate module (NCW-3DNIP) in the “Request History” field, and then click “Add to Relation List”.

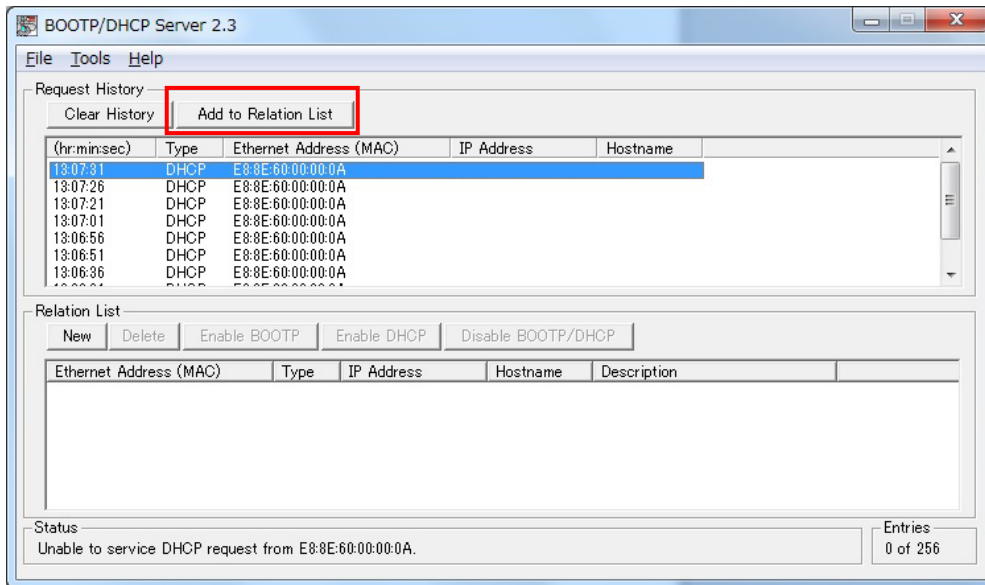

(6) Associate the MAC address with an IP address

The “New Entry” dialog box appears. Associate MAC address with IP address.

Enter an IP Address, Hostname, and Description for NCW-3DNIP, and then click “OK”.

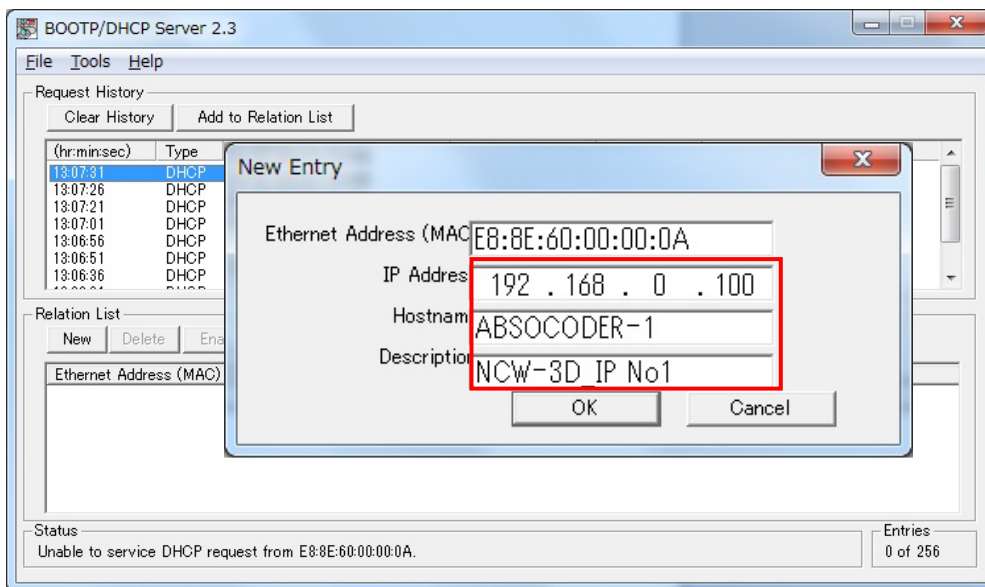

(7) Confirm that NCW-3DNIP is added on the "Relation list"

Confirm that NCW-3DNIP is added on the "Relation list" field.

Also, allocated IP address to NCW-3DNIP is displayed in the "Request History".

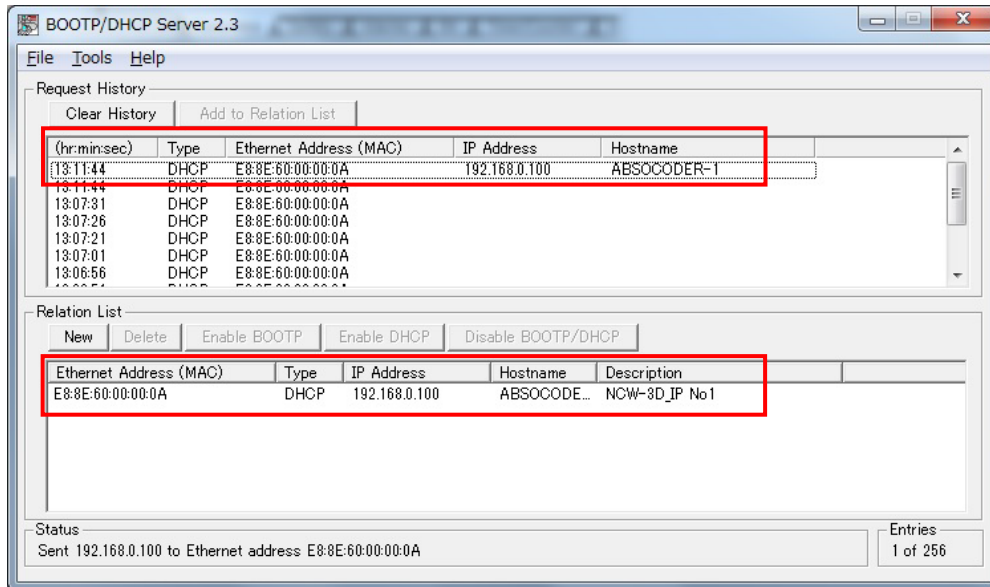

(8) Disable NCW-3DNIP requests to BOOTP/DHCP server

Choose NCW-3DNIP in the "Relation List" field, and click "Disable BOOTP/DHCP".

Then, a message of "[Disable DHCP] Command successful" is displayed in the status field.

When turning on the power supply again, NCW-3DNIP doesn't issue a DHCP request.

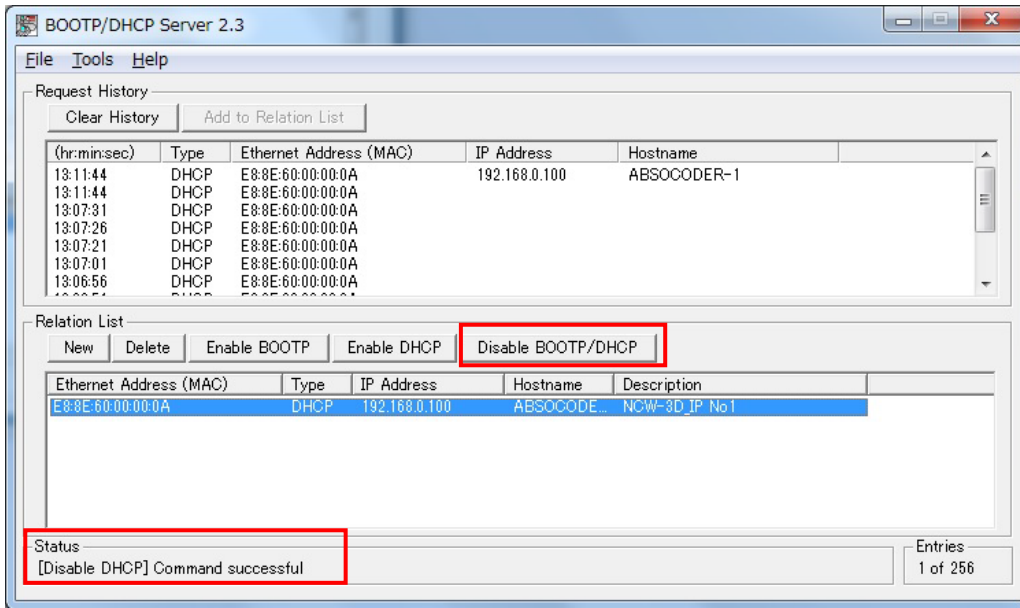

 Note

The above operation sets Bit0-3: Startup Configuration in attribute 3 (Configuration Control) of the TCP/IP Interface object to "0: The device use the previously saved interface setting value."
After this setting, the IP address setting via BOOTP/DHCP will not be accepted.

To set the IP address setting via BOOTP/DHCP again, do the following.

(1) Shut off the power to NCW-3DNIP.

(2) Set the Host address rotary switch (IP.ADR ×16, ×1) on the panel of NCW-3DHIP to FF (255).

(3) Supply the power to NCW-3DNIP.

At this time, "2: The device obtain its interface configuration values via DHCP.(Default)" is set to Bit0-3: Startup Configuration in attribute 3 (Configuration Control) of the TCP/IP Interface object.

(4) Shut off the power to NCW-3DNIP again.

(5) Set the Subnet address (IP.NET) on the panel of NCW-3DNIP to 0 (0) and the Host address rotary switch (IP.ADR ×16, ×1) to 00 (0).

(6) Supply the power to NCW-3DNIP again.

At this time, the IP address setting via BOOTP/DHCP is available.

(9) The allocation of an IP address is completed.

9-5. Configure the EtherNet/IP Driver

Configures an Ethernet communication driver by using RSLinx Classic.

Configure the EtherNet/IP Driver to the programming terminal (Windows PC) in order to set the network between the controller (1769-L30ERM/A CompactLogix5330ERM) and NCW-3DNIP.

(1) Start the RSLinx Classic Software.

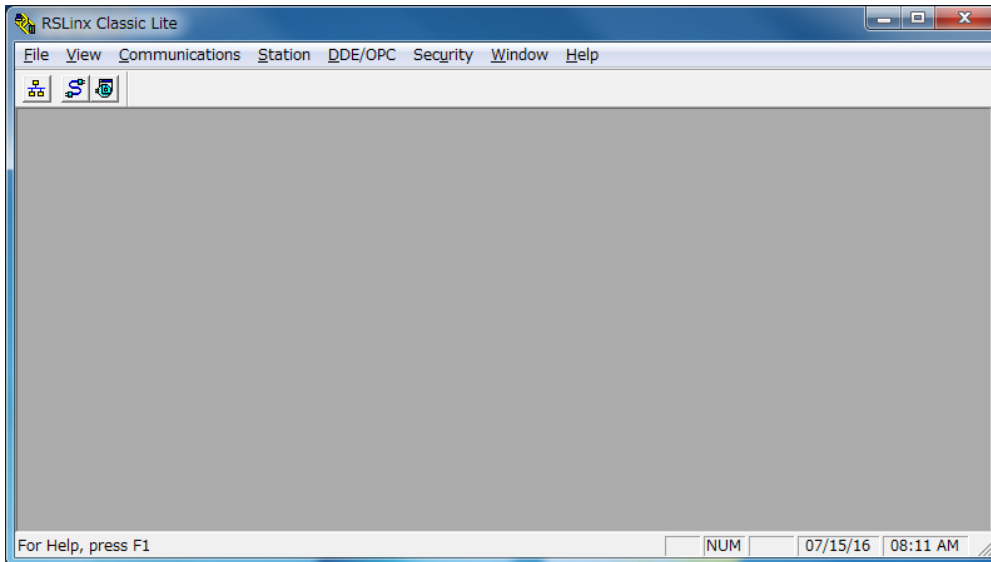

(2) Configure Communication Drivers

From the "Communications" menu, choose "Configure Drivers".

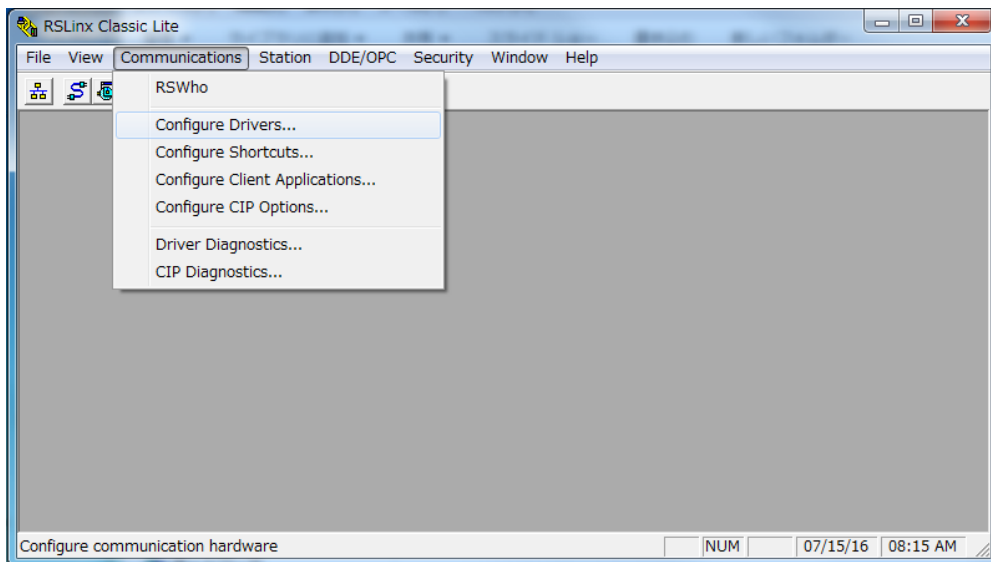

(3) Choose the EtherNet/IP Driver

From the “Available Driver Types” pull-down menu, choose “EtherNet/IP Driver”.

Then click “Add New ...”.

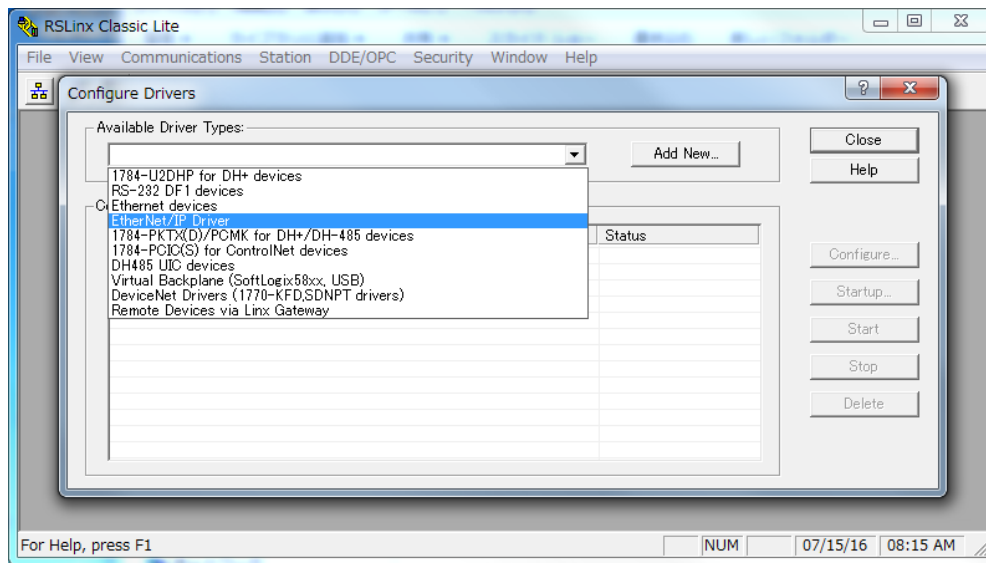

(4) Enter a name for the new driver

The “Add New RSLinx Classic Driver” dialog box appears.

Enter a name for the new driver, and click “OK”.

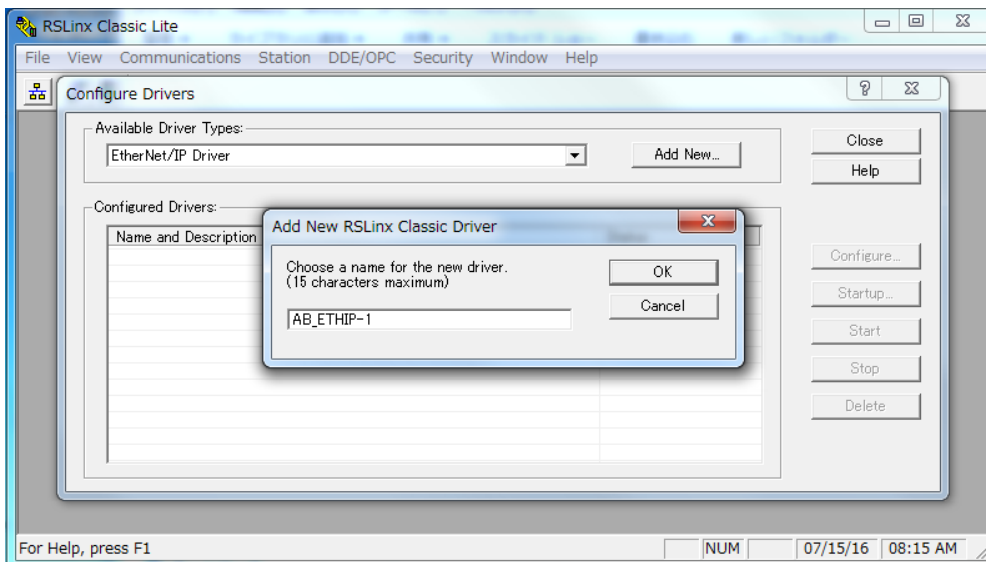

(5) Choose the Ethernet device on the EtherNet/IP network

The “Configure driver” dialog box appears, and then click “Browse Local Subnet” checkbox.

Choose the desired device, and click “OK”.

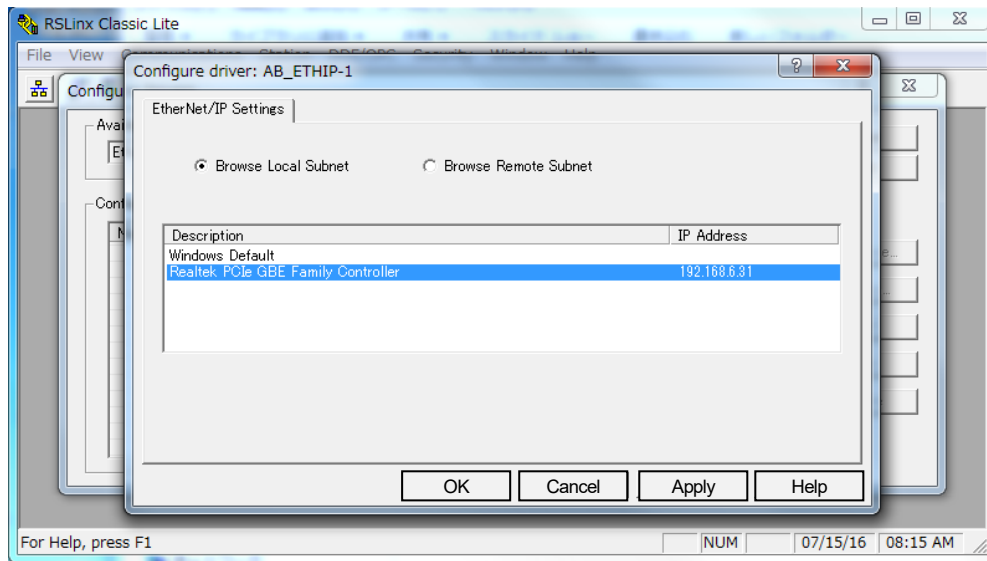

(6) Confirm the status with the new driver

The added driver appears on the “Configure Drivers” dialog box.

Confirm that the status message of added driver is “Running”. Then click “Close”.

In the above procedure, you can access controller (CompactLogix) and NCW-3DNIP via the EtherNet/IP network from RSLogix5000.

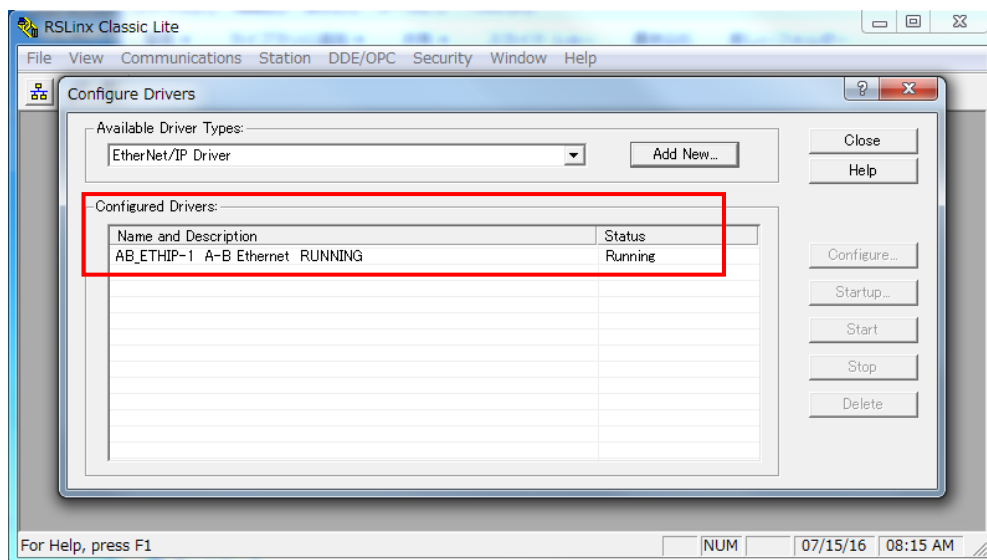

(7) Find devices

Search a device connected on the EtherNet/IP network.

From the “Communications” menu, choose “RSWho”.

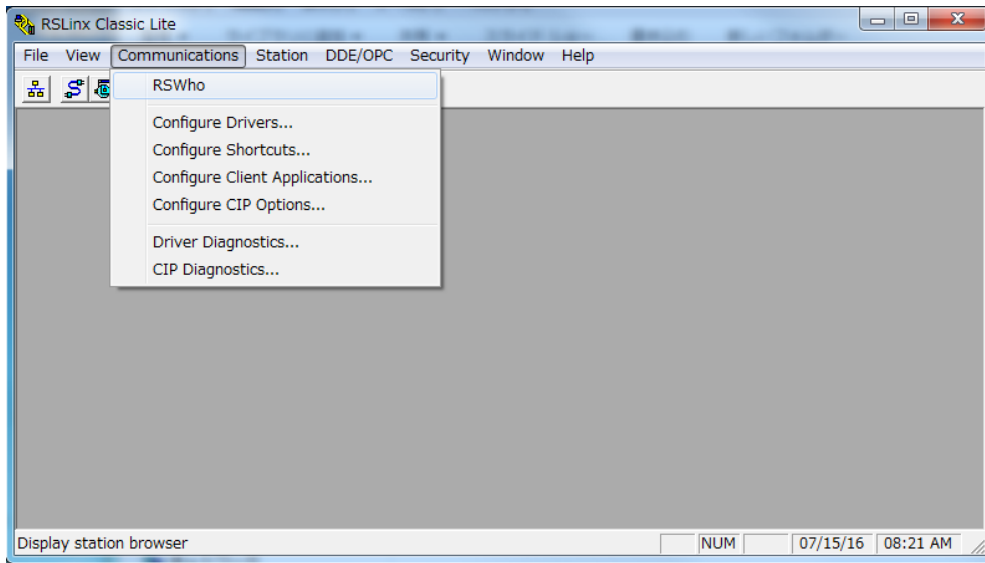

(8) Confirm the connection between the controller and NCW-3DNIP

The “RSWho” dialog box appears, and it indicates that the controller is connected with NCW-3DNIP via the EtherNet/IP network.

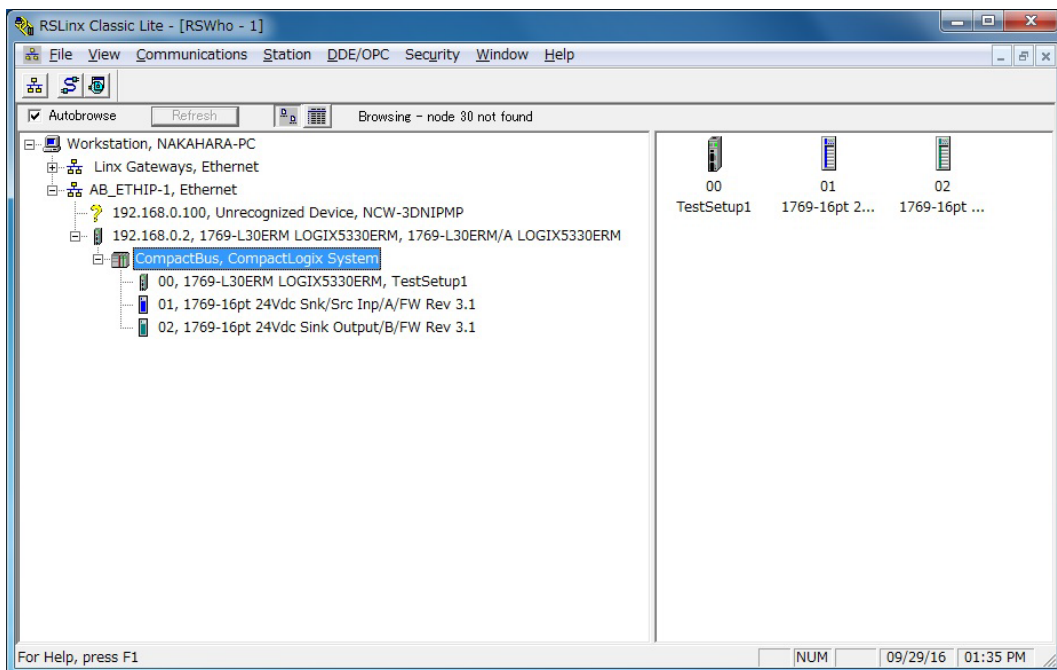

9-6. Configuration of EtherNet/IP Network

Configure the EtherNet/IP network by the RSLogix5000 software.

RSLogix5000 is a PLC development tool software manufactured by Rockwell Automation, Inc..

9-6-1. Configuration procedure

Set the network configuration by following procedures.

The procedures and settings are different whether EDS file is used or not.

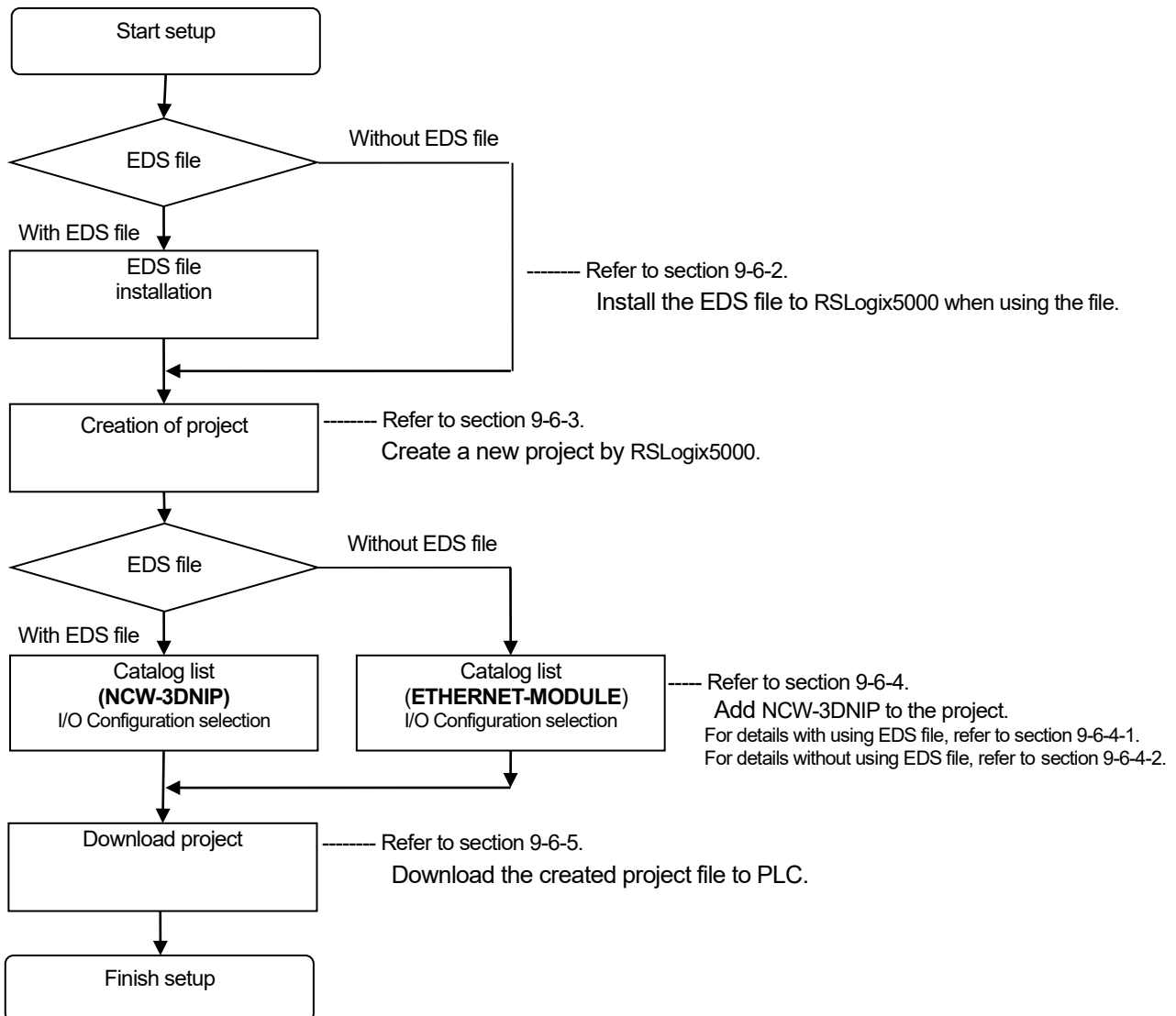

9-6-2. Installation of the EDS file

If EDS file isn't installed, proceed to the next "9-6-3. Creation of controller project".

(1) Starting the RSLogix5000 software

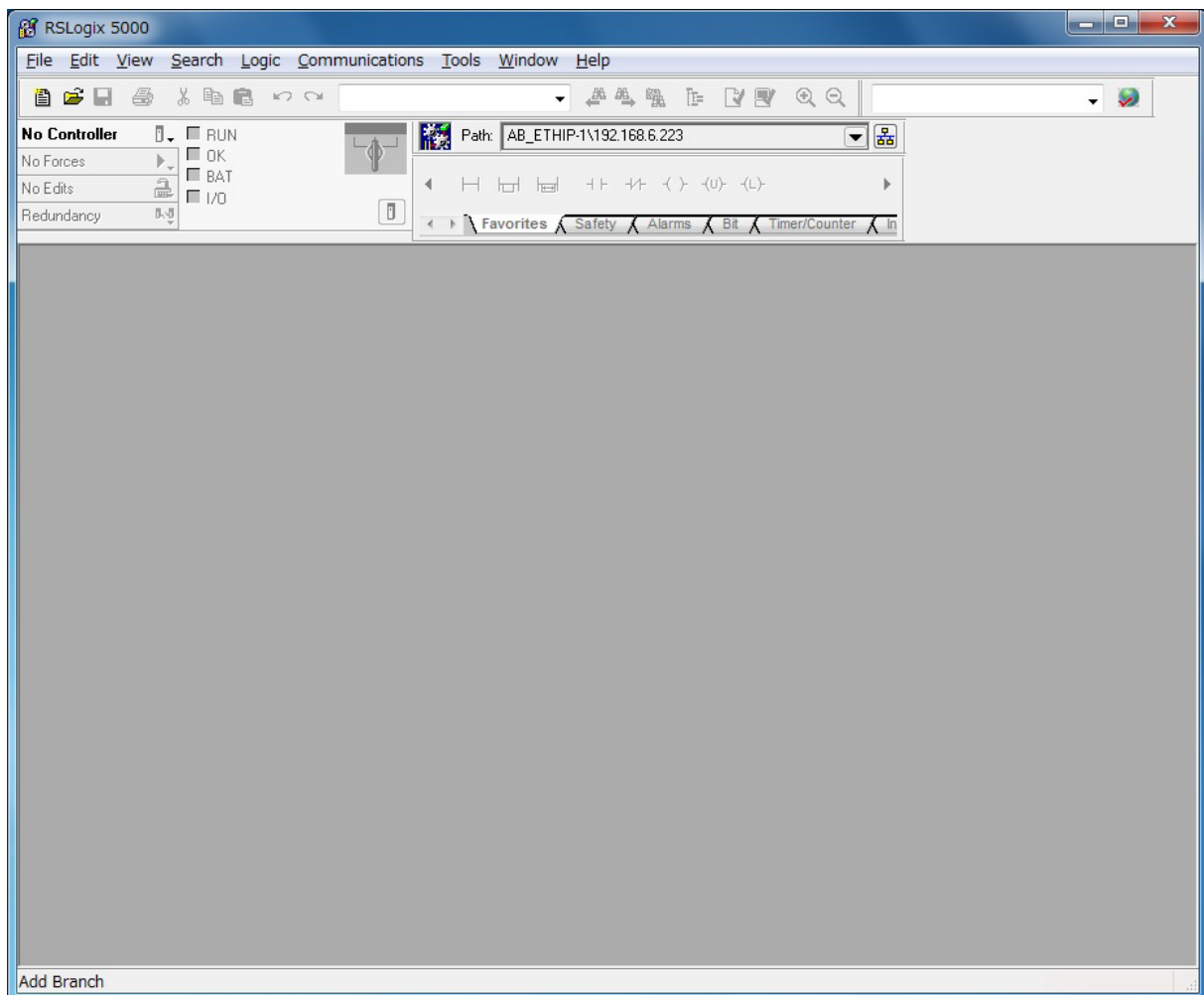

(2) Choose the EDS file installation tool

From the "Tools" pull-down menu, choose "EDS Hardware Installation Tool".

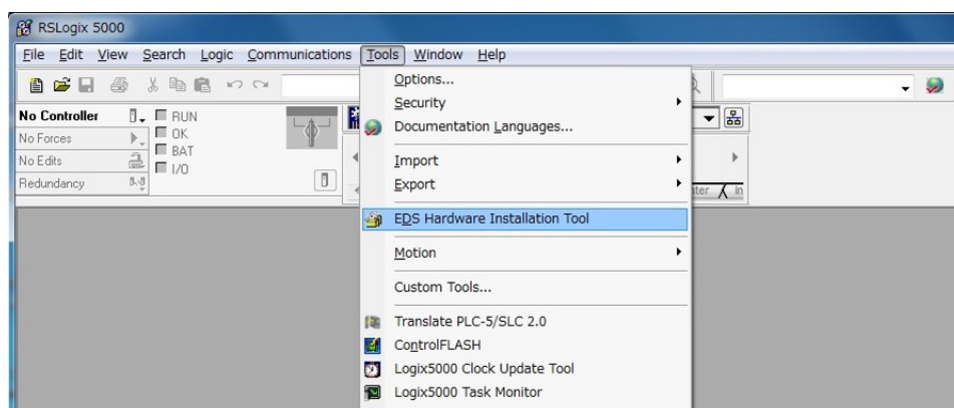

(3) Start EDS Wizard

Click "Next".

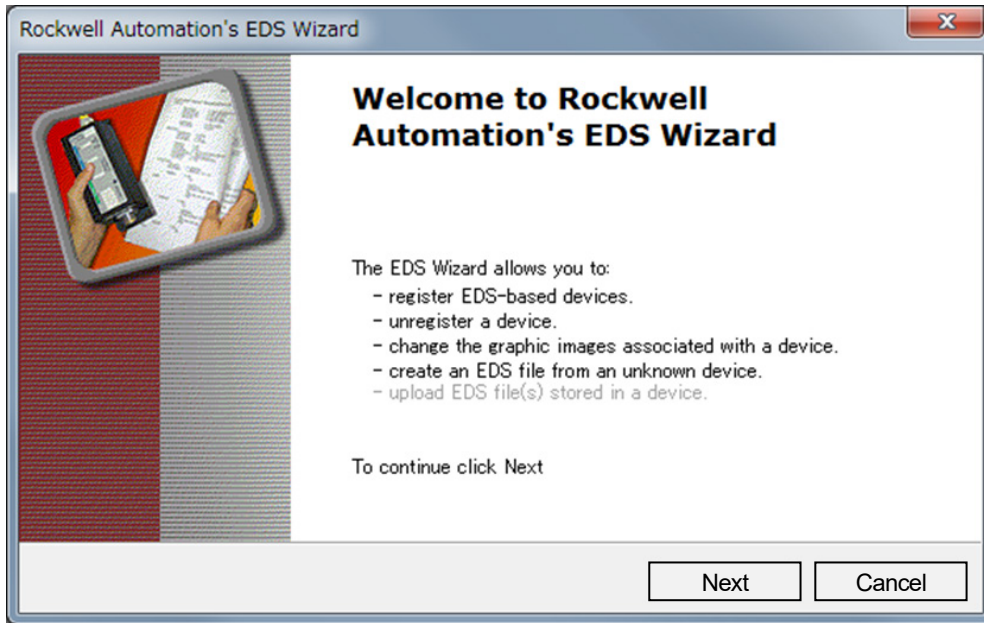

(4) Registration of the EDS file

Click the "Register an EDS files(s)" checkbox, and then click "Next".

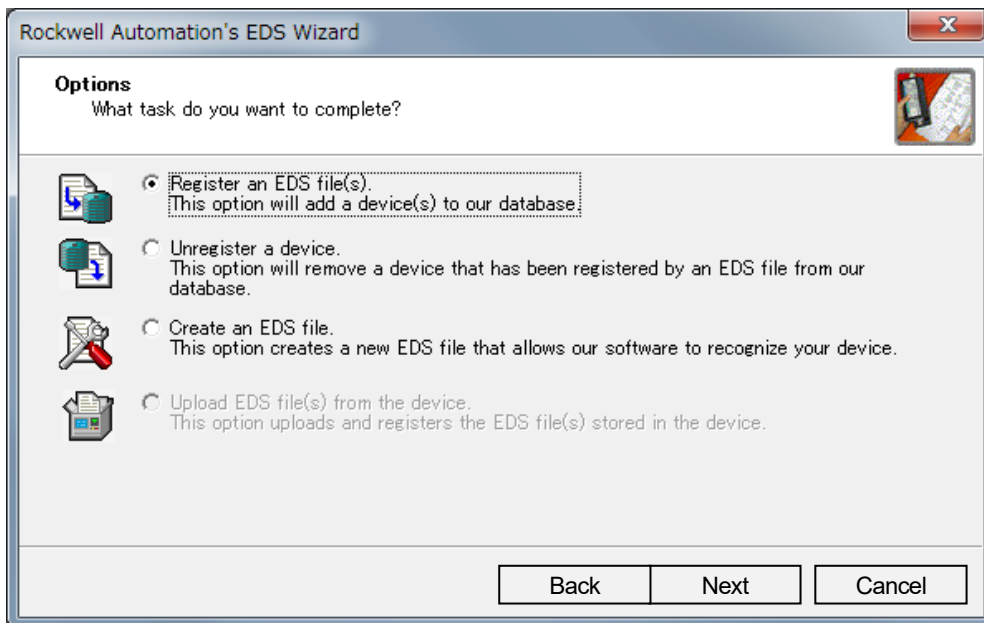

(5) Select the EDS file

Click the “Register a single file” checkbox, and then click the “Browse...”.

On the “Select an EDS file” dialog box, choose the desired file and click “Open”.

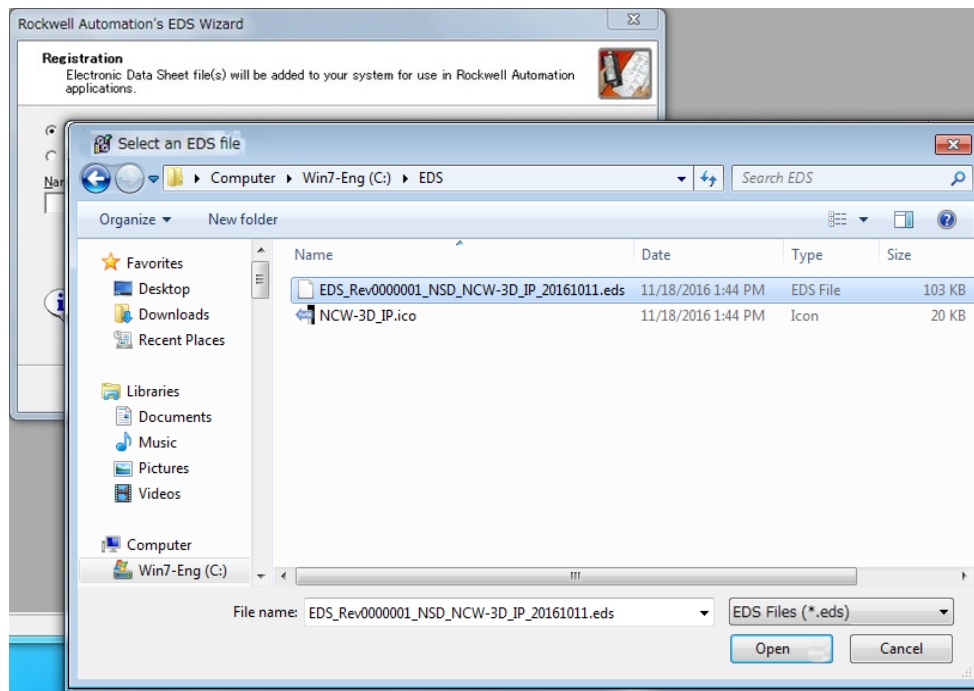

(6) Completion of the selected EDS file

On the “Rockwell Automation’s EDS Wizard” dialog box, click “Next”.

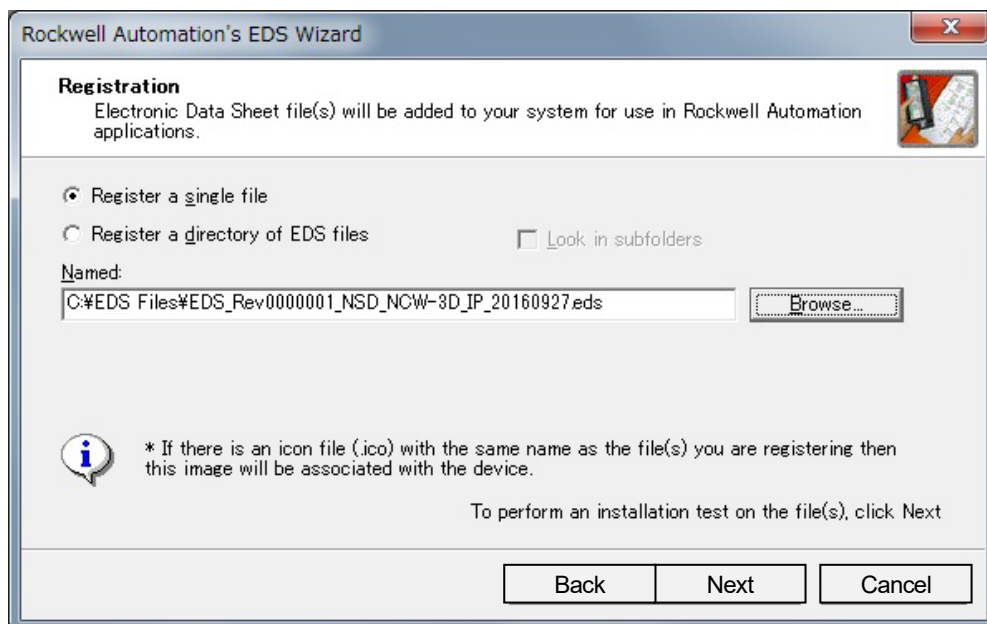

(7) EDS File Installation Test

Displays EDS File Installation Test Results on the “Rockwell Automation’s EDS Wizard” dialog box. Click “Next”.

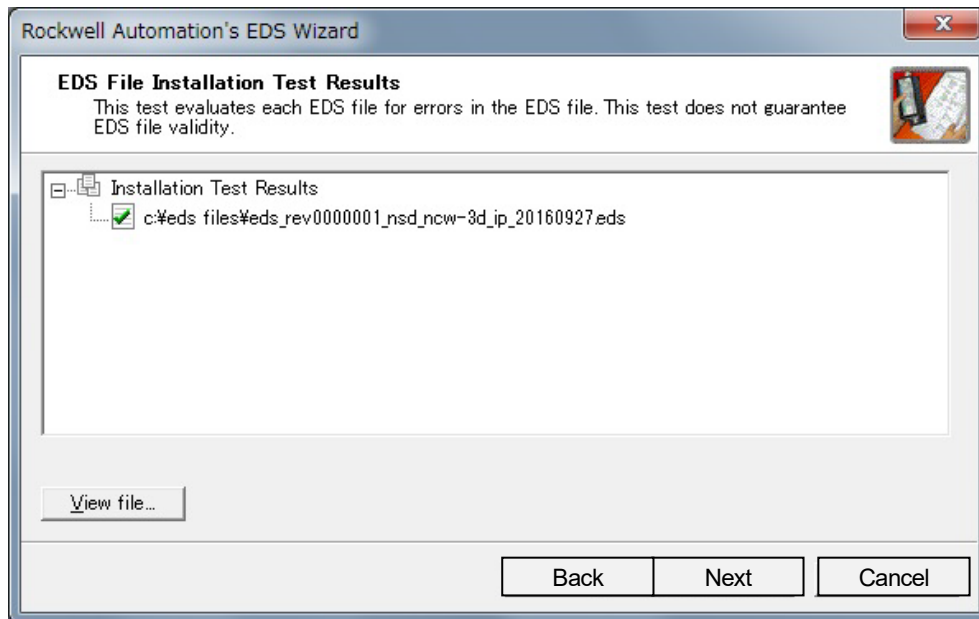

(8) Graphic Image for the device

It is not necessary to change Graphic Image for the device. Click “Next”.

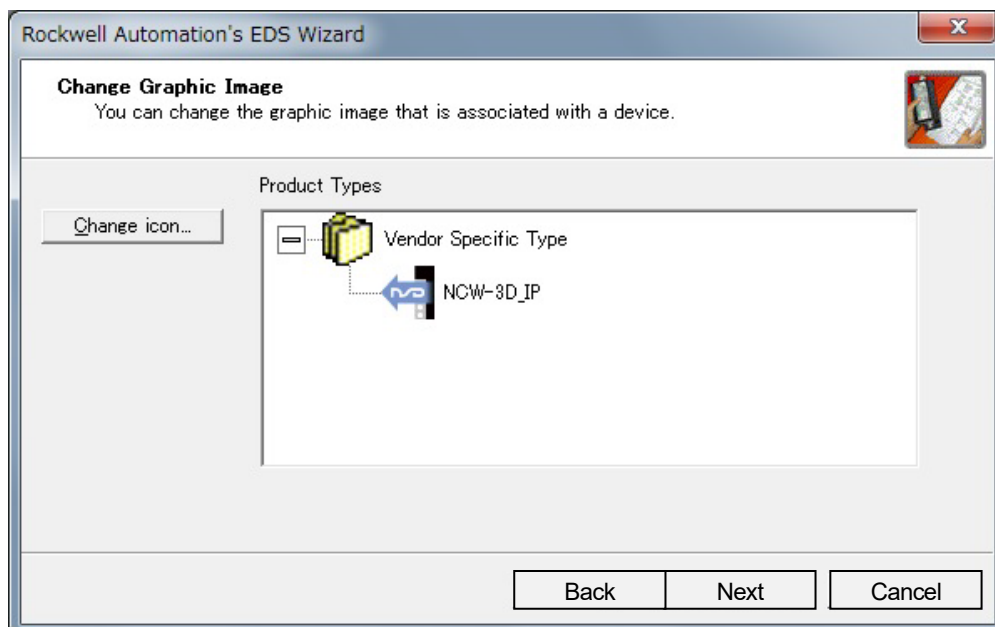

- (9) Confirm the registration of NCW-3DNIP
Confirm that NCW-3DNIP is successfully registered.
Click "Next".

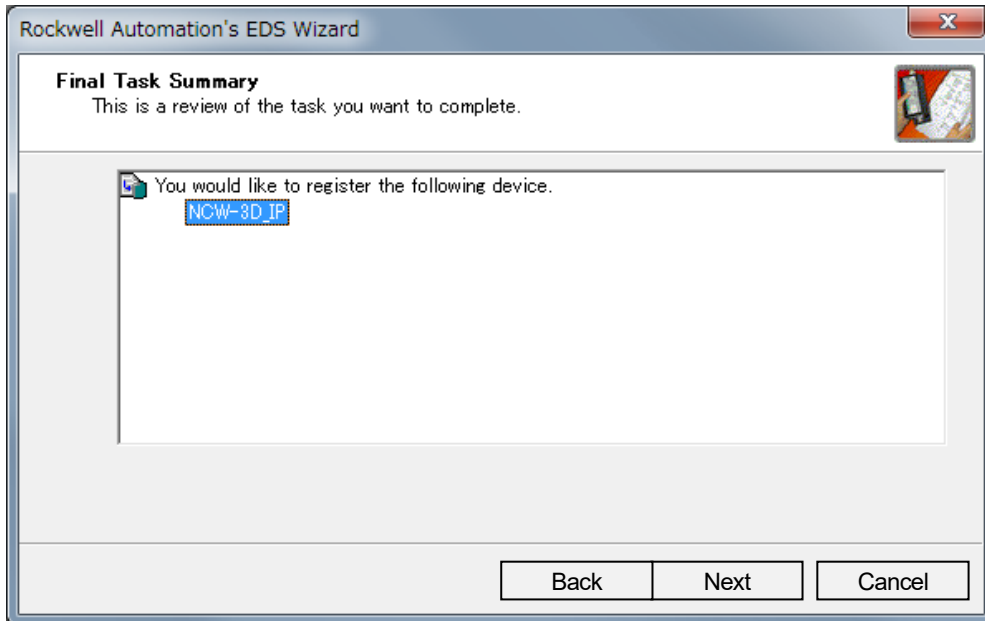

- (10) Close the EDS Wizard
The EDS file of NCW-3DNIP is successfully installed by the EDS Wizard.
Click "OK" to close the dialog box.

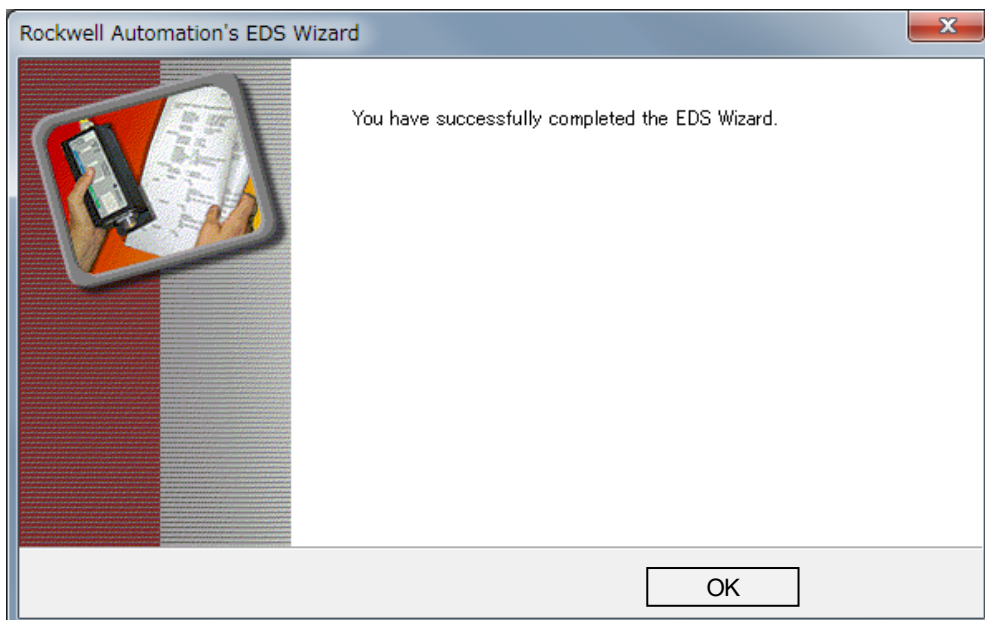

9-6-3. Creation of a controller project

Create a new controller project for the Network.

(1) Create a new controller project

From the “File” menu, choose “New” to create a new controller project for the Network.

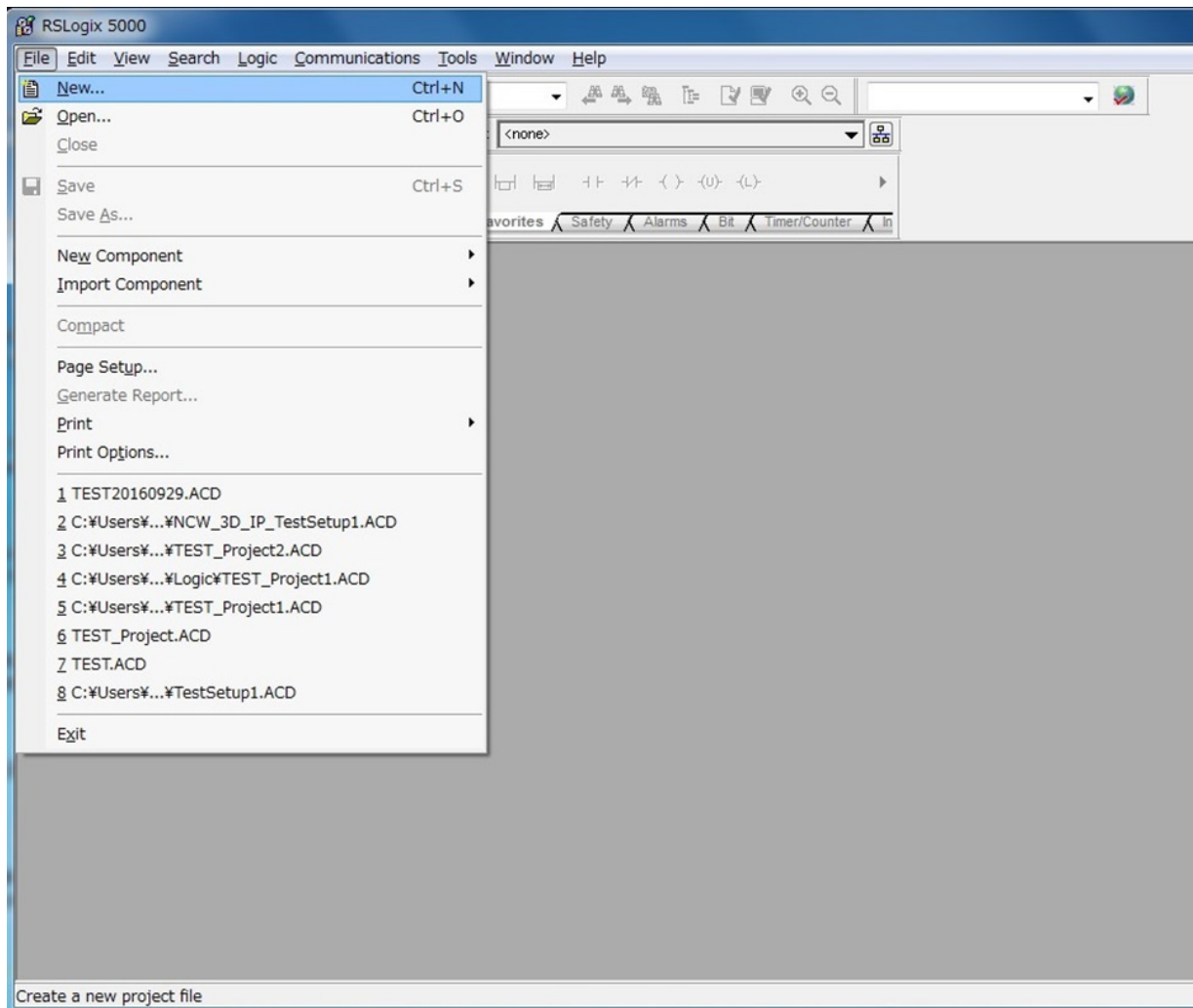

(2) Configure a new controller project

On the "New Controller" dialog box, enter the following items, and then click "OK".

- Desired controller type
- Revision number of RSLogix5000 software
- Project name

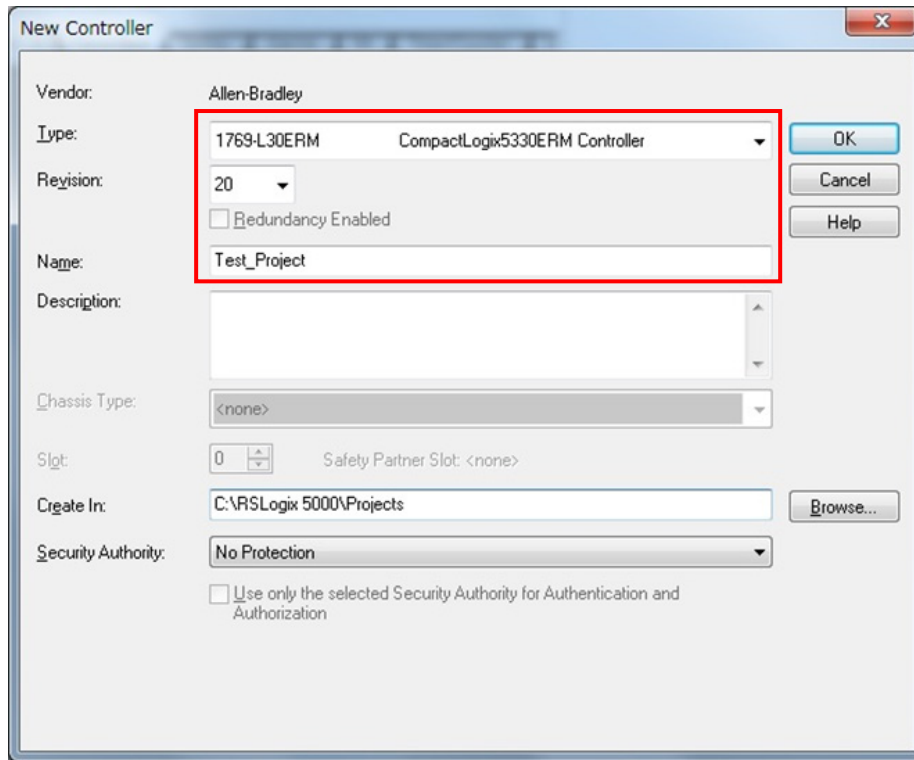

(3) Confirmation of a new controller project

A new project is created, and the controller (1769-L30ERM/A CompactLogix5330ERM) is displayed in the "I/O Configuration" folder.

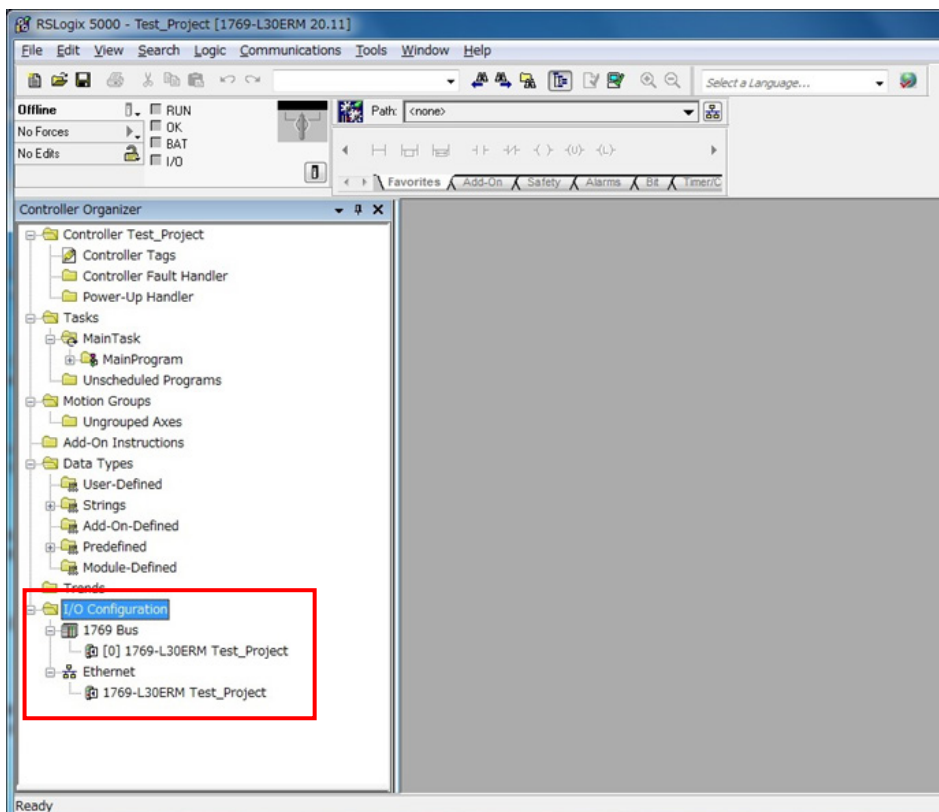

9-6-4. Adding NCW-3DNIP to the controller project

Add the NCW-3DNIP to the controller project as an I/O device.
There are two ways to add NCW-3DNIP as described below.

- ① In case EDS file is installed (refer to section 9-6-4-1)
- ② In case EDS file isn't installed (refer to section 9-6-4-2)

9-6-4-1. In case EDS file is installed

(1) Right-click the "Ethernet" in the I/O Configuration folder, and choose "New Module".

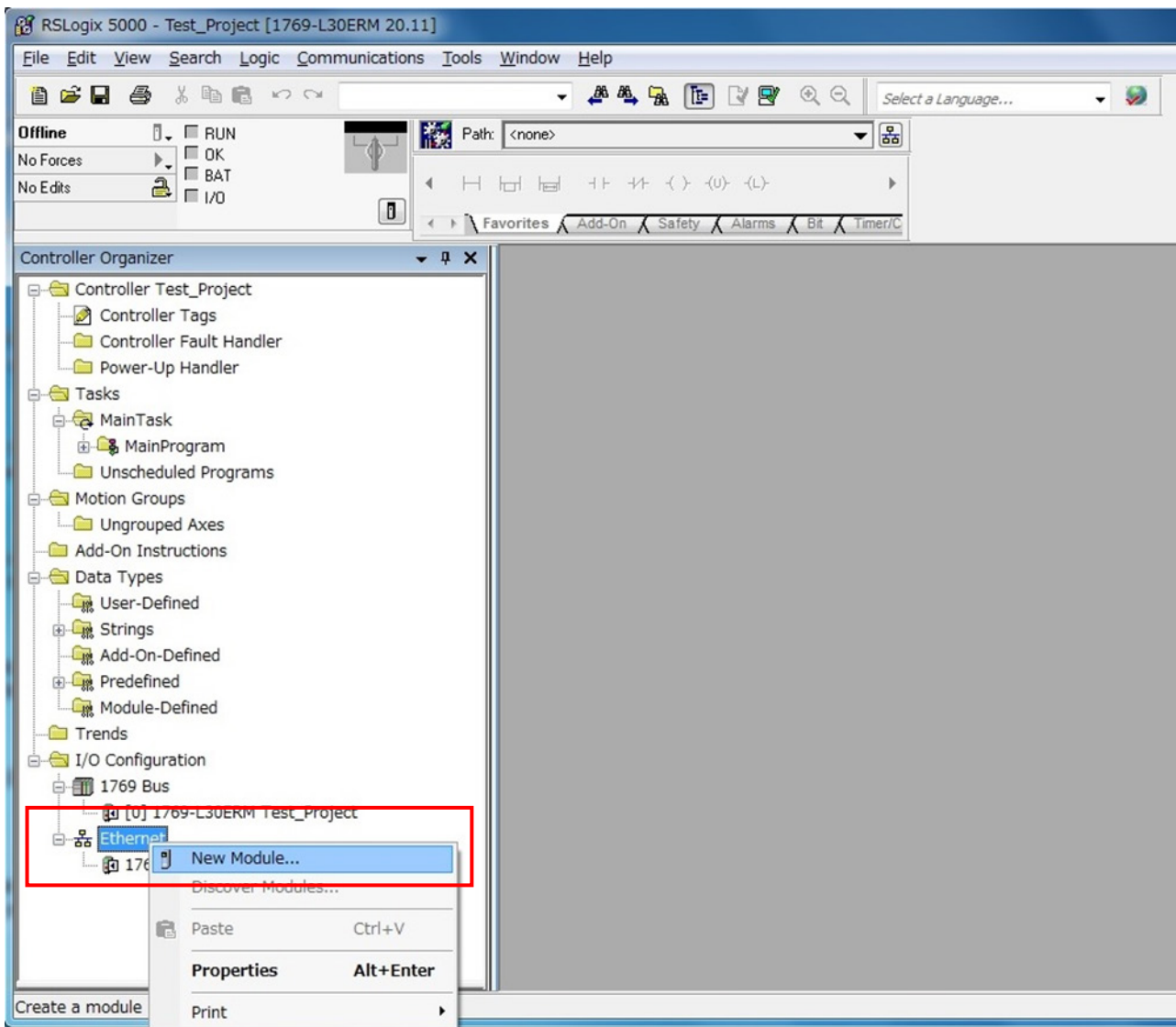

- (2) The “Select Module Type” dialog box appears
- (3) Uncheck the “Module Type Vendor Filters” checkbox.
- (4) Check the “NSD Corporation” checkbox.
- (5) Choose NCW-3DNIP which is displayed in the “Catalog Number field”.
- (6) Click “Create”.

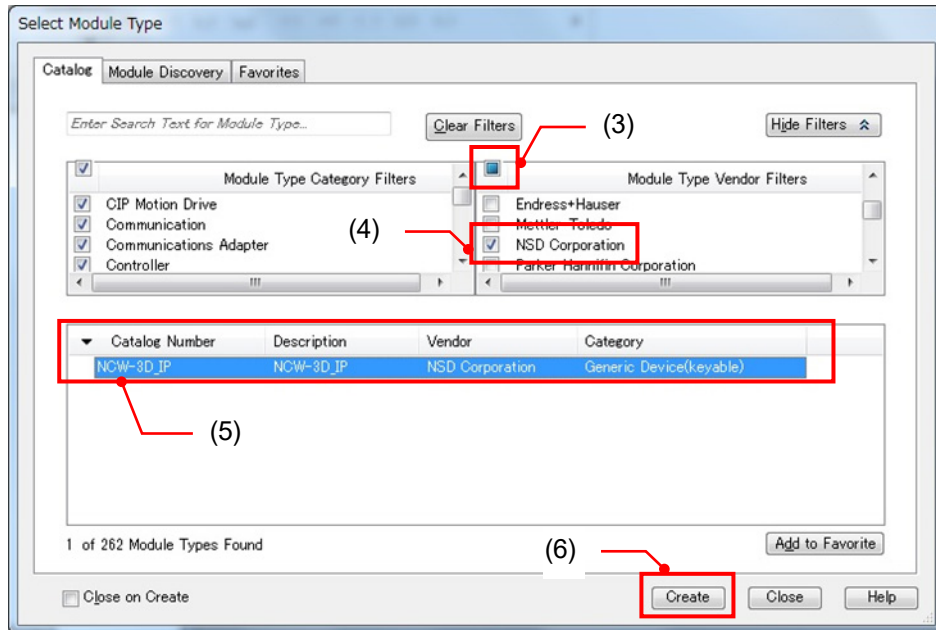

- (7) The “New Module” dialog box appears
- (8) Choose the “General” tab.
- (9) Type the name of NCW-3DNIP.
- (10) Enter the IP address of NCW-3DNIP.
- (11) Click “Change ...” to change the connection data size of NCW-3DNIP.

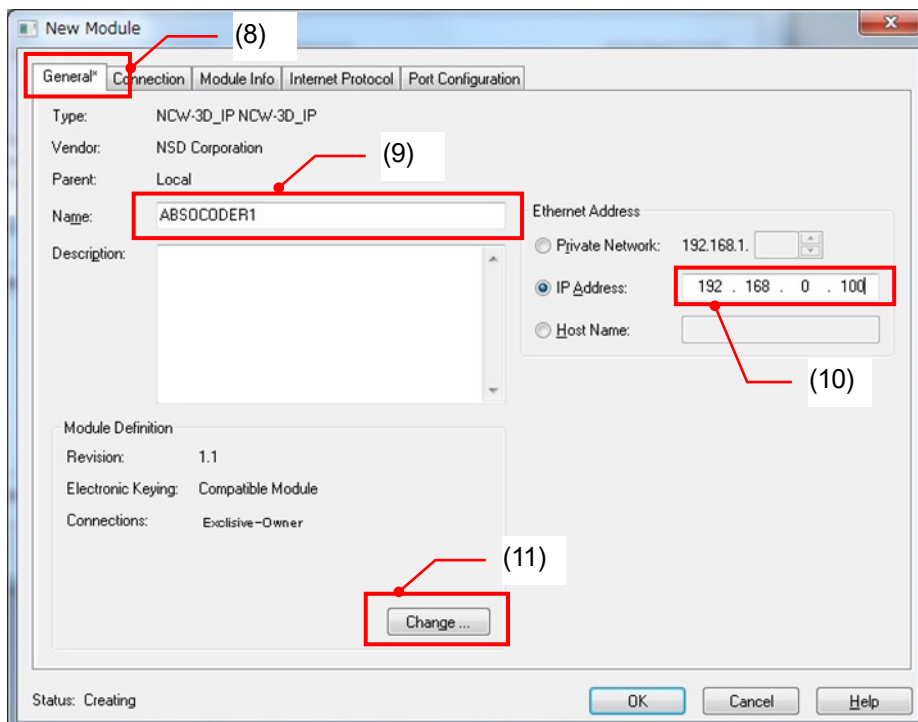

- (12) The “Module Definition” dialog box appears.
Choose “DINT”, and then click “OK”.

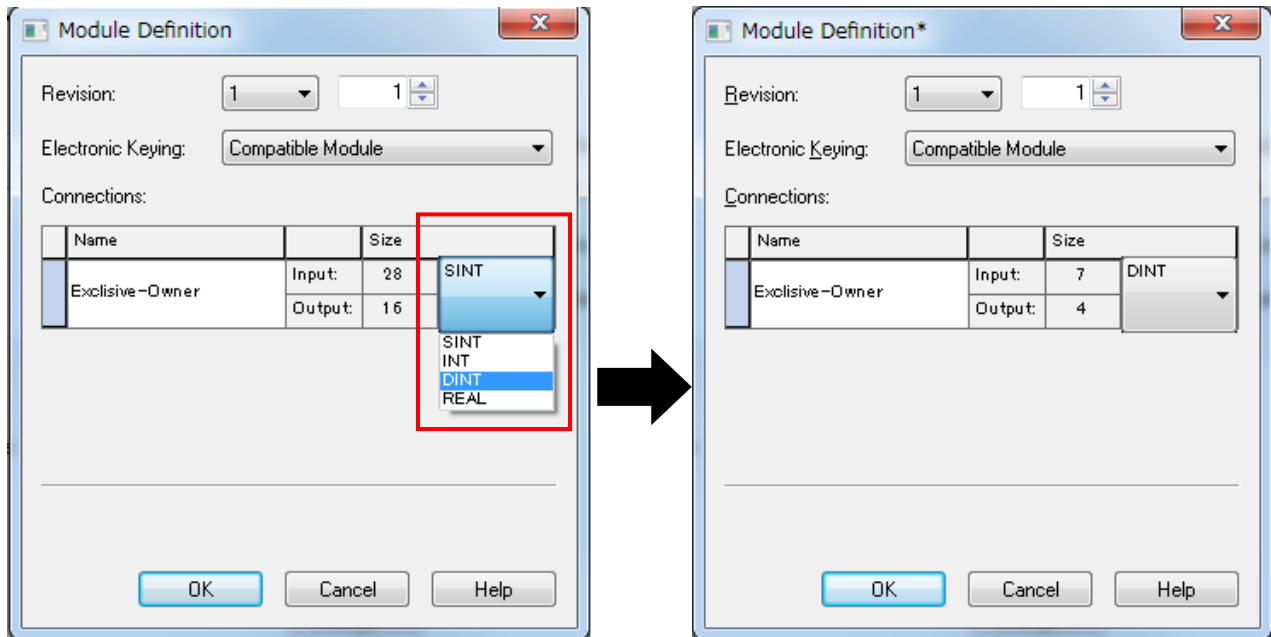

- (13) Choose the “Connection” tab.
(14) Designate the RPI (Request Packet Interval).
(15) Click “OK”.

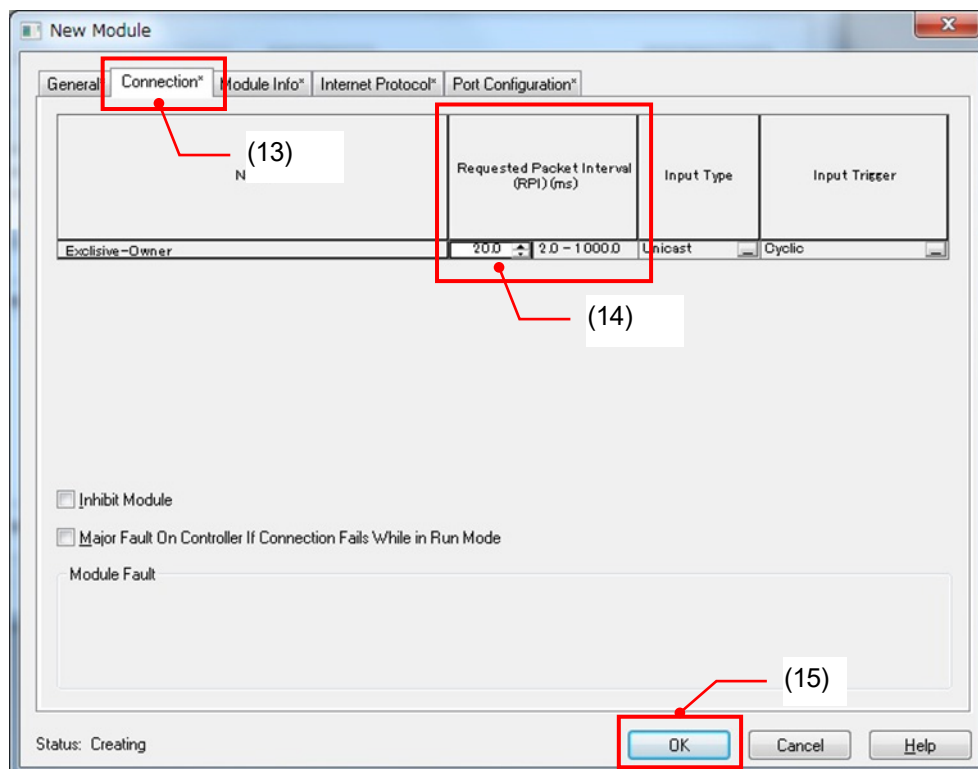

(16) "Adding NCW-3DNIP to the controller project" is completed.

Confirm that NCW-3DNIP is added on "EtherNet" of the "I/O Configuration" folder.

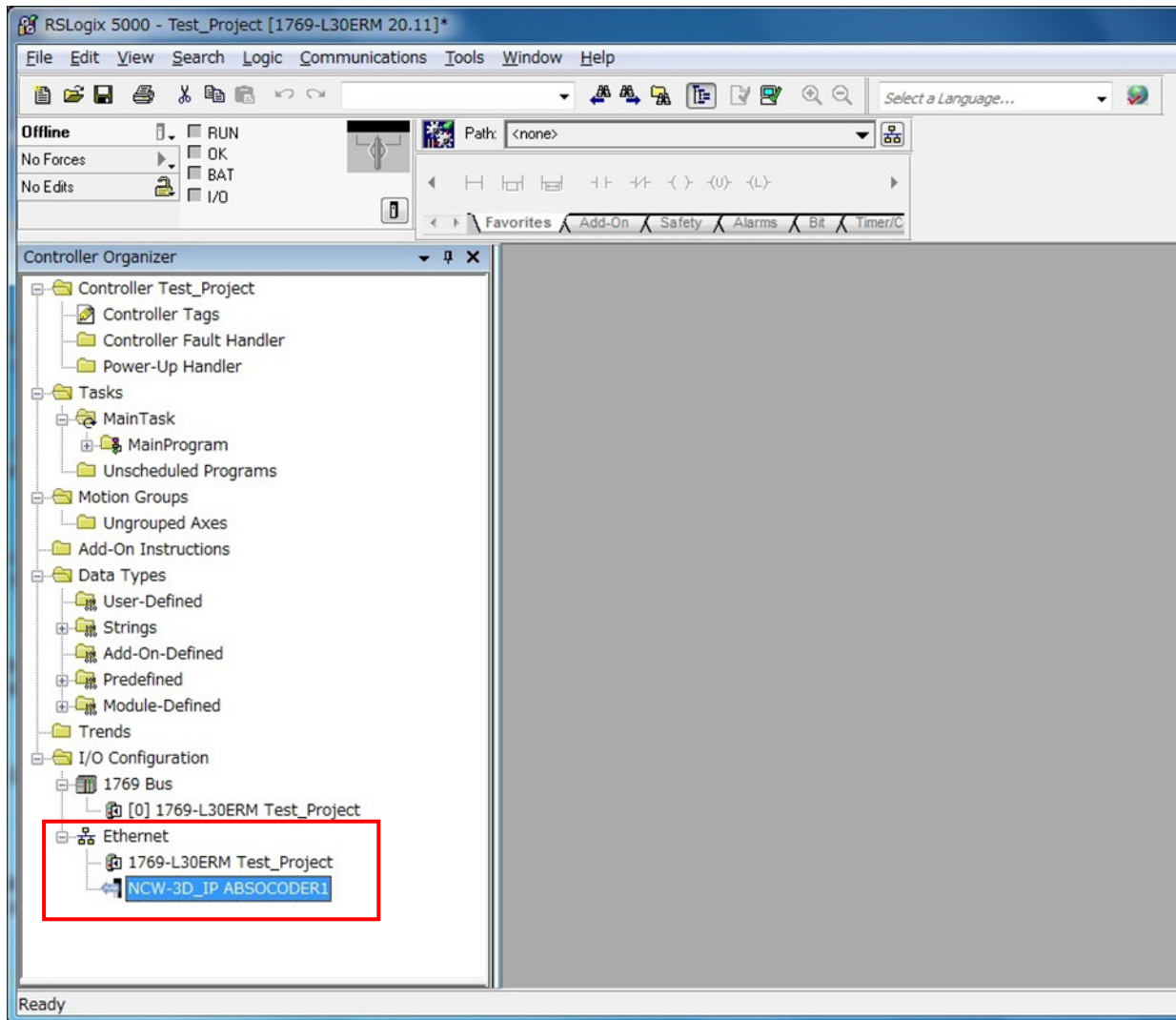

9-6-4-2. In case EDS file isn't installed

(1) Right-click the "Ethernet" in the I/O Configuration folder, and choose "New Module".

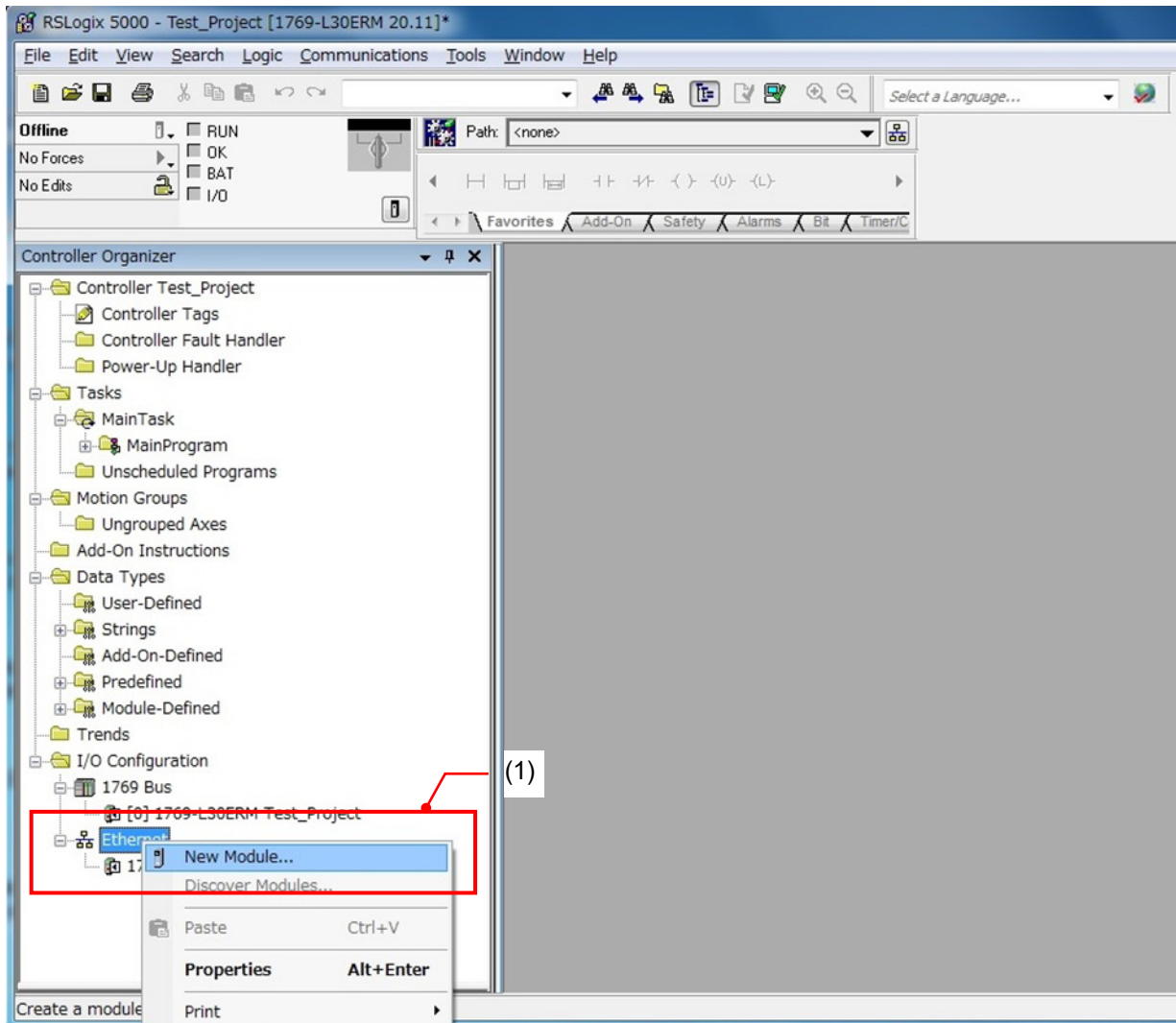

- (2) The "Select Module Type" dialog box appears
- (3) Select "ETHERNET-MODULE"
- (4) Click "Create".

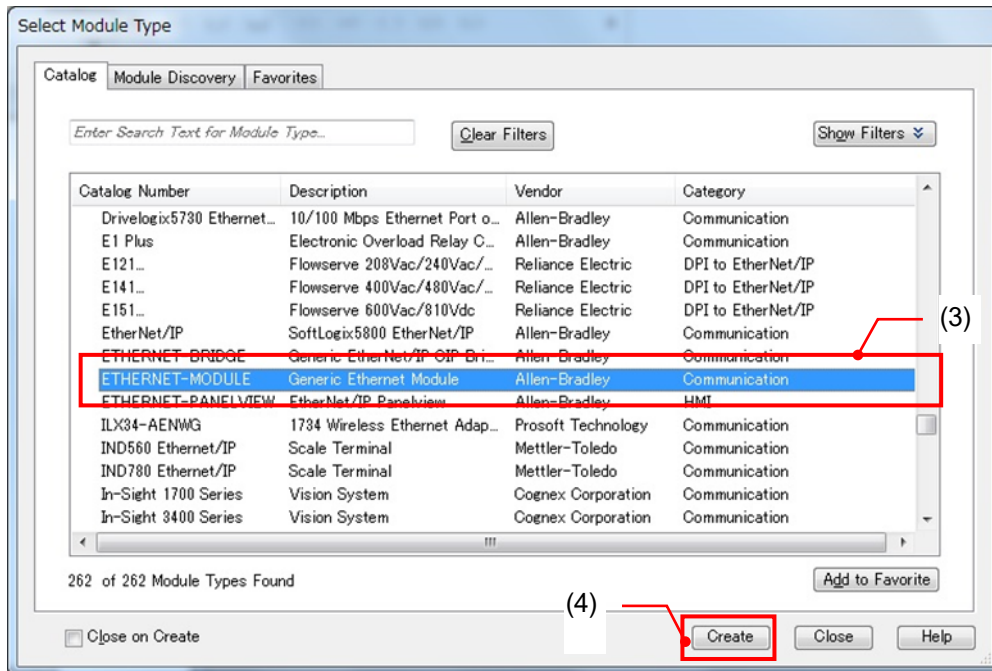

- (5) The "New Module" dialog box appears
- (6) Enter the information of "ETHERNET-MODULE" which is newly added.
 - Name
 - Description
 - Comm Format
 - IP Address
- (7) Enter value to the connection parameter as follows.
- (8) Click "OK".

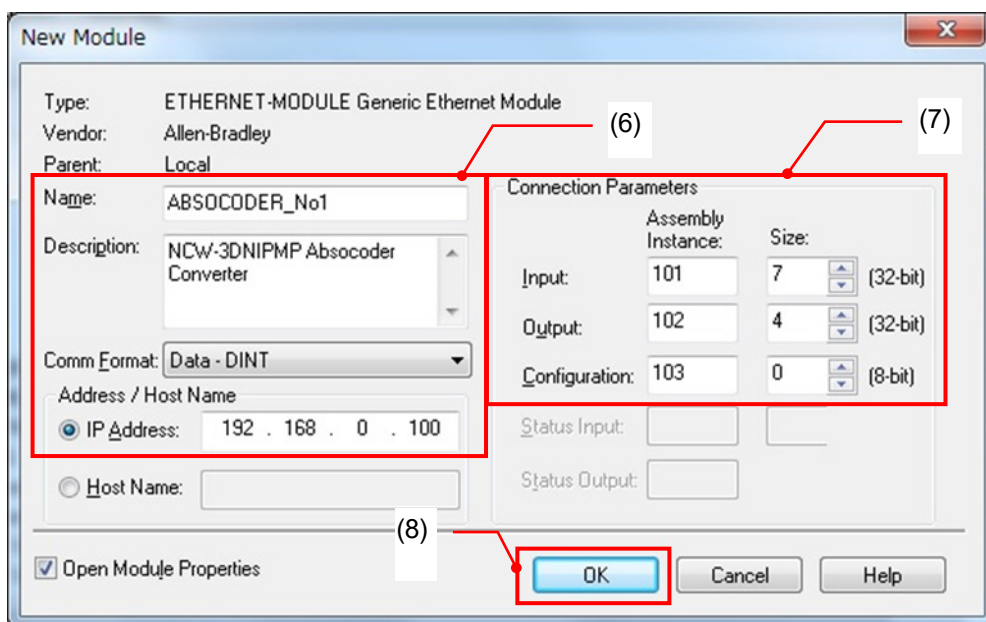

- (9) Right-click newly added "ETHERNET-MODULE", and choose the property.
- (10) Choose the "Connection" tab on the "Module Property Report" dialog box.
- (11) Designate the RPI (Request Packet Interval).
- Notice: RPI of NCW-3DNIP should be specified to 2.0ms or more.
- (12) Click "OK".
- (13) "Adding NCW-3DNIP to the controller project" is completed.

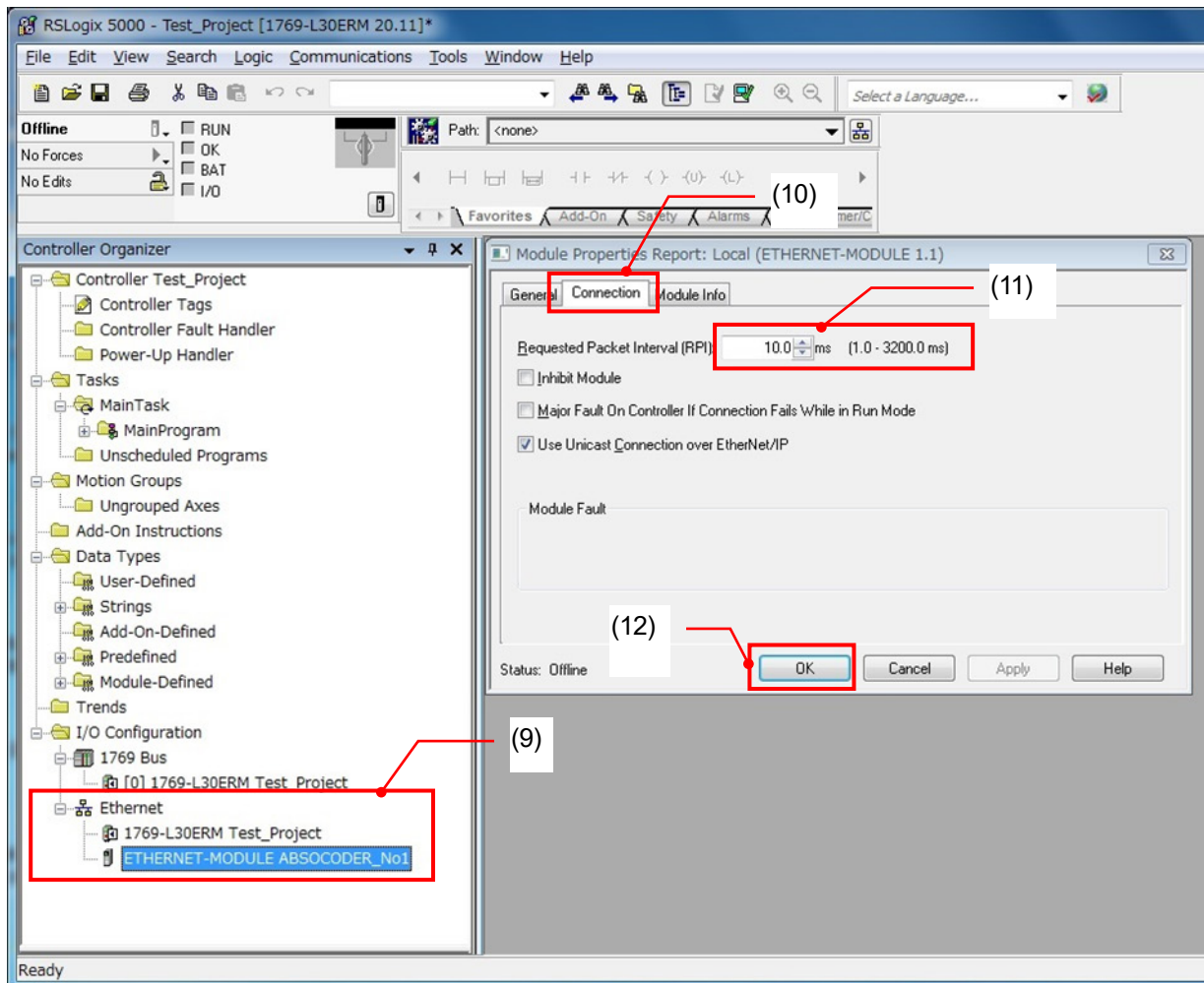

9-6-5. Download the project

Downloads the created project to the controller (1769-L30ERM/A CompactLogix5330ERM).
For downloading, the communication path must be specified to RSLogix5000 software.

(1) Specifies the communication path to the controller

Click “Brows  ” icon

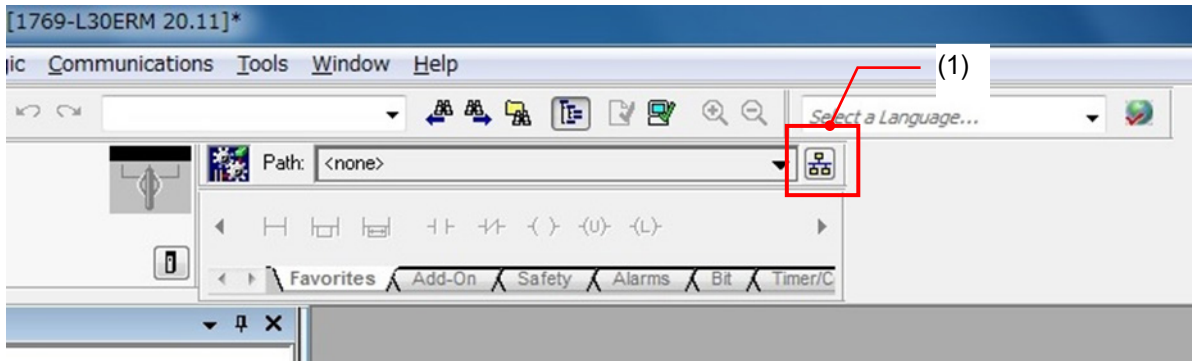

(2) On the “Who Active” dialog box, choose the controller (1769-L30ERM/A CompactLogix5330ERM).

(3) Click “Set Project Path”.

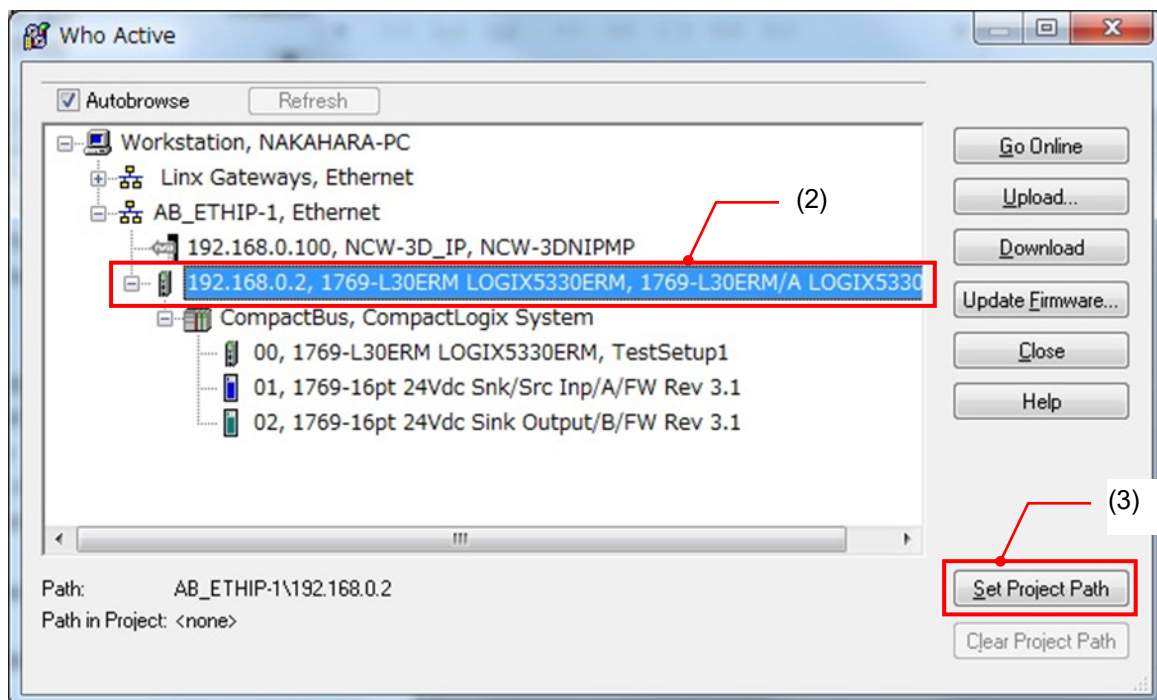

(4) Turn the mode switch on the controller (1769-L30ERM/A CompactLogix5330ERM) to the “PROG” position to online.

(5) Click the “Controller Status ” icon, and choose “Go Online”.

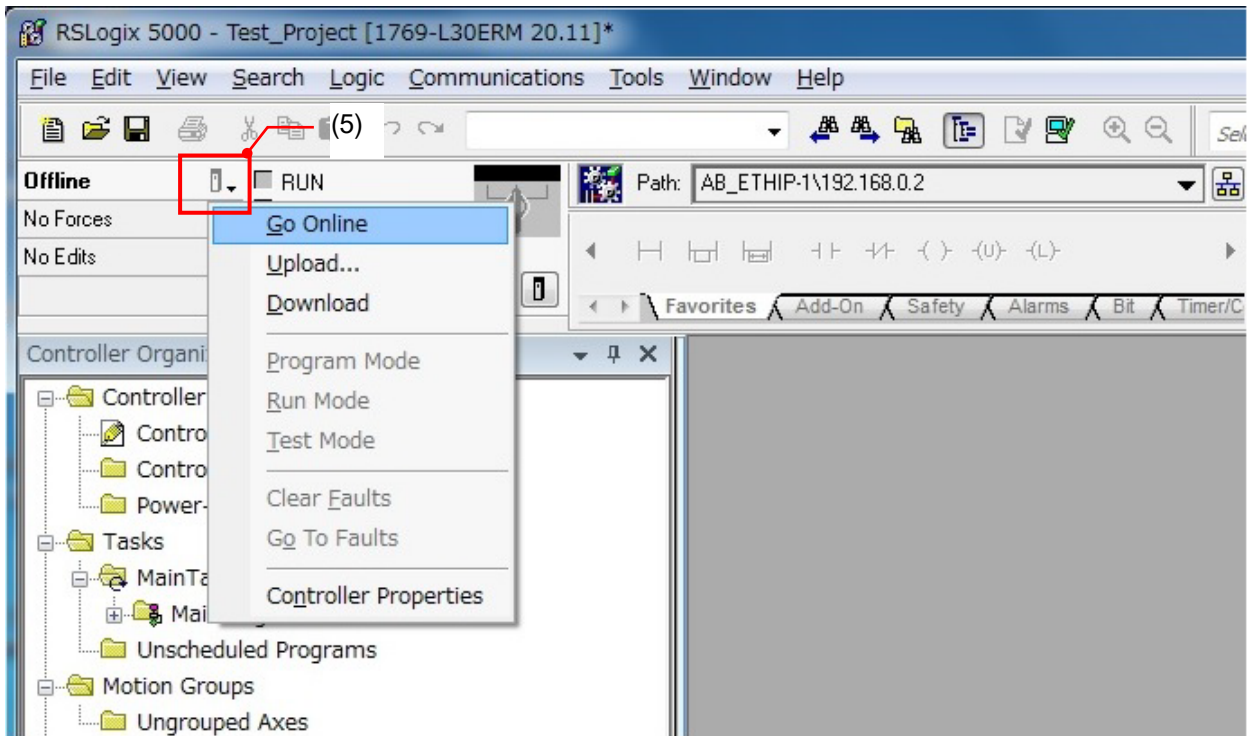

(6) On the “Connected To Go Online” dialog box, click “Download”.

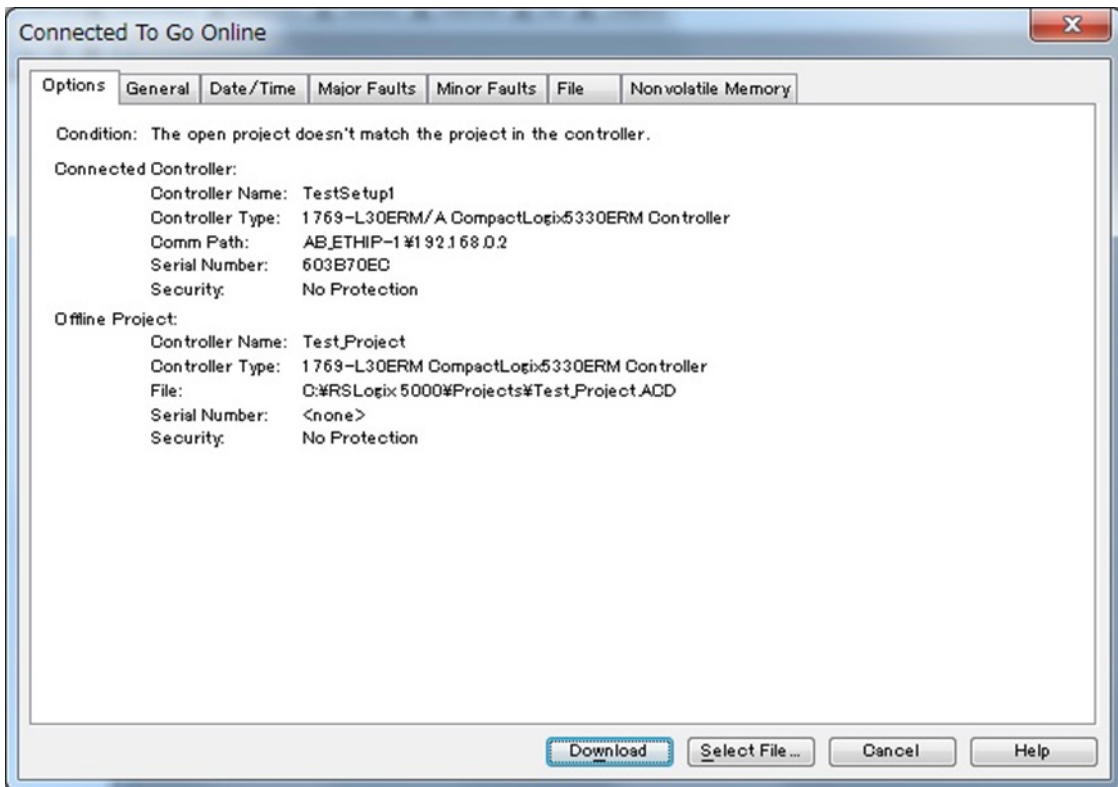

- (7) On the “Download” dialog box, click “Download”.
Downloading a project is started.

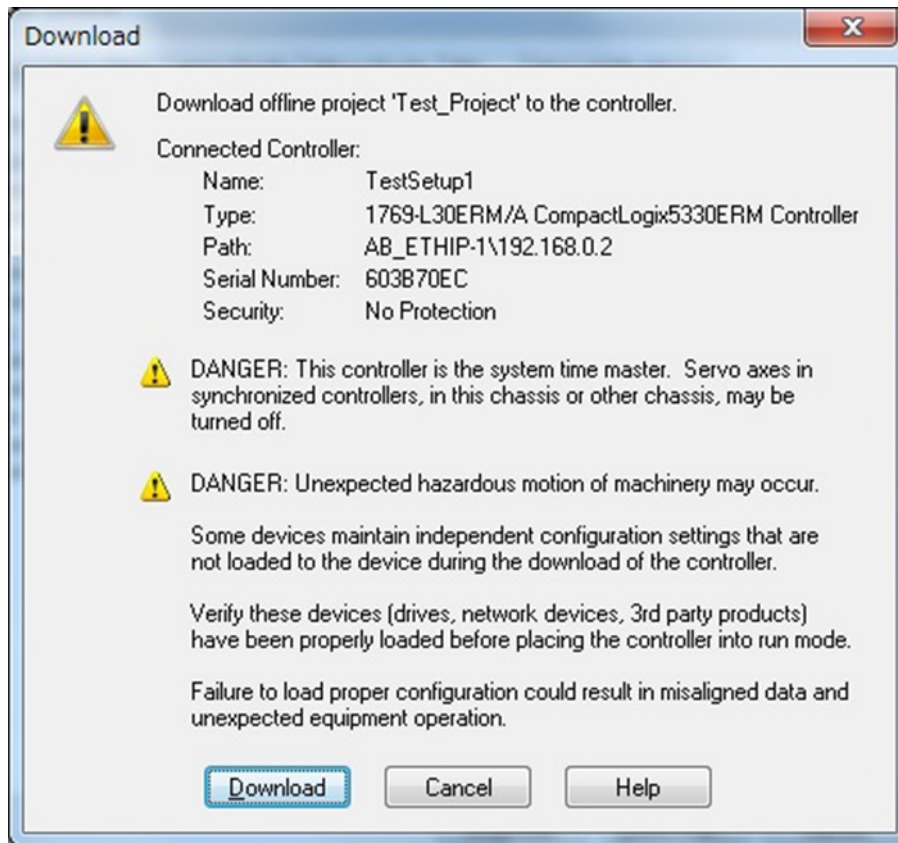

- (8) The following dialog box is displayed during downloading.
The dialog box closes when the download is completed.

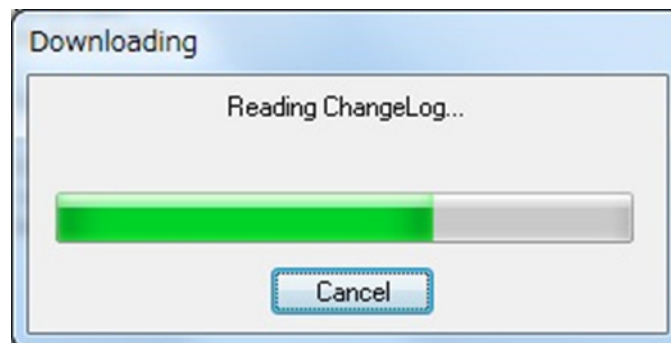

- (9) Save the project
From the “File” menu, click “Save” to save all configurations described above.

(10) Confirm “Controller tags”

Double-click the “Controller tags”.

On the “Controller Tags” dialog box, I/O information of NCW-3DNIP can be confirmed.

NCW-3DNIP can be accessed by the controller program.

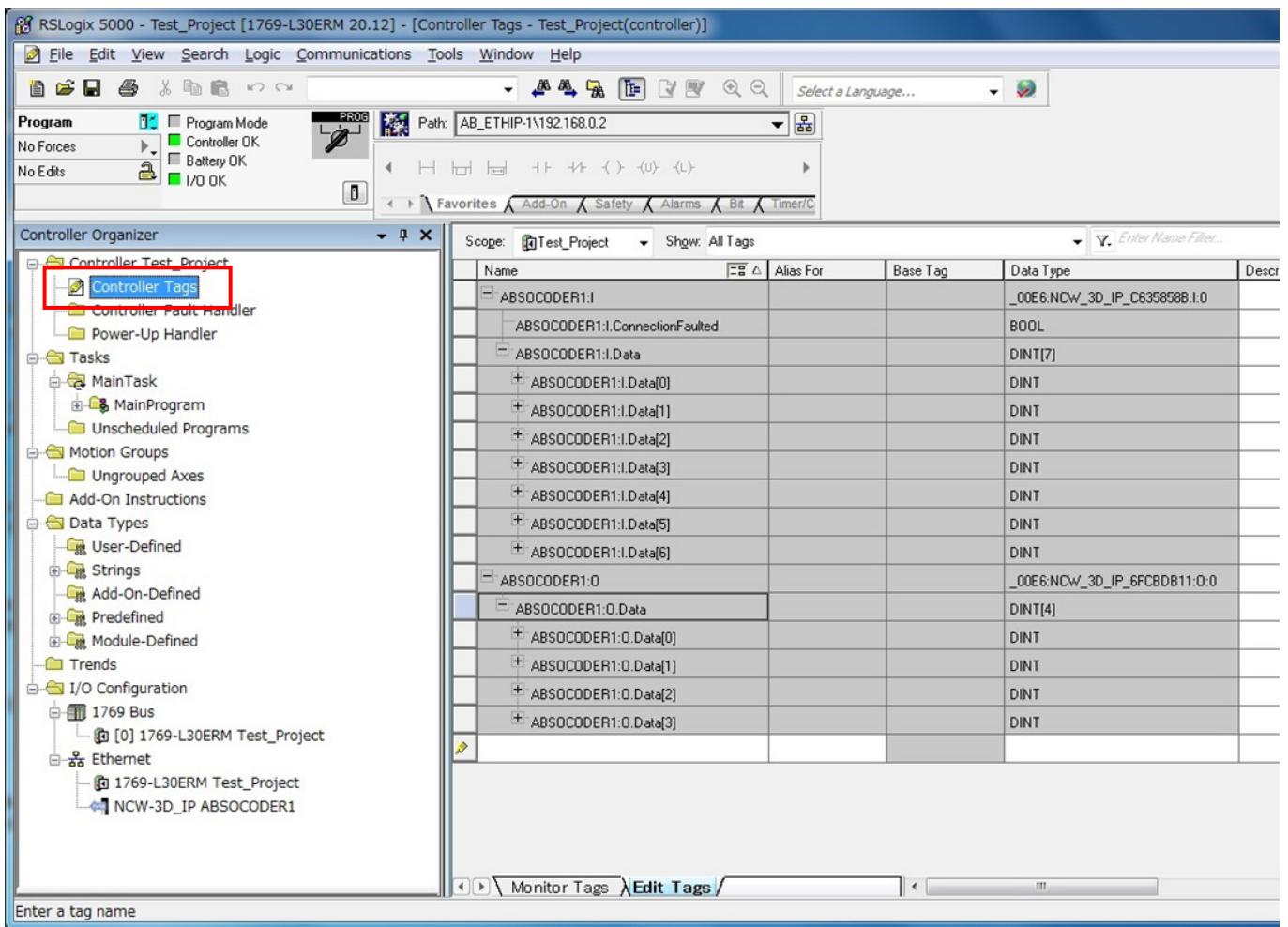

9-7. Set Parameter of NCW-3DHIP

Before NCW-3DNIP is used, parameters must be configured.



Note

In the case of using one sensor, NCW-3DNIP might not operate normally when the parameter is set by a configuration tool except RSNetWorx manufactured by Rockwell Automation, Inc.

In this case, set "1 (disable)" to "Axis Unavailable" of the axis-2 parameter, and use the axis-1 sensor connector (SENSOR 1).



Note

When setting parameters, switch the operation mode of the host PLC to program mode (PROG).

Cannot be set in run mode (RUN).

This operation is performed by using the PLC's configuration tool (a PLC development tool software).

*: Depending on the PLC model, this operation can also be performed by the mode selection switch on the CPU card.

9-7-1. Parameter List

NCW-3DNIP has following parameters.

Parameter setting values except a preset value are saved in the nonvolatile memory; therefore, NCW-3DNIP can operate with previous designated parameters after turning on the power supply again.

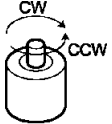
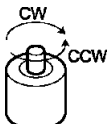
Axis	Parameters	ABSOCODER Object (Class ID: 0x64)		Descriptions
		Instance ID	Attribute ID	
For axis-1 sensor	Axis Unavailable	0x01	0x64	Specify "Enable" or "Disable" for the axis. 0: Enable (Default) 1: Disable
	Error Clear	0x01	0x65	Specify "Error recovery behavior". 0: Auto clearing (Default) Automatically clears the error when removing the cause of the error. 1: Manual clearing
	Position Data Increase Direction	0x01	0x0C	Specify the ABSOCODER sensor rotation direction in which the position data increases. 0: CW (Default) 1: CCW 
	Preset Value	0x01	0x13	Specify "Preset Value". Axis-1 current position value is changed to a value which is specified at this parameter after setting it. NOTE The setting value is deleted and reset to the initial value "0" when restarting the power supply or resetting the device.
For axis-2 sensor	Axis Unavailable	0x02	0x64	Specify "Enable" or "Disable" for the axis. 0: Enable (Default) 1: Disable
	Error Clear	0x02	0x65	Specify "Error recovery behavior". 0: Auto clearing (Default) Automatically clears the error when removing the cause of the error. 1: Manual clearing
	Position Data Increase Direction	0x02	0x0C	Specify the ABSOCODER sensor rotation direction in which the position data increases. 0: CW (Default) 1: CCW 
	Preset Value	0x02	0x13	Specify "Preset Value". Axis-2 current position value is changed to a value which is specified at this parameter after setting it. NOTE The setting value is deleted and reset to the initial value "0" when restarting the power supply or resetting the device.

9-7-2. Parameters Setting Procedure

Use the RSNetWorx software to set parameters.

NCW-3DNIP (after the version 2.01) can set parameters by using the web server function.

Products with the software version mark put on the products panel after "B" support this function.

Refer to "8-1." for the version mark

(Refer to "APPENDIX 3" for the web server function.)

In this section, setting procedures of the parameters are described below.

(1) Start RSNetWorx software

(2) Go online

Click "Online"

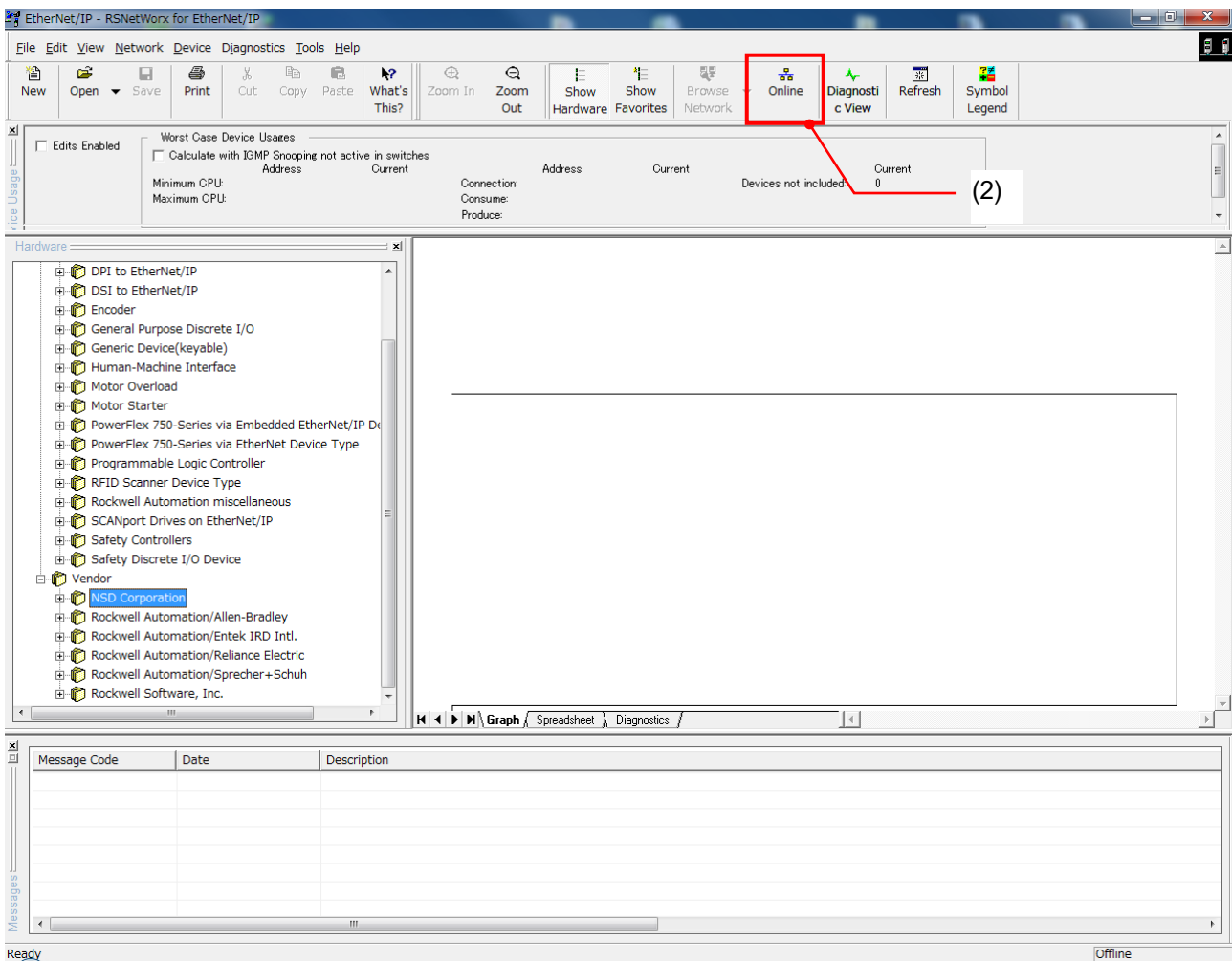

(3) Browse Network

On the “Browse for Network” dialog box, choose a desired network.

(4) Click “OK”.

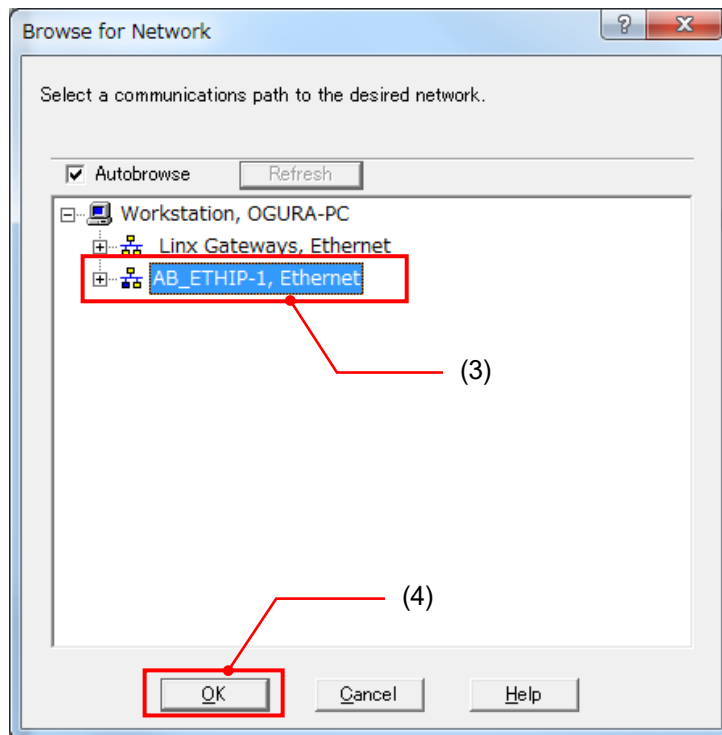

(5) On the “Browsing network...” dialog box, the progress of searching network is shown.

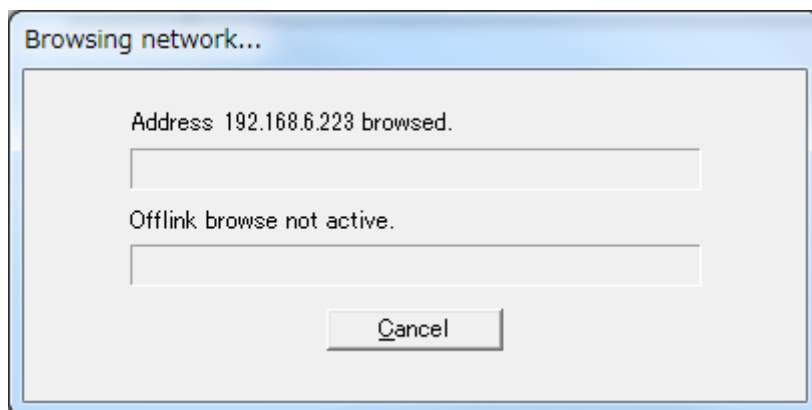

(6) Confirm your network device

The configured devices are indicated in network.

Confirms the network at which the controller (1769-L30ERM/A CompactLogix5330ERM) is connected to NCW-3DNIP.

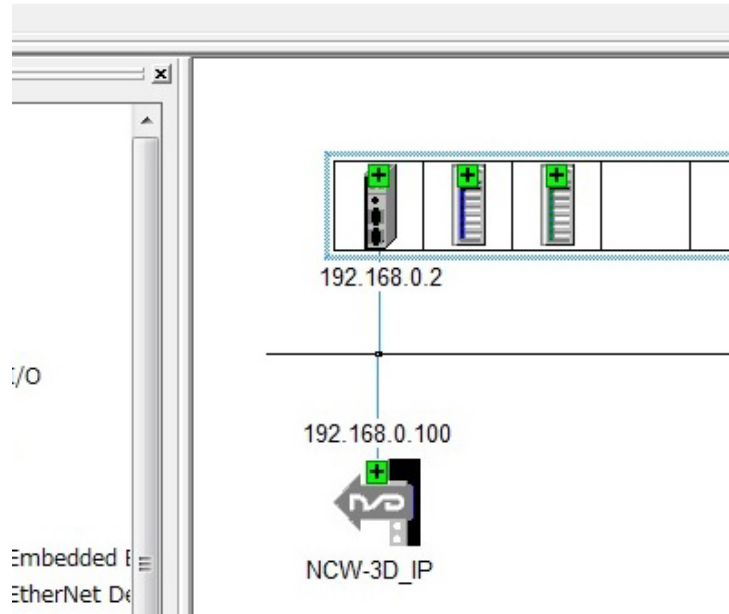

(7) Start "Class Instance Editor"

Right-click NCW-3DNIP, and choose "Class Instance Editor".

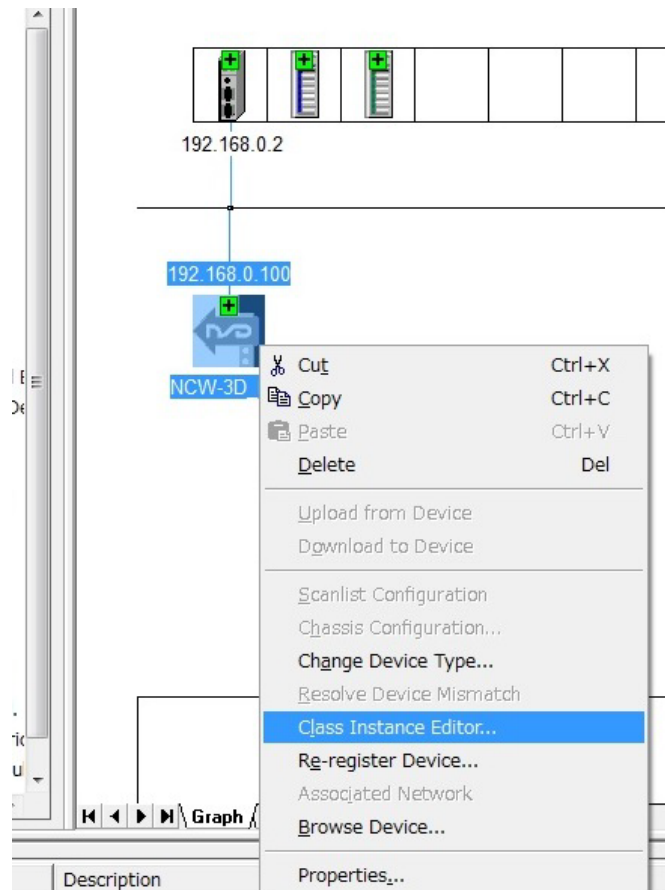

(8) Confirm the WARNING on “Class Instance Editor” dialog box, and click “Yes”.

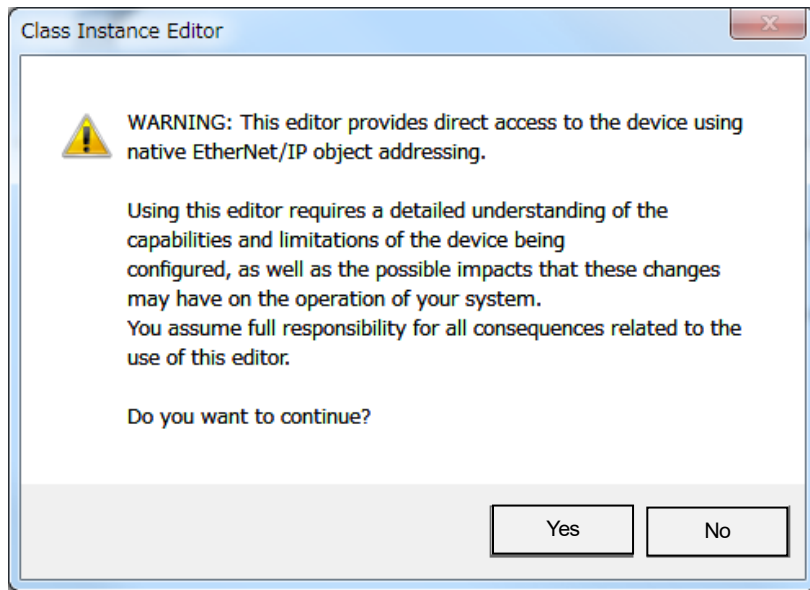

(9) Set the parameter

There are parameters which are for axis-1 and axis-2.

Set the following contents.

A) Position Data Increase Direction

- B) Axis Unavailable
- C) Error Clear

B) and C) usually don't need to be set. Set them if you need.

For the setting, enter the setting values from (a) to (f) in the dialog "Class Instance Editor", and click the "Execute" button.

	Items	Values	Remarks
(a)	Service Code	Set Single Attribute	Service code for the attribute
(b)	Object Address Class (Class ID)	0x64	ABSOCODER Object
(c)	Object Address Instance (Instance ID)	0x01	Instance: for axis-1
		0x02	Instance: for axis-2
(d)	Object Address Attribute (Attribute ID)	0x0C	Attribute: Position Data Increase Direction
		0x64	Attribute: Axis Unavailable
		0x65	Attribute: Error Clear
(e)	Transmit data size	Byte	1Byte
(f)	Data sent to the device	0x0 or 0x1	Enters the parameter setting value (0 or 1).

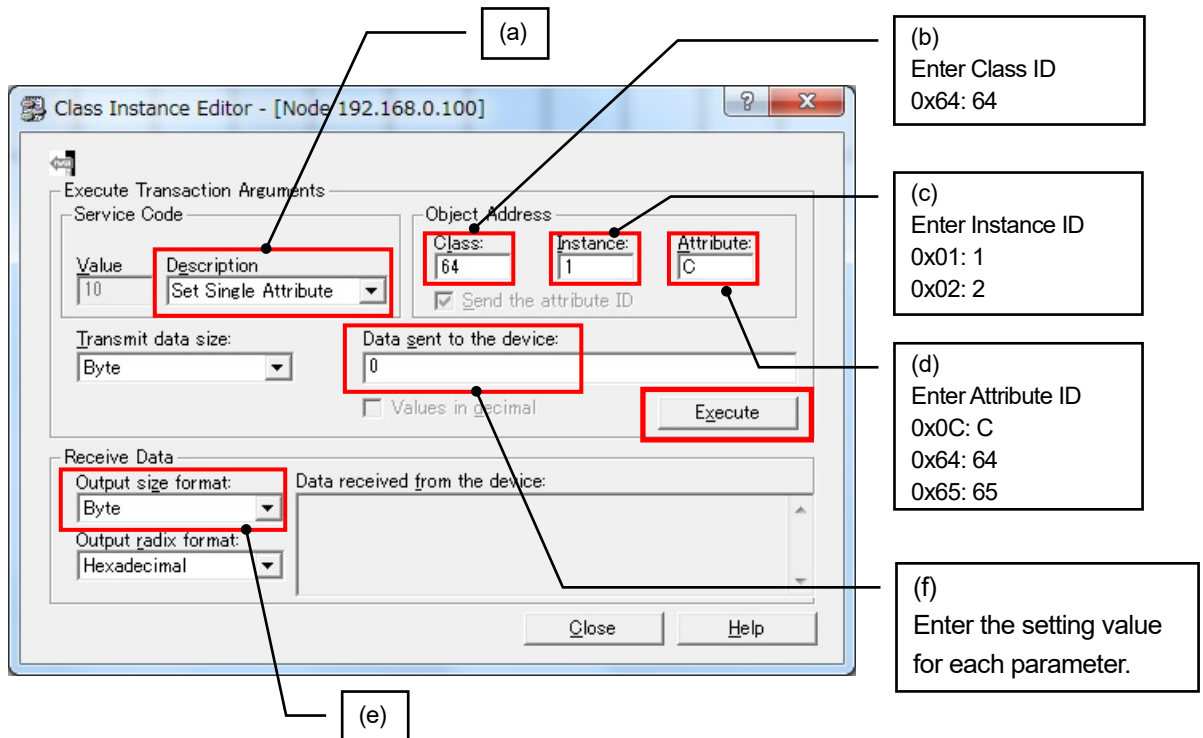

(10) Confirm "Position Data Increase Direction" setting

"The execution was completed." is displayed in the "Data received from the device" field when "Position Data Increase Direction" is set correctly. Confirm both axes.

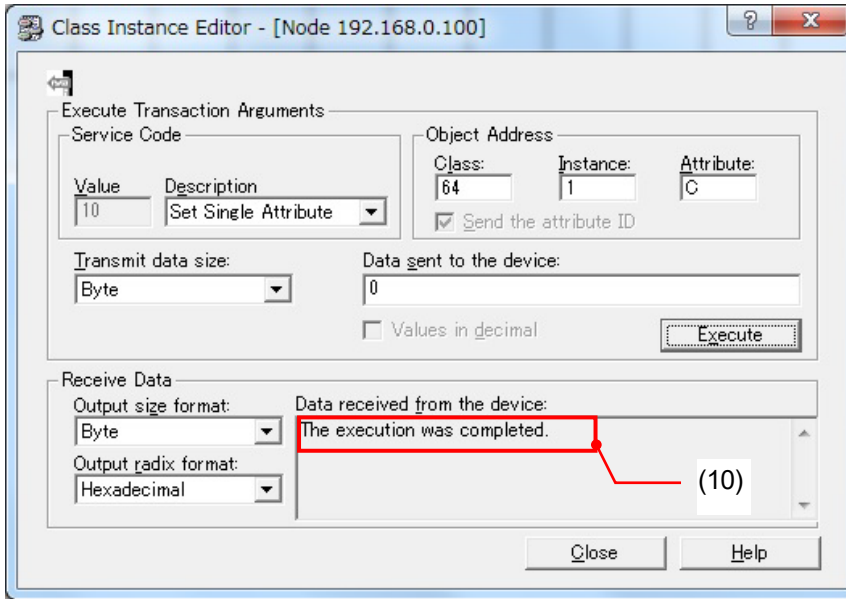

(11) Specify "Preset Value"

"Preset Value" is specified to each two settings (for axis-1 and for axis-2).

Enter a setting value in "Class Instance Editor" dialog box, and click the "Execute" button.

Items	Values	Remarks
Service Code	Set Single Attribute	Service code for the attribute
Object Address Class	0x64	ABSOCODER Object
Object Address Instance	0x01	Instance: for axis-1
	0x02	Instance: for axis-2
Object Address Attribute	0x13	Attribute: Preset Value
Transmit data size	DINT	4Byte
Data sent to the device	0x00000000	A value of "Values" is indicated as an example when "Preset Value" is set to "0".

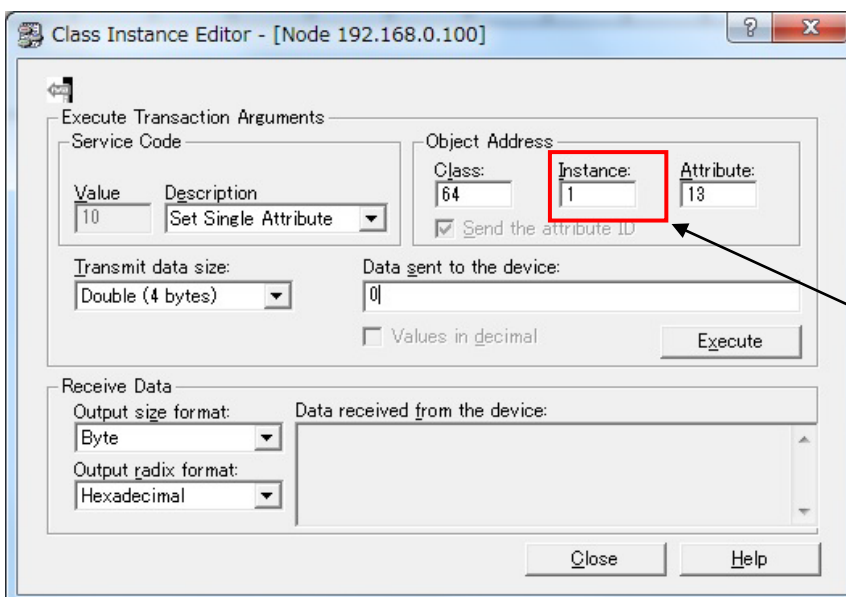

A setting value for axis-1 is different from for axis-2.
For axis-1: 1 (0x01)
For axis-1: 2 (0x02)

(12) Confirm "Preset Value"

"The execution was completed." is displayed in the "Data received from the device" field when "Preset Value" is set correctly. Confirm both axes.

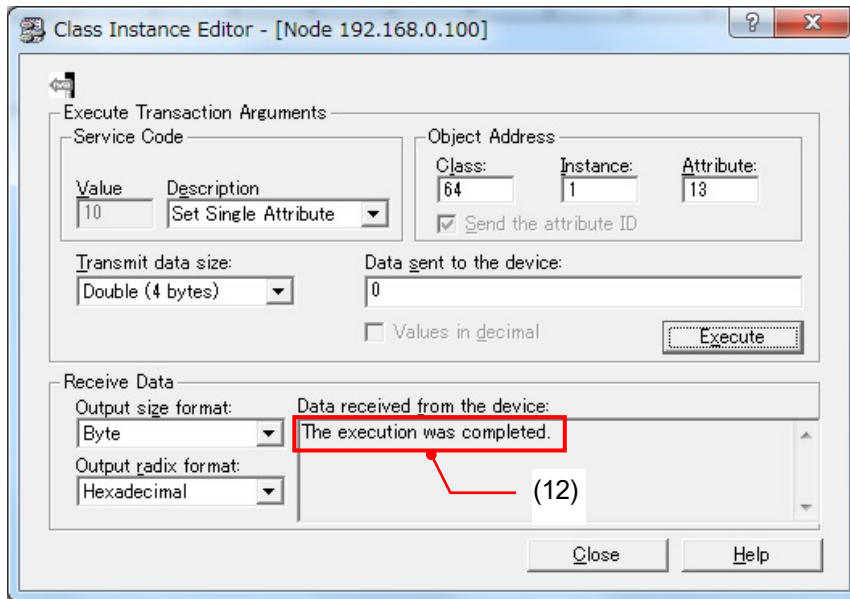

9-8. Confirm Position Data of NCW-3DNIP

All settings are completed, and NCW-3DNIP is ready to use.

Double-click the “Controller tags” of RSLogix5000.

The “Controller Tags” dialog box appears.

The position data can be confirmed by the tag of NCW-3DNIP.

The tags which indicate each position data are as follows.

Axis-1 Position Data → ABSOCODER1:I:Data[1]

Axis-2 Position Data → ABSOCODER1:I:Data[4]

The screenshot shows the RSLogix 5000 software interface. The 'Controller Tags' folder is selected in the left-hand 'Controller Organizer' pane. The main window displays a list of tags for the 'ABSOCODER1:I:Data' object. The tags are listed in a table with columns for Name, Value, Force Mask, Style, and Data Type.

Name	Value	Force Mask	Style	Data Type
ABSOCODER1:I:Data[0]	16#0000_0000		Hex	DINT
ABSOCODER1:I:Data[1]	16#0001_fdf9		Hex	DINT
ABSOCODER1:I:Data[2]	16#0000_0000		Hex	DINT
ABSOCODER1:I:Data[3]	16#0000_0000		Hex	DINT
ABSOCODER1:I:Data[4]	16#0001_f8d6		Hex	DINT
ABSOCODER1:I:Data[5]	16#0000_0000		Hex	DINT
ABSOCODER1:I:Data[6]	16#0000_0021		Hex	DINT

At the bottom of the window, there is a status bar with the text 'Enter display style for the value' and a button labeled 'Monitor Tags / Edit Tags'.

9-9. CIP Implicit Messaging (I/O Connection)

NCW-3DNIP has the "Exclusive-Owner Connection" for the unicast connection which can connect with the real-time I/O communication connection. It lets control the I/O data of NCW-3DNIP.

The connection summary and data format are described below.

9-9-1. Exclusive-Owner Connection

(1) Connection Attribute

Item		Description
Transport Type		Client , Exclusive-Owner
Transport Class		1
Production Trigger		Cyclic
Scanner -> Slave (Output)	Size	16Byte
	Realtime Transfer Format	32bit Run/Idle Header
	Connection Type	Point to Point
	Priority	High
	RPI	20ms (min.: 2ms, max.: 100ms)
Slave -> Scanner (Input)	Size	28Byte
	Realtime Transfer Format	Modeless
	Connection Type	Point to Point
	Priority	High
	RPI	20ms (min.: 2ms, max.: 100ms)
Configuration	Size	0Byte
Connection Name		"Input / Output / Configuration"
Help String		"Exclusive-Owner"
Connection Path		20 04 24 67 2C 66 2C 65

(2) Scanner -> Slave (Output) Data Format (Size: 16-byte)

Offset Address (Byte)	Data Format												
	Size	Name	Description										
+0	WORD	Axis-1 Control	<table border="1"> <thead> <tr> <th>Bit</th> <th>Description</th> </tr> </thead> <tbody> <tr> <td>0-5</td> <td>Reserved</td> </tr> <tr> <td>6</td> <td>ERRCLR (Error Clear Command) Clears an error that is monitored from Axis-1 Status. 0: Not clear an error 1: Clear an error</td> </tr> <tr> <td>7</td> <td>PRESET (Preset Command) Presets a position data for Axis-1. Specify "1: Execute PRESET" after setting the preset value for Axis-1. 0: Unexecute PRESET 1: Execute PRESET</td> </tr> <tr> <td>8-15</td> <td>Reserved</td> </tr> </tbody> </table>	Bit	Description	0-5	Reserved	6	ERRCLR (Error Clear Command) Clears an error that is monitored from Axis-1 Status. 0: Not clear an error 1: Clear an error	7	PRESET (Preset Command) Presets a position data for Axis-1. Specify "1: Execute PRESET" after setting the preset value for Axis-1. 0: Unexecute PRESET 1: Execute PRESET	8-15	Reserved
Bit	Description												
0-5	Reserved												
6	ERRCLR (Error Clear Command) Clears an error that is monitored from Axis-1 Status. 0: Not clear an error 1: Clear an error												
7	PRESET (Preset Command) Presets a position data for Axis-1. Specify "1: Execute PRESET" after setting the preset value for Axis-1. 0: Unexecute PRESET 1: Execute PRESET												
8-15	Reserved												
+2	WORD	Reserved	—										
+4	UDINT	Axis-1 PresetValue	Axis-1 Preset Value Sets the preset value for Axis-1. Set any value to the preset before operating the Bit7 (PRESET) of Axis-1 control flag.										
+8	WORD	Axis-2 Control	<table border="1"> <thead> <tr> <th>Bit</th> <th>Description</th> </tr> </thead> <tbody> <tr> <td>0-5</td> <td>Reserved</td> </tr> <tr> <td>6</td> <td>ERRCLR (Error Clear Command) Clears an error that is monitored from Axis-2 Status. 0: Not clear an error 1: Clear an error</td> </tr> <tr> <td>7</td> <td>PRESET (Preset Command) Presets a position data for Axis-2. Specify "1: Execute PRESET" after setting the preset value for Axis-2. 0 : Unexecute PRESET 1 : Execute PRESET</td> </tr> <tr> <td>8-15</td> <td>Reserved</td> </tr> </tbody> </table>	Bit	Description	0-5	Reserved	6	ERRCLR (Error Clear Command) Clears an error that is monitored from Axis-2 Status. 0: Not clear an error 1: Clear an error	7	PRESET (Preset Command) Presets a position data for Axis-2. Specify "1: Execute PRESET" after setting the preset value for Axis-2. 0 : Unexecute PRESET 1 : Execute PRESET	8-15	Reserved
Bit	Description												
0-5	Reserved												
6	ERRCLR (Error Clear Command) Clears an error that is monitored from Axis-2 Status. 0: Not clear an error 1: Clear an error												
7	PRESET (Preset Command) Presets a position data for Axis-2. Specify "1: Execute PRESET" after setting the preset value for Axis-2. 0 : Unexecute PRESET 1 : Execute PRESET												
8-15	Reserved												
+10	WORD	Reserved	—										
+12	UDINT	Axis-2 PresetValue	Axis-2 Preset Value Sets the preset value for Axis-2. Set any value to the preset before operating the Bit7 (PRESET) of Axis-2 control flag.										

(3) Slave -> Scanner (Input) Data Format (Size: 28-byte)

Offset Address (Byte)	Data Format																		
	Size	Name	Description																
+0	DWORD	System Status	<table border="1"> <thead> <tr> <th colspan="2">NCW-3DNIP Diagnosis Status</th> </tr> <tr> <th>Bit</th> <th>Description</th> </tr> </thead> <tbody> <tr> <td>0</td> <td>NRDY (Internal Error) Indicates that an internal error of NCW-3DNIP occurred. The hardware might have malfunction if the converter doesn't operate normally after restarting the power supply. Replace NCW-3DNIP. 0: Normal 1: Error</td> </tr> <tr> <td>1</td> <td>WDTE (Watchdog Timer Error) Indicates a watchdog timer error of NCW-3DNIP. 0: Normal 1: Error</td> </tr> <tr> <td>2</td> <td>ME (Memory Error) Indicates that the internal memory (FRAM) of NCW-3DNIP is malfunction. 0: Normal 1: Error</td> </tr> <tr> <td>3-7</td> <td>Reserved</td> </tr> <tr> <td>8</td> <td>I/F ERR (Internal I/F Error) Indicates that the internal I/F circuit has an error. 0: No error 1: Error</td> </tr> <tr> <td>9-31</td> <td>Reserved</td> </tr> </tbody> </table>	NCW-3DNIP Diagnosis Status		Bit	Description	0	NRDY (Internal Error) Indicates that an internal error of NCW-3DNIP occurred. The hardware might have malfunction if the converter doesn't operate normally after restarting the power supply. Replace NCW-3DNIP. 0: Normal 1: Error	1	WDTE (Watchdog Timer Error) Indicates a watchdog timer error of NCW-3DNIP. 0: Normal 1: Error	2	ME (Memory Error) Indicates that the internal memory (FRAM) of NCW-3DNIP is malfunction. 0: Normal 1: Error	3-7	Reserved	8	I/F ERR (Internal I/F Error) Indicates that the internal I/F circuit has an error. 0: No error 1: Error	9-31	Reserved
NCW-3DNIP Diagnosis Status																			
Bit	Description																		
0	NRDY (Internal Error) Indicates that an internal error of NCW-3DNIP occurred. The hardware might have malfunction if the converter doesn't operate normally after restarting the power supply. Replace NCW-3DNIP. 0: Normal 1: Error																		
1	WDTE (Watchdog Timer Error) Indicates a watchdog timer error of NCW-3DNIP. 0: Normal 1: Error																		
2	ME (Memory Error) Indicates that the internal memory (FRAM) of NCW-3DNIP is malfunction. 0: Normal 1: Error																		
3-7	Reserved																		
8	I/F ERR (Internal I/F Error) Indicates that the internal I/F circuit has an error. 0: No error 1: Error																		
9-31	Reserved																		
+4	UDINT	Axis-1 Position	Axis-1 Position data Shows the Axis-1 Position data.																
+8	UDINT	Reserved	Reserved																
+12	WORD	Axis-1 Status	<table border="1"> <thead> <tr> <th colspan="2">Axis-1 Status</th> </tr> <tr> <th>Bit</th> <th>Description</th> </tr> </thead> <tbody> <tr> <td>0</td> <td>SE (Sensor Error) Indicates that a SSE/SPF/DE occurred. 0: No error 1: Error</td> </tr> <tr> <td>1-4</td> <td>Reserved</td> </tr> <tr> <td>5</td> <td>SSE (Disconnected Sensor Error) Indicates that a sensor is disconnected. 0: Connected 1: Disconnected (Error)</td> </tr> <tr> <td>6</td> <td>SPF (Sensor Circuit Power Error) Indicates that the internal power supply of NCW-3DNIP is malfunction. 0: Normal 1: Error</td> </tr> <tr> <td>7</td> <td>DE (Sensor Data Error) Indicates "DE" status. 0: No error 1: Error</td> </tr> <tr> <td>8-15</td> <td>Reserved</td> </tr> </tbody> </table>	Axis-1 Status		Bit	Description	0	SE (Sensor Error) Indicates that a SSE/SPF/DE occurred. 0: No error 1: Error	1-4	Reserved	5	SSE (Disconnected Sensor Error) Indicates that a sensor is disconnected. 0: Connected 1: Disconnected (Error)	6	SPF (Sensor Circuit Power Error) Indicates that the internal power supply of NCW-3DNIP is malfunction. 0: Normal 1: Error	7	DE (Sensor Data Error) Indicates "DE" status. 0: No error 1: Error	8-15	Reserved
Axis-1 Status																			
Bit	Description																		
0	SE (Sensor Error) Indicates that a SSE/SPF/DE occurred. 0: No error 1: Error																		
1-4	Reserved																		
5	SSE (Disconnected Sensor Error) Indicates that a sensor is disconnected. 0: Connected 1: Disconnected (Error)																		
6	SPF (Sensor Circuit Power Error) Indicates that the internal power supply of NCW-3DNIP is malfunction. 0: Normal 1: Error																		
7	DE (Sensor Data Error) Indicates "DE" status. 0: No error 1: Error																		
8-15	Reserved																		
+14	WORD	Axis-1 Control Answerback	<table border="1"> <thead> <tr> <th colspan="2">Axis-1 Control Flag Answerback</th> </tr> <tr> <th>Bit</th> <th>Description</th> </tr> </thead> <tbody> <tr> <td>0-5</td> <td>Reserved</td> </tr> <tr> <td>6</td> <td>ERRCLR (Error Clear) Answerback 0: "ERRCLR" failed. 1: "ERRCLR" succeeded</td> </tr> <tr> <td>7</td> <td>PRESET Answerback 0: "PRESET" failed 1: "PRESET" succeeded.</td> </tr> <tr> <td>8-15</td> <td>Reserved</td> </tr> </tbody> </table>	Axis-1 Control Flag Answerback		Bit	Description	0-5	Reserved	6	ERRCLR (Error Clear) Answerback 0: "ERRCLR" failed. 1: "ERRCLR" succeeded	7	PRESET Answerback 0: "PRESET" failed 1: "PRESET" succeeded.	8-15	Reserved				
Axis-1 Control Flag Answerback																			
Bit	Description																		
0-5	Reserved																		
6	ERRCLR (Error Clear) Answerback 0: "ERRCLR" failed. 1: "ERRCLR" succeeded																		
7	PRESET Answerback 0: "PRESET" failed 1: "PRESET" succeeded.																		
8-15	Reserved																		

Continued from the previous page

Offset Address (Byte)	Data Format																
	Size	Name	Description														
+16	UDINT	Axis-2 Position	Axis-2 Position data Shows the Axis-2 Position data.														
+20	UDINT	Reserved	Reserved														
+24	WORD	Axis-2 Status	<table border="1"> <thead> <tr> <th>Bit</th> <th>Description</th> </tr> </thead> <tbody> <tr> <td>0</td> <td>SE (Sensor Error) Indicates that a SSE/SPF/DE occurred. 0: No error 1: Error</td> </tr> <tr> <td>1-4</td> <td>Reserved</td> </tr> <tr> <td>5</td> <td>SSE (Disconnected Sensor Error) Indicates that a sensor is disconnected. 0: Connected 1: Disconnected (Error)</td> </tr> <tr> <td>6</td> <td>SPF (Sensor Circuit Power Error) Indicates that the internal power supply of NCW-3DNIP is malfunction. 0: Normal 1: Error</td> </tr> <tr> <td>7</td> <td>DE (Sensor Data Error) Indicates "DE" status. 0: No error 1: Error</td> </tr> <tr> <td>8-15</td> <td>Reserved</td> </tr> </tbody> </table>	Bit	Description	0	SE (Sensor Error) Indicates that a SSE/SPF/DE occurred. 0: No error 1: Error	1-4	Reserved	5	SSE (Disconnected Sensor Error) Indicates that a sensor is disconnected. 0: Connected 1: Disconnected (Error)	6	SPF (Sensor Circuit Power Error) Indicates that the internal power supply of NCW-3DNIP is malfunction. 0: Normal 1: Error	7	DE (Sensor Data Error) Indicates "DE" status. 0: No error 1: Error	8-15	Reserved
Bit	Description																
0	SE (Sensor Error) Indicates that a SSE/SPF/DE occurred. 0: No error 1: Error																
1-4	Reserved																
5	SSE (Disconnected Sensor Error) Indicates that a sensor is disconnected. 0: Connected 1: Disconnected (Error)																
6	SPF (Sensor Circuit Power Error) Indicates that the internal power supply of NCW-3DNIP is malfunction. 0: Normal 1: Error																
7	DE (Sensor Data Error) Indicates "DE" status. 0: No error 1: Error																
8-15	Reserved																
+26	WORD	Axis-2 Control Answerback	<table border="1"> <thead> <tr> <th>Bit</th> <th>Description</th> </tr> </thead> <tbody> <tr> <td>0-5</td> <td>Reserved</td> </tr> <tr> <td>6</td> <td>ERRCLR (Error Clear) Answerback 0: "ERRCLR" failed. 1: "ERRCLR" succeeded</td> </tr> <tr> <td>7</td> <td>PRESET Answerback 0: "PRESET" failed 1: "PRESET" succeeded.</td> </tr> <tr> <td>8-15</td> <td>Reserved</td> </tr> </tbody> </table>	Bit	Description	0-5	Reserved	6	ERRCLR (Error Clear) Answerback 0: "ERRCLR" failed. 1: "ERRCLR" succeeded	7	PRESET Answerback 0: "PRESET" failed 1: "PRESET" succeeded.	8-15	Reserved				
Bit	Description																
0-5	Reserved																
6	ERRCLR (Error Clear) Answerback 0: "ERRCLR" failed. 1: "ERRCLR" succeeded																
7	PRESET Answerback 0: "PRESET" failed 1: "PRESET" succeeded.																
8-15	Reserved																

(4) Preset procedure

Indicates PRESET procedure of the current position value which is using the I/O communication data (Implicit message).

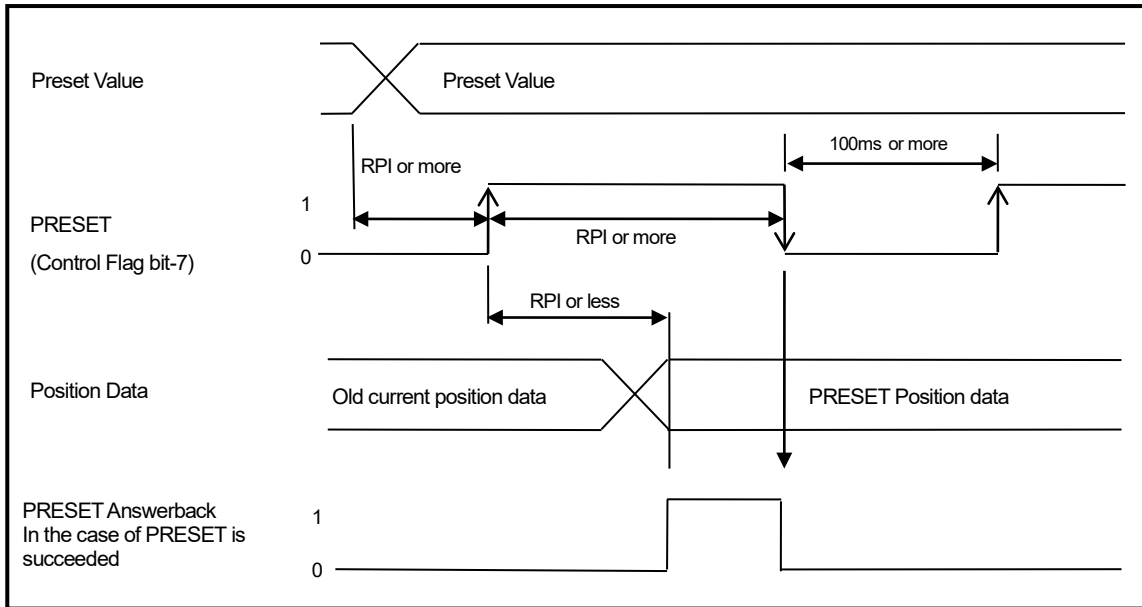

● PRESET procedure

- ① Set a desired Preset Value.
- ② Set the value "1" to PRESET (bit 7 of the control flag).
At this time, the PRESET (bit 7 of the control flag) should be kept setting to "1" in a period of RPI or more.
- ③ "1" is returned to the PRESET Answerback if the PRESET is executed correctly.
"0" is returned to the PRESET Answerback if an error (NRDY or SE) occurs.
- ④ The PRESET (bit 7 of the control flag) must be reset to "0".
At this time, the PRESET Answerback is reset to "0".

(5) Error clear procedure

Indicates the error clear procedure by using the I/O communication data (Implicit message).

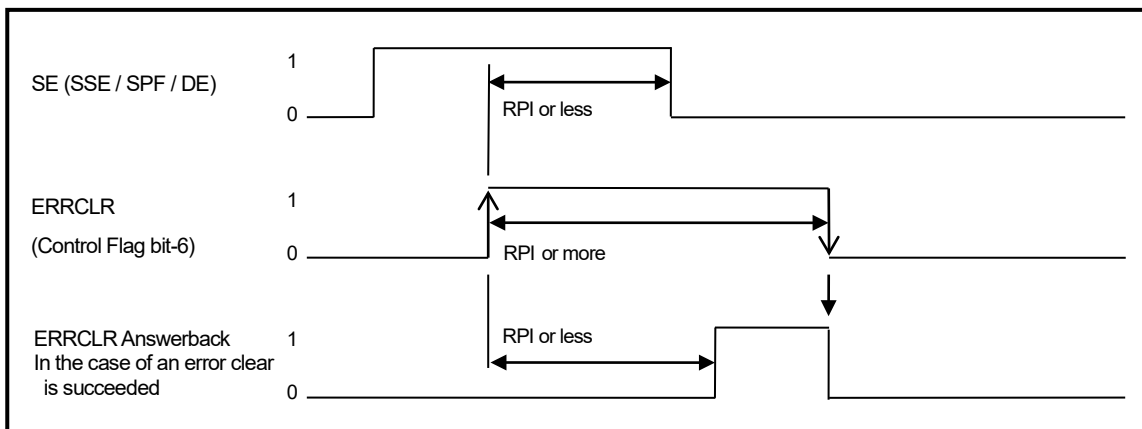

● Error clear procedure

- ① The ERRCLR (control flag bit 6) should be set to "1" after clearing an error cause.
At this time, the ERRCLR (control flag bit 6) should be kept setting to "1" in a period of RPI or more.
- ② "1" is returned to the ERRCLR Answerback if the error clear is executed correctly.
- ③ The ERRCLR (control flag bit 6) must be reset to "0".
At this time, the ERRCLR Answerback is reset to "0".

9-10. Device Level Ring (DLR) Function

NCW-3DNIP can be used as a ring node for device level ring (DLR) function.

All ring nodes on the network must support DLR function when using this function.

All settings of DLR function are done by "Supervisor node". NCW-3DNIP doesn't need any setting.

Refer to the "Supervisor node manual in-use" for the network setting and operation methods with using DLR function.

The device level ring (DLR) function was supported after version 2.01.

Products with the software version mark put on the products panel after "B" support.

Refer to "8-1." for the version mark.

10. INSPECTION

The inspection should be conducted once every 6 months to a year.

Any inspected items which do not satisfy the criteria shown below should be repaired

Inspection item	Inspection Description	Criteria	Remark
Power supply	Measure the voltage fluctuation at the power supply terminal block of the converter to determine if it is within the prescribed range.	Within 21.6V to 26.4VDC range	Tester
Ambient Conditions	Check the ambient temperature.	ABSOCODER sensor: -20 to +60°C Converter: 0 to +55°C	Thermometer
	There should be no accumulation of dust.	None	Visual Inspection
Mount Conditions	Verify that the sensor is securely mounted.	There should be no looseness.	
	Verify that the sensor shaft is securely coupled to the machine shaft.	There should be no looseness.	
	Check for severed cables.	Cable should appear normal.	
	Verify that the sensor cable connector is plugged in all the way.	There should be no looseness.	
	Verify that the LAN cable connector is plugged in all the way.	There should be no looseness.	

11. TROUBLE SHOOTING

Explains each error which is detected by NCW-3DNIP.

11-1. Check Methods during an Error Is Occurred

Error details can be checked by the indicator light status of NCW-3DNIP or using the following software (RSLogix5000 or RSNetWorx).

- ① Each status in Implicit (Input) message
(Use RSLogix5000)
- ② Instance 0x01 and 0x02 of the ABSOCODER object 0x64 in the Explicit message
(Use RSNetWorx)
- ③ Instance 0x01 of the Info Log object 0xC5 in the Explicit message
(Use RSNetWorx)
- ④ Instance 0x01 of the Info Diagnosis object 0xC6 in the Explicit message
(Use RSNetWorx)

For the methods for checking each error on the scanner system (master), refer to the scanner system manual.

11-2. Measures when a Communication Error Occurs

Explains general error causes because of unstable communication and measures.

At first, check the following basic causes;

- The communication cable is connected correctly or not.
- The communication cable is served or not.
- Connectors of the communication cable is connected or not.
- The length of the communication cable connected with NCW-3DNIP is 100m or less.
- The communication cable is category 5e specification.
- The Ethernet/IP scanner (master) operates normally.

Check the following secondary causes if the above causes aren't applied.

- The communication cable isn't affected by noises.
- Appropriate distance should be kept between the communication cable and power supply cable.

After checking the above items, retry to communicate with NCW-3DNIP from the Ethernet/IP scanner (master). NCW-3DNIP might be failure if only NCW-3DNIP cannot be communicated through the Ethernet/IP network. Check the light status of the NCW-3DNIP indicators (L/A1, L/A2).

11-3. CIP General Status Code

The following table lists the Status Codes that may be present in the General Status Code field of an Error Response message.

Note that the Extended Code Field is available for use in further describing any General Status Code. For the Extended Status code, refer to “11-4.”

Codes in the gray area aren't available NCW-3DNIP.

(1/3)

General Status Code (in hex)	Status Name	Description of Status
00	Success	Service was successfully performed by the object specified.
01	Connection failure	A connection related service failed along the connection path.
02	Resource unavailable	Resources needed for the object to perform the requested service were unavailable.
03	Invalid parameter value	See Status Code 0x20, which is the preferred value to use for this condition.
04	Path segment error	The path segment identifier or the segment syntax was not understood by the processing node. Path processing shall stop when a path segment error is encountered.
05	Path destination unknown	The path is referencing an object class, instance or structure element that is not known or is not contained in the processing node. Path processing shall stop when a path destination unknown error is encountered.
06	Partial transfer	Only part of the expected data was transferred.
07	Connection lost	The messaging connection was lost.
08	Service not supported	The requested service was not implemented or was not defined for this Object Class/Instance.
09	Invalid attribute value	Invalid attribute data detected.
0A	Attribute list error	An attribute in the Get_Attribute_List or Set_Attribute_List response has a non-zero status.
0B	Already in requested mode/state	The object is already in the mode/state being requested by the service.
0C	Object state conflict	The object cannot perform the requested service in its current mode/state.
0D	Object already exists	The requested instance of object to be created already exists.
0E	Attribute not settable	A request to modify a nonmodifiable attribute was received.
0F	Privilege violation	A permission/privilege check failed.
10	Device state conflict	The device's current mode/state prohibits the execution of the requested service.
11	Reply data too large	The data to be transmitted in the response buffer is larger than the allocated response buffer.
12	Fragmentation of a primitive value	The service specified an operation that is going to fragment a primitive data value, i.e. half a REAL data type.
13	Not enough data	The service did not supply enough data to perform the specified operation.
14	Attribute not supported	The attribute specified in the request is not supported.
15	Too much data	The service supplied more data than was expected.
16	Object does not exist	The object specified does not exist in the device.

General Status Code (in hex)	Status Name	Description of Status
17	Service fragmentation sequence not in progress	The fragmentation sequence for this service is not currently active for this data.
18	No stored attribute data	The attribute data of this object was not saved prior to the requested service.
19	Store operation failure	The attribute data of this object was not saved due to a failure during the attempt.
1A	Routing failure, request packet too large	The service request packet was too large for transmission on a network in the path to the destination. The routing device was forced to abort the service.
1B	Routing failure, response packet too large	The service response packet was too large for transmission on a network in the path from the destination. The routing device was forced to abort the service.
1C	Missing attribute list entry data	The service did not supply an attribute in a list of attributes that was needed by the service to perform the requested behavior.
1D	Invalid attribute value list	The service is returning the list of attributes supplied with status information for those attributes that were invalid.
1E	Embedded service error	An embedded service resulted in an error.
1F	Vendor specific error	A vendor specific error has been encountered. The Additional Code Field of the Error Response defines the particular error encountered. Use of this General Error Code should only be performed when none of the Error Codes presented in this table or within an Object Class definition accurately reflect the error.
20	Invalid parameter	A parameter associated with the request was invalid. This code is used when a parameter does not meet the requirements of this specification and/or the requirements defined in an Application Object Specification.
21	Write-once value or medium already written	An attempt was made to write to a write-once medium (e.g. WORM drive, PROM) that has already been written, or to modify a value that cannot be changed once established.
22	Invalid Reply Received	An invalid reply is received (e.g. reply service code does not match the request service code, or reply message is shorter than the minimum expected reply size). This status code can serve for other causes of invalid replies.
23	Buffer Overflow	The message received is larger than the receiving buffer can handle. The entire message was discarded.
24	Message Format Error	The format of the received message is not supported by the server.
25	Key Failure in path	The Key Segment that was included as the first segment in the path does not match the destination module. The object specific status shall indicate which part of the key check failed.
26	Path Size Invalid	The size of the path which was sent with the Service Request is either not large enough to allow the Request to be routed to an object or too much routing data was included.
27	Unexpected attribute in list	An attempt was made to set an attribute that is not able to be set at this time.
28	Invalid Member ID	The Member ID specified in the request does not exist in the specified Class/Instance/Attribute.
29	Member not settable	A request to modify a non-modifiable member was received.

General Status Code (in hex)	Status Name	Description of Status
2A	Group 2 only server general failure	This error code may only be reported by DeviceNet Group 2 Only servers with 4K or less code space and only in place of Service not supported, Attribute not supported and Attribute not settable.
2B	Unknown Modbus Error	A CIP to Modbus translator received an unknown Modbus Exception Code.
2C	Attribute not gettable	A request to read a non-readable attribute was received.
2D	Instance Not Deletable	The requested object instance cannot be deleted.
2E	Service Not Supported for Specified Path	The object supports the service, but not for the designated application path (e.g. attribute). NOTE: Not to be used for any set service (use General Status Code 0x0E or 0x29 instead)
2F ~ CF	Reserved	Reserved by CIP for future extensions.
D0 ~ F9	Reserved for Object Class specific errors	This range of error codes is to be used to indicate Object Class specific errors.
FA	Error in Function Call	Detected a CIP error in Function.
FB	Error from Lower Level(CIP)	Detected an error from lower level (CIP).
FC	Error from Lower Level(NET)	Detected an error from lower level (NET).
FD	Error from Lower Level(EPIC)	Detected an error from lower level (EPIC).
FE	Error from Lower Level(TCP)	Detected an error from lower level (TCP).
FF	Reserved for Object Class specific error	This error code is to be used to indicate Object Class specific errors.

11-4. CIP Extended Status Code

Status Codes may be present in the General Status and the Extended Status of an Error Response message.

11-4-1. Connection Manager Object Instance Extended Status Code

The error codes are returned with the response to a Connection Manager Service Request that resulted in an error. These error codes shall be used to help diagnose the problem with a Service Request. The error code shall be split into an 8 bit general status and one or more 8/16-bit words of extended status.

Codes in the gray area aren't available NCW-3DNIP.

(1) General Status Code: 01h (connection failure)

(1/3)

Extended Status Code (in hex)	Description of Status
0100	Connection in use or duplicate Forward Open
0101 - 0102	Reserved
0103	Transport Class and trigger combination not supported
0104 - 0105	Reserved
0106	Ownership conflict
0107	Target connection not found
0108	Invalid network connection parameter
0109	Invalid connection size
010A - 010F	Reserved
0110	Target for connection not configured
0111	RPI not supported.
0112	RPI value not acceptable
0113	Out of connections
0114	Vender ID or product code mismatch
0115	Device type mismatch
0116	Revision mismatch
0117	Invalid produced or consumed application path
0118	Invalid or inconsistent configuration application path
0119	Non-listen only connection not opened
011A	TARGET object out of connections
011B	The Production Inhibit Time is greater than the RPI
011C	Transport class not supported
011D	Target to originator production trigger not supported
011E	Direction not supported
011F	Invalid originator to target network connection fixvar
0120	Invalid target to originator network connection fixvar
0121	Invalid originator to target network connection priority
0122	Invalid target to originator network connection priority
0123	Invalid originator to target network connection type
0124	Invalid target to originator network connection type
0125	Invalid originator to target network connection redundant_owner
0126	Invalid configuration size

Extended Status Code (in hex)	Description of Status
0127	Invalid originator to target network connection size
0128	Invalid target to originator network connection size
0129	Invalid configuration application path
012A	Invalid consuming application path
012B	Invalid producing application path
012C	Configuration symbol does not exist
012D	Consuming symbol does not exist
012E	Producing symbol does not exist
012F	Inconsistent application path combination
0130	Inconsistent consume data format
0131	Inconsistent produce data format
0132	Null forward open function not supported
0133	Connection timeout multiplier not acceptable
0134 - 0202	Reserved
0203	Connection timed out
0204	Unconnected request timed out
0205	Parameter error in unconnected request service
0206	Message too large for unconnected_Send service
0207	Unconnected acknowledge without reply
0208 - 0300	Reserved
0301	No buffer memory available (Connection buffer memory shortage)
0302	Network bandwidth not available for data
0303	No consumed connection ID filter available
0304	Not configured to send scheduled priority data
0305	Schedule signature mismatch
0306	Schedule signature validation not possible
0307 - 0310	Reserved
0311	Port not available
0312	Link address not valid
0313 - 0314	Reserved
0315	Invalid segment in connection path
0316	Forward close service connection path mismatch
0317	Scheduling not specified
0318	Link address to self invalid
0319	Secondary resources unavailable
031A	Rack connection already established
031B	Module connection already established
031C	Miscellaneous (This extended status is returned when no other extended status code applies for a connection related error.)
031D	Redundant connection mismatch
031E	No more user configurable link consumer resources available in the producing module
031F	No user configurable link consumer resources configured in the producing module
0320	Connection is forbidden
0800	Network link in path to module is offline
0801 - 080F	Reserved

Extended Status Code (in hex)	Description of Status
0810	No target application data available
0811	No originator application data available
0812	Node address has changed since the network was scheduled
0813	Not configured for off-subnet multicast
0814	Invalid produce / Consume data format
0815 - FCFF	Reserved
FD00 - FFFF	Do not use

11-4-2. Extended status codes for protocol stack (communication control part)

The error codes indicate the response to the communication control part including CIP.

These error codes shall be used to help diagnose the problem with a Service Request.

The error code shall be split into an 8-bit general status and one or more 8-bit words of extended status.

(1) General Status Code: FBh (network action error)

Extended Status Code (in hex)	Description of Status
01	CIP IO FORWARD OPEN TARGET to originator action
02	Invalid socket address
03	Invalid originator to target network parameter
04	Invalid target to originator network parameter
05	Invalid UDP port
06	Invalid multicast JOIN (invalid muticast address)
07	Unequipped CIP IO packet (lack of resource)
08	Unequipped CIP IO producer
09	Unequipped CIP IO producer
0A	Lack of the CIP resource
0B	CIP IO timeout action
0C	CIP IO close action
0D	CIP IO stop action
0E	CIP adapter stop action

11-5. NCW-3DNIP Indicator

11-5-1. Status indicator (MS/NS)

Error contents can be checked by lighting status of the status indicator (MS/NS) when an error occurs. Check the contents and take appropriate measures.

Light status		Name	Cause and Countermeasure
MS	NS		
Green	Green	Normal operation	Indicates that it is in the normal communication.
Flashing Green/ Red	Flashing Green/ Red	Self-test	MS/NS indicators alternately blink each 0.25s.
OFF	OFF	No power	The power doesn't supply to NCW-3DNIP. - Check wirings of the power supply terminal block of NCW-3DNIP. - Check that the power voltage is within the range of specification. - Check whether the power supply capacities are enough or not.
Flashing Green	OFF	No IP address	The converter cannot get a valid IP address. (This error is detected only when the automatic IP address setting is selected.) Check the BOOTP or DHCP server operates in the network system.
Flashing Red	—	Major Recoverable Fault	The sensor error (SE) occurred. For more details, refer to "11-5-3".
Red	—	Major Unrecoverable Fault	NCW-3DNIP has the internal error (RDY LED is OFF). Restart the power supply. Hardware might have a malfunction if the operation is not back to normal. Thus, replace the converter.
Green	Flashing Green	No connections	Communication is available, but a connection is not established.
Green	Flashing Red	Connection timeout	Detects one or more connection is timeout during the communication. - The communication band width of the whole network system might be lack. Reallocate the communication band width of the whole network system including NCW-3DNIP RPI setting by the configuration tool. - Irregular communication interrupt might have occurred. Investigate a conceivable cause in the system.
Green	Red	Duplicate IP address	The IP address is duplicated in the network.

11-5-2. Link status indicator (L/A1·L/A2)

The Link Status indicator (L/A1, L/A2) monitors communication state.

L/A1: Monitors the Ethernet port 1 state.

L/A2: Monitors the Ethernet port 2 state.

Light status L/A1, L/A2	Name	Cause and Countermeasure
OFF	No link	Indicates Link is not established.
ON	Link	Indicates Link is established.
Flashing	During the communication	Indicates data is sent/received.

11-5-3. Converter status indicator

Indicates error causes and countermeasures regarding to the converter.

Light status				Name	Cause and Countermeasure
PON	RDY	ME	SE1 SE2		
ON	ON	OFF	OFF	Normal	—
OFF	OFF	OFF	OFF	Power Supply Error	The power doesn't supply to NCW-3DNIP. - Check wirings of the power supply terminal block of NCW-3DNIP. - Check that the power voltage is within the range of specification. - Check whether the power supply capacities are enough or not.
ON	OFF	OFF	OFF	Watchdog Timer Error or Internal Error	NCW-3DNIP operation is abnormal. Restart the power supply. Hardware might have a malfunction if the operation is not back to normal. Thus, replace NCW-3DNIP.
ON	OFF	ON	—	Memory Error	A parameter memory for NCW-3DNIP is abnormal. Restart the power supply. Hardware might have a malfunction if memory error occurred repeatedly. Thus, replace NCW-3DNIP.
ON	ON	—	ON	SE1 Axis-1 Sensor Error SE2 Axis-2 Sensor Error	One of the following errors occurred. - The ABOSOCODER sensor isn't connected. - A sensor cable is severed. - A parameter (Axis valid / Axis Unavailable) whose axis isn't used is set to "0: valid". - NCW-3DNIP has a malfunction. - ABSOCODER has a malfunction. Check the following content. - Check whether the sensor connector is connected or not. - Check whether a sensor cable is severed or not. - Check the unused axis parameter. Remove the error, and execute the error clear from the Ethernet/IP scanner. Hardware might have a malfunction if errors occurred repeatedly. Thus, replace the converter.

11-6. Reset Service

The state of NCW-3DNIP (slave) can be reset by using a configuration tools or EtherNet/IP scanner (master) if EhterNet/IP communication is available.

Use Reset (ID: 0x05) in an Instance Service (InstanceID: 0x01) of the Identity object (ClassID: 0x01), and the device can be reset.

The following parameter can be specified when resetting.

Parameter	Description
0	Restart
1	All NCW-3DNIP parameters' setting is redesignated to initial values (factory setting), and restart.
2	All NCW-3DNIP parameters' setting is redesignated to initial values (factory setting) except communication LINK parameter, and restart.

- MEMO -

12. STORE OF MAINTENANCE INFORMATION

NCW-3DNIP can store maintenance information to the Info Maintenance object (Class ID: 0xC07).

The maintenance information should be store if it is required.

Stored information can be checked when doing periodic maintenance NCW-3DNIP or having an error.

For more details, refer to "APPENDIX 2-12. Info Maintenance Object (Class ID: 0xC7)".

No.	Name	Data Type	Description
1	Power Distribution Time	UDINT	NCW-3DNIP cumulative energization time can be check. Unit: sec
2	Function	UDINT	Stores a function code.
		STRING	Stores a function comment. Max.character No.: 58
3	Location	UDINT	Stores an installation location code.
		STRING	Stores an installation location comment. Max.character No.: 58
4	Installation Date	UDINT	Stores an installation date code.
		STRING	Stores an installation date comment. Max.character No.: 58
5	Descriptor 1	UDINT	Stores a descriptor 1 code.
		STRING	Stores a descriptor 1 comment. Max.character No.: 58
6	Descriptor 2	UDINT	Stores a descriptor 2 code.
		STRING	Stores a descriptor 2 comment. Max.character No.: 58
7	Security	UDINT	Stores a security code.
		STRING	Stores a security name comment. Max. character No.:58

13. ABSOCODER SENSOR CHECK LIST

- Applicable ABSOCODER sensor models
 MRE-32SP062
 MRE-G[]SP062 []: 64, 128, 160, 256, 320

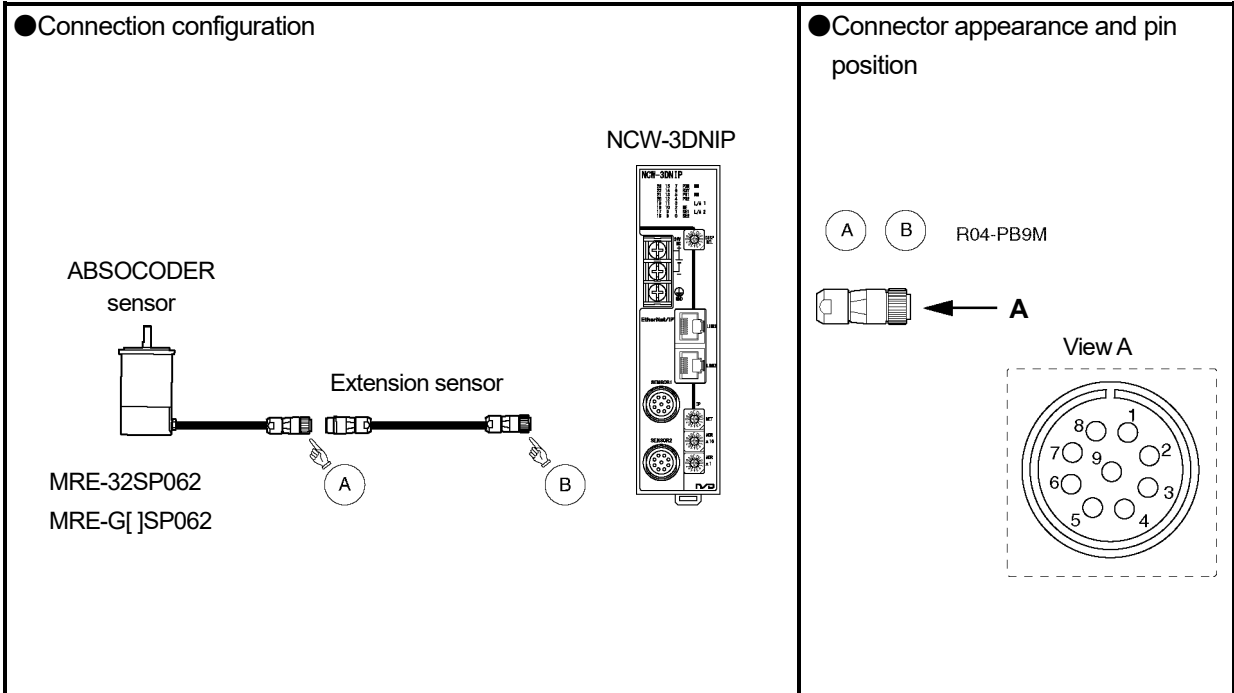

Checks at Point B should be carried out with Point A connected.

- Connector pin position and standard coil resistance ranges (at 25°C)

Connector pin No.	Signal name	Wiring color	Standard coil resistance [Ω]	
			MRE-32SP062	MRE-G[]SP062
1	SIN+	Brown	100 to 120	115 to 123
2	SIN-	Red		
3	-COS+	Orange	100 to 120	115 to 123
4	-COS-	Yellow		
5	OUT1+	Green	4 to 10	28.5 to 40.5
6	OUT1-	Blue		
7	OUT2+	Violet	113 to 137	28.5 to 40.5
8	OUT2-	Gray		
9	Shield	Shield	—	—
—	—	—	—	—

The above standard coil resistance ranges are referential data to assist wiring disconnection diagnosis and are not product specification values. There may be no wiring disconnection even when the resistance measurement is out of the standard resistance range.

● Circuit resistance check

[Measurement method]

Measure resistance at Point A or B using a circuit tester or other appropriate device.
If the connector is off, identify the line by the wiring color.

[Check details]

Refer to the previous page for the connector pin number.

Check position	Criterion	Check position	Criterion
Between brown and red	The measured value should be in the range of the standard coil resistance. *1	Between brown and orange, green, violet, shield	∞
Between orange and yellow		Between orange and green, violet, shield	
Between green and blue		Between green and violet, shield	
Between violet and gray		Between violet and shield	
		Between frame and each wire	

*1: If checks are done at Point B, the measurement value is [Standard coil resistance + extension sensor cable resistance (cable length (m) x 0.2 (Ω))].

The resistance value of the NSD special cable is 0.2Ω/m (loop resistance).

Consider resistance variations due to temperature, which, relative to the standard temperature (25°C), increases 0.4% when the temperature rises 1°C and decreases 0.4% when the temperature falls 1°C.

● Insulation check

[Measurement method]

Measure using a 500 VDC insulation tester.

[Check details]

Refer to the previous page for the connector pin number.

Check position	Criterion
Between brown and orange, green, violet, shield	10MΩ or more
Between orange and green, violet, shield	
Between green and violet, shield	
Between violet and shield	
Between frame and each wire	

 NOTES

1. Make sure to disconnect the ABSOCODER sensor from NCW-3DNIP before carrying out insulation checks.
2. If there is a risk that energization may cause damages to the electronic circuits in and around the machine, remove the ABSOCODER sensor from the machine.
3. After completing the checks, short-circuit between the pins to discharge remaining voltage before connecting the ABSOCODER sensor to NCW-3DNIP.

14. CE MARKING

This product conforms to the EMC Directive.

14-1. EMC Directives

It is necessary to do CE marking in the customer's responsibility in the state of a final product.
Confirm EMC compliance of the machine and the entire device by customer because EMC changes configuration of the control panel, wiring, and layout.

14-2. EMC Directive and Standards

EMC consists of emission and immunity items.
It conforms to Table (see below) of EMC standards and Testing.

Class	Standard No.	Standard Name
Emission (EMI)	EN61000-6-4	Generic standards. Emission standard for industrial environments
Immunity (EMS)	EN61000-6-2	Generic standards. Immunity standard for industrial environments
	EN61000-4-2	Electrostatic Discharge
	EN61000-4-3	Radiated, Radio frequency, Electromagnetic Field
	EN61000-4-4	Electrical Fast Transient / Burst
	EN61000-4-5	Surge Immunity
	EN61000-4-6	Conducted Disturbances, Induced by Radio-Frequency Fields
	EN61000-4-8	Power Frequency Magnetic Field

14-3. Low Voltage Directive

This product doesn't apply to low-voltage directive for the equipment of 24VDC power supply.

14-4. Measures for EMC Compliance

Describes measures for EMC compliance when testing the compatibility verification.

●LAN cable (Communication cable for EtherNet/IP)

A CAT-5e STP straight cable was used as the LAN cable.

The LAN cable was covered with the shielded zippertubing, and the shield was grounded.

Zippertubing

Model	Manufacturer
MTFS 20 ϕ	ZIPPERTUBING (JAPAN), LTD.

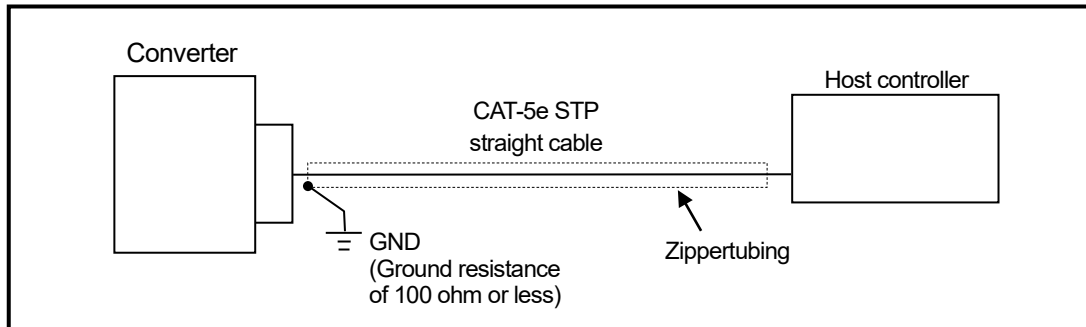

14-5. Restrictions

●Sensor cable

If a 30m or longer sensor cable is to be used, pass the sensor cable through a metal duct or cover the sensor cable with the shielded zippertubing and ground the tube shield.

Zippertubing

Model	Manufacturer
MTFS 20 ϕ	ZIPPERTUBING (JAPAN), LTD.

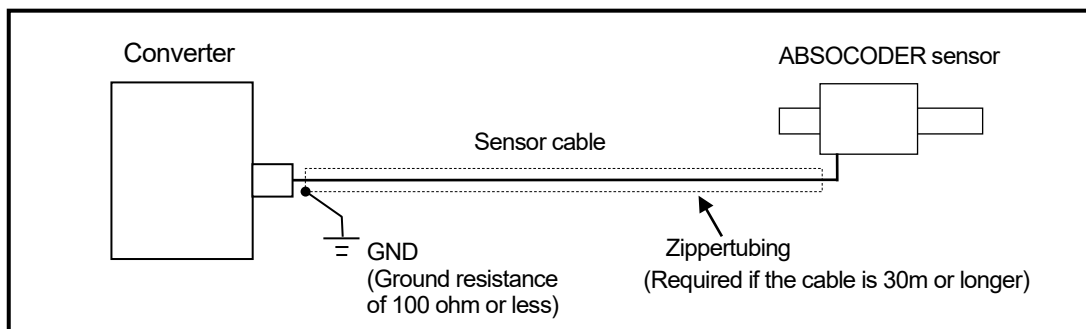

[Reference]

It might be improved when the clamp filter is installed to the power supply or sensor cable when it operates faultily by the influence from the peripheral devices.

Clamp Filter

Mounting location	Clamp filter model	Manufacturer
- Power supply cable - Sensor cable	ZCAT2032-0930 (inner dimensions: $\phi 9$)	TDK

APPENDIX 1. CIP OBJECT MODEL

The following figure illustrates the CIP object model of the NCW-3DNIP.

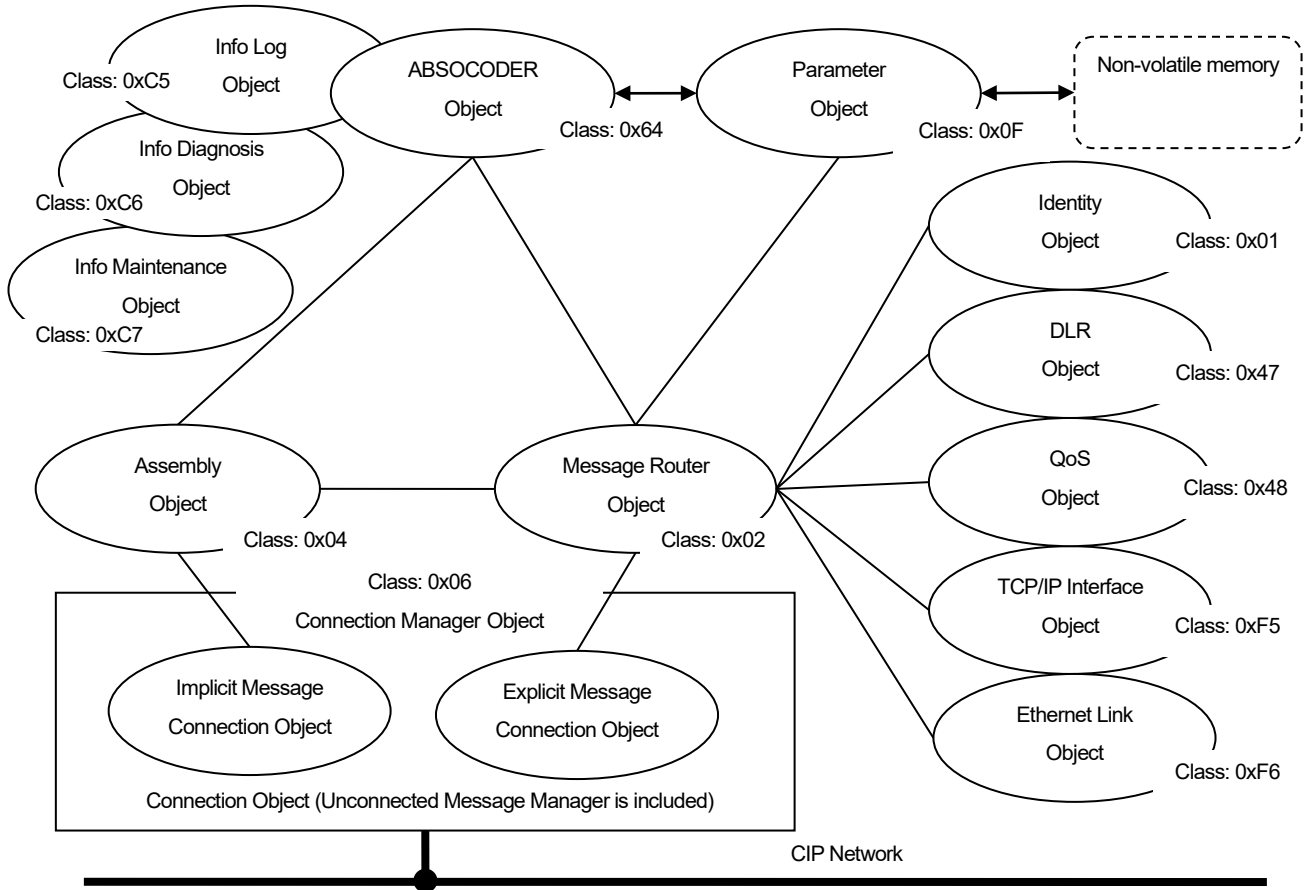

Class Code	Object Name	Description	Number of Instances
0x01	Identity	Provides NCW-3DNIP node information on the network.	1
0x02	Message Router	All communication messages are processed, and then they are sorted to proper objects.	1
0x04	Assembly	The object is assembled for ABOSOCODER. I/O message data for the NCW-3DNIP's Exclusive-Owner connection can be read or written.	3
0x06	Connection Manager	Manages the communication status.	1
0x0F	Parameter	Provides parameter information of NCW-3DNIP.	8
0x47	DLR	Provides the ring topology information	1
0x48	QoS	Provides relative priority setting information of different transmission traffics	1
0x64	ABSOCODER	Provides parameters and status information of ABSOCODER.	2
0xC5	Info Log	Provides NCW-3DNIP operation and error histories (max.32)	1
0xC6	Info Diagnosis	Provides NCW-3DNIP diagnosis information.	1
0xC7	Info Maintenance	Provides NCW-3DNIP maintenance information.	1
0xF5	TCP/IP Interface	Provides Ethernet TCP/IP interface information.	1
0xF6	Ethernet Link	Provides Ethernet interface information.	2

APPENDIX 2. DETAILS OF CIP OBJECT

Data handled by NCW-3DNIP supporting Ethernet / IP is managed by CIP object.
Access the CIP object using various services that are installed in each CIP object.

APPENDIX 2-1. Identity Object (Class ID: 0x01)

It holds NCW - 3DNIP node information on the network.
The specification of the Identity object is shown below.
Identity object has one instance.

Class Attribute (Class ID: 0x01)

ID	Name	Access		Data Type	Description
		Get	Set		
0x01	Revision	○	-	UINT	1
0x02	Max Instance	○	-	UINT	1
0x03	Number of Instances	○	-	UINT	1

Class Service (Class ID: 0x01, Instance ID: 0x00)

ID	Name	Description										
0x01	Get_Attribute_All	Read out all attribute values from NCW-3DNIP. Responded Attribute information for the request is following; <table border="1" data-bbox="603 1144 1382 1350"> <thead> <tr> <th>ID</th> <th>Description</th> </tr> </thead> <tbody> <tr> <td>0x01</td> <td>1 (Revision)</td> </tr> <tr> <td>0x02</td> <td>1 (Max Instance)</td> </tr> <tr> <td>0x06</td> <td>0 (Not available for NCW-3DNIP)</td> </tr> <tr> <td>0x07</td> <td>0 (Not available for NCW-3DNIP)</td> </tr> </tbody> </table>	ID	Description	0x01	1 (Revision)	0x02	1 (Max Instance)	0x06	0 (Not available for NCW-3DNIP)	0x07	0 (Not available for NCW-3DNIP)
ID	Description											
0x01	1 (Revision)											
0x02	1 (Max Instance)											
0x06	0 (Not available for NCW-3DNIP)											
0x07	0 (Not available for NCW-3DNIP)											
0x0E	Get_Attribute_Single	Read out one attribute value from NCW-3DNIP.										

Instance Attribute (Class ID: 0x01, Instance ID: 0x01)

ID	Name	Access		Data Type	Description
		Get	Set		
0x01	Vendor ID	○	—	UINT	Indicates the product vendor ID. (230: NSD Corporation)
0x02	Device Type	○	—	UINT	Indicates the product device type. (43: Generic Device)
0x03	Product Code	○	—	UINT	Indicates the product code. (30101)
0x04	Revision	○	—	USINT	Indicates the product major revision.
				USINT	Indicates the product minor revision.
0x05	Status	○	—	WORD	Indicates the product status. *1: Please refer to the next page for definition of Bit.
0x06	Serial Number	○	—	UDINT	Indicates the product serial number.
0x07	Product Name	○	—	SHORT_STRING	Indicates the product name. (NCW-3DNIPMP)

Instance Service (Class ID: 0x01, Instance ID: 0x01)

ID	Name	Description
0x01	Get_Attribute_All	Read out all attribute values from NCW-3DNIP.
0x05	Reset	Reset service The Reset service parameters are the following; 0: Restart 1: All NCW-3DNIP parameters' setting is redesignated to initial values (factory setting), and restart. 2: All NCW-3DNIP parameters' setting is redesignated to initial values (factory setting) except communication LINK parameter, and restart.
0x0E	Get_Attribute_Single	Read out one attribute value from NCW-3DNIP.

*1 : Instance Attribute 0x05: Bit definition of Status

Bit	Name	Definition																				
0	Owned	FALSE: Indicates NCW-3DNIP has no owner. TRUE: Indicates NCW-3DNIP has an owner.																				
1	—	Reserved (fixed at 0)																				
2	Configured	FALSE: Indicates that NCW-3DNIP is set initial (factory setting) values. TRUE: Indicates that NCW-3DNIP is changed from initial (factory setting) values. (The communication setting isn't included.)																				
3	—	Reserved (fixed at 0)																				
4-7	Extended Device Status	Indicates current NCW-3DNIP status. This attribute value is changed depending on the device state. <table border="1" data-bbox="603 1146 1426 1554"> <thead> <tr> <th>Bit value</th> <th>Description</th> </tr> </thead> <tbody> <tr> <td>0000b</td> <td>Self-Testing or Unknown</td> </tr> <tr> <td>0010b</td> <td>At least one faulted I/O connection</td> </tr> <tr> <td>0011b</td> <td>No I/O connections established</td> </tr> <tr> <td>0100b</td> <td>Non-Volatile Configuration bad</td> </tr> <tr> <td>0101b</td> <td>Major Fault – either bit 10 or bit 11 is true</td> </tr> <tr> <td>0110b</td> <td>At least one I/O connection in run mode</td> </tr> <tr> <td>0111b</td> <td>At least one I/O connection established, all in idle mode</td> </tr> <tr> <td>1000b</td> <td>Reserved</td> </tr> <tr> <td>1001b</td> <td>Reserved</td> </tr> </tbody> </table>	Bit value	Description	0000b	Self-Testing or Unknown	0010b	At least one faulted I/O connection	0011b	No I/O connections established	0100b	Non-Volatile Configuration bad	0101b	Major Fault – either bit 10 or bit 11 is true	0110b	At least one I/O connection in run mode	0111b	At least one I/O connection established, all in idle mode	1000b	Reserved	1001b	Reserved
Bit value	Description																					
0000b	Self-Testing or Unknown																					
0010b	At least one faulted I/O connection																					
0011b	No I/O connections established																					
0100b	Non-Volatile Configuration bad																					
0101b	Major Fault – either bit 10 or bit 11 is true																					
0110b	At least one I/O connection in run mode																					
0111b	At least one I/O connection established, all in idle mode																					
1000b	Reserved																					
1001b	Reserved																					
8	Minor Recoverable Fault	FALSE: - TRUE: Indicates that a minor fault (recoverable fault) is detected.																				
9	Minor Unrecoverable Fault	FALSE: - TRUE: Indicates that a minor fault (unrecoverable fault) is detected.																				
10	Major Recoverable Fault	FALSE: - TRUE: Indicates that a major fault (recoverable fault) is detected.																				
11	Major Unrecoverable Fault	FALSE: - TRUE: Indicates that a major fault (unrecoverable fault) is detected.																				

● Identity (ClassID: 0x01) State transition diagram of object

The Identity object defines the NCW-3DNIP's behavior.

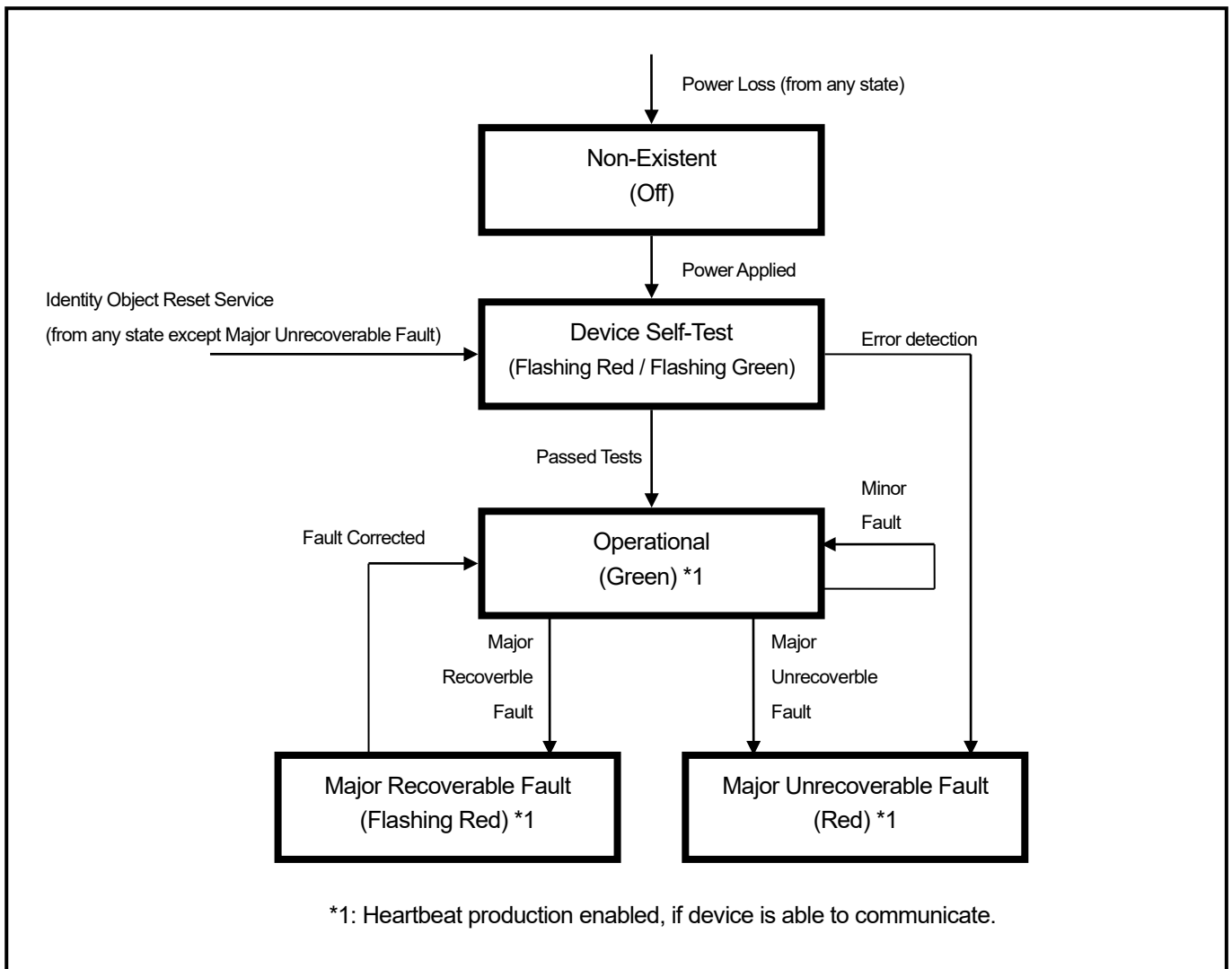

The state transition diagram of the Identity object includes the following events.

- **Minor fault:** A fault classified as either a Minor Unrecoverable Fault or a Minor Recoverable Fault has occurred.
- **Major Recoverable Fault:** An event classified as Major Recoverable Fault has occurred.
- **Major Unrecoverable Fault:** An event classified as a Major Unrecoverable Fault has occurred.

APPENDIX 2-2. Message Router Object (Class ID: 0x02)

All communication messages are processed, and then they are sorted to proper objects.

Following tables indicate specifications of the Message Router object.

The Message Router object has one instance; however, all attribute isn't opened to the public.

Class Attribute (Class ID: 0x02)

ID	Name	Access		Data Type	Description
		Get	Set		
0x01	Revision	—	—	UINT	—
0x04	Optional attribute list	—	—	UINT	—
				UINT[]	—
0x05	Optional service list	—	—	UINT	—
				UINT[]	—
0x06	Maximum ID Number Class Attributes	—	—	UINT	—
0x07	Maximum ID Number Instance Attributes	—	—	UINT	—

Instance Attribute (Class ID: 0x02, Instance ID: 0x01)

ID	Name	Access		Data Type	Description
		Get	Set		
0x01	Object List	—	—	UINT	—
				UINT[]	—
0x02	Number Available	—	—	UINT	—
0x03	Number active	—	—	UINT	—
0x04	Active Connections	—	—	UINT[]	—

APPENDIX 2-3. Assembly Object (Class ID: 0x04)

This object is assembled for ABSOCODER.

I/O message data for the NCW-3DNIP's Exclusive-Owner connection can be read or written.

Following tables indicate specifications of the Assembly object.

NCW-3DNIP has the following Assembly object instances.

0x65: For Exclusive-Owner (Input) Connection

0x66: For Exclusive-Owner (Output) Connection

0x67: For Exclusive-Owner (Configuration) Connection

Class Attribute (Class ID: 0x04)

ID	Name	Access		Data Type	Description
		Get	Set		
0x01	Revision	○	—	UINT	2
0x02	Max Instance	○	—	UINT	0x67(103)
0x03	Number of Instances	○	—	UINT	3

Class Service (Class ID: 0x04, Instance ID: 0x00)

ID	Name	Description
0x0E	Get_Attribute_Single	Read out one attribute value from NCW-3DNIP.

Instance Attribute (Class ID: 0x04, Instance ID: 0x65)

ID	Name	Access		Data Type	Description
		Get	Set		
0x03	Data	○	—	USINT[28]	<p>Indicates the Input (Exclusive-Owner) data. For more details, refer to "section 9-9".</p> <p>*: The general status code "0x0E (not settable) will be returned to the EtherNet/IP master if the Set operation is done.</p>

Instance Attribute (Class ID: 0x04, Instance ID: 0x66)

ID	Name	Access		Data Type	Description
		Get	Set		
0x03	Data	○	○	USINT[16]	<p>Indicates the Output (Exclusive-Owner) data. For more details, refer to "section 9-9".</p> <p>*: PRESET or ERRCLR can be operated by Output data format except during I/O communication if the Set operation is done.</p> <p>The general status code "0x0F (Privilege violation) will be returned to the EtherNet/IP master during I/O communication.</p>

Instance Attribute (Class ID: 0x04, Instance ID: 0x67)

ID	Name	Access		Data Type	Description
		Get	Set		
0x03	Data	○	—	USINT[0]	Indicates the Configuration (Exclusive-Owner) data. *: The general status code "0x0E (not settable) will be returned to the EtherNet/IP master if the Set operation is done.

Instance Service (Class ID: 0x04, Instance ID: 0x65,0x66,0x67)

ID	Name	Description
0x0E	Get_Attribute_Single	Read out one attribute value from NCW-3DNIP.
0x10	Set_Attribute_Single	Write one attribute value to NCW-3DNIP.

APPENDIX 2-4. Connection Manager Object (Class ID: 0x06)

The Connection Manager object manages the communication status, and has one instance. Following tables indicate specifications of the Connection Manager object.

Class Attribute (Class ID: 0x06)

ID	Name	Access		Data Type	Description
		Get	Set		
0x01	Revision	○	—	UINT	1
0x02	Max Instance	○	—	UINT	1
0x03	Number of Instances	○	—	UINT	1

Class Service (Class ID: 0x06, Instance ID: 0x00)

ID	Name	Description										
0x01	Get_Attribute_All	<p>Read out all attribute values from NCW-3DNIP. Responded Attribute information for the request is following;</p> <table border="1"> <thead> <tr> <th>ID</th> <th>Description</th> </tr> </thead> <tbody> <tr> <td>0x01</td> <td>1 (Revision)</td> </tr> <tr> <td>0x02</td> <td>1 (Max Instance)</td> </tr> <tr> <td>0x06</td> <td>0 (Not available for NCW-3DNIP)</td> </tr> <tr> <td>0x07</td> <td>0 (Not available for NCW-3DNIP)</td> </tr> </tbody> </table>	ID	Description	0x01	1 (Revision)	0x02	1 (Max Instance)	0x06	0 (Not available for NCW-3DNIP)	0x07	0 (Not available for NCW-3DNIP)
ID	Description											
0x01	1 (Revision)											
0x02	1 (Max Instance)											
0x06	0 (Not available for NCW-3DNIP)											
0x07	0 (Not available for NCW-3DNIP)											
0x0E	Get_Attribute_Single	Read out one attribute value from NCW-3DNIP.										

Instance Attribute (Class ID: 0x06, Instance ID: 0x01)

ID	Name	Access		Data Type	Description
		Get	Set		
0x01	Open Requests	○	—	UINT	Number of Forward Open service requests received.
0x02	Open Format Rejects	○	—	UINT	Number of Forward Open service requests which were rejected due to bad format.
0x03	Open Resource Rejects	○	—	UINT	Number of Forward Open service requests which were rejected due to lack of resources.
0x04	Open Other Rejects	○	—	UINT	Number of Forward Open service requests which were rejected for reasons other than bad format or lack of resources.
0x05	Close Requests	○	—	UINT	Number of Forward Close service requests received.
0x06	Close Format Requests	○	—	UINT	Number of Forward Close service requests which were rejected due to bad format.
0x07	Close Other Requests	○	—	UINT	Number of Forward Close service requests which were rejected for reasons other than bad format.
0x08	Connection Timeouts	○	—	UINT	Total number of connection timeouts that have occurred in connections controlled by the Connection Manager.

Instance Service (Class ID: 0x06, Instance ID: 0x01)

ID	Name	Description
0x01	Get_Attribute_All	Read out all attribute values from NCW-3DNIP.
0x0E	Get_Attribute_Single	Read out one attribute value from NCW-3DNIP.
0x4E	Forward_Close	Close the connection.
0x54	Forward_Open	Open the connection.

APPENDIX 2-5. Parameter Object (Class ID: 0x0F)

Parameter object provides parameter information of NCW-3DNIP.

Following tables indicate specifications of the Parameter object.
This is objects for parameters which are used with NCW-3DNIP.

Class Attribute (Class ID: 0x0F)

ID	Name	Access		Data Type	Description										
		Get	Set												
0x01	Revision	○	—	UINT	1										
0x02	Max Instance	○	—	UINT	0x08(8)										
0x03	Number of Instances	○	—	UINT	8										
0x08	Parameter Class Descriptor	○	—	WORD	Indicates the following parameter characteristics (value: 0x000B). <table border="1" data-bbox="887 745 1465 1301"> <thead> <tr> <th>Bit</th> <th>Description</th> </tr> </thead> <tbody> <tr> <td>0</td> <td><u>Supports Parameter Instances</u> 1: Individual Parameter instances are supported.</td> </tr> <tr> <td>1</td> <td><u>Supports Full Attributes</u> 1: All Full Parameter Attributes are supported.</td> </tr> <tr> <td>2</td> <td><u>Must do non-volatile storage Save command</u> 0: Do not have to execute non-volatile storage save command. (It automatically executes inside of NCW-3DNIP.)</td> </tr> <tr> <td>3</td> <td><u>Param are stored in Non-Volatile Storage</u> 1: Parameters are stored in non-volatile storage.</td> </tr> </tbody> </table>	Bit	Description	0	<u>Supports Parameter Instances</u> 1: Individual Parameter instances are supported.	1	<u>Supports Full Attributes</u> 1: All Full Parameter Attributes are supported.	2	<u>Must do non-volatile storage Save command</u> 0: Do not have to execute non-volatile storage save command. (It automatically executes inside of NCW-3DNIP.)	3	<u>Param are stored in Non-Volatile Storage</u> 1: Parameters are stored in non-volatile storage.
Bit	Description														
0	<u>Supports Parameter Instances</u> 1: Individual Parameter instances are supported.														
1	<u>Supports Full Attributes</u> 1: All Full Parameter Attributes are supported.														
2	<u>Must do non-volatile storage Save command</u> 0: Do not have to execute non-volatile storage save command. (It automatically executes inside of NCW-3DNIP.)														
3	<u>Param are stored in Non-Volatile Storage</u> 1: Parameters are stored in non-volatile storage.														
0x09	Configuration Assembly Instance	○	—	UINT	0x67										

Class Service (Class ID: 0x0F, Instance ID: 0x00)

ID	Name	Description												
0x01	Get_Attribute_All	Read out all attribute values from NCW-3DNIP. Attribute information returned in response to a request is as follows. <table border="1" data-bbox="603 1641 1382 1888"> <thead> <tr> <th>ID</th> <th>Description</th> </tr> </thead> <tbody> <tr> <td>0x01</td> <td>1 (Revision)</td> </tr> <tr> <td>0x02</td> <td>1 (Max Instance)</td> </tr> <tr> <td>0x08</td> <td>0 (Not available for NCW-3DNIP)</td> </tr> <tr> <td>0x09</td> <td>0 (Not available for NCW-3DNIP)</td> </tr> <tr> <td>0x0A</td> <td>0</td> </tr> </tbody> </table>	ID	Description	0x01	1 (Revision)	0x02	1 (Max Instance)	0x08	0 (Not available for NCW-3DNIP)	0x09	0 (Not available for NCW-3DNIP)	0x0A	0
ID	Description													
0x01	1 (Revision)													
0x02	1 (Max Instance)													
0x08	0 (Not available for NCW-3DNIP)													
0x09	0 (Not available for NCW-3DNIP)													
0x0A	0													
0x0E	Get_Attribute_Single	Read out one attribute value from NCW-3DNIP.												

Instance Attribute (Class ID: 0x0F, Instance ID: 0x01)

ID	Name	Access		Data Type	Description
		Get	Set		
0x01	Parameter Value	○	○	BOOL	Parameter value (Axis-1 parameter :Axis Unavailable)
0x02	Link Path Size	○	—	USINT	3
0x03	Link Path	○	—	Packed EPATH	"20 64 24 01 30 64"
0x04	Descriptor	○	—	WORD	0x0000
0x05	Data Type	○	—	EPATH	0xC1 (Logical boolean)
0x06	Data Size	○	—	USINT	1
0x07	Parameter Name String	○	—	SHORT_ STRING	0x10,"Axis-1 Unavailab"
0x08	Unit String	○	—	SHORT_ STRING	0x00,""
0x09	Help String	○	—	SHORT_ STRING	0x22,"Axis-1 Parameter - Axis Unavailable"
0x0A	Minimum Value	○	—	BOOL	0
0x0B	Maximum Value	○	—	BOOL	1
0x0C	Default Value	○	—	BOOL	0
0x0D	Scaling Multiplier	○	—	UINT	1 (Scaling factor)
0x0E	Scaling Divisor	○	—	UINT	1 (Scaling factor)
0x0F	Scaling Base	○	—	UINT	1 (Scaling factor)
0x10	Scaling Offset	○	—	INT	0 (Scaling factor)
0x11	Multiplier Link	○	—	UINT	0 (Scaling factor)
0x12	Divisor Link	○	—	UINT	0 (Scaling factor)
0x13	Base Link	○	—	UINT	0 (Scaling factor)
0x14	Offset Link	○	—	UINT	0 (Scaling factor)
0x15	Decimal Precision	○	—	USINT	0 (Number of decimal places of parameter value)

Instance Attribute (Class ID: 0x0F, Instance ID: 0x02)

ID	Name	Access		Data Type	Description
		Get	Set		
0x01	Parameter Value	○	○	BOOL	Parameter value (Axis-1 parameter: Error Clear)
0x02	Link Path Size	○	—	USINT	3
0x03	Link Path	○	—	Packed EPATH	"20 64 24 01 30 65"
0x04	Descriptor	○	—	WORD	0x0000
0x05	Data Type	○	—	EPATH	0xC1 (Logical boolean)
0x06	Data Size	○	—	USINT	1
0x07	Parameter Name String	○	—	SHORT_ STRING	0x10,"Axis-1 Error Cle"
0x08	Unit String	○	—	SHORT_ STRING	0x00,""
0x09	Help String	○	—	SHORT_ STRING	0x1E,"Axis-1 Parameter - Error Clear"
0x0A	Minimum Value	○	—	BOOL	0
0x0B	Maximum Value	○	—	BOOL	1
0x0C	Default Value	○	—	BOOL	0
0x0D	Scaling Multiplier	○	—	UINT	1 (Scaling factor)
0x0E	Scaling Divisor	○	—	UINT	1 (Scaling factor)
0x0F	Scaling Base	○	—	UINT	1 (Scaling factor)
0x10	Scaling Offset	○	—	INT	0 (Scaling factor)
0x11	Multiplier Link	○	—	UINT	0 (Scaling factor)
0x12	Divisor Link	○	—	UINT	0 (Scaling factor)
0x13	Base Link	○	—	UINT	0 (Scaling factor)
0x14	Offset Link	○	—	UINT	0 (Scaling factor)
0x15	Decimal Precision	○	—	USINT	0 (Number of decimal places of parameter value)

Instance Attribute (Class ID: 0x0F, Instance ID: 0x03)

ID	Name	Access		Data Type	Description
		Get	Set		
0x01	Parameter Value	○	○	BOOL	Parameter value (Axis-1 parameter: Position Data Increase Direction)
0x02	Link Path Size	○	—	USINT	3
0x03	Link Path	○	—	Packed EPATH	"20 64 24 01 30 0C"
0x04	Descriptor	○	—	WORD	0x0000
0x05	Data Type	○	—	EPATH	0xC1 (Logical boolean)
0x06	Data Size	○	—	USINT	1
0x07	Parameter Name String	○	—	SHORT_STRING	0x10,"Axis-1 Direction"
0x08	Unit String	○	—	SHORT_STRING	0x00,""
0x09	Help String	○	—	SHORT_STRING	0x33,"Axis-1 Parameter - Position Data Increase Direction"
0x0A	Minimum Value	○	—	BOOL	0
0x0B	Maximum Value	○	—	BOOL	1
0x0C	Default Value	○	—	BOOL	0
0x0D	Scaling Multiplier	○	—	UINT	1 (Scaling factor)
0x0E	Scaling Divisor	○	—	UINT	1 (Scaling factor)
0x0F	Scaling Base	○	—	UINT	1 (Scaling factor)
0x10	Scaling Offset	○	—	INT	0 (Scaling factor)
0x11	Multiplier Link	○	—	UINT	0 (Scaling factor)
0x12	Divisor Link	○	—	UINT	0 (Scaling factor)
0x13	Base Link	○	—	UINT	0 (Scaling factor)
0x14	Offset Link	○	—	UINT	0 (Scaling factor)
0x15	Decimal Precision	○	—	USINT	0 (Number of decimal places of parameter value)

Instance Attribute (Class ID: 0x0F, Instance ID: 0x04)

ID	Name	Access		Data Type	Description
		Get	Set		
0x01	Parameter Value	○	○	DINT	Parameter value (Axis-1 parameter: Preset Value)
0x02	Link Path Size	○	—	USINT	3
0x03	Link Path	○	—	Packed EPATH	"20 64 24 01 30 13"
0x04	Descriptor	○	—	WORD	0x0000
0x05	Data Type	○	—	EPATH	0xC4 (Signed 32-bit integer)
0x06	Data Size	○	—	USINT	4
0x07	Parameter Name String	○	—	SHORT_STRING	0x10,"Axis-1 Preset Va"
0x08	Unit String	○	—	SHORT_STRING	0x00,""
0x09	Help String	○	—	SHORT_STRING	0x1F,"Axis-1 Parameter - Preset Value"
0x0A	Minimum Value	○	—	DINT	0
0x0B	Maximum Value	○	—	DINT	16777215 (0x00FFFFFF)
0x0C	Default Value	○	—	DINT	0
0x0D	Scaling Multiplier	○	—	UINT	1 (Scaling factor)
0x0E	Scaling Divisor	○	—	UINT	1 (Scaling factor)
0x0F	Scaling Base	○	—	UINT	1 (Scaling factor)
0x10	Scaling Offset	○	—	INT	0 (Scaling factor)
0x11	Multiplier Link	○	—	UINT	0 (Scaling factor)
0x12	Divisor Link	○	—	UINT	0 (Scaling factor)
0x13	Base Link	○	—	UINT	0 (Scaling factor)
0x14	Offset Link	○	—	UINT	0 (Scaling factor)
0x15	Decimal Precision	○	—	USINT	0 (Number of decimal places of parameter value)

Instance Attribute (Class ID: 0x0F, Instance ID: 0x05)

ID	Name	Access		Data Type	Description
		Get	Set		
0x01	Parameter Value	○	○	BOOL	Parameter value (Axis-2 parameter: Axis Unavailable)
0x02	Link Path Size	○	—	USINT	3
0x03	Link Path	○	—	Packed EPATH	"20 64 24 02 30 64"
0x04	Descriptor	○	—	WORD	0x0000
0x05	Data Type	○	—	EPATH	0xC1 (Logical boolean)
0x06	Data Size	○	—	USINT	1
0x07	Parameter Name String	○	—	SHORT_ STRING	0x10, "Axis-2 Unavailab"
0x08	Unit String	○	—	SHORT_ STRING	0x00, ""
0x09	Help String	○	—	SHORT_ STRING	0x22, "Axis-2 Parameter - Axis Unavailable"
0x0A	Minimum Value	○	—	BOOL	0
0x0B	Maximum Value	○	—	BOOL	1
0x0C	Default Value	○	—	BOOL	0
0x0D	Scaling Multiplier	○	—	UINT	1 (Scaling factor)
0x0E	Scaling Divisor	○	—	UINT	1 (Scaling factor)
0x0F	Scaling Base	○	—	UINT	1 (Scaling factor)
0x10	Scaling Offset	○	—	INT	0 (Scaling factor)
0x11	Multiplier Link	○	—	UINT	0 (Scaling factor)
0x12	Divisor Link	○	—	UINT	0 (Scaling factor)
0x13	Base Link	○	—	UINT	0 (Scaling factor)
0x14	Offset Link	○	—	UINT	0 (Scaling factor)
0x15	Decimal Precision	○	—	USINT	0 (Number of decimal places of parameter value)

Instance Attribute (Class ID: 0x0F, Instance ID: 0x06)

ID	Name	Access		Data Type	Description
		Get	Set		
0x01	Parameter Value	○	○	BOOL	Parameter value (Axis-2 parameter: Error Clear)
0x02	Link Path Size	○	—	USINT	3
0x03	Link Path	○	—	Packed EPATH	"20 64 24 02 30 65"
0x04	Descriptor	○	—	WORD	0x0000
0x05	Data Type	○	—	EPATH	0xC1 (Logical boolean)
0x06	Data Size	○	—	USINT	1
0x07	Parameter Name String	○	—	SHORT_ STRING	0x10, "Axis-2 Error Cle"
0x08	Unit String	○	—	SHORT_ STRING	0x00, ""
0x09	Help String	○	—	SHORT_ STRING	0x1E, "Axis-2 Parameter - Error Clear"
0x0A	Minimum Value	○	—	BOOL	0
0x0B	Maximum Value	○	—	BOOL	1
0x0C	Default Value	○	—	BOOL	0
0x0D	Scaling Multiplier	○	—	UINT	1 (Scaling factor)
0x0E	Scaling Divisor	○	—	UINT	1 (Scaling factor)
0x0F	Scaling Base	○	—	UINT	1 (Scaling factor)
0x10	Scaling Offset	○	—	INT	0 (Scaling factor)
0x11	Multiplier Link	○	—	UINT	0 (Scaling factor)
0x12	Divisor Link	○	—	UINT	0 (Scaling factor)
0x13	Base Link	○	—	UINT	0 (Scaling factor)
0x14	Offset Link	○	—	UINT	0 (Scaling factor)
0x15	Decimal Precision	○	—	USINT	0 (Number of decimal places of parameter value)

Instance Attribute (Class ID: 0x0F, Instance ID: 0x07)

ID	Name	Access		Data Type	Description
		Get	Set		
0x01	Parameter Value	○	○	BOOL	Parameter value (Axis-2 parameter: Position Data Increase Direction)
0x02	Link Path Size	○	—	USINT	3
0x03	Link Path	○	—	Packed EPATH	"20 64 24 02 30 0C"
0x04	Descriptor	○	—	WORD	0x0000
0x05	Data Type	○	—	EPATH	0xC1 (Logical boolean)
0x06	Data Size	○	—	USINT	1
0x07	Parameter Name String	○	—	SHORT_STRING	0x10, "Axis-2 Direction"
0x08	Unit String	○	—	SHORT_STRING	0x00, ""
0x09	Help String	○	—	SHORT_STRING	0x33, "Axis-2 Parameter - Position Data Increase Direction"
0x0A	Minimum Value	○	—	BOOL	0
0x0B	Maximum Value	○	—	BOOL	1
0x0C	Default Value	○	—	BOOL	0
0x0D	Scaling Multiplier	○	—	UINT	1 (Scaling factor)
0x0E	Scaling Divisor	○	—	UINT	1 (Scaling factor)
0x0F	Scaling Base	○	—	UINT	1 (Scaling factor)
0x10	Scaling Offset	○	—	INT	0 (Scaling factor)
0x11	Multiplier Link	○	—	UINT	0 (Scaling factor)
0x12	Divisor Link	○	—	UINT	0 (Scaling factor)
0x13	Base Link	○	—	UINT	0 (Scaling factor)
0x14	Offset Link	○	—	UINT	0 (Scaling factor)
0x15	Decimal Precision	○	—	USINT	0 (Number of decimal places of parameter value)

Instance Attribute (Class ID: 0x0F, Instance ID: 0x08)

ID	Name	Access		Data Type	Description
		Get	Set		
0x01	Parameter Value	○	○	DINT	Parameter value (Axis-2 parameter: Preset Value)
0x02	Link Path Size	○	—	USINT	3
0x03	Link Path	○	—	Packed EPATH	"20 64 24 02 30 13"
0x04	Descriptor	○	—	WORD	0x0000
0x05	Data Type	○	—	EPATH	0xC4 (Signed 32-bit integer)
0x06	Data Size	○	—	USINT	4
0x07	Parameter Name String	○	—	SHORT_STRING	0x10, "Axis-2 Preset Va"
0x08	Unit String	○	—	SHORT_STRING	0x00, ""
0x09	Help String	○	—	SHORT_STRING	0x1F, "Axis-2 Parameter - Preset Value"
0x0A	Minimum Value	○	—	DINT	0
0x0B	Maximum Value	○	—	DINT	16777215 (0x00FFFFFF)
0x0C	Default Value	○	—	DINT	0
0x0D	Scaling Multiplier	○	—	UINT	1 (Scaling factor)
0x0E	Scaling Divisor	○	—	UINT	1 (Scaling factor)
0x0F	Scaling Base	○	—	UINT	1 (Scaling factor)
0x10	Scaling Offset	○	—	INT	0 (Scaling factor)
0x11	Multiplier Link	○	—	UINT	0 (Scaling factor)
0x12	Divisor Link	○	—	UINT	0 (Scaling factor)
0x13	Base Link	○	—	UINT	0 (Scaling factor)
0x14	Offset Link	○	—	UINT	0 (Scaling factor)
0x15	Decimal Precision	○	—	USINT	0 (Number of decimal places of parameter value)

Instance Service (Class ID: 0x0F, Instance ID: 0x01,0x02,0x03,0x04,0x05,0x06,0x07,0x08)

ID	Name	Description
0x01	Get_Attribute_All	Read out all attribute values from NCW-3DNIP.
0x0E	Get_Attribute_Single	Read out one attribute value from NCW-3DNIP.
0x10	Set_Attribute_Single	Write one attribute value to NCW-3DNIP.

APPENDIX 2-6. ABSOCODER Object (Class ID: 0x64)

ABSOCODER object provides setting information of the absolute encoder (ABSOCODER).

Following tables indicate specifications of the ABSOCODER object.
The ABSOCODER object has two instances for 2-axis NCW-3DNIP.

Class Attribute (Class ID: 0x64)

ID	Name	Access		Data Type	Description
		Get	Set		
0x01	Revision	○	—	UINT	1
0x02	Max Instance	○	—	UINT	2
0x03	Number of Instances	○	—	UINT	2

Class Service (Class ID: 0x64, Instance ID: 0x00)

ID	Name	Description
0x05	Reset	Reset service The Reset service parameters are the following; 0: Restart 1: All NCW-3DNIP parameters' setting is redesignated to initial values (factory setting), and restart.
0x0E	Get_Attribute_Single	Read out one attribute value from NCW-3DNIP.

Instance Attribute (Class ID: 0x64, Instance ID: 0x01[For axis-1], 0x02[For axis-2])

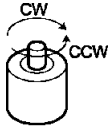
ID	Name	Access		Data Type	Description																								
		Get	Set																										
0x01	Number of Attributes	○	—	USINT	Indicates Numbers of Attributes that are supported this product. Returns the Number of Attributes "9".																								
0x02	Attribute List	○	—	USINT[]	Indicates Attribute List that is supported this product. Attribute List: 03, 0C, 13, 2C, 2D, 2E, 64, 65, 96																								
0x03	Position Value Unsigned	○	—	UDINT	Current position value																								
0x0C	Position Data Increase Direction	○	○	BOOL	Specify the ABSOCODER sensor rotation direction in which the position data increases. 0: CW (Default) 1: CCW 																								
0x13	Preset Value	○	○	DINT	Specify "Preset Value". Every axis's current position value will be changed to a value which is set in this attribute if Preset is executed. A designated Preset Value of Output data is returned during Get access when I/O communication starts.																								
0x2C	Alarms	○	—	WORD	Indicates an error detection state <table border="1" data-bbox="896 902 1444 1265"> <thead> <tr> <th>Bit</th> <th>Description</th> <th>FALSE (0)</th> <th>TRUE (1)</th> </tr> </thead> <tbody> <tr> <td>0</td> <td>SE (Sensor Error)</td> <td>None</td> <td>Yes</td> </tr> <tr> <td>1-12</td> <td>Reserved</td> <td colspan="2">—</td> </tr> <tr> <td>13</td> <td>SSE (Disconnected Sensor Error)</td> <td>None</td> <td>Yes</td> </tr> <tr> <td>14</td> <td>SPF (Sensor Circuit Power Error)</td> <td>None</td> <td>Yes</td> </tr> <tr> <td>15</td> <td>DE (Sensor Data Error)</td> <td>None</td> <td>Yes</td> </tr> </tbody> </table>	Bit	Description	FALSE (0)	TRUE (1)	0	SE (Sensor Error)	None	Yes	1-12	Reserved	—		13	SSE (Disconnected Sensor Error)	None	Yes	14	SPF (Sensor Circuit Power Error)	None	Yes	15	DE (Sensor Data Error)	None	Yes
Bit	Description	FALSE (0)	TRUE (1)																										
0	SE (Sensor Error)	None	Yes																										
1-12	Reserved	—																											
13	SSE (Disconnected Sensor Error)	None	Yes																										
14	SPF (Sensor Circuit Power Error)	None	Yes																										
15	DE (Sensor Data Error)	None	Yes																										
0x2D	Supported Alarms	○	—	WORD	Indicates error detection information which is supported. <table border="1" data-bbox="896 1321 1444 1482"> <thead> <tr> <th>Bit</th> <th>Description</th> <th>FALSE (0)</th> <th>TRUE (1)</th> </tr> </thead> <tbody> <tr> <td>0</td> <td>SE (Sensor Error)</td> <td>None</td> <td>Yes</td> </tr> <tr> <td>1-12</td> <td>Reserved</td> <td colspan="2">—</td> </tr> </tbody> </table>	Bit	Description	FALSE (0)	TRUE (1)	0	SE (Sensor Error)	None	Yes	1-12	Reserved	—													
Bit	Description	FALSE (0)	TRUE (1)																										
0	SE (Sensor Error)	None	Yes																										
1-12	Reserved	—																											
0x2E	Alarm Flag	○	—	BOOL	Indicates an error detection state 0: No error 1: With error * The flag is the logical sum of all alarm bits of 0x2C (Alarm).																								
0x64	AxisUnavailable	○	○	BOOL	Specify "Enable" or "Disable" for the axis. 0: Enable (Default) 1: Disable																								
0x65	Error Clear	○	○	BOOL	Specify "Error recovery behavior". 0: Auto clearing (Default) Automatically clears the error when removing the cause of the error. 1: Manual clearing																								
0x96	Reserved	○	—	DINT	Reserved																								

APPENDIX 2-7. QoS Object (Class ID: 0x48)

The QoS object provides relative priority setting information of different transmission traffics.

A transmission traffic priority can be adjusted by a managed switch on the network when the relative priority is set.

The relative priority is specified by the QoS object attribute setting.

NCW-3DNIP uses DiffServ (QoS) (redefinition of the "ToS" field in IP head). Packets are classified by elements, and priorities (64 steps) are defined for each group. The packet transmission is executed according to the definition. (NCW-3DNIP doesn't support the 802.1Q tag.).

Note

Restart the power supply when settings are changed.

Following tables indicate specifications of the QoS object.

The QoS object has one instance.

Class Attribute (Class ID: 0x48)

ID	Name	Access		Data Type	Description
		Get	Set		
0x01	Revision	○	—	UINT	1
0x02	Max Instance	○	—	UINT	1
0x03	Number of Instances	○	—	UINT	1

Class Service (Class ID: 0x48, Instance ID: 0x00)

ID	Name	Description
0x0E	Get_Attribute_Single	Read out one attribute value from NCW-3DNIP.

Instance Attribute (Class ID: 0x48, Instance ID: 0x01)

ID	Name	Access		Data Type	Description
		Get	Set		
0x04	DSCP Urgent	○	○	USINT	Set the DSCP value for CIP transport class 0/1 messages with Urgent priority. Default: 55 (110 11 1b) This setting is invalid for NCW-3DNIP.
0x05	DSCP Scheduled	○	○	USINT	Set the DSCP value for CIP transport class 0/1 messages with Scheduled priority. Default: 47 (101 11 1b) This setting is invalid for NCW-3DNIP.
0x06	DSCP High	○	○	USINT	Set the DSCP value for CIP transport class 0/1 messages with High priority. Default: 43 (101 01 1b) This setting is for NCW-3DNIP I/O traffic.
0x07	DSCP Low	○	○	USINT	Set the DSCP value for CIP transport class 0/1 messages with Low priority. Default: 31 (011 11 1b) This setting is invalid for NCW-3DNIP.
0x08	DSCP Explicit	○	○	USINT	Set the DSCP value for CIP Explicit messages (Transport Class 2/3 and UCMM). Default: 27 (011 01 1b) This attribute setting is for NCW-3DNIP Explicit message traffic.

Instance Service (Class ID: 0x48, Instance ID: 0x01)

ID	Name	Description
0x0E	Get_Attribute_Single	Read out one attribute value from NCW-3DNIP.
0x10	Set_Attribute_Single	Write one attribute value to NCW-3DNIP.

● Complement (DSCP value)

A packet priority allocation is classified for each DSCP value by a definition is called "PHB(Per-Hop Behavior)".
 Default values for general Ethernet and Ethernet/IP are shown below

PHB	DSCP value	Description	
	Bit5-3: high priority class Bit2-1: packet discard rate Bit0: Standard / Test		
■ General Ethernet definition			
AF(Assured Forwarding)	AF11	001 01 0b(10)	If the first 3 bits are larger, the priority will become higher. If the last 3 bits are larger, the discard priority will become higher.
	AF12	001 10 0b(12)	
	AF13	001 11 0b(14)	
	AF21	010 01 0b(18)	
	AF22	010 10 0b(20)	
	AF23	010 11 0b(22)	
	AF31	011 01 0b(26)	
	AF32	011 10 0b(28)	
	AF33	011 11 0b(30)	
	AF41	100 01 0b(34)	
	AF42	100 10 0b(36)	
AF43	100 11 0b(38)		
EF(Expedited Forwarding)	101 11 0b(46)	It means the highest priority packet.	
■ Ethernet/IP CIP definition			
CIP UCMM CIP Transport Class 3 All Other EIP Encapsulation Message	011 01 1b(27)	<u>CIP Explicit message transmitting *1</u>	
CIP Transport Class 0/1	Low(0)	011 11 1b(31)	Unrecommanded to use
	High(1)	101 01 1b(43)	<u>CIP I/O (CIP Implicit message) transmitting*1</u>
	Scheduled(2)	101 11 1b(47)	For CIP Safty I/O (CIP Implicitmessage) transmitting For CIP I/O (CIP Implicit message) transmitting
	Urgent(3)	110 11 1b(55)	For CIP Motion transmitting

*1: PHB for NCW-3DNIP

APPENDIX 2-8. TCP/IP Interface Object (Class ID: 0xF5)

The TCP/IP interface object provides Ethernet TCP/IP interface information.

The TCP/IP Interface Object provides the mechanism to configure the NCW-3DNIP's TCP/IP network interface (IP address, network mask, and gateway address).

Following tables indicate specifications of the TCP/IP Interface object.

The TCP/IP Interface object has one instance.

Class Attribute (Class ID: 0xF5)

ID	Name	Access		Data Type	Description
		Get	Set		
0x01	Revision	○	—	UINT	4
0x02	Max Instance	○	—	UINT	1
0x03	Number of Instances	○	—	UINT	1

Class Service (Class ID: 0xF5, Instance ID: 0x00)

ID	Name	Description
0x01	Get_Attribute_All	Read out all attribute values from NCW-3DNIP.
0x0E	Get_Attribute_Single	Read out one attribute value from NCW-3DNIP.

Instance Attribute (Class ID: 0xF5, Instance ID: 0x01)

(1/4)

ID	Name	Access		Data Type	Description								
		Get	Set										
0x01	Status	○	—	DWORD	<p>Current status of NCW-3DNIP This attribute value changes due to the converter state.</p> <table border="1"> <thead> <tr> <th>Bit</th> <th>Description</th> </tr> </thead> <tbody> <tr> <td>0-3</td> <td> <p>Interface Configuration Status Indicates the status of the Interface Configuration Attribute. 0: The Interface Configuration attribute has not been configured. (It doesn't occur for NCW-3DNIP.) 1: The Interface Configuration attribute contains configuration obtained from BOOTP, DHCP or non-volatile storage. 2: The IP address member of the Interface Configuration attribute contains configuration, obtained from hardware settings. 3-15: Reserved</p> </td> </tr> <tr> <td>4</td> <td> <p>Mcast Pending NCW-3DNIP doesn't support. (Fixed at 0)</p> </td> </tr> <tr> <td>5</td> <td> <p>Interface Configuration Pending TRUE (1) when Interface Configuration attribute values are changed. The NCW-3DNIP requires a restart in order for the configuration change to take effect.</p> </td> </tr> </tbody> </table>	Bit	Description	0-3	<p>Interface Configuration Status Indicates the status of the Interface Configuration Attribute. 0: The Interface Configuration attribute has not been configured. (It doesn't occur for NCW-3DNIP.) 1: The Interface Configuration attribute contains configuration obtained from BOOTP, DHCP or non-volatile storage. 2: The IP address member of the Interface Configuration attribute contains configuration, obtained from hardware settings. 3-15: Reserved</p>	4	<p>Mcast Pending NCW-3DNIP doesn't support. (Fixed at 0)</p>	5	<p>Interface Configuration Pending TRUE (1) when Interface Configuration attribute values are changed. The NCW-3DNIP requires a restart in order for the configuration change to take effect.</p>
Bit	Description												
0-3	<p>Interface Configuration Status Indicates the status of the Interface Configuration Attribute. 0: The Interface Configuration attribute has not been configured. (It doesn't occur for NCW-3DNIP.) 1: The Interface Configuration attribute contains configuration obtained from BOOTP, DHCP or non-volatile storage. 2: The IP address member of the Interface Configuration attribute contains configuration, obtained from hardware settings. 3-15: Reserved</p>												
4	<p>Mcast Pending NCW-3DNIP doesn't support. (Fixed at 0)</p>												
5	<p>Interface Configuration Pending TRUE (1) when Interface Configuration attribute values are changed. The NCW-3DNIP requires a restart in order for the configuration change to take effect.</p>												

ID	Name	Access		Data Type	Description																
		Get	Set																		
0x02	Configuration Capability	○	—	DWORD	<p>Fixed at 0x00000075</p> <p>The following table indicates the function which is supported by NCW-3DNIP.</p> <table border="1"> <thead> <tr> <th>Bit</th> <th>Description</th> </tr> </thead> <tbody> <tr> <td>0</td> <td> <p><u>BOOTP Client</u></p> <p>1: Indicates that NCW-3DNIP is capable of obtaining its network configuration via BOOTP.</p> </td> </tr> <tr> <td>1</td> <td> <p><u>DNS Client</u></p> <p>0: Indicates NCW-3DNIP can not obtain host names from DNS server.</p> </td> </tr> <tr> <td>2</td> <td> <p><u>DHCP Client</u></p> <p>1: Indicates NCW-3DNIP is capable of obtaining its network configuration via DHCP.</p> </td> </tr> <tr> <td>3</td> <td> <p><u>DHCP-DNS Update</u></p> <p>0: Indicates NCW-3DNIP cannot return own host name by the DHCP request.</p> </td> </tr> <tr> <td>4</td> <td> <p><u>Configuration Settable</u></p> <p>1: Indicates the Interface Configuration attribute is settable.</p> </td> </tr> <tr> <td>5</td> <td> <p><u>Hardware Configurable</u></p> <p>1: Indicates the IP Address number of the Interface Configuration attribute can be obtained from hardware settings.</p> </td> </tr> <tr> <td>6</td> <td> <p><u>Interface Configuration Change Requires Reset</u></p> <p>1: Indicates that NCW-3DNIP requires a restart in order for a change to the Interface Configuration attribute to take effect.</p> </td> </tr> </tbody> </table>	Bit	Description	0	<p><u>BOOTP Client</u></p> <p>1: Indicates that NCW-3DNIP is capable of obtaining its network configuration via BOOTP.</p>	1	<p><u>DNS Client</u></p> <p>0: Indicates NCW-3DNIP can not obtain host names from DNS server.</p>	2	<p><u>DHCP Client</u></p> <p>1: Indicates NCW-3DNIP is capable of obtaining its network configuration via DHCP.</p>	3	<p><u>DHCP-DNS Update</u></p> <p>0: Indicates NCW-3DNIP cannot return own host name by the DHCP request.</p>	4	<p><u>Configuration Settable</u></p> <p>1: Indicates the Interface Configuration attribute is settable.</p>	5	<p><u>Hardware Configurable</u></p> <p>1: Indicates the IP Address number of the Interface Configuration attribute can be obtained from hardware settings.</p>	6	<p><u>Interface Configuration Change Requires Reset</u></p> <p>1: Indicates that NCW-3DNIP requires a restart in order for a change to the Interface Configuration attribute to take effect.</p>
Bit	Description																				
0	<p><u>BOOTP Client</u></p> <p>1: Indicates that NCW-3DNIP is capable of obtaining its network configuration via BOOTP.</p>																				
1	<p><u>DNS Client</u></p> <p>0: Indicates NCW-3DNIP can not obtain host names from DNS server.</p>																				
2	<p><u>DHCP Client</u></p> <p>1: Indicates NCW-3DNIP is capable of obtaining its network configuration via DHCP.</p>																				
3	<p><u>DHCP-DNS Update</u></p> <p>0: Indicates NCW-3DNIP cannot return own host name by the DHCP request.</p>																				
4	<p><u>Configuration Settable</u></p> <p>1: Indicates the Interface Configuration attribute is settable.</p>																				
5	<p><u>Hardware Configurable</u></p> <p>1: Indicates the IP Address number of the Interface Configuration attribute can be obtained from hardware settings.</p>																				
6	<p><u>Interface Configuration Change Requires Reset</u></p> <p>1: Indicates that NCW-3DNIP requires a restart in order for a change to the Interface Configuration attribute to take effect.</p>																				
0x03	Configuration Control	○	○	DWORD	<p>Configures a NCW-3DNIP network setting option control.</p> <p><u>This attribute is stored in the non-volatile memory.</u></p> <table border="1"> <thead> <tr> <th>Bit</th> <th>Description</th> </tr> </thead> <tbody> <tr> <td>0-3</td> <td> <p><u>Startup Configuration</u></p> <p>0: The device use the previously saved interface setting value. (Such as the value in the non-volatile memory or the value of the hardware switch)</p> <p>1: The device obtain its interface configuration values via BOOTP.</p> <p>2: The device obtain its interface configuration values via DHCP. (Default)</p> <p>3-15: Reserved</p> </td> </tr> <tr> <td>4</td> <td> <p><u>DNS Enable</u></p> <p>NCW-3DNIP doesn't support.</p> </td> </tr> </tbody> </table>	Bit	Description	0-3	<p><u>Startup Configuration</u></p> <p>0: The device use the previously saved interface setting value. (Such as the value in the non-volatile memory or the value of the hardware switch)</p> <p>1: The device obtain its interface configuration values via BOOTP.</p> <p>2: The device obtain its interface configuration values via DHCP. (Default)</p> <p>3-15: Reserved</p>	4	<p><u>DNS Enable</u></p> <p>NCW-3DNIP doesn't support.</p>										
Bit	Description																				
0-3	<p><u>Startup Configuration</u></p> <p>0: The device use the previously saved interface setting value. (Such as the value in the non-volatile memory or the value of the hardware switch)</p> <p>1: The device obtain its interface configuration values via BOOTP.</p> <p>2: The device obtain its interface configuration values via DHCP. (Default)</p> <p>3-15: Reserved</p>																				
4	<p><u>DNS Enable</u></p> <p>NCW-3DNIP doesn't support.</p>																				

ID	Name	Access		Data Type	Description	
		Get	Set			
0x04	Physical Link Object	○	—	Structure	Identifies an object (Ethernet Link Object) related to the physical interface. The path indicates the Instance 1 of the Ethernet Link Object class.	
				UINT	Path Size	2
				Packed EPATH	Path	"20 F6 24 01"
0x05	Interface Configuraton	○	○	Structure	NCW-3DNIP configures necessary settings as a TCP/IP node. Bit5 (Interface Configuration Pending) of Attribute 1(Status) will be TRUE (1) if the settings are valid. Reset Service (0x05) of the Identify object must be requested when activating settings. <u>This attribute is stored in the non-volatile memory.</u>	
				UDINT	IP Address	IP address (host address) *: This attribute is invalid when the IP address is set to a value at [ADR] rotary switch on the NCW-3DNIP panel side except "0".
				UDINT	Network Mask	Network mask
				UDINT	Gateway Address	Gateway IP address
				UDINT	Name Server	Primary DNS server IP address
				UDINT	Name Server2	Secondary DNS server IP address
				STRING	Domain Name	"nsdcorp.co.jp" (default) Default domain name The name should be less than 48 characters, and a length should be padded to the nearest even number. (The pad is not including in the length.) The Domain Name is not configured when the length is 0.
0x06	Host Name	○	○	STRING	"NCW-3DNIP" (default) A NCW-3DNIP host name is configured. <u>This attribute is stored in the non-volatile memory.</u> The name should be less than 64 characters, and a length should be padded to the nearest even number. (The pad is not including in the length.) *:A NCW-3DNIP doesn't support the DHCP-DNS update function.	
0x07	Safety Network Number	—	—	USINT[6]	NCW-3DNIP doesn't support this attribute.	
0x08	TTL Value	—	—	USINT	NCW-3DNIP doesn't support this attribute.	

ID	Name	Access		Data Type	Description
		Get	Set		
0x09	Mcast Config	—	—	Structure	NCW-3DNIP doesn't support this attribute.
				USINT	
				USINT	
				UDINT	
0x0A	Select ACD	—	—	BOOL	NCW-3DNIP doesn't support this attribute.
0x0B	LastConflictDetected	—	—	Structure	NCW-3DNIP doesn't support this attribute.
				USINT	
				USINT[6]	
				USINT[28]	
0x0C	EIP Quick Connect	—	—	BOOL	NCW-3DNIP doesn't support this attribute.
0x0D	Encapsulation Inactivity Timeout	○	○	UINT	<p>The TCP socket is cleaned up (closed) when an encapsulation operation is not detected within the setting time (second).</p> <p>Setting range: 0 to 3600s</p> <p>0: No Timeout detection</p> <p>Default: 120</p> <p><u>This attribute is stored in the non-volatile memory.</u></p>

Instance Service (Class ID: 0xF5, Instance ID: 0x01)

ID	Name	Description
0x01	Get_Attribute_All	Read out all attribute values from NCW-3DNIP.
0x0E	Get_Attribute_Single	Read out one attribute value from NCW-3DNIP.
0x10	Set_Attribute_Single	Write one attribute value to NCW-3DNIP.

APPENDIX 2-9. Ethernet Link Object (Class ID: 0xF6)

The Ethernet Link object provides Ethernet Interface's MAC address, communication speed and format status information.

Following tables indicate specifications of the Ethernet Link object.
NCW-3DNIP has two ports, so the Ethernet Link object has two instances.

Class Attribute (Class ID: 0xF6)

ID	Name	Access		Data Type	Description
		Get	Set		
0x01	Revision	○	—	UINT	4
0x02	Max Instance	○	—	UINT	2 (2 ports)
0x03	Number of Instances	○	—	UINT	2 (2 ports)

Class Service(Class ID: 0xF6, Instance ID: 0x00)

ID	Name	Description
0x01	Get_Attribute_All	Read out all attribute values from NCW-3DNIP.
0x0E	Get_Attribute_Single	Read out one attribute value from NCW-3DNIP.

ID	Name	Access		Data Type	Description												
		Get	Set														
0x01	Interface Speed	○	—	UDINT	NCW-3DNIP's current state Speed value (Mbps): 0, 10, 100, 1000, and etc...												
0x02	Interface Flag	○	—	DWORD	NCW-3DNIP's current state <table border="1" data-bbox="887 405 1445 1570"> <thead> <tr> <th>Bit</th> <th>Description</th> </tr> </thead> <tbody> <tr> <td>0</td> <td><u>Link Status</u> Indicates the status of link 0: Inactive link 1: Active link</td> </tr> <tr> <td>1</td> <td><u>Half/Full Duplex</u> Indicates the duplex mode 0: Half duplex 1: Full duplex</td> </tr> <tr> <td>2-4</td> <td><u>Negotiation Status</u> Indicates the status of negotiation 0: Auto-negotiation in progress. 1: Auto-negotiation and speed detection failed. A default value of the Speed/Duplex when the detection is faulty: 10Mbps, half duplex 2: Auto negotiation failed but detected speed. Default value of the Duplex when detection is fault: half duplex 3: Successfully negotiated speed and duplex. 4: Auto-negotiation not attempted. Force Speed / Force Interface Speed value is used.</td> </tr> <tr> <td>5</td> <td><u>Manual Setting Requires Speed</u> Fixed at 0 Duplex, Speed Indicates the setting reflected status setting. 0: Auto-Negotiation / Duplex / Speed are automatically activated. 1: Indicates that you must issue a Reset service to the Identity object to activate the change.</td> </tr> <tr> <td>6</td> <td><u>Local Hardware Fault</u> Indicates the fault status of NCW-3DNIP. 0: Fault is not detected. 1: Fault is detected. This is assumed a hard-fault requiring user intervention.</td> </tr> </tbody> </table>	Bit	Description	0	<u>Link Status</u> Indicates the status of link 0: Inactive link 1: Active link	1	<u>Half/Full Duplex</u> Indicates the duplex mode 0: Half duplex 1: Full duplex	2-4	<u>Negotiation Status</u> Indicates the status of negotiation 0: Auto-negotiation in progress. 1: Auto-negotiation and speed detection failed. A default value of the Speed/Duplex when the detection is faulty: 10Mbps, half duplex 2: Auto negotiation failed but detected speed. Default value of the Duplex when detection is fault: half duplex 3: Successfully negotiated speed and duplex. 4: Auto-negotiation not attempted. Force Speed / Force Interface Speed value is used.	5	<u>Manual Setting Requires Speed</u> Fixed at 0 Duplex, Speed Indicates the setting reflected status setting. 0: Auto-Negotiation / Duplex / Speed are automatically activated. 1: Indicates that you must issue a Reset service to the Identity object to activate the change.	6	<u>Local Hardware Fault</u> Indicates the fault status of NCW-3DNIP. 0: Fault is not detected. 1: Fault is detected. This is assumed a hard-fault requiring user intervention.
Bit	Description																
0	<u>Link Status</u> Indicates the status of link 0: Inactive link 1: Active link																
1	<u>Half/Full Duplex</u> Indicates the duplex mode 0: Half duplex 1: Full duplex																
2-4	<u>Negotiation Status</u> Indicates the status of negotiation 0: Auto-negotiation in progress. 1: Auto-negotiation and speed detection failed. A default value of the Speed/Duplex when the detection is faulty: 10Mbps, half duplex 2: Auto negotiation failed but detected speed. Default value of the Duplex when detection is fault: half duplex 3: Successfully negotiated speed and duplex. 4: Auto-negotiation not attempted. Force Speed / Force Interface Speed value is used.																
5	<u>Manual Setting Requires Speed</u> Fixed at 0 Duplex, Speed Indicates the setting reflected status setting. 0: Auto-Negotiation / Duplex / Speed are automatically activated. 1: Indicates that you must issue a Reset service to the Identity object to activate the change.																
6	<u>Local Hardware Fault</u> Indicates the fault status of NCW-3DNIP. 0: Fault is not detected. 1: Fault is detected. This is assumed a hard-fault requiring user intervention.																
0x03	Physical Address	○	—	USINT[6]	MAC address of NCW-3DNIP (E8-8E-60-xx-xx-xx) *: NCW-3DNIP has two ports, but the Physical address is one.												

ID	Name	Access		Data Type	Description
		Get	Set		
0x04	Interface Counters	—	—	Structure	NCW-3DNIP doesn't support this attribute.
				UDINT	
				UDINT	
				UDINT	
				UDINT	
				UDINT	
				UDINT	
				UDINT	
				UDINT	
				UDINT	
				UDINT	
				UDINT	
0x05	Media Counters	—	—	Structure	NCW-3DNIP doesn't support this attribute.
				UDINT	
				UDINT	
				UDINT	
				UDINT	
				UDINT	
				UDINT	
				UDINT	
				UDINT	
				UDINT	
				UDINT	
				UDINT	
0x06	Interface Control	—	—	Structure	NCW-3DNIP doesn't support this attribute.
				WORD	
				UINT	
0x07	Interface Type	—	—	USINT	NCW-3DNIP doesn't support this attribute.
0x08	Interface State	—	—	USINT	NCW-3DNIP doesn't support this attribute.
0x09	Admin State	—	—	USINT	NCW-3DNIP doesn't support this attribute.

ID	Name	Access		Data Type	Description	
		Get	Set			
0x0A	Interface Label	○	—	SHORT_STRING	Interface identifier Instance 0x01: "Port1" Instance 0x02: "Port2"	
0x0B	Interface Capability	○	—	Structure	Interface function	
				DWORD	[Capability Bits] The values (Bit0:0, Bit1:1, Bit2:1, and Bit3:0) are fixed. Indicates interface functions other than Speed / Duplex. Bit0: Manual Setting Requires Reset Bit1: Auto-negotiate Bit2: Auto-MDIX Bit3: Manual Speed/Duplex Bit4-31: Reserved	
				Structure	[Speed/Duplex Options] A pair of Speed/Duplex supported by Interface Control attributes	
				USINT	[Speed/Duplex element number] Fixed at 4	
				Structure [0]	UINT	[Interface Speed] Same contents as the Forced Interface Speed of the Interface Control Attribute (Element 0): 10
					USINT	[Interface Duplex Mode] 0: Half Duplex 1: Full Duplex 2-255: Reserved (Element 0):0
				Structure [1]	UINT	[Interface Speed] (Element 1): 10
					USINT	[Interface Duplex Mode] (Element 1): 1
				Structure [2]	UINT	[Interface Speed] (Element 2): 100
					USINT	[Interface Duplex Mode] (Element 2): 0
				Structure [3]	UINT	[Interface Speed] (Element 3): 100
					USINT	[Interface Duplex Mode] (Element 3): 1

Instance Service (Class ID: 0xF6, Instance ID: 0x01, 0x02)

ID	Name	Description
0x01	Get_Attribute_All	Read out all attribute values from NCW-3DNIP.
0x0E	Get_Attribute_Single	Read out one attribute value from NCW-3DNIP.

APPENDIX 2-10.Info Log Object (Class ID: 0xC5)

Info Log object provides NCW-3DNIP operation and error histories (max.32).
Stored information is saved in the non-volatile memory.

Following tables indicate specifications of the Info Log object.
Info Log object has one instance.

Class Attribute (Class ID: 0xC5)

ID	Name	Access		Data Type	Description
		Get	Set		
0x01	Revision	○	—	UINT	1
0x02	Max Instance	○	—	UINT	1
0x03	Number of Instances	○	—	UINT	1

Class Service (Class ID: 0xC5, Instance ID: 0x00)

ID	Name	Description
0x01	Get_Attribute_All	Read out all attribute values from NCW-3DNIP.
0x0E	Get_Attribute_Single	Read out one attribute value from NCW-3DNIP.

Instance Attribute (Class ID: 0xC5, Instance ID: 0x01)

ID	Name	Access		Data Type	Description
		Get	Set		
0x01	LOG Data 1 (Newest LOG data)	○	—	Structure	History data 1
				UDINT	History message code 1
				UDINT	Cumulative energization system time (unit: sec)
				STRING	History message
~	~	○	—	~	~ (History data 2 to 31)
0x20	LOG Data 32 (Oldest LOG data)	○	—	Structure	History data 32
				UDINT	History message code 32
				UDINT	Cumulative energization system time (unit: sec)
				STRING	History message

Instance Service (Class ID: 0xC5, Instance ID: 0x01)

ID	Name	Description
0x0E	Get_Attribute_Single	Read out one attribute value from NCW-3DNIP.

History message code (Hex)	History message	Message details
0x00000001	Power ON	The power was applied.
0x00000002	Power FAIL	A low power supply was detected.
0x00000003 - 0x0000000E	—	
0x0000000F	IP Address CONFLICT	IP Address CONFLICT was detected.
0x00000010	LINK1 Settings - AUTO	LINK1 port settings is "AUTO"
0x00000011	LINK1 Settings - MANUAL	LINK1 port settings is "MANUAL"
0x00000012	LINK1 Settings - 100Mbps	LINK1 port speed rate is "100Mbps"
0x00000013	LINK1 Settings - 10Mbps	LINK1 port speed rate is "10Mbps"
0x00000014	LINK1 Settings – Full Duplex	LINK1 port transmit format is "Full Duplex"
0x00000015	LINK1 Settings – Half Duplex	LINK1 port transmit format is "Half Duplex"
0x00000016	LINK2 Settings - AUTO	LINK2 port settings is "AUTO"
0x00000017	LINK2 Settings - MANUAL	LINK2 port settings is "MANUAL"
0x00000018	LINK2 Settings - 100Mbps	LINK2 port speed rate is "100Mbps"
0x00000019	LINK2 Settings - 10Mbps	LINK2 port speed rate is "10Mbps"
0x0000001A	LINK2 Settings – Full Duplex	LINK2 port transmit format is "Full Duplex"
0x0000001B	LINK2 Settings – Half Duplex	LINK2 port transmit format is "Half Duplex"
0x00000020	LINK1 Port is a LinkUP	LINK1 Port was Linked up.
0x00000021	LINK1 Port is a LinkDOWN	LINK1 Port was Linked down
0x00000022	LINK2 Port is a LinkUP	LINK2 Port was Linked up.
0x00000023	LINK2 Port is a LinkDOWN	LINK2 Port was Linked down
0x00000030	IP Address Assign Mode - SWITCH	IP Address Assign Mode is "SWITCH"
0x00000031	IP Address Assign Mode - Disable BOOTP / DHCP	IP Address Assign Mode is "Disable BOOTP / DHCP"
0x00000032	IP Address Assign Mode - BOOTP	IP Address Assign Mode is "BOOTP"
0x00000033	IP Address Assign Mode - DHCP	IP Address Assign Mode is "DHCP"
0x00000040	State in SELFTEST	State became into "SELFTEST"
0x00000041	State in NETBOOT	State became into "NETBOOT"
0x00000042	State in BOOTP	State became into "BOOTP"
0x00000043	State in DHCP	State became into "DHCP"
0x00000044	State in NETINIT	State became into "NETINIT"
0x00000045	—	
0x00000046	State in OPERATIONAL	State became into "OPERATIONAL"
0x00000047	State in MINOR RECOVERABLE FAULT	State became into "MINOR RECOVERABLE FAULT"
0x00000048	State in MAJOR UNRECOVERABLE FAULT	State became into MAJOR UNRECOVERABLE FAULT
0x00000050	Access to an Identity OBJECT	An Identity OBJECT was accessed.
0x00000051	Access to an Assembly OBJECT	An Assembly OBJECT was accessed.
0x00000052	Access to a Connection Manager OBJECT	A Connection Manager OBJECT was accessed.

History message code (Hex)	History message	Message details
0x00000053	Access to a Parameter OBJECT	A Parameter OBJECT was accessed.
0x00000054	Access to a QoS OBJECT	A QoS OBJECT was accessed.
0x00000055	Access to an ABSOCODER OBJECT	An ABSOCODER OBJECT was accessed.
0x00000056	—	
0x00000057	Access to an Info Diagnosis OBJECT	An Info Diagnosis OBJECT was accessed.
0x00000058	Access to an Info Maintenance OBJECT	An Info Maintenance OBJECT was accessed.
0x00000059	—	—
0x0000005A	Access to a TCP/IP Interface OBJECT	A TCP/IP Interface OBJECT was accessed.
0x0000005B	Access to an Ethernet Link OBJECT	An Ethernet Link OBJECT was accessed.
0x00000060	I/O Transmission Start	An I/O transmission was started
0x00000061	I/O Transmission End	An I/O transmission was ended
0x00000070 - 0x00000075	—	
0x00000076	1Axis ERRCLR	An axis-1 ERRCLR was Received.
0x00000077	1Axis PRESET	An axis-1 PRESET was Received.
0x00000078 - 0x0000007D	—	
0x0000007E	2Axis ERRCLR	An axis-2 ERRCLR was Received.
0x0000007F	2Axis PRESET	An axis-2 PRESET was Received.
0x00000080	NRDY	A NRDY was Detected.
0x00000081	WDTE	A WDTE was Detected.
0x00000082	ME	A ME was Detected.
0x00000083 - 0x00000087	—	
0x00000088	I/F ERR	An I/F ERR was Detected.
0x00000089 - 0x0000008F	—	
0x00000090	I/F ERR - Timeout	An I/F ERR (Timeout) was Detected.
0x00000091	I/F ERR - Unknown Command	An I/F ERR (Unknown Command) was Detected.
0x00000092	I/F ERR - CheckSum Error [Sensor to Ethernet]	An I/F ERR (CheckSum Error) was Detected.
0x00000093	I/F ERR - CheckSum Error [Ethernet to Sensor]	An I/F ERR (CheckSum Error) was Detected.
0x000000A0	1Axis SE	An axis-1 sensor error was Detected.
0x000000A1 - 0x000000A4	—	
0x000000A5	1Axis SSE	An axis-1 sensor error (Disconnected Sensor Error) was Detected.
0x000000A6	1Axis SPF	An axis-1 sensor error (Sensor Circuit Power Error) was Detected.
0x000000A7	1Axis DE	An axis-1 sensor error (Sensor Data Error) was Detected.
0x000000A8	2Axis SE	An axis-2 sensor error was Detected.
0x000000A9 - 0x000000AC	—	
0x000000AD	2Axis SSE	An axis-2 sensor error (Disconnected Sensor Error) was Detected.
0x000000AE	2Axis SPF	An axis-2 sensor error (Sensor Circuit Power Error) was Detected.
0x000000AF	2Axis DE	An axis-2 sensor error (Sensor Data Error) was Detected.

APPENDIX 2-11. Info Diagnosis Object (Class ID: 0xC6)

This object provides NCW-3DNIP diagnosis information.

Following tables indicate specifications of the Info Diagnosis object.
The Info Diagnosis object has one instance.

Class Attribute (Class ID: 0xC6)

ID	Name	Access		Data Type	Description
		Get	Set		
0x01	Revision	○	—	UINT	1
0x02	Max Instance	○	—	UINT	1
0x03	Number of Instances	○	—	UINT	1

Class Service (Class ID: 0xC6, Instance ID: 0x00)

ID	Name	Description
0x01	Get_Attribute_All	Read out all attribute values from NCW-3DNIP.
0x0E	Get_Attribute_Single	Read out one attribute value from NCW-3DNIP.

Instance Attribute (Class ID: 0xC6, Instance ID: 0x01)

ID	Name	Access		Data Type	Description																																		
		Get	Set																																				
0x01	Sensor Circuit Status	○	—	UDINT	<p>Indicates the sensor circuit status.</p> <table border="1"> <thead> <tr> <th>Bit</th> <th>Description</th> </tr> </thead> <tbody> <tr> <td>0</td> <td>NRDY (Internal Error)</td> </tr> <tr> <td>1</td> <td>WDTE (Watchdog Timer Error)</td> </tr> <tr> <td>2</td> <td>ME (Memory Error)</td> </tr> <tr> <td>3-7</td> <td>Reserved</td> </tr> <tr> <td>8</td> <td>I/F ERR (Internal I/F Error)</td> </tr> <tr> <td>9-15</td> <td>Reserved</td> </tr> <tr> <td>16</td> <td>Axis-1 SE (Sensor Error)</td> </tr> <tr> <td>17-20</td> <td>Reserved</td> </tr> <tr> <td>21</td> <td>Axis-1 SSE (Disconnected Sensor Error)</td> </tr> <tr> <td>22</td> <td>Axis-1 SPF (Sensor Circuit Power Error)</td> </tr> <tr> <td>23</td> <td>Axis-1 DE (Sensor Data Error)</td> </tr> <tr> <td>24</td> <td>Axis-2 SE (Sensor Error)</td> </tr> <tr> <td>25-28</td> <td>Reserved</td> </tr> <tr> <td>29</td> <td>Axis-2 SSE (Disconnected Sensor Error)</td> </tr> <tr> <td>30</td> <td>Axis-2 SPF (Sensor Circuit Power Error)</td> </tr> <tr> <td>31</td> <td>Axis-2 DE (Sensor Data Error)</td> </tr> </tbody> </table>	Bit	Description	0	NRDY (Internal Error)	1	WDTE (Watchdog Timer Error)	2	ME (Memory Error)	3-7	Reserved	8	I/F ERR (Internal I/F Error)	9-15	Reserved	16	Axis-1 SE (Sensor Error)	17-20	Reserved	21	Axis-1 SSE (Disconnected Sensor Error)	22	Axis-1 SPF (Sensor Circuit Power Error)	23	Axis-1 DE (Sensor Data Error)	24	Axis-2 SE (Sensor Error)	25-28	Reserved	29	Axis-2 SSE (Disconnected Sensor Error)	30	Axis-2 SPF (Sensor Circuit Power Error)	31	Axis-2 DE (Sensor Data Error)
Bit	Description																																						
0	NRDY (Internal Error)																																						
1	WDTE (Watchdog Timer Error)																																						
2	ME (Memory Error)																																						
3-7	Reserved																																						
8	I/F ERR (Internal I/F Error)																																						
9-15	Reserved																																						
16	Axis-1 SE (Sensor Error)																																						
17-20	Reserved																																						
21	Axis-1 SSE (Disconnected Sensor Error)																																						
22	Axis-1 SPF (Sensor Circuit Power Error)																																						
23	Axis-1 DE (Sensor Data Error)																																						
24	Axis-2 SE (Sensor Error)																																						
25-28	Reserved																																						
29	Axis-2 SSE (Disconnected Sensor Error)																																						
30	Axis-2 SPF (Sensor Circuit Power Error)																																						
31	Axis-2 DE (Sensor Data Error)																																						
0x02	Ethernet Circuit Status	○	—	UINT	<p>Indicates the Ethernet circuit status.</p> <table border="1"> <thead> <tr> <th>Bit</th> <th>Description</th> </tr> </thead> <tbody> <tr> <td>0-15</td> <td>Reserved</td> </tr> </tbody> </table>	Bit	Description	0-15	Reserved																														
Bit	Description																																						
0-15	Reserved																																						
0x03	Sensor - Ethernet Circuit Interface Status			UINT	<p>Indicates the I/F status between sensor and Ethernet circuits.</p> <p>0: No error 1: Timeout error (No response from sensor circuit) 2: command error 3: checksum error (Data from sensor circuit to Ethernet circuit) 4: checksum error (Data from Ethernet circuit to sensor circuit)</p>																																		

Instance Service (Class ID: 0xC6, Instance ID: 0x01)

ID	Name	Description
0x01	Get_Attribute_All	Read out all attribute values from NCW-3DNIP.
0x0E	Get_Attribute_Single	Read out one attribute value from NCW-3DNIP.

APPENDIX 2-12. Info Maintenance Object (Class ID: 0xC7)

Stores NCW-3DNIP maintenance information in this object.
The maintenance information is saved in the non-volatile memory.

Following tables indicate specifications of the Info Maintenance object.
The Info Maintenance object has one instance.

Class Attribute (Class ID: 0xC7)

ID	Name	Access		Data Type	Description
		Get	Set		
0x01	Revision	○	—	UINT	1
0x02	Max Instance	○	—	UINT	1
0x03	Number of Instances	○	—	UINT	1

Class Service (Class ID: 0xC7, Instance ID: 0x00)

ID	Name	Description
0x01	Get_Attribute_All	Read out all attribute values from NCW-3DNIP.
0x0E	Get_Attribute_Single	Read out one attribute value from NCW-3DNIP.

Instance Attribute (Class ID: 0xC7, Instance ID: 0x01)

ID	Name	Access		Data Type	Description
		Get	Set		
0x01	Power Distribution Time	○	—	UDINT	NCW-3DNIP cumulative energization time can be check. Unit: sec
0x02	Function	○	○	Structure	Function information
				UDINT	Stores a function code.
				STRING	Stores a function comment. (Max.character No.: 58)
0x03	Location	○	○	Structure	Installation location information
				UDINT	Stores an installation location code.
				STRING	Stores an installation location comment. (Max.character No.: 58)
0x04	Installation Date	○	○	Structure	Installation date information
				UDINT	Stores installation date code.
				STRING	Stores installation date comment. (Max.character No.: 58)
0x05	Descriptor1	○	○	Structure	Descriptor1 information
				UDINT	Stores a descriptor 1 code.
				STRING	Stores a descriptor 1 comment. (Max.character No.: 58)
0x06	Descriptor2	○	○	Structure	Descriptor2 information
				UDINT	Stores a descriptor 2 code.
				STRING	Stores a descriptor 2 comment. (Max.character No.: 58)
0x07	Security	○	○	Structure	Security information
				UDINT	Stores a security code.
				STRING	Stores a security name comment. (Max. character No.:58)

Instance Service (Class ID: 0xC7, Instance ID: 0x01)

ID	Name	Description
0x0E	Get_Attribute_Single	Read out one attribute value from NCW-3DNIP.
0x10	Set_Attribute_Single	Write one attribute value to NCW-3DNIP.

APPENDIX 2-13. Device Level Ring (DLR) Object (Class ID: 0x47)

This object can confirm the state of the NCW-3DNIP's Device Level Ring.

Following tables indicate specifications of the Device Level Ring object.
The Device Level Ring object has one instance.

Class Attribute (Class ID: 0x47)

ID	Name	Access		Data Type	Description
		Get	Set		
0x01	Revision	○	—	UINT	3
0x02	Max Instance	○	—	UINT	1
0x03	Number of Instance	○	—	UINT	1

Class Service (Class ID: 0x47, Instance ID: 0x00)

ID	Name	Description
0x01	Get_Attribute_All	Read out all attribute values from NCW-3DNIP.
0x0E	Get_Attribute_Single	Read out one attribute value from NCW-3DNIP.

Instance Attribute (Class ID: 0x47, Instance ID: 0x01)

ID	Name	Access		Data Type	Description		
		Get	Set				
0x01	Network Topology	○	—	USINT	Indicates the current network topology mode.		
					Value	Description	
					0	Linear	
1	Ring						
0x02	Network Status	○	—	USINT	Indicates the current status of the network.		
					Value	Description	
					0	Normal operation in both Ring and Linear Network Topology modes.	
1	Ring Fault. A ring fault has been detected. Valid only when Network Topology is Ring.						
0x0A	Active Supervisor Address	○	—	Structure	Address information of the active ring supervisor		
				UDINT	Indicates the IP address of the active ring.		
				USINT[6]	Indicates the MAC address of the active ring.		
0x0C	Capability Flags	○	—	DWORD	Indicates DLR capabilities of NCW-3DNIP.		
					Bit	Name	Value
					0	Announce-based Ring Node	0
					1	Becaon-based Ring Node	1
					2-4	Reserved	0
					5	Supervisor Capable	0
					6	Redundant Gateway Capable	0
					7	Flush_Table frame Capable	1
8-31	Reserved	0					

Instance Service (Class ID: 0x47, Instance ID: 0x01)

ID	Name	Description
0x01	Get_Attribute_All	Read out all attribute values from NCW-3DNIP. Attribute ID 1 to 8 and 10 to12 can be read out. Attribute ID 3 to 8 and 11 aren't supported, thus initial values are read out.
0x0E	Get_Attribute_Single	Read out one attribute value from NCW-3DNIP.

APPENDIX 3. WEB SERVER FUNCTION

NCW-3DNIP can use the web server function.

The web server function can set and check the user management and information.

The web server function is supported after version 2.01.

Products with the software version mark put on the products panel after "B" support.

Refer to "8-1." for the version mark.

APPENDIX 3-1. Login Procedures

Login NCW-3DNIP for using the web server function.

●Login procedures

1. Enter NCW-3DNIP's IP address to the address bar of the internet browser.
2. A login window appears.
3. Enter "admin" to the user name and password fields, click "Login" button.
(*: The password can be changed at "user setting window".)

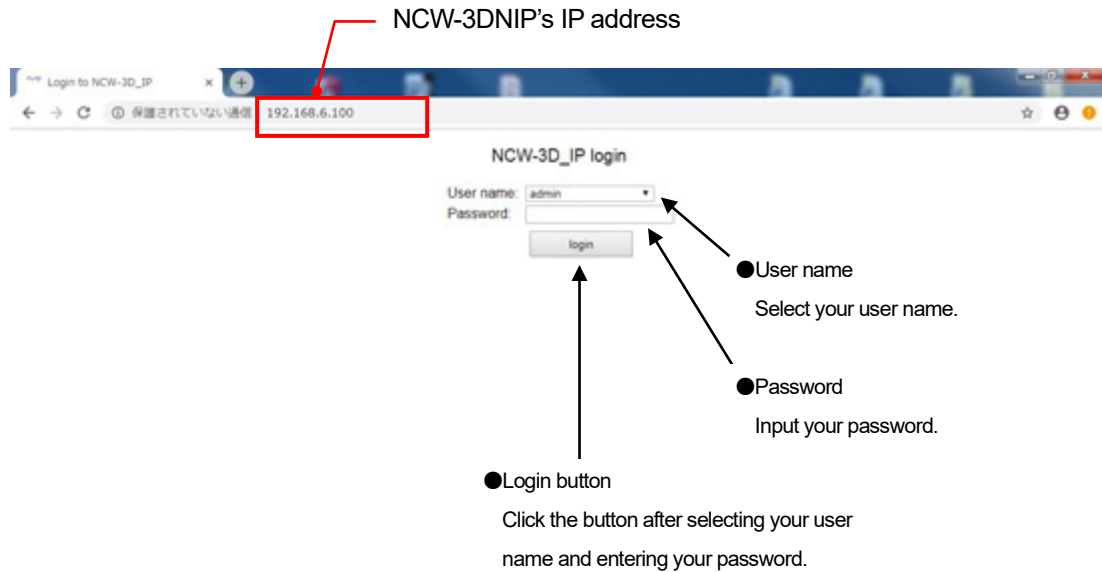

4. NCW-3D_IP's menu "Identity Object" appears after the login.
Select a menu if you need.

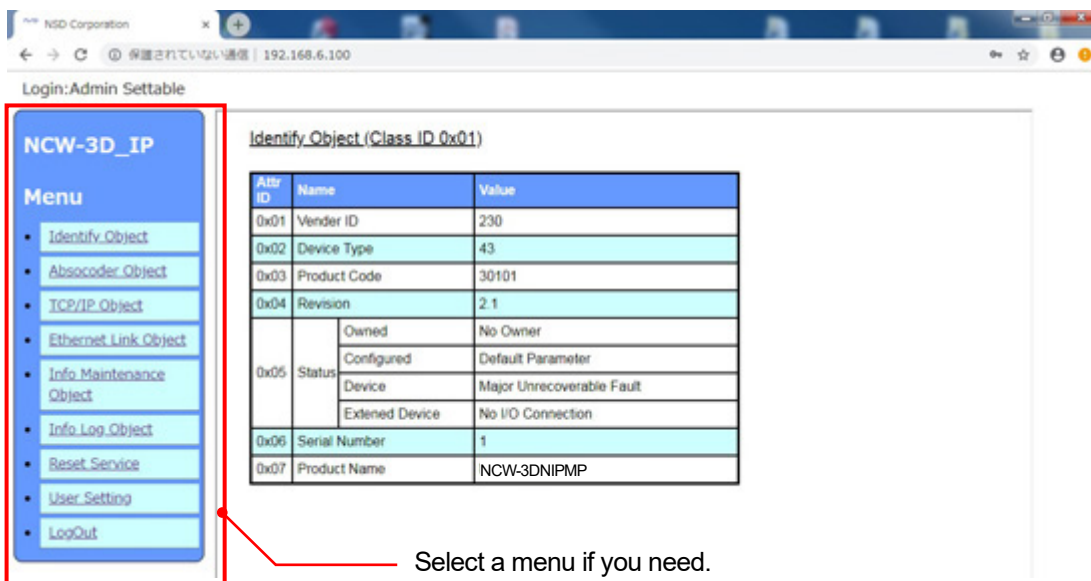

APPENDIX 3-2. User management function

User's setting operation can be restricted at the management function.

Click "User Setting" on the menu.

A User Setting window appears.

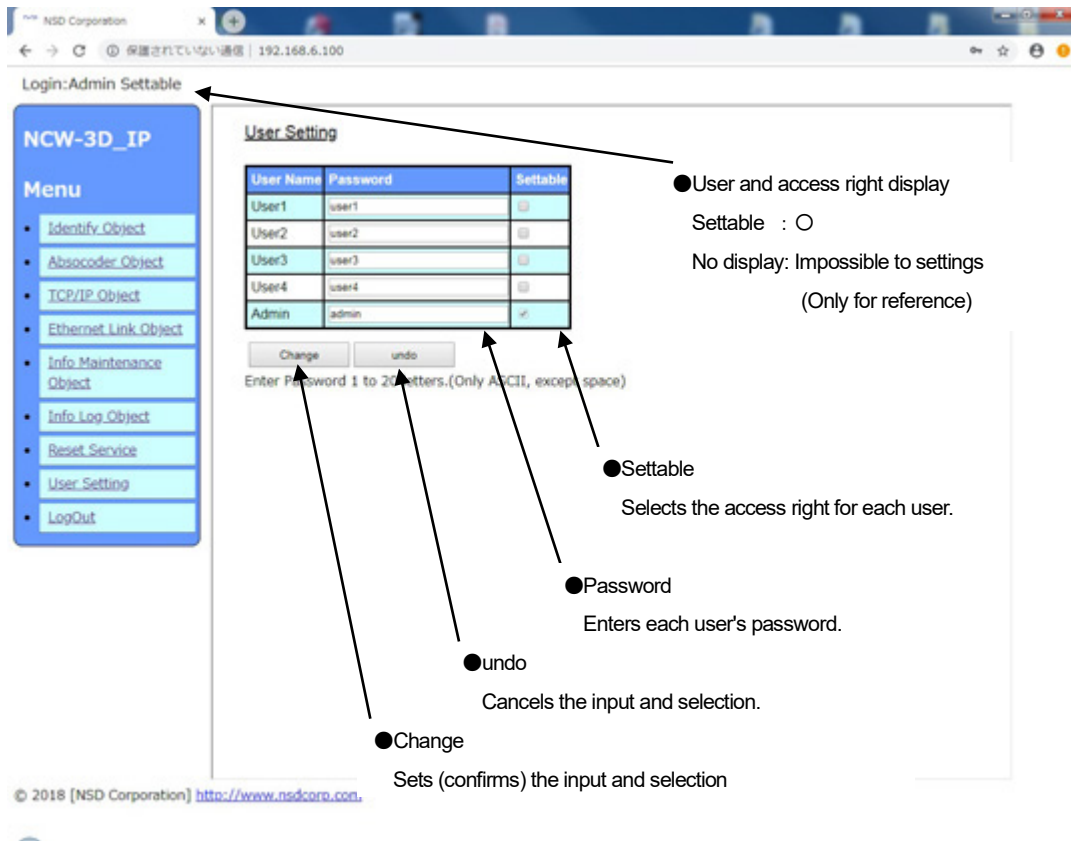

●Screen setting contents

Only administrator (admin) can set this screen setting.

The password for users (User 1 to 4) and administrator (admin) can be set.

The user name cannot be changed, but password can be set.

Users (users 1 to 4) can be selected "settable" or "unsettable" for the access right (settable).

●Operation method

The administrator sets the users' passwords (user 1 to 4).

Users can use after receiving "User name" and "Password" from the administrator.

The factory settings for manageable user names and access rights are described below;

(User names cannot be changed.)

No.	User name	Password (factory setting)	Access right (factory setting)	Access right	Note
1	User1	user1	Unsettable (for reference)	Select either settable or unsettable	General user1
2	User2	user2			General user 2
3	User3	user3			General user 3
4	User4	user4			General user 4
5	Admin	admin	Settable	Settable only	Administrator

APPENDIX 3-3. Setting / Reference display

(1) Menu "Identity Object (ClassID: 0x01)" - Reference of the identity information

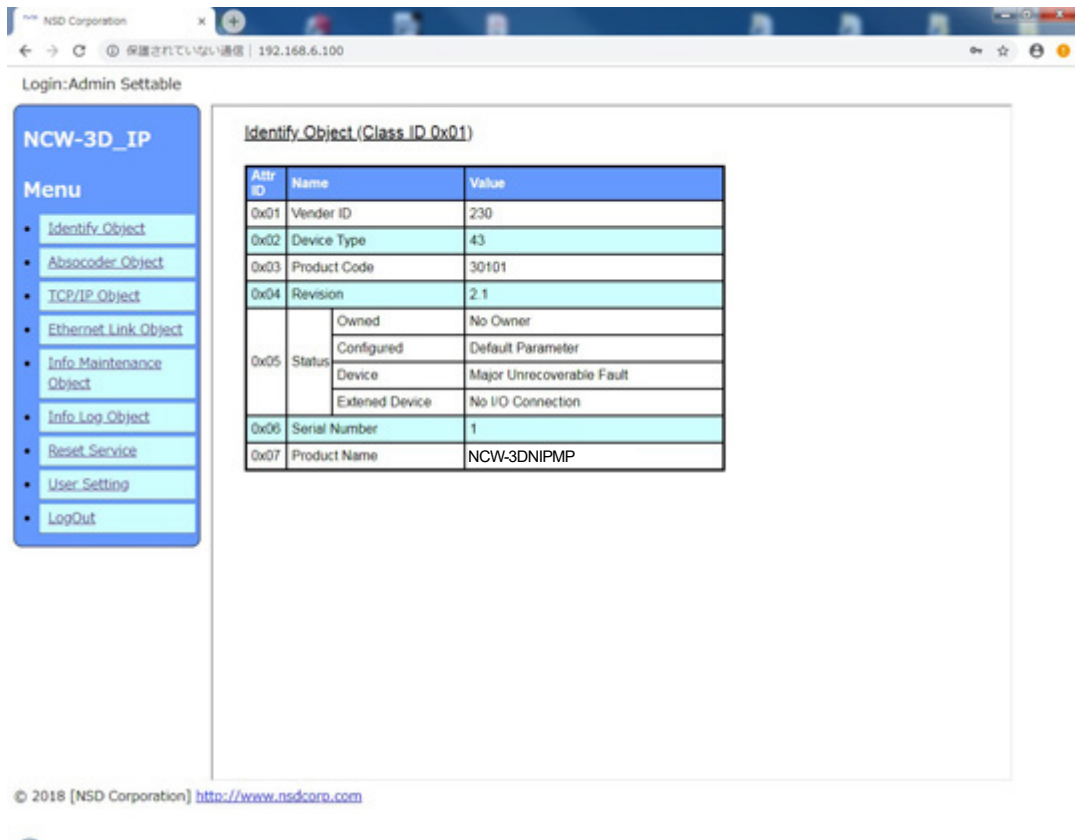

The screenshot shows a web browser window with the URL 192.168.6.100. The page title is "Login:Admin Settable". On the left, there is a blue sidebar menu for "NCW-3D_IP" with the following items: Identify Object, Absocoder Object, TCP/IP Object, Ethernet Link Object, Info Maintenance Object, Info Log Object, Reset Service, User Setting, and LogOut. The main content area displays the "Identify Object (Class ID 0x01)" section, which contains a table of identity information.

Attr ID	Name	Value	
0x01	Vender ID	230	
0x02	Device Type	43	
0x03	Product Code	30101	
0x04	Revision	2.1	
0x05	Status	Owned	No Owner
		Configured	Default Parameter
		Device	Major Unrecoverable Fault
		Extened Device	No I/O Connection
0x06	Serial Number	1	
0x07	Product Name	NCW-3DNIPMP	

© 2018 [NSD Corporation] <http://www.nsdcorp.com>

(2) Menu “Absocoder Object (ClassID: 0x64)” - References and settings of ABSOCODER's parameter and status

NCW-3D_IP

Menu

- Identify Object
- Absocoder Object
- TCP/IP Object
- Ethernet Link Object
- Info Maintenance Object
- Info Log Object
- Reset Service
- User Setting
- LogOut

Absocoder Object (Class ID 0x64)

Attr ID	Name	Value	
		Axis1(Inst ID 1)	Axis2(Inst ID 2)
0x03	Position Value Unsigned	820	0
0x0C	Position Data Increase Direction	<input checked="" type="radio"/> CW <input type="radio"/> CCW	<input checked="" type="radio"/> CW <input type="radio"/> CCW
0x13	Preset Value Range: 0 to 131071	<input type="text" value="0"/> Axis-1 Preset	<input type="text" value="0"/> Axis-2 Preset
0x64	Axis Unavailable	<input checked="" type="radio"/> Available <input type="radio"/> Unavailable	<input checked="" type="radio"/> Available <input type="radio"/> Unavailable
0x65	Error Clear	<input checked="" type="radio"/> Auto <input type="radio"/> Manual	<input checked="" type="radio"/> Auto <input type="radio"/> Manual

Parameter Change

Axis-1 Parameter Axis-2 Parameter Undo

Info Diagnosis Object (Class ID 0xC8)

Attr ID	Name	Value
0x01	Sensor Curcuit Status	Converter Error <input checked="" type="checkbox"/> NRDY <input type="checkbox"/> WDTE <input checked="" type="checkbox"/> ME <input type="checkbox"/> IF ERR
		Axis-1 Sensor Error <input type="checkbox"/> SE <input type="checkbox"/> SSE <input type="checkbox"/> SPF <input type="checkbox"/> DE
		Axis-2 Sensor Error <input checked="" type="checkbox"/> SE <input checked="" type="checkbox"/> SSE <input type="checkbox"/> SPF <input type="checkbox"/> DE

© 2018 [NSD Corporation] <http://www.nsdcorp.com>



Note

When setting parameters, switch the operation mode of the host PLC to program mode (PROG).
Cannot be set in run mode (RUN).

This operation is performed by using the PLC's configuration tool (a PLC development tool software).

*: Depending on the PLC model, this operation can also be performed by the mode selection switch on the CPU card.

(3) Menu “TCP/IP Object (ClassID: 0xF5)” - References and settings of Ethernet TCP/IP's parameter and status

© 2018 [NSD Corporation] <http://www.nsdcorp.com>

(4) Menu “Ethernet Link Object (ClassID: 0xF6)” - Reference of the Ethernet Link status

© 2018 [NSD Corporation] <http://www.nsdcorp.com>

(5) Menu “Info Log Object (ClassID: 0xC5)” - Reference and settings of the log information

NCW-3D_IP

Menu

- Identify Object
- AbsoCoder Object
- TCP/IP Object
- Ethernet Link Object
- Info Maintenance Object
- Info Log Object
- Reset Service
- User Setting
- Logout

Info Log Object (Class ID 0xC5)

No	Time[sec]	Event
0	11	LINK1 Settings - AUTO
1	11	LINK1 Settings - FullDuplex
2	11	LINK1 Settings - 100Mbps
3	11	LINK1 Port is a LinkUP
4	10	State in MAJOR UNRECOVERABLE FAULT
5	10	State in OPERATIONAL
6	10	ME
7	10	NRDY
8	10	2Axis SSE
9	10	2Axis SE
10	10	State in NETINIT
11	10	IP Address Assign Mode - SWITCH
12	10	State in NETBOOT
13	10	State in SELFTTEST
14	9	Power ON
15	0	
16	0	
17	0	
18	0	
19	0	
20	0	
21	0	
22	0	
23	0	
24	0	
25	0	
26	0	
27	0	
28	0	
29	0	
30	0	
31	0	

© 2018 [NSD Corporation] <http://www.nsdcorp.com>

(6) Menu “Info Maintenance Object (ClassID: 0xC7)” - Reference and settings of the maintenance information

NCW-3D_IP

Menu

- Identify Object
- AbsoCoder Object
- TCP/IP Object
- Ethernet Link Object
- Info Maintenance Object
- Info Log Object
- Reset Service
- User Setting
- Logout

Info Maintenance (Class ID 0xC7)

Attr ID	Name	Value
0x01	Power Distribution Time	328[sec]
0x02	Function	Code 0
		Comment
0x03	Location	Code 0
		Comment
0x04	Install Date	Code 0
		Comment
0x05	Descriptor1	Code 0
		Comment
0x06	Descriptor2	Code 0
		Comment
0x07	Security	Code 0
		Comment

Change undo

Range of Code: 0 to 4294967295
 Comment is Max 58 Characters.(Only ASCII)

© 2018 [NSD Corporation] <http://www.nsdcorp.com>

(7) Menu “Reset Service” - Reset operation of NCW-3DNIP

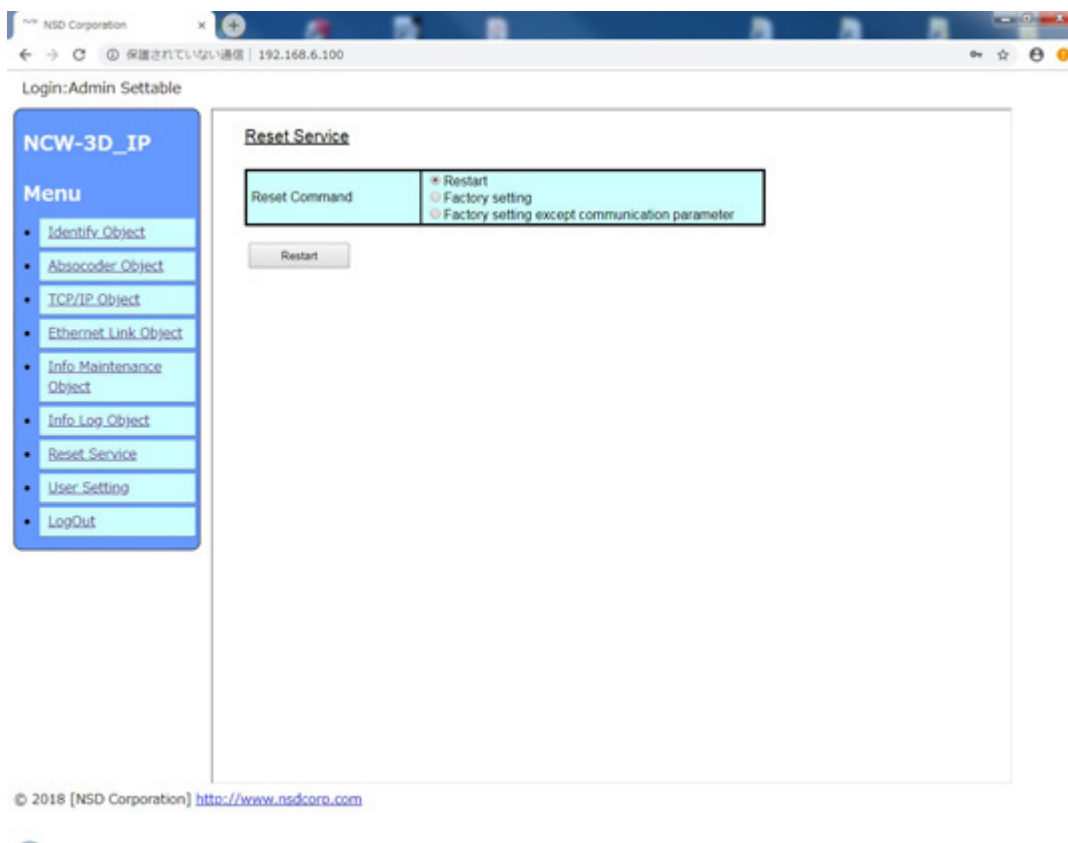

The reset operation can be selected from the following three types;

No.	Type of Reset	Description
1	Restart	Restart
2	Factory setting	All NCW-3DNIP parameters' setting is redesignated to initial values (factory setting), and restart.
3	Factory setting except communication parameter	All NCW-3DNIP parameters' setting is redesignated to initial values (factory setting) except communication LINK parameter, and restart.



NSD Group

Manufacturer

NSD Corporation 3-31-28, OSU, NAKA-KU, NAGOYA, JAPAN 460-8302

Distributor

NSD Trading Corporation 3-31-23, OSU, NAKA-KU, NAGOYA, JAPAN 460-8302

Phone: +81-52-261-2352 Facsimile: +81-52-252-0522

URL: www.nsdcorp.com E-mail: foreign@nsdcorp.com

Copyright©2023 NSD Corporation All rights reserved.