



ZEF005960701



For Iron and Steel Industry

**Abbycode**<sup>®</sup>

**ABSOCODER Converter**

**NCW-3DHPNL8**

**Specifications & Instruction Manual**

**Applicable sensor:**

VLS-8SM





# CONTENTS

<b>INTRODUCTION</b> .....	<b>i</b>
<b>COPYRIGHT</b> .....	<b>i</b>
<b>GENERAL SAFETY RULES</b> .....	<b>ii</b>
<b>REVISION HISTORY</b> .....	<b>iii</b>
<b>1. OVERVIEW</b> .....	<b>1</b>
1-1. Features .....	1
1-2. Limitations .....	2
<b>2. MODEL SELECTION WHEN ORDERING</b> .....	<b>3</b>
<b>3. SPECIFICATIONS</b> .....	<b>5</b>
3-1. Converter Specifications .....	5
3-2. ABSOCODER Sensor Specification .....	7
3-3. Extension Sensor Cable Specification .....	9
<b>4. DIMENSIONS</b> .....	<b>10</b>
4-1. Converter Dimension .....	10
4-2. ABSOCODER Sensor Dimensions .....	11
4-3. Extension Sensor Cable Dimensions .....	13
<b>5. CHECKING THE CONTENTS OF THE SHIPPING CASE</b> .....	<b>15</b>
<b>6. INSTALLATION</b> .....	<b>16</b>
6-1. Converter Installation Conditions and Precautions .....	16
6-2. ABSOCODER Sensor Installation Conditions and Precautions .....	17
<b>7. WIRING</b> .....	<b>18</b>
7-1. Connection between Converter and ABSOCODER Sensor .....	18
7-1-1. Connection configure example of the sensor cable .....	19
7-2. Power Supply Connection.....	21
<b>8. NOMENCLATURE</b> .....	<b>22</b>
8-1. Part Identification .....	22
8-2. Function and Name of Indicator and Setting Area .....	23
8-2-1. Contents of the communication status indicator area .....	24
8-2-2. Contents of the data indicator area .....	25
8-2-3. Ethernet port (LINK1/LINK2).....	27

<b>9. PROFINET COMMUNICATION SETUP .....</b>	<b>28</b>
9-1. Procedure Before the Operation .....	28
9-2. Preparation .....	29
9-3. Set the Network Configuration .....	30
9-3-1. Installation of the GSDML file.....	30
9-3-2. Creation of the network configuration .....	31
9-3-3. Set the topology .....	33
9-4. Set NameOfStation (Device Name).....	34
9-5. Set the IP Address .....	37
9-6. Set the Communication Cycle .....	38
9-7. Set Sensor Parameter of NCW-3DHPN .....	39
9-7-1. Sensor parameter list.....	39
9-7-2. Sensor parameters setting procedure.....	40
9-8. Create of the NCW-3DHPN Tag Table .....	41
9-8-1. I/O data format .....	43
9-9. Download the Device Description File .....	47
9-10. Confirm Position Data of NCW-3DHPN .....	49
<b>10. INSPECTION .....</b>	<b>50</b>
<b>11. TROUBLE SHOOTING.....</b>	<b>51</b>
11-1. Check Methods during an Error Is Occurred .....	51
11-2. Measures when a Communication Error Occurs .....	51
11-3. NCW-3DHPN Indicator.....	52
11-3-1. Status indicator (MS/NS).....	52
11-3-2. Link status indicator (L/A1·L/A2) .....	53
11-3-3. Converter status indicator .....	53
11-4. Device Reset .....	54
<b>12. STORE OF MAINTENANCE INFORMATION .....</b>	<b>55</b>
<b>13. ABSOCODER SENSOR CHECK LIST .....</b>	<b>57</b>
<b>14. CE MARKING .....</b>	<b>59</b>
14-1. EMC Directives .....	59
14-2. EMC Directive and Standards .....	59
14-3. Low Voltage Directive .....	59
14-4. Restrictions .....	60
<b>APPENDIX 1. RECORD DATA.....</b>	<b>61</b>
APPENDIX 1-1. Sensor Parameter .....	61
APPENDIX 1-2. Product Operation & Error History.....	62
APPENDIX 1-3. Interface Parameter .....	64
<b>APPENDIX 2. I&amp;M DATA (Identification &amp; Maintenance Data) .....</b>	<b>65</b>
<b>APPENDIX 3. ALARM DATA .....</b>	<b>66</b>

## **INTRODUCTION**

Thank you very much for purchasing our product.

Before operating this product, be sure to carefully read this manual so that you may fully understand the product, safety instructions and precautions.

- Please submit this manual to the operators actually involved in operation.
- Please keep this manual in a handy place.

## **COPYRIGHT**

- PROFINET logo is trademarks used under license by PROFIBUS Nutzerorganisation e.V..
- Company and product names that appear in this manual are registered trademarks or trademarks of their respective holders.

# GENERAL SAFETY RULES

## ● Application Limitation



This product is not designed to be used under any situation affecting human life. When you are considering using this product for special purposes such as medical equipment, aerospace equipment, nuclear power control systems, traffic systems, and etc., please consult with NSD.

This product is designed to be used under the industrial environments categorized in Class A device.

The supplier and user may be required to take appropriate measures.



## ● Signal Words

Safety precautions in this guide are classified into DANGER and CAUTION.

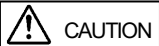

Symbol	Meaning
 DANGER	Incorrect handling may cause a hazardous situation that will result in death or serious injury.
 CAUTION	Incorrect handling may cause a hazardous situation that will result in moderate injury or physical damage.



Instructions accompanied by a symbol  CAUTION may also result in serious damage or injury. Be sure to follow the all instructions accompanied by the symbol.

## ● Graphic Symbols



Symbol	Meaning
	Indicates prohibited items.
	Indicates items that must be performed to.

### 1. Handling Precautions



 DANGER	
	<ul style="list-style-type: none"> <li>- Do not touch components inside of the converter; otherwise, it will cause electric shock.</li> <li>- Do not damage the cable by applying excessive load, placing heavy objects on it, or clamping; otherwise, it will cause electric shock or fire.</li> </ul>
	<ul style="list-style-type: none"> <li>- Turn the power supply OFF before wiring, transporting, and inspecting the converter; otherwise, it may cause electric shock.</li> <li>- Provide an external safety circuit so that the entire system functions safely even when the converter is faulty.</li> <li>- Connect the grounding terminal of the converter; otherwise, it may cause electric shock or malfunction.</li> </ul>

 CAUTION	
	- Do not use the converter in the following places; water splashes, the atmosphere of the corrosion, the atmosphere of the flammable vapor, and the side of the combustibility. Doing so may result in fire or the converter may become faulty.
	<ul style="list-style-type: none"> <li>- Be sure to use the converter and the ABSOCODER sensor in the environment designated by the general specifications in the manual. Failure to do so may result in electric shock, fire, malfunction or unit failure.</li> <li>- Be sure to use the specified combination of the ABSOCODER sensor, the converter and sensor cable; otherwise, it may cause fire or the converter malfunction.</li> </ul>

### 2. Storage

 CAUTION	
	- Do not store the converter in a place exposed to water, or toxic gas and liquid.
	<ul style="list-style-type: none"> <li>- Be sure to store the converter in designed temperature and humidity range, and do not exposed to direct sunlight.</li> <li>- Be sure to consult with NSD when the converter is stored for long periods.</li> </ul>



### 3. Transport



 CAUTION	
	- Do not hold the cable or shaft of ABSOCODER sensor during transport; otherwise, it will cause injury or malfunction.

### 4. Installation



 CAUTION	
	<ul style="list-style-type: none"> <li>- Do not step on ABSOCODER sensor or place heavy objects on the converter; otherwise, it will cause injury or malfunction.</li> <li>- Do not block the exhaust port or allow any foreign matter to enter the converter; otherwise, it will cause fire or the converter failure.</li> </ul>
	<ul style="list-style-type: none"> <li>- Be sure to secure the converter and ABSOCODER sensor with the provided brackets; otherwise, it may cause malfunction, injury, or drop.</li> <li>- Be sure to secure the specified distance between the converter and the control panel or other equipment; otherwise, it may cause malfunction.</li> </ul>

### 5. Wiring



 DANGER	
	<ul style="list-style-type: none"> <li>- Be sure to secure the terminal block firmly; otherwise, it will cause fire.</li> <li>- Be sure to mount the terminal cover provided with the converter, before supplying the power, starting operation after the installation, and wiring; otherwise, it may cause electric shock.</li> </ul>

 CAUTION	
	<ul style="list-style-type: none"> <li>- Be sure to keep the sensor cable, control cable, and communication cable at least 300 mm away from the main circuit and power line; otherwise it may cause injury or malfunction.</li> <li>- Be sure to connect all cables correctly; otherwise, it may cause injury or malfunction.</li> <li>- Be sure to firmly connect the external I/O connectors and sensor connectors; otherwise, it may cause incorrect inputs and outputs or injury.</li> </ul>



### 6. Operation

 CAUTION	
	<ul style="list-style-type: none"> <li>- Do not change the converter's function switch settings during the operation; otherwise, it will cause injury.</li> <li>- Do not approach the machine after instantaneous power failure has been recovered. Doing so may result in injury if the machine starts abruptly.</li> </ul>
	<ul style="list-style-type: none"> <li>- Be sure to check that the power supply specifications are correct; otherwise, it may cause the converter failure.</li> <li>- Be sure to provide an external emergency stop circuit so that operation can be stopped with power supply terminated immediately.</li> <li>- Be sure to conduct independent trial runs for the converter before mounting ABSOCODER sensor to the machine; otherwise, it may cause injury.</li> <li>- When an error occurs, be sure to eliminate the cause, ensure safety, and reset the error before restarting operation; otherwise, it may cause injury.</li> </ul>

### 7. Maintenance and Inspection

 CAUTION	
	- Do not disassemble, remodel, or repair the unit; otherwise, it will cause electric shock, fire, and unit malfunction.
	- The capacitor of the power line deteriorates through prolonged use. We recommended that the capacitor be replaced every five years to prevent secondary damage.

### 8. Disposal

 CAUTION	
	- Be sure to handle the converter and ABSOCODER sensor as industrial waste while disposing of it.

## REVISION HISTORY

The Document No. appears at the upper right of this manual's cover page.

Document No.	Date	Revision Description
ZEF005960700	29, Mar., 2018	1st Edition Japanese document: ZEF005960600
ZEF005960701	12, Nov., 2019	2nd Edition Japanese document: ZEF005960601

# 1. OVERVIEW

NCW-3DHPNL8 (hereinafter referred to as NCW-3DHPN) is an ABSOCODER converter, a slave unit for PROFINET, can communicate with PROFINET. With the use of NCW-3DHPN in combination with the linear type of ABSOCODER sensor (VLS-8SM), the machine position can be detected. The detected position data can be transmitted to the programmable logic controller (PLC) and industrial computer through the PROFINET communication.

Or, the PLC and industrial computer can readout the converter status information and set parameters.

This manual assumes that NCW-3DHPN and a programmable controller which is manufactured by Siemens AG, Inc. are connected by the network. Therefore, we explain the manual by using a configuration tool "STEP7 V14 Professional SP1" developed by Siemens AG, Inc.. For the details of the tool, refer to manual of the "STEP7 V14 Professional SP1".

If the configuration tool is needed the definition file (GSDML file), download it from NSD website.

## 1-1. Features

### (1) Superior durability

ABSOCODER sensor is not used electronic parts except coils and resistance, and it features a no-contact construction excepting bearing. This sensor offers problem-free operation, even in environment where it is exposed to vibration, impact shocks, extreme temperatures, oil, and dust.

### (2) Compact design

The unit's outside dimensions (39(W) x 155(H) x 93(D)) were miniaturized. DIN rail can be used, so mounting is much easier.

### (3) PROFINET communication

A position, preset, alarm, and parameter data can be transmitted through the PROFINET network.  
- The communication speed and format is decided by Auto-Negotiation function.

### (4) Two ABSOCODER sensors can connect

The machine positions for two axes can be detected by one converter. The space-saving in the control panel can be conducted.

### (5) Diagnosis function

The error information can be expressed both by PROFINET alarm data and by monitor LEDs on the converter's front panel.

### (6) Preset function

The position data can be preset to the desired value from the PROFINET controller.

### (7) Configuration tool (software for configuring the system)

Settings are available by using PROFINET software.

### (8) Compliance with CE standards

The converter complies with CE (EMC Directive) standards.



## 1-2. Limitations

 <b>NOTES</b>	<u>Cautions concerning power-off and error occurrence</u>
<p>If the sensor moves while the converter power is OFF or an error is present, it mightn't detect accurate machine positions thereafter.</p> <p>Be sure to correct the position data using the "current position setting" after turning ON the power supply or clearing the error.</p> <p>Moreover after clearing the following error, the correct position data cannot be detected. Be sure to correct the position data using the "current position setting".</p> <ul style="list-style-type: none"><li>- "Sensor data error (DE)"</li><li>- "Internal power supply error for sensors (SPF)"</li><li>- "Disconnected sensor error (SSE)"</li><li>- "Sensor error (SE)"</li></ul>	

## 2. MODEL SELECTION WHEN ORDERING

The following figure indicates the connection configuration of NCW-3DHPN.

Before ordering, refer to the connection configuration and model list. Please prepare by customer except (1) to (4) in the connection configuration.

● Connection configuration

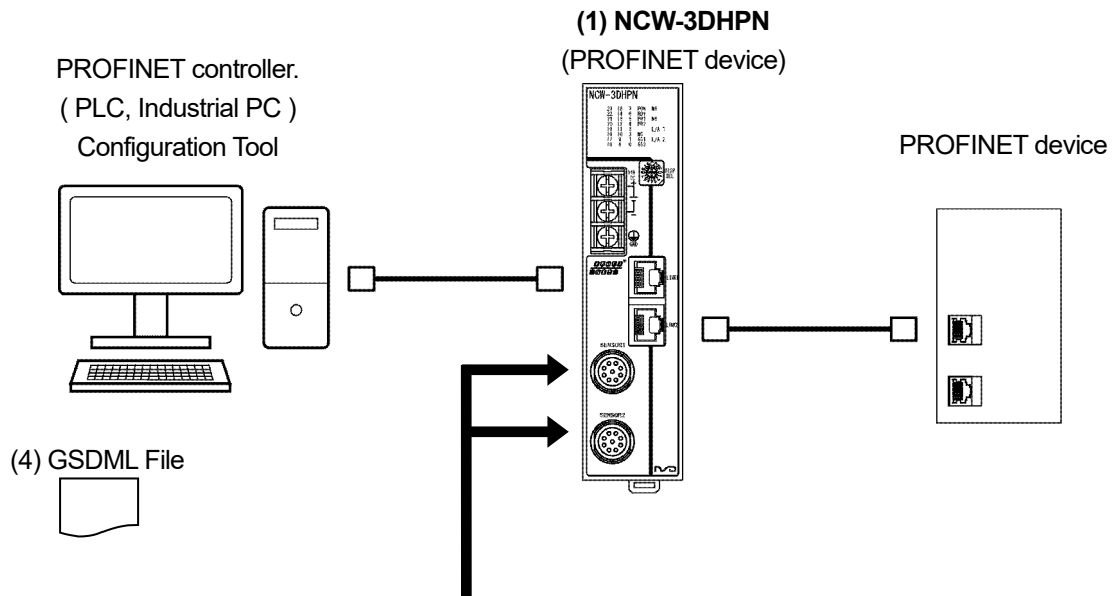

(3) Extension sensor cable		(2) ABSOCODER sensor	
 3S-S/RBT/URT-0144-[L]		Connector type  B	VLS-8SM20 
 3S-S/RBT/URT-0144-[L] 3S-S/RBT/URT-4344-[L] 3S-HRT-5152-[L]			 VLS-8SM14
 3S-S/RBT/URT-0190-[L] 3S-S/RBT/URT-9044-[L] 3S-HRT-9052-[L]		R  R Z  Z	 VLS-8SM14S
 3S-S/RBT/URT-0190-[L] 3S-S/RBT/URT/HRT-9090-[L]			

● Model List

◆ Converter

No.	Model	Description
①	NCW-3DHPNL8	For linear type ABSOCODER sensor Position data 24-bit binary code output

◆ ABSOCODER sensor

No.	Items	Models	Descriptions
(2)	Linear type ABSOCODER sensor	VLS-8SM20-[1]FA[2][L]	Flange-mount type  [1]: Stroke VLS-8SM20: 50, 100, 150, 200, 250, 300, 350 VLS-8SM14(S): 50, 100, 150, 200
		VLS-8SM20-[1]LA[2][L]	Base-mount type  [2]: Connector type B: Standard connector (NJW-2012PM8, manufacturer: Nanaboshi Electric Mfg.Co,Ltd.) Contact your NSD representative for VLS-8SM14 and VLS-8SM14S.
		VLS-8SM14-[1]FB[2][L]	Flange-mount type  R: Crimping terminals (R1.25-4) Z: No connector
		VLS-8SM14S-[1]FB[2][L]	Flange-mount type  [L]: Interconnecting sensor cable length (m): 2, 5, 10, 20

◆ Extension sensor cable

No.	Model	Description
(3)	3S-S-0144-[L]	Standard cable
	3S-RBT-0144-[L]	Robotic cable
	3S-URT-0144-[L]	Semi-heat-resistant robotic cable
	3S-S-4344-[L]	Standard cable
	3S-RBT-4344-[L]	Robotic cable
	3S-URT-4344-[L]	Semi-heat-resistant robotic cable
	3S-HRT-5152-[L]	Heat-resistant robotic cable
	3S-S-0190-[L]	Standard cable
	3S-RBT-0190-[L]	Robotic cable
	3S-URT-0190-[L]	Semi-heat-resistant robotic cable
	3S-S-9044-[L]	Standard cable
	3S-RBT-9044-[L]	Robotic cable
	3S-URT-9044-[L]	Semi-heat-resistant robotic cable
	3S-HRT-9052-[L]	Heat-resistant robotic cable
	3S-S-9090-[L]	Standard cable
	3S-RBT-9090-[L]	Robotic cable
	3S-URT-9090-[L]	Semi-heat-resistant robotic cable
	3S-HRT-9090-[L]	Heat-resistant robotic cable

[L]: Specify the cable length (m) that you need.

◆ GSDML

No.	Model	Description
(4)	File name: GSDML-V***-NSD_Corporation-NCW3D_PN-*****.xml	Download it from NSD website.

### 3. SPECIFICATIONS

#### 3-1. Converter Specifications

##### (1) General specification

Items	Specifications
Power supply voltage	24VDC±10% (including ripple)
Power consumption	10W or less
Insulation resistance	20 M-Ohms or more between external DC power terminals and ground (by 500 VDC insulation resistance tester)
Withstand voltage	500 VAC, 60Hz for 1 minute between external DC power terminals and ground
Vibration resistance	20m/s <sup>2</sup> 10 to 500Hz, 10cycles of 5 minutes in 3 directions, conforms to JIS C 0040 standard
Ambient operating temperature	0 to +55°C (No freezing)
Ambient operating humidity	20 to 90 %RH (No condensation)
Ambient operating environment	Free from corrosive gases and excessive dust
Ambient storage temperature	-25 to +70°C
Grounding	Must be securely grounded (ground resistance of 100 ohm or less)
Construction	Book-shelf type within enclosure, DIN rail mountable
Outside dimension (mm)	39(W) x 155(H) x 93(D) Refer to dimensions for details.
Mass	Approx. 0.4kg

##### (2) Performance specification

Items	Specifications	Notes
Converter model	NCW-3DHPNL8	
Applicable sensor	VLS-8SM20      VLS-8SM14      VLS-8SM14S	
Resolution	1µm(8.192mm/8192 divisions)	
Total number of divisions	8192×2048	
Position detection format	Semi-absolute format	
Output code	Binary code	
Number of detection axes	2	
Position data update interval	Minimum 2ms Update time : By PROFINET communication cycle setting	
Error detection	Sensor error, Memory error, Watchdog timer error, Internal I/F error	
Auxiliary functions	Preset function	
Monitor LED	MS: Module status	PROFINET Communication monitor
	NS: Network status	
	L/A1/L/A2: Communication status	
	PON: Power ON	
	RDY: Converter normal	
	PR1/PR2: Preset operation (Current position setting)	
	ME: Memory error	
	SE1/SE2: Sensor error	
	Position data: D0 to D23	LED display changes by selecting the DISP. SEL switch.
	Preset data: D0 to D23	
	Previous preset data: D0 to D23	
	Converter's diagnosis data	
	Parameter	
Communication diagnostic data		
Front panel operation	LED display selecting: DISP SEL	Rotary switch
Applicable standard	CE Marking (EMC directive)	

**(3) Communication specification**

	Items	Specifications
Communication	Physical layer	Ethernet 10Base-T, 100Base-TX, ISO/IEC 8802-3
	Number of communication ports	2 (connector: RJ45)
	Communication speed	Auto-Negotiation(100Mbit/s)
	Communication format	Auto-Negotiation(Full Duplex)
	Communication cycle time(Update time)	Minimum 2 ms
	RT Class	RT Class 1
	Conformance class	Class B
	PROFINET version	PN2.3
	Basic protocol	<ul style="list-style-type: none"> <li>• Internet Protocol (IP version 4) (RFC 791)</li> <li>• User Datagram Protocol (UDP) (RFC 768)</li> <li>• Transfer Control Protocol (TCP) (RFC 793)</li> <li>• Address Resolution Protocol (ARP) (RFC 826)</li> <li>• Internet Control Message Protocol (ICMP) (RFC 792)</li> <li>• Simple Network Management Protocol (SNMP)(RFC1157)</li> <li>• Link Layer Discovery Protocol (LLDP)(IEEE802.1AB)</li> <li>• Media Redundancy Protocol (MRP)(IEC 62439-2)</li> </ul>
	Recommended cable	CAT-5e STP straight cable
Cable length	Between nodes: Max. 100m	
Function	IP address setting	Sets manually by using the configuration tool.
	Communication setting (Speed and format)	Sets automatically by the Auto-Negotiation.
	I&M (Identification & Maintenance)	I&M0, 1, 2, 3
	Network redundancy	MRP (Only MRC is supported.)
	Parameter settings	Axis Unavailable Code Sequence (Position Data Increase Direction) Preset Value
	Control (OUTPUT)	Preset (PRESET) Error Clear (ERRCLR)
	Diagnosis status reference (INPUT)	Device Not Ready (NRDY) Device watchdog timer error (WDTE) Device memory error (ME) Internal I/F error (I/F ERR) Axis-n Sensor Error (SE) Axis-n Disconnected Sensor Error (SSE) Axis-n Sensor Circuit Power Error (SPF) Axis-n Sensor Data Error (DE) Axis-n Position Data
	Operation and abnormality occurrence history	Newest 32 error contents or operation histories
	Maintenance information	Cumulative energization time Writing in and reference of maintenance information
	Communication indicator	"MS" (Green / Red) : Module status "NS" (Green / Red) : Network status "L/A1" (Green) : Link status "L/A2" (Green) : Link status

### 3-2. ABSOCODER Sensor Specification

#### (1) VLS-8SM20

Items		Specifications
Model		VLS-8SM20
Max. detection stroke		350 mm
Absolute detection range		8.192 mm
Resolution		1 $\mu$ m(8.192mm/8192)
Linearity error		Customer's Special Specifications
Mass	Head	4.5+0.15 x [cable length(m)] kg
	Rod	0.4+0.0025 x [stroke (mm)] kg
Sliding resistance		69 N or less (7kgf or less)
Permissible mechanical speed		1000 mm/s
Ambient temperature	Operating	-10 to +80°C
	Storage	-10 to +80°C
Ambient operating humidity		—
Vibration resistance		2.0 x 10 <sup>2</sup> m/s <sup>2</sup> (20G) 200Hz up/down 4h, forward/back/left/right 2h each, conforms to JIS D 1601 standard
Shock resistance		4.9 x 10 <sup>3</sup> m/s <sup>2</sup> (500G) 0.5ms, up/down x 3 times, conforms to JIS C 5026 standard
Protection rating		IP67, conforms to JEM1030 standard
Interconnecting cable		2 · 5 · 10 · 20m
Max. sensor cable length	Standard cable	3S-S 200m
	Robotic cable	3S-RBT 100m
Surface	Head	Electroless nickel plated
	Rod	Hard chromium electro plated
Material	Head	Steel
	Rod	Steel

**(2) VLS-8SM14, VLS-8SM14S**

Items		Specifications	
Model		VLS-8SM14	VLS-8SM14S
Max. detection stroke		200 mm	
Absolute detection range		8.192 mm	
Resolution		1 $\mu$ m(8.192mm/8192)	
Linearity error		Customer's Special Specifications	
Mass	Head	1.1+0.07 x [cable length(m)] kg	0.8+0.07 x [cable length(m)] kg
	Rod	0.0012 x ([rod length (mm)]) kg	
Sliding resistance		15 N or less (1.5kgf or less)	
Permissible mechanical speed		1000 mm/s	
Ambient temperature	Operating	-10 to +80°C	
	Storage	-10 to +80°C	
Ambient operating humidity		—	
Vibration resistance		2.0 x 10 <sup>2</sup> m/s <sup>2</sup> (20G) 200Hz up/down 4h, forward/back 2h, conforms to JIS D 1601 standard	
Shock resistance		4.9 x 10 <sup>3</sup> m/s <sup>2</sup> (500G) 0.5ms, up/down x 3 times, conforms to JIS C 5026 standard	
Protection rating		IP67, conforms to JEM1030 standard	
Interconnecting cable		2 · 5 · 10 · 20m	
Max. sensor cable length	Standard cable	3S-S 200m	
	Robotic cable	3S-RBT 100m	
Surface	Head	Electroless nickel plated	
	Rod	Hard chromium electro plated	
Material	Head	Steel	
	Rod	Steel	

### 3-3. Extension Sensor Cable Specification

Items	Specifications			
Model code	3S-S	3S-RBT	3S-URT	3S-HRT
Cable type	Standard cable	Robotic cable	Semi-heat-resistant robotic cable	Heat-resistant robotic cable
Diameter	$\phi 8$			$\phi 9.5$
Operating temperature range	-5~+60°C		-5~+105°C	0~+150°C
Insulator	Irradiated cross linked formed polyethylene	ETFE plastic (resin)		
Sheath	Polyvinyl chloride mixture		Heat-resistant polyvinyl chloride mixture	Fluonlex
Construction	7-core, 1 triple with shield + 2 pairs with shield			
Color of sheath	Dark brown	Blue		Black
Advantage	Extensible for long distances	Superior flexibility; ideal for moving place		Heat treatment and flexible; ideal for moving place

**[Remark]**

Contact your NSD representative when the extension cable combines different types of cables.



## 4. DIMENSIONS

### 4-1. Converter Dimension

Units: mm

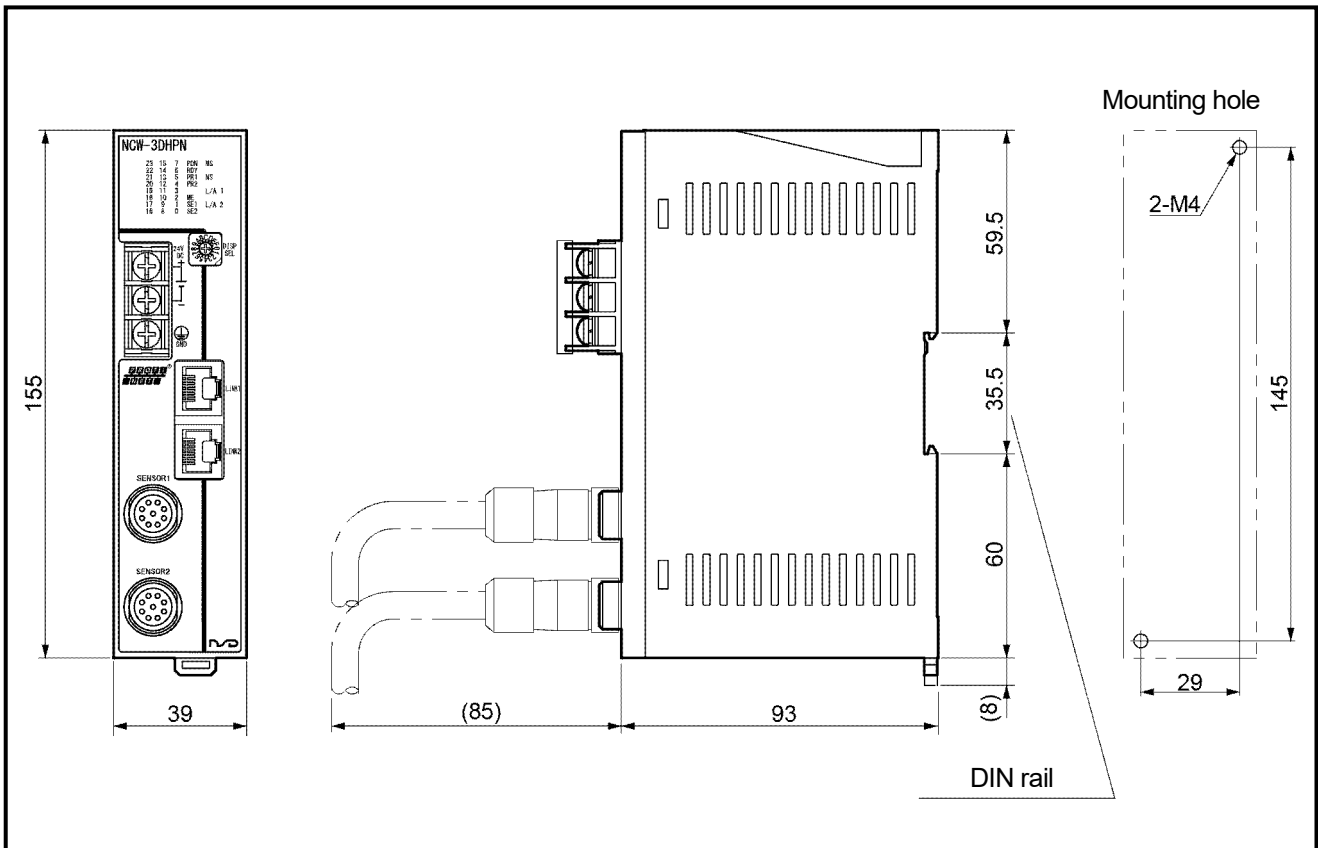

## 4-2. ABSOCODER Sensor Dimensions

### (1) VLS-8SM20-[ ]FA[ ] (Flange-mount type)

Units: mm

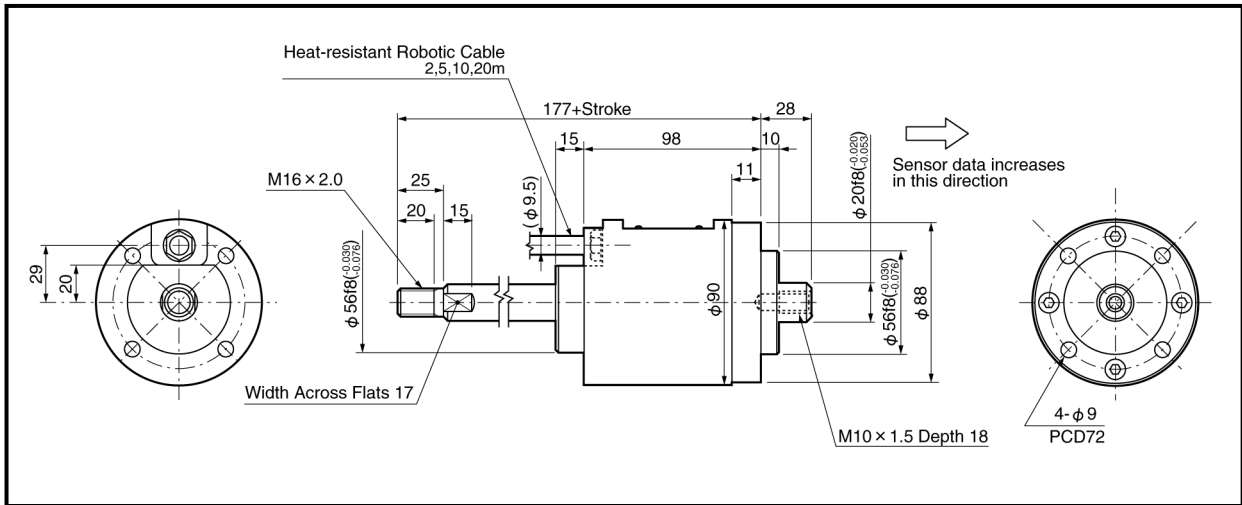

### (2) VLS-8SM20-[ ]LA[ ] (Base-mount type)

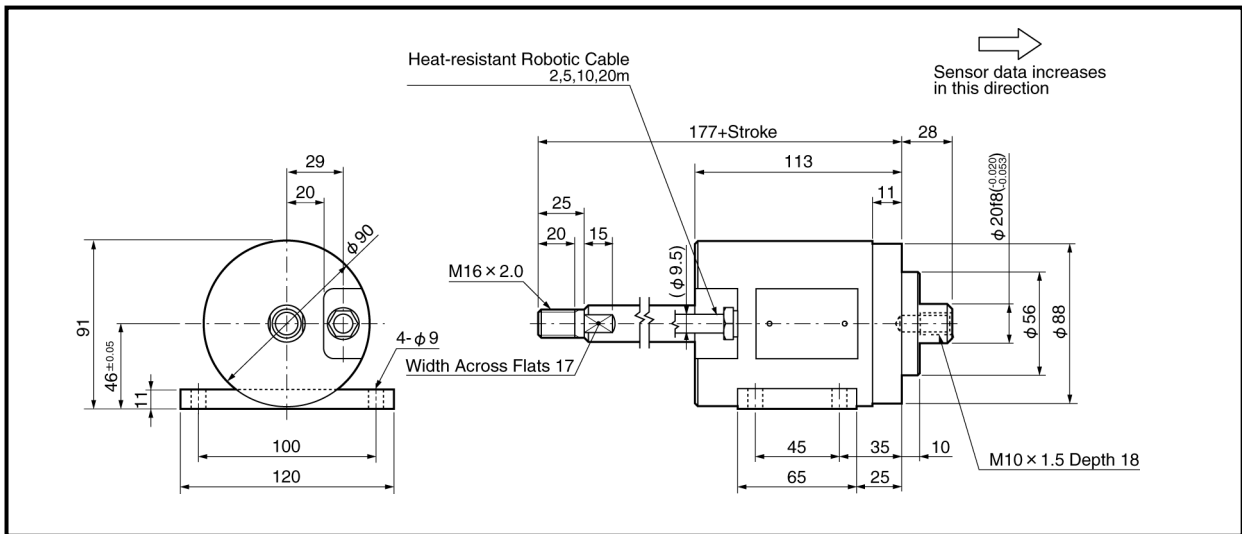

**(3) VLS-8SM14-[ ]FB[ ] (Flange-mount type)**

Units: mm

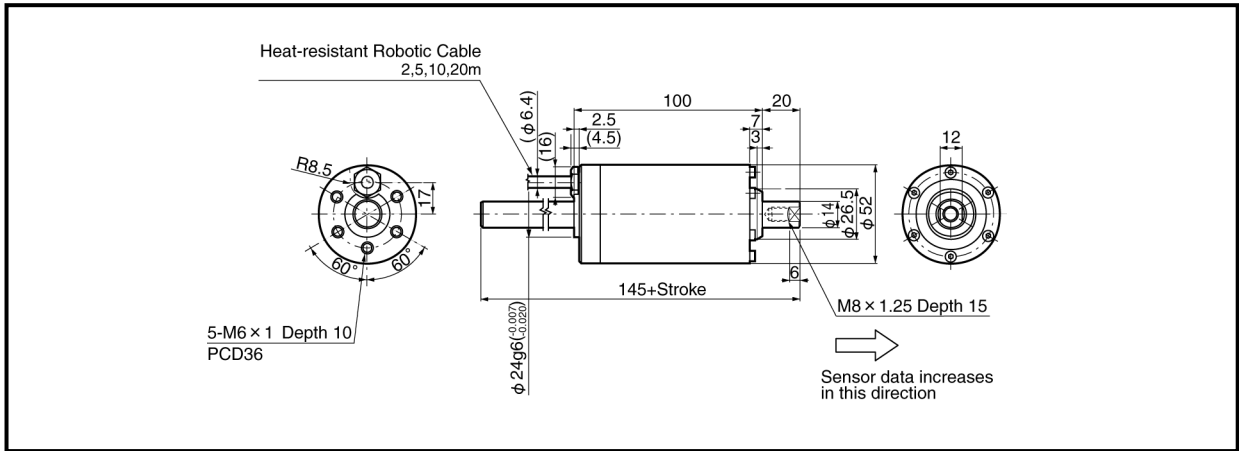

**(4) VLS-8SM14S-[ ]FB[ ] (Flange-mount type)**

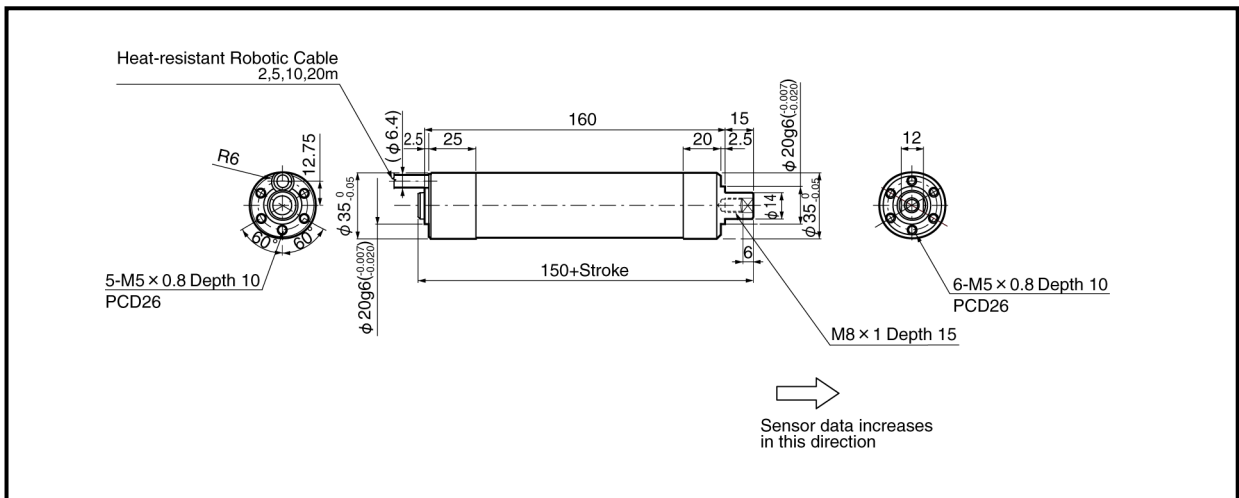

### 4-3. Extension Sensor Cable Dimensions

(1) 3S-S-0144-[L] / 3S-RBT-0144-[L] / 3S-URT-0144-[L]

Units: mm

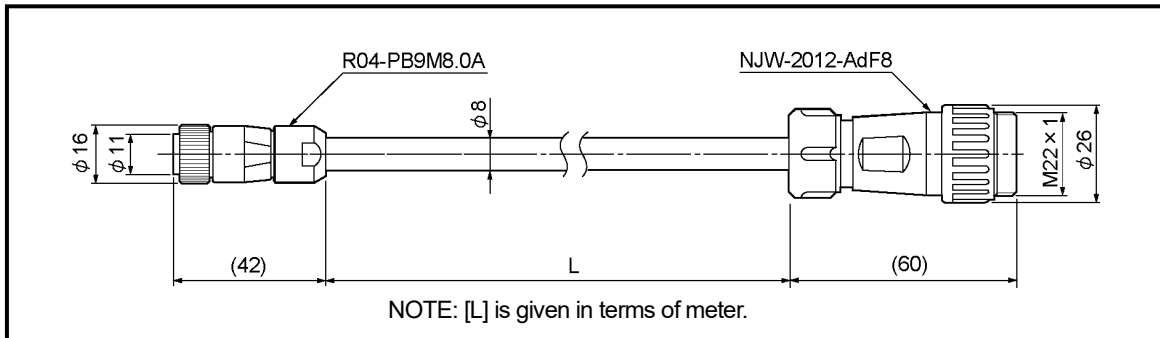

(2) 3S-S-4344-[L] / 3S-RBT-4344-[L] / 3S-URT-4344-[L]

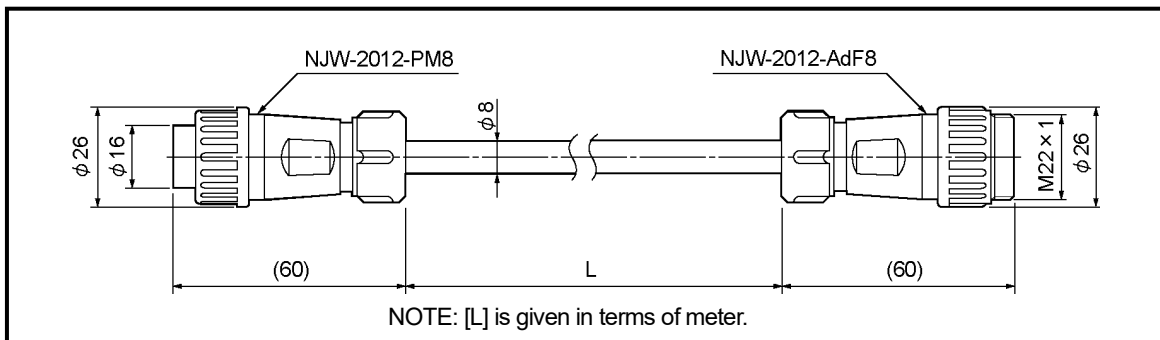

(3) 3S-HRT-5152-[L]

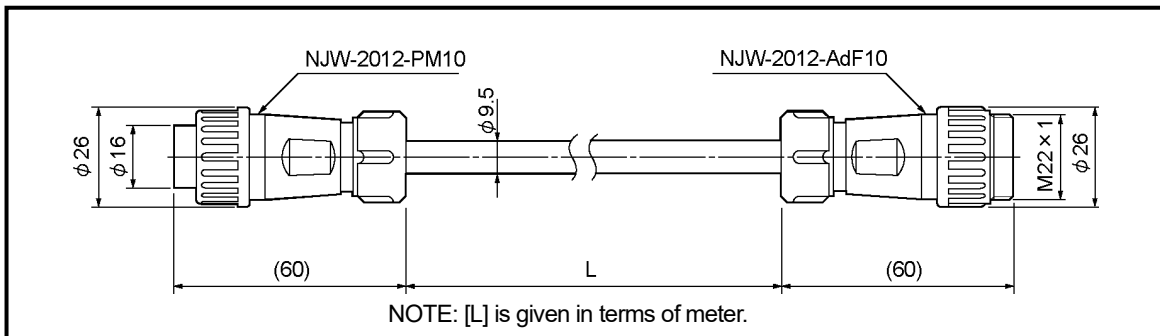

(4) 3S-S-0190-[L] / 3S-RBT-0190-[L] / 3S-URT-0190-[L]

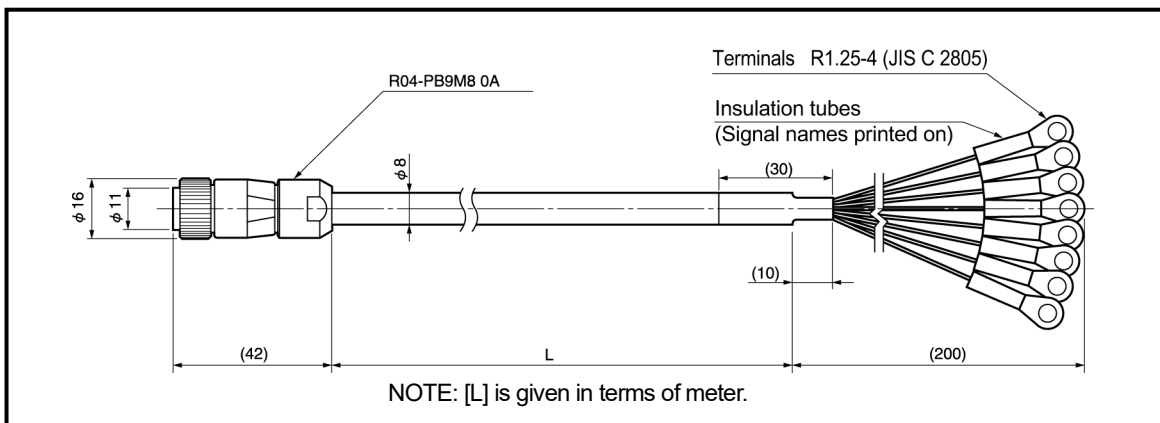

(5) 3S-S-9044-[L] / 3S-RBT-9044-[L] / 3S-URT-9044-[L]

Units: mm

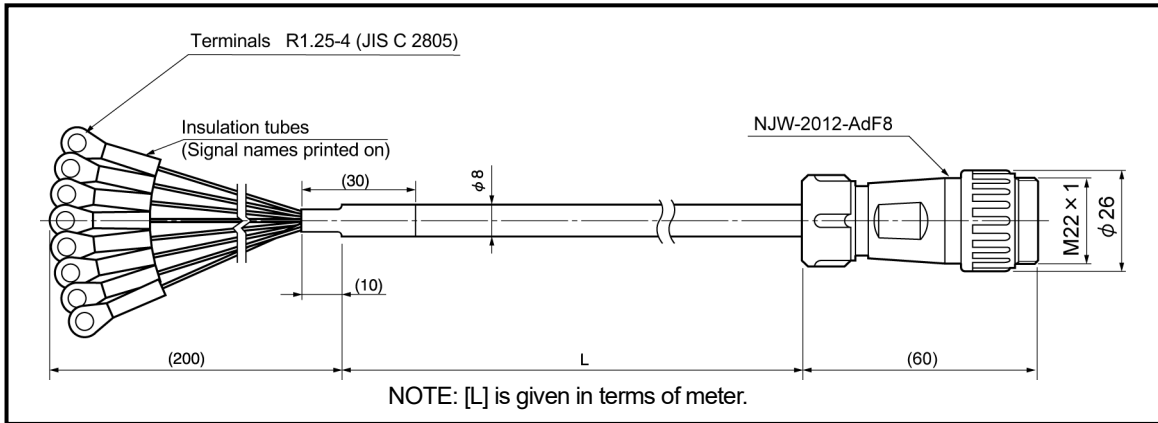

(6) 3S-HRT-9052-[L]

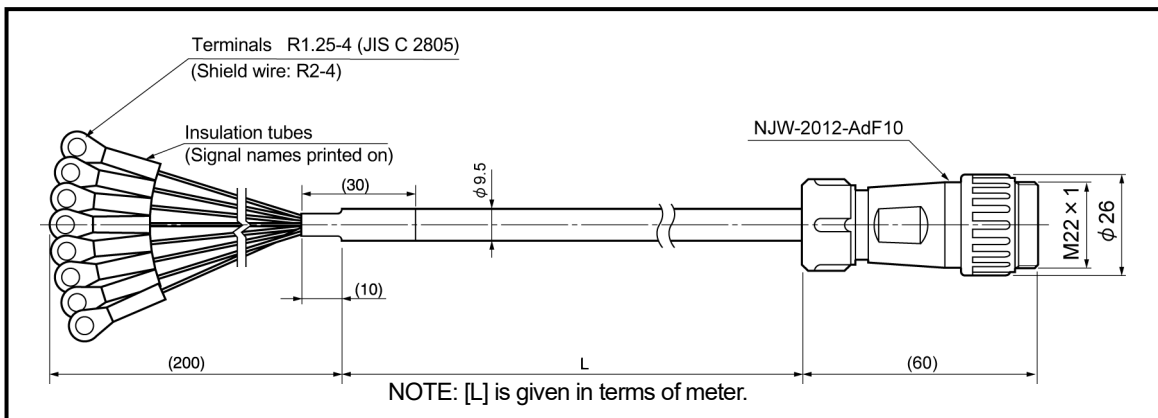

(7) 3S-S-9090-[L] / 3S-RBT-9090-[L] / 3S-URT-9090-[L]

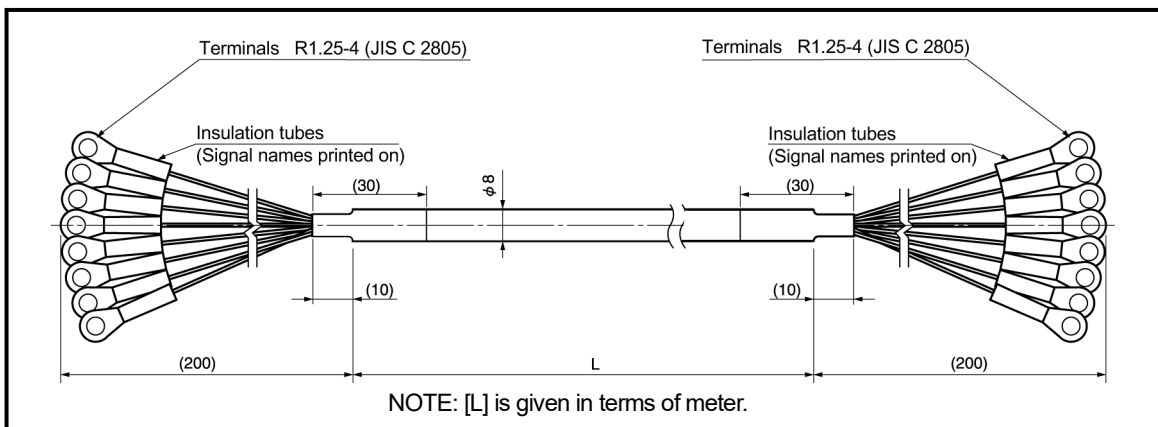

(8) 3S-HRT-9090-[L]

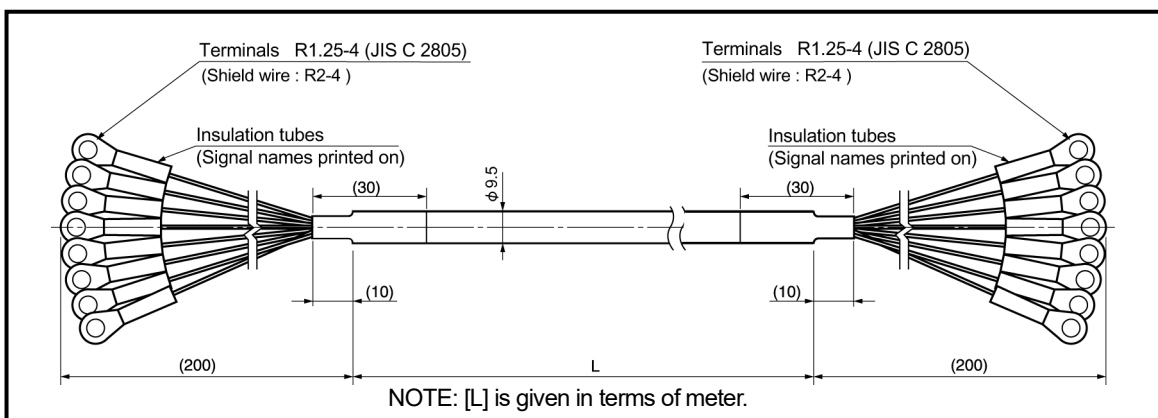

## 5. CHECKING THE CONTENTS OF THE SHIPPING CASE

Open the packing case, and verify that all items are present.

When extension sensor cables are ordered, they are packed separately.

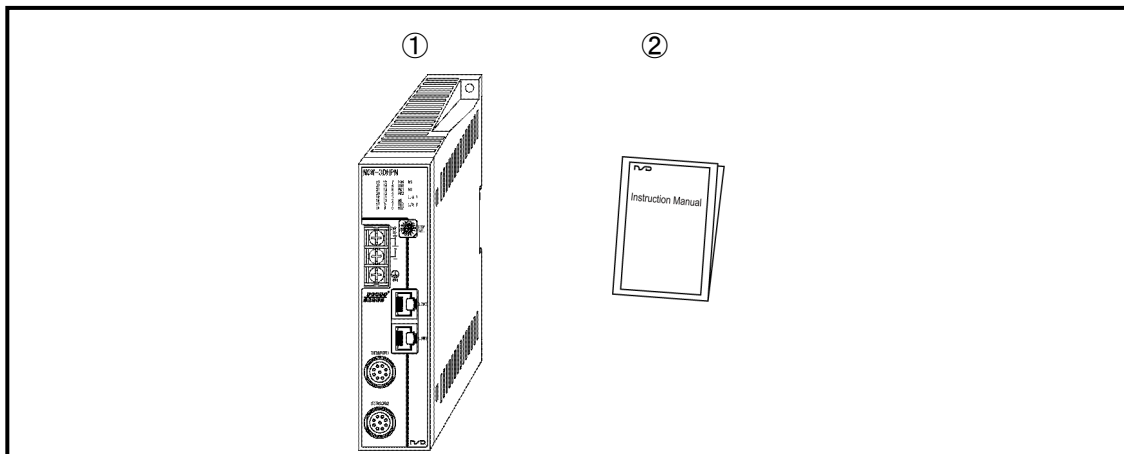

① Converter..... 1 unit

② Manual (Simple edition) ..... 1 piece

## 6. INSTALLATION

### 6-1. Converter Installation Conditions and Precautions

When installing the converter, the following conditions and precautions should be observed.

#### -Installation Site

- (1) Avoid sites where the unit is exposed to direct sunlight.
- (2) The ambient temperature should never exceed a 0 to 55°C range.
- (3) The ambient humidity should never exceed a 20 to 90% RH range.
- (4) Do not install the unit in areas where condensation is likely to occur (high humidity with extreme temperature changes).
- (5) Avoid sites where dust is excessive.
- (6) Do not install in areas with an excessive amount of salt and/or metal chips.
- (7) Do not install in areas where flammable and / or corrosive gases are present.
- (8) Avoid areas where splashing water, oil or chemicals are likely to occur.
- (9) Avoid areas where vibration and shocks are excessive.

#### -Installation cautions

- (1) Install inside the control cabinet.
- (2) Install in a vertical direction so that the characters are visible.
- (3) If a DIN rail mounting format is used, insert until the latch mechanism catches with an audible click.  
Secure between end plates at both sides.
- (4) In high vibration areas, secure tightly with 2 M4 screws.
- (5) Install as far from high voltage lines and power lines as possible in order to minimize noise influences.
- (6) Allow 85mm or more space at the converter's front side for plugging in and unplugging the connector.
- (7) Peripheral components should be arranged so as not to obstruct converter installation, removal, and connector plugging/unplugging.
- (8) Space out 10mm or more between the converter and peripheral components in order not to obstruct the converter's heat dissipation.

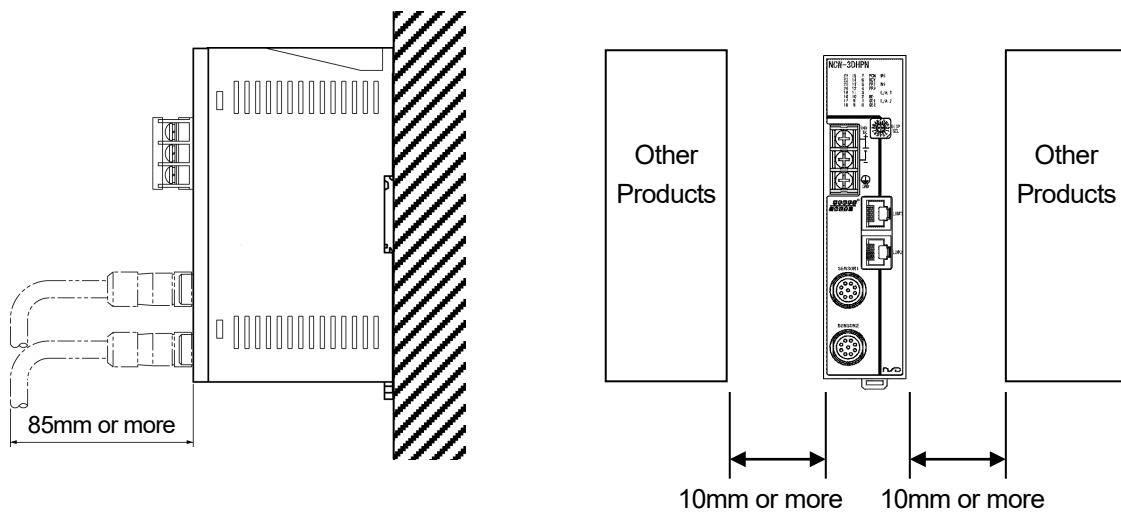

## 6-2. ABSOCODER Sensor Installation Conditions and Precautions

The installation conditions and precautions for ABSOCODER sensor are described in this section.

- (1) Do not apply excessive forces to the cable port, and avoid damaging the cable.

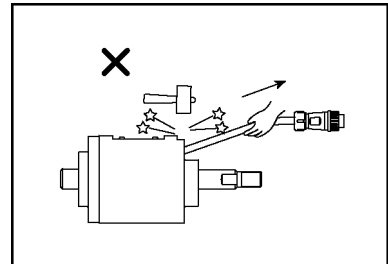

- (2) The part of a machine mounted the sensor rod must travel in the same direction as the sensor rod extends and contracts.

Do not use a floating joint.

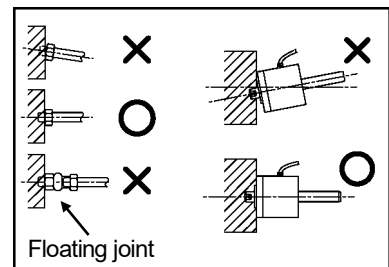

- (3) When the cable port is exposed, a shielding plate should be installed as shown in the right figure.

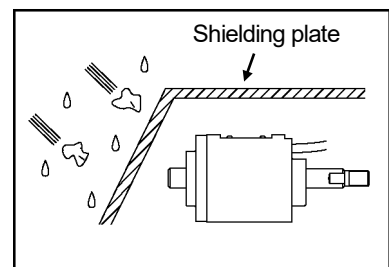

Contact your NSD representative for details of the installation conditions and precautions for ABSOCODER sensor.



## 7. WIRING

### 7-1. Connection between Converter and ABSOCODER Sensor

The maximum extension sensor cable length varies according to the ABSOCODER sensor and cable model being used. For more details refer to "3-2. ABSOCODER Sensor Specifications".

#### ●Wiring precautions

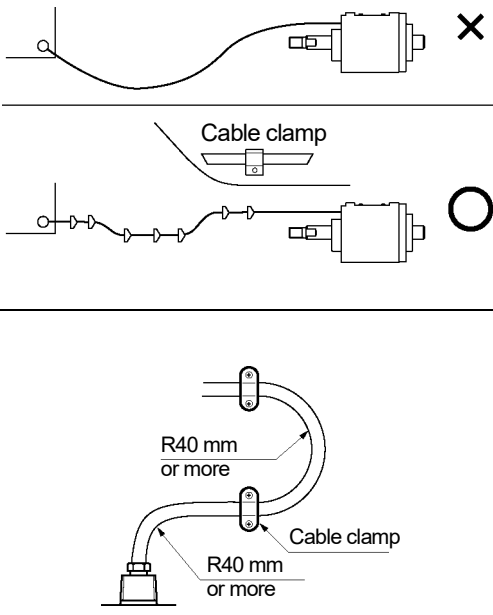
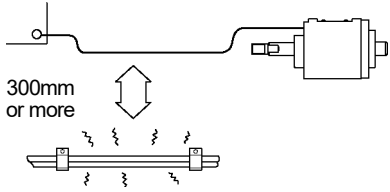
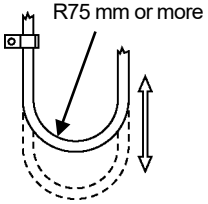
<p>(1) The sensor cable should be clamped as shown in the right figure to prevent excessive tension from being applied to the cable connectors.</p>	
<p>(2) The sensor cable should be located at least 300mm away from power lines and other lines which generate a high level of electrical noise.</p>	
<p>(3) If the cable is moved under the state of bending like a horseshoe, a robotic cable should be used. The bend radius should never be less than 75 mm.</p>	

## 7-1-1. Connection configure example of the sensor cable

Indicates the ABSOCODER sensor cable connection example when connecting by the standard connector or the crimping terminal.

- In the case of connecting by using the standard connector

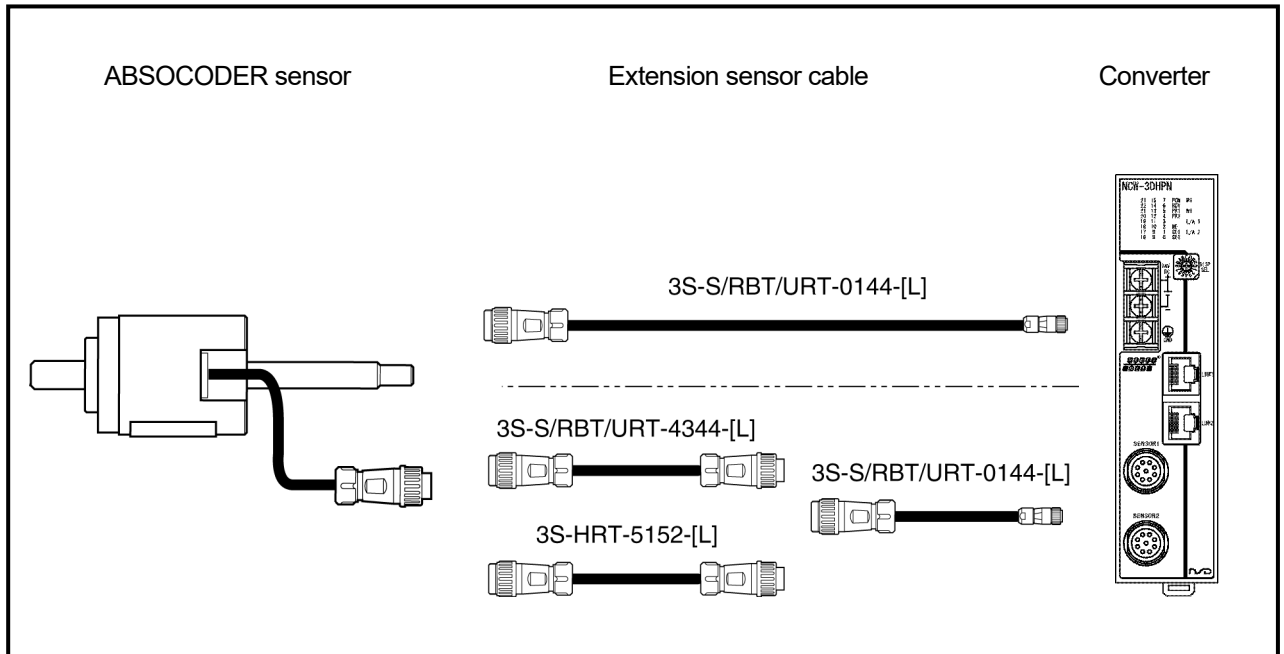

● In the case of connecting by using crimping terminals

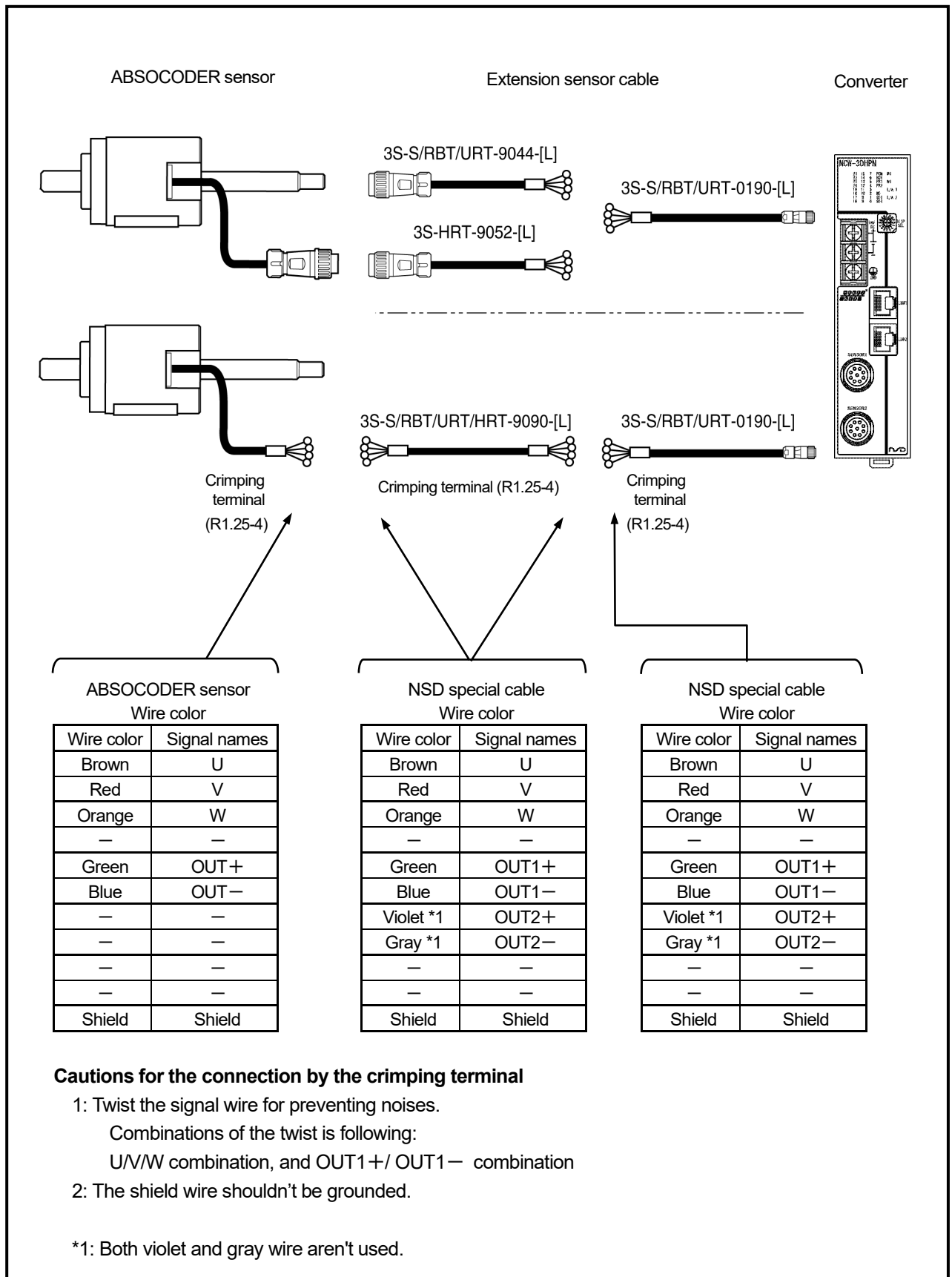

**Cautions for the connection by the crimping terminal**

- Twist the signal wire for preventing noises.  
Combinations of the twist is following:  
U/V/W combination, and OUT1+ / OUT1- combination
- The shield wire shouldn't be grounded.

\*1: Both violet and gray wire aren't used.

## 7-2. Power Supply Connection

The power supply should be connected as described below:

### ●Power Supply

- Choose the power supply capacity which is more than twice the power consumption of the converter.  
The power consumption of the converter is 10W or less.

- The input power supply should be isolated from the commercial power supply.

- The power cable should be as thick as possible to minimize voltage drops.

- Twist the power cable for preventing noises.

- Use the M4 size crimp lug terminals with insulating sleeves in order to prevent short circuit caused by loose screws.

- The terminal block tightening torque is 1.8 N·m (16 lb·in).

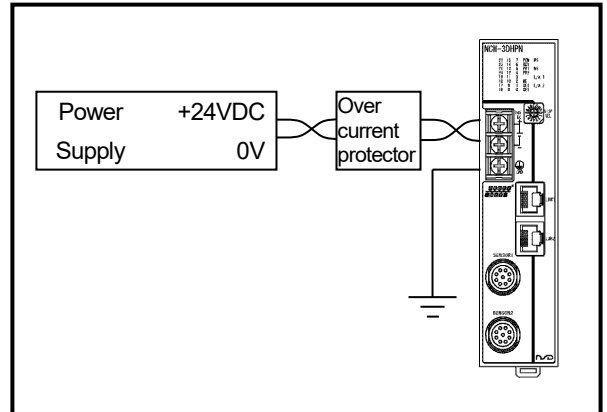

### ●Ground

- The unit should be securely grounded (ground resistance of 100ohm or less) to prevent electrical shocks.

- The ground wire should be connected to the ground terminal directly.

- The terminal block tightening torque is 1.8 N·m (16 lb·in).

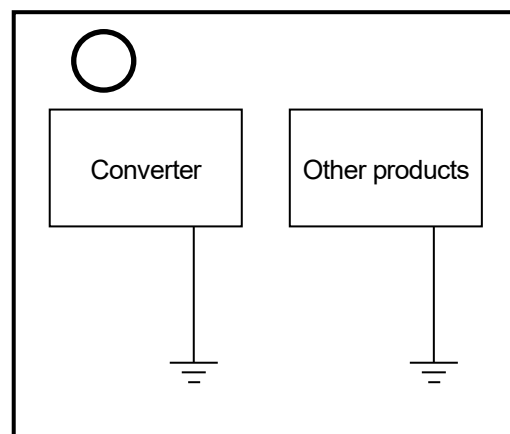
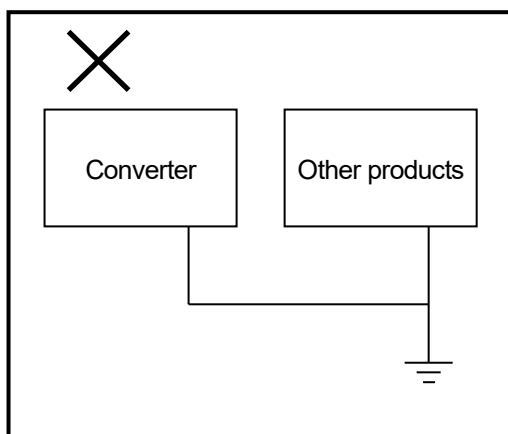

# 8. NOMENCLATURE

## 8-1. Part Identification

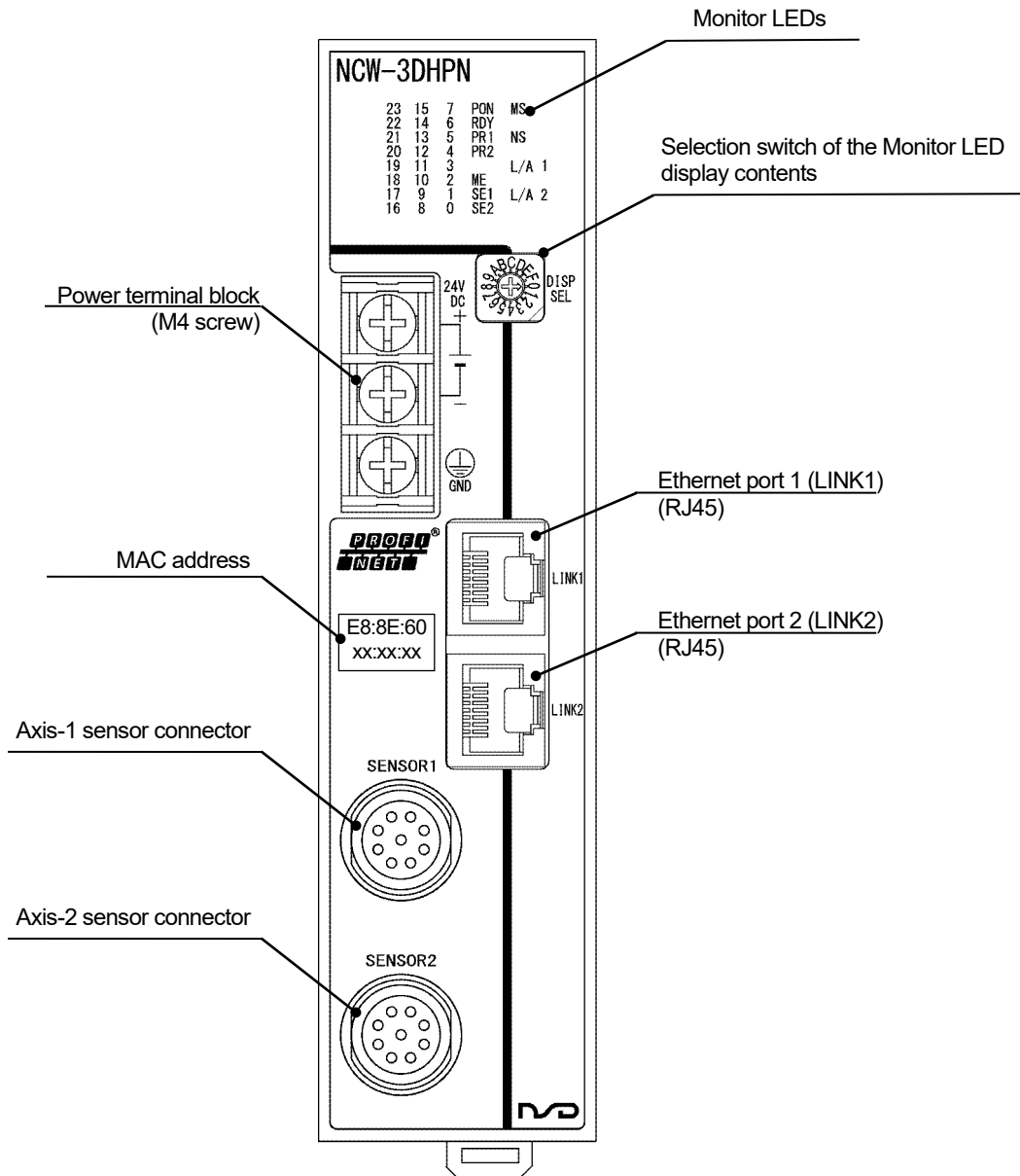

## 8-2. Function and Name of Indicator and Setting Area

Contents on the monitor LEDs are described in this section.

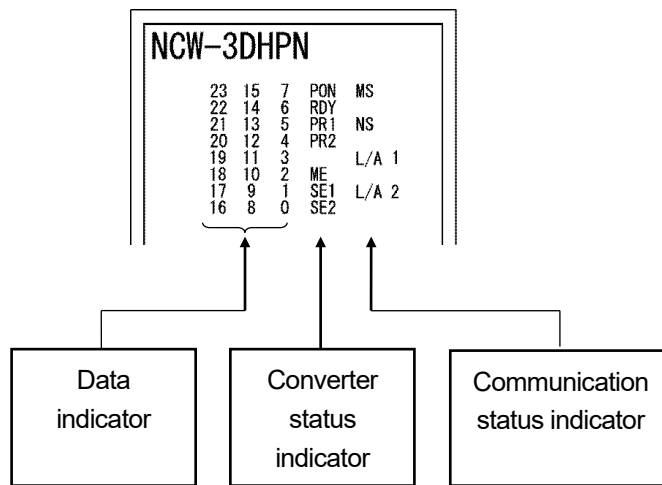

Indicator		LED color	Description
Communication status indicator *1	MS	Green / Red	Indicates the operation status of NCW-3DHPN.
	NS	Green / Red	Indicates the EtherNet/IP communication status of NCW-3DHPN.
	L/A1	Green	Indicates data sent and received status for the Ethernet port 1 (LINK 1).
	L/A2	Green	Indicates data sent and received status for the Ethernet port 2 (LINK 2).
Converter status indicator	PON	Green	ON when the power supply is functioning normally.
	RDY	Green	ON when Converter status is normal.
	PR1	Green	ON for approximately 1 second when the preset function operation (Current position setting) occurs with axis-1.
	PR2	Green	ON for approximately 1 second when the preset function operation (Current position setting) occurs with axis-2.
	ME	Red	ON when a memory error is occurred.
	SE1	Red	ON when the axis-1 sensor error is occurred.
	SE2	Red	ON when the axis-2 sensor error is occurred.
Data indicator *2	0 to 23	Green	Displays the content which was selected by the selecting switch (DISP SEL).

\*1: For the communication status indicator, refer to section 8-2-1.

\*2: For the data indicator, refer to section 8-2-2.

## 8-2-1. Contents of the communication status indicator area

Explains the overview of the PROFINET communication status indicator area.  
For more details, refer to “11. TROUBLE SHOOTING”.

Indicator	Color	Light status	Description
MS	Green/Red	OFF	No power
		Steady Green	Normal operation
		Flashing Red	A recoverable fault occurs
		Steady Red	An unrecoverable fault occurs
		Flashing Green / Red	LED test in progress
NS	Green/Red	OFF	No power
		Flashing Green	No connection is established
		Steady Green	Connection is established
		Flashing Red	GSDML error
		Steady Red	Faulty connection
L/A1	Green	OFF	LINK1 port: No link
		ON	LINK1 port: Link
		Flashing	LINK1 port: Link (during the communication)
L/A2	Green	OFF	LINK2 port: No link
		ON	LINK2 port: Link
		Flashing	LINK2 port: Link (during the communication)

## 8-2-2. Contents of the data indicator area

The data indicator content is changed by the display selection switch (DISP SEL).

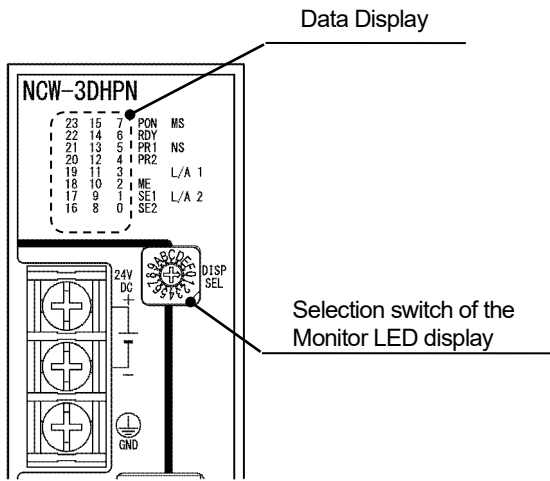

DISP SEL	Display content
0	Axis-1 position data D0-D23
1	Axis-2 position data D0-D23
2	Axis-1 preset data D0-D23 *1
3	Axis-2 preset data D0-D23 *1
4	Previous axis-1 preset data D0-D23 *2
5	Previous axis-2 preset data D0-D23 *2
6	Reserved
7	Converter diagnosis data *3
8	Parameter data *4
9	Ethernet network transmission setting *5
A	Reserved
B	Reserved
C	Reserved
D	Sensor circuit control information *6
E	Reserved
F	Reserved

\*1: Displays the preset data which is transmitted from the master.

\*2: Displays the preset data when preset was executed previously.

\*3: Converter diagnosis data

	7	6	5	4	3	2	1	0
Axis-1 diagnosis data	DE1	SPF1	SSE1	0	0	0	0	SE1
	15	14	13	12	11	10	9	8
Axis-2 diagnosis data	DE2	SPF2	SSE2	0	0	0	0	SE2
	23	22	21	20	19	18	17	16
Converter diagnosis data	0	0	0	0	I/F ERR	ME	WDTE	NRDY

\*4: Sensor parameter data

	7	6	5	4	3	2	1	0
Axis-1 parameter data	Reserved					Code Sequence 1	Reserved	Axis Unavailable 1
	15	14	13	12	11	10	9	8
Axis-2 parameter data	Reserved					Code Sequence 2	Reserved	Axis Unavailable 2
	23	22	21	20	19	18	17	16
Unused	0							



\*5: Ethernet network transmission setting

	7	6	5	4	3	2	1	0
LINK1	Reserved					Full Duplex	Reserved	100 Mbps
	15	14	13	12	11	10	9	8
LINK2	Reserved					Full Duplex	Reserved	100 Mbps
	23	22	21	20	19	18	17	16
IP address	IP Host address [IP.ADR] 8-bit							

- 100Mbps light turns ON when it is normal. Lights turn OFF when an error occurs.

\*6: Sensor circuit control information

Indicates the low-order 8-bit information of Output data (Axis-1 control flag and Axis-2 control flag) for Real-Time communication. For more details, refer to "9-9-1. I/O data format for Real-Time communication".

	7	6	5	4	3	2	1	0
Axis-1 Control (Bit0-7)	PRESET	ERRCLR	0	0	0	0	0	0
	15	14	13	12	11	10	9	8
Axis-2 Control (Bit8-15)	PRESET	ERRCLR	0	0	0	0	0	0
	23	22	21	20	19	18	17	16
Reserved	0	0	0	0	0	0	0	0

### 8-2-3. Ethernet port (LINK1/LINK2)

Ethernet communication cables are connected to these ports.

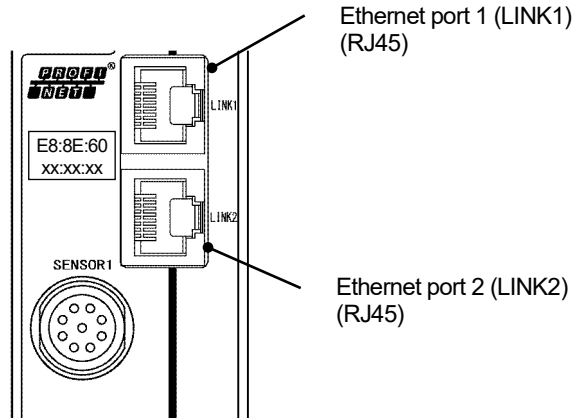

## 9. PROFINET COMMUNICATION SETUP

### 9-1. Procedure Before the Operation

Indicates procedure before the operation.

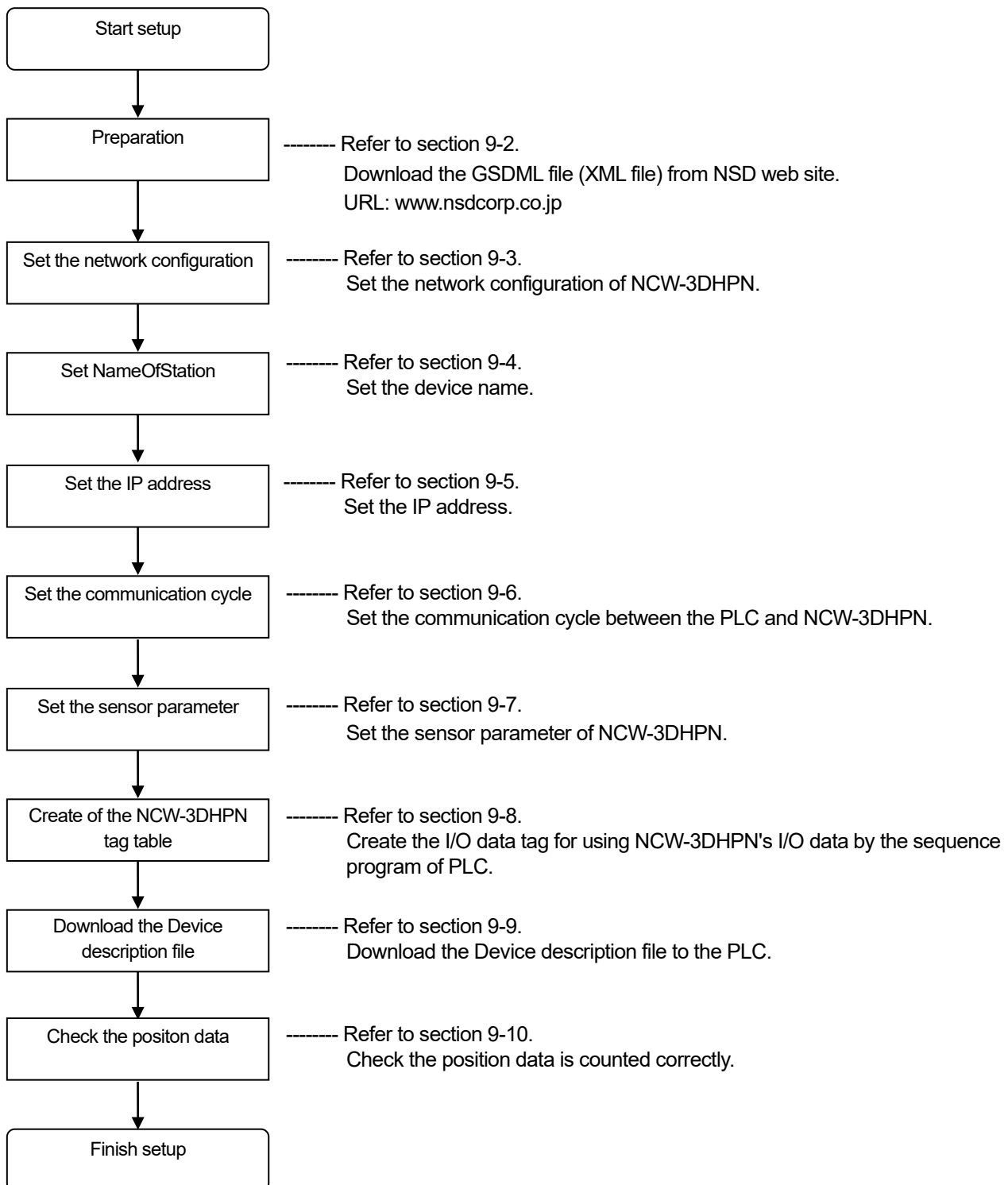

## 9-2. Preparation

Prepares that NCW-3DHPN connects the PROFINET network.

This manual assumes that NCW-3DHPN and a programmable controller which is manufactured by Siemens AG, Inc. are connected by the network. Therefore, we explain the manual by using a configuration tool "STEP7 V14 Professional SP1" developed by Siemens AG, Inc.. For the details of the tool, refer to manual of the "STEP7 V14 Professional SP1".

### ●Preparation of GDSML file

If the configuration tool is needed the definition file (GSDML file), download it from NSD website.

URL: [www.nsdcorp.co.jp](http://www.nsdcorp.co.jp)

File name: GSDML-V\*\*\*-NSD\_Corporation-NCW3D\_PN-\*\*\*\*\*

### ●Hardware Setup

The following figure indicates the connection of NCW-3DHPN as an example.

The NCW-3DHPN is connected to the controller (SIMATIC S7-1500 1511-1 PN) through the EtherNet switch (SCALANCE X204IRT 204-0BA00-2BA3) as shown below.

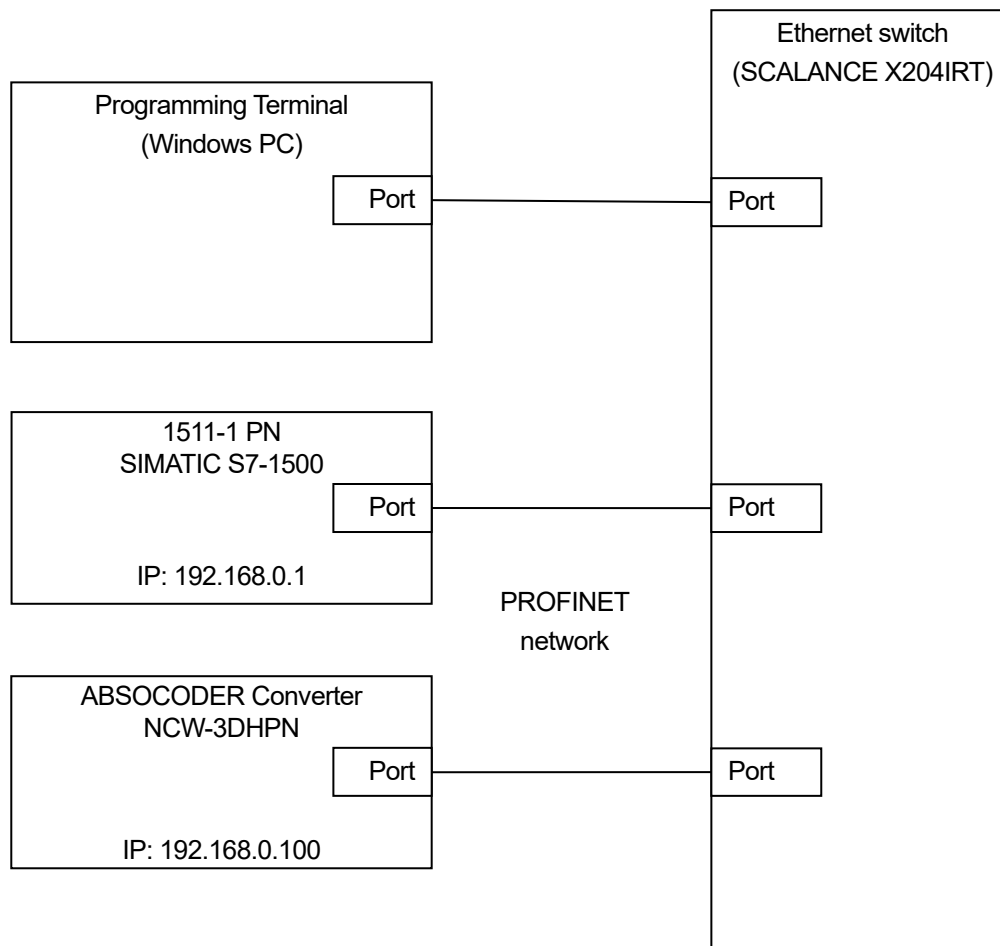

### 9-3. Set the Network Configuration

Set the network configuration of the converter after installing the GSDML file to the configuration tool.

#### 9-3-1. Installation of the GSDML file

Install the GSDML file of the converter to the configuration tool.

In the "Options" menu of the configuration tool, select the "Manage general station description files (GSD)" command.

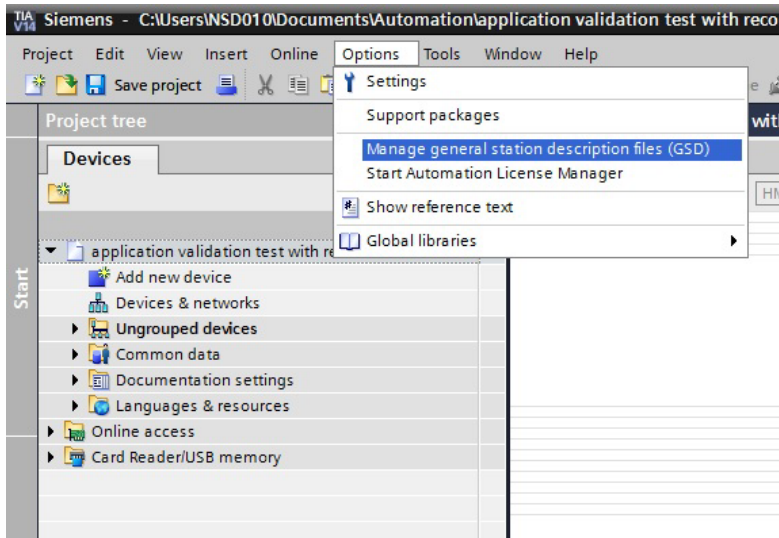

In the "Installed GSDs" tab, select the directory in which the GSDML files are stored. Check the box of the GSDML file which will be installed, and click on the "Install" button.

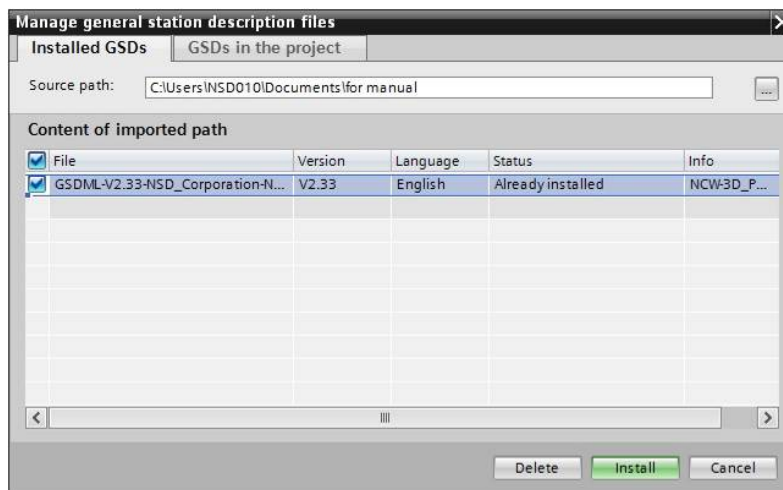

### 9-3-2. Creation of the network configuration

Select the GSDML file of the product which configures the network from "Hardware Catalog" after installing the GSDML file.

The GSDML file is stored in the following folders by each category.

- PLC ..... Controllers
- Switching hub ..... Network Components
- NCW-3DHPN ..... Other field devices → General

Select the GSDML file, and add the product on the network by drag and drop.

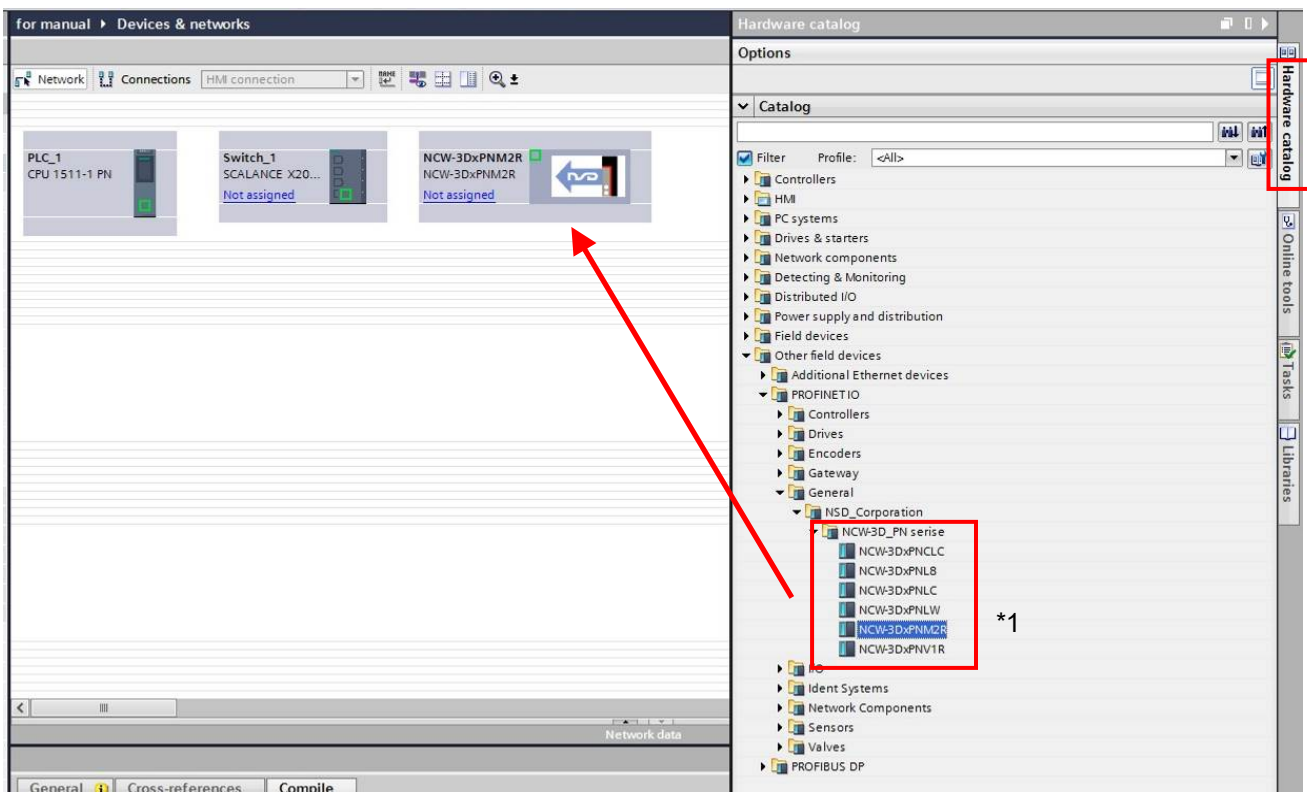

\*1: Select the converter model which is actually used because it changes depending on the sensor in-use.

Set the network configuration of the PLC and switching hub.

1. Select the PLC interface (indicated by green rectangle).



2. Drag the PLC interface to the switching hub interface to connect. A line appears when dragging.



3. PROFINET IO-System is configured between PLC and switching hub after releasing the drag.

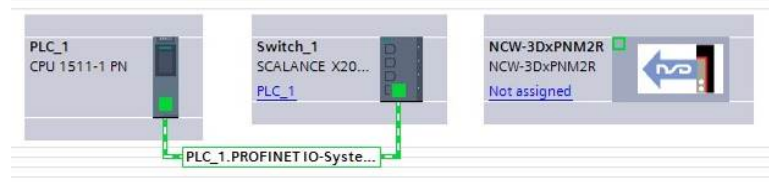

4. PROFINET IO-System is configured by connecting the line between NCW-3DHPN and switching hub by following the procedure 1 to 3.

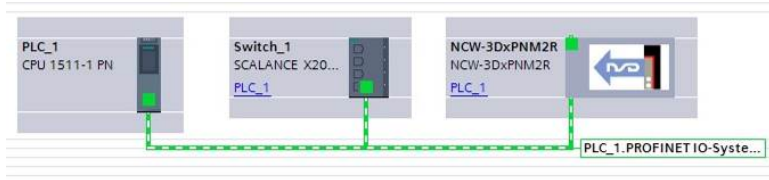

### 9-3-3. Set the topology

Sets the network topology.

Display the Topology view from main screen. Set the topology by following the actual network configuration.

The setting method is the same as the network configuration in "9-3-2".

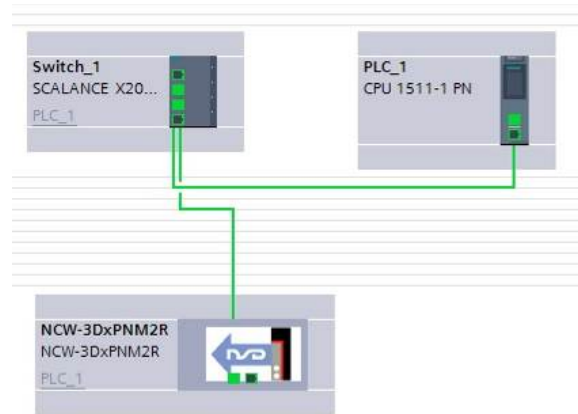



## 9-4. Set NameOfStation (Device Name)

The PROFINET configuration is needed setting each device name which is called "NameOfStation". The device name is previously set as a default name to the GSDML file.

Thus, the default name is displayed on the configuration tool. The configuration tool automatically adjusts the device name if the same product name exists on the network.

Setting procedures are indicated below;

(1) In the "Network view" tab, double click the converter which is set the device name.

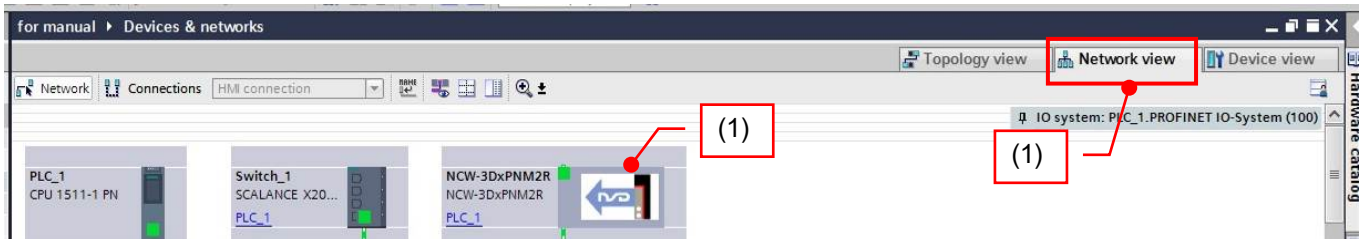

(2) Click the converter image when the "Device view" tab appears.

(3) Click "Ethernet Address" when "Properties" appears.

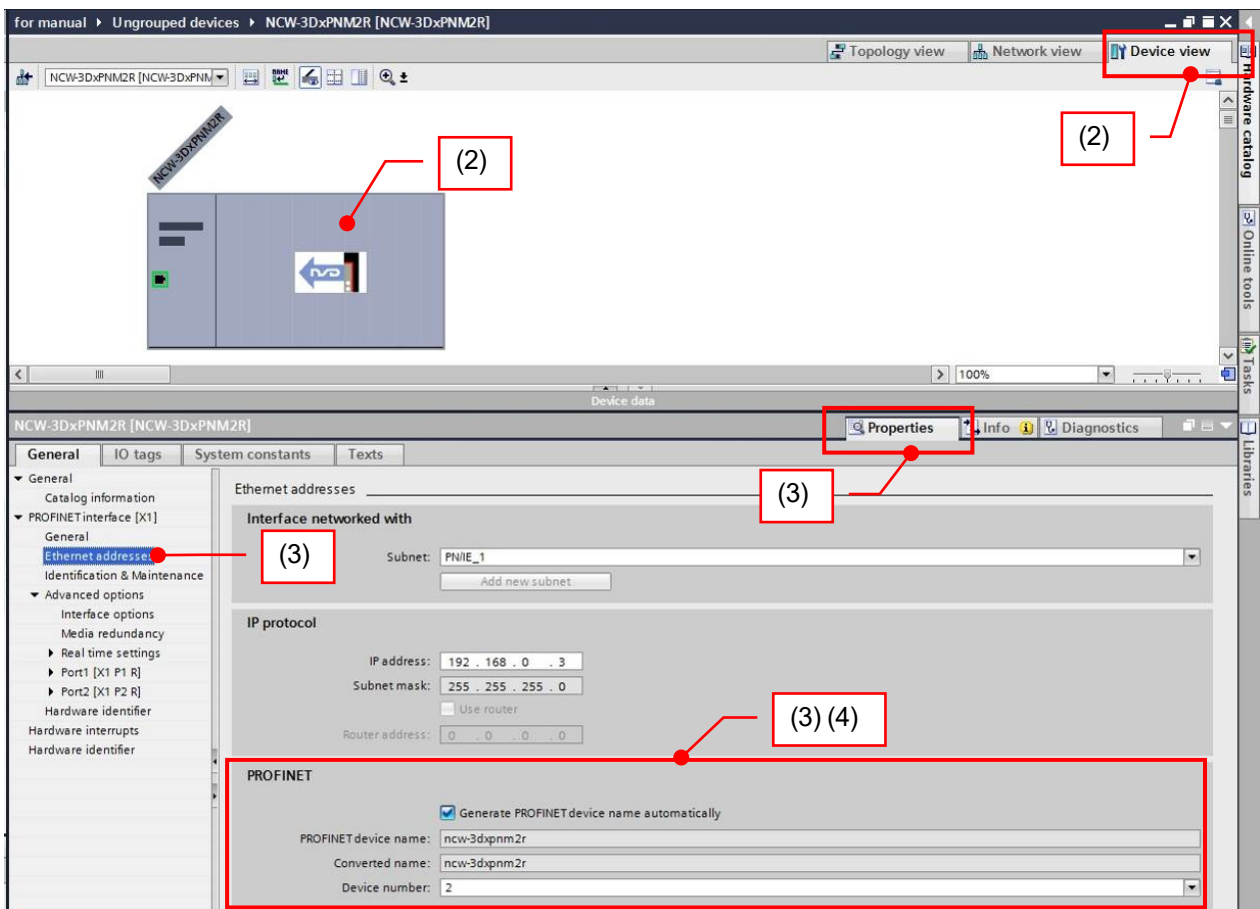

- (4) Check the box on "Generate PROFINET device name automatically" when using the default name. Remove the check-mark, and input a new device name on the "PROFINET device name" when changing the device name.

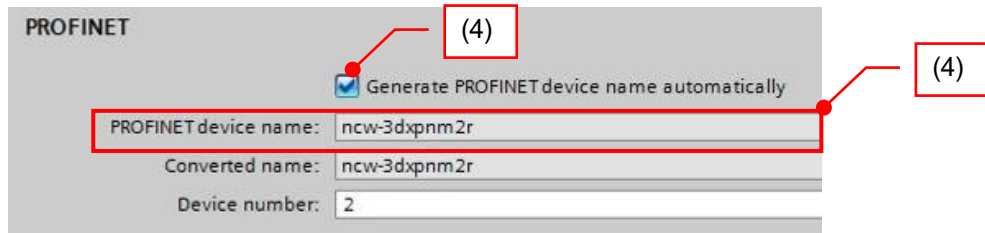

- (5) Set the device name to the converter.  
Right click on the converter image, and click "Assign device name".

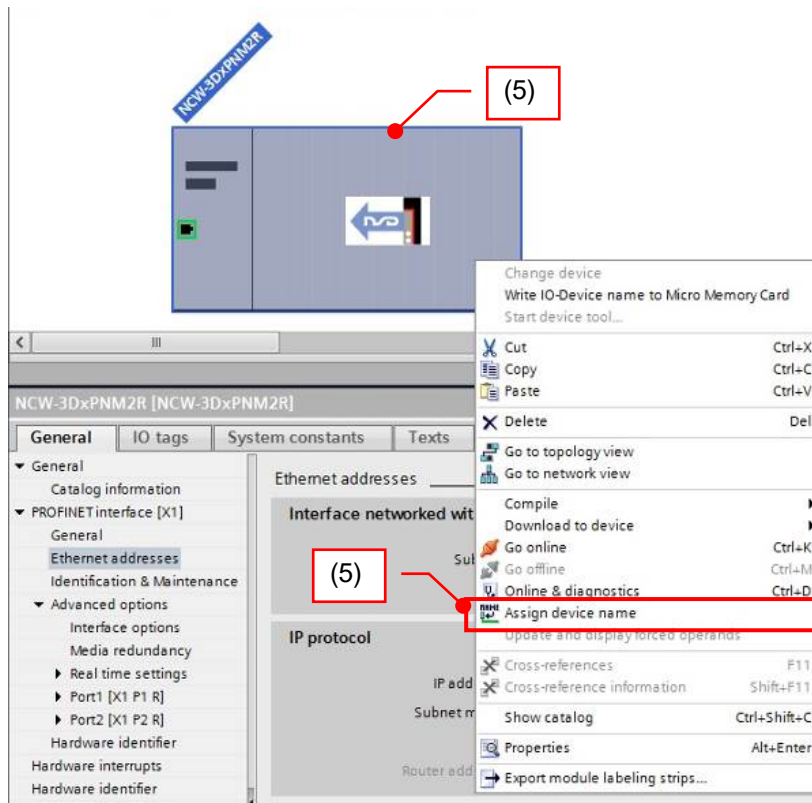

(6) "Assign PROFINET device name" window is appears on the screen.

Click "Update list" button.

The devices which can be changed the name are listed.

(7) Select the converter whose device name is changed, and click the "Assign name" button.

The device name is changed to the name which is set in procedure (4).

"OK" is displayed on the "Status" of the selected converter when changing of the device name is succeeded.

After the change, click "Close" button for closing the window.

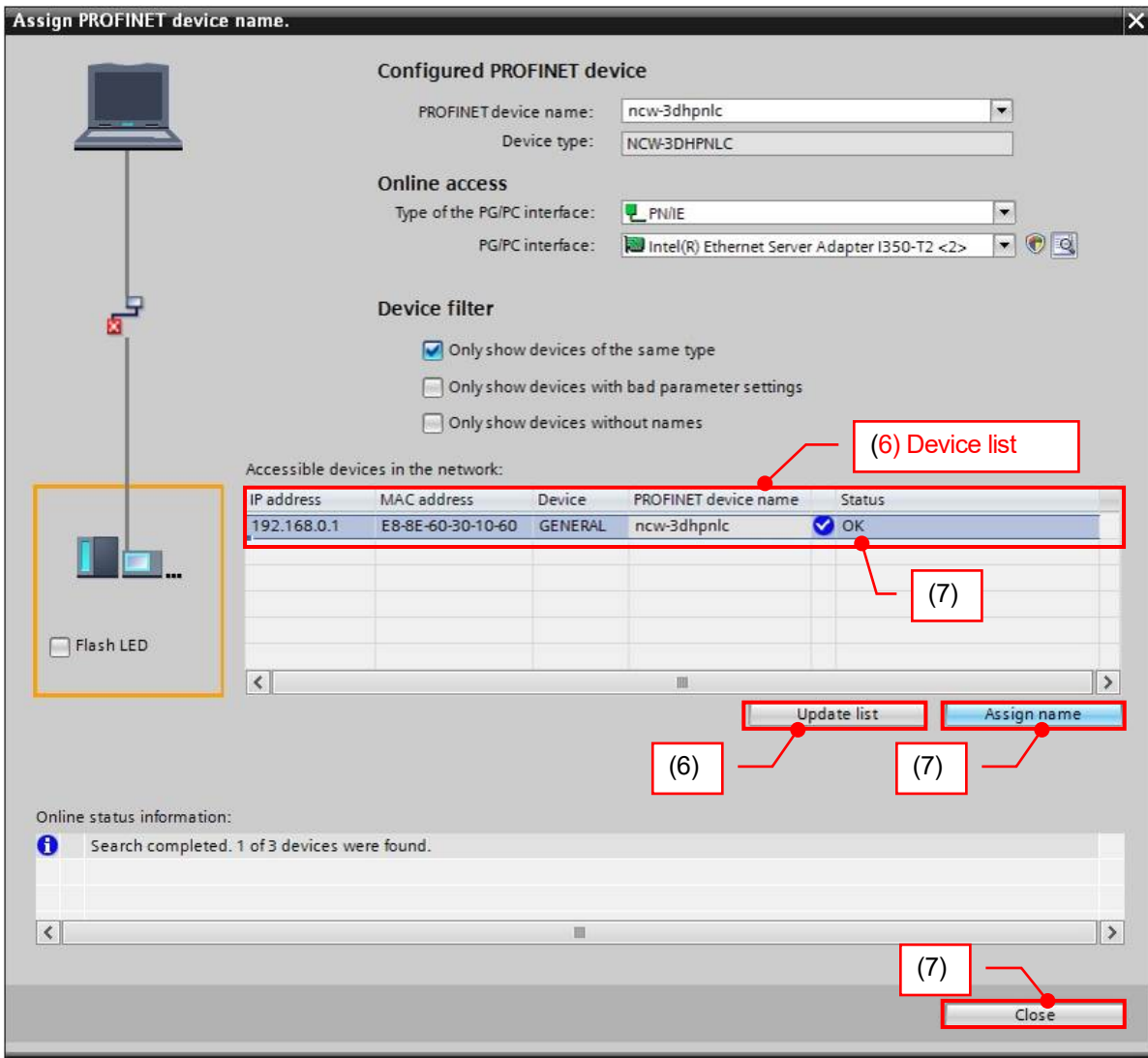

## 9-5. Set the IP Address

IP address for each device is automatically allocated.

IP address of the converter can be changed in the following window when it needs to change.

(1) In the "Device view" tab, display "IP protocol" from "General ->PROFINET Interface->Ethernet Address".

(2) Change the value of "IP address".

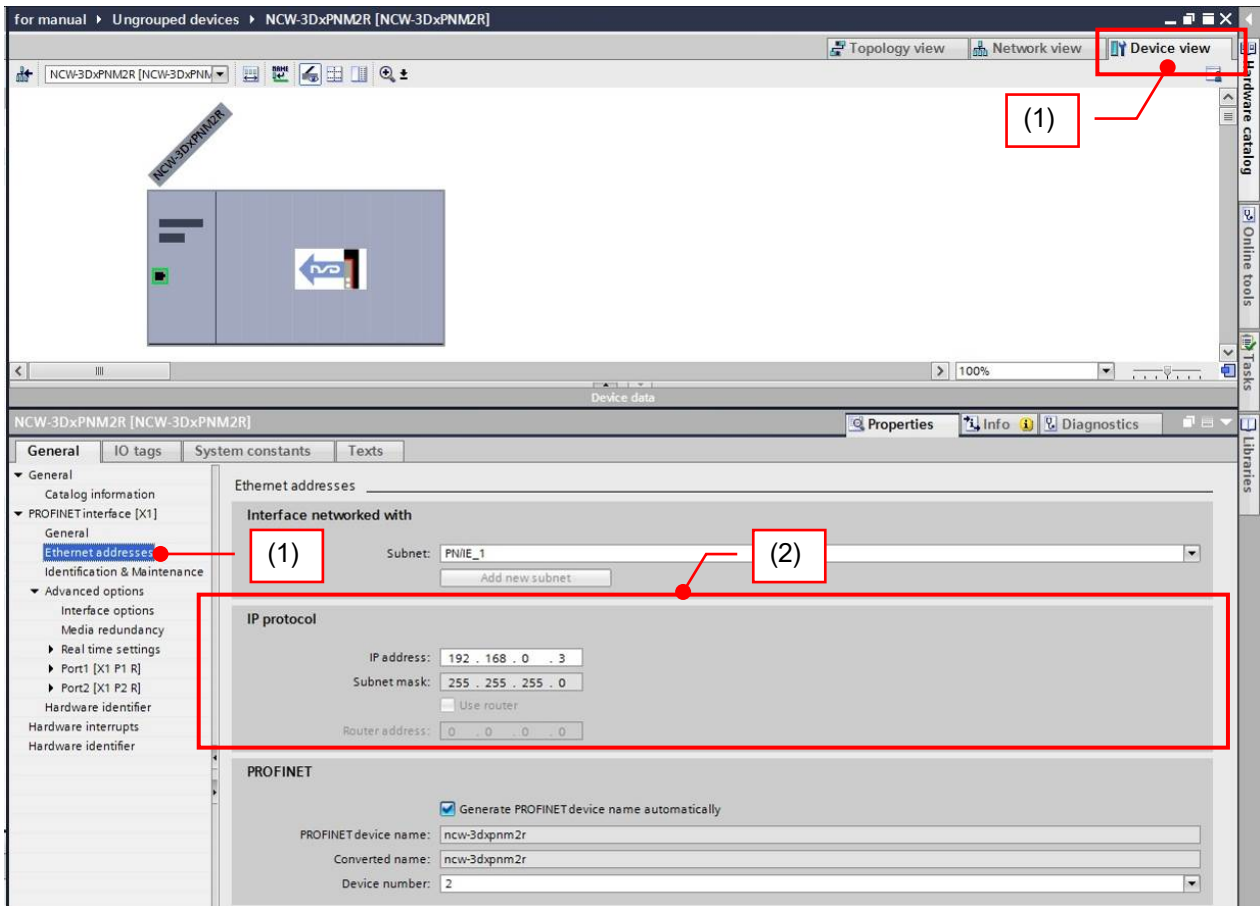

## 9-6. Set the Communication Cycle

Sets the communication cycle between the PLC and converter.

A default value of the communication cycle is set to "2ms (minimum value)".

Change the communication cycle in the following window if it needed to change.

(1) In the "Device view" tab, display "Update time" from General->PROFINET Interface->Advanced options->Real time settings->IO cycle.

(2) In the default setting, "Calculate update time automatically" is checked.

Check "Set update time manually", and select the update time when changing it.

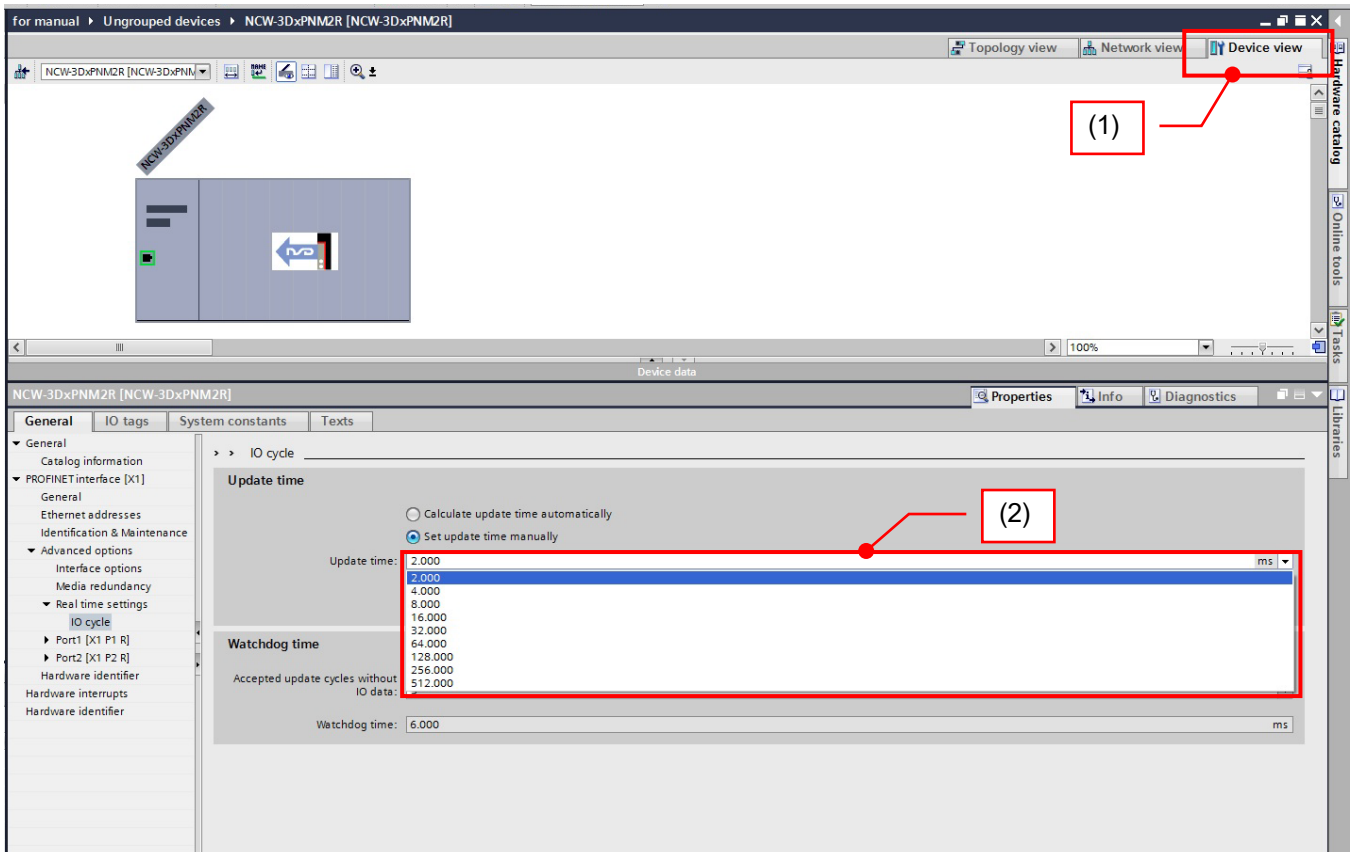

## 9-7. Set Sensor Parameter of NCW-3DHPN

Before NCW-3DHPN is used, parameters must be configured.

The parameter value set at configuration tool is written to NCW-3DHPN when the communication is established for PROFINET.

 <b>Note</b>
<p>The sensor parameter can be also set from the WRREC of the PLC function.          However, a value is change to it set by the configuration tool when communication is reestablished (relinking-up or restarting the power supply). In this case, set the parameter from the WRREC again.</p>

### 9-7-1. Sensor parameter list

NCW-3DHPN has following sensor parameters.

Sensor parameter setting values are saved in the nonvolatile memory; therefore, NCW-3DHPN can operate with previous designated parameters after turning on the power supply again.

Axis	Parameter Name	Description
For axis-1 sensor	Axis Unavailable	Specify "Enable" or "Disable" for the axis. 0: Enable (Default) 1: Disable
	Code Sequence (Position Data Increase Direction)	Specify the ABSOCODER sensor rotation direction in which the position data increases. 0: CW (Default) 1: CCW
For axis-2 sensor	Axis Unavailable	Specify "Enable" or "Disable" for the axis. 0: Enable (Default) 1: Disable
	Code Sequence (Position Data Increase Direction)	Specify the ABSOCODER sensor rotation direction in which the position data increases. 0: CW (Default) 1: CCW

◆ Travel direction of the rod

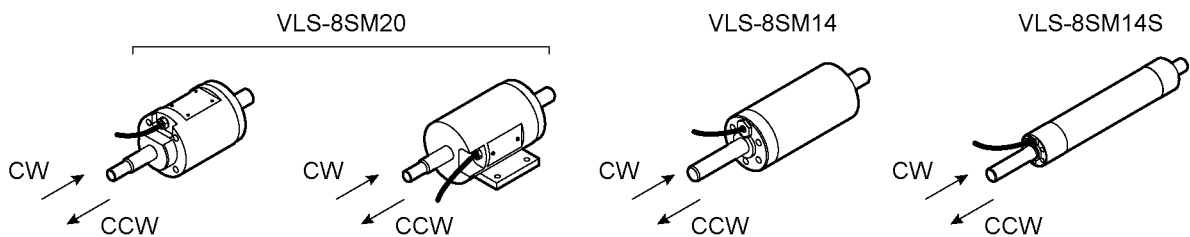

## 9-7-2. Sensor parameters setting procedure

Setting procedures of the sensor parameter is indicated below.

- (1) Select "Device view->Device overview".
- (2) Right-click "Parameter Access Point", and click "Properties".

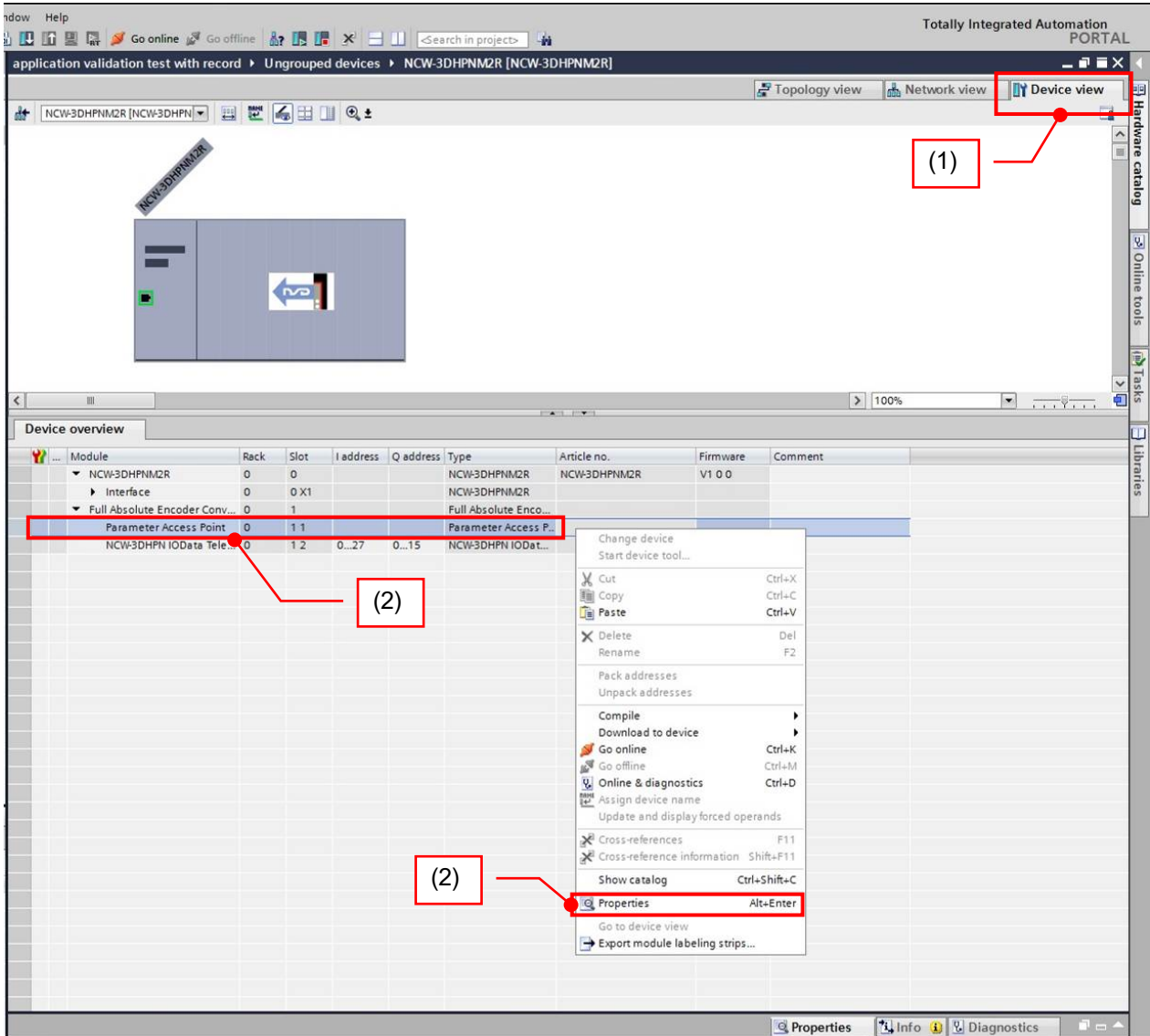

- (3) Set the sensor parameter.  
Set the parameter when displaying "Module Parameters".

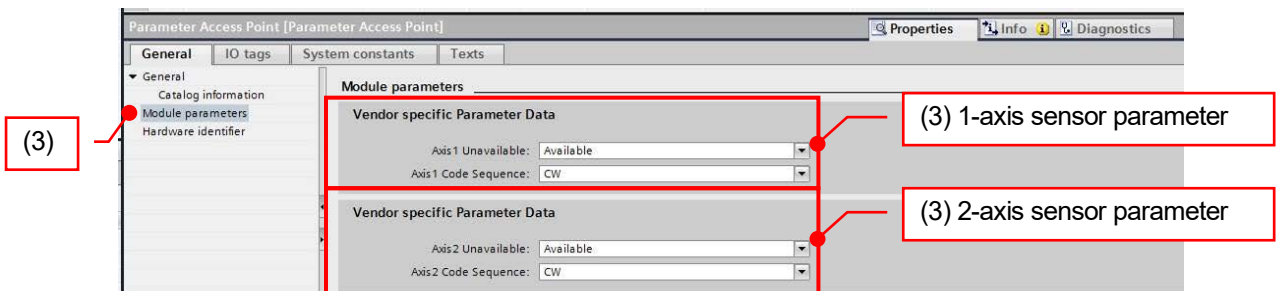

## 9-8. Create of the NCW-3DHPN Tag Table

Create I/O data tag in "Default tag table" in order to use I/O data of NCW-3DHPN in the PLC sequence program. The I/O data tag is created for axis-1 and axis-2; however, a tag of unused axis doesn't need to create.

Indicates procedures of the I/O data tag.

- (1) Select "PLC->PLC Tag->Default tag table", and display "default tag table".
- (2) Input the data tag name.

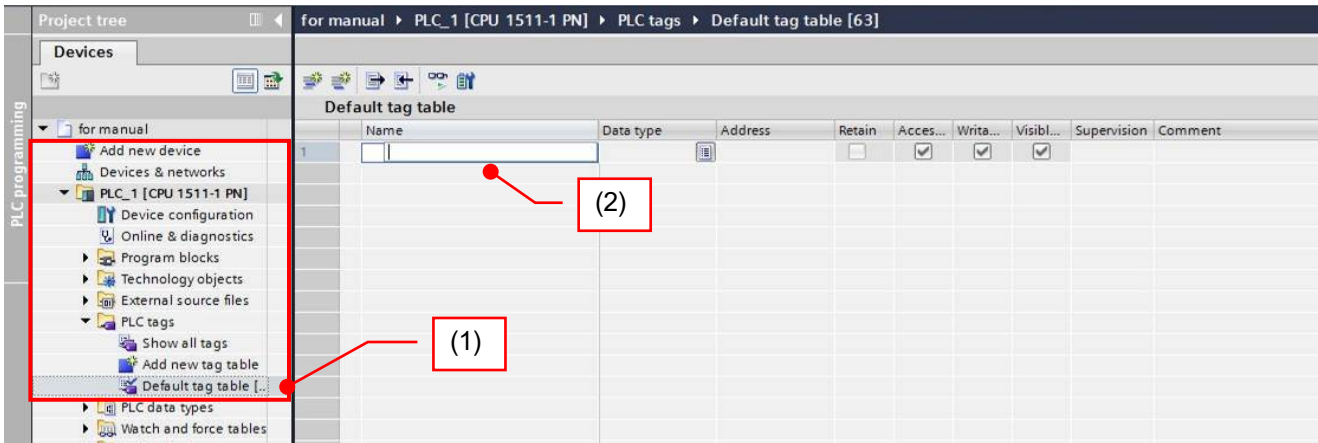

- (3) Selects a data type of the data tag.  
Check the data type for each I/O data by referring to "9-8-1. I/O data format".

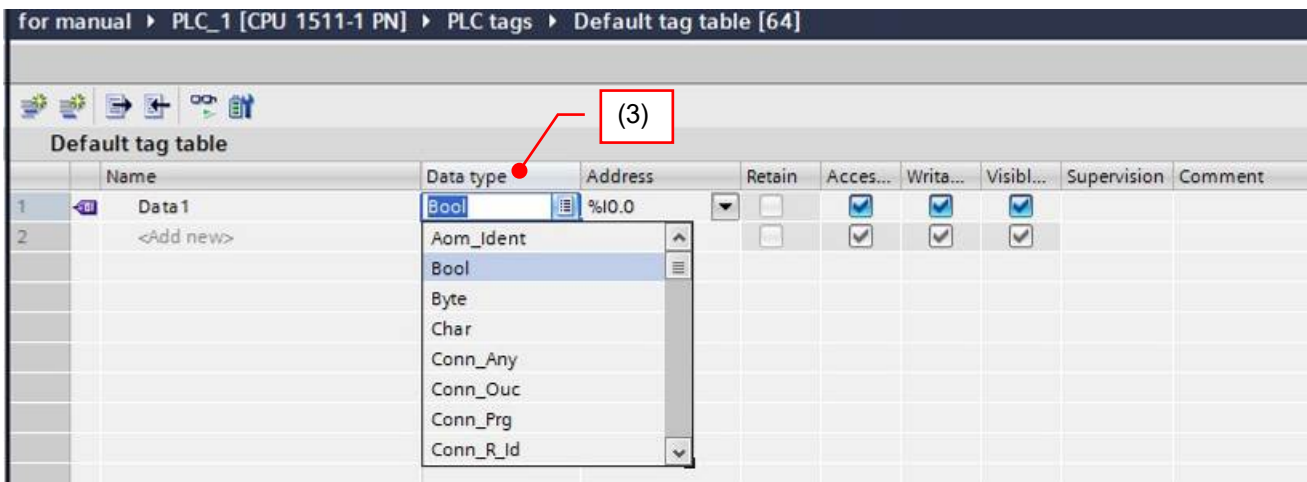



(4) Set the data tag address.

On "Operand identifier", "I" indicates the input of the I/O data, and "O" is the output.

For more details, refer to the "9-8-1. I/O data format".

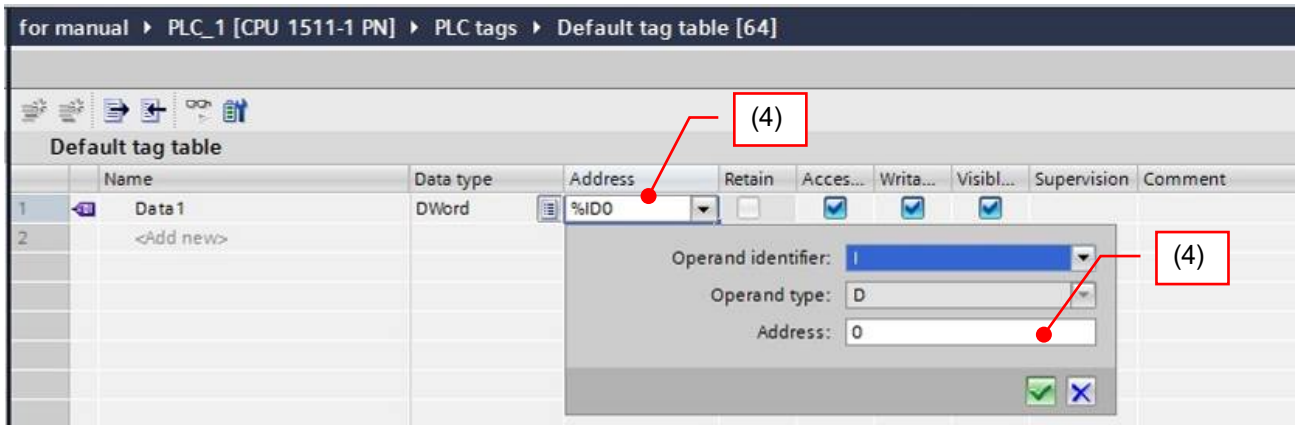

For each address of the I/O data, check I Address and Q Address in "Device view->Device overview".

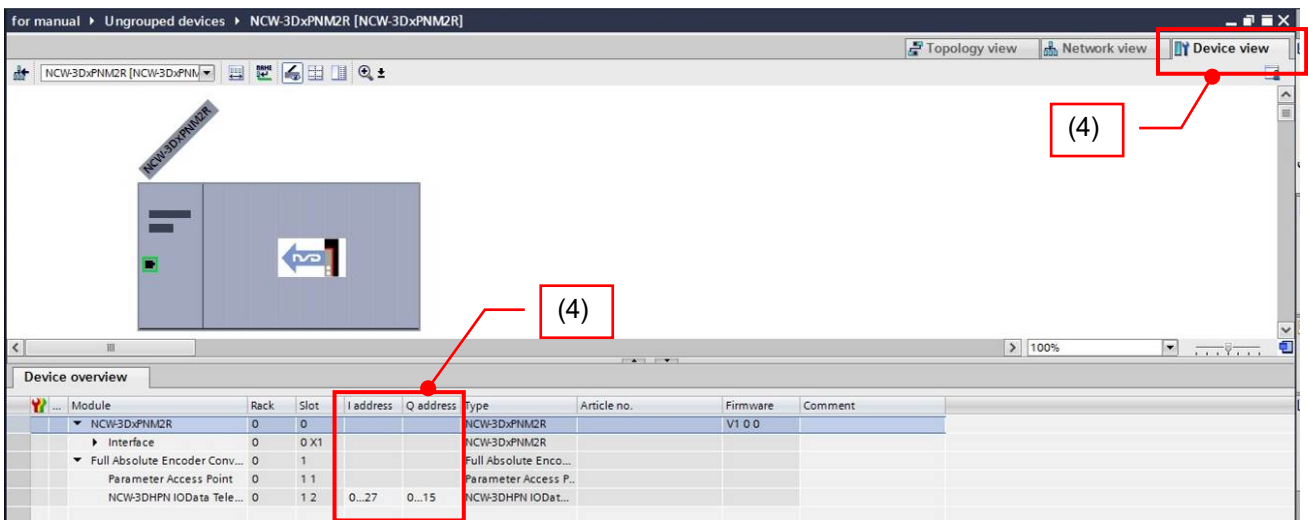

(5) Create a data tag for either axis-1 or axis-2 by repeating the procedure (2) to (4).

Items indicated on the following data tags are the same as items written on "9-8-1. I/O data format".

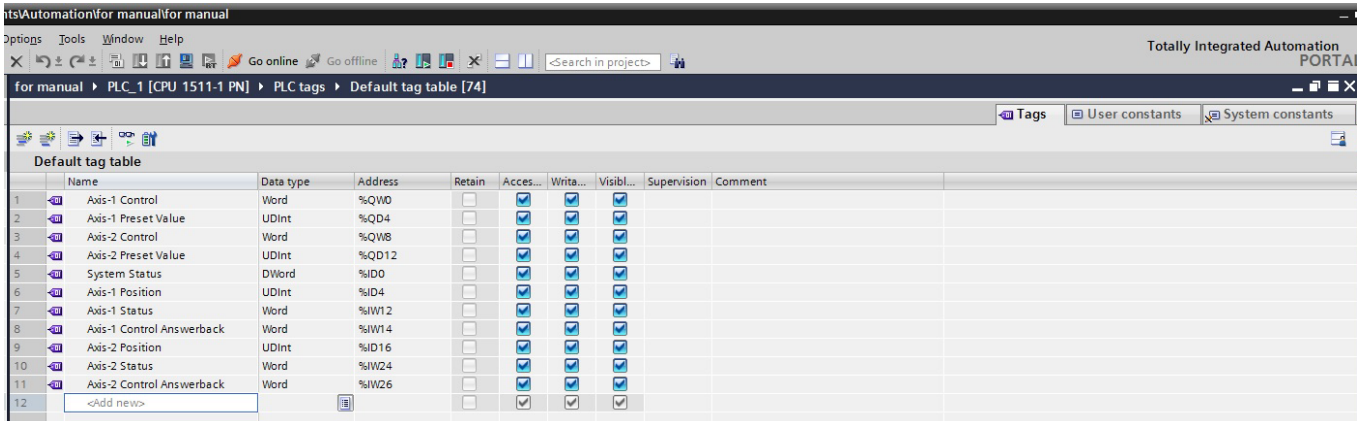

## 9-8-1. I/O data format

Indicates the I/O data format of NCW-3DHPN.

### (1) Output (Controller -> Device) Data Format (Size: 16-byte)

Offset Address (Byte)	Data Format												
	Data type	Name	Description										
+0	WORD	Axis-1 Control	<table border="1"> <thead> <tr> <th>Bit</th> <th>Description</th> </tr> </thead> <tbody> <tr> <td>0-5</td> <td>Reserved</td> </tr> <tr> <td>6</td> <td>ERRCLR (Error Clear Command) Clears an error that is monitored from Axis-1 Status. 0: Not clear an error 1: Clear an error</td> </tr> <tr> <td>7</td> <td>PRESET (Preset Command) Presets a position data for Axis-1. Specify "1: Execute PRESET" after setting the preset value for Axis-1. 0: Unexecute PRESET 1: Execute PRESET</td> </tr> <tr> <td>8-15</td> <td>Reserved</td> </tr> </tbody> </table>	Bit	Description	0-5	Reserved	6	ERRCLR (Error Clear Command) Clears an error that is monitored from Axis-1 Status. 0: Not clear an error 1: Clear an error	7	PRESET (Preset Command) Presets a position data for Axis-1. Specify "1: Execute PRESET" after setting the preset value for Axis-1. 0: Unexecute PRESET 1: Execute PRESET	8-15	Reserved
Bit	Description												
0-5	Reserved												
6	ERRCLR (Error Clear Command) Clears an error that is monitored from Axis-1 Status. 0: Not clear an error 1: Clear an error												
7	PRESET (Preset Command) Presets a position data for Axis-1. Specify "1: Execute PRESET" after setting the preset value for Axis-1. 0: Unexecute PRESET 1: Execute PRESET												
8-15	Reserved												
+2	WORD	Reserved	—										
+4	UDINT	Axis-1 PresetValue	Axis-1 Preset Value Sets the preset value for Axis-1. Set any value to the preset before operating the Bit7 (PRESET) of Axis-1 control flag.										
+8	WORD	Axis-2 Control	<table border="1"> <thead> <tr> <th>Bit</th> <th>Description</th> </tr> </thead> <tbody> <tr> <td>0-5</td> <td>Reserved</td> </tr> <tr> <td>6</td> <td>ERRCLR (Error Clear Command) Clears an error that is monitored from Axis-2 Status. 0: Not clear an error 1: Clear an error</td> </tr> <tr> <td>7</td> <td>PRESET (Preset Command) Presets a position data for Axis-2. Specify "1: Execute PRESET" after setting the preset value for Axis-2. 0 : Unexecute PRESET 1 : Execute PRESET</td> </tr> <tr> <td>8-15</td> <td>Reserved</td> </tr> </tbody> </table>	Bit	Description	0-5	Reserved	6	ERRCLR (Error Clear Command) Clears an error that is monitored from Axis-2 Status. 0: Not clear an error 1: Clear an error	7	PRESET (Preset Command) Presets a position data for Axis-2. Specify "1: Execute PRESET" after setting the preset value for Axis-2. 0 : Unexecute PRESET 1 : Execute PRESET	8-15	Reserved
Bit	Description												
0-5	Reserved												
6	ERRCLR (Error Clear Command) Clears an error that is monitored from Axis-2 Status. 0: Not clear an error 1: Clear an error												
7	PRESET (Preset Command) Presets a position data for Axis-2. Specify "1: Execute PRESET" after setting the preset value for Axis-2. 0 : Unexecute PRESET 1 : Execute PRESET												
8-15	Reserved												
+10	WORD	Reserved	—										
+12	UDINT	Axis-2 PresetValue	Axis-2 Preset Value Sets the preset value for Axis-2. Set any value to the preset before operating the Bit7 (PRESET) of Axis-2 control flag.										

(2) Input (Device -> Controller) Data Format (Size: 28-byte)

Offset Address (Byte)	Data Format																		
	Data type	Name	Description																
+0	DWORD	System Status	<table border="1"> <thead> <tr> <th colspan="2">NCW-3DHPN Diagnosis Status</th> </tr> <tr> <th>Bit</th> <th>Description</th> </tr> </thead> <tbody> <tr> <td>0</td> <td> <p>NRDY (Internal Error) Indicates that an internal error of NCW-3DHPN occurred. The hardware might have malfunction if the converter doesn't operate normally after restarting the power supply. Replace NCW-3DHPN. 0: Normal 1: Error</p> </td> </tr> <tr> <td>1</td> <td> <p>WDTE (Watchdog Timer Error) Indicates a watchdog timer error of NCW-3DHPN. 0: Normal 1: Error</p> </td> </tr> <tr> <td>2</td> <td> <p>ME (Memory Error) Indicates that the internal memory (FRAM, EEPROM) of NCW-3DHPN is malfunction. 0: Normal 1: Error</p> </td> </tr> <tr> <td>3-7</td> <td>Reserved</td> </tr> <tr> <td>8</td> <td> <p>I/F ERR (Internal I/F Error) Indicates that the internal I/F circuit has an error. 0: No error 1: Error</p> </td> </tr> <tr> <td>9-31</td> <td>Reserved</td> </tr> </tbody> </table>	NCW-3DHPN Diagnosis Status		Bit	Description	0	<p>NRDY (Internal Error) Indicates that an internal error of NCW-3DHPN occurred. The hardware might have malfunction if the converter doesn't operate normally after restarting the power supply. Replace NCW-3DHPN. 0: Normal 1: Error</p>	1	<p>WDTE (Watchdog Timer Error) Indicates a watchdog timer error of NCW-3DHPN. 0: Normal 1: Error</p>	2	<p>ME (Memory Error) Indicates that the internal memory (FRAM, EEPROM) of NCW-3DHPN is malfunction. 0: Normal 1: Error</p>	3-7	Reserved	8	<p>I/F ERR (Internal I/F Error) Indicates that the internal I/F circuit has an error. 0: No error 1: Error</p>	9-31	Reserved
NCW-3DHPN Diagnosis Status																			
Bit	Description																		
0	<p>NRDY (Internal Error) Indicates that an internal error of NCW-3DHPN occurred. The hardware might have malfunction if the converter doesn't operate normally after restarting the power supply. Replace NCW-3DHPN. 0: Normal 1: Error</p>																		
1	<p>WDTE (Watchdog Timer Error) Indicates a watchdog timer error of NCW-3DHPN. 0: Normal 1: Error</p>																		
2	<p>ME (Memory Error) Indicates that the internal memory (FRAM, EEPROM) of NCW-3DHPN is malfunction. 0: Normal 1: Error</p>																		
3-7	Reserved																		
8	<p>I/F ERR (Internal I/F Error) Indicates that the internal I/F circuit has an error. 0: No error 1: Error</p>																		
9-31	Reserved																		
+4	UDINT	Axis-1 Position	<p>Axis-1 Position data Shows the Axis-1 Position data.</p>																
+8	UDINT	Previous Axis-1 Preset Data	<p>Previous axis-1 preset data Displays the preset data when axis-1 preset was executed previously.</p>																
+12	WORD	Axis-1 Status	<table border="1"> <thead> <tr> <th colspan="2">Axis-1 Status</th> </tr> <tr> <th>Bit</th> <th>Description</th> </tr> </thead> <tbody> <tr> <td>0</td> <td> <p>SE (Sensor Error) Indicates that a SSE/SPF/DE occurred. 0: No error 1: Error</p> </td> </tr> <tr> <td>1-4</td> <td>Reserved</td> </tr> <tr> <td>5</td> <td> <p>SSE (Disconnected Sensor Error) Indicates that a sensor is disconnected. 0: Connected 1: Disconnected (Error)</p> </td> </tr> <tr> <td>6</td> <td> <p>SPF (Sensor Circuit Power Error) Indicates that the internal power supply of NCW-3DHPN is malfunction. 0: Normal 1: Error</p> </td> </tr> <tr> <td>7</td> <td> <p>DE (Sensor Data Error) Indicates that position data has an error. 0: No error 1: Error</p> </td> </tr> <tr> <td>8-15</td> <td>Reserved</td> </tr> </tbody> </table>	Axis-1 Status		Bit	Description	0	<p>SE (Sensor Error) Indicates that a SSE/SPF/DE occurred. 0: No error 1: Error</p>	1-4	Reserved	5	<p>SSE (Disconnected Sensor Error) Indicates that a sensor is disconnected. 0: Connected 1: Disconnected (Error)</p>	6	<p>SPF (Sensor Circuit Power Error) Indicates that the internal power supply of NCW-3DHPN is malfunction. 0: Normal 1: Error</p>	7	<p>DE (Sensor Data Error) Indicates that position data has an error. 0: No error 1: Error</p>	8-15	Reserved
Axis-1 Status																			
Bit	Description																		
0	<p>SE (Sensor Error) Indicates that a SSE/SPF/DE occurred. 0: No error 1: Error</p>																		
1-4	Reserved																		
5	<p>SSE (Disconnected Sensor Error) Indicates that a sensor is disconnected. 0: Connected 1: Disconnected (Error)</p>																		
6	<p>SPF (Sensor Circuit Power Error) Indicates that the internal power supply of NCW-3DHPN is malfunction. 0: Normal 1: Error</p>																		
7	<p>DE (Sensor Data Error) Indicates that position data has an error. 0: No error 1: Error</p>																		
8-15	Reserved																		

Offset Address (Byte)	Data Format																		
	Data type	Name	Description																
+14	WORD	Axis-1 Control Answerback	<table border="1"> <thead> <tr> <th colspan="2">Axis-1 Control Flag Answerback</th> </tr> <tr> <th>Bit</th> <th>Description</th> </tr> </thead> <tbody> <tr> <td>0-5</td> <td>Reserved</td> </tr> <tr> <td>6</td> <td>ERRCLR (Error Clear) Answerback 0: "ERRCLR" failed. 1: "ERRCLR" succeeded</td> </tr> <tr> <td>7</td> <td>PRESET Answerback 0: "PRESET" failed 1: "PRESET" succeeded.</td> </tr> <tr> <td>8-15</td> <td>Reserved</td> </tr> </tbody> </table>	Axis-1 Control Flag Answerback		Bit	Description	0-5	Reserved	6	ERRCLR (Error Clear) Answerback 0: "ERRCLR" failed. 1: "ERRCLR" succeeded	7	PRESET Answerback 0: "PRESET" failed 1: "PRESET" succeeded.	8-15	Reserved				
Axis-1 Control Flag Answerback																			
Bit	Description																		
0-5	Reserved																		
6	ERRCLR (Error Clear) Answerback 0: "ERRCLR" failed. 1: "ERRCLR" succeeded																		
7	PRESET Answerback 0: "PRESET" failed 1: "PRESET" succeeded.																		
8-15	Reserved																		
+16	UDINT	Axis-2 Position	Axis-2 Position data Shows the Axis-2 Position data.																
+20	UDINT	Previous Axis-2 Preset Data	Previous axis-2 preset data Displays the preset data when axis-2 preset was executed previously.																
+24	WORD	Axis-2 Status	<table border="1"> <thead> <tr> <th colspan="2">Axis-2 Status</th> </tr> <tr> <th>Bit</th> <th>Description</th> </tr> </thead> <tbody> <tr> <td>0</td> <td>SE (Sensor Error) Indicates that a SSE/SPF/DE occurred. 0: No error 1: Error</td> </tr> <tr> <td>1-4</td> <td>Reserved</td> </tr> <tr> <td>5</td> <td>SSE (Disconnected Sensor Error) Indicates that a sensor is disconnected. 0: Connected 1: Disconnected (Error)</td> </tr> <tr> <td>6</td> <td>SPF (Sensor Circuit Power Error) Indicates that the internal power supply of NCW-3DHPN is malfunction. 0: Normal 1: Error</td> </tr> <tr> <td>7</td> <td>DE (Sensor Data Error) Indicates that position data has an error. 0: No error 1: Error</td> </tr> <tr> <td>8-15</td> <td>Reserved</td> </tr> </tbody> </table>	Axis-2 Status		Bit	Description	0	SE (Sensor Error) Indicates that a SSE/SPF/DE occurred. 0: No error 1: Error	1-4	Reserved	5	SSE (Disconnected Sensor Error) Indicates that a sensor is disconnected. 0: Connected 1: Disconnected (Error)	6	SPF (Sensor Circuit Power Error) Indicates that the internal power supply of NCW-3DHPN is malfunction. 0: Normal 1: Error	7	DE (Sensor Data Error) Indicates that position data has an error. 0: No error 1: Error	8-15	Reserved
Axis-2 Status																			
Bit	Description																		
0	SE (Sensor Error) Indicates that a SSE/SPF/DE occurred. 0: No error 1: Error																		
1-4	Reserved																		
5	SSE (Disconnected Sensor Error) Indicates that a sensor is disconnected. 0: Connected 1: Disconnected (Error)																		
6	SPF (Sensor Circuit Power Error) Indicates that the internal power supply of NCW-3DHPN is malfunction. 0: Normal 1: Error																		
7	DE (Sensor Data Error) Indicates that position data has an error. 0: No error 1: Error																		
8-15	Reserved																		
+26	WORD	Axis-2 Control Answerback	<table border="1"> <thead> <tr> <th colspan="2">Axis-2 Control Flag Answerback</th> </tr> <tr> <th>Bit</th> <th>Description</th> </tr> </thead> <tbody> <tr> <td>0-5</td> <td>Reserved</td> </tr> <tr> <td>6</td> <td>ERRCLR (Error Clear) Answerback 0: "ERRCLR" failed. 1: "ERRCLR" succeeded</td> </tr> <tr> <td>7</td> <td>PRESET Answerback 0: "PRESET" failed 1: "PRESET" succeeded.</td> </tr> <tr> <td>8-15</td> <td>Reserved</td> </tr> </tbody> </table>	Axis-2 Control Flag Answerback		Bit	Description	0-5	Reserved	6	ERRCLR (Error Clear) Answerback 0: "ERRCLR" failed. 1: "ERRCLR" succeeded	7	PRESET Answerback 0: "PRESET" failed 1: "PRESET" succeeded.	8-15	Reserved				
Axis-2 Control Flag Answerback																			
Bit	Description																		
0-5	Reserved																		
6	ERRCLR (Error Clear) Answerback 0: "ERRCLR" failed. 1: "ERRCLR" succeeded																		
7	PRESET Answerback 0: "PRESET" failed 1: "PRESET" succeeded.																		
8-15	Reserved																		



**NOTE**

**Precautions to Avoid Positional Deviation Problems**

After clearing the following error, the correct position data cannot be detected.

Be sure to correct the position data using the "current position setting".

- "Sensor data error (DE)"
- "Internal power supply error for sensors (SPF)"
- "Disconnected sensor error (SSE)"
- "Sensor error (SE)"

### (3) Preset procedure

Indicates PRESET procedure of the position data which is using the I/O communication data (Output).

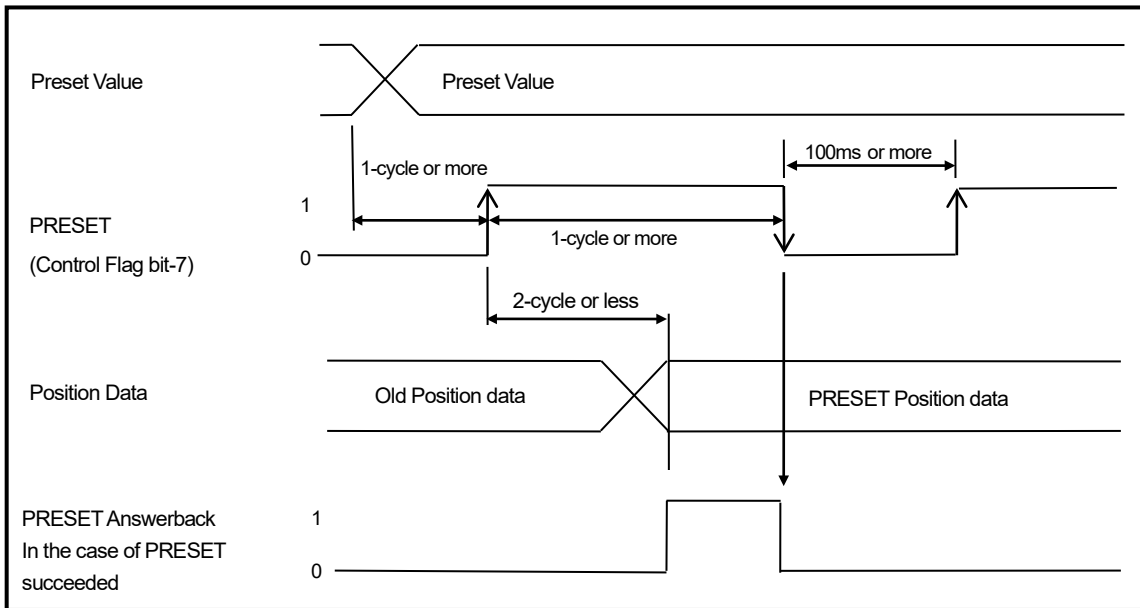

#### ● Preset procedure

- ① Set a desired Preset Value.
- ② Set the value "1" to PRESET (bit 7 of the control flag).  
At this time, the PRESET (bit 7 of the control flag) should be kept setting to "1" in 1-cycle or more.
- ③ "1" is returned to the PRESET Answerback if the PRESET is executed correctly.  
"0" is returned to the PRESET Answerback if an error (NRDY or SE) occurs.
- ④ The PRESET (bit 7 of the control flag) must be reset to "0".  
At this time, the PRESET Answerback is reset to "0".

### (4) Error clear procedure

Indicates the error clear procedure by using the I/O communication data (Output).

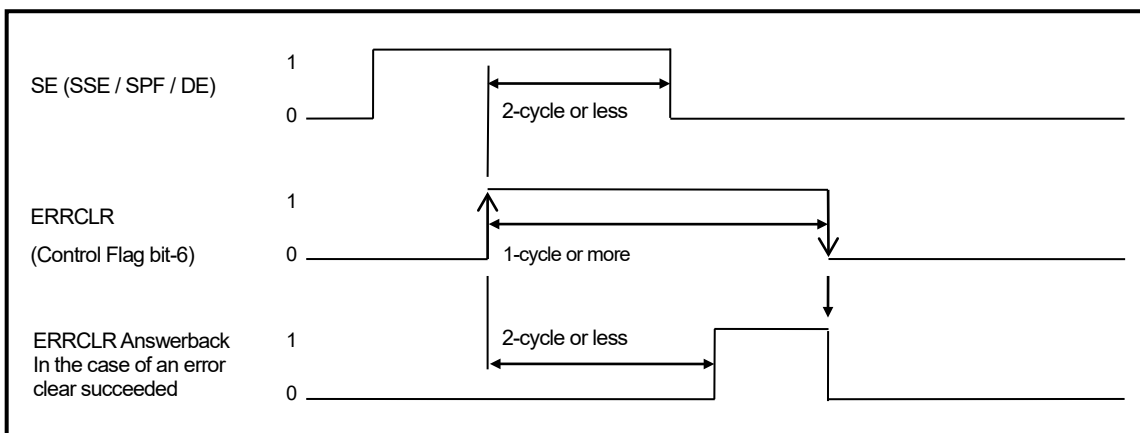

#### ● Error clear procedure

- ① The ERRCLR (control flag bit 6) should be set to "1" after clearing an error cause.  
At this time, the ERRCLR (control flag bit 6) should be kept setting to "1" in 1-cycle or more.
- ② "1" is returned to the ERRCLR Answerback if the error clear is executed correctly.
- ③ The ERRCLR (control flag bit 6) must be reset to "0".  
At this time, the ERRCLR Answerback is reset to "0".

## 9-9. Download the Device Description File

Download the device description file to the PLC.

(1) Select the device, and Right-click. Select "Compile->Hardware and Software (only changes)"

(2) Reselect the device and right-click after the compile is completed. Select "Download to device->Hardware and Software (only changes) ", and download to the PLC.

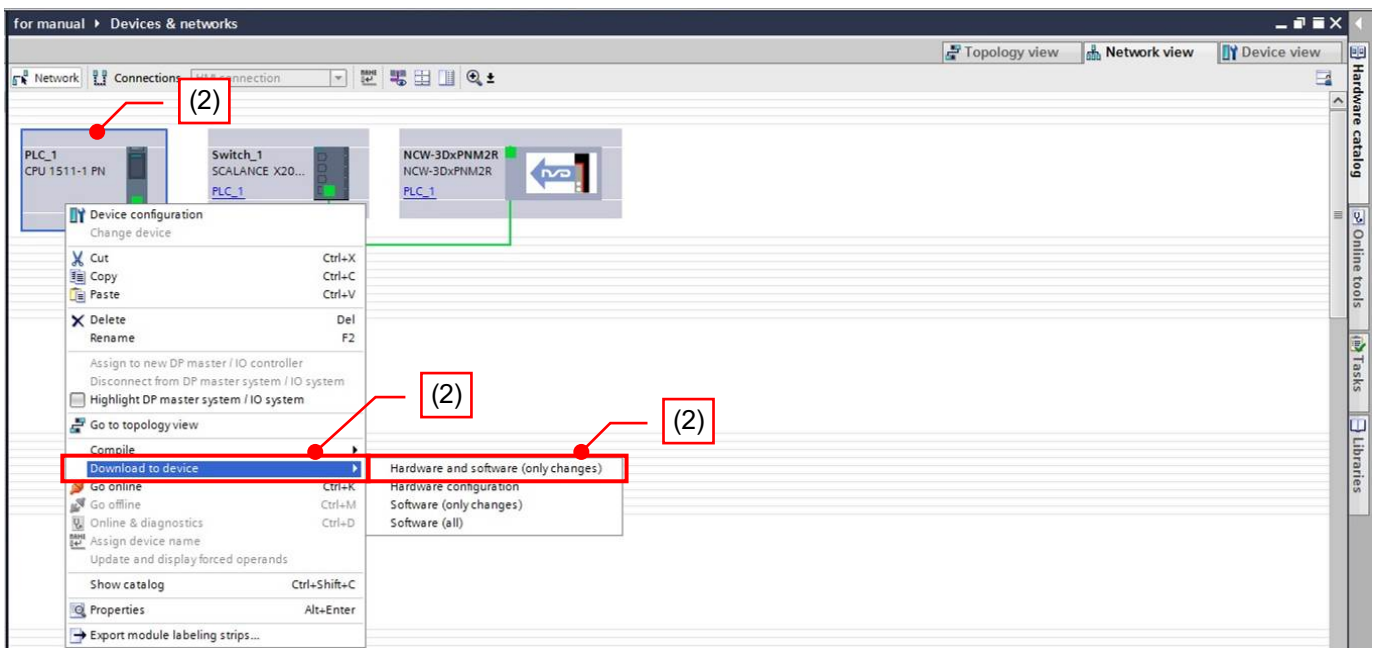
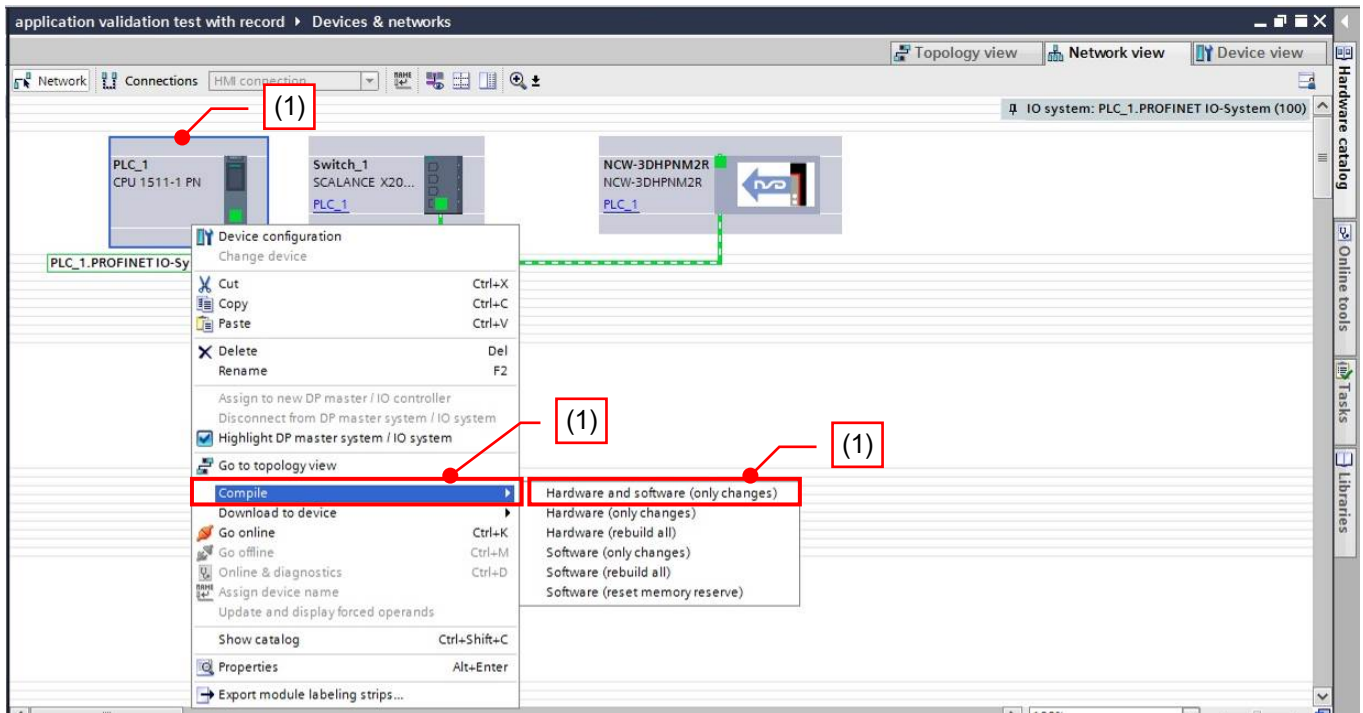

(3) The following window is displayed after the download.

Search the PLC which is downloaded by clicking "Start search" button.

(4) Select target PLC, and click "Load" button. "Download" is executed.

Extended download to device

Configured access nodes of "PLC\_1"

Device	Device type	Slot	Type	Address	Subnet
PLC_1	CPU 1511-1 PN	1 X1	PN/IE	192.168.0.100	PN/IE_1

Type of the PG/PC interface: PN/IE  
PG/PC interface: Intel(R) Ethernet Server Adapter I350-T2 <2>  
Connection to interface/subnet: Direct at slot '1 X1'  
1st gateway:

Select target device: (4) Show all compatible devices

Device	Device type	Interface type	Address	Target device
a	CPU 1511-1 PN	PN/IE	192.168.0.100	a
--	--	PN/IE	Access address	--

Downloadable PLCs are displayed after searching the device.

Flash LED

(3) Start search

Online status information:  Display only error messages

- Found accessible device b [192.168.0.99]
- Scan completed. 1 compatible devices of 3 accessible devices found.
- Retrieving device information...
- Scan and information retrieval completed.

(4) Load Cancel

## 9-10. Confirm Position Data of NCW-3DHPN

(1) Click "Go online" when PLC is RUN mode.

(2) "Default tag table" is displayed by selecting "PLC->PLC Tag->Default tag table".

(3) Current I/O data are displayed on "Monitor value" when clicking "Monitor" button.

Name	Data type	Address	Retain	Acces...	Writa...	Visibl...	Monitor value	Supervision	Comment
1 Axis-1 Control	Word	%QW0	<input type="checkbox"/>	<input checked="" type="checkbox"/>	<input checked="" type="checkbox"/>	<input checked="" type="checkbox"/>	16#0000		
2 Axis-1 Preset Value	UDInt	%QD4	<input type="checkbox"/>	<input checked="" type="checkbox"/>	<input checked="" type="checkbox"/>	<input checked="" type="checkbox"/>	0		
3 Axis-2 Control	Word	%QW8	<input type="checkbox"/>	<input checked="" type="checkbox"/>	<input checked="" type="checkbox"/>	<input checked="" type="checkbox"/>	16#0000		
4 Axis-2 Preset Value	UDInt	%QD12	<input type="checkbox"/>	<input checked="" type="checkbox"/>	<input checked="" type="checkbox"/>	<input checked="" type="checkbox"/>	0		
5 System Status	DWord	%ID0	<input type="checkbox"/>	<input checked="" type="checkbox"/>	<input checked="" type="checkbox"/>	<input checked="" type="checkbox"/>	16#0000_0000		
6 Axis-1 Position	UDInt	%ID4	<input type="checkbox"/>	<input checked="" type="checkbox"/>	<input checked="" type="checkbox"/>	<input checked="" type="checkbox"/>	7454		
7 Axis-1 Status	Word	%IW12	<input type="checkbox"/>	<input checked="" type="checkbox"/>	<input checked="" type="checkbox"/>	<input checked="" type="checkbox"/>	16#0000		
8 Axis-1 Control Answerback	Word	%IW14	<input type="checkbox"/>	<input checked="" type="checkbox"/>	<input checked="" type="checkbox"/>	<input checked="" type="checkbox"/>	16#0000		
9 Axis-2 Position	UDInt	%ID16	<input type="checkbox"/>	<input checked="" type="checkbox"/>	<input checked="" type="checkbox"/>	<input checked="" type="checkbox"/>	8191		
10 Axis-2 Status	Word	%IW24	<input type="checkbox"/>	<input checked="" type="checkbox"/>	<input checked="" type="checkbox"/>	<input checked="" type="checkbox"/>	16#0000		
11 Axis-2 Control Answerback	Word	%IW26	<input type="checkbox"/>	<input checked="" type="checkbox"/>	<input checked="" type="checkbox"/>	<input checked="" type="checkbox"/>	16#0000		
12 <Add new>			<input type="checkbox"/>	<input checked="" type="checkbox"/>	<input checked="" type="checkbox"/>	<input checked="" type="checkbox"/>			

Current I/O data are displayed.  
The position data can be confirmed by following items;  
For Axis-1: Axis-1 Position  
For Axis-1: Axis-2 Position



## 10. INSPECTION

The inspection should be conducted once every 6 months to a year.

Any inspected items which do not satisfy the criteria shown below should be repaired

Inspection item	Inspection Description	Criteria	Remark
Power supply	Measure the voltage fluctuation at the power supply terminal block of the converter to determine if it is within the prescribed range.	Within 21.6V to 26.4VDC range	Tester
Ambient Conditions	Check the ambient temperature.	ABSOCODER sensor: -10 to +80°C Converter: 0 to +55°C	Thermometer
	There should be no accumulation of dust.	None	Visual Inspection
Mount Conditions	Verify that the sensor is securely mounted.	There should be no looseness.	
	Verify that the sensor rod is securely coupled to the machine shaft.	There should be no looseness.	
	Check for severed cables.	Cable should appear normal.	
	Verify that the sensor cable connector is plugged in all the way.	There should be no looseness.	
	Verify that the LAN cable connector is plugged in all the way.	There should be no looseness.	

# 11. TROUBLE SHOOTING

Explains each error which is detected by NCW-3DHPN.

## 11-1. Check Methods during an Error Is Occurred

Error details can be checked by the indicator light status of NCW-3DHPN.

More over, the error details can be checked by following method with using configuration tool "STEP7 V14 Professional SP1"

- ① Each status in I/O data (Input data format)
- ② Index 0x3001 (Event Log) of the record data
- ③ Online & Diagnosis (Select the red rectangular area.)

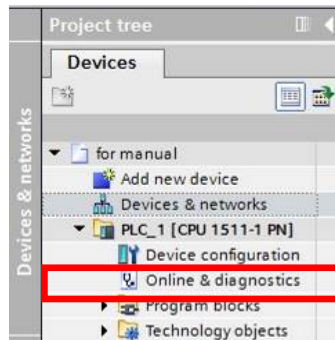

## 11-2. Measures when a Communication Error Occurs

Explains general error causes because of unstable communication and measures.

At first, check the following basic causes;

- The communication cable is connected correctly or not.
- The communication cable is served or not.
- Connectors of the communication cable are connected or not.
- The length of the communication cable connected with NCW-3DHPN is 100m or less.
- The communication cable is category 5e specification.
- The PROFINET controller (master) operates normally.

Check the following secondary causes if the above causes aren't applied.

- The communication cable isn't affected by noises.
- Appropriate distance should be kept between the communication cable and power supply cable.

After checking the above items, retry to communicate with NCW-3DHPN from the PROFINET controller (master). NCW-3DHPN might be failure if only NCW-3DHPN cannot be communicated through the PROFINET network. Check the light status of the NCW-3DHPN indicators (L/A1, L/A2).

## 11-3. NCW-3DHPN Indicator

### 11-3-1. Status indicator (MS/NS)

Error contents can be checked by lighting status of the status indicator (MS/NS) when an error occurs. Check the contents and take appropriate measures.

Light status		Name	Cause and Countermeasure
MS	NS		
Green	Green	Normal operation	Indicates that it is in the normal communication.
Flashing Green/ Red	Flashing Green/ Red	LED test in progress	LED lighting test is executed from the controller. MS/NS indicators blink 3 seconds.
OFF	OFF	No power	The power doesn't supply to NCW-3DHPN. - Check wirings of the power supply terminal block of NCW-3DHPN. - Check that the power voltage is within the range of specification. - Check whether the power supply capacities are enough or not.
Flashing Red	—	Major Recoverable Fault	The sensor error (SE) occurred. For more details, refer to "11-3-3".
Red	—	Major Unrecoverable Fault	NCW-3DHPN has the internal error (RDY LED is OFF). Restart the power supply. Hardware might have a malfunction if the operation is not back to normal. Thus, replace the NCW-3DHPN.
Green	Flashing Green	No connections	Communication is available, but a connection is not established. Check the Ethernet cable is connected with Ethernet portor properly.
Green	Flashing Red	Configuration error	The device's GSDML file might be different in the configuration tool setting. Check whether the GSDML file is selected correctly, and execute the configuration again.
Green	Red	Communication error	An error occurs in communicating I/O controller, and the connection is interrupted. - The communication band width of the whole network system might be lack. Reallocate the communication band width of the whole network system including NCW-3DHPN IO cycle setting by the configuration tool.  - Irregular communication interrupt might have occurred. Investigate a conceivable cause in the system.

### 11-3-2. Link status indicator (L/A1·L/A2)

The Link Status indicator (L/A1, L/A2) indicates communication state.

L/A1: Indicates the Ethernet port 1 state.

L/A2: Indicates the Ethernet port 2 state.

Light status L/A1, L/A2	Name	Cause and Countermeasure
OFF	No link	Indicates Link is not established.
ON	Link	Indicates Link is established.
Flashing	During the communication	Indicates data is sent/received.

### 11-3-3. Converter status indicator

Indicates error causes and countermeasures regarding to the converter.

Light status				Name	Cause and Countermeasure
PON	RDY	ME	SE1 SE2		
ON	ON	OFF	OFF	Normal	—
OFF	OFF	OFF	OFF	Power Supply Error	The power doesn't supply to NCW-3DHPN. - Check wirings of the power supply terminal block of NCW-3DHPN. - Check that the power voltage is within the range of specification. - Check whether the power supply capacities are enough or not.
ON	<b>OFF</b>	OFF	OFF	Watchdog Timer Error or Internal Error	NCW-3DHPN operation is abnormal. Restart the power supply. Hardware might have a malfunction if the operation is not back to normal. Thus, replace NCW-3DHPN.
ON	OFF	<b>ON</b>	—	Memory Error	A memory for parameter of NCW-3DHPN is abnormal. Restart the power supply. Hardware might have a malfunction if memory error occurred repeatedly. Thus, replace NCW-3DHPN.
ON	ON	—	<b>ON</b>	SE1 Axis-1 Sensor Error  SE2 Axis-2 Sensor Error	One of the following errors occurred. - The ABOSOCODER sensor isn't connected. - Sensor connector is disconnected or loose. - A sensor cable is severed. - A parameter (Axis Unavailable) whose axis isn't used is set to "0: valid". - NCW-3DHPN has a malfunction. - ABSOCODER has a malfunction.  Remove the error, and execute the error clear from the PROFINET controller. Hardware might have a malfunction if errors occurred repeatedly. Thus, replace NCW-3DHPN.

## 11-4. Device Reset

The following parameter of NCW-3DHPN can be reset (factory setting) by using a configuration tool if PROFINET communication is available.

A memory error (ME) which is occurred on NCW-3DHPN will be cleared if reset (factory setting) is done.

Parameter	Description
2	- NameOfStation - IP Address - Subnet Mask - Default Gateway - sysContact - sysName - sysLocation

## 12. STORE OF MAINTENANCE INFORMATION

NCW-3DHPN can store maintenance information.

The maintenance information should be store if it is required.

Stored information can be checked when doing periodic maintenance NCW-3DHPN or having an error.

For more details, refer to "APPENDIX 1-2. Info Maintenance" and "APPENDIX 2. I&M DATA".

No.	Name	Data Type	Description
1	Power Distribution Time	Record data	NCW-3DHPN cumulative energization time can be check. Unit: sec
2	Function	I&M1	Stores a function information. Max.character No.: 32
3	Location	I&M1	Stores an installation location information. Max.character No.: 22
4	Installation Date	I&M2	Stores an installation date information. Max.character No.: 16 With installation time: YYYY-MM-DD-HH:MM Without installation time: YYYY-MM-DD
5	Descriptor	I&M3	Stores a comment. Max.character No.: 54

**- MEMO -**

# 13. ABSOCODER SENSOR CHECK LIST

● **Applicable ABSOCODER sensor models**

- VLS-8SM20
- VLS-8SM14
- VLS-8SM14S

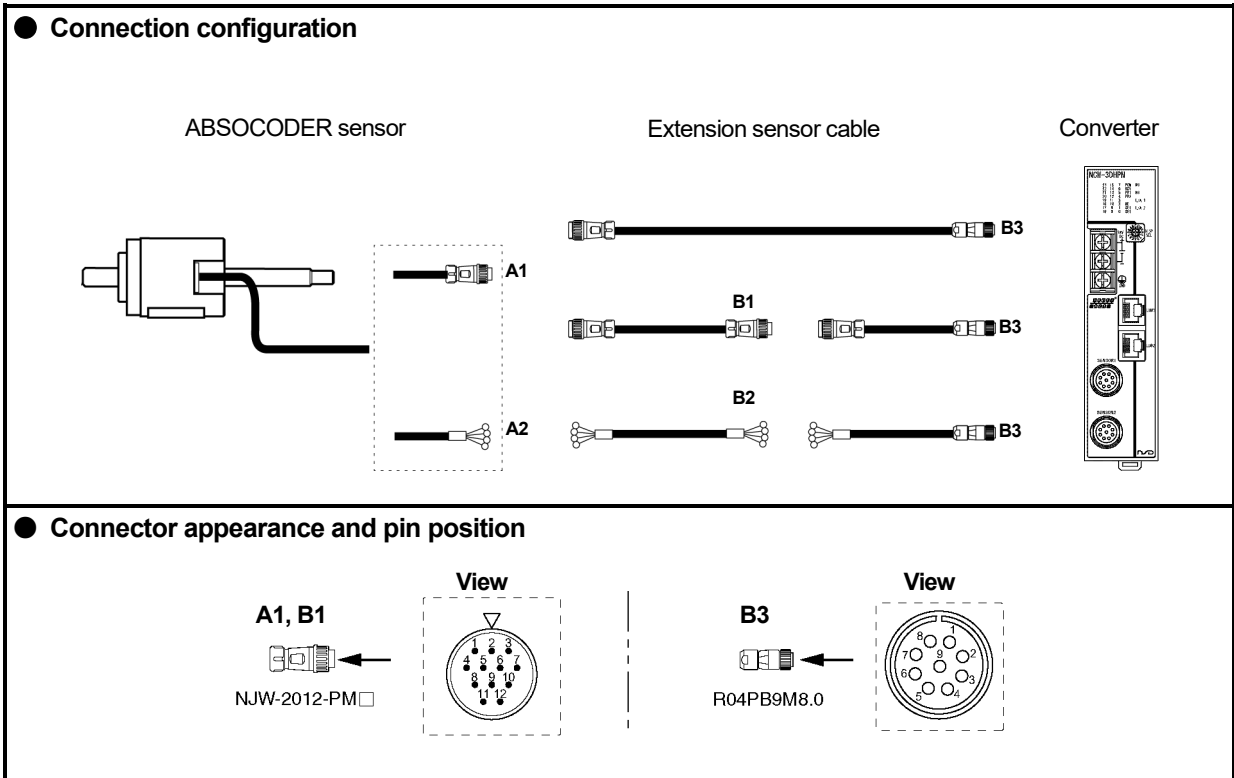

● **Connector pin position and standard coil resistance ranges (at 25°C)**

Check position				Signal names	Standard coil resistance [ $\Omega$ ]	
A1, A2, B1, B2		B3			VLS-8SM20	VLS-8SM14 VLS-8SM14S
Pin No.	Wiring color	Pin No.	Wiring color			
1	Brown	1	Brown	U	114 to 154	132 to 152
2	Red	2	Red	V		
3	Orange	3	Orange	W		
4	—	4	—	—	—	—
5	Green	5	Green	OUT+	162 to 202	150 to 180
6	Blue	6	Blue	OUT-		
7	—	7	—	—		
8	—	8	—	—		
9	—	9	Shield	Shield		
10	—	—	—	—		
11	Shield	—	—	—		
12	—	—	—	—		

The standard coil resistance ranges shown below are referential data to assist wiring disconnection diagnosis and are not product specification values. There may be no wiring disconnection even when the resistance measurement is out of the standard resistance range.



● **Circuit resistance check**

[Measurement method]

Measure resistance at Point A or B using a circuit tester or other appropriate device.  
 Have Point A connected to measure at Point B.  
 If the connector is off, identify the line by the wiring color.

[Check details]

Refer to the previous page for the connector pin number.

Check position	Criterion	Check position	Criterion
Between brown and red	The measured value should be in the range of the standard coil resistance. *1	Between brown and green	∞
Between brown and orange		Between brown and shield	
Between red and orange		Between green and shield	
Between green and blue			
		Between frame and each wire or shield	

\*1: If checks are done at Point B, the measurement value is [Standard coil resistance + extension sensor cable resistance].

Extension sensor cable resistance value

The resistance value of the NSD special cable is 0.2Ω/m (loop resistance).

Consider resistance variations due to temperature, which, relative to the standard temperature (25°C), increases 0.4% when the temperature rises 1°C and decreases 0.4% when the temperature falls 1°C.

● **Insulation check**

[Measurement method]

Measure using a 500 VDC insulation tester.

[Check details]

Refer to the previous page for the connector pin number.

Check position	Criterion
Between brown and green	10MΩ or more
Between brown and shield	
Between green and shield	
Between frame and each wire or shield	

 <b>NOTES</b>
<ol style="list-style-type: none"> <li>1. Make sure to disconnect the ABSOCODER sensor from the converter before carrying out insulation checks.</li> <li>2. If there is a risk that energization may cause damages to the electronic circuits in and around the machine, remove the ABSOCODER sensor from the machine.</li> <li>3. After completing the checks, short-circuit between the pins to discharge remaining voltage before connecting the ABSOCODER sensor to the converter.</li> </ol>

## 14. CE MARKING

This product conforms to the EMC Directive.

### 14-1. EMC Directives

It is necessary to do CE marking in the customer's responsibility in the state of a final product.  
Confirm EMC compliance of the machine and the entire device by customer because EMC changes configuration of the control panel, wiring, and layout.

### 14-2. EMC Directive and Standards

EMC consists of emission and immunity items.  
It conforms to Table (see below) of EMC standards and Testing.

Class	Standard No.	Standard Name
Emission (EMI)	EN61000-6-4	Generic standards. Emission standard for industrial environments
Immunity (EMS)	EN61000-6-2	Generic standards. Immunity standard for industrial environments
	EN61000-4-2	Electrostatic Discharge
	EN61000-4-3	Radiated, Radio frequency, Electromagnetic Field
	EN61000-4-4	Electrical Fast Transient / Burst
	EN61000-4-5	Surge Immunity
	EN61000-4-6	Conducted Disturbances, Induced by Radio-Frequency Fields
	EN61000-4-8	Power Frequency Magnetic Field

### 14-3. Low Voltage Directive

This product doesn't apply to low-voltage directive for the equipment of 24VDC power supply.

## 14-4. Restrictions

### ● Sensor cable

If a 30m or longer sensor cable is to be used, pass the sensor cable through a metal duct or cover the sensor cable with the shielded zippertubing and ground the tube shield.

#### Zippertubing

Model	Manufacturer
MTFS 20 $\phi$	ZIPPERTUBING (JAPAN), LTD.

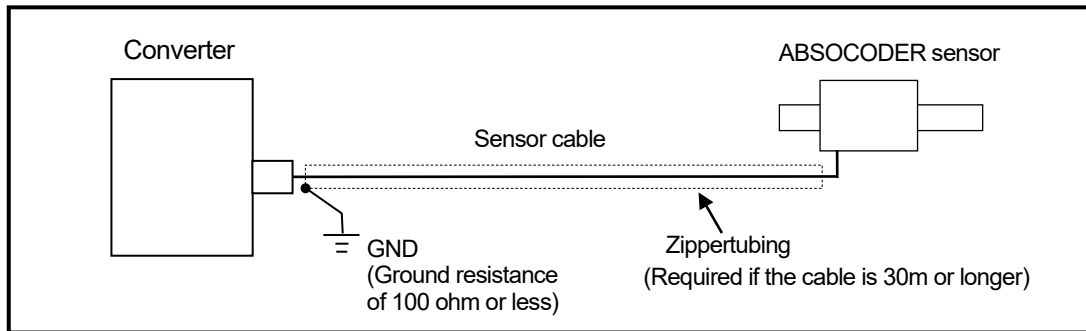

[Reference]

It might be improved when the clamp filter is installed to the power supply or sensor cable when it operates faultily by the influence from the peripheral devices.

#### Clamp Filter

Mounting location	Clamp filter model	Manufacturer
- Power supply cable - Sensor cable	ZCAT2032-0930 (inner dimensions: $\phi 9$ )	TDK

## APPENDIX 1. RECORD DATA

The record data used in NCW-3DHPN is written in the GSDML file.

### APPENDIX 1-1. Sensor Parameter

NCW-3DHPN has following sensor parameters.

Index	Name	Access		Data Type	Description
		Read	Write		
0x1000	Axis-1 Sensor Parameter	○	○	BYTE	Bit0 ... Axis Unavailable Specify "Enable" or "Disable" for the axis. 0: Enable (Default) 1: Disable Bit2 ... Code Sequence (Position Data Increase Direction) Specify the ABSOCODER sensor rotation direction in which the position data increases. 0: CW (Default) 1: CCW
0x1001	Axis-1 Preset	○	○	UDINT	Specify "Preset Value". Axis-1 position data is changed to a value which is specified at this parameter after setting it.
0x2000	Axis-2 Sensor Parameter	○	○	BYTE	Bit0 ... Axis Unavailable Specify "Enable" or "Disable" for the axis. 0: Enable (Default) 1: Disable Bit2 ... Code Sequence (Position Data Increase Direction) Specify the ABSOCODER sensor rotation direction in which the position data increases. 0: CW (Default) 1: CCW
0x2001	Axis-2 Preset	○	○	UDINT	Specify "Preset Value". Axis-2 position data is changed to a value which is specified at this parameter after setting it.

#### ◆ Travel direction of the rod

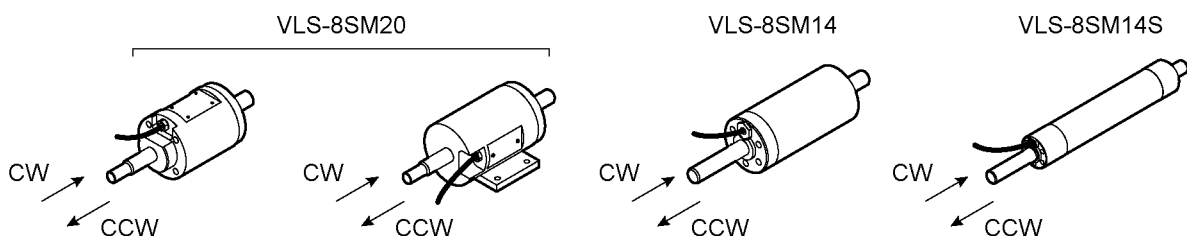

## APPENDIX 1-2. Product Operation & Error History

The cumulative energization time, operation, and error history of NCW-3DHPN can be checked.

Index	Name	Access		Data Type	Description									
		Read	Write											
0x3000	Power Distribution Time	○	-	UDINT	Indicates the cumulative energization time of NCW-3DHPN. (Unit: sec)									
0x3100	Event Log	○	-	256 (8[32])	Indicates the operation and error information histories of NCW-3DHPN. The history is stored in nonvolatile memory. (Max.32 histories)  Arrangement contents <table border="1" data-bbox="852 667 1428 902"> <thead> <tr> <th>Name</th> <th>Data Type</th> <th>Remarks</th> </tr> </thead> <tbody> <tr> <td>Message code</td> <td>DWORD</td> <td>History message code Refer to next page.</td> </tr> <tr> <td>Event occurrence time</td> <td>UDINT</td> <td>Time when an event occurs</td> </tr> </tbody> </table>	Name	Data Type	Remarks	Message code	DWORD	History message code Refer to next page.	Event occurrence time	UDINT	Time when an event occurs
Name	Data Type	Remarks												
Message code	DWORD	History message code Refer to next page.												
Event occurrence time	UDINT	Time when an event occurs												

●History Message Lists

History message code (Hex)	History message	Message details
0x00000001	Power ON	The power was applied.
0x00000002	Power FAIL	Low power supply was detected.
0x00000020	LINK1 Port is LinkUP	LINK1 Port was Linked up.
0x00000021	LINK1 Port is LinkDOWN	LINK1 Port was Linked down
0x00000022	LINK2 Port is LinkUP	LINK2 Port was Linked up.
0x00000023	LINK2 Port is LinkDOWN	LINK2 Port was Linked down
0x00000050	Changes Axis-1 Sensor Parameter	Axis-1 sensor parameter was changed.
0x00000051	Changes Axis-2 Sensor Parameter	Axis-2 sensor parameter was changed.
0x00000060	I/O Transmission Start	I/O transmission was started
0x00000061	I/O Transmission End	I/O transmission was ended
0x00000070 - 0x00000075	—	
0x00000076	Axis-1 ERRCLR	Axis-1 ERRCLR was received.
0x00000077	Axis-1 PRESET	Axis-1 PRESET was received.
0x00000078 - 0x0000007D	—	
0x0000007E	Axis-2 ERRCLR	Axis-2 ERRCLR was received.
0x0000007F	Axis-2 PRESET	Axis-2 PRESET was received.
0x00000080	NRDY	NRDY was detected.
0x00000081	WDTE	WDTE was detected.
0x00000082	ME	ME was detected.
0x00000083 - 0x00000087	—	
0x00000088	I/F ERR	I/F ERR was detected.
0x00000089 - 0x0000008F	—	
0x00000090	I/F ERR - Timeout	I/F ERR (Timeout) was detected.
0x00000091	I/F ERR - Unknown Command	I/F ERR (Unknown Command) was detected.
0x00000092	I/F ERR – CheckSum Error [Sensor to Ethernet]	I/F ERR (CheckSum Error) was detected.
0x00000093	I/F ERR - CheckSum Error [Ethernet to Sensor]	I/F ERR (CheckSum Error) was detected.
0x000000A0	Axis-1 SE	Axis-1 sensor error was detected.
0x000000A1 - 0x000000A4	—	
0x000000A5	Axis-1 SSE	Axis-1 sensor error (Disconnected Sensor Error) was detected.
0x000000A6	Axis-1 SPF	Axis-1 sensor error (Sensor Circuit Power Error) was detected.
0x000000A7	Axis-1 DE	Axis-1 sensor error (Sensor Data Error) was detected.
0x000000A8	Axis-2 SE	Axis-2 sensor error was detected.
0x000000A9 - 0x000000AC	—	
0x000000AD	Axis-2 SSE	Axis-2 sensor error (Disconnected Sensor Error) was detected.
0x000000AE	Axis-2 SPF	Axis-2 sensor error (Sensor Circuit Power Error) was detected.
0x000000AF	Axis-2 DE	Axis-2 sensor error (Sensor Data Error) was detected.

### APPENDIX 1-3. Interface Parameter

Indicates the current communication parameter of NCW-3DHPN.

Index	Name	Access		Data Type	Description
		Read	Write		
0x7000	NameOfStation	○	-	STRING [240]	NameOfStation of device (Max. 240-octet)
0x7001	IP Address	○	-	BYTE [4]	IP Address of device
0x7002	MAC Address	○	-	BYTE [6]	MAC Address
0x7003	Default Gateway	○	-	BYTE [4]	Default Gateway Address
0x7004	Subnet Mask	○	-	BYTE [4]	Subnet Mask

## APPENDIX 2. I&M DATA (Identification & Maintenance Data)

I &M data indicates the product and maintenance information.

These are stored in the nonvolatile memory.

I&M	Access		I&M data	Description
	Read	Write		
0	○	-	VENDER_ID	NSD_Corp "0x0417"
			ORDER_ID	Model code of product "NCW-3DHPNL8"
			SERIAL_NUMBER	Serial number of product
			HARDWARE_REVISION	Hardware version of product
			SOFTWARE_REVISION	Firmware version of product
			REV_COUNTER	0x0000
			PROFILE_ID	"0x0000" (unspecified device)
			PROFILE_SPECIFIC_TYPE	This product is "General". "0x0000"
			IM_VERSION	Version of the I&M data
			IM_SUPPORTED	Support I&M number This product supports I&M0, 1, 2, and 3. "0x000E"
1	○	○	FUNCTION	Stores a function information. Max.character No.: 32
			LOCATION	Stores installation location information. Max.character No.: 22
2	○	○	INSTALLATION_DATE	Stores an installation date information. Max.character No.: 16 With installation time: YYYY-MM-DD-HH:MM Without installation time: YYYY-MM-DD
3	○	○	DESCRIPTOR	Stores a comment. Max.character No.: 54
4				Not supported
5				Not supported



## APPENDIX 3. ALARM DATA

The alarm data used in NCW-3DHPN is written in GSDML file.

The text is displayed on the configuration tool when an alarm occurs.

AlarmType	Text display	Description
Process	Axis-1 SSE	Axis-1 sensor error (Disconnected Sensor Error) was detected.
	Axis-1 DE	Axis-1 sensor error (Sensor Data Error) was detected.
	Axis-2 SSE	Axis-2 sensor error (Disconnected Sensor Error) was detected.
	Axis-2 DE	Axis-2 sensor error (Sensor Data Error) was detected.
Diagnosis	Memory Error	Memory error was detected.
	WatchDog Error	Watch dog timer error was detected.
	Internal Bus Error	Bus error was detected.
	Axis-1 SPF	Axis-1 sensor error (Sensor Circuit Power Error) was detected.
	Axis-2 SPF	Axis-2 sensor error (Sensor Circuit Power Error) was detected.
	GSDML file is different	The configuration was executed by using a GSDML file of different product.



NSD Group

---

**Manufacturer**

**NSD Corporation** 3-31-28, OSU, NAKA-KU, NAGOYA, JAPAN 460-8302

**Distributor**

**NSD Trading Corporation** 3-31-23, OSU, NAKA-KU, NAGOYA, JAPAN 460-8302

Phone: +81-52-261-2352 Facsimile: +81-52-252-0522

URL: [www.nsdcorp.com](http://www.nsdcorp.com) E-mail: [foreign@nsdcorp.com](mailto:foreign@nsdcorp.com)

Copyright©2020 NSD Corporation All rights reserved.