



ZEF005242004



**Pulse Converter  
Line Driver Output**

**NPG-210HABVT**

**Specifications & Instruction Manual**

Applicable sensor: VRE-10TP058

VRE-10TP068

VRE-10TP101



# GENERAL SAFETY RULES



(Please read this safety guide carefully before operation)

Thank you very much for purchasing our product. Before operating this product, be sure to carefully read this manual so that you may fully understand the product, safety instructions and precautions.

- Please submit this manual to the operators actually involved in operation.
- Please keep this manual in a handy place.



## Signal Words

Safety precautions in this guide are classified into DANGER and CAUTION.

Symbol	Meaning
 DANGER	Incorrect handling may cause a hazardous situation that will result in death or serious injury.
 CAUTION	Incorrect handling may cause a hazardous situation that will result in moderate injury or physical damage.

Instructions accompanied by a symbol  may also result in serious damage or injury. Be sure to follow the all instructions accompanied by the symbol.

## Graphic Symbols







Symbol	Meaning
	Indicates prohibited items.
	Indicates items that must be performed to.



## Application Limitation

This product is not designed to be used under any situation affecting human life. When you are considering to use this product for special purposes such as medical equipment, aerospace equipment, nuclear power control systems, traffic systems, and etc., please consult with NSD.



This product is designed to be used under the industrial environments categorized in Class A device. The supplier and user may be required to take appropriate measures.

## 1. Handling Precautions



 DANGER	
	- Do not touch components inside of the controller; otherwise, it may cause electric shock.
	- Do not damage the cable by applying excessive load, placing heavy objects on it, or clamping; otherwise, it may cause electric shock or fire.
	- Turn the power supply OFF before wiring, transporting, and inspecting the controller; otherwise, it may cause electric shock.
	- Provide an external safety circuit so that the entire system functions safely even when the controller is faulty.
	- Connect the grounding terminal of the controller; otherwise, it may cause electric shock or malfunction.

 CAUTION	
	- Do not use the controller in the following places; water splashes, the atmosphere of the corrosion, the atmosphere of the flammable vapor, and the side of the combustibility. Doing so may result in fire or the controller may become faulty.
	- Be sure to use the controller and the ABSOCODER sensor in the environment designated by the general specifications in the manual. Failure to do so may result in electric shock, fire, malfunction or unit failure. - Be sure to use the specified combination of the ABSOCODER sensor, controller and sensor cable; otherwise, it may cause fire or controller malfunction.



## 2. Storage

 CAUTION	
	- Do not store the controller in a place exposed to water, or toxic gas and liquid.
	- Be sure to store the controller in designed temperature and humidity range, and do not expose to direct sunlight. - Be sure to consult with NSD when the controller is stored for long periods.



## 3. Transport



 CAUTION	
	- Do not hold the cable or shaft of ABSOCODER sensor during transport; otherwise, it may cause injury or malfunction.

## 4. Installation



 CAUTION	
	- Do not step on the ABSOCODER sensor or place heavy objects on the controller; otherwise, it may cause injury. - Do not block the exhaust port or allow any foreign matter to enter the controller; otherwise, it may cause fire or controller failure.
	- Be sure to secure the controller and ABSOCODER sensor with the provided brackets; otherwise, it may cause malfunction, injury, or drop. - Be sure to secure the specified distance between the controller and the control panel or other equipments; otherwise, it may cause malfunction.

## 5. Wiring



 DANGER	
	- Be sure to secure the terminal block firmly; otherwise, it may have risk of fire. - Be sure to mount the terminal cover provided with the controller, before supplying the power, starting operation after the installation, and wiring; otherwise, it may cause electric shock.

 CAUTION	
	- Be sure to keep the sensor cable, control cable, and communication cable at least 300 mm away from the main circuit and power line; otherwise it may cause injury or malfunction. - Be sure to connect all cables correctly; otherwise, it may cause injury or malfunction. - Be sure to firmly connect the external I/O connectors and sensor connectors; otherwise, it may cause incorrect inputs and outputs or injury.



## 6. Operation

 CAUTION	
	- Do not change the controller's function switch settings during the operation; otherwise, it may cause injury. - Do not approach the machine after instantaneous power failure has been recovered. Doing so may result in injury if the machine starts abruptly, it may cause injury.
	- Be sure to check that the power supply specifications are correct; otherwise, it may caused controller failure. - Be sure to provide an external emergency stop circuit so that operation can be stopped with power supply terminated immediately. - Be sure to conduct independent trial runs for the controller before mounting the controller to the machine; otherwise, it may cause injury. - When an error occur, be sure to eliminate the cause, ensure safety, and reset the error before restarting operation; otherwise, it may cause injury.

## 7. Maintenance And Inspection

 CAUTION	
	- Do not disassemble, remodel, or repair the product; otherwise, it may cause electric shock, fire, and product malfunction.
	- The capacitor of the power line deteriorates through prolonged use. We recommended that the capacitor be replaced every five years to prevent secondary damage.

## 8. Disposal

 CAUTION	
	- Be sure to handle the controller as industrial waste while disposing of it.

## REVISION HISTORY

The Document No. appears at the upper right of this manual's cover page.

Document No.	Date	Revision Description
ZEF005242000	30, Jun., 2014	1st Edition Japanese document: ZEF005241900
ZEF005242001	17, Jan., 2017	2nd Edition Japanese document: ZEF005241901
ZEF005242002	25, Dec., 2020	3rd Edition Japanese document: ZEF005241902
ZEF005242003	26, May, 2022	4th Edition Japanese document: ZEF005241903
ZEF005242004	2, Apr., 2024	5th Edition Japanese document: ZEF005241904

**-MEMO-**

# CONTENTS

<b>1. OVERVIEW</b> .....	<b>1</b>
1-1. Features.....	1
<b>2. MODEL SELECTION WHEN ORDERING</b> .....	<b>2</b>
2-1. Connection Configuration .....	2
2-2. Model List.....	3
<b>3. SPECIFICATIONS</b> .....	<b>4</b>
3-1. Converter Specifications .....	4
3-1-1. General specification.....	4
3-1-2. Performance specification.....	4
3-1-3. Input / output specification .....	5
3-1-4. Input / output connector specification .....	6
3-1-5. Signal timing patterns.....	7
3-2. ABSOCODER Sensor Specifications.....	9
3-3. Extension Sensor Cable Specification .....	11
<b>4. DIMENSIONS</b> .....	<b>12</b>
4-1. Converter Dimension .....	12
4-2. ABSOCODER Sensor Dimensions.....	13
4-3. Extension Sensor Cable Dimensions .....	15
4-4. I/O Cable .....	17
<b>5. CHECKING THE CONTENTS OF THE SHIPPING CASE</b> .....	<b>18</b>
<b>6. INSTALLATION</b> .....	<b>19</b>
6-1. Converter Installation Conditions and Precautions.....	19
6-2. ABSOCODER Sensor Installation Conditions and Precautions .....	20
<b>7. WIRING</b> .....	<b>23</b>
7-1. Power Supply Connection.....	23
7-2. Connection between Converter and ABSOCODER Sensor .....	24
7-2-1. Connection configure example of the sensor cable .....	25
7-3. Input / Output Connector Connection .....	28
<b>8. NOMENCLATURE</b> .....	<b>29</b>
8-1. Part Identification .....	29
8-2. Monitor LED .....	30
<b>9. OPERATION</b> .....	<b>31</b>
9-1. Operation Sequence .....	31
9-2. Function Selector Switch .....	32
9-3. Setting of Pulse Number .....	34
9-4. Error Clear Button .....	35
<b>10. INSPECTION</b> .....	<b>36</b>
<b>11. TROUBLESHOOTING</b> .....	<b>37</b>
11-1. Display and Countermeasure when an Error Occurred .....	37
11-2. Output State when Occurring an Error .....	38
11-3. Procedure Contents after Replacing .....	38
11-4. ABSOCODER Sensor Check List .....	40

# 1. OVERVIEW

NPG-210HABVT converter is used in conjunction with an ABSOCODER sensor as a pulse output system which serves an alternative to PLG systems.

## 1-1. Features

Converter has the following features.

### (1) Superior durability

ABSOCODER sensor is not used electronic parts except coils and resistors, and it features a no-contact construction excepting bearing. This sensor offers problem-free operation, even in environments where it is exposed to vibration, impact shocks, extreme temperatures, oil, and dust.

### (2) Applicable with JKPEV-S cable

A commercially available cable (JKPEV-S 1.25mm<sup>2</sup> x 5P) can be used between the converter and ABSOCODER sensor.

### (3) Compact design

The unit's outside dimensions (39(W) x 155(H) x 93(D)) were miniaturized. DIN rail can be used, so mounting is much easier.

### (4) Two ABSOCODER sensors can be connected

Two ABSOCODER sensors can be connected to one converter. The space-saving in the control panel can be conducted.

### (5) Number of pulse can be selected to the desired

The pulse number per turn of ABSOCODER sensor can be selected to the desired number by changing the pulse number setting switches. Also, the pulse number setting can be select by each channel.

### (6) Pulse output increase/decrease direction setting function

The pulse output increase/decrease direction (A phase leads B phase or B phase leads A phase) which is corresponding to the rotation direction of the ABSOCODER sensor can be selected by changing the function selector switch.

### (7) Error detection function

Detecting the sensor disconnected error (SE) and low power supply error (PF), the state can be displayed at the monitor LED. PLC etc. can detect the converter error because the converter has the system ready output (NOR) function.

## 2. MODEL SELECTION WHEN ORDERING

### 2-1. Connection Configuration

The following figure indicates the connection configuration of NPG-210HABVT.  
Please prepare by customer except 1 to 4 in the connection configuration.

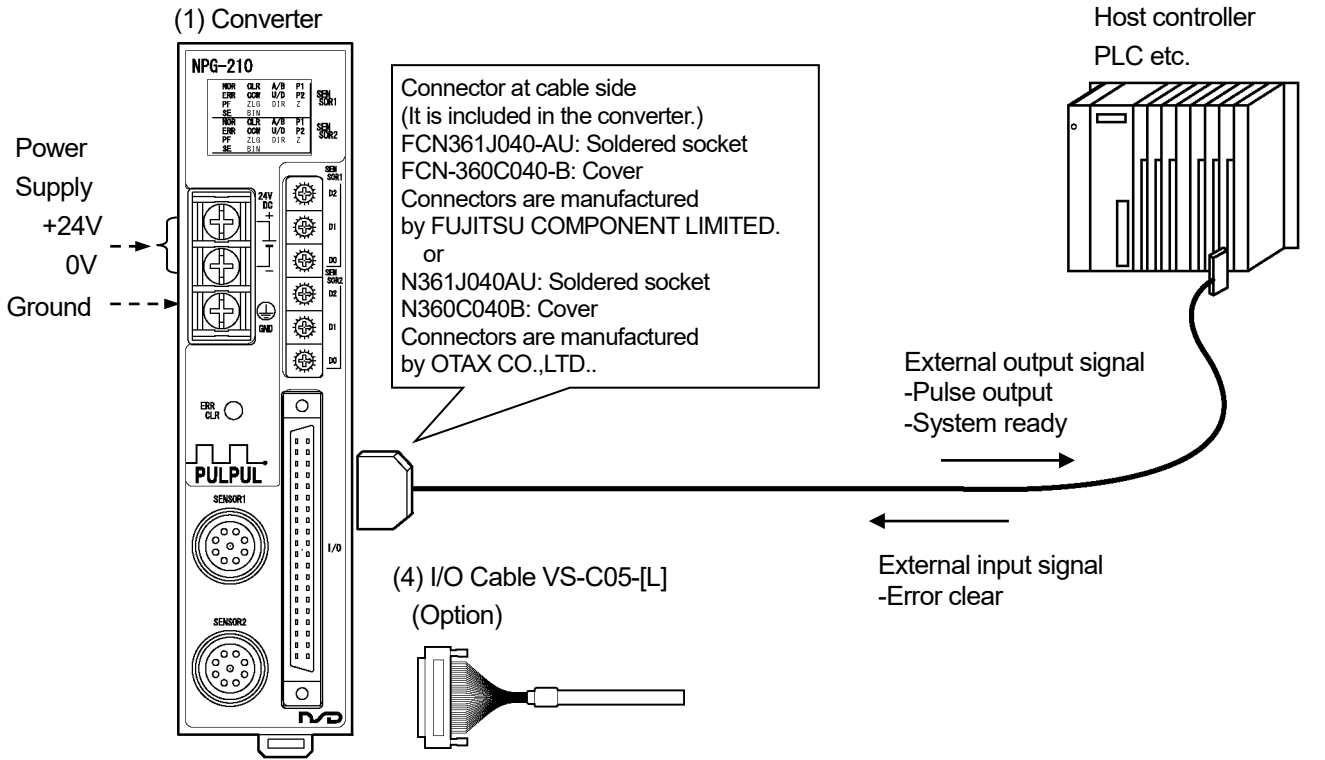

(3) Extension sensor cable		(2) ABSOCODER sensor	
<p>-In the case of using the NSD special cable</p> <p>4P-S/RBT/URT-0144-[L]</p> <p>4P-S/RBT/URT-0144-[L]      4P-S/RBT/URT/HRT-4344-[L]</p> <p>4P-S/RBT/URT-0190-[L]      4P-S/RBT/URT/HRT-9090-[L]</p>		<p>Connector type</p> <p>B</p> <p>R</p>	<p>VRE-10TP058 VRE-10TP068 VRE-10TP101</p>
<p>-In the case of using the commercially available cable</p> <p>4P-S/RBT/URT-0155-[L]</p> <p>JKPEV-S(1.25mm<sup>2</sup> X5P)</p> <p>NWPC-4012-Ad14      NWPC-4012-P14</p> <p>4P-S/RBT/URT-0190-[L]</p> <p>JKPEV-S(1.25mm<sup>2</sup> X5P)</p>		<p>P</p> <p>R</p>	





## 2-2. Model List

### ◆ Converter

No.	Model	Description
(1)	NCV-210HABVT	For two ABSOCODER sensors

### ◆ ABSOCODER sensor

No.	Model	Description
(2)	VRE-10TP058MSB	General environment type, with interconnecting cable 2m
	VRE-10TP068[1] K [2][L]	Compact size heavy duty type, SUS
	VRE-10TP101[1] K [2][L]-G	Heavy duty type, SUS
	<p>[1]: Mounting format            F: Flange-mount type    L: Base-mount type    M: Face-mount type            (Only available for 058 and 068.)</p>  <p>K: Input shaft (sunk key)    S: Without key</p>  <p>[2]: Connector type            B: Standard connector for the NSD special cable            (NJW-2012PM8, manufacturer: Nanaboshi Electric Mfg.Co.,Ltd.)            P: Large connector for JKPEV-S cable            (NWPC-4012-Ad12, manufacturer: Nanaboshi Electric Mfg.Co.,Ltd.)            R: Crimping terminals for JKPEV-S cable and the NSD special cable (R1.25-4)</p> <p>[L]: Interconnecting sensor cable length (m): 2, 5, 10, 20</p> <p>G: Silicon oil injected    no code: no oil injected</p>	

### Extension sensor cable

No.	Model	Description
(3)	4P-[1]-[2] [3]-[L]	<p>[1]...Cable type            S: Standard cable            RBT: Robotic cable            URT: Semi-heat-resistant robotic cable            HRT: Heat-resistant robotic cable</p> <p>[2]...Connector (Converter side)            01: Connector for connecting to a converter (R04-PB9M8.0A)            43: Standard connector (NJW-2012-PM8)            90: Crimping terminals (R-1.25-4)</p> <p>[3]...Connector (Sensor side)            44: Standard connector (NJW-2012-AdF8)            55: Large connector (NWPC-4012-P12)            90: Crimping terminals (R-1.25-4)</p> <p>[L]...Cable length (m)            Contact your NSD representative for the cable length.</p>
	JKPEV-S(1.25mm <sup>2</sup> ×5P)	Commercially available cable

### ◆ Option

No.	Name	Model	Description
(4)	I/O cable	VS-C05-[L]	Used for the I/O connector. [L]: Cable length: 1, 2, 3, 5, 7, 10m

### 3. SPECIFICATIONS

#### 3-1. Converter Specifications

##### 3-1-1. General specification

Items	Specifications
Power supply voltage	24VDC±10% (including ripple)
Power consumption	10W or less
Insulation resistance	20 M-Ohms or more between external DC power terminals and ground (by 500 VDC insulation resistance tester)
Withstand voltage	500 VAC, 60Hz for 1 minute between external DC power terminals and ground
Vibration resistance	20m/s <sup>2</sup> 10 to 500Hz, 10cycles of 5 minutes in 3 directions, conforms to JIS C 0040 standard
Ambient operating temperature	0 to +55°C (No freezing)
Ambient operating humidity	20 to 90 %RH (No condensation)
Ambient operating environment	Free from corrosive gases and excessive dust
Ambient storage temperature	-10 to +70°C
Grounding	Must be securely grounded (ground resistance of 100 ohm or less)
Construction	Book-shelf type within enclosure, DIN rail mountable
Outside dimension (mm)	39(W) x 155(H) x 93(D) Refer to dimensions for details.
Mass	Approx. 0.4kg

##### 3-1-2. Performance specification

Items	Specifications
Number of detection axes	2
Number of pulse output channels	1 channel for each axis
Pulse format	A/B phase pulse format
Number of pulse	Designates the output pulse number setting per turn of ABSOCODER sensor. The setting value can be selected from 10 to 10240 by the 10 pulse units. (Selectable for each axis)
Resolution	Max. 10240-pulse per revolution
Maximum rotation speed	4000 r/min (Can be used up to the permissible mechanical speed of ABSOCODER sensor.)
Maximum frequency response of pulse output	300kHz
Pulse output increase/decrease direction	Select the increase/decrease direction of the output pulse which corresponds to the shaft rotation direction of the ABSOCODER sensor. (Selectable for each axis)
Error detection	Sensor disconnected error, low power supply error
Monitor LED	System ready, various error detection state, function selector switch state, pulse output state, input signal state
Front panel operation	Error clear
Input signal	Error clear
Output signal	System ready, pulse output

### 3-1-3. Input / output specification

Items		Specifications
Input	Input signals	1ERR CLR (Axis-1 error clear) 2ERR CLR (Axis-2 error clear)
	Input circuit	DC input, photo-coupler isolation
	Rated input voltage	12VDC/24VDC (10VDC to 30VDC)
	Rated input current	10mA (24VDC)
	ON voltage	10VDC or more
	OFF voltage	4VDC or less
Output	Output signals	1POUT1, 1POUT2 (Axis-1 pulse output) 2POUT1, 2POUT2 (Axis-2 pulse output)  1NOR (Axis-1 system ready) 2NOR (Axis-2 system ready)
	Output circuit	Photo-coupler isolation, line driver (equivalent to AM26C31: T.I.) output

I/O circuit

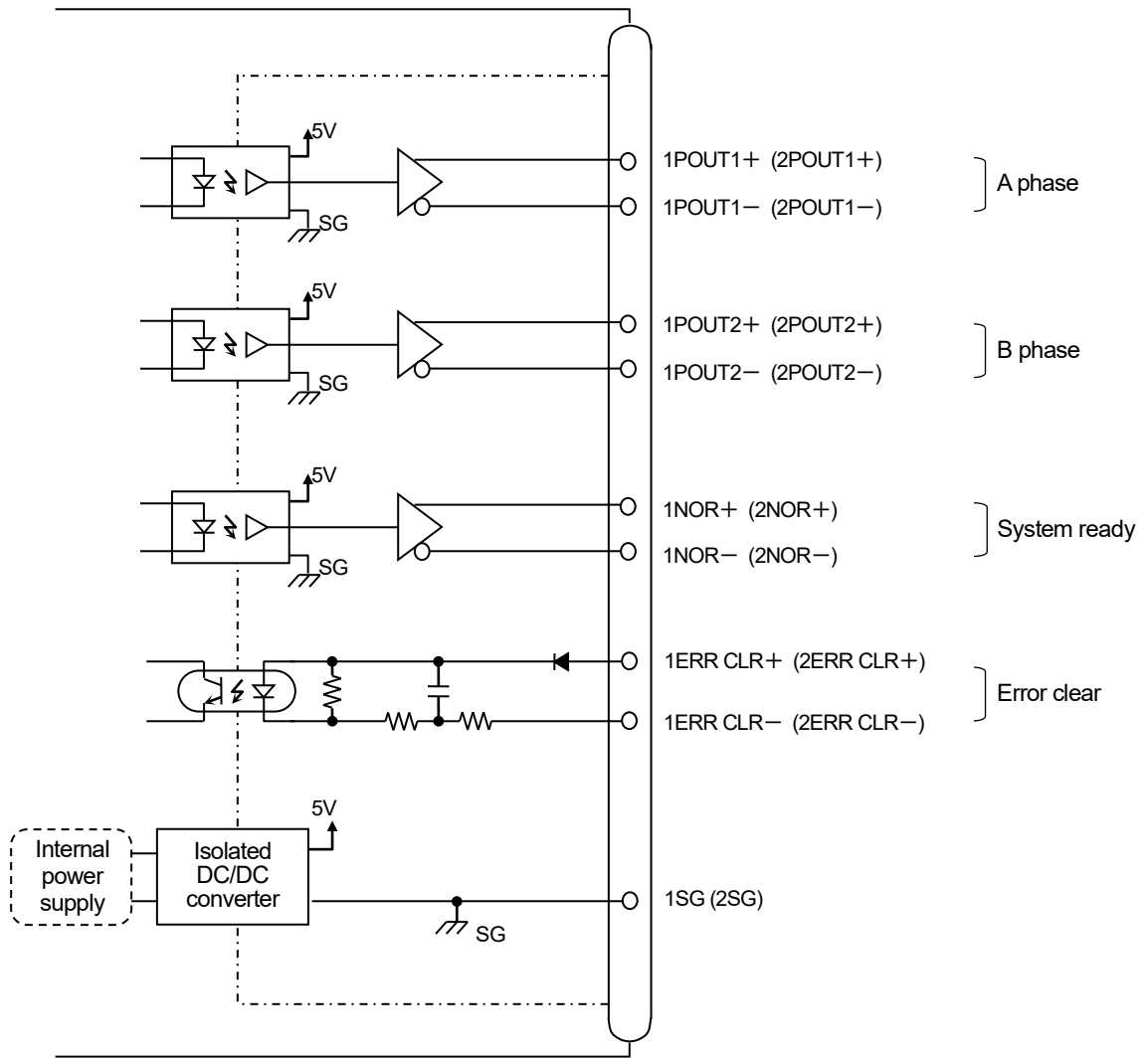

- \*1: Axis-1 and Axis-2 are the same circuit configuration.
- \*2: The power supply of the Axis-1 is isolated from Axis-2

### 3-1-4. Input / output connector specification

#### (1) Pin arrangement of the I/O Connector

Pin arrangement of input/output connectors is described in this section.

Connector model: FCN-361J040-AU / FCN-360C040-B (FUJITSU COMPONENT LIMITED)  
or N361J040AU / N360C040B (OTAX CO.,LTD.)

Compatible wire size: 0.3mm<sup>2</sup>

Pin No.	Signal name	Pin No.	Signal name	Pin arrangement
A1	1SG	B1	1ERR CLR+	<p>Shows the pin arrangement as viewed from the soldering terminals side.</p>
A2	1SG	B2	1ERR CLR+	
A3	NC	B3	1ERR CLR-	
A4	NC	B4	NC	
A5	1POUT1+	B5	1POUT1-	
A6	1POUT2+	B6	1POUT2-	
A7	1NOR+	B7	1NOR-	
A8	NC	B8	NC	
A9	NC	B9	NC	
A10	NC	B10	NC	
A11	NC	B11	NC	
A12	NC	B12	NC	
A13	NC	B13	NC	
A14	2NOR-	B14	2NOR+	
A15	2POUT2-	B15	2POUT2+	
A16	2POUT1-	B16	2POUT1+	
A17	NC	B17	NC	
A18	2ERR CLR-	B18	NC	
A19	2ERR CLR+	B19	2SG	
A20	2ERR CLR+	B20	2SG	

**[Note]** Do not connect any cord to NC pins.

#### (2) Signal names and descriptions

Signal name		Description	
Line driver output	1POUT1 1POUT2	Axis-1 pulse output	POUT1: Outputs A phase pulse. POUT2: Outputs B phase pulse.
	2POUT1 2POUT2	Axis-2 pulse output	
	1NOR	Axis-1 system ready	Signal level when the pulse output is normal +pin: Low -pin: High
	2NOR	Axis-2 system ready	Can be used as an interlock signal. (1NOR and 2NOR outputs the same state.)
	1SG	Axis-1 signal ground	This is the signal ground (0V) for the axis-1 pulse output.
	2SG	Axis-2 signal ground	This is the signal ground (0V) for the axis-2 pulse output.
Input	1ERR CLR	Axis-1 error clear	The axis-1 error is cleared when turning ON this signal.
	2ERR CLR	Axis-2 error clear	The axis-2 error is cleared when turning ON this signal.

### 3-1-5. Signal timing patterns

Signal timing is described in this section.

#### (1) Signal output timing at power ON/OFF

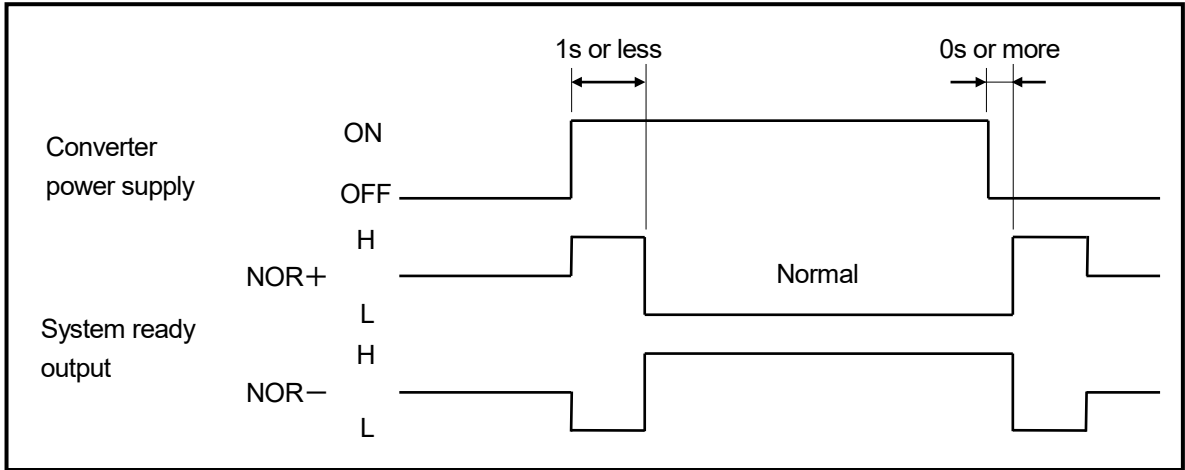

#### (2) Timing of error clear

The error clear signal must be ON 500μs or more.

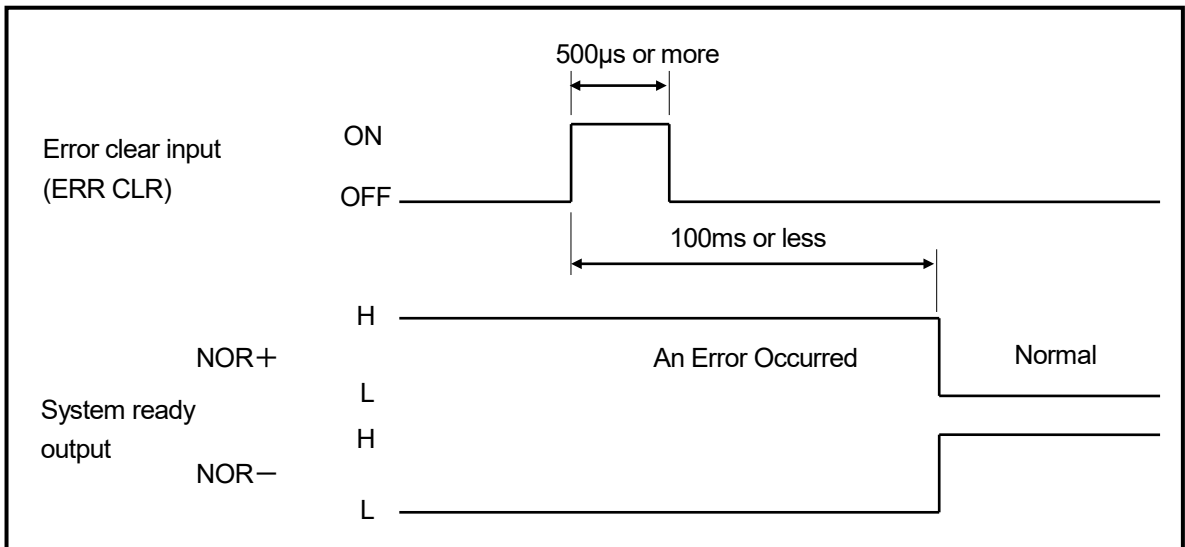

### (3) Pulse output

The equalized pulse which corresponds to the rotation speed of the ABSOCODER sensor is output. The timing of the pulse output is different by the setting of the function selector switch "pulse output increase/decrease direction".

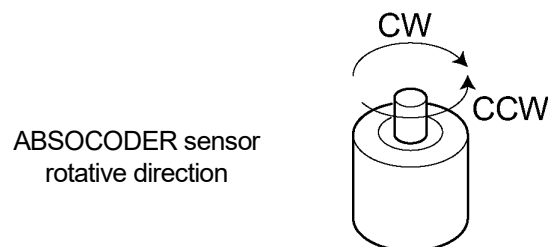
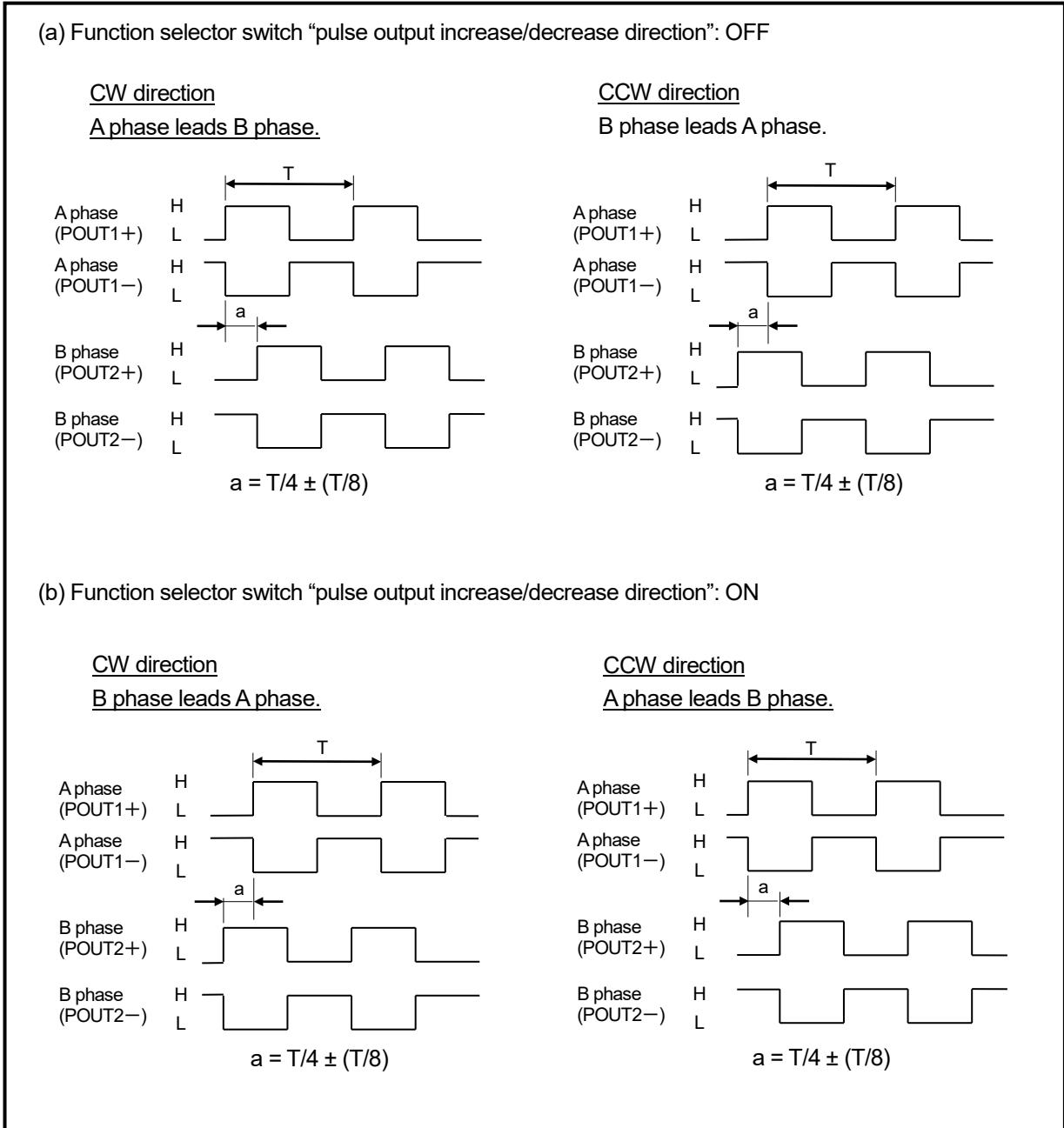

### 3-2. ABSOCODER Sensor Specifications

#### (1) VRE-10TP058

Items		Specifications
Sensor model		VRE-10TP058
Total number of turns		1
Mass		Approx. 1kg
Linearity error		0.12° Max.
Moment of inertia $GD^2/4(J)$		$3.5 \times 10^{-6} \text{kg} \cdot \text{m}^2$ ( $3.6 \times 10^{-5} \text{kgf} \cdot \text{cm} \cdot \text{s}^2$ )
Starting torque		$4.9 \times 10^{-2} \text{N} \cdot \text{m}$ or less ( 0.5 kgf·cm or less )
Permissible shaft load	Radial	49N (5kgf)
	Thrust	24.5N (2.5kgf)
Permissible mechanical speed		4000r/min
Bearing life		$8 \times 10^4 \text{h}$ (at 4000r/min)
Ambient temperature	Operating	-20 to +105°C
	Storage	-30 to +105°C
Vibration resistance		$2.0 \times 10^2 \text{ m/s}^2$ (20G) 200Hz, up/down 4 h, forward/back 2 h, conforms to JIS D 1601 standard
Shock resistance		$4.9 \times 10^3 \text{ m/s}^2$ (500G) 0.5 ms, up/down/forward/back x 3 times each, conforms to JIS C 5026 standard
Protection rating		IP67, conforms to JEM 1030 standard IP69K, conforms to ISO 20653 standard
Max. sensor cable length	4P-S	300m
	4P-RBT/URT/HRT	250m
	JKPEV-S ( $1.25 \text{mm}^2 \times 5\text{P}$ )	300m
Surface treatment		Electroless nickel plate
Material		Steel

**(2) VRE-10TP068 / VRE-10TP101**

Items		Specifications	
Sensor model		VRE-10TP068	VRE-10TP101
Total number of turns		1	
Mass		F: Flange-mount type: approx. $2 + 0.1 \times$ cable length (m) kg L: Base-mount type: approx. $2.5 + 0.1 \times$ cable length (m) kg M: Face-mount type: approx. $1.9 + 0.1 \times$ cable length (m) kg	Approx. $7.5 + 0.1 \times$ cable length (m) kg
Linearity error		0.12° Max.	
Moment of inertia $GD^2/4(J)$		$3.3 \times 10^{-5} \text{kg} \cdot \text{m}^2$ ( $3.4 \times 10^{-4} \text{kgf} \cdot \text{cm} \cdot \text{s}^2$ )	
Starting torque		$9.8 \times 10^{-2} \text{N} \cdot \text{m}$ or less ( 1 kgf·cm or less )	
Permissible shaft load	Radial	98N (10kgf)	150N (15kgf)
	Thrust	49N (5kgf)	78N (8kgf)
Permissible mechanical speed		4000r/min	
Bearing life		$8 \times 10^4 \text{h}$ (at 4000r/min)	
Ambient temperature	Operating	-20 to +120°C	
	Storage	-30 to +120°C	
Vibration resistance		$2.0 \times 10^2 \text{ m/s}^2$ (20G) 200Hz, up/down 4 h, forward/back 2 h, conforms to JIS D 1601 standard	
Shock resistance		$4.9 \times 10^3 \text{ m/s}^2$ (500G) 0.5 ms, up/down/forward/back x 3 times each, conforms to JIS C 5026 standard	
Protection rating		IP67, conforms to JEM 1030 standard IP69K, conforms to ISO 20653 standard	
Max. sensor cable length	4P-S	300m	
	4P-RBT/URT/HRT	250m	
	JKPEV-S (1.25mm <sup>2</sup> × 5P)	300m	
Surface treatment		Not treated	
Material		Stainless	



### 3-3. Extension Sensor Cable Specification

Items	Specifications			
Model code	4P-S	4P-RBT	4P-URT	4P-HRT
Cable type	Standard cable	Robotic cable	Semi-heat-resistant robotic cable	Heat-resistant robotic cable
Diameter	$\phi 8$			
Operating temperature range	-5 to +60°C		-5 to +105°C	0 to +150°C
Insulator	Irradiated cross linked foamed polyethylene	ETFE plastic		
Sheath	Polyvinyl chloride mixture		Heat-resistant polyvinyl chloride mixture	Fluoro-rubber
Construction	8-core, 2 pairs without shield + 2 pairs with shield			
Color of sheath	Gray	Black		
Advantage	Extensible for long distances	Superior flexibility; ideal for moving place		Heat treatment and flexible; ideal for moving place

## 4. DIMENSIONS

### 4-1. Converter Dimension

Units: mm

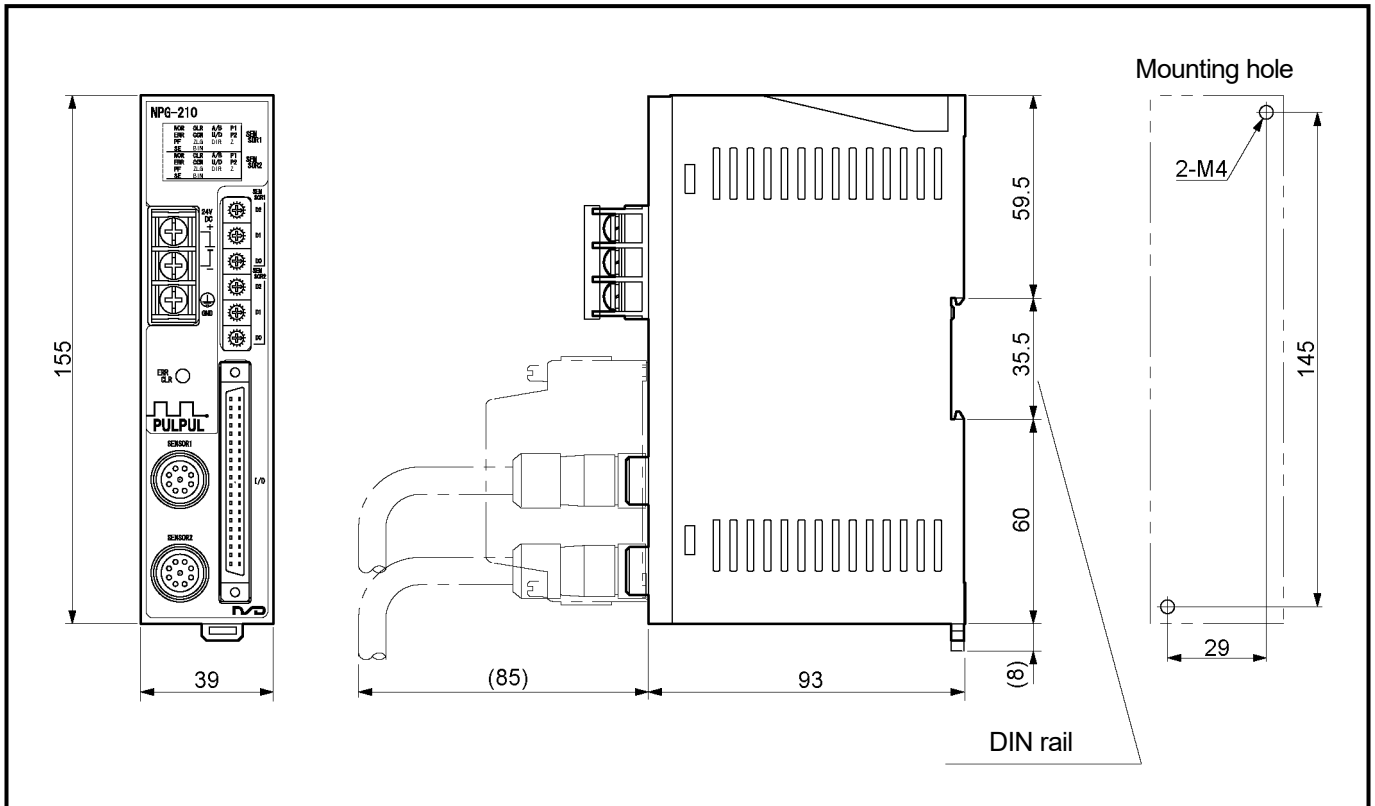

## 4-2. ABSOCODER Sensor Dimensions

### (1) VRE-10TP058MSB (Face-mount type)

Units: mm

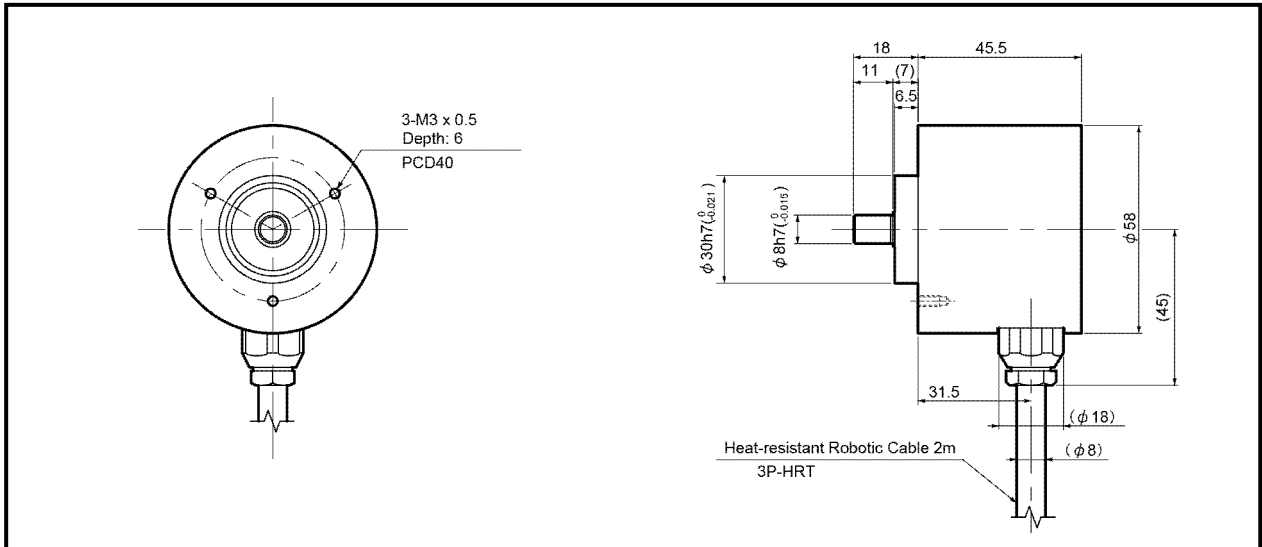

### (2) VRE-10TP068FK[ ][L] (Flange-mount type)

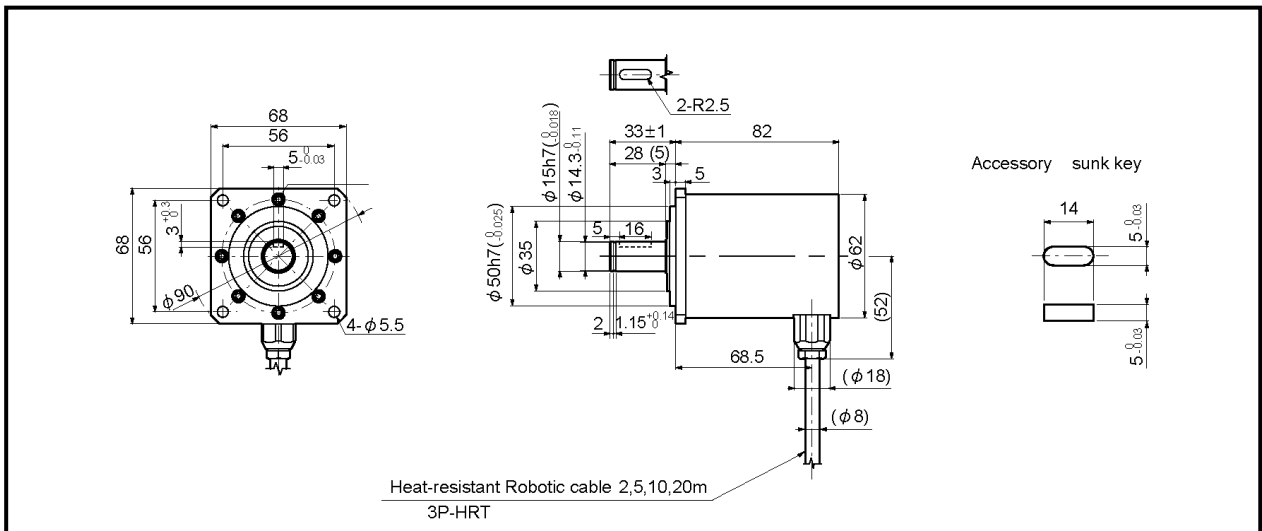

### (3) VRE-10TP068LK[ ][L] (Base-mount type)

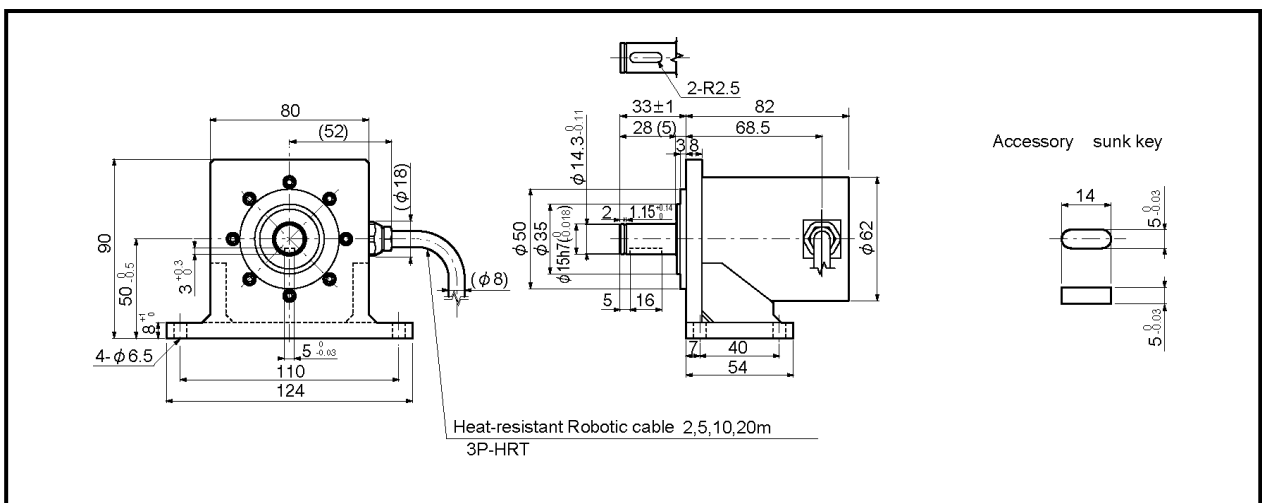

**(4) VRE-10TP068MK[ ][L] (Face-mount type)**

**Units: mm**

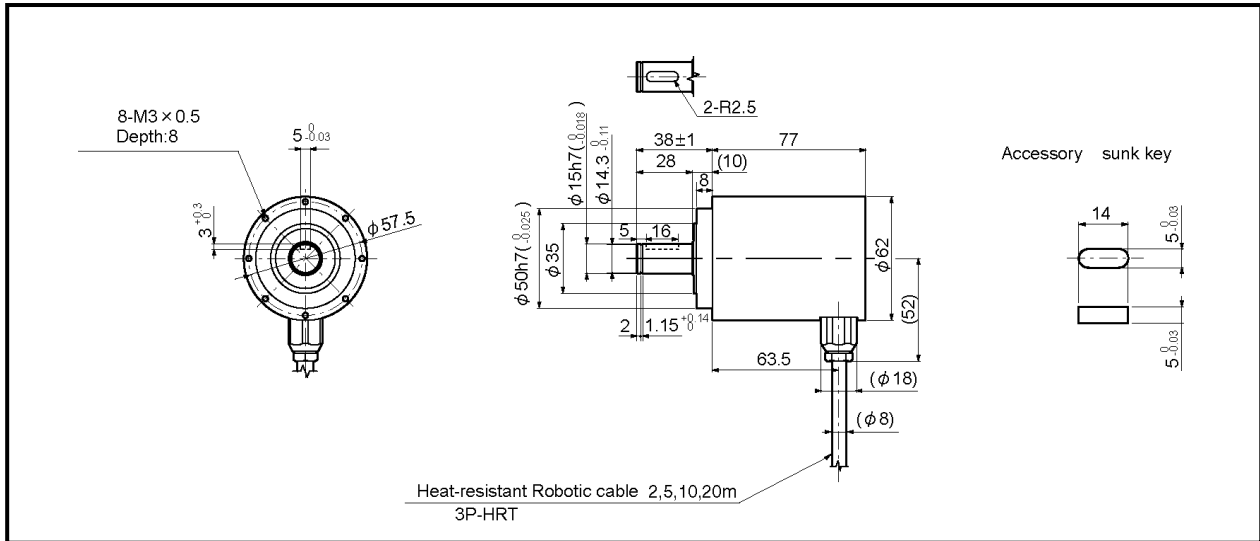

**(5) VRE-10TP101FK[ ][L]-G (Flange-mount type)**

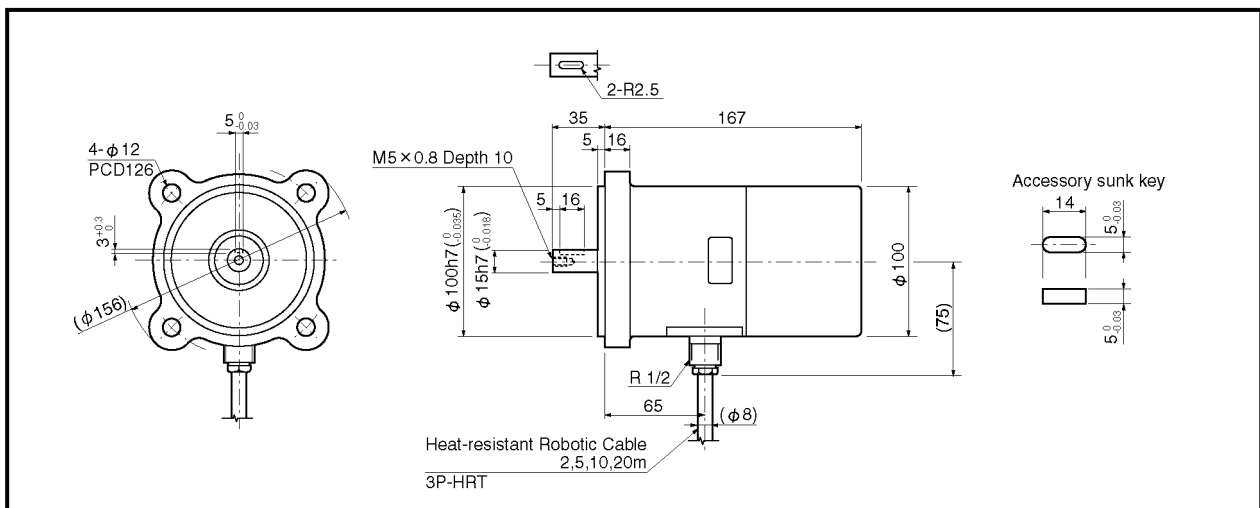

**(6) VRE-10TP101LK[ ][L]-G (Base-mount type)**

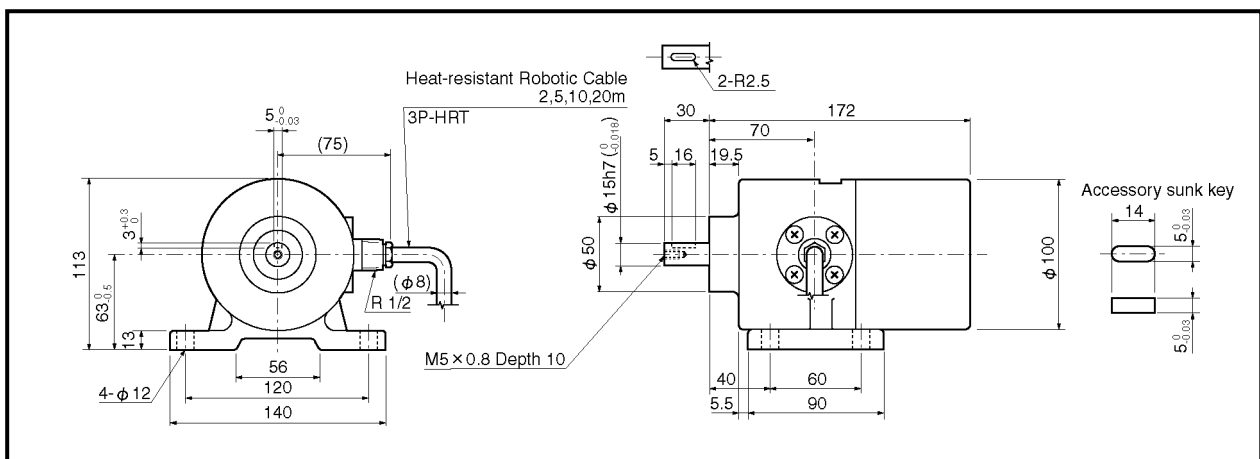

### 4-3. Extension Sensor Cable Dimensions

(1) 4P-S-0144-[L] / 4P-RBT-0144-[L] / 4P-URT-0144-[L]

Units: mm

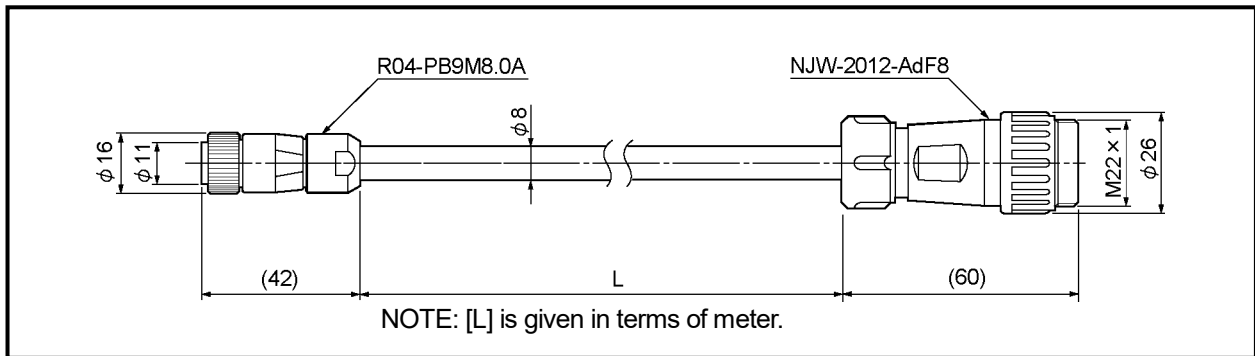

(2) 4P-S-4344-[L] / 4P-RBT-4344-[L] / 4P-URT-4344-[L] / 4P-HRT-4344-[L]

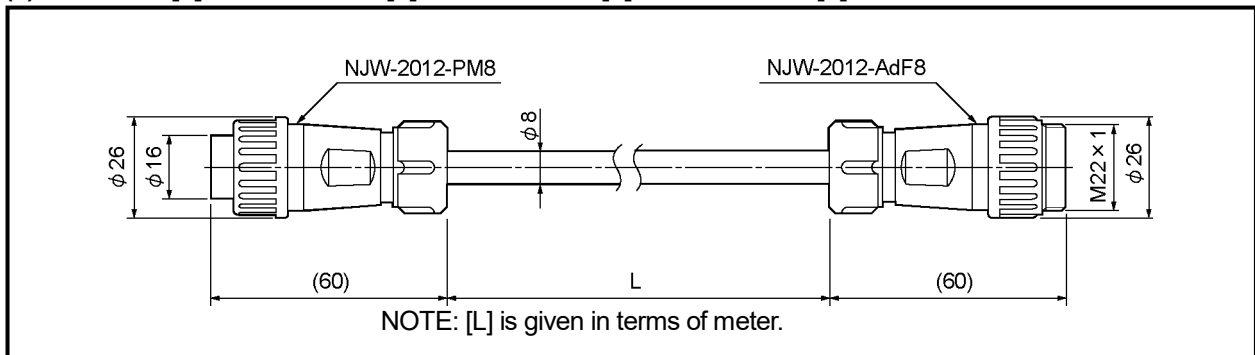

(3) 4P-S-0155-[L] / 4P-RBT-0155-[L] / 4P-URT-0155-[L]

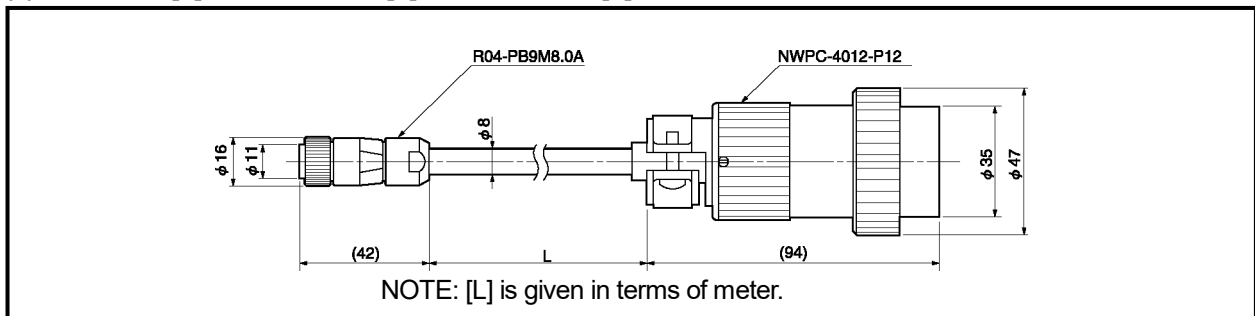

(4) 4P-S-0190-[L] / 4P-RBT-0190-[L] / 4P-URT-0190-[L]

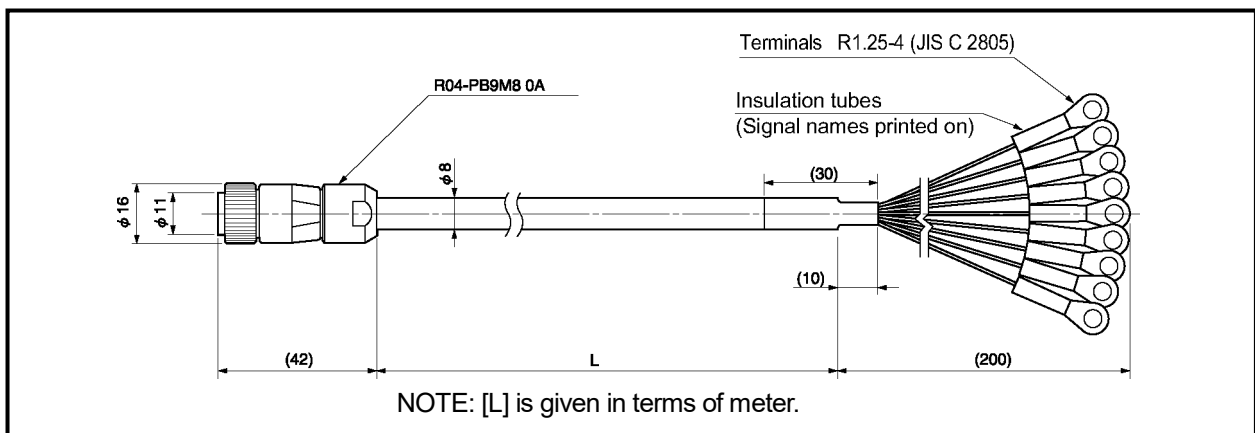

(5) 4P-S-9090-[L] / 4P-RBT-9090-[L] / 4P-URT-9090-[L] / 4P-HRT-9090-[L]

Units: mm

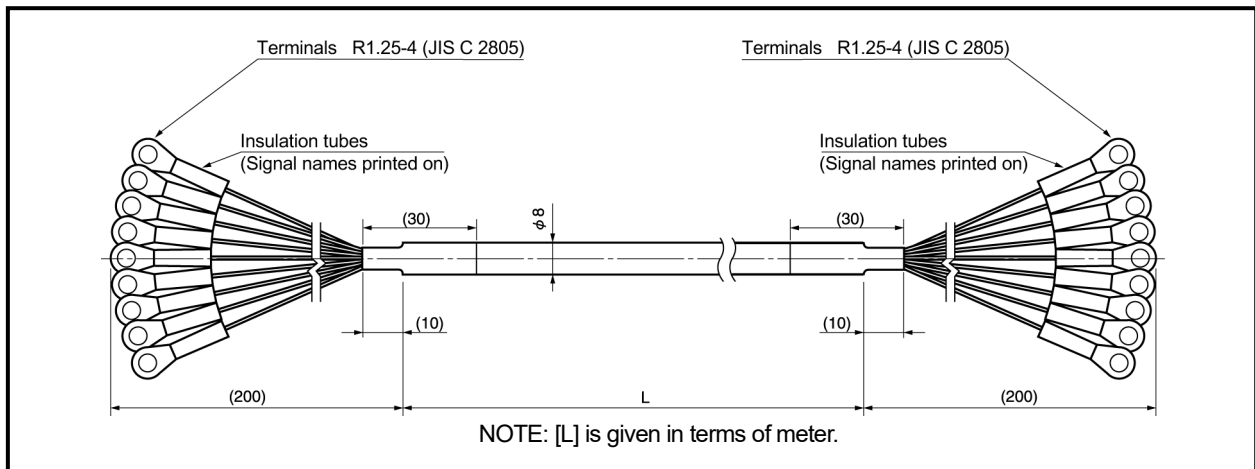

## 4-4. I/O Cable

●VS-C05-[L]

Units: mm

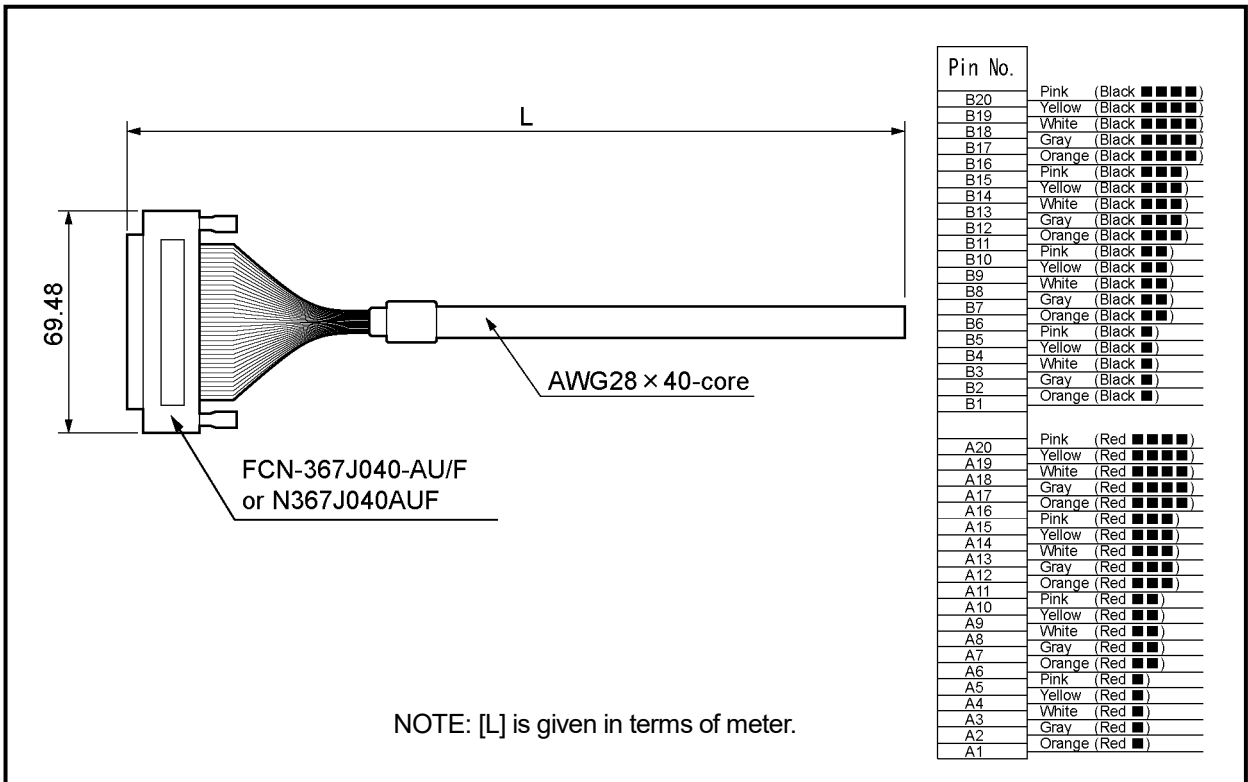

## 5. CHECKING THE CONTENTS OF THE SHIPPING CASE

Open the packing case, and verify that all items are present.

When extension sensor cables are ordered, they are packed separately.

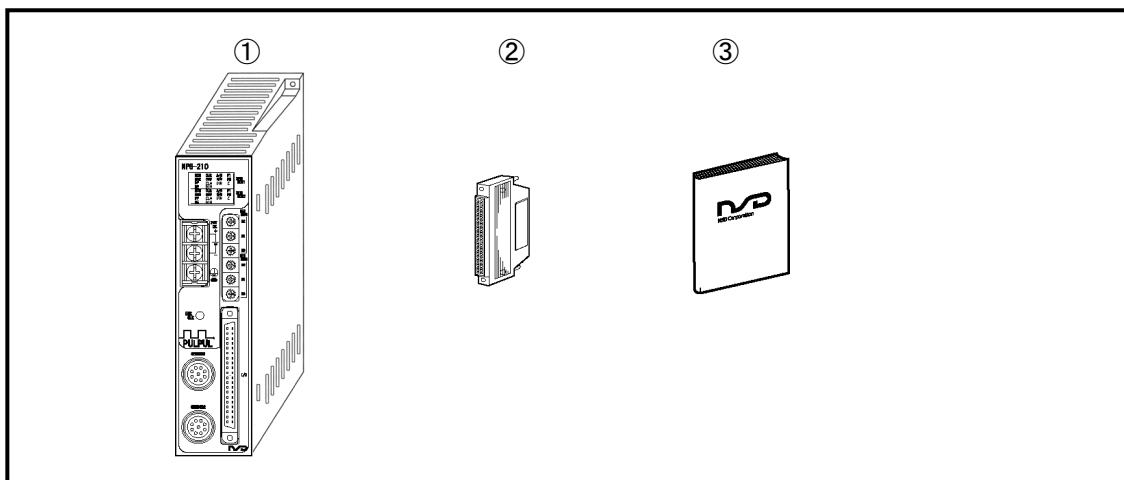

① Converter..... 1 unit

② I/O connector..... 1 piece

Connector: FCN-361J040-AU / N361J040AU

Cover: FCN-360C040-B / N360C040B

Manufacturer: FUJITSU COMPONENT LIMITED / OTAX CO.,LTD.

③ Manual..... 1 piece



## 6. INSTALLATION

### 6-1. Converter Installation Conditions and Precautions

When installing the converter, the following conditions and precautions should be observed.

#### -Installation Site

- (1) Avoid sites where the unit is exposed to direct sunlight.
- (2) The ambient temperature should never exceed a 0 to 55°C range.
- (3) The ambient humidity should never exceed a 20 to 90% RH range.
- (4) Do not install the unit in areas where condensation is likely to occur (high humidity with extreme temperature changes).
- (5) Avoid sites where dust is excessive.
- (6) Do not install in areas with an excessive amount of salt and/or metal chips.
- (7) Do not install in areas where flammable and / or corrosive gases are present.
- (8) Avoid areas where splashing water, oil or chemicals are likely to occur.
- (9) Avoid areas where vibration and shocks are excessive.

#### -Installation cautions

- (1) Install inside the control cabinet.
- (2) Install in a vertical direction so that the characters are visible.
- (3) If a DIN rail mounting format is used, insert until the latch mechanism catches with an audible click.  
Secure between end plates at both sides.
- (4) In high vibration areas, secure tightly with 2 M4 screws.
- (5) Install as far from high voltage lines and power lines as possible in order to minimize noise influences.
- (6) Allow 85mm or more space at the converter's front side for plugging in and unplugging the connector.
- (7) Peripheral components should be arranged so as not to obstruct converter installation, removal, and connector plugging/unplugging.

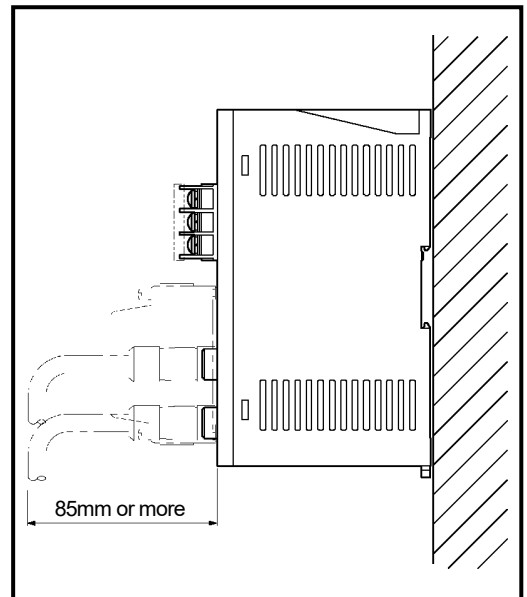

## 6-2. ABSOCODER Sensor Installation Conditions and Precautions

The ABSOCODER installation procedures and precautions are described in this section.



### ● Handling of Turn-type ABSOCODER Sensor

Item	Explanation
(1) Main unit	<p>Never drop the Sensor, or subject it to excessive forces or shocks.</p>
(2) Cable	<p>Avoid stepping on, or applying excessive stress to the cable.</p>

### ● Mounting of Turn-type ABSOCODER Sensor

Item	Explanation	Precaution
(1) Mounting	For details regarding mounting dimensions, refer to each ABSOCODER dimensions.	
(2) Cable port	<p>Cable port should face downward.</p>	
(3) Cable	<p>The bend radius for movable parts should never be less than 75 mm (<math>\phi</math> 150) (robotic cable).</p>	Do not use the standard cable for movable parts. (Use robotic cable.)
(4) Wiring	<p>The sensor cable should be located at least 300mm away from power lines and other lines which generate a high level of electrical noise.</p>	

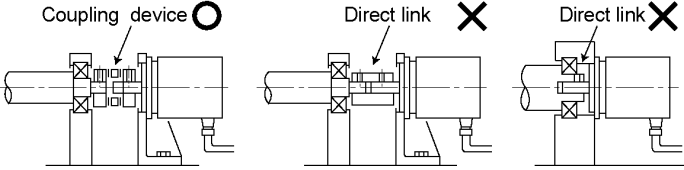
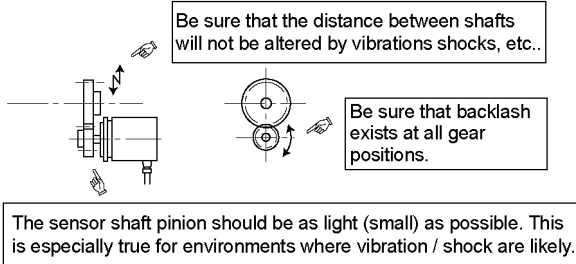
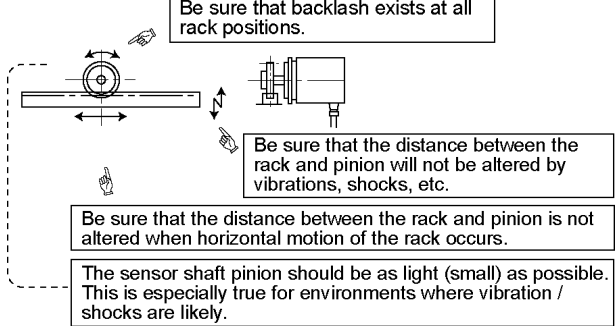
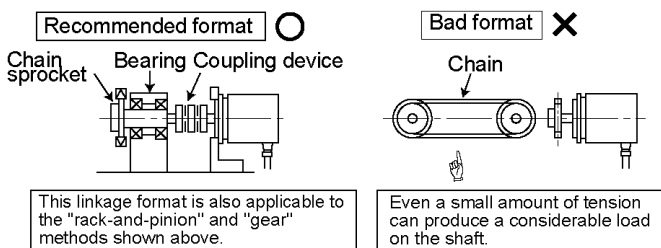
● **Mounting of Turn-type ABSOCODER Sensor**

Item	Explanation	Precaution
(1) Coupling of machine shaft and sensor shaft	<p>Be sure to use a coupling device to link the 2 shafts.</p>  <p>Coupling device ○      Direct link ✕      Direct link ✕</p>	<p>A “direct-link” format will result in shaft fatigue and / or breakage after long periods. Therefore, be sure to use a coupling device to link the shafts.</p>
(2) For gear-type linkage	<p>If a gear linkage is used, be sure that some backlash exists.</p>  <p>Be sure that the distance between shafts will not be altered by vibrations shocks, etc..</p> <p>Be sure that backlash exists at all gear positions.</p> <p>The sensor shaft pinion should be as light (small) as possible. This is especially true for environments where vibration / shock are likely.</p>	<p>Incorrect gear mounting can result in shaft bending or breakage.</p>
(3) For rack and pinion type linkage	<p>Be sure that backlash exists at all rack positions.</p>  <p>Be sure that backlash exists at all rack positions.</p> <p>Be sure that the distance between the rack and pinion will not be altered by vibrations, shocks, etc.</p> <p>Be sure that the distance between the rack and pinion is not altered when horizontal motion of the rack occurs.</p> <p>The sensor shaft pinion should be as light (small) as possible. This is especially true for environments where vibration / shocks are likely.</p>	<p>Incorrect rack and pinion mounting can result in shaft bending or breakage.</p>
(4) Chain or timing belt linkage	<p>When a chain or timing belt linkage format is used, there is an inherent risk of the shaft's load being increased by the resulting tension. Therefore, a bearing should be used, with the shafts being linked by a coupling device immediately behind the bearing.</p>  <p>Recommended format ○      Bad format ✕</p> <p>Chain sprocket      Bearing      Coupling device      Chain</p> <p>This linkage format is also applicable to the "rack-and-pinion" and "gear" methods shown above.</p> <p>Even a small amount of tension can produce a considerable load on the shaft.</p>	
(5) Shaft mounting position	<p>The shaft should be attached to the coupling device or gear at a point which is as near to the sensor body as possible.</p>  <p>Recommended format ○      Bad format ✕      Coupling device or</p> <p>This distance should be as short as possible. When this distance is short, the load placed on the bearing by vibrations / shocks is slight.</p> <p>Never use an extended shaft format.</p>	

● Coupling of Turn-type ABSOCODER Sensor

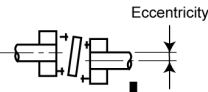
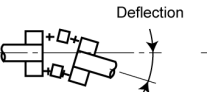
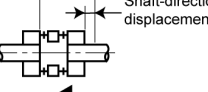
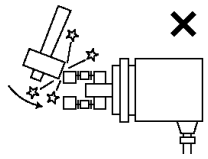
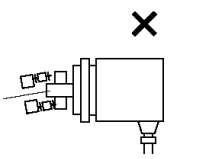
Item	Explanation	Precaution
<p>(1) Coupling device selection precaution</p>	<p>1. Selection of the coupling device should be based on the following factors;</p> <ul style="list-style-type: none"> <li>- The amount of a mounting error caused by the machine design.</li> <li>- The permissible error of coupling device.</li> <li>- Reaction force of coupling device.</li> <li>- Permissible shaft load of the sensor.</li> </ul> <div style="display: flex; justify-content: space-around; align-items: center; margin: 10px 0;"> <div style="border: 1px solid black; padding: 2px; font-size: 8px;">The amount of a mounting error caused by the machine design</div> <div style="font-size: 24px;">&lt;</div> <div style="border: 1px solid black; padding: 2px; font-size: 8px;">The permissible error of the coupling device</div> </div> <hr style="width: 100%;"/> <p><b>Mounting error</b></p> <div style="display: flex; justify-content: space-around; align-items: center;"> <div style="text-align: center;">  <p>Eccentricity</p> <p>↓</p> <div style="border: 1px solid black; padding: 2px; font-size: 8px;">Load generated by the eccentricity</div> </div> <div style="text-align: center;">  <p>Deflection</p> <p>↓</p> <div style="border: 1px solid black; padding: 2px; font-size: 8px;">Load generated by the deflection</div> </div> <div style="text-align: center;">  <p>Prescribed dimension</p> <p>Shaft-direction displacement</p> <p>←</p> <div style="border: 1px solid black; padding: 2px; font-size: 8px;">Load generated by the shaft direction displacement</div> </div> </div> <div style="display: flex; justify-content: space-around; margin-top: 10px;"> <div style="border: 1px solid black; padding: 2px; font-size: 8px;">Radial load</div> <div style="border: 1px solid black; padding: 2px; font-size: 8px;">Thrust load</div> </div> <p>2. If the selected coupling device is larger than necessary (When used in high vibration/shock environments), the load which is applied to the shaft by the vibrations/shocks will be increased by the weight of the coupling device.</p> <p>3. Be sure to select a coupling device with an adequate transmission torque surplus relative to the sensor shaft's torque.</p>	<p>The selection of a larger coupling than necessary will increase the shaft load which is caused by the mounting error amount.</p> <p>Excessive force applied to the shaft can deform the coupling and reduce durability.</p>
<p>(2) Coupling device installation precaution</p>	<p>Avoid bending or damaging the coupling.</p> <div style="display: flex; justify-content: space-around; align-items: center; margin-top: 10px;"> <div style="text-align: center;">  <p>×</p> </div> <div style="text-align: center;">  <p>×</p> </div> </div>	

# 7. WIRING

## 7-1. Power Supply Connection

The power supply should be connected as described below.

### (1) Power Supply

- Choose the power supply capacity which is more than twice the power consumption of the converter.  
The power consumption of the converter is 10W or less.
- The input power supply should be isolated from the commercial power supply.
- The power cable should be as thick as possible to minimize voltage drops.
- Twist the power cable for preventing noises.
- Use the M4 size crimp lug terminals with insulating sleeves in order to prevent short circuit caused by loose screws.
- The terminal block tightening torque is 1.8 N·m (16 lb·in).

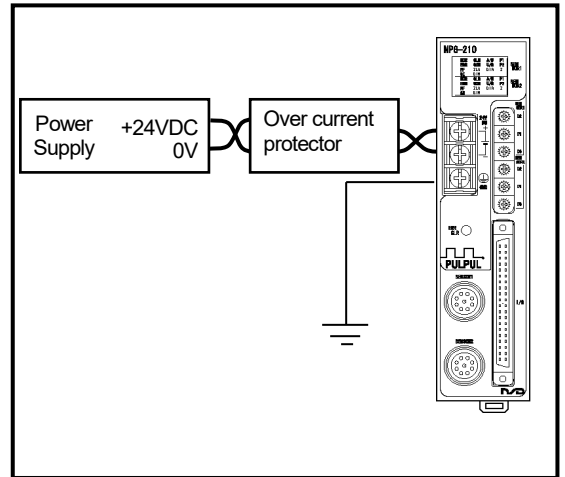

### (2) Ground

- The unit should be securely grounded (ground resistance of 100ohm or less) to prevent electrical shocks.
- The ground wire should be connected to the ground terminal directly.
- The terminal block tightening torque is 1.8 N·m (16 lb·in).

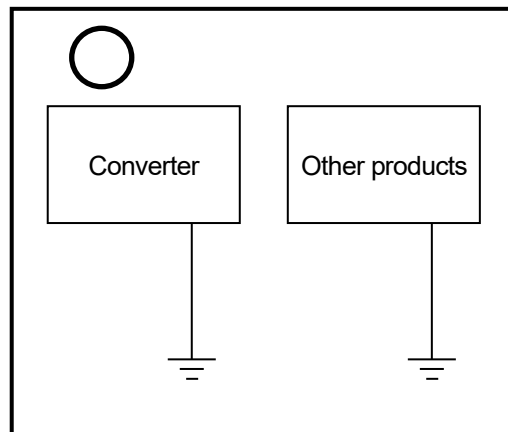
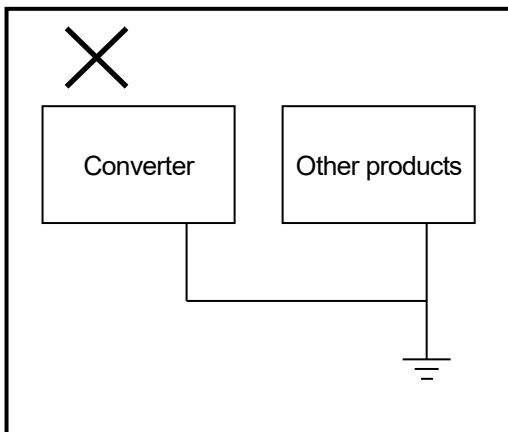

## 7-2. Connection between Converter and ABSOCODER Sensor

The maximum extension sensor cable length varies according to the ABSOCODER sensor and cable model being used. For more details refer to "3-2. ABSOCODER Sensor Specifications".

### -Wiring Precautions

- (1) The sensor cable should be clamped as shown in the right figure to prevent excessive tension from being applied to the cable connectors.
- (2) The sensor cable should be located at least 300mm away from power lines and other lines which generate a high level of electrical noise.
- (3) If the cable is moved under the state of bending like a horseshoe, a robotic cable should be used. The bend radius should never be less than 75 mm.

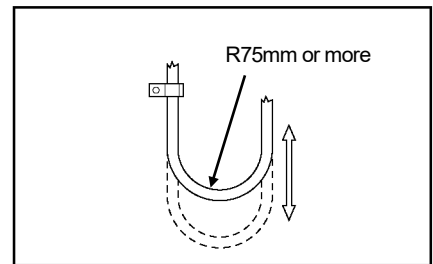
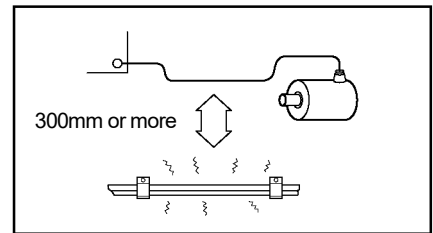
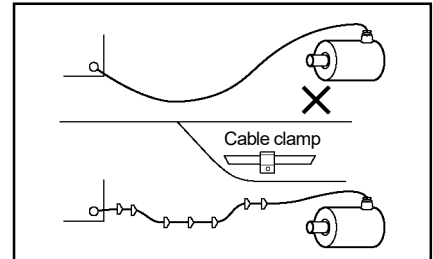

## 7-2-1. Connection configure example of the sensor cable

● In the case of using the NSD special cable

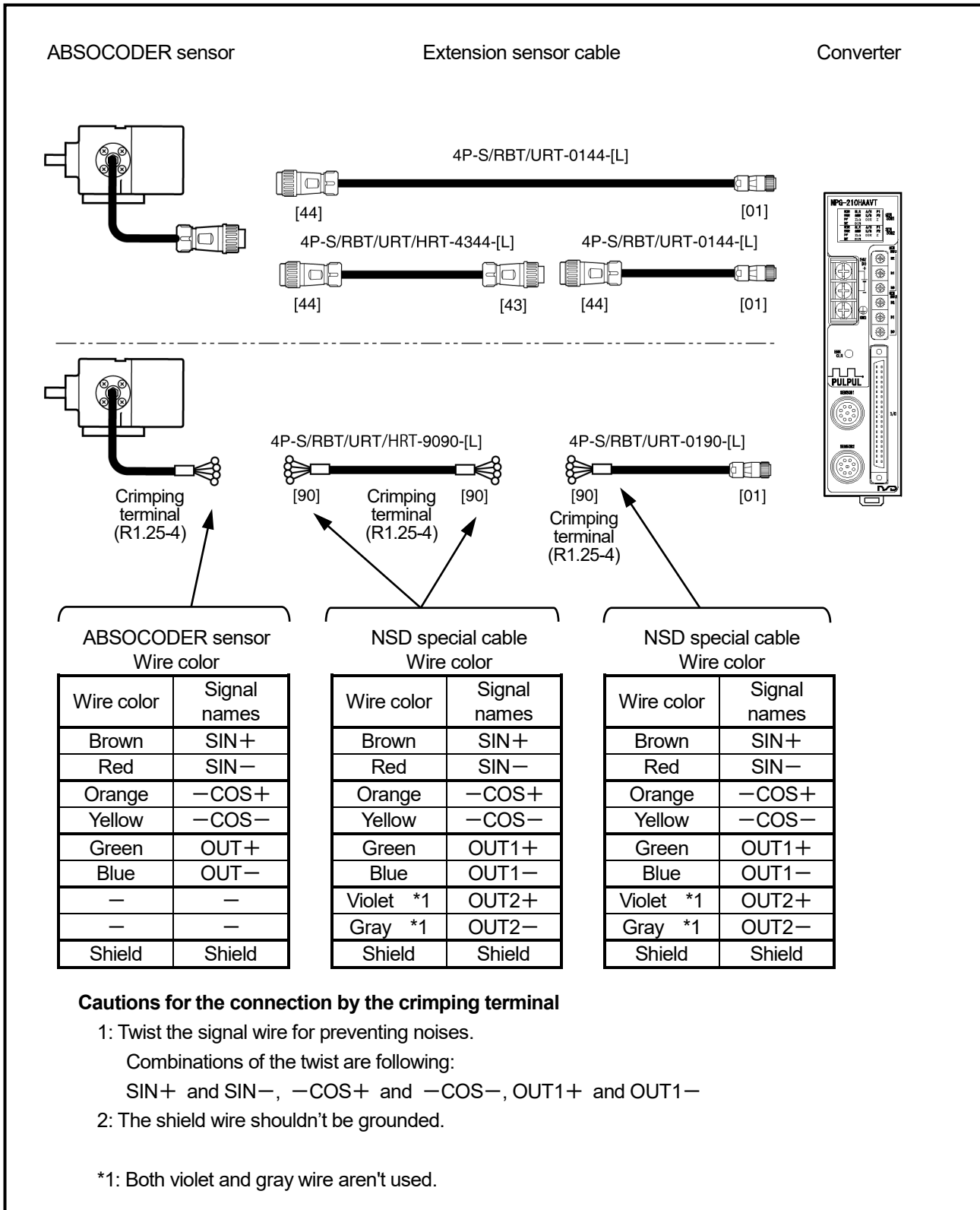

- In the case of using the commercially available cable (JKPEV-S 1.25mm<sup>2</sup> × 5P) and connecting with crimping terminals

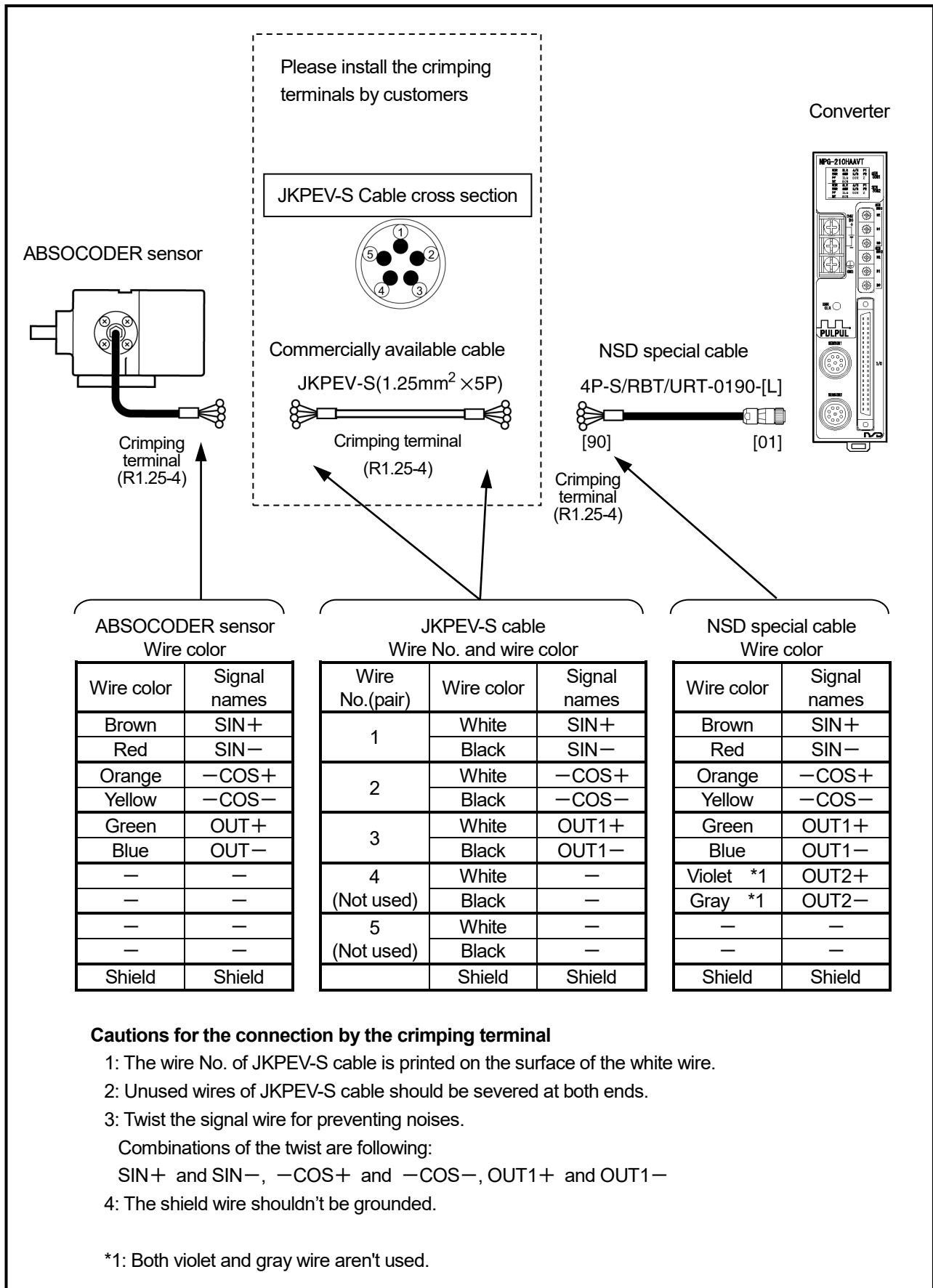



- In the case of using the commercially available cable (JKPEV-S 1.25mm<sup>2</sup>×5P) and connecting with a connector

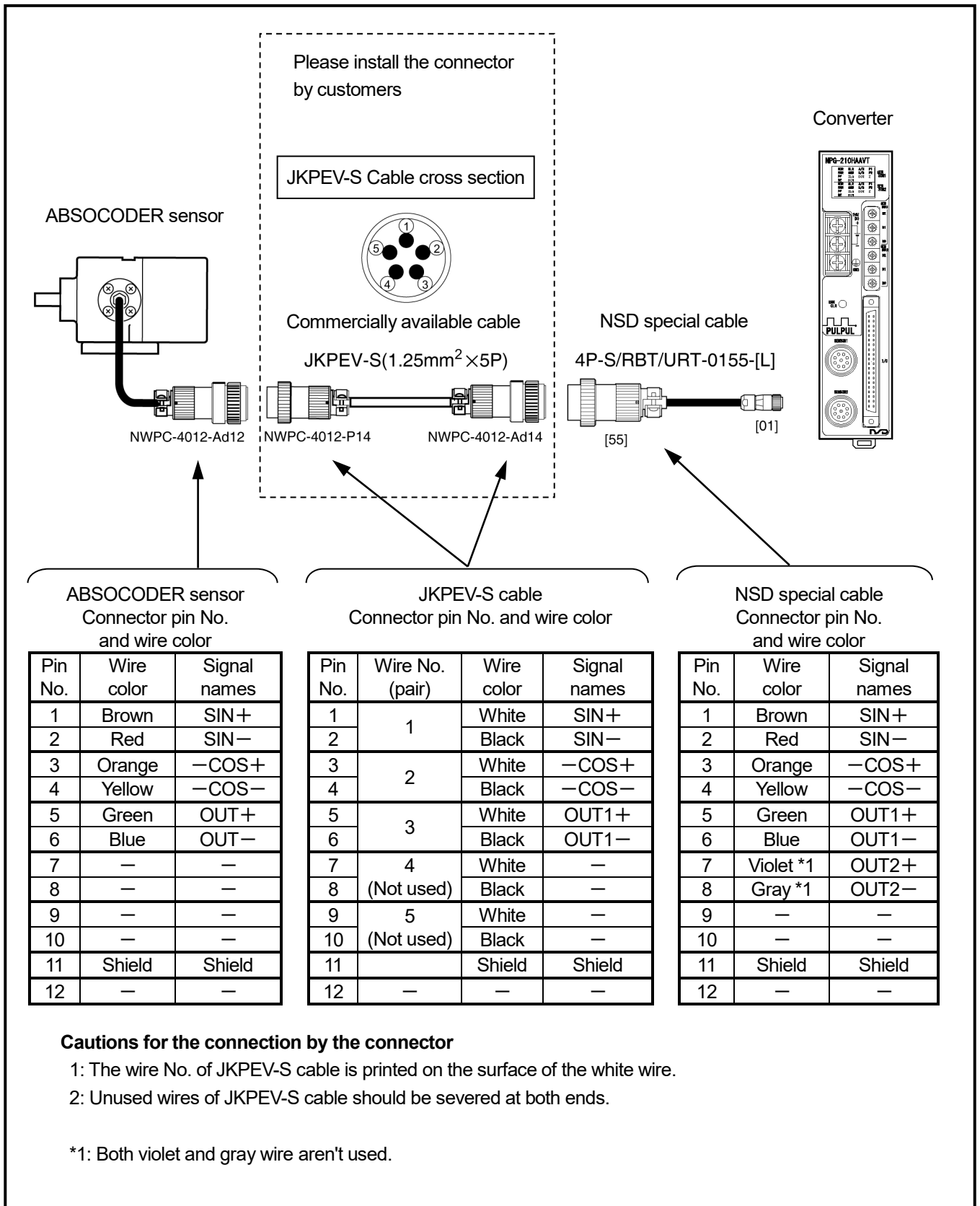

### 7-3. Input / Output Connector Connection

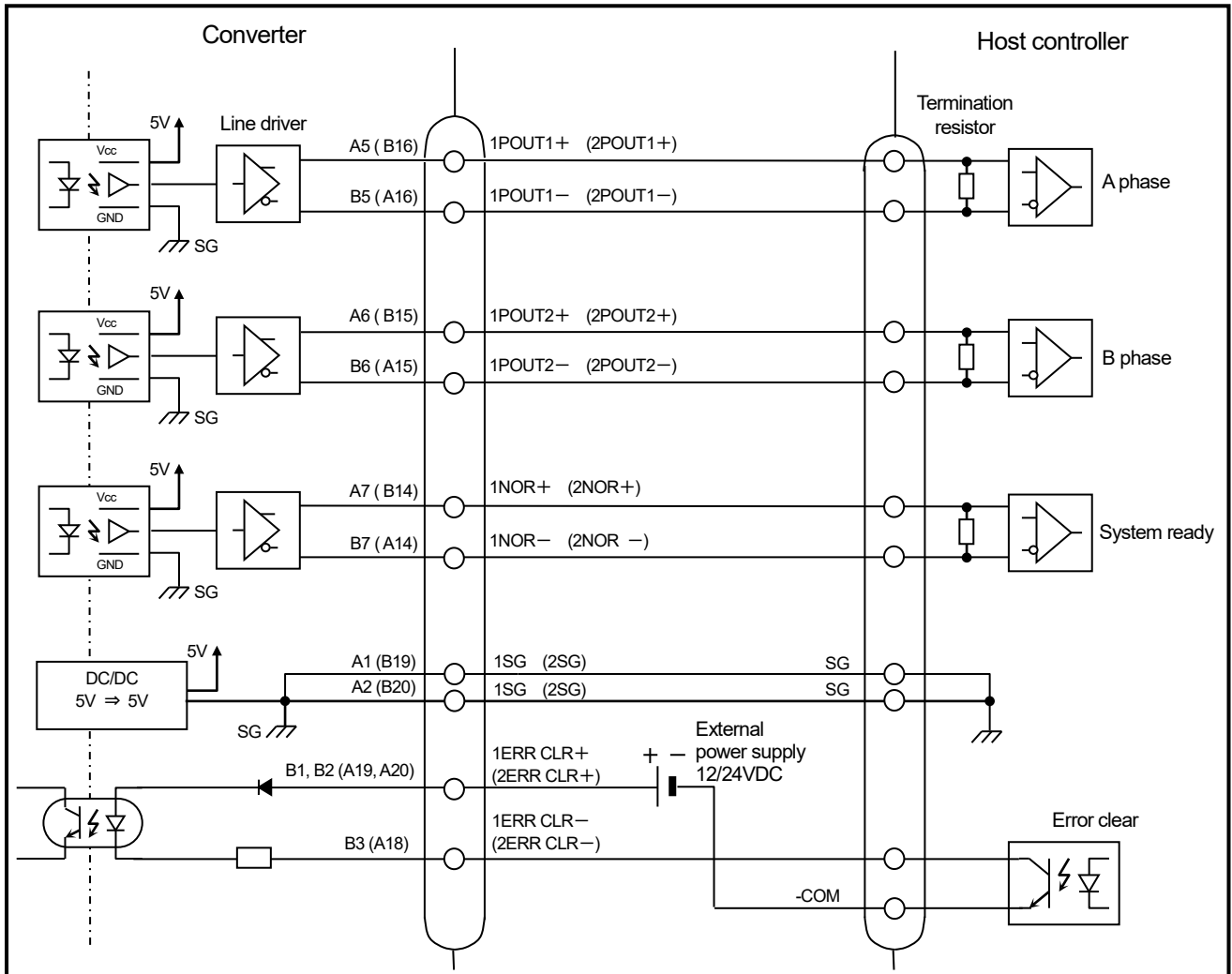

\*1: The circuit for axis-1 and axis-2 is isolated. Supply the power to both axis-1 and axis-2.

\*2: The line driver which is equivalent to AM26C31 manufactured by Texas Instruments Incorporated is used.

Mount proper termination resistor when connecting with the line receiver.

● I/O cable (VS-C05)

Indicates wire colors and markings.

Pin No.	Wire colors & markings	Pin No.	Wire colors & markings
B20	Pink (Black ■■■■)	A20	Pink (Red ■■■■)
B19	Yellow (Black ■■■■)	A19	Yellow (Red ■■■■)
B18	White (Black ■■■■)	A18	White (Red ■■■■)
B17	Gray (Black ■■■■)	A17	Gray (Red ■■■■)
B16	Orange (Black ■■■■)	A16	Orange (Red ■■■■)
B15	Pink (Black ■■■■)	A15	Pink (Red ■■■■)
B14	Yellow (Black ■■■■)	A14	Yellow (Red ■■■■)
B13	White (Black ■■■■)	A13	White (Red ■■■■)
B12	Gray (Black ■■■■)	A12	Gray (Red ■■■■)
B11	Orange (Black ■■■■)	A11	Orange (Red ■■■■)
B10	Pink (Black ■■■■)	A10	Pink (Red ■■■■)
B9	Yellow (Black ■■■■)	A9	Yellow (Red ■■■■)
B8	White (Black ■■■■)	A8	White (Red ■■■■)
B7	Gray (Black ■■■■)	A7	Gray (Red ■■■■)
B6	Orange (Black ■■■■)	A6	Orange (Red ■■■■)
B5	Pink (Black ■■■■)	A5	Pink (Red ■■■■)
B4	Yellow (Black ■■■■)	A4	Yellow (Red ■■■■)
B3	White (Black ■■■■)	A3	White (Red ■■■■)
B2	Gray (Black ■■■■)	A2	Gray (Red ■■■■)
B1	Orange (Black ■■■■)	A1	Orange (Red ■■■■)

# 8. NOMENCLATURE

## 8-1. Part Identification

Part identification is described in this section.

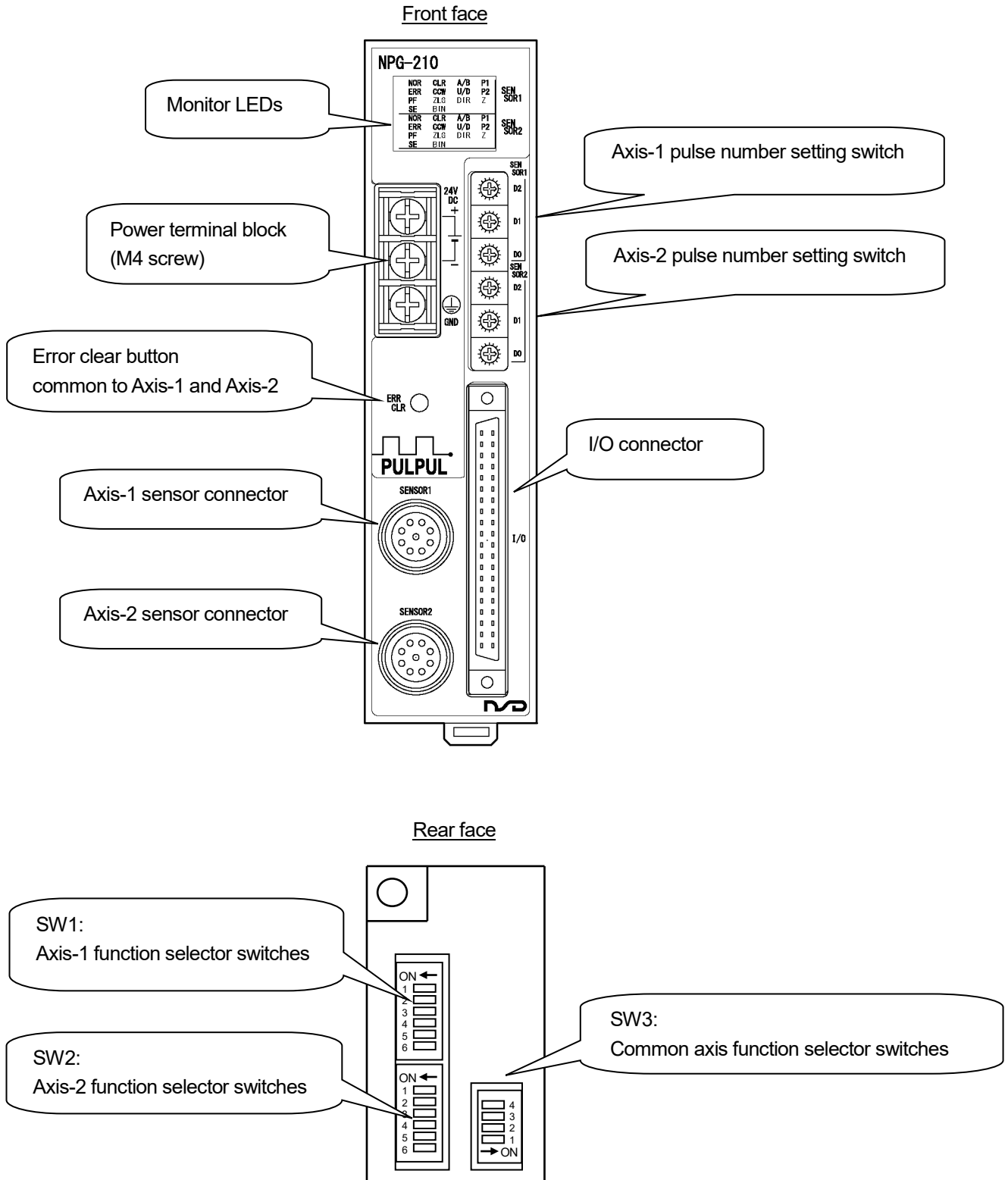

## 8-2. Monitor LED

Display contents on the monitor LEDs is described in this section.

The monitor display for axis-1 is isolated from axis-2 one.

For example, the monitor LEDs indicate the following when detecting the sensor disconnected error (SE) for axis-1.

- Axis-1 system ready (NOR): OFF
- Axis-1 system error (ERR): ON
- Axis-1 sensor disconnected error (SE): ON

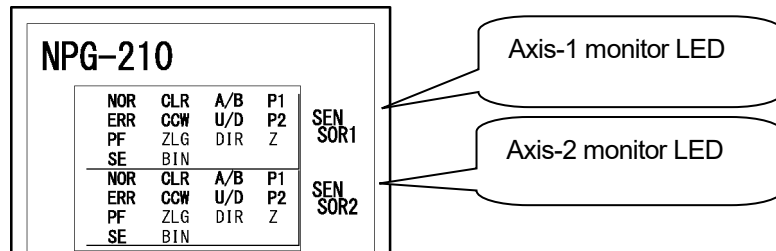

Display	Name	Color	Description
NOR	System ready	Green	LED turns ON when the pulse output is normal status.
ERR	System error	Red	The converter detects an error, and LED turns ON when the pulse output is abnormal state.
PF	Low power supply error	Green	LED turns ON when detecting the 24VDC low power supply error. LED blinks when detecting the power supply error inside of the converter.
SE	Sensor disconnected error	Green	LED turns ON when detecting the sensor disconnected error.
CLR	Error clear input state	Green	LED turns ON when turning ON the error clear input. (1) In the case of inputting from external: LED which is corresponding to the axis turns ON. (2) In the case of inputting from the switch on the panel: both LEDs for axis-1 and axis-2 turn ON.
CCW	Selected state of the pulse output increase/decrease direction	Green	LED turns ON when the function selector switch "pulse output increase/decrease direction" is ON.
ZLG	—	—	Not used (Always ON)
BIN	—	—	
A/B	Pulse format	Green	A/B phase pulse format (Always ON)
U/D	—	—	Not used (Always OFF)
DIR	—	—	
P1	Pulse output state	Green	P1: LED turns ON when the output voltage of "A phase +" pulse is high level.
P2			P2: LED turns ON when the output voltage of "B phase +" pulse is high level.
Z	—	—	Not used (Always OFF)

## 9. OPERATION

### 9-1. Operation Sequence

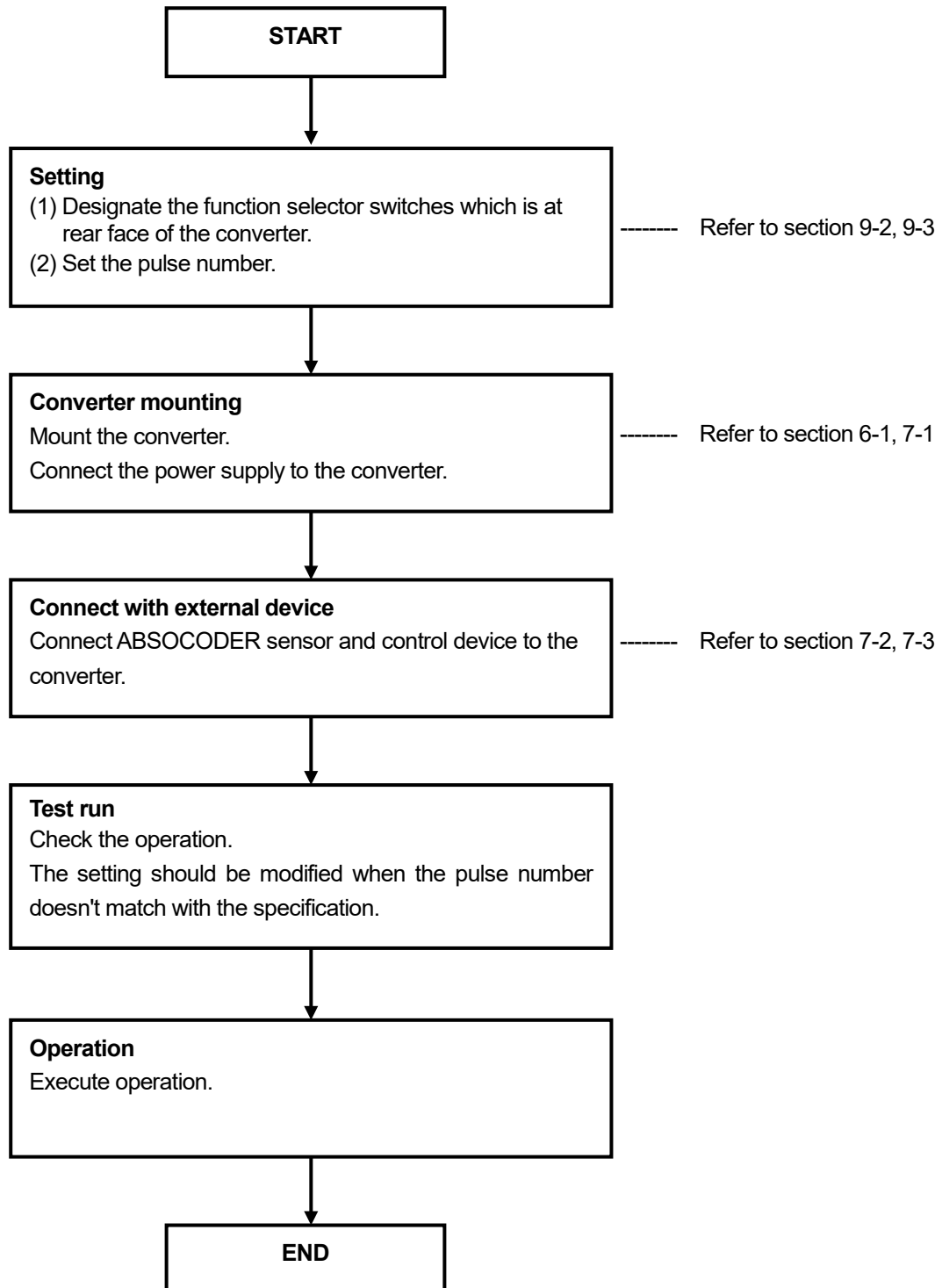

## 9-2. Function Selector Switch

Function selector switch is described in this section.

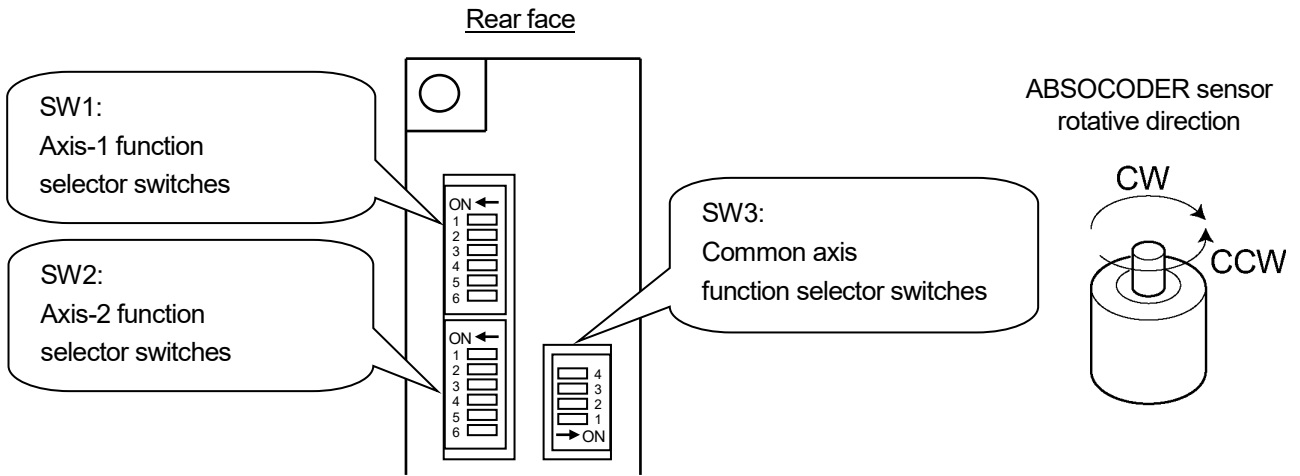

(1) Function selector switches of each axis SW1, SW2

SW1_* SW2_*	Name	Setting ( <input type="checkbox"/> : Factory setting )	
1	Reserved	<input checked="" type="checkbox"/> Fixed at OFF	The correct operation cannot be guaranteed if this switch is set to the ON position.
2	Reserved	<input checked="" type="checkbox"/> Fixed at OFF	The correct operation cannot be guaranteed if this switch is set to the ON position.
3	Pulse output increase/ decrease direction	<input type="checkbox"/> OFF	The pulse outputs to the increase direction when the ABSOCODER sensor rotates to CW. (CCW: decrease direction)
		<input type="checkbox"/> ON	The pulse outputs to the decrease direction when the ABSOCODER sensor rotates to CW. (CCW: increase direction)
4	Axis disabled	<input type="checkbox"/> OFF	All functions which are corresponding to the axis are enabled.
		<input type="checkbox"/> ON	All functions which are corresponding to the axis are disabled.
5	Reserved	<input checked="" type="checkbox"/> Fixed at OFF	The correct operation cannot be guaranteed if this switch is set to the ON position.
6	Reserved	<input checked="" type="checkbox"/> Fixed at OFF	The correct operation cannot be guaranteed if this switch is set to the ON position.

**(2) Common axis function selector switches SW3**

SW3_*	Name	Setting ( <input type="checkbox"/> : Factory setting )	
1	Error clear method	<input type="checkbox"/> OFF (Automatic clear)	If the converter detects an error, the error state is automatically cleared when removing the cause.
		ON (Manual clear)	If the converter detects an error, the error state is kept except doing either of the following operations after removing the cause. - Pressing the ERR CLR button on the panel - Inputting the error clear signal from external
2	Reserved	<input type="checkbox"/> Fixed at OFF	The correct operation cannot be guaranteed if this switch is set to the ON position.
3	Reserved	<input type="checkbox"/> Fixed at OFF	The correct operation cannot be guaranteed if this switch is set to the ON position.
4	Reserved	<input type="checkbox"/> Fixed at OFF	The correct operation cannot be guaranteed if this switch is set to the ON position.

**Important**

Cautions when using the function selector switches















- Do not turn ON the "reserved" switch.
- Turn the power OFF and then ON again after the function selector switches are changed.

### 9-3. Setting of Pulse Number

The pulse number is set by the BCD code (binary coded decimal). The BCD code is set by rotary switch "D0 to D2" on the panel.

Following charts are indicated the specification of the pulse number setting and setting example.

Items	Description
Pulse number	The output pulse number when the shaft of the ABSOCODER sensor rotated once should be set. The setting can be selected to desired value from 10 to 10240 by 10-pulse unit.
Setting of axis-1	It is set by "D0 to D2" of sensor-1 pulse number setting switch.
Setting of axis-2	It is set by "D0 to D2" of sensor-2 pulse number setting switch.

Setting example	Number of pulse output
<p><b>【Factory setting】</b></p> <p><b>Setting</b></p>  D2 ⇒ <b>0</b>  D1 ⇒ <b>0</b>  D0 ⇒ <b>0</b>	<p>10240 pulses/turn</p> <p>The output pulse number is 10240-pulse/turn when following values are set;            (a) In the case of setting the pulse more than 10240            (b) In the case of changing the setting of D0 or D1 from A to F</p>
<p><b>Setting</b></p>  D2 ⇒ <b>0</b>  D1 ⇒ <b>6</b>  D0 ⇒ <b>0</b>	<p>600 pulses/turn</p>
<p><b>Setting</b></p>  D2 ⇒ <b>2</b>  D1 ⇒ <b>5</b>  D0 ⇒ <b>6</b>	<p>2560 pulses/turn</p>
<p><b>Setting</b></p>  D2 ⇒ <b>A</b>  D1 ⇒ <b>0</b>  D0 ⇒ <b>0</b>	<p>10000 pulses/turn</p> <p>Point: Set D2 to "A" for pulse number of 10000 or more.</p>
<p><b>Setting</b></p>  D2 ⇒ <b>A</b>  D1 ⇒ <b>2</b>  D0 ⇒ <b>4</b>	<p>10240 pulses/turn</p>

<b>Important</b>	<u>Cautions when using the pulse number setting switches</u>
Turn the power OFF and then ON again after the pulse setting switches are changed.	



## 9-4. Error Clear Button

In the case of clearing an error, remove the cause, and then press the error clear button on the converter panel. The error clear button is effective for both axis-1 and axis-2.

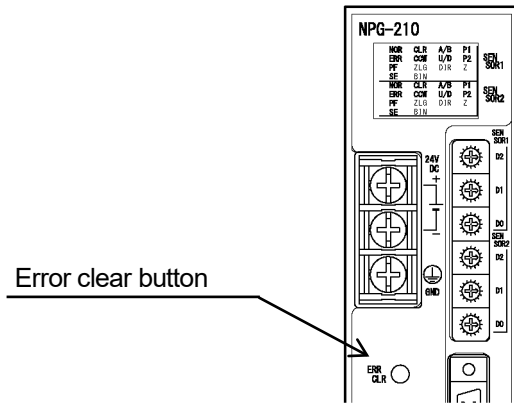

## 10. INSPECTION

The inspection should be conducted once every 6 months to a year.

Any inspected items which do not satisfy the criteria shown below should be repaired

Inspection item	Inspection Description	Criteria	Remark
Power supply	Measure the voltage fluctuation at the power supply terminal block of the converter to determine if it is within the prescribed range.	Within 21.6V to 26.4VDC	Tester
Ambient conditions	Check the ambient temperature.	ABSOCODER sensor: Refer to "ABSOCODER Sensor Specifications". Converter: 0 to +55°C	Thermometer
	There should be no accumulation of dust.	None	Visual Inspection
Mount conditions	Verify that the sensor is securely mounted.	There should be no looseness.	
	Verify that the sensor shaft is securely coupled to the machine shaft.	There should be no looseness.	
	Check for severed cables.	Cable should appear normal.	
	Verify that the relay connector of the sensor cable is plugged in all the way.	There should be no looseness.	
	Verify that the screws of the relay terminal block of the sensor cable is securely tightened.	There should be no looseness.	
	Verify that the sensor cable connector is plugged in all the way.	There should be no looseness.	
	Verify that the I/O connector is plugged in all the way.	There should be no looseness.	

# 11. TROUBLESHOOTING

The causes and corrective actions for errors that may occur during converter operation are described below.

## 11-1. Display and Countermeasure when an Error Occurred

● Lists of the error monitors, probable causes, and error clear procedures

Error item	Name	Probable cause	Error cancel procedures
SENSOR1 "ERR" and "SE" LED is ON.	Axis-1 sensor disconnected error	Sensor connector is disconnected or loose.	After removing an error cause, clear the error by either way: *1 - Press the error clear button of the front face. - Turn ON the error clear signal which is corresponding to the axis. - Turn the converter power OFF and then ON again.
		Sensor cable is severed.	Replace the sensor cable. For more details, refer to "11-3".
SENSOR2 "ERR" and "SE" LED is ON.	Axis-2 sensor disconnected error	ABSOCODER sensor failure	Replace the ABSOCODER sensor. For more details, refer to "11-3".
		Converter failure	Replace the converter. For more details, refer to "11-3".
SENSOR1 SENSOR2 "ERR" and "PF" LED is ON.	Low power supply error	Voltage drop of 24VDC power supply Instantaneous power failure of 24VDC power supply.	After removing an error cause, clear the error by either way: *2 - Press the error clear button of the front face. - Turn ON the error clear signal either axis-1 or axis-2. - Turn the converter power OFF and then ON again.
SENSOR1 SENSOR2 "ERR" LED is ON, "PF" LED is blinking.	Converter internal power supply error	The power supply inside of the converter is broken down.	Replace the converter. For more details, refer to "11-3".
SENSOR1 SENSOR2 Only "NOR" LED is ON.	—	The "Axis disabled" switch of the function selector switch is ON both axis-1 and axis-2.	Turn OFF the "Axis disabled" switch either axis-1 or axis-2.
Pulse is not output.	—	The wiring of the I/O connector has problems.	Repair the wiring.
		The "Axis disabled" switch of the function selector switch is ON.	Turn OFF the "Axis disabled" switch.
Incorrect pulse output.	—	The pulse output increase/decrease direction of the function selector switch is improper.	Select the correct increase/decrease direction.
		The pulse number setting is improper.	Set the correct pulse number.
		The wiring of the I/O connector has problems.	Repair the wiring.

If the troubleshooting procedures described above fail to solve the problem, the sensor or converter may be defective. In this case, please contact your NSD representative.

\*1: If the error clear method is set to "auto clear", the error will be cleared automatically after removing the cause of the sensor disconnected error. (Factory setting is "auto clear".)

\*2: If the error clear method is set to "auto clear", the error will be cleared automatically after removing the cause of the low power supply error. (Factory setting is "auto clear".)

## 11-2. Output State when Occurring an Error

Indicates the state of output signal when occurring an error.

Item \ Output	Axis-1		Axis-2	
	Pulse output A phase (1POUT1) B phase (1POUT2)	System ready 1NOR	Pulse output A phase (2POUT1) B phase (2POUT2)	System ready 2NOR
SENSOR1 "ERR" and "SE" LED is ON. Axis-1 sensor disconnected error	A+ and B+: L level A- and B-: H level	NOR+: H level NOR-: L level	Vary depending on the state for the axis-2.	Vary depending on the state for the axis-2.
SENSOR2 "ERR" and "SE" LED is ON. Axis-2 sensor disconnected error	Vary depending on the state for the axis-1.	Vary depending on the state for the axis-1.	A+ and B+: L level A- and B-: H level	NOR+: H level NOR-: L level
SENSOR1,SENSOR2 "ERR" and "PF" LED is ON. Low power error	A+ and B+: L level A- and B-: H level	NOR+: H level NOR-: L level	A+ and B+: L level A- and B-: H level	NOR+: H level NOR-: L level
SENSOR1,SENSOR2 "ERR" LED is ON, "PF" LED is blinking. Converter internal power supply error	A+ and B+: L level A- and B-: H level	NOR+: H level NOR-: L level	A+ and B+: L level A- and B-: H level	NOR+: H level NOR-: L level

## 11-3. Procedure Contents after Replacing

Implement the following measures after replacing the converter, ABSOCODER sensor, and sensor cable.

Replacing contents	Countermeasure
In the case of replacing ABOSOCODER sensor	After the replacement, clear the error by either way.*1 - Press the error clear button of the front face. - Turn ON the error clear signal which is corresponding to the axis. - Turn the converter power OFF and then ON again.
In the case of replacing the sensor cable	
In the case of replacing the converter	After replacing the converter, function selector switches on the back of converter and rotary switches (pulse number setting) on the panel should be set.

\*1: If the error clear method is set to "auto clear", the error will be cleared automatically after removing the cause of the sensor disconnecting error. (Factory setting is "auto clear".)

**-MEMO-**

## 11-4. ABSOCODER Sensor Check List

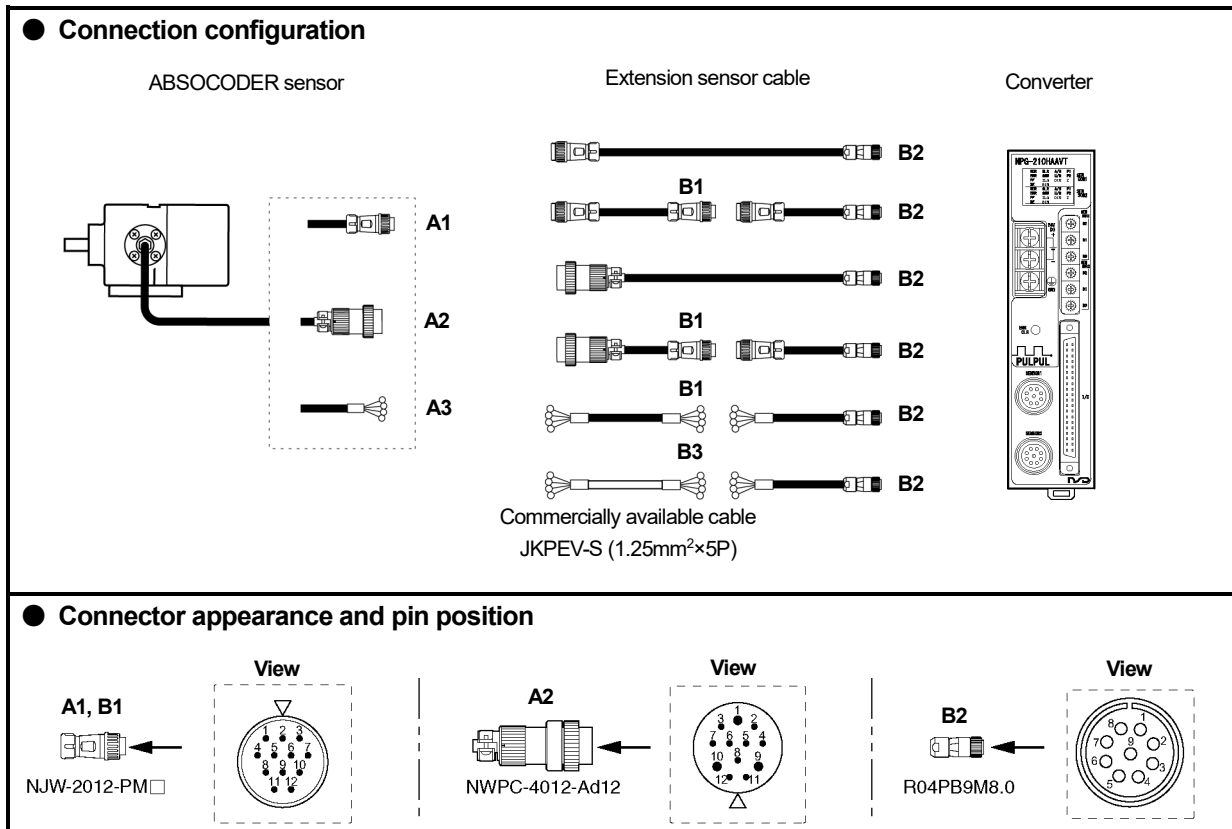

● **Connector pin position and standard coil resistance ranges (at 25°C)**

Check position				Signal names	Standard coil resistance [ $\Omega$ ]		
A1, A2, A3, B1		B2			VRE-10TP058 VRE-10TP068	VRE-10TP101	
Pin No.	Wiring color	Pin No.	Wiring color				
1	Brown	1	Brown	1	White	114 to 124	108 to 124
2	Red	2	Red		Black		
3	Orange	3	Orange	2	White	114 to 124	108 to 124
4	Yellow	4	Yellow		Black		
5	Green	5	Green	3	White	29 to 49	29 to 49
6	Blue	6	Blue		Black		
7	-	7	Violet	4	White		
8	-	8	Gray		Black		
9	-	-	-	5	White		
10	-	-	-		Black		
11	Shield	9	Shield	-	Shield		
12	-	-	-	-	-		

The above standard coil resistance ranges are referential data to assist wiring disconnection diagnosis and are not product specification values. There may be no wiring disconnection even when the resistance measurement is out of the standard resistance range.

● **Circuit resistance check**

[Measurement method]

Measure resistance at Point A or B using a circuit tester or other appropriate device.

Have Point A connected to measure at Point B.

If the connector is off, identify the line by the wiring color.

[Check details]

Refer to the previous page for the connector pin number.

Check position	Criterion	Check position	Criterion
Between brown and red	The measured value should be in the range of the standard coil resistance. *1	Between brown and orange, green, shield	∞
Between orange and yellow		Between orange and green, shield	
Between green and blue		Between green and shield	
		Between frame and each wire or shield	

\*1: If a check is done at Point B, the measurement value will be [Standard coil resistance + extension sensor cable resistance].

Extension sensor cable resistance value

The resistance value of the NSD special cable is 0.2Ω/m (loop resistance).

The resistance value of the JKPEV-S cable is 0.034Ω/m (loop resistance).

Consider resistance variations due to temperature, which, relative to the standard temperature (25°C), increases 0.4% when the temperature rises 1°C and decreases 0.4% when the temperature falls 1°C.

● **Insulation check**

[Measurement method]

Measure using a 500 VDC insulation tester.

[Check details]

Refer to the previous page for the connector pin number.

Check position	Criterion
Between brown and orange, green, shield	10MΩ or more
Between orange and green, shield	
Between green and shield	
Between frame and each wire or shield	

 **Note**

1. Make sure to disconnect the ABSOCODER sensor from the converter before carrying out insulation checks.
2. If there is a risk that energization may cause damages to the electronic circuits in and around the machine, remove the ABSOCODER sensor from the machine.
3. After completing the checks, short-circuit between the pins to discharge remaining voltage before connecting the ABSOCODER sensor to the converter.



NSD Group

---

**Manufacturer**

**NSD Corporation** 3-31-28, OSU, NAKA-KU, NAGOYA, JAPAN 460-8302

**Distributor**

**NSD Trading Corporation** 3-31-23, OSU, NAKA-KU, NAGOYA, JAPAN 460-8302

Phone: +81-52-261-2352 Facsimile: +81-52-252-0522

URL: [www.nsdcorp.com](http://www.nsdcorp.com) E-mail: [foreign@nsdcorp.com](mailto:foreign@nsdcorp.com)

Copyright©2024 NSD Corporation All rights reserved.