



Eddy current displacement sensor *Easy Gap*



GTA-120 Series

Specifications and Instruction Manual

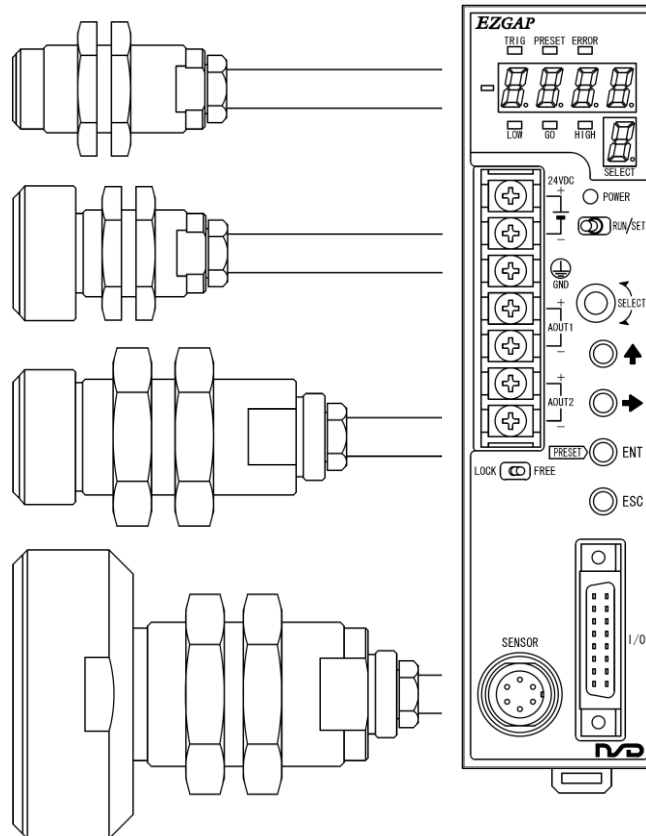

Amplifier

- GTA-120VN
- GTA-120VP
- GTA-120AN
- GTA-120AP

Sensor

- GPS-1718M-[]
- GPS-2818M-[]
- GPS-2824M-[]
- GPS-6030M-[]

Extension cable

- GPS-C01-[]



REVISION HISTORY

The Document No. appears at the upper right of this manual's cover page.

Document No.	Date	Revision Description
G-TB10003400	03, Aug., 2011	1st Edition Japanese document: G-TB10002602
G-TB10003401	17, May, 2012	2nd Edition Japanese document: G-TB10002603
G-TB10003402	10, Dec., 2014	3rd Edition Japanese document: G-TB10002604
G-TB10003403	17, Feb., 2016	4th Edition Japanese document: G-TB10002605
G-TB10003404	27, Mar., 2018	5th Edition Japanese document: G-TB10002606
G-TB10003405	16, Sep., 2020	6th Edition Japanese document: G-TB10002607
G-TB10003406	20, May, 2022	7th Edition Japanese document: G-TB10002608
G-TB10003407	17, Oct, 2023	8th Edition Japanese document: G-TB10002609

CONTENTS

PREPARATION BEFORE USE

INTRODUCTION	1
General Safety Rules.....	1
Checking the Contents of the Shipping Case.....	4
Description in This Document	4
1. OVERVIEW	5
1-1. Overview.....	5
1-2. Principle.....	5
2. NOMENCLATURE	6
3. NOTES ON MOUNTING	7
3-1. Notes on Mounting the Sensor.....	7
3-2. Amplifier Installation Conditions and Precautions.....	9
4. WIRING and CONNECTION	10
4-1. Power Supply Connection.....	10
4-2. Connection between the Sensor and the Amplifier	11
4-3. Analog Output Connection	12
4-4. I/O Connections and Functions.....	13
5. PROCEDURES before OPERATION	15
5-1. Basic Use (From Initial setting to Operation)	15
5-2. Applied Usage	15

BASIC USE

6. WARM-UP OPERATION	16
7. SET the SENSOR TYPE and the CABLE LENGTH	17
8. SET the INTERFERENCE PREVENTION FUNCTION	19
9. ADJUST the SENSOR TEMPERATURE	21
10. SET the DETECTION OBJECT MATERIAL	24
11. PERFORM OFFSET CANCELLATION	25
12. PERFORM CALIBRATION	26
12-1. Description of Calibration	26
12-2. Procedures for Calibration	27
13. OPERATION	30

APPLID USAGE

14. CHANGE the GAP DATA DISPLAY METHOD	32
15. USE the DIGITAL FILTER	33
16. USE the JUDGMENT FUNCTION.....	34
17. USE the MEASURING FUNCTION	37
17-1. Description of the Measuring Function	37
17-2. Example of Measuring Function Operations	39
17-3. Procedures for Setting the Measuring Function	47
18. USE the ANALOG OUTPUT FUNCTION.....	50
18-1. Description of the Analog Output Function	50
18-2. Procedures for Setting the Analog Output Function	52
19. USE the PRESET FUNCTION.....	56
19-1. Description of the Preset Function	56
19-2. Procedures for Setting the Preset Value	57
19-3. Procedures for Executing/Cancelling the Preset	58
20. RUN-OUT REDUCTION	61
20-1. Explanation of the RUN-OUT reduction function	61
20-2. Procedures before the operation by using the RUN-OUT reduction function....	62
20-3. Setting Procedures of the RUN-OUT Reduction Function	63
21. USE the PROGRAM FUNCTION	64
21-1. Description of the Program Function	64
21-2. Procedures for Switching Programs.....	65
22. CHECK the PRESENT SETTING	69
23. LOCK the SETTING	70
24. SPECIAL SETTING AND DISPLAY	71
24-1. Reset All Settings to Factory Setting	71
24-2. Display the Product Version	72
24-3. Display the Sensor Status.....	72

TROUBLESHOOTING

25. TROUBLESHOOTING.....	73
25-1. Warning Message	73
25-2. Error Message	74
25-3. Other Abnormalities	75
25-4. Information Required When Reporting a Problem.....	76
25-5. Warranty Period and Scope	77
25-6. Scope of Service.....	77

SPECIFICATIONS AND DIMENSIONS

26. SPECIFICATIONS	78
26-1. Performance Specification	78
26-2. Sensor Specification	79
26-3. Extension Cable Specification.....	79
26-4. Amplifier Specification.....	80
27. OTHER CHARACTERS AND NOTES	82
27-1. Characters of Detection Objects	82
27-2. RUN-OUT (Notes when detected points change after calibration)	83
27-3. Timing Chart	84
27-4. Abrupt Fluctuations	87
28. OUTER DIMENSIONS	88
28-1. Sensor Dimension	88
28-2. Extension Cable Dimension	90
28-3. Amplifier Dimension	91

APPENDIX

APPENDIX 1. CE MARKING	92
APPENDIX 1-1. Products which comply with EMC directive	92
APPENDIX 1-2. EMC Directives	92
APPENDIX 1-3. EMC Directive and Standards	92
APPENDIX 1-4. Low Voltage Directive.....	92
APPENDIX 1-5. Measures for EMC Compliance and Restriction	93
APPENDIX 2. UL STANDARD	94
APPENDIX 2-1. Products which comply with UL standards	94
APPENDIX 2-2. Installation.....	94
APPENDIX 2-3. External Power Supply.....	94
APPENDIX 2-4. Wiring to the Power Supply and Ground	94
APPENDIX 3 LIST of EACH MODE ITEMS.....	96
APPENDIX 3-1. List of RUN Mode Items	96
APPENDIX 3-2. List of SET Mode Items.....	97

INTRODUCTION

Thank you very much for purchasing our product.

Before operating this product, be sure to carefully read this manual so that you may fully understand the product, safety instructions and precautions.

- Please submit this manual to the operators actually involved in operation.
- Please keep this manual in a handy place.

General Safety Rules



■ Application Limitation

This product is not designed to be used under any situation affecting human life. When you are considering using this product for special purposes such as medical equipment, aerospace equipment, nuclear power control systems, traffic systems, and etc., please consult with NSD.

This product is designed to be used under the industrial environments categorized in Class A device. The supplier and user may be required to take appropriate measures.



■ Signal Words

Safety precautions in this guide are classified into DANGER and CAUTION.



Symbol	Meaning
 DANGER	Incorrect handling may cause a hazardous situation that will result in death or serious injury.
 CAUTION	Incorrect handling may cause a hazardous situation that will result in moderate injury or physical damage.



Instructions accompanied by a symbol  **CAUTION** may also result in serious damage or injury. Be sure to follow the all instructions accompanied by the symbol.

■ Graphic Symbols



Symbol	Meaning
	Indicates prohibited items.
	Indicates items that must be performed to.

1. Handling Precautions



 DANGER	
	<ul style="list-style-type: none"> - Do not touch components inside of the amplifier ; otherwise, it will cause electric shock. - Do not damage the cable by applying excessive load, placing heavy objects on it, or clamping; otherwise, it will cause electric shock or fire.
	<ul style="list-style-type: none"> - Turn the power supply OFF before wiring, transporting, and inspecting; otherwise, it may cause electric shock. - Provide an external safety circuit so that the entire system functions safely even when the amplifier is faulty. - Connect the grounding terminal of the amplifier; otherwise, it may cause electric shock or malfunction.

 CAUTION	
	<ul style="list-style-type: none"> - Do not use the amplifier in the following places; water splashes, the atmosphere of the corrosion, the atmosphere of the flammable vapor, and the side of the combustibility. Doing so may result in fire or the amplifier may become faulty.
	<ul style="list-style-type: none"> - Be sure to use the amplifier and sensor in the environment designated by the general specifications in the manual. Failure to do so may result in electric shock, fire, malfunction or failure. - Be sure to use the specified combination of the sensor, amplifier and extension cable; otherwise, it may cause fire or failure.



2. Storage

 CAUTION	
	<ul style="list-style-type: none"> - Do not store the amplifier in a place exposed to water, or toxic gas and liquid.
	<ul style="list-style-type: none"> - Be sure to store the amplifier in designed temperature and humidity range, and do not expose to direct sunlight. - Be sure to consult with NSD when the amplifier is stored for long periods.



3. Transport



 CAUTION	
	<ul style="list-style-type: none"> - Do not hold the sensor interconnecting cable during transport; otherwise, it will cause injury or failure.

4. Installation



 CAUTION	
	<ul style="list-style-type: none"> - Do not step on the sensor or place heavy objects on the amplifier; otherwise, it will cause injury or failure. - Do not block the exhaust port or allow any foreign matter to enter the amplifier; otherwise, it will cause fire or the amplifier failure.
	<ul style="list-style-type: none"> - Be sure to secure the amplifier and sensor; otherwise, it may cause malfunction, injury, or drop. - Be sure to secure the specified distance between the amplifier and the control panel or other equipments; otherwise, it may cause failure.

5. Wiring



 DANGER	
	<ul style="list-style-type: none">- Be sure to secure screws of the terminal block firmly; otherwise, it will cause fire.- Be sure to mount the terminal cover provided with the amplifier, before supplying the power, starting operation after the installation, and wiring; otherwise, it may cause electric shock.

 CAUTION	
	<ul style="list-style-type: none">- Be sure to keep the sensor cable, control cable, and communication cable at least 300 mm away from the main circuit and power line; otherwise it may cause injury or malfunction.- Be sure to connect all cables correctly; otherwise, it may cause injury or malfunction.- Be sure to firmly connect the external I/O connectors and sensor connectors; otherwise, it may cause incorrect inputs and outputs or injury.

6. Operation

 CAUTION	
	<ul style="list-style-type: none">- Do not approach the machine after instantaneous power failure has been recovered. Doing so may result in injury if the machine starts abruptly
	<ul style="list-style-type: none">- Be sure to check that the power supply specifications are correct; otherwise, it may cause the amplifier failure.- Be sure to provide an external emergency stop circuit so that operation can be stopped with power supply terminated immediately.- Be sure to conduct independent trial runs for the amplifier before mounting the sensor to the machine; otherwise, it may cause injury.- When an error occurs, be sure to eliminate the cause, ensure safety, and reset the error before restarting operation; otherwise, it may cause injury.

7. Maintenance and Inspection

 CAUTION	
	<ul style="list-style-type: none">- Do not disassemble, remodel, or repair the unit; otherwise, it will cause electric shock, fire, and failure.
	<ul style="list-style-type: none">- The capacitor of the power line deteriorates through prolonged use. We recommended that the capacitor be replaced every five years to prevent secondary damage.

8. Disposal

 CAUTION	
	<ul style="list-style-type: none">- Be sure to handle the amplifier and sensor as industrial waste while disposing of it.

Checking the Contents of the Shipping Case

Open the packing case, and verify that all items are present.

(1) Sensor

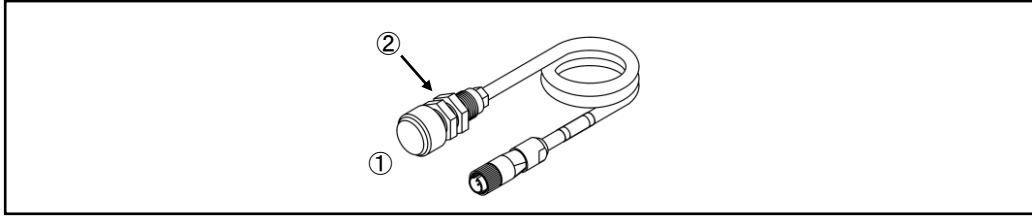

- ① Sensor 1 unit
- ② Hexagonal nut 2 pieces

(2) Extension cable

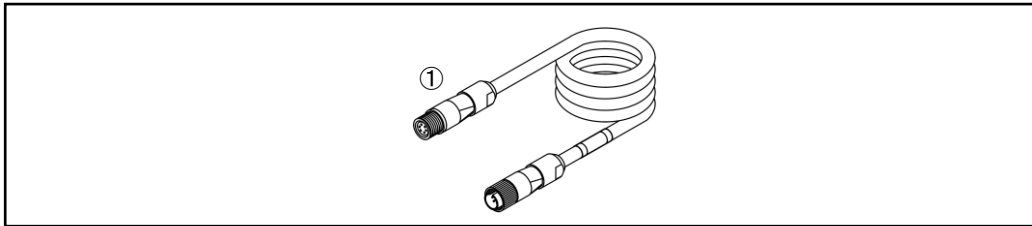

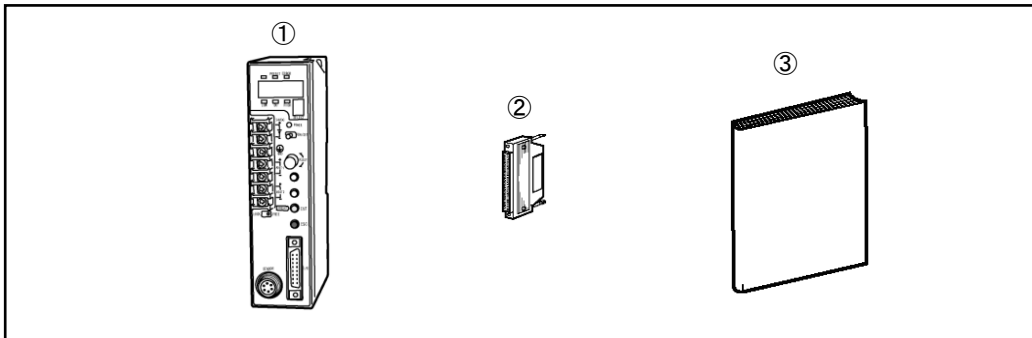

- ① Extension cable 1 piece

(3) Amplifier



- ① Amplifier 1 unit
- ② I/O connector 1 piece Note: These parts are shipped before assembled.
- (Connector: FCN-361J016-AU / N361J016AU Cover: FCN-360C016-B / N360C016B
Manufacturer: FUJITSU COMPONENT LIMITED / OTAX CO.,LTD.)
- ③ Specifications and Instruction Manual 1 piece

Description in This Document

Code	Meaning of code
 ATTN	Calls attention to the reader.
 POINT	Indicates a point good to know.
 REF.	Shows a page describing related contents.

1. OVERVIEW

1-1. Overview

This is an eddy current displacement sensor which measures the gap (distance) from the sensor head to the metal detection object in a non-contacting method. The major characteristics of this product are as follows:

- The inner part of the sensor consists of only a coil and a core (magnetic material), which has a great environment resistance.
- The amplifier can be used in combination with different kinds of the sensor or detection object material (iron, stainless steel, and aluminum).
- The sensor, the amplifier, and the extension cable are compatible with each other. This enables easy maintenance. (Reset of the amplifier is necessary.)
- High-level digital processing and the calibration function achieve high-precision linearity.
- The sensor head temperature is measured to automatically adjust the errors in gap data changes due to the temperature drift.
- The sensor cable can be extended up to 20 m.
- Each connector is plated with gold, which gives resistance to improper contact.
- The amplifier supports the hydrogen sulfide gas resistant model which is resistant to gas, moisture, and dust.
- The sensor supports the hydrogen sulfide gas resistant model which is resistant to gas.

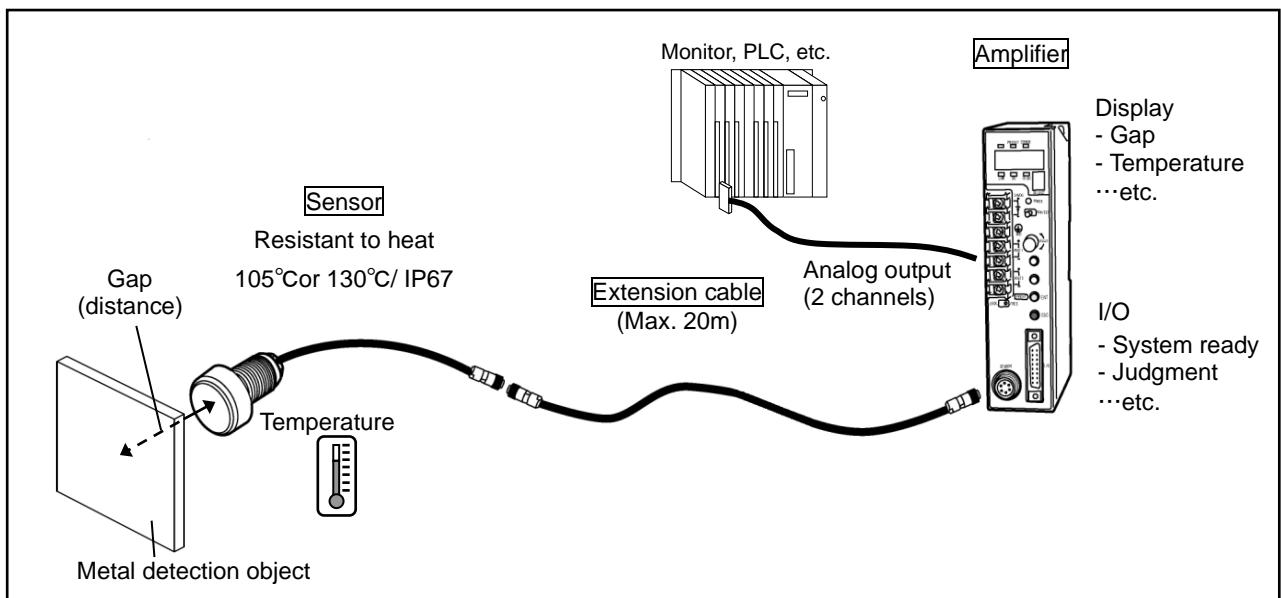

1-2. Principle

When a metal is placed close to the sensor head while an alternating magnetic field is generated in it, an eddy current occurs on the metal surface.

The eddy current becomes larger when the gap with the metal is smaller, and becomes smaller when the gap is larger, thus changes the sensor impedance. The amplifier detects the change in the impedance to measure the gap. At the same time, by detecting the DC resistance of the sensor, it also measures the sensor head temperature.

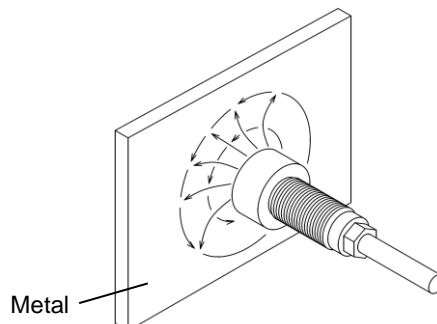

2. NOMENCLATURE

Data display part

Displays data of gaps, temperature, and various settings. A minus (-) sign lights up when the value is a negative one. (Red)

Judgment display part

Lights up any of LOW, GO or HIGH depending on the judgment result. (Yellow)

Power supply terminal block

Connects 24V DC power supply and ground. See "4-1. Power Supply Connection" for details.

Analog output terminal block

Outputs gap data and temperature data by two channels.
(Analog output 1: AOUT1 terminal block)
(Analog output 2: AOUT2 terminal block)
See "4-3. Analog Output Connection" for details.

Sensor connector

Connects the sensor.
See "4-2. Connection between the Sensor and the Amplifier" for details.

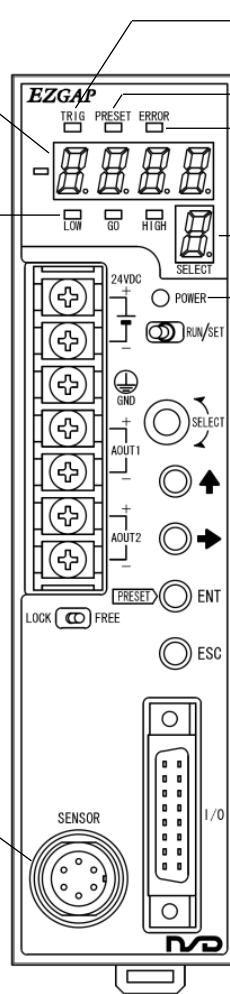

Measuring trigger display part

Blinks once when the measured data is updated. (Yellow)

Preset display part

Lights up when the preset is executed. (Yellow)

Error display part

Lights up when an error occurs. (Red)

Select No. display part

Displays the present select No. in hexadecimal from 0 to F. A function is allocated to each select No. (Green)

Power ON display part

Lights up when the power supply is turned ON. (Green)

Operating switch

Changes displays and settings. See the table below for details of each switch function.

I/O connector

Connects the input/output signals to output the system ready and input the preset. See "4-4. I/O Connections and Functions" for details.

Operating Switches

Switch	Name	Function
	RUN/SET switch	Switches between the RUN mode (operation) and the SET mode (setting). - RUN (left side): Switch to the RUN mode for operation and display of gap data and temperature data. - SET (right side): Switch to the SET mode for setting.
	SELECT switch	Switches the select number. - The select number is displayed in the select No. display part in hexadecimal from 0 to F. - A function is allocated to each select No. (Note that the functions differ by mode, RUN or SET.)
	↑ switch	Switches the setting or changes the setting value incrementally during setting. - When the switch is pressed once, the value increases by one; when it is held down for a while, the value increases continuously. - When the value reaches the upper limit value, the lower limit value follows.
	➡ switch	Moves the digit to change the setting value during setting. - When the switch is pressed once, the digit moves to the right by one; when it is held down for a while, the digit moves continuously. - This switch is also used to check the present setting.
	ENT switch	Used to start setting or determine setting values in the SET mode. - When the switch is held down for a while, setting is started. (Except for special operations such as program copying.) - When the switch is pressed once, the setting is determined and the next setting is started.
	PRESET switch	Used to turn on and off the preset in the RUN mode.
	ESC switch	Discontinues operations during setting, or returns to the previous setting.
	LOCK/FREE switch	Switches between the lock state and the free state. - LOCK (left side): In the lock state, settings cannot be changed using switches. However, the preset input signal and the program enable signal are accepted only in the lock state and the RUN mode. - FREE (right side): Settings can be changed using switches.

3. NOTES ON MOUNTING

3-1. Notes on Mounting the Sensor

■ When the sensor is mounted to the touch roller etc.

In order to use the sensor by attaching it to the touch roller etc., mount the sensor in a manner that the set gap (distance between the detection surface of the sensor and the touch roller) is minimized. (Recommended gap: 1.5 mm or below) By reducing the set gap, the detectable range is broadened, reducing temperature drifts and abrupt fluctuations.

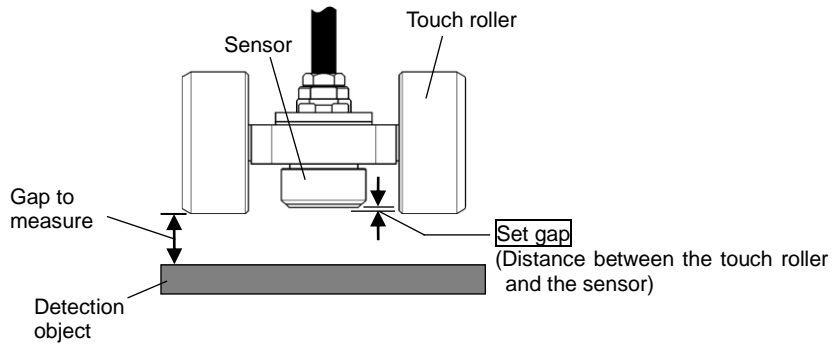

POINT

- Mount the sensor in a manner that “(Set gap + Gap to measure) ≤ (Rated detection range)” is secured.
- The recommended set gap is 1.5 mm or below.
- Decreasing the set gap enlarges the detectable range. It is effective for reducing temperature drifts and abrupt fluctuations.

■ When an elongated or a rolled detection object is used

In order to use an elongated or a rolled detection object, mount the sensor with its width across flats*1 parallel with the longer side of the detection object as shown in the drawing below. In doing so the sensor performance may improve. This is particularly effective when one side of the detection object is shorter than that of the standard detection object.

*1: The width across flats is found at the rear end of the sensor.

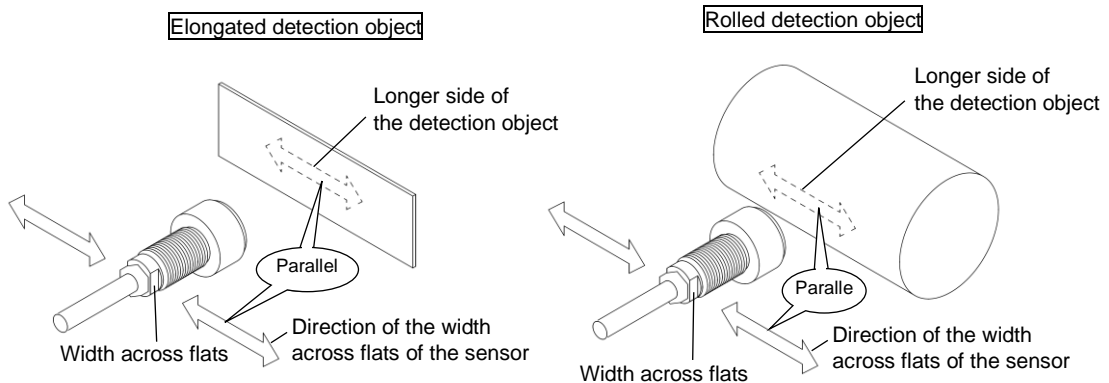

- See also “27-1. Characters of Detection Objects” for more details of the detection objects.

■ When more than one sensor is used simultaneously in proximity

When more than one sensor is used simultaneously in proximity, the gap data fluctuates by mutual interference of the sensors. When mutual interference causes a problem, set the interference prevention function. The effects of mutual interference can be further reduced when adjacent sensors are mounted with their width across flats*1 crossed each other as shown in the drawing below.

*1: The width across flats is found at the rear end of the sensor.

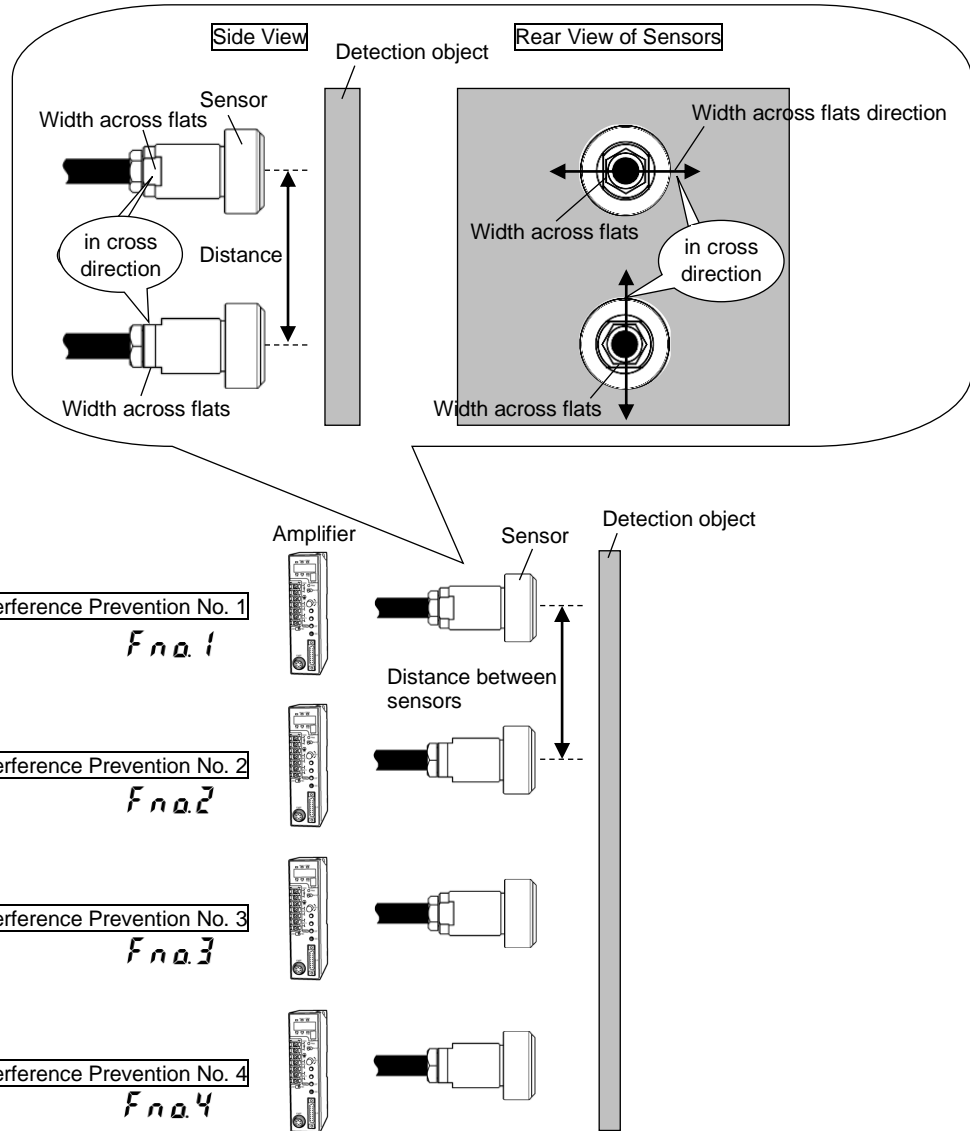

- See "8. SET the INTERFERENCE PREVENTION FUNCTION" for the details of the interference prevention function.

3-2. Amplifier Installation Conditions and Precautions

When installing the amplifier, the following conditions and precautions should be observed.

- Installation Site

- (1) Avoid sites where the unit is exposed to direct sunlight.
- (2) The ambient temperature should never exceed a 0 to 55°C range.
- (3) The ambient humidity should never exceed a 20 to 90% RH range.
- (4) Do not install the unit in areas where condensation is likely to occur (high humidity with extreme temperature changes).
- (5) Avoid sites where dust is excessive.
- (6) Do not install in areas with an excessive amount of salt and/or metal chips.
- (7) Do not install in areas where flammable and / or corrosive gases are present.
- (8) Avoid areas where splashing water, oil or chemicals are likely to occur.
- (9) Avoid areas where vibration and shocks are excessive.

-Installation cautions

- (1) Install inside the control cabinet.
- (2) Install in a vertical direction so that the characters are visible.
- (3) If a DIN rail mounting format is used, insert until the latch mechanism catches with an audible click.
Secure between end plates at both sides.
- (4) In high vibration areas, secure tightly with two-M4 screws.
- (5) Install as far from high voltage lines and power lines as possible in order to minimize noise influences.
- (6) Allow 100mm or more space at the amplifier's front side for plugging in and unplugging the connector.
- (7) Peripheral components should be arranged so as not to obstruct amplifier installation, removal, and connector plugging/unplugging.
- (8) Space out 50mm or more between the converter and peripheral components in order not to obstruct the amplifier's heat dissipation.

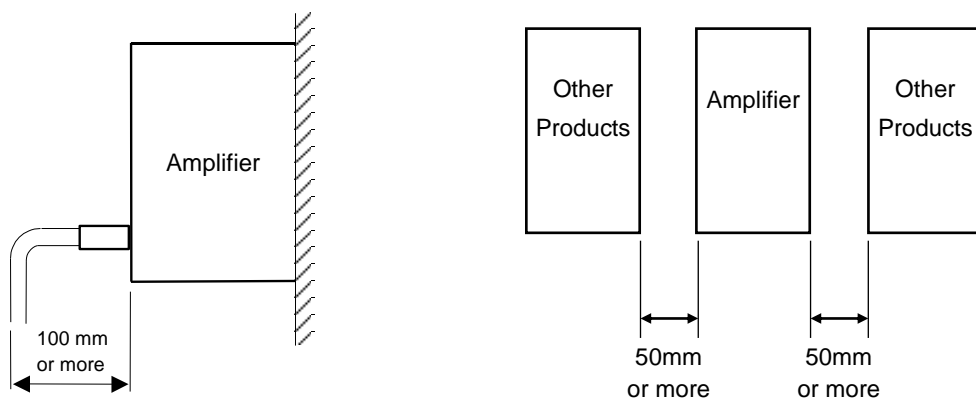

4. WIRING and CONNECTION

4-1. Power Supply Connection

(1) Power supply

- The power supply should be isolated from the commercial power supply.
- Choose the power supply capacity which is more than twice the power consumption of the amplifier.
The power consumption of the amplifier is 10W or less.

(2) Wiring

- Twist the power cable for preventing noises.
- The power cable should be as thick as possible to minimize voltage drops.

(3) Crimping terminal

- Use M3 size crimp lug terminal.
- The terminal block tightening torque is $0.6\text{N}\cdot\text{m}$ ($5.1\text{Lb}\cdot\text{In}$).
- After the connection, a terminal block cover should be placed to ensure safety.

(4) Ground

- The amplifier should be grounded (ground resistance of 100ohm or less) to prevent electrical shocks.

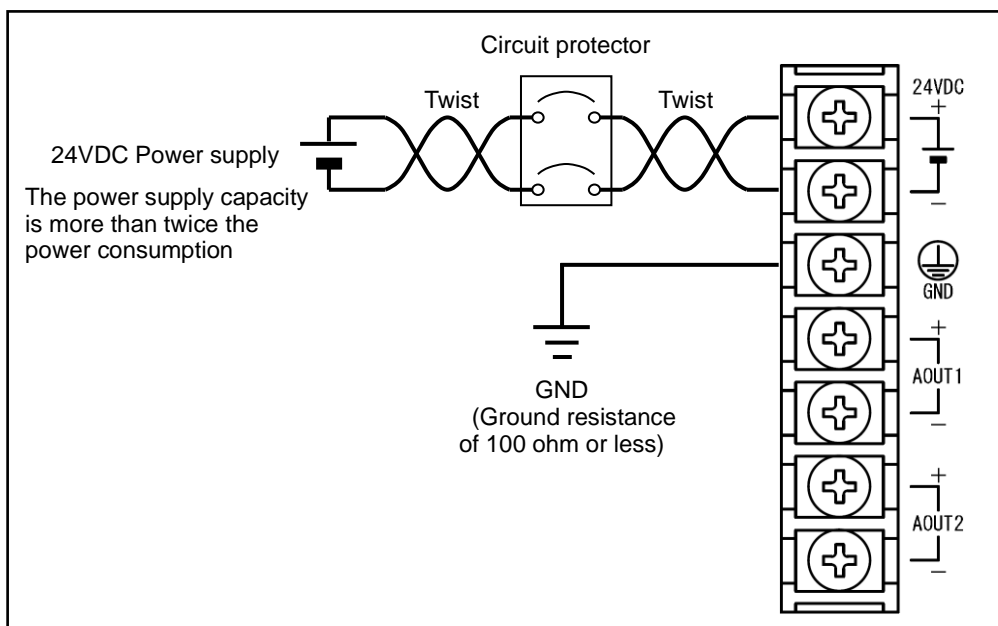

4-2. Connection between the Sensor and the Amplifier

(1) Connecting the sensor to the amplifier

Connect the sensor and the extension cable connector securely without slack.

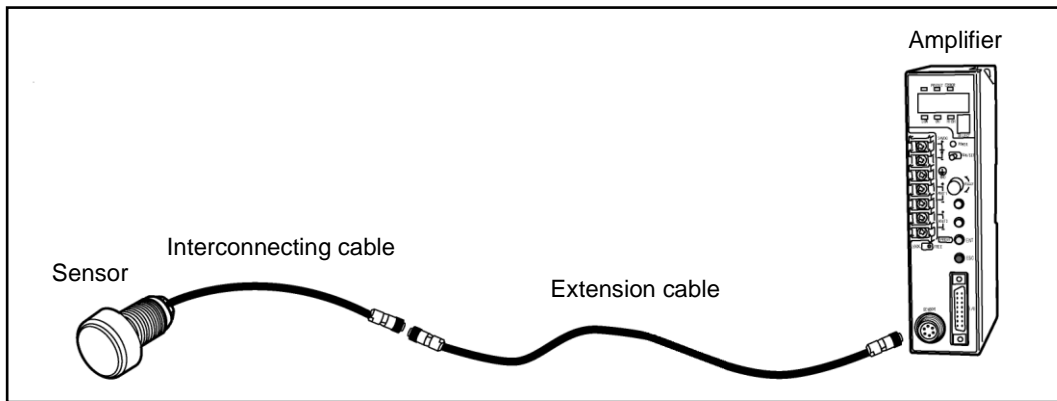

(2) Wiring precautions

- The sensor cable should be clamped as shown in the right figure to prevent excessive tension from being applied to the cable connectors.

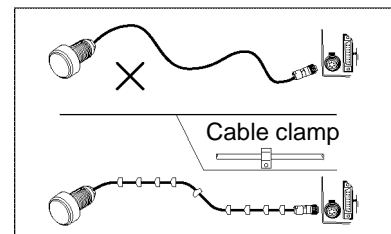

- The sensor cable should be located at least 300mm away from power lines and other lines which generate a high level of electrical noise.

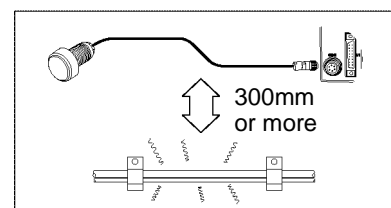

- Do not bend or vibrate the sensor cable continuously, because it may be disconnected.

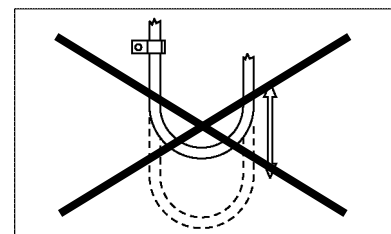

4-3. Analog Output Connection

(1) Terminal names and functions

The analog output can be connected to the terminal block (in M3 size) on the front of the amplifier by two output channels. The circuit of the analog output part is isolated with a photo-coupler from other circuits. However, the channels are not isolated from each other. (Negative terminals are common.)

Name		Function
AOUT1	+	Positive terminal for Analog Output 1.
	-	Negative terminal (0V) for Analog Output 1.
AOUT2	+	Positive terminal for Analog Output 2.
	-	Negative terminal (0V) for Analog Output 2.

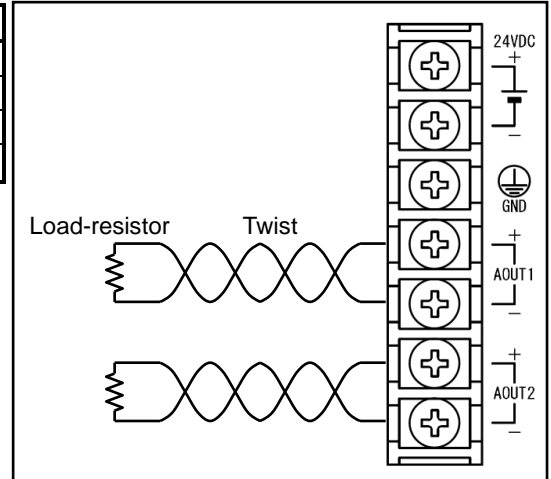

(2) Wiring

- Twist the power cable for preventing noises.
- The power cable should be as thick as possible to minimize voltage drops.

(3) Crimping terminal

- Use M3 size crimp lug terminal.
- The terminal block tightening torque is $0.6\text{N}\cdot\text{m}$ ($5.1\text{Lb}\cdot\text{In}$).
- After the connection, a terminal block cover should be placed to ensure safety.

(4) Internal circuit and connection diagram

■ With GTA-120V[] (Voltage output models)

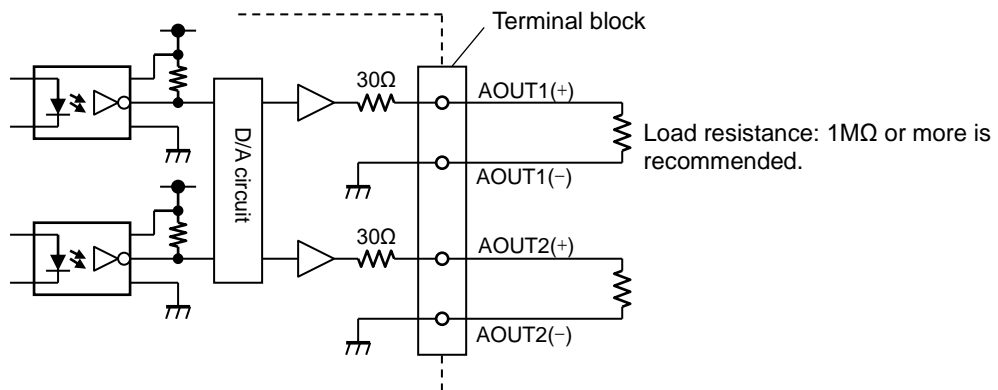

■ With GTA-120A[] (Current output models)

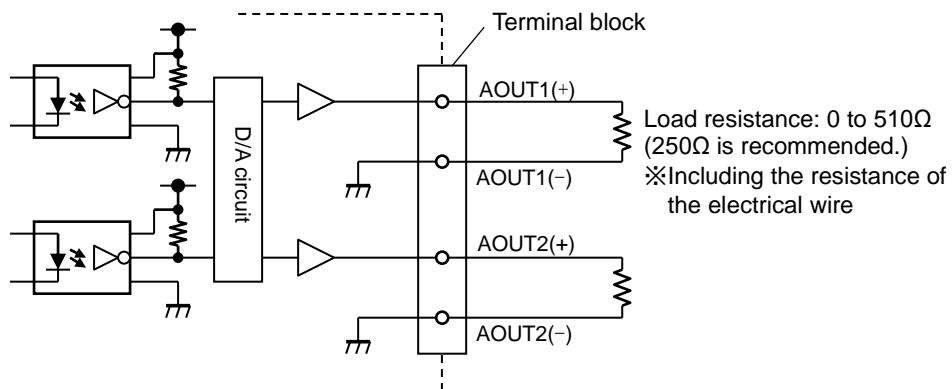

REF

- See "18. USE the ANALOG OUTPUT FUNCTION" for details of the analog output functions.

4-4. I/O Connections and Functions

(1) Connector pin position and signal name

■ With GTA-120[JN (Sink models)

Pin No.	Code	I/O	Pin No.	Code	I/O
A1	24V COM	I	B1	TRIG	I
A2	RES	I	B2	PRESET	I
A3	PRG0	I	B3	PRG1	I
A4	PRGEN	I	B4	NOR	O
A5	RUN	O	B5	LOW	O
A6	GO	O	B6	HIGH	O
A7	STROBE	O	B7	No connection	O
A8	No connection	O	B8	0V COM	I

■ With GTA-120[JP (Source models)

Pin No.	Code	I/O	Pin No.	Code	I/O
A1	0V COM	I	B1	TRIG	I
A2	RES	I	B2	PRESET	I
A3	PRG0	I	B3	PRG1	I
A4	PRGEN	I	B4	NOR	O
A5	RUN	O	B5	LOW	O
A6	GO	O	B6	HIGH	O
A7	STROBE	O	B7	No connection	O
A8	No connection	O	B8	24V COM	I

(2) Accessory connector

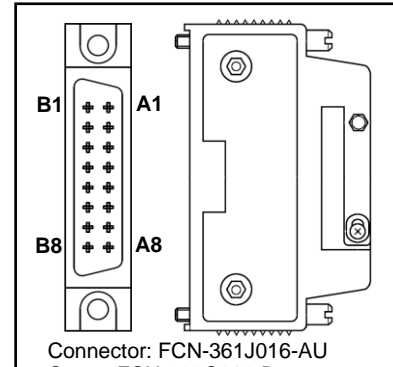

Connector: FCN-361J016-AU
 Cover: FCN-360C016-B
 Nos. of pin: 16 pin
 Manufacturer: FUJITSU COMPONENT LIMITED
 or
 Connector: N361J016AU
 Cover: N360C016B
 Nos. of pin: 16 pin
 Manufacturer: OTAX CO.,LTD.



Note that the pin Nos. to connect to 24V COM and 0V COM are different between the Sink models and the Source models.

(3) Functions of each signal

I/O	Code	Signal name	Function																						
I	24V COM	24V common	24V common.																						
	0V COM	0V common	0V common.																						
	TRIG	External measuring trigger	Triggers measured data when the external trigger is selected at the trigger setting for the measuring function. Trigger is activated at an OFF to ON transition (ON edge).																						
	RES	Measuring reset	Resets measured data of the measuring function. Measured data is reset when the signal is ON.																						
	PRESET	Preset	Executes the preset. (The preset execution cannot be cancelled by input signals.) The preset is executed at an OFF to ON transition (ON edge).																						
	PRG0	Program setting 0	Switches the program. Selects the program No. using PRG0 and PRG1, and enables the program using PRGEN. <table border="1"> <thead> <tr> <th>PRG0</th> <th>PRG1</th> <th>PRGEN</th> <th>Function</th> </tr> </thead> <tbody> <tr> <td>OFF</td> <td>OFF</td> <td rowspan="3">OFF→ON (ON edge)</td> <td>Switches to Program 1.</td> </tr> <tr> <td>ON</td> <td>OFF</td> <td>Switches to Program 2.</td> </tr> <tr> <td>OFF</td> <td>ON</td> <td>Switches to Program 3.</td> </tr> <tr> <td>ON</td> <td>ON</td> <td></td> <td>Switches to Program 4.</td> </tr> <tr> <td>Don't care</td> <td>Don't care</td> <td>ON→OFF (OFF edge)</td> <td>No function</td> </tr> </tbody> </table>	PRG0	PRG1	PRGEN	Function	OFF	OFF	OFF→ON (ON edge)	Switches to Program 1.	ON	OFF	Switches to Program 2.	OFF	ON	Switches to Program 3.	ON	ON		Switches to Program 4.	Don't care	Don't care	ON→OFF (OFF edge)	No function
	PRG0	PRG1		PRGEN	Function																				
	OFF	OFF		OFF→ON (ON edge)	Switches to Program 1.																				
ON	OFF	Switches to Program 2.																							
OFF	ON	Switches to Program 3.																							
ON	ON		Switches to Program 4.																						
Don't care	Don't care	ON→OFF (OFF edge)	No function																						
PRG1	Program setting 1																								
PRGEN	Program enable																								
O	NOR	System ready	Kept ON as long as the system is operating properly. Turns off when a sensor disconnected error or other various errors occur(s).																						
	RUN	RUN mode	Kept ON during the RUN mode. Kept OFF during the SET mode. Even during the RUM mode, however, when the preset or the program enable is executed, the RUN mode is kept OFF until the internal processing is completed.																						
	LOW	Judgment LOW	Turned on when the judgment result is LOW.																						
	GO	Judgment GO	Turned on when the judgment result is GO.																						
	HIGH	Judgment HIGH	Turned on when the judgment result is HIGH.																						
	STROBE	Measuring strobe	When External trigger is set	Turned on for a certain period when measured data is updated.																					
		When Internal trigger is set	Turned on during sampling measured data																						
		When Cycle trigger is set	Turned on for a certain period when measured data is updated.																						

(4) Internal circuit and connection diagram

■ With GTA-120[JN (Sink models)

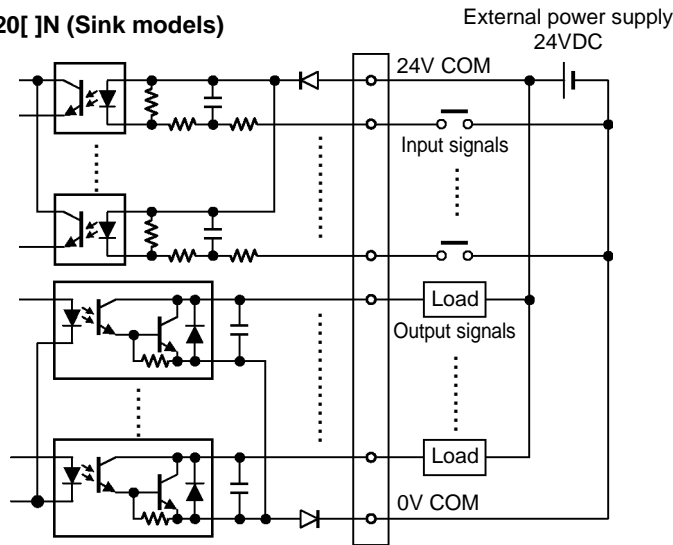

■ With GTA-120[JP (Source models)

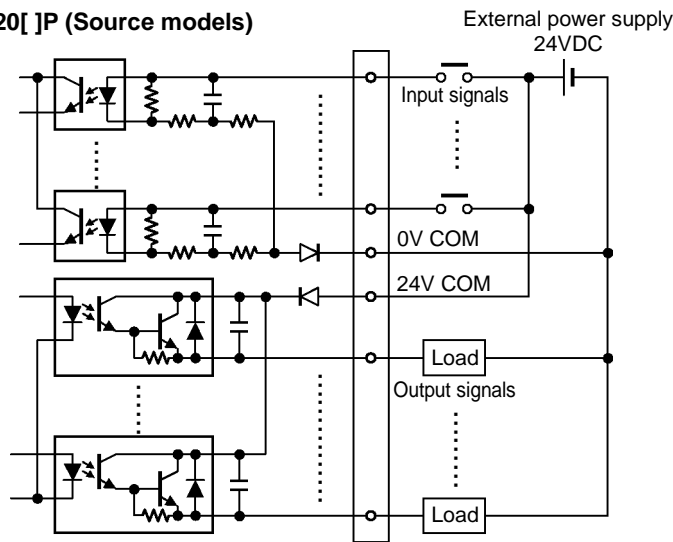

- Relations between output signals and voltage levels are as shown below.



POINT

Models	Output logic	Output signal	Voltage level
GTA-120[JN (Sink models)	Negative logic	ON	L level
		OFF	H level
GTA-120[JP (Source models)	Positive logic	ON	H level
		OFF	L level

- Use the system without connecting wires when input signals are not used. This prevents malfunctions.

- The preset input signal and the program enable input signal are accepted only in the lock state and the RUN mode. When the preset input signal or the program enable input signal is switched from OFF to ON in other case, a warning **FrEE** is displayed.



ATTN

- When the preset input signal and the program enable input signal are accepted, the RUN mode output is kept OFF until the internal processing is completed. Another preset input signal or program enable input signal will not be accepted until the internal processing is completed.

- The preset input signal can only execute the preset. To cancel the preset, operate the switches on the panel.

- PRGEN is not accepted when the program number selected using PRG0 and PRG1 is the same as the present program number.

- When the preset input signal and the program enable input signal are input simultaneously, the preset input signal is prioritized.

- When the I/O connector or the external power supply for the I/O is disconnected while the input signal is ON, an unexpected input may be made.



REF.

- See "26-4. Amplifier Specifications" for performance specification of I/O.

5. PROCEDURES before OPERATION

5-1. Basic Use (From Initial setting to Operation)

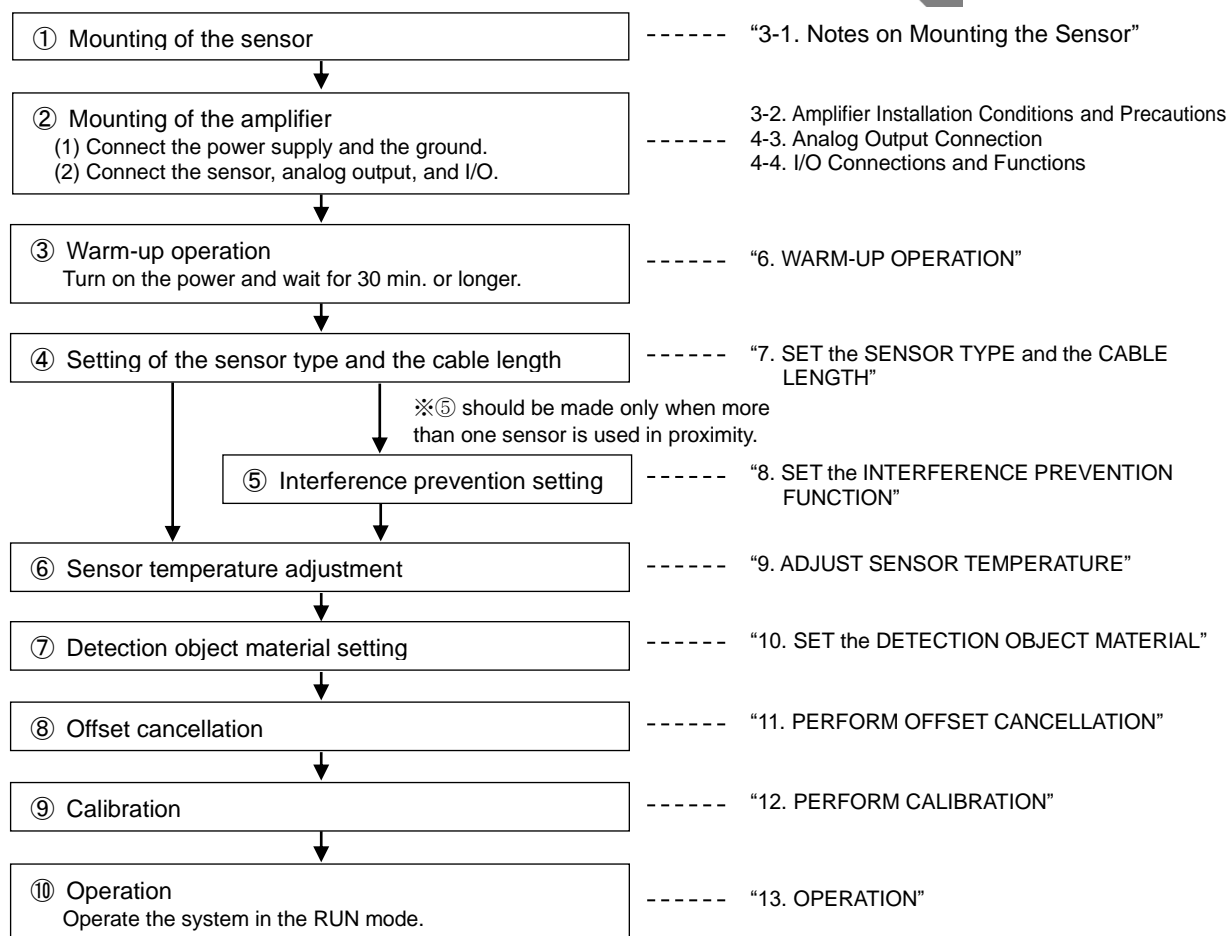

※⑤ should be made only when more than one sensor is used in proximity.



- Make sure to make settings in the above order.
- When the setting is changed somewhere from ④ to ⑨, make sure to perform the subsequent settings again. (For example, when ⑦ was changed, ⑧ and ⑨ must be set again.)

5-2. Applied Usage



Change the update cycle or the decimal point position in the gap display.	-----	14. CHANGE the GAP DATA DISPLAY METHOD
Change the frequency of the digital filter.	-----	15. USE the DIGITAL FILTER FUNCTION
Use the judgment function.	-----	16. USE the JUDGMENT FUNCTION
Use the measuring function.	-----	17. USE the MEASURING FUNCTION
Perform scaling of analog output. Output temperature data, measured data, and vibration amplification data.	-----	18. USE the ANALOG OUTPUT FUNCTION
Preset gaps with any values	-----	19. USE the PRESET FUNCTION
Reduce the fluctuation of the gap data because of RUN-OUT	-----	20. RUN-OUT REDUCTION
Switch or copy the setting values using the program function.	-----	21. USE the PROGRAM FUNCTION

6. WARM-UP OPERATION

The gap data is not stable when the power supply has just been turned on. This is caused by self-heat generated by the sensor and the amplifier. Make sure to perform warm-up operation for at least 30 minutes after the power is turned on. As long as the sensor temperature changes, perform warm-up operation until it is saturated. Effects of temperature drifts can be reduced as the temperature when the offset cancellation and calibration are performed is closer to the operating temperature.



- Perform warm-up operation after connecting the sensor and the amplifier.
 - Perform warm-up operation when the system is installed in an operating state.
-



- Effects of temperature drifts can be reduced as the temperature when the offset cancellation and calibration are performed is closer to the operating temperature.
-

7. SET the SENSOR TYPE and the CABLE LENGTH

A sensor, an interconnecting cable and an extension cable are connected to the amplifier. Set the sensor type, the interconnecting cable length, and the extension cable type and length. Check the models and set them correctly. When they are used in an incorrect setting, linearity errors and temperature drifts may deteriorate.

■ Description of sensor models

Example: **GPS-2818M-0.5**

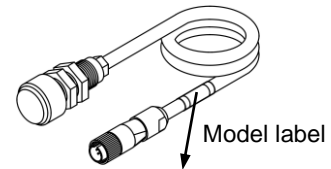
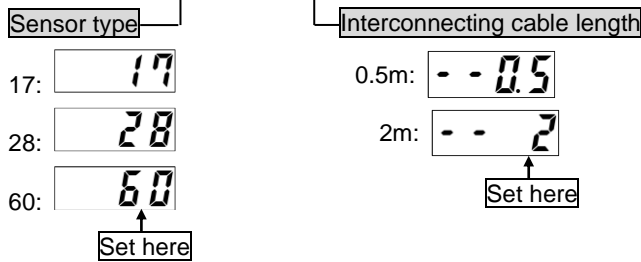

MODEL
Model of the sensor
SER.
CODE

■ Description of extension cable models

Example: **GPS-C01-20**

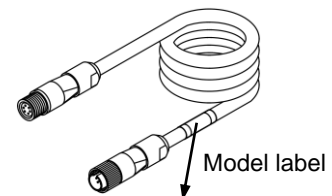
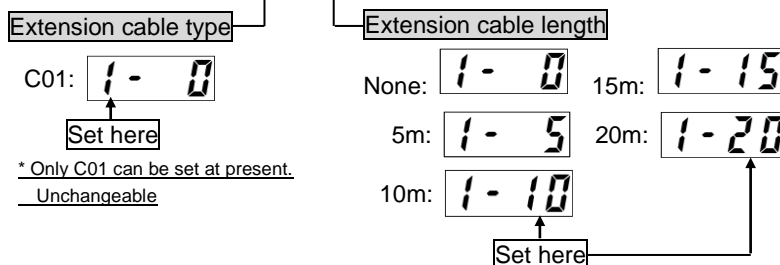

MODEL
Model of the extension cable



- Check the models and set them correctly. When they are used in an incorrect setting, linearity errors and temperature drifts may deteriorate.
- The factory setting is "Sensor type: 28; Interconnecting cable length: 2 m; Extension cable length: 0 (No cable)."

■ Procedures for sensor model and cable length setting

- 1** Set the select No. at "9" in the SET mode.
- "tyPE" is displayed.



- 2** Hold down **[ENT]** for about 1 second to start the setting.

- 3** Select the sensor type.
- Press **↑** to change the setting value.

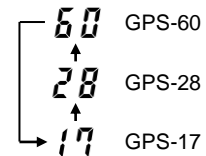
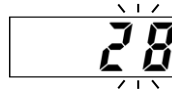

- 4** Press **[ENT]**. The display blinks rapidly.
Press **[ENT]** again to start the next setting.

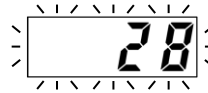

- 5** Select the interconnecting cable length.
- Press **↑** to change the setting value.

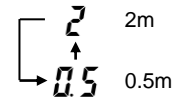
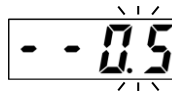

- 6** Press **[ENT]**. The display blinks rapidly.
Press **[ENT]** again to start the next setting.

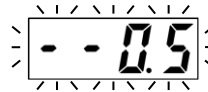

- 7** Select the extension cable length.
- Press **↑** to change the setting value.
- The extension cable type is currently fixed at "1."

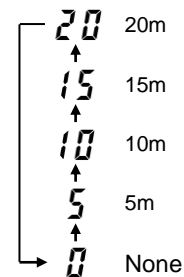
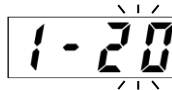

- 8** Press **[ENT]**. The display blinks rapidly.
Press **[ENT]** again to complete the setting.
- When the setting is completed, the display returns to 1. **[End]**

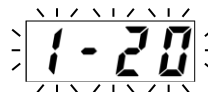

8. SET the INTERFERENCE PREVENTION FUNCTION

(This setting is necessary only when more than one sensor is used in proximity.)

The interference prevention function prevents gap data fluctuations caused by mutual interference when more than one sensor is used simultaneously in proximity. By changing the sensor frequency in each sensor, Effects of mutual interference are reduced.

To set this function, set the interference prevention numbers in each amplifier (up to four amplifiers).

In addition, the effects of mutual interference can be further reduced when adjacent sensors are mounted with their width across flats^{*1} crossed each other. See “3-1. Notes on Mounting the Sensor” for details of mounting.

The table below shows the reference values for accessible distance between sensors to measure stable gap data at a rated detection range. The accessible distance between sensors varies depending on the digital filter setting. The distance between sensors can be set shorter as the cutoff frequency of the digital filter is set lower.

*1: The width across flats is found at the rear end of the sensor.

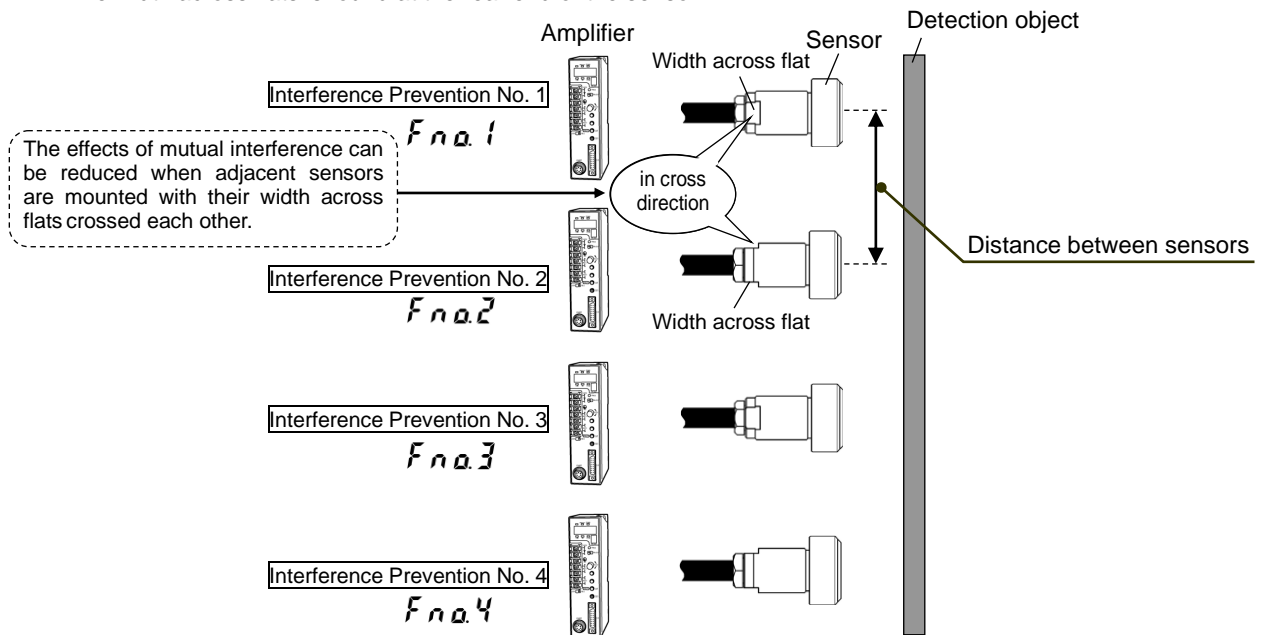

■ Accessible distance between sensors (reference values)

Sensor type	Digital filter cutoff frequency	Without the interference prevention function	With the interference prevention function	
				When mounted in a cross direction ※2
GPS-17 [I I] - []	62Hz or higher	600mm	300mm	50mm
	30Hz or lower		50mm	
GPS-28 [I I] - []	62Hz or higher	1000mm	500mm	100mm
	30Hz or lower		100mm	
GPS-60 [I I] - []	62Hz or higher	2000mm	1000mm	200mm
	30Hz or lower		200mm	

※2: When adjacent sensors are mounted with their width across flats crossed each other



- The effects of mutual interference can be further reduced when adjacent sensors are mounted with their width across flats crossed each other. See “3-1. Notes on Mounting the Sensor” for details.
- The distance between sensors may be shorter than those in the above table when the gap to measure is smaller than the rated detection range.
- It is more effective to set the interference prevention numbers in the ascending order.
Ex.) When two sensors are used simultaneously, set the interference prevention Nos. 1 and 2. (In this case, Nos. 3 and 4 should not be used.)



- When the interference prevention setting was changed, make sure to perform offset cancellation and calibration again.



- See “15. USE the DIGITAL FILTER” for details of the digital filter.

■ Procedures for interference prevention setting

- 1** Set the select No. at "A" in the SET mode.
- " Fno.□ " is displayed.



- 2** Hold down **ENT** for about 1 second to start the setting.

- 3** Select the interference prevention number.
- Press **↑** to change the setting value.

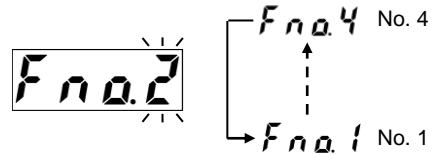

- 4** Press **ENT**. The display blinks rapidly.
Press **ENT** again to complete the setting.
- When the setting is completed, the display returns to 1. **[End]**

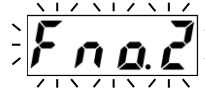

9. ADJUST the SENSOR TEMPERATURE

This system can measure the sensor (head) temperature in a simple manner. The sensor temperature is measured by detecting the DC resistance of the internal sensor. It may include some errors because the DC resistance varies for each sensor. The sensor temperature adjustment function corrects these errors, and execute either ways described below.

- (1) Adjustment by the value written on the sensor model label (Most commonly please conduct this method.)
- (2) Adjustment by measuring the sensor temperature

Most commonly please conduct (1) method. If the label is removed and (1) method cannot be conducted, adjust the temperature by (2) method. For the operation details, refer to each section.

(1) Adjustment by the value written on the sensor model label

Input the adjusted value of the sensor temperature (ΔT) written on the sensor model label to the amplifier.

■ Procedures for sensor temperature adjustment

- 1 Check "adjusted value of the sensor temperature (ΔT)" written on "model label" which is attached on the sensor interconnecting cable.

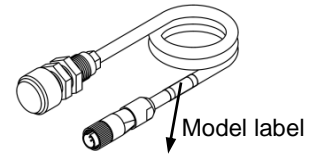

In this example
" $\Delta T = +4^{\circ}\text{C}$ "

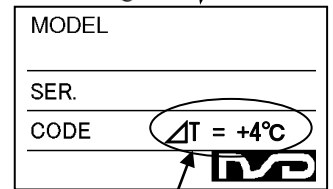

Adjusted value of the sensor temperature

- 2 Set the select No. at "b" in the SET mode.
- "tEMP" is displayed.



- 3 Hold down **[ENT]** for about 1 second to start the setting.

- 4 Set the adjusted value of the sensor temperature (ΔT)
 - Press **▲** to change the setting value.
 - "P" means plus (+).
 - Selectable from -12 to +12.

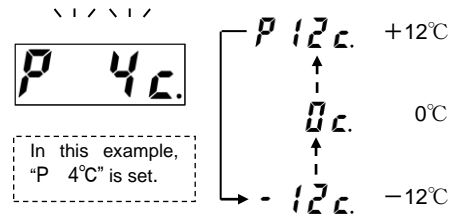

- 5 Press **[ENT]**. The display blinks rapidly.
Press **[ENT]** again, and the setting is completed.
[END]



ATTN

- If the sensor model label is removed and adjustment value is not found, conduct "9-(2) Adjustment by measuring the sensor temperature".
- Do not use the sensor temperature for system control etc. as this is measured in a simple manner.
- When the temperature adjustment was changed, make sure to perform offset cancellation and calibration again.

POINT

- Precision after temperature adjustment is about $\pm 3^{\circ}\text{C}$.
- Temperature adjustment of the gap data functions even when the sensor temperature is not adjusted. However, the temperature is corrected more precisely when the sensor temperature is adjusted.

(2) Adjustment by measuring the sensor temperature

In doing so, users need to directly measure the sensor temperature using a thermometer etc. and set the adjusted values in each amplifier.

The adjusted values are the difference between "Temperature displayed in the amplifier without adjustment (T1)" and "Actual temperature measured by the user (T2)," which are calculated by the following formula:

"Adjusted value of the sensor temperature (ΔT)" = "Actual temperature measured by the user (T2)" – "Temperature displayed in the amplifier without adjustment (T1)"

The adjusted values are fixed for each sensor; therefore, even when the amplifier is replaced or the setting is initialized, adjustment can be made immediately just by entering the adjusted values once they are noted down. The factory setting is 0°C (No adjustment).

Temperature adjustment of the gap data functions even when the sensor temperature is not adjusted. However, the temperature is corrected more precisely when the sensor temperature is adjusted.



- Most commonly conduct "9-(1) Adjustment by the value written on the sensor model label".
- Do not use the sensor temperature for system control etc. as this is measured in a simple manner.
- Adjust the sensor temperature when it is saturated fully.
- When the sensor temperature cannot be measured directly, measure the ambient temperature.
- When the temperature adjustment was changed, make sure to perform offset cancellation and calibration again.



- Precision after temperature adjustment is about $\pm 3^{\circ}\text{C}$.
- Temperature adjustment of the gap data functions even when the sensor temperature is not adjusted. However, the temperature is corrected more precisely when the sensor temperature is adjusted.
- Once the adjusted values are noted down for each sensor, adjustment can be made immediately. Just enter the adjusted values even when the amplifier is replaced or the setting is initialized. (No need to use a thermometer every time)
- With the program function, the adjusted temperature values and calibration settings can be backed up. The program number can also be switched to enable each sensor setting. See "21. USE the PROGRAM FUNCTION" for details of the program function.

■ Procedures for sensor temperature adjustment

1 Saturate the sensor temperature fully.

2 Set the select No. at "b" in the SET mode.
- "tEMP" is displayed.



3 Hold down **[ENT]** for about 1 second to start the setting.

4 Set the adjusted value of the sensor temperature (ΔT) at "0°C"
(No adjustment) .
- Press **▲** to change the setting value.
- The factory setting is "0°C".

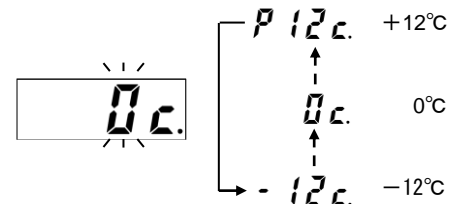

5 Press **[ENT]**. The display blinks rapidly
Press **[ENT]** again. The sensor temperature adjusted value is determined "0°C" (No adjustment).



(Continued on Next Page)

- 6** Set the select No. at "1" in the RUN mode.
 Note down the sensor temperature of the amplifier at the time of no adjustment (T1).

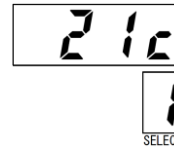

In this example, note "T1=21°C".

T1=21°C
 T2=
 Δ T=

- 7** Measure the sensor temperature (T2) using a thermometer or a thermocouple and note it down.
 - When the sensor temperature cannot be measured directly, measure the ambient temperature.

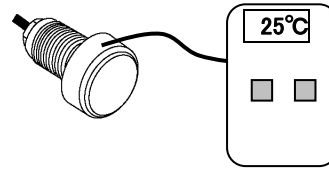

In this example, note "T2=25°C".

T1=21°C
 T2=25°C
 Δ T=

- 8** Calculate and note the adjusted value of the sensor temperature (Δ T).
 "Adjusted value of the sensor temperature (Δ T)" = "Actual temperature measured by the user (T2)" – "Temperature displayed in the amplifier without adjustment (T1)"

T1=21°C
 T2=25°C
 Δ T=+4°C

In this example, note " Δ T=T2-T1=+4°C".

- 9** Set the select No. at "b" in the SET mode.
 - "tEMP" is displayed.



- 10** Hold down **ENT** for about 1 second to start the setting.

- 11** Enter the Adjusted value of the sensor temperature (Δ T).
 - Press **▲** to change the setting value.
 - "P" shows "plus" (positive).
 - Can be set from -12°C to +12°C.

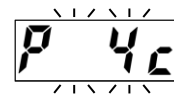

In this example, "P 4°C" is set.

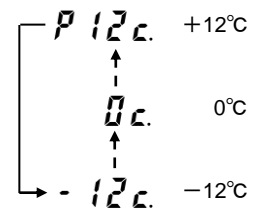

- 12** Press **ENT**. The display blinks rapidly.
 Press **ENT** again to complete the setting.

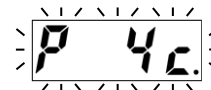

- 13** Set the select No. at "1" in the RUN mode.
 Make sure that the sensor temperature has been adjusted.
[End]



In this example, it is adjusted to "25°C".

10. SET the DETECTION OBJECT MATERIAL

This system has several material parameters to obtain optimal linearity precision for various types of detection objects. Make settings according to the detection object material to use. The materials for standard detection objects that can be set are shown in the table below.

Sensor performance specifications vary depending on the detection object materials. Therefore, it is recommended to use materials with a higher performance specification. The superiority of the performance specifications of standard detection objects is shown in the following order:

(S50C, FC250, SUS430) > (SUS304) > (A5052)

Magnetic metals (S50C, FC250, SUS430) have a superior performance specification to that of nonmagnetic metals (SUS304, A5052). It is recommended to use magnetic metals (S50C, FC250, SUS430) unless they are inappropriate to use. When using a material other than that for the standard detection objects, select one with similar properties.

■ List of detection object material setting

Display of setting	Material	Performance level
FE1	Iron	High
FE2		
SUS1	Stainless steel	Medium
SUS2		High
AL	Aluminum	Low

※ The factory setting is FE1.

■ Procedures for detection object material setting

- 1** Set the select No. at "C" in the SET mode.
- The present material is displayed.



- 2** Hold down **[ENT]** for about 1 second to start the setting.

- 3** Select the detection object material.
- Press **↑** to change the setting value.

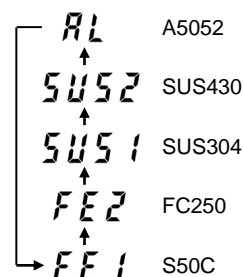
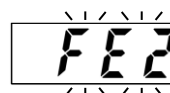

- 4** Press **[ENT]**. The display blinks rapidly.
Press **[ENT]** again to complete the setting.
- When the setting is completed, the display returns to 1. **[End]**



- Magnetic metals (S50C, FC250, SUS430) have a superior performance specification to that of nonmagnetic metals (SUS304, A5052). It is recommended to use magnetic metals (S50C, FC250, SUS430) unless they are inappropriate to use.
- When using a material other than that for the standard detection objects, select one with similar properties.



- Set the detection object material before performing offset cancellation and calibration.
- When the detection object material setting was changed, make sure to perform offset cancellation and calibration again.



- See "27-1. Characters of Detection Objects" for details of detection objects.
- See "26-1. Performance Specification" for details of the performance specification.

11. PERFORM OFFSET CANCELLATION

Offset cancellation is a function to cancel offset error components of gap data caused by influences of surrounding structures or the extension cable, or differences in individual amplifiers or the sensors. Maintain a recommended distance or more between the sensor and the detection object with the system installed in an operating state. The recommended distance varies depending on the sensor to use as shown in the table below. Even when a sufficient distance cannot be secured because of structural and/or other unavoidable reasons, maintain a distance which is three times or more of the distance to detect.

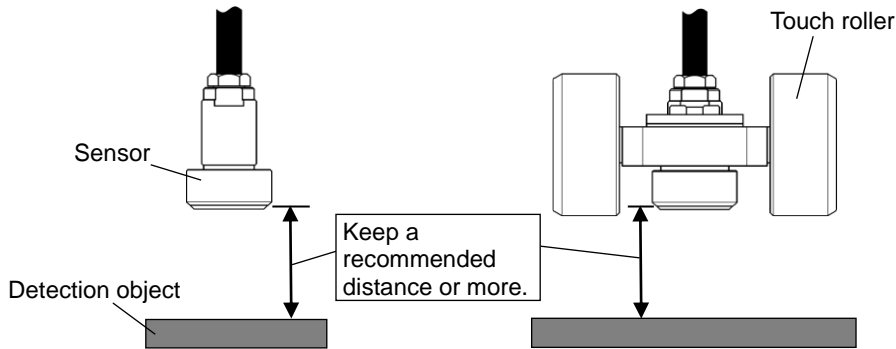

Recommended offset cancellation distance

Sensor type	Recommended distance
GPS-17[][][]-[]	25mm or more
GPS-28[][][]-[]	50mm or more
GPS-60[][][]-[]	100mm or more

Procedures for offset cancellation

- 1 Set the select No. at "d" in the SET mode.
- "oFSt" is displayed.



- 2 Maintain sufficient distance between the sensor and the detection object.

- 3 Hold down **ENT** for about 1 second.
- Blinking "Go" is displayed.

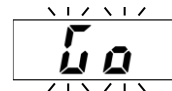

- 4 Press **ENT** again to perform offset cancellation.
- When the offset cancellation is completed, the display returns to 1. **[End]**



- Even when a sufficient distance cannot be secured because of structural and/or other unavoidable reasons, keep a distance which is three times or more of the distance to detect.
- Effects of temperature drifts can be reduced as the temperature when the offset cancellation is performed is closer to the operating temperature.



- Perform offset cancellation with the system installed in an operating state. When the installed condition changes after the offset cancellation, the gap data changes.
- When the conditions of the mounting of the sensor or surrounding structures changed, make sure to perform offset cancellation and calibration again.
- When "Sensor type and cable length setting," "Interference prevention setting," "Sensor temperature adjustment," or "Detection object material setting" is changed, perform offset cancellation and calibration again.

12. PERFORM CALIBRATION

12-1. Description of Calibration

Calibration is a function to correct errors between the actual gap (actual value) and the gap data that the amplifier outputs. This function has the following characteristics:

① **Corrects linearity errors.**

Linearity errors caused by changes in the site environment, difference among individual sensors and amplifiers, or the influences of extension cables can be corrected.

② **Can set the 0 mm gap position freely.**

In an example, the sensor is mounted to the touch roller to measure the thickness of a nonconductive material (e.g. rubber). The gap data of the touch roller surface can be set at 0 mm by cancelling the set gap (distance between the detection surface of the sensor and the touch roller).

③ **Can select the number of corrected points freely.**

Corrected points can be set from 2 to 11 points. As the number of corrected points increases, linearity errors become smaller. Select the number taking into account required precision and workability.

(Though zero corrected point can also be selected, this should be avoided as a rule. Linearity errors increase because this setting outputs gap data without calibration. However, the factory setting is the zero corrected point.)

④ **Errors become smaller as the corrected points are closer to the gap.**

As the corrected points are closer to the gap to measure, linearity errors become smaller. Therefore, set the corrected points based on the gap to measure. (For example, set one of the corrected points at “2 mm” to measure a gap around 2mm.)

The following charts and drawing show an example of calibration when the thickness of a nonconductive material (e.g. rubber) is measured with a sensor attached to a touch roller. Performing calibrations corrects linearity errors. In addition, the gap data of the touch roller surface can be set at 0 mm by cancelling the set gap (distance between the sensor detection surface and the touch roller). Linearity errors can be further reduced as the number of corrected points for calibration increases.

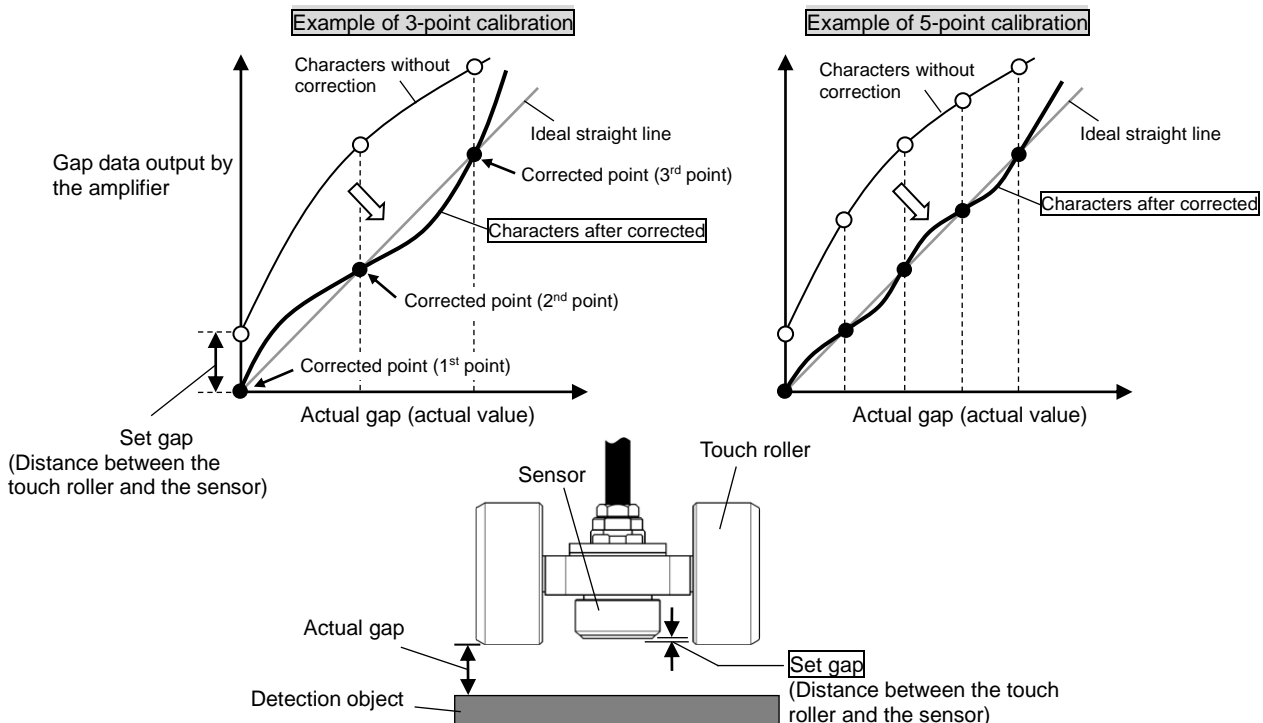

- Mount the sensor in a manner that “(Set gap + Gap to measure) ≤ (Rated detection range)” is secured.
- Decreasing the set gap enlarges the detectable range. It is effective for reducing temperature drifts and abrupt fluctuations.



- See “3-1. Notes on Mounting the Sensor” for details of sensor mounting.

12-2. Procedures for Calibration

(1) Basic Procedures for Calibration

Set a reference gauge (e.g. block gauge, clearance gauge) between the sensor and the detection object, and enter the reference gauge value to the amplifier. The number of corrected points (2 to 11) and the gaps of corrected points can be set as required.

Set the corrected points in ascending order of the gap size (1st point < 2nd point < 3rd point...).

Keep a 0.10 mm or more space between corrected points. ($[n+1]$ th point - $[n]$ th point \geq 0.10 mm).

Do not use a magnetic or conductive material such as metal for the reference gauge when placing the gauge directly against the sensor.

The following drawing shows an example of 3-point calibration.

■ Example of reference gauge directly placed against the sensor ①

[Range for measuring: 0 to 4 mm: Corrected points: 3 points; Gap of corrected points: 0, 2, 4 mm]

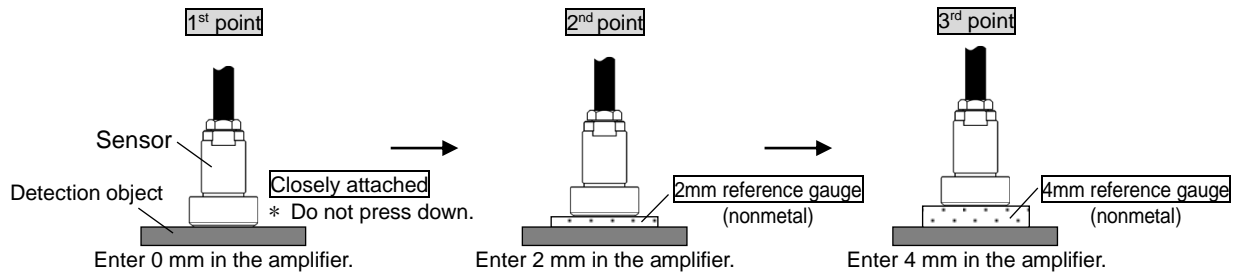

■ Example of reference gauge directly placed against the sensor ②

[Range for measuring: 4 to 6 mm: Corrected points: 3 points; Gap of corrected points: 4, 5, 6 mm]

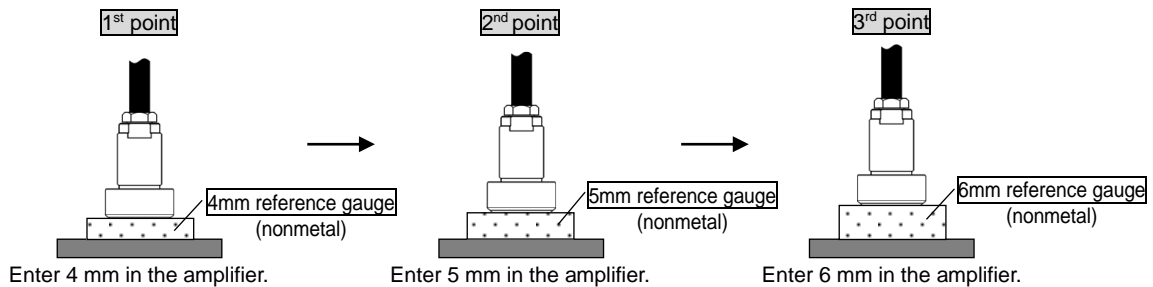

■ Example of reference gauge indirectly placed against the sensor

[Range for measuring: 0 to 4 mm: Corrected points: 3 points; Gap of corrected points: 0, 2, 4 mm]

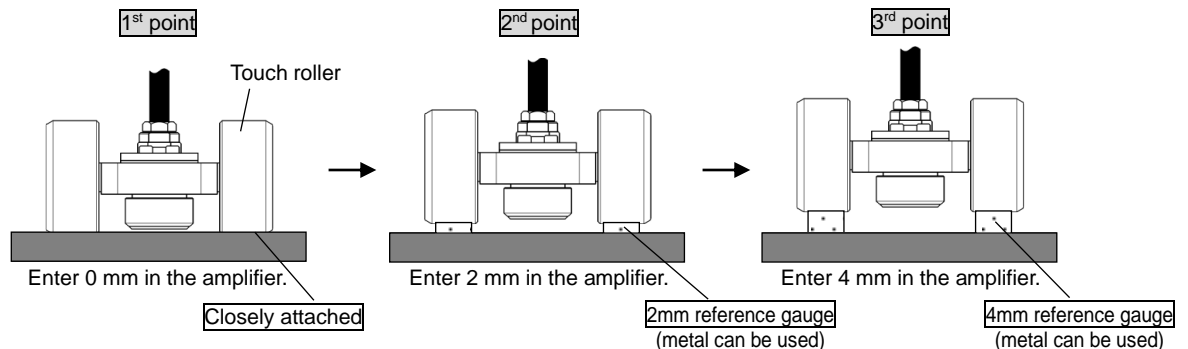

- Perform calibration with the system installed in an operating state. When the installed condition changes after the calibration, the gap data changes.
- Do not use a magnetic or conductive material such as metal for the reference gauge when placing the gauge directly against the sensor. Otherwise, the sensor is influenced by the reference gauge, resulting in incorrect calibration.
- A metal gauge can be used when the reference gauge is placed indirectly at a point away from the sensor. Pay attention not to place the reference gauge closer to the sensor in this case.
- Be careful not to press down the sensor hard when placing the detection object or the reference gauge directly against the sensor. Otherwise, the sensor may break.
- Set the gap of corrected points in ascending order of the gap size (1st point < 2nd point < 3rd point...).
- Keep a 0.10 mm or more space between corrected points. ($[n+1]$ th point - $[n]$ th point \geq 0.10 mm).
- When the number of corrected points is set at 0, the gap data without calibration is output. This setting should be avoided as a rule because linearity errors increase. However, the factory setting is the zero corrected point.
- When "Sensor type and cable length setting," "Interference prevention setting," "Sensor temperature adjustment," "Detection object material setting," or "Offset cancellation" is changed, make sure to perform calibration again.

(2) Procedures for Calibration in Detail

The procedures are described below using an example of 3-point calibration.

- Range for measuring ...0 to 4 mm
- Number of corrected points ...3 points
- Gap of corrected points ...0, 2, 4 mm (1st point...0 mm; 2nd point...2 mm; 3rd point...4 mm)

1 Perform offset cancellation in advance.

2 Set the select No. at "E" in the SET mode.
- "CAL" is displayed.



3 Hold down **ENT** for about 1 second to start the setting.

4 Select the number of corrected points.
- "Pt. □" is displayed.
- Press **▲** to change the setting value.
- The factory setting is zero (no correction).

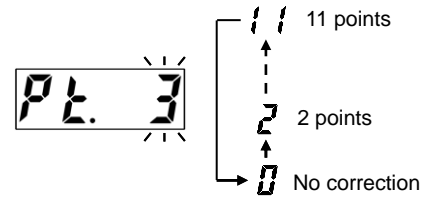

5 Press **ENT**. The display blinks rapidly.
Press **ENT** again to start the next setting.

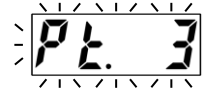

6 Prepare the 1st point.

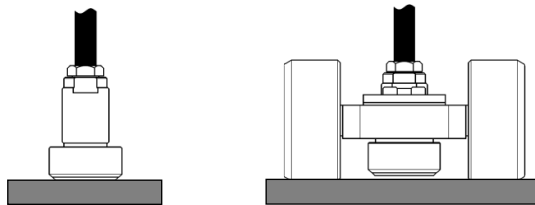

In this example, "0mm (closely attached)" status is set.

7 Enter the value of the 1st corrected point.
- Press **▲** to change the value at the blinking digit.
- Press **▶** to change the blinking digit.
- The present corrected point is displayed from *i* to *b* (in hexadecimal) in the select display part.

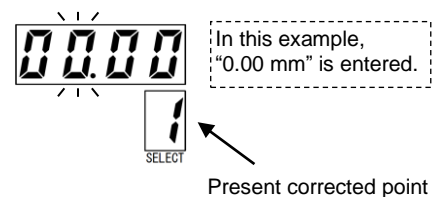

Present corrected point

8 Press **ENT**. The display blinks rapidly.
Press **ENT** again to start the next setting.
- Do not move the sensor and the detection object before pressing **ENT** twice.



9 Prepare the 2nd point.

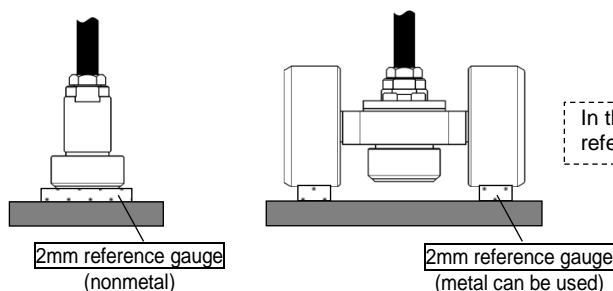

In this example, a "2 mm" reference gauge is set.

- 10** Enter the value of the 2nd corrected point.
- Press **▲** to change the value at the blinking digit.
 - Press **▶** to change the blinking digit.
 - The present corrected point is displayed from **i** to **b** (in hexadecimal) in the select display part.

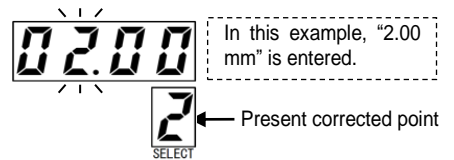

- 11** Press **ENT**. The display blinks rapidly.
- Press **ENT** again to start the next setting.
- Do not move the sensor and the detection object before pressing **ENT** twice.



- 12** Prepare the 3rd point.

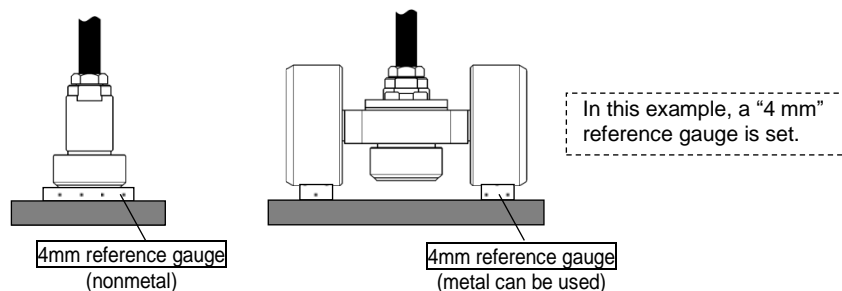

- 13** Enter the value of the 3rd corrected point.
- Press **▲** to change the value at the blinking digit.
 - Press **▶** to change the blinking digit.
 - The present corrected point is displayed from **i** to **b** (in hexadecimal) in the select display part.

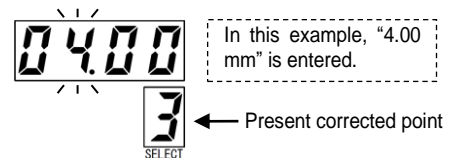

- 14** Press **ENT**. The display blinks rapidly.
- Press **ENT** again to start the next setting.
- Do not move the sensor and the detection object before pressing **ENT** twice.



- 15** When the setting of all the corrected points is completed, blinking "End" is displayed.
- Calibration is not completed yet

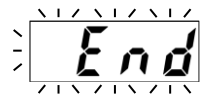

- 16** Pressing **ENT** again completes calibration.
- When the setting is completed, the display returns to 1. **[End]**



POINT

- Effects of temperature drifts can be reduced as the temperature when the calibration is performed is closer to the operating temperature.
- When the setting is not correct, a warning **nb** is displayed.
- The previous corrected point is displayed when **ESC** is pressed. Resetting is necessary after each return.
- The setting is not registered when the calibration is interrupted.

13. OPERATION

Operate the system in the RUN mode. By changing the Select No. during the RUN mode, the display contents can be changed.

The RUN output of the I/O connector is kept ON in the RUN mode.

(1) Display the Gap Data

When the select No. is set at "0" in the RUN mode, the present gap data is displayed in mm. The update cycle and the decimal point position can be changed in the SET mode.

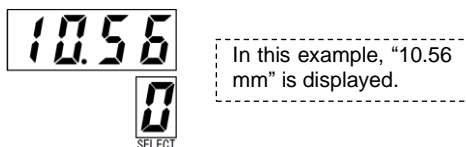

- When the gap data exceed the rated detection range largely, **OVER** is displayed.
- When a sensor disconnected error occurs, **SE** is displayed.



- See "14. CHANGE the GAP DATA DISPLAY METHOD" to change update cycle or the decimal point position in the gap data display.
- Execution and cancellation of the preset by switch operation are made with the gap data displayed. See "19. USE the PRESET FUNCTION" for details of the preset function.

(2) Display the Temperature Data

Setting the Select No. at "1" in the RUN mode, the present sensor temperature is displayed in °C.

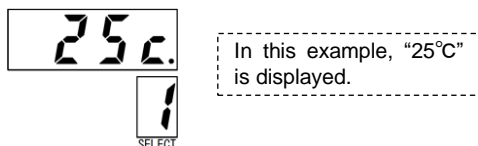

- When a sensor disconnected error occurs, **SE** is displayed.



- See "9. ADJUST the SENSOR TEMPERATURE" for adjusting the sensor temperature.

(3) Display the Judgment Result

Judgment result is displayed in the judgment display part. The corresponding display part lights up when each judgment is active. In addition, when the select No. is set at "2" in the RUN mode, the judgment result is also displayed in the data display part.

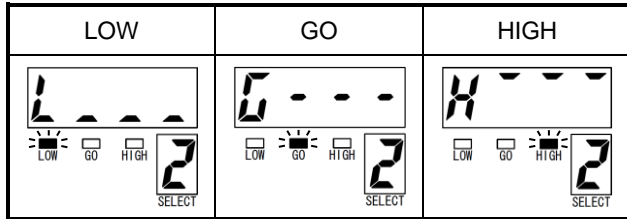

- When a sensor disconnected error occurs, **SE** is displayed.



- See "16. USE the JUDGMENT FUNCTION" for details of the judgment.

(4) Display the Measured Data

When the select No. is set at "3" in the RUN mode, the measured data is displayed.

When the measured data is updated, the measuring trigger display part blinks once.

When the measured data is reset, **none** is displayed.

The update cycle or the decimal point position in the display can be changed in the SET mode.

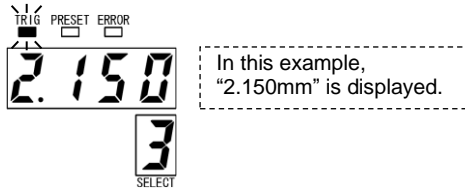

- When a sensor disconnected error occurs, **SE** is displayed.



- See "17. USE the MEASURING FUNCTION" for details of the measuring function.

- See "14. CHANGE the GAP DATA DISPLAY METHOD" to change the update cycle or the decimal point position in the display.

(5) Check Analog Output

The analog signal is output from the terminal block at the front of the amplifier. It has two output channels.

The analog output is enabled both in the RUN mode and the SET mode.



- See "4-3. Analog Output Connection" for the connection of analog output.

- See "18. USE the ANALOG OUTPUT FUNCTION" for the analog output function.

14. CHANGE the GAP DATA DISPLAY METHOD

Update cycles and decimal point positions can be changed for the display of gap data and measured data. (A separate change is not accepted.)

In the display, the left side is for the update cycle and the right side is for the decimal point position.

Update cycle		Decimal point position	
Display of setting	Description	Display of setting	Description
1 -	Updated once per second.	- 0	Automatically shifts and displays the decimal point positions. - Values below 10 mm are displayed up to the third decimal place (0.001 mm). - 10 mm or larger values are displayed up to the second decimal place (0.01 mm).
3 -	Updated 3 times per second.	- 1	Displays to the first decimal place. (0.1mm) (Ex.) "10.5" is displayed for 10.555 mm.
5 -	Updated 5 times per second.	- 2	Displays to the second decimal place. (0.01mm) (Ex.) "10.55" is displayed for 10.555 mm.
10 -	Updated 10 times per second.	- 3	Displays to the third decimal place (0.001mm) - The two digit number is not displayed for 10 mm or larger values. (Ex.) "0.555" is displayed for 10.555 mm.

* The factory setting is 3 - 0. (Updated 3 times per second, and the decimal place positions are switched automatically.)

■ Procedures for display setting of gap data and measured data

- 1** Set the select No. at "0" in the SET mode.
- The present setting is displayed.



- 2** Hold down **[ENT]** for about 1 second to start the setting.

- 3** Select the decimal point position.
- The right-side digit in the display blinks.
- Press **↑** to change the setting value.

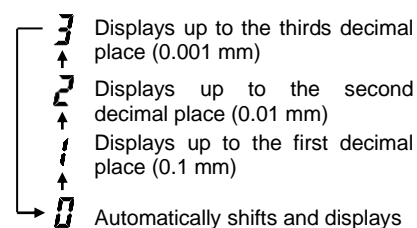
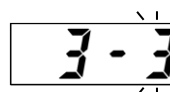

- 4** When **→** is pressed, the blinking digit changes.

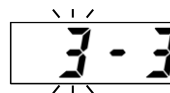

- 5** Select the update cycle.
- The left-side digit in the display blinks.
- Press **↑** to change the setting value.
- When **→** is pressed, the display returns to the step 3.

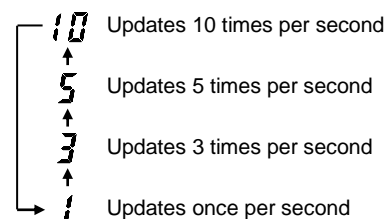
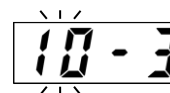

- 6** Press **[ENT]**. The display blinks rapidly.
Press **[ENT]** again to complete the setting.
- When the setting is completed, the display returns to 1. **[End]**

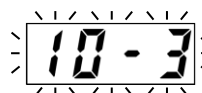

15. USE the DIGITAL FILTER

The digital filter is a function to eliminate elements whose frequency is higher than the cutoff frequency of the sensor signals (LPF). As the cutoff frequency is lower, abrupt fluctuations caused by noises or vibrations of the detection object become smaller. However, the response speed becomes slower at the same time. Therefore, set the frequency in accordance with the site environment and applications. The cutoff frequency can be set in 11 grades between 1 Hz and 1 kHz.

Display of setting	Cutoff frequency of LPF	Display of setting	Cutoff frequency of LPF
1K H	1kHz	15H	15Hz
500H	500Hz	8H	8Hz
250H	250Hz	4H	4Hz
125H	125Hz	2H	2Hz
62H	62Hz	1H	1Hz
30H	30Hz		

* The factory setting is 30H.

■ Procedures for digital filter setting

- 1 Set the select No. at "1" in the SET mode.
- The present setting is displayed.



- 2 Hold down **[ENT]** for about 1 second to start the setting.

- 3 Select the cutoff frequency.
- Press **▲** to change the setting value.

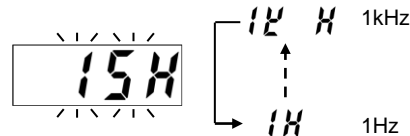

- 4 Press **[ENT]**. The display blinks rapidly.
Press **[ENT]** again to complete the setting.
- When the setting is completed, the display returns to 1. **[End]**



- Cutoff frequency is a frequency component of the gap data whose amplitude attenuates up to -3 dB (approx. 71%). Frequency components higher than the cutoff frequency attenuate further.
- To measure the motions and vibrations of the detection object precisely, observe the gap data with the cutoff frequency at the maximum value (1 kHz), and set the cutoff frequency again according to the observed waveform.
- Since the gap data is measured in the measuring mode, the digital filter can be set.



- See "27-4. Abrupt Fluctuations" for the fluctuations.

16. USE the JUDGMENT FUNCTION

Judgment is a function to judge data using the lower and the upper limit values. For target data selectable from gap data, measured data, and temperature data, there are three judgment results: "LOW," "GO," and "HIGH." Hysteresis can be provided to the upper and the lower limit values. The hysteresis functions inward (toward the Go area) from the lower and the upper limit values. The judgment result is displayed in its display part, and is also output as an I/O signal.

Target data for Judgment

Display	Name	Description
	Gap data	Judges gap data.
	Measured data	Judges measured data of the measuring function.
	Temperature data	Judges temperature data.

* The factory setting is .

Description of Judgment

Judgment	Description	Display of judgment	I/O output signal
LOW	Judgment when the data falls on or below the lower limit value. (Data \leq Lower limit value)		LOW is ON.
GO	Judgment when the data is between the lower and the upper limit values. (Lower limit value < Data < Upper limit value)		GO is ON.
HIGH	Judgment when the data falls on or above the upper limit value. (Upper limit value \leq Data)		HIGH is ON.

Description of hysteresis

The hysteresis functions inward (toward the Go area) from the lower and the upper limit values.

- Once the value is judged LOW, it will not become GO unless the data becomes "Lower limit value + Hysteresis or above."
- Once the value is judged HIGH, it will not become GO unless the data becomes "Upper limit value - Hysteresis or below."

Example of judgment operations

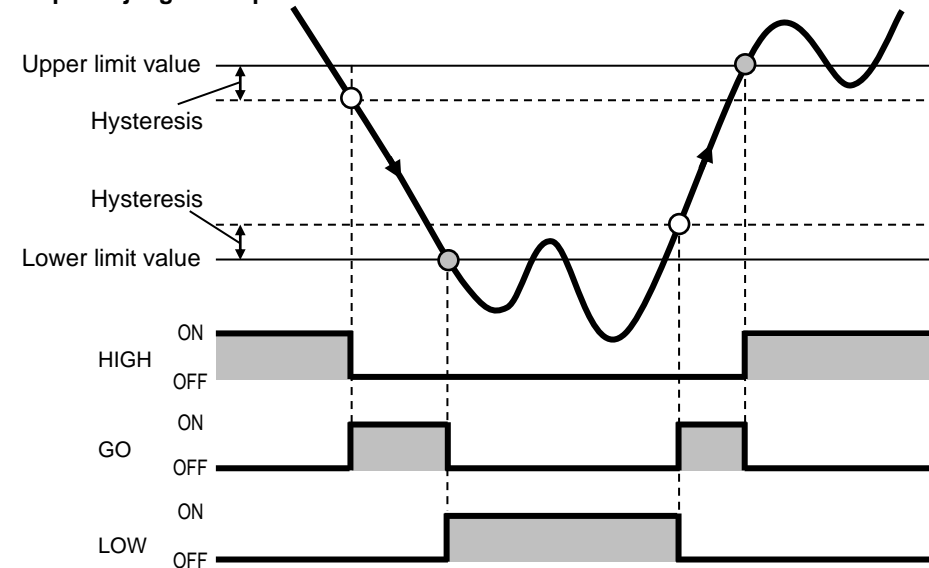

- The lower limit value, the upper limit value, and the hysteresis have the following relationship:
 $(\text{Lower limit value} + \text{Hysteresis}) < (\text{Upper limit value} - \text{Hysteresis})$
 The hysteresis value that can be set is as follows: $\text{Hysteresis} < (\text{Upper limit value} - \text{Lower limit value}) \div 2$.



- See "4-4. I/O Connections and Functions" for the connections and functions of input and/or output.

■ Procedures for Judgment setting

- 1 Set the select No. at "2" in the SET mode.
- "LGH" is displayed.



- 2 Hold down **[ENT]** for about 1 second to start the setting.

- 3 Select the judgment data.
- Press **↑** to change the setting data.

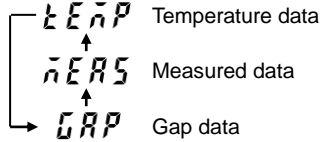

In the case of gap data or measured data



In the case of temperature data

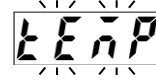

- 4 Press **[ENT]**. The display blinks rapidly.
Press **[ENT]** again to start the next setting.

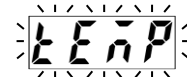

- 5 Enter the lower limit value.
- Press **↑** to change the value at the blinking digit.
- Press **→** to change the blinking digit.
- During setting, "L" is displayed in the select display part.

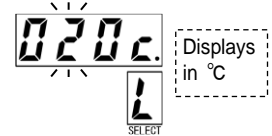
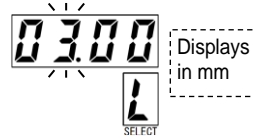

- 6 Press **[ENT]**. The display blinks rapidly.
Press **[ENT]** again to start the next setting.



- 7 Enter the upper limit value.
- Press **↑** to change the value at the blinking digit.
- Press **→** to change the blinking digit.
- During setting, "H" is displayed in the select display part.

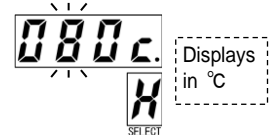
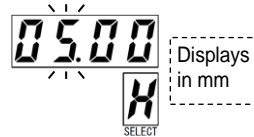

- 8 Press **[ENT]**. The display blinks rapidly.
Press **[ENT]** again to start the next setting.



- 9 Select the hysteresis.
- Press **↑** to change the value at the blinking digit.
- Press **→** to change the blinking digit.
- During setting, "h" is displayed in the select display part.

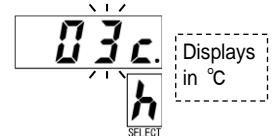
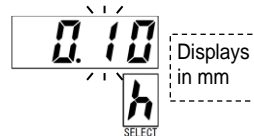

- 10 Press **[ENT]**. The display blinks rapidly.
Press **[ENT]** again to complete the setting.
- When the setting is completed, the display returns to 1. **[End]**



- Enter the "lower limit value," the "upper limit value" and the "hysteresis" correctly in this order.

- In the factory setting, gap data is selected as target data. The setting values are as follows:
Lower limit value is 1.00 mm; upper limit value is 5 mm; and hysteresis is 0.1 mm.



- When the gap data or the measured data is selected, the upper and lower limit values can be set from 0.00 to 99.99 mm with the hysteresis from 0.00 to 9.99 mm.

- When the temperature data is selected, the upper and lower limit values can be set from 0 to 999°C with the hysteresis from 0 to 99°C.

- Enter the values correctly in a manner that "(Lower limit value + Hysteresis) < (Upper limit value - Hysteresis)" is secured.
The hysteresis value that can be set is as follows: Hysteresis < (Upper limit value - Lower limit value) ÷ 2

- When the setting value is not correct, a warning **nG** is displayed.

■ Procedures to display judgment

Judgment result is displayed in the judgment display part. The corresponding display part lights up when each judgment is active. In addition, when the select No. is set at "2" in the RUN mode, the judgment result is also displayed in the data display part.

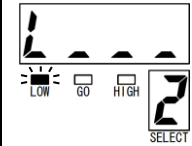
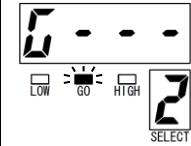
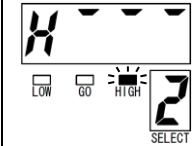
LOW	GO	HIGH
		



- When a sensor disconnected error occurs, **SE** is displayed.

17. USE the MEASURING FUNCTION

17-1. Description of the Measuring Function

The measuring function measures gap data in each mode. The selectable trigger types are external trigger, internal trigger, and cycle trigger. Any trigger type can reset the measured data by the I/O measuring reset input. A measuring strobe signal is output from the I/O according to the measuring timing. When the measured data is updated, the measuring trigger display part blinks once. Since the measuring function handles gap data, the digital filter can be set.

Measuring modes

Display	Name	Description
SAMPL	Sample Hold	Holds gap data at a designated timing.
PEAK	Peak Hold	Holds the maximum gap data value during the sampling duration.
bottom	Bottom Hold	Holds the minimum gap data value during the sampling duration.
P-P	Peak-to-Peak Hold	Holds the "maximum value – minimum value" of gap data during the sampling duration.

※The factory setting is **SAMPL** (Sample Hold).

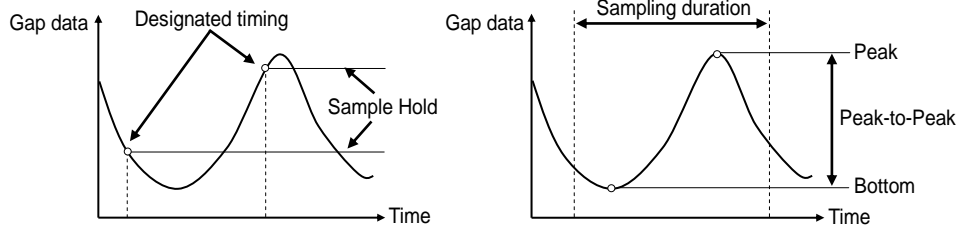

Trigger types

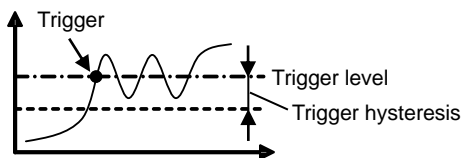
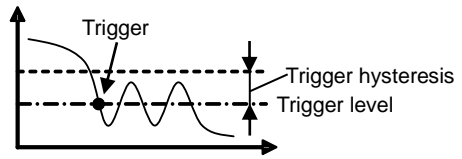
Display	Name	Function	
EYE	External trigger	Activates trigger by the external trigger input of the I/O.	
int	Internal trigger	Activates trigger when the gap data exceeds or falls below the trigger level. Sampling is started after the trigger delay is over and data is measured after the sampling duration is over.	
		Trigger direction: Leading edge \uparrow	A trigger is generated when the gap data exceeds the trigger level.
		Trigger direction: Trailing edge \downarrow	A trigger is generated when the gap data falls below the trigger level.
		Trigger level	Threshold of the gap data which generates a trigger. The setting range is from 0 to 99.99 mm.
		Trigger hysteresis	Hysteresis to prevent trigger chattering. The setting range is from 0 to 9.99 mm. - In the case of the leading edge \uparrow :  - In the case of the trailing edge \downarrow : 
		Trigger delay	Delay time until the sampling is started after a trigger is generated. The setting range is from 0 to 9,999 ms.
Sampling duration	Duration of sampling. The setting range is from 0 to 9,999 ms. When the sampling duration is zero, the sampling ends with "Trigger level – Trigger hysteresis" or "Trigger level + Trigger hysteresis."		
CYCL	Cycle trigger	Activates trigger in a preset cycle. The setting cycle is from 1 to 9,999 ms.	

* The factory setting is **EYE** (External trigger).

■ Display of measured data

When the select No. is set at "3" in the RUN mode, the measured data is displayed in mm.

- When the measured data is updated, the measuring trigger display part blinks once.
- When the measured data is reset, *none* is displayed.
- When a sensor disconnected error occurs, *SE* is displayed.

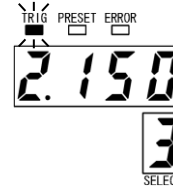

In this example, "2.150 mm" is displayed.

■ Measuring reset input

The measured data can be reset at a desired timing by the I/O measuring reset input. The measured data is reset when the power has just been turned on.

- When the measured data is reset, *none* is displayed.
- When the measured data is selected for judgment, the judgment result is that for when the measured data is 0 mm.
- When the measured data is selected for the analog output, the output value is that for when the measured data is 0 mm.

■ Measuring strobe output

This signal is output from the I/O according to the measuring timing. The function varies depending on the setting of the trigger type.

In any trigger type, a stable analog output and judgment signal can be captured into the host controller when the strobe output changes from ON to OFF (OFF edge).

- In the case of external trigger and cycle trigger...Kept ON for a certain period of time when the measured data is updated.
(ON period: Approx. 10 ms)
However, a correct measuring strobe is not output when the input timing of the external trigger or the preset cycle of the cycle trigger is shorter than 20 ms.
- In the case of internal trigger...Kept ON during the sampling duration. However, an off-delay is activated for about 5 ms when the output changes from ON to OFF.

-
- The measured data is reset when the power has just been turned on.
 - The measured data is reset when "Measuring function setting," "Sensor type and cable length setting," "Interference prevention setting," "Sensor temperature adjustment," "Detection object material setting," "Offset cancellation," "Calibration," or "Preset value setting" is set again.
 - The measured data is reset when the preset is executed or cancelled.
- ATTN**
- When the measured data is reset, *none* is displayed.
 - When the measured data is selected for judgment and it is reset, the judgment result is that for when the measured data is 0 mm.
 - When the measured data is selected for analog output, the output value is that for when the measured data is 0 mm.
-

- Since this amplifier has two analog output channels, the measuring function operations can be verified when the normal gap data and the measured data are observed simultaneously. The drawing below shows an example of simultaneous observation by selecting the gap data to the analog output 1 and the measured data to the analog output 2.

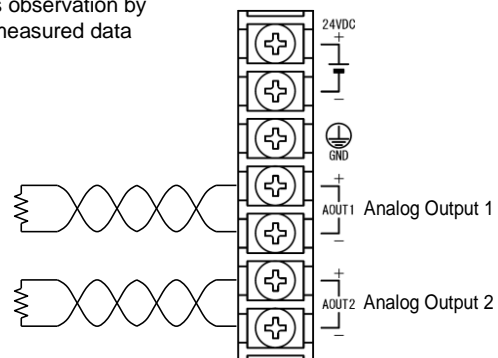
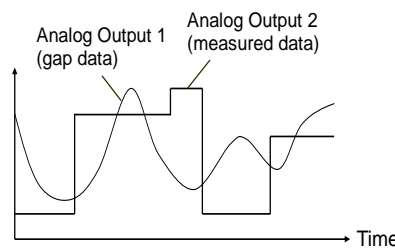

- See "27-3. Timing Chart" for timing of the measuring reset input and the measuring strobe output.
- See "18. USE the ANALOG OUTPUT FUNCTION" for details of the analog output function.

17-2. Example of Measuring Function Operations

(1) Sample Hold

Holds gap data at a designated timing.

■ Example of Sample Hold by external trigger

- Holds the gap data at an OFF to ON transition (ON edge) of the external trigger input.
- When the measured data is updated, the strobe output is kept ON for a certain period of time (approx. 10 ms).
- When the reset input turns ON, the measured data is reset and the sampling is canceled.
- The measured data is reset when the power has just been turned on.
- When the measured data is reset, $n o n \bar{E}$ is displayed, and the analog output value becomes that at 0 mm. (See *1 in the drawing.)

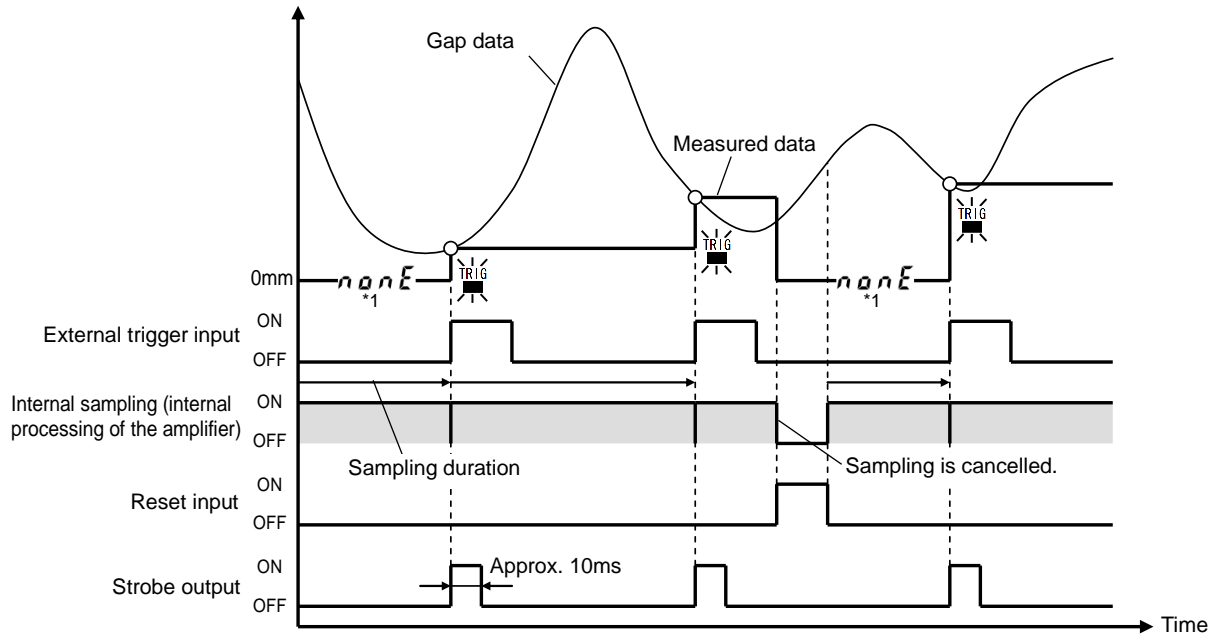

■ Example of Sample Hold by internal trigger ①

[Trigger direction: \uparrow leading edge, sampling duration ≥ 1 ms]

- A trigger is generated when the gap data exceeds the trigger level, and the gap data is held after the trigger delay and the sampling duration are over.
- Once a trigger is generated, another trigger will not be generated until the gap data falls below "Trigger level - Trigger hysteresis."
- The strobe output is kept ON during the sampling duration. However, an off-delay is activated for about 5 ms when the strobe output changes from ON to OFF.
- When the reset input turns on, the measured data is reset and the sampling is canceled.
- The measured data is reset when the power has just been turned on.
- When the measured data is reset, $n o n \bar{E}$ is displayed, and the analog output value becomes that at 0 mm. (See *1 in the drawing.)

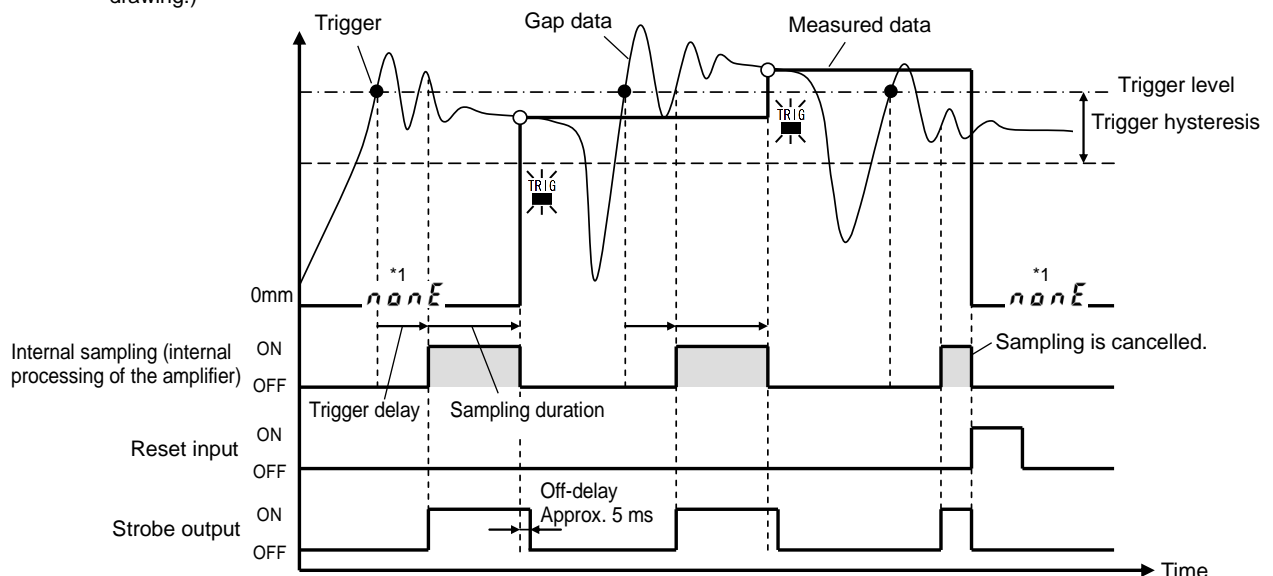

■ Example of Sample Hold by internal trigger ②

[Trigger direction:  leading edge, sampling duration = 0 ms]

* This setting should be avoided under normal use because the measured data is always the value of "Trigger level—Trigger hysteresis."

- A trigger is generated when the gap data exceeds the trigger level, and the sampling is started after the trigger delay is over. Then, the sampling ends when the gap data falls below "Trigger level—Trigger hysteresis," and the gap data is held.
- Once a trigger is generated, another trigger will not be generated until the gap data falls below "Trigger level—Trigger hysteresis."
- The strobe output is kept ON during the sampling duration. However, an off-delay is activated for about 5 ms when the strobe output changes from ON to OFF.
- When the reset input turns on, the measured data is reset and the sampling is canceled.
- The measured data is reset when the power has just been turned on.
- When the measured data is reset, *nonE* is displayed, and the analog output value becomes that at 0 mm. (See *1 in the drawing.)

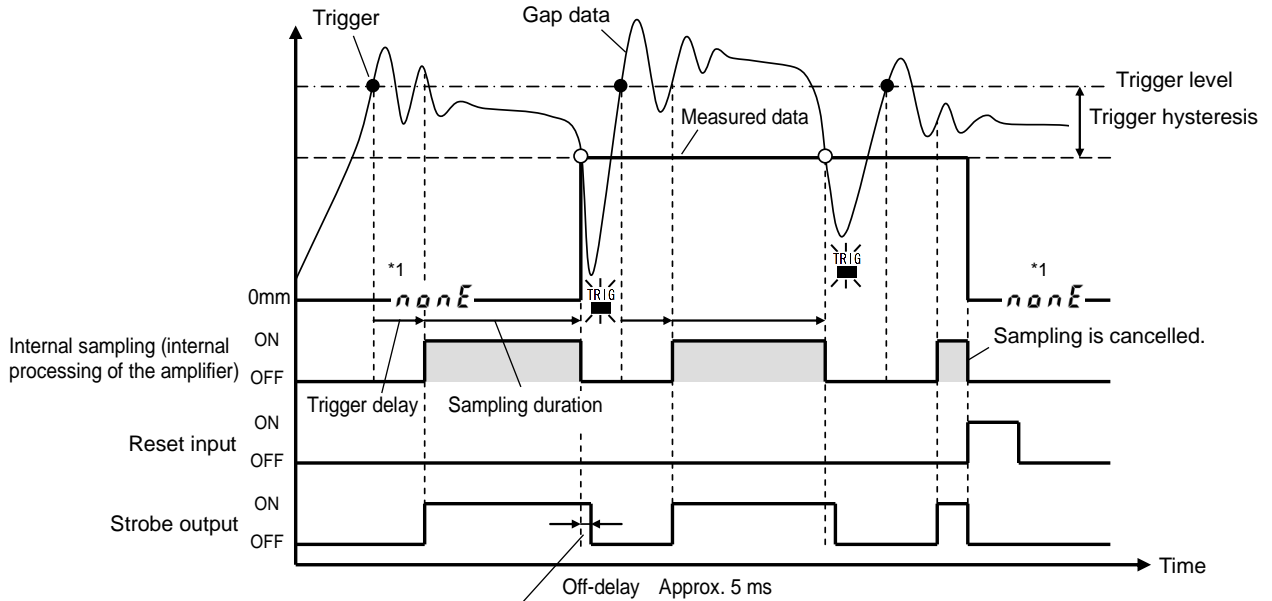

■ Example of Sample Hold by cycle trigger

- Holds the gap data each time the preset cycle is over.
- When the measured data is updated, the strobe output is kept ON for a certain period of time (approx. 10 ms).
- When the reset input turns on, the measured data is reset and the sampling is canceled. The sampling is resumed when the reset input turns OFF.
- The measured data is reset when the power has just been turned on.
- When the measured data is reset, *nonE* is displayed, and the analog output value becomes that at 0 mm. (See *1 in the drawing.)

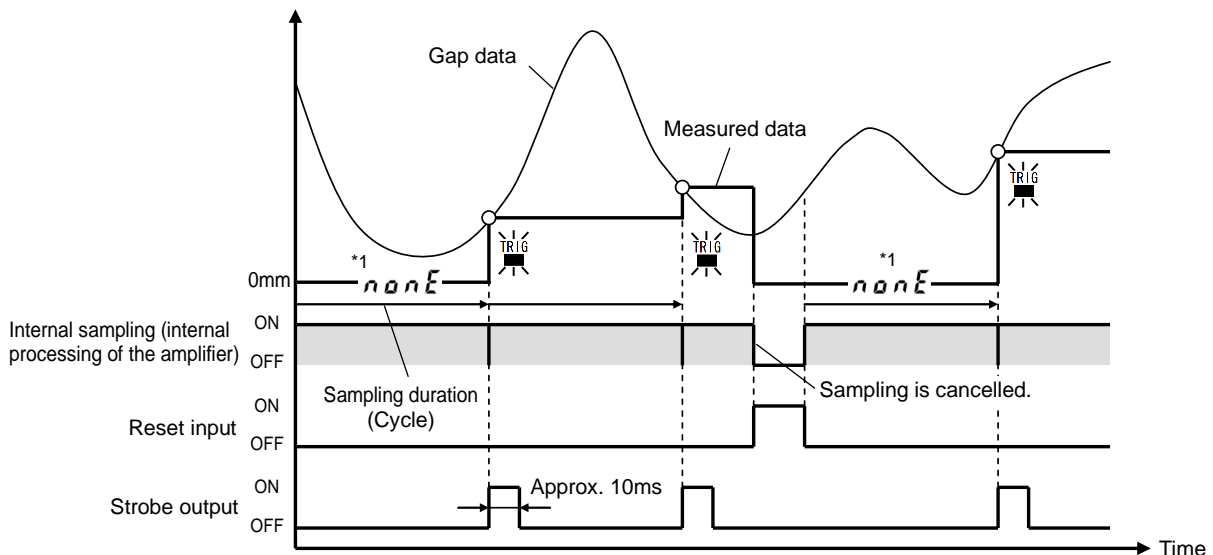

(2) Peak Hold

Holds the maximum gap data value during the sampling duration.

Example of Peak Hold by external trigger

- The sampling duration starts at an OFF to ON transition (ON edge) of the external trigger input and continues until another OFF to ON transition (ON edge), and the maximum value during the duration is held.
- When the measured data is updated, the strobe output is kept ON for a certain period of time (approx. 10 ms).
- When the reset input turns on, the measured data is reset and the sampling is canceled.

The sampling is resumed when the reset input turns OFF.

- The measured data is reset when the power has just been turned on.

- When the measured data is reset, $n\ 0\ n\ \xi$ is displayed, and the analog output value becomes that at 0 mm. (See *1 in the drawing.)

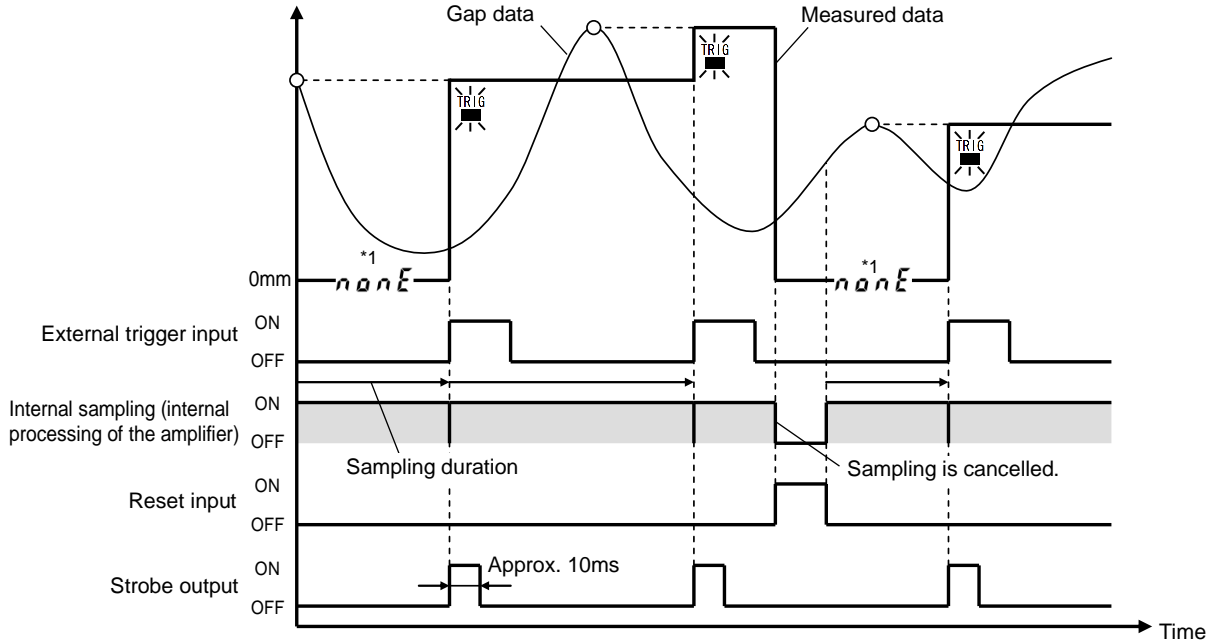

Example of Peak Hold by internal trigger ①

[Trigger direction: \uparrow leading edge, sampling duration ≥ 1 ms]

- A trigger is generated when the gap data exceeds the trigger level, and the sampling is started after the trigger delay is over. Then, the maximum value during the sampling duration is held after the duration is over.
- Once a trigger is generated, another trigger will not be generated until the gap data falls below "Trigger level - Trigger hysteresis."
- The strobe output is kept ON during the sampling duration. However, an off-delay is activated for about 5 ms when the strobe output changes from ON to OFF.
- When the reset input turns on, the measured data is reset and the sampling is canceled.
- The measured data is reset when the power has just been turned on.
- When the measured data is reset, $n\ 0\ n\ \xi$ is displayed, and the analog output value becomes that at 0 mm. (See *1 in the drawing.)

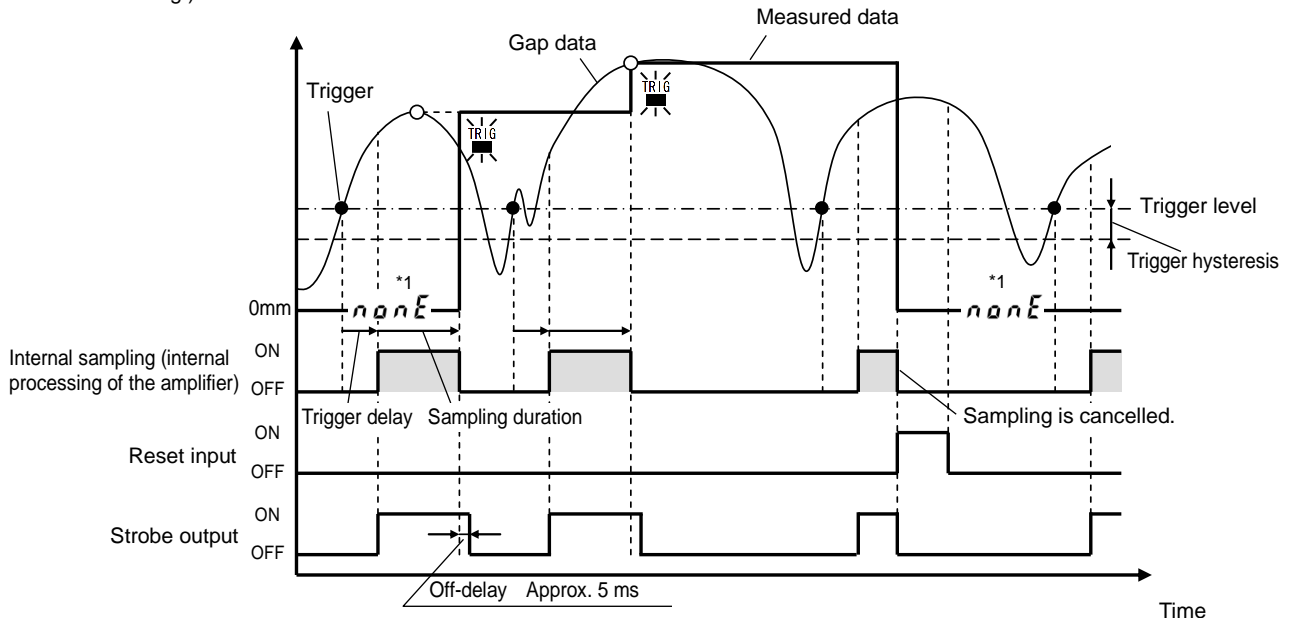

■ Example of Peak Hold by internal trigger ②

[Trigger direction:  leading edge, sampling duration = 0 ms]

- A trigger is generated when the gap data exceeds the trigger level, and the sampling is started after the trigger delay is over. Then, the sampling ends when the gap data falls below "Trigger level - Trigger hysteresis," and the maximum value during the sampling duration is held.
- Once a trigger is generated, another trigger will not be generated until the gap data falls below "Trigger level - Trigger hysteresis."
- The strobe output is kept ON during the sampling duration. However, an off-delay is activated for about 5 ms when the strobe output changes from ON to OFF.
- When the reset input turns on, the measured data is reset and the sampling is canceled.
- The measured data is reset when the power has just been turned on.
- When the measured data is reset, $n\theta n\epsilon$ is displayed, and the analog output value becomes that at 0 mm. (See *1 in the drawing.)

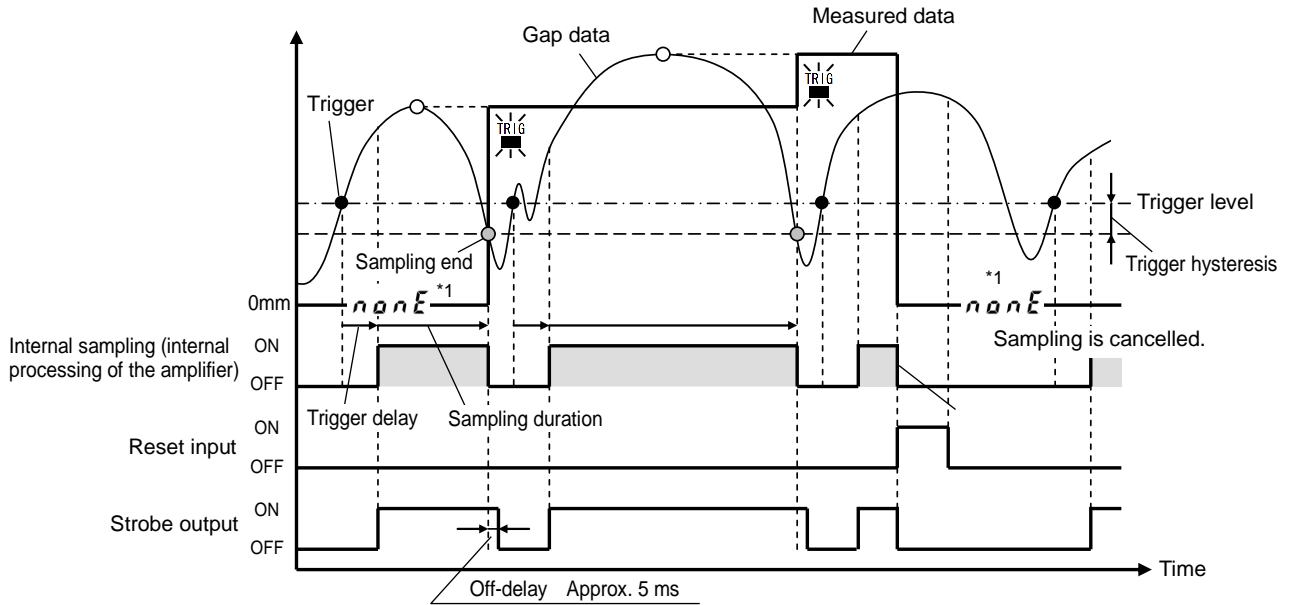

■ Example of Peak Hold by cycle trigger

- The maximum value during the sampling duration, which is a preset cycle, is held.
- When the measured data is updated, the strobe output is kept ON for a certain period of time (approx. 10 ms).
- When the reset input turns on, the measured data is reset and the sampling is canceled. The sampling is resumed when the reset input turns OFF.
- The measured data is reset when the power has just been turned on.
- When the measured data is reset, $n\theta n\epsilon$ is displayed, and the analog output value becomes that at 0 mm. (See *1 in the drawing.)

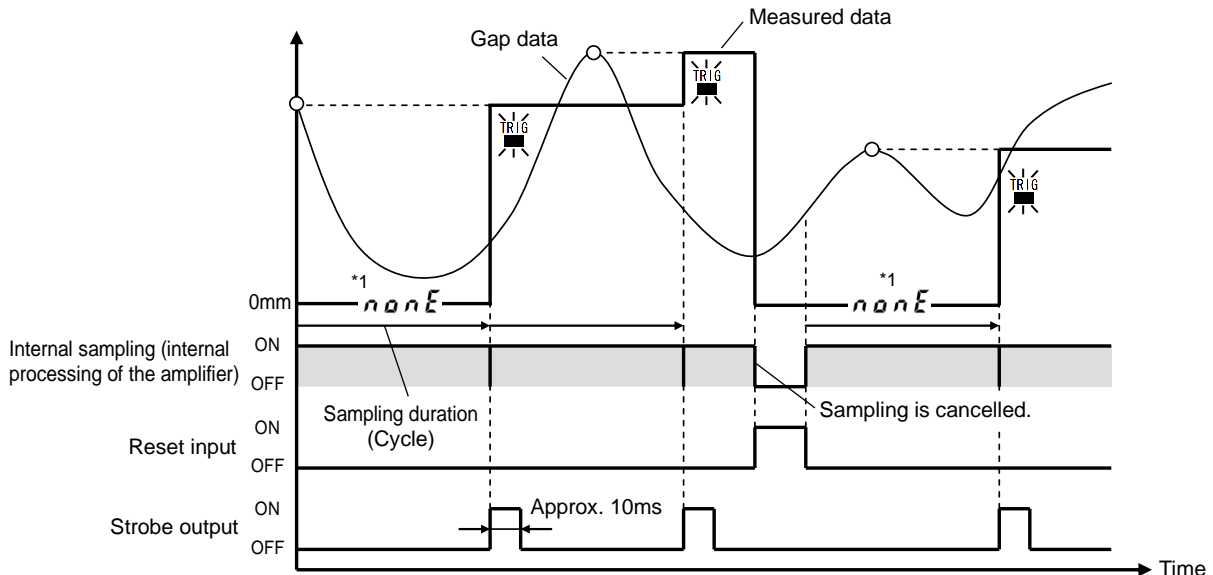

(3) Bottom Hold

Holds the minimum gap data value during the sampling duration.

■ Example of Bottom Hold by external trigger

- The sampling duration starts at an OFF to ON transition (ON edge) of the external trigger input and continues until another OFF to ON transition (ON edge), and the minimum value during the duration is held.
- When the measured data is updated, the strobe output is kept ON for a certain period of time (approx. 10 ms).
- When the reset input turns on, the measured data is reset and the sampling is canceled.
- The sampling is resumed when the reset input turns OFF.
- The measured data is reset when the power has just been turned on.
- When the measured data is reset, $n o n E$ is displayed, and the analog output value becomes that at 0 mm. (See *1 in the drawing.)

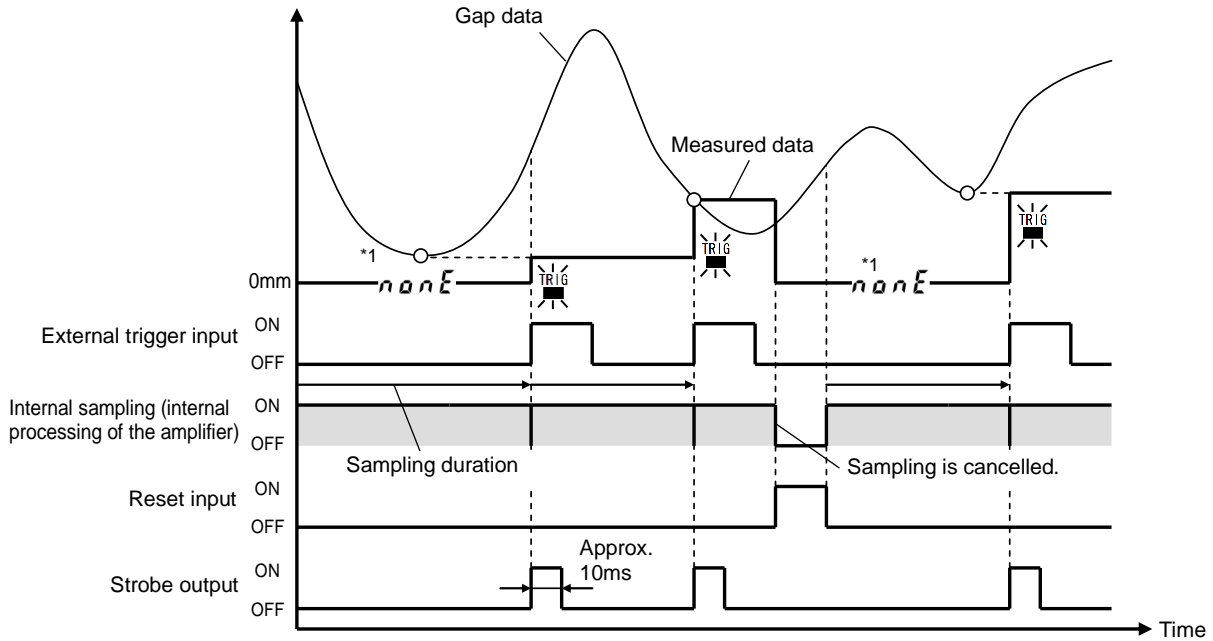

■ Example of Bottom Hold by internal trigger ①

[Trigger direction: ∇ trailing edge, sampling duration ≥ 1 ms]

- A trigger is generated when the gap data falls below the trigger level, and the sampling is started after the trigger delay is over. Then, the minimum value during the sampling duration is held after the duration is over.
- Once a trigger is generated, another trigger will not be generated until the gap data exceeds "Trigger level + Trigger hysteresis."
- The strobe output is kept ON during the sampling duration. However, an off-delay is activated for about 5 ms when the strobe output changes from ON to OFF.
- When the reset input turns on, the measured data is reset and the sampling is canceled.
- The measured data is reset when the power has just been turned on.
- When the measured data is reset, $n o n E$ is displayed, and the analog output value becomes that at 0 mm. (See *1 in the drawing.)

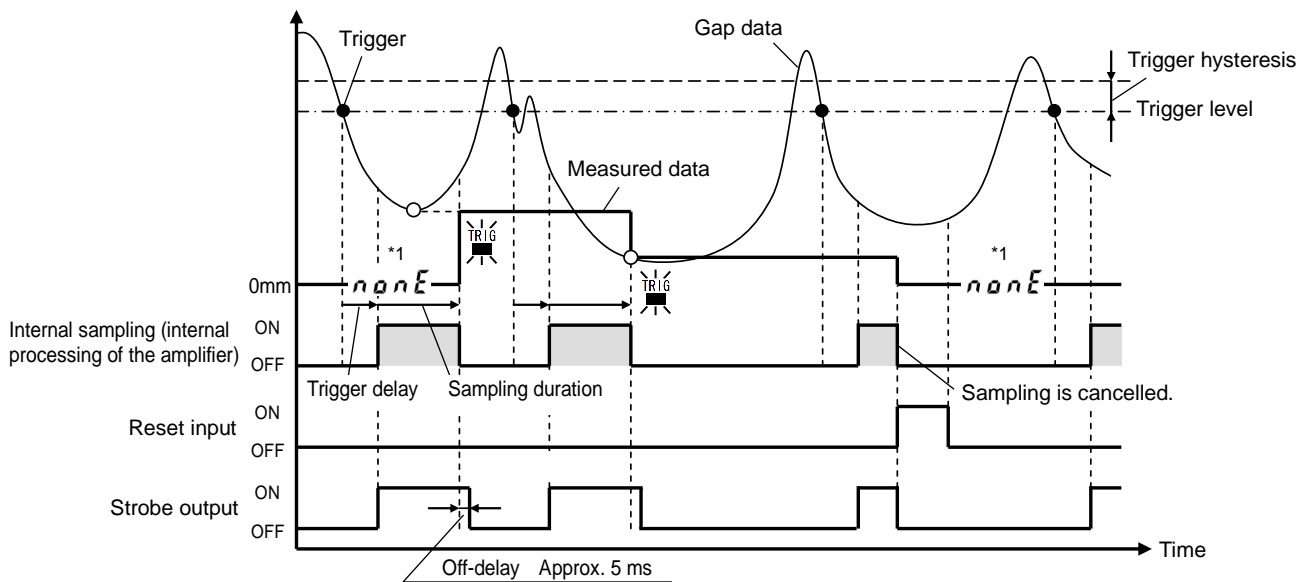

■ Example of Bottom Hold by internal trigger ②

[Trigger direction: ∇ trailing edge, sampling duration = 0 ms]

- A trigger is generated when the gap data falls below the trigger level, and the sampling is started after the trigger delay is over. Then, the sampling ends when the gap data exceeds "Trigger level+Trigger hysteresis," and the minimum value during the sampling duration is held.
- Once a trigger is generated, another trigger will not be generated until the gap data exceeds "Trigger level+Trigger hysteresis."
- The strobe output is kept ON during the sampling duration. However, an off-delay is activated for about 5 ms when the strobe output changes from ON to OFF.
- When the reset input turns on, the measured data is reset and the sampling is canceled.
- The measured data is reset when the power has just been turned on.
- When the measured data is reset, $n\ 0\ 0\ \bar{E}$ is displayed, and the analog output value becomes that at 0 mm. (See *1 in the drawing.)

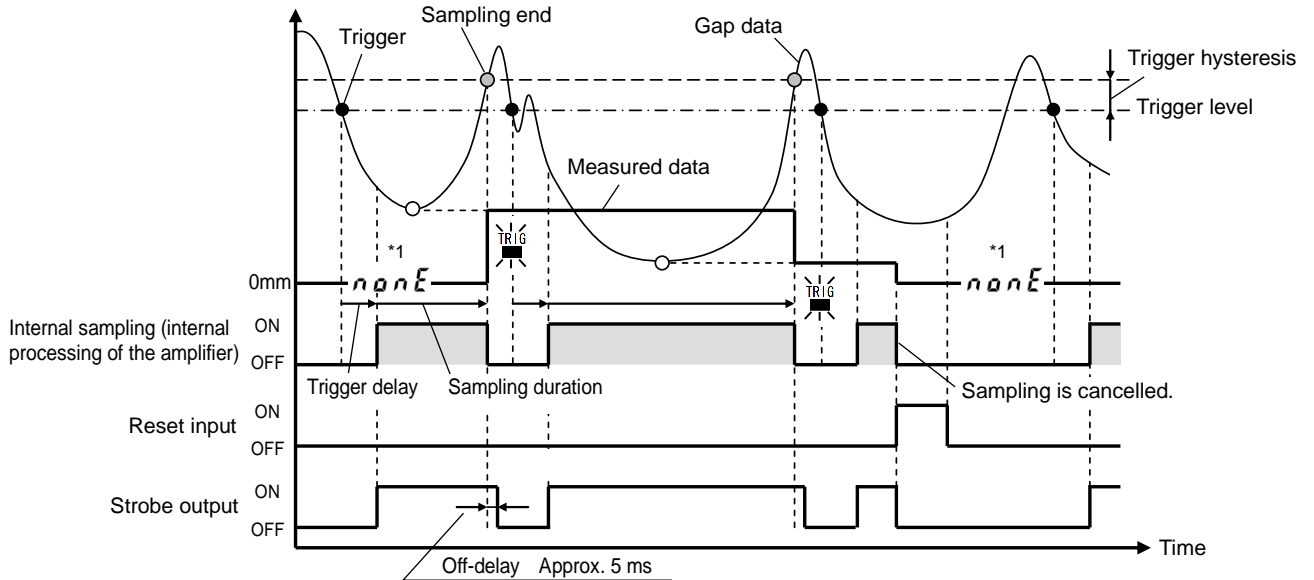

■ Example of Bottom Hold by cycle trigger

- The minimum value during the sampling duration, which is a preset cycle, is held.
- When the measured data is updated, the strobe output is kept ON for a certain period of time (approx. 10 ms).
- When the reset input turns on, the measured data is reset and the sampling is canceled. The sampling is resumed when the reset input turns OFF.
- The measured data is reset when the power has just been turned on.
- When the measured data is reset, $n\ 0\ 0\ \bar{E}$ is displayed, and the analog output value becomes that at 0 mm. (See *1 in the drawing.)

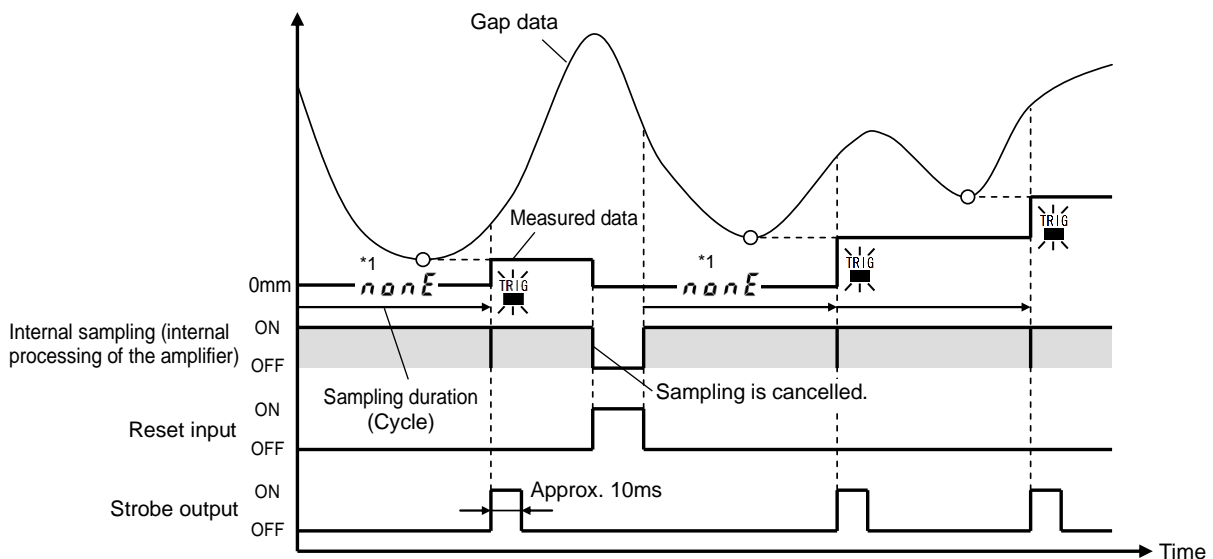

(4) Peak-to-Peak Hold

Holds the “maximum value—minimum value” of the gap data during the sampling duration.

■ Example of Peak-to-Peak Hold by external trigger

- The sampling duration starts at an OFF to ON transition (ON edge) of the external trigger input and continues until another OFF to ON transition (ON edge), and the “maximum value—minimum value” during the duration is held.
- When the measured data is updated, the strobe output is kept ON for a certain period of time (approx. 10 ms).
- When the reset input turns on, the measured data is reset and the sampling is canceled.
- The sampling is resumed when the reset input turns OFF.
- The measured data is reset when the power has just been turned on.
- When the measured data is reset, $n\ 0\ 0\ \bar{E}$ is displayed, and the analog output value becomes that at 0 mm. (See *1 in the drawing.)

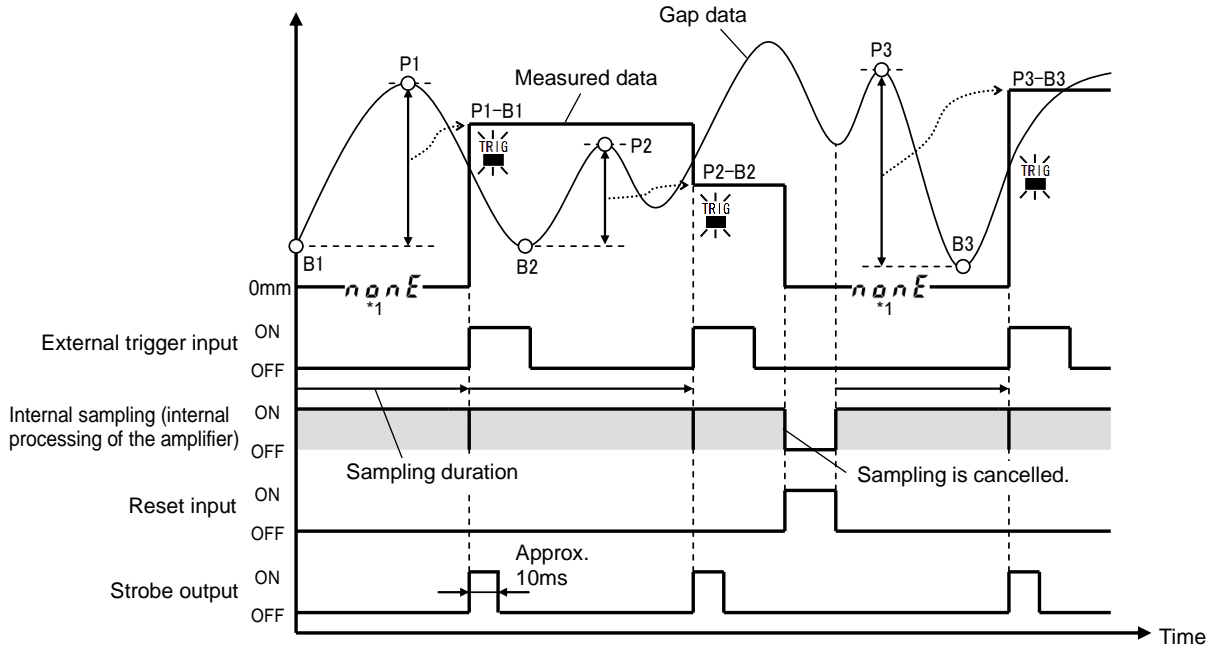

■ Example of Peak-to-Peak Hold by internal trigger ①

[Trigger direction: \uparrow leading edge, sampling duration ≥ 1 ms]

- A trigger is generated when the gap data exceeds the trigger level, and the sampling is started after the trigger delay is over.
- Then, the “maximum value—minimum value” during the sampling duration is held after the duration is over.
- Once a trigger is generated, another trigger will not be generated until the gap data falls below “Trigger level—Trigger hysteresis.”
- The strobe output is kept ON during the sampling duration.
- However, an off-delay is activated for about 5 ms when the strobe output changes from ON to OFF.
- When the reset input turns on, the measured data is reset and the sampling is canceled.
- The measured data is reset when the power has just been turned on.
- When the measured data is reset, $n\ 0\ 0\ \bar{E}$ is displayed, and the analog output value becomes that at 0 mm. (See *1 in the drawing.)

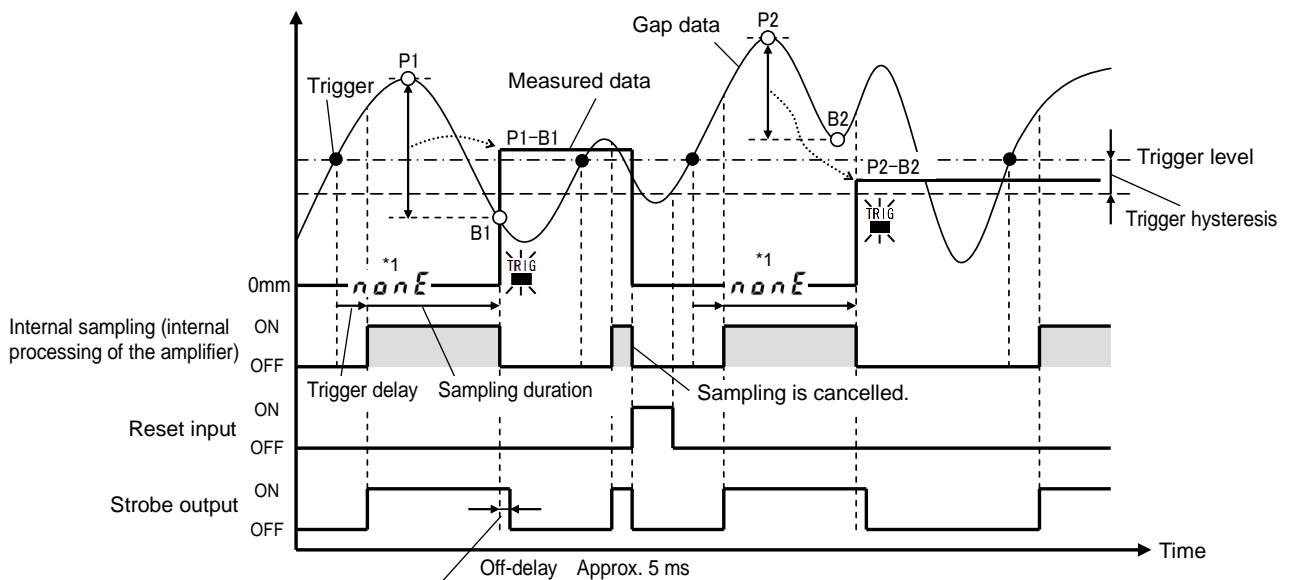

■ Example of Peak-to-Peak Hold by internal trigger ②

[Trigger direction:  leading edge, sampling duration = 0 ms]

- A trigger is generated when the gap data exceeds the trigger level, and the sampling is started after the trigger delay is over. Then, the sampling ends when the gap data falls below "Trigger level - Trigger hysteresis," and the "maximum value - minimum value" during the sampling duration is held.
- Once a trigger is generated, another trigger will not be generated until the gap data falls below "Trigger level - Trigger hysteresis."
- The strobe output is kept ON during the sampling duration. However, an off-delay is activated for about 5 ms when the strobe output changes from ON to OFF.
- When the reset input turns on, the measured data is reset and the sampling is canceled.
- The measured data is reset when the power has just been turned on.
- When the measured data is reset, $n\ 0\ 0\ \bar{E}$ is displayed, and the analog output value becomes that at 0 mm. (See *1 in the drawing.)

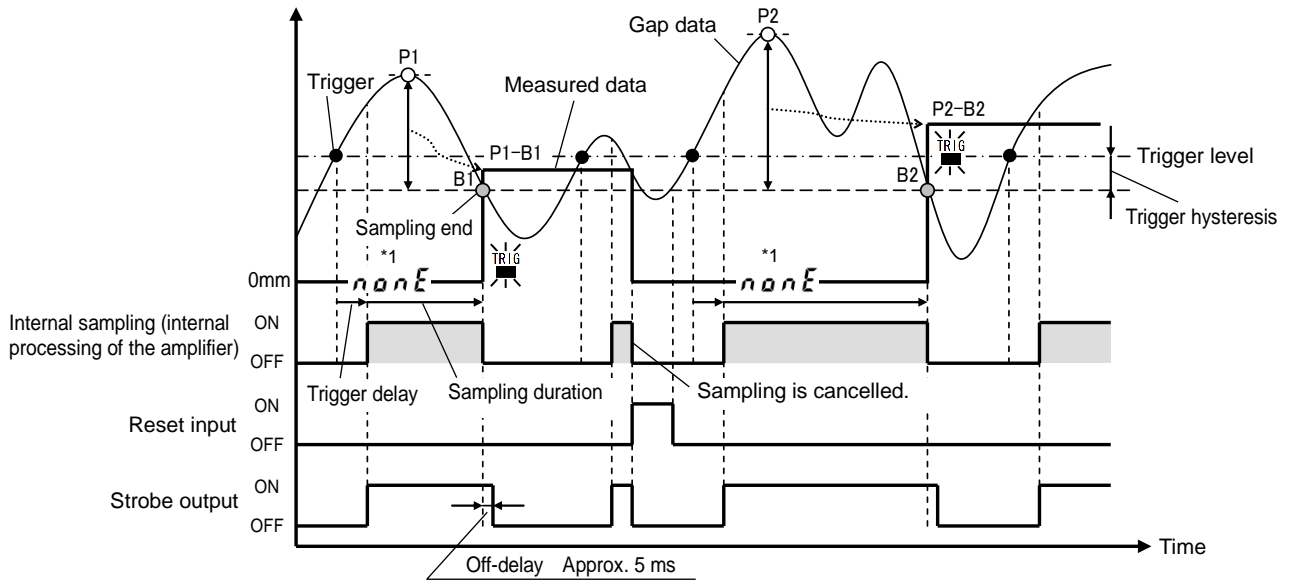

■ Example of Peak-to-Peak Hold by cycle trigger

- The "maximum value - minimum value" during the sampling duration, which is a preset cycle, is held.
- When the measured data is updated, the strobe output is kept ON for a certain period of time (approx. 10 ms).
- When the reset input turns on, the measured data is reset and the sampling is canceled. The sampling is resumed when the reset input turns OFF.
- The measured data is reset when the power has just been turned on.
- When the measured data is reset, $n\ 0\ 0\ \bar{E}$ is displayed, and the analog output value becomes that at 0 mm. (See *1 in the drawing.)

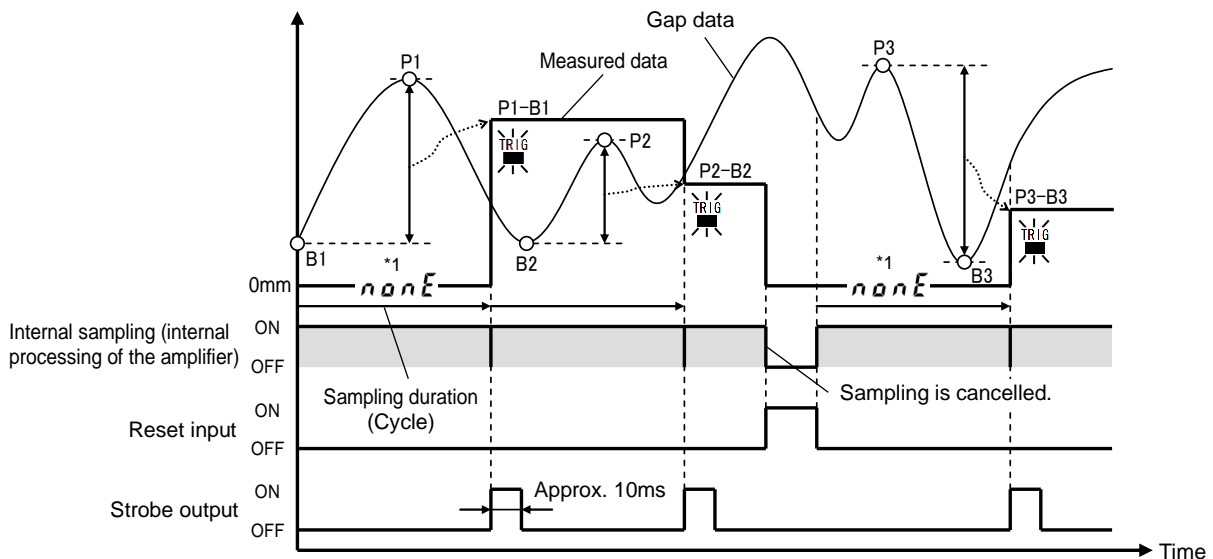

17-3. Procedures for Setting the Measuring Function

(1) Procedures for the external trigger setting

- 1** Set the select No. at "3" in the SET mode.
- "MEAS" is displayed.



- 2** Hold down **ENT** for about 1 second to start the setting.

- 3** Select the Measuring mode.
- Press **↑** to change the setting item.

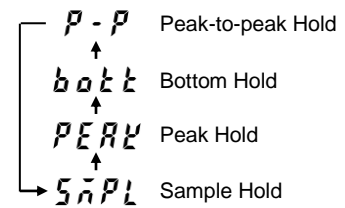

- 4** Press **ENT**. The display blinks rapidly.
Press **ENT** again to start the next setting.



- 5** Select the External trigger at the Trigger Type.
- Press **↑** to change the setting item.

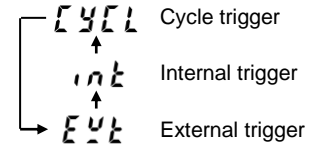
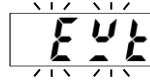

- 6** Press **ENT**. The display blinks rapidly.
Press **ENT** again to complete the setting.
- When the setting is completed, the display returns to 1. **[End]**

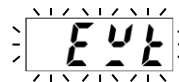

(2) Procedures for the internal trigger setting

- 1** Set the select No. at "3" in the SET mode.
- "MEAS" is displayed.



- 2** Hold down **[ENT]** for about 1 second to start the setting.

- 3** Select the Measuring mode.
- Press **↑** to change the setting item.

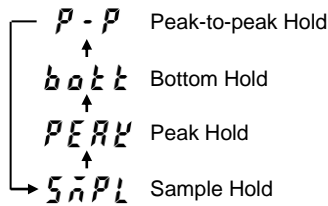

- 4** Press **[ENT]**, The display blinks rapidly. Press **[ENT]** again to start the next setting.



- 5** Select the internal trigger at the trigger type.
- Press **↑** to change the setting item.

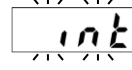
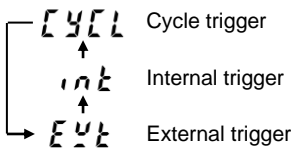

- 6** Press **[ENT]**, The display blinks rapidly. Press **[ENT]** again to start the next setting.

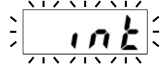

- 7** Select the trigger direction.
- Press **↑** to change the setting item.

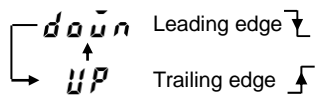

- 8** Press **[ENT]**, The display blinks rapidly. Press **[ENT]** again to start the next setting.

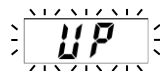

- 9** Set the trigger level.
- Press **↑** to change the value at the blinking digit.
- Press **→** to change the blinking digit.
- During setting, "L" is displayed in the select display part.

Displays in mm.
Setting range: 0 to 99.99 mm

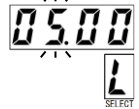

- 10** Press **[ENT]**, The display blinks rapidly. Press **[ENT]** again to start the next setting.

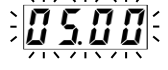

- 11** Set the trigger hysteresis.
- Press **↑** to change the value at the blinking digit.
- Press **→** to change the blinking digit.
- During setting, "h" is displayed in the select display part.

Displays in mm.
Setting range: 0 to 9.99 mm

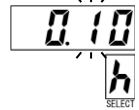

- 12** Press **[ENT]**, The display blinks rapidly. Press **[ENT]** again to start the next setting.

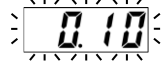

- 13** Set the trigger delay.
- Press **↑** to change the value at the blinking digit.
- Press **→** to change the blinking digit.
- During setting, "d" is displayed in the select display part.

Displays in ms.
Setting range: 0 to 9999 ms



- 14** Press **[ENT]**, The display blinks rapidly. Press **[ENT]** again to start the next setting.

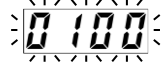

- 15** Set the sampling duration.
- Press **↑** to change the value at the blinking digit.
- Press **→** to change the blinking digit.
- During setting, "S" is displayed in the select display part.

Displays in ms.
Setting range: 0 to 9999 ms



- 16** Press **[ENT]**, The display blinks rapidly. Press **[ENT]** again to complete the setting.
- When the setting is completed, the display returns to 1. **[End]**



(3) Procedures for the cycle trigger setting

- 1** Set the select No. at "3" in the SET mode.
 - "MEAS" is displayed.



- 2** Hold down **ENT** for about 1 second to start the setting.

- 3** Select the Measuring mode.
 - Press **↑** to change the setting item.

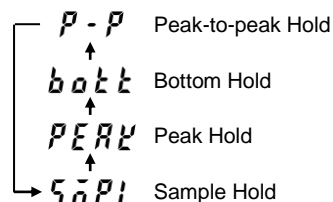
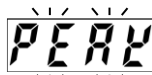

- 4** Press **ENT**. The display blinks rapidly.
 Press **ENT** again to start the next setting.

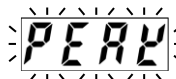

- 5** Select the cycle trigger at the trigger type
 - Press **↑** to change the setting item.

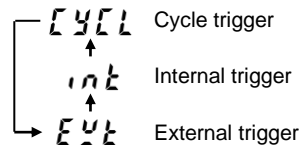

- 6** Press **ENT**. The display blinks rapidly.
 Press **ENT** again to start the next setting.



- 7** Set the cycle.
 - Press **↑** to change the value at the blinking digit.
 - Press **→** to change the blinking digit.



Displays in ms.
 Setting range: 1 to 9999 ms

- 8** Press **ENT**. The display blinks rapidly.
 Press **ENT** again to complete the setting.
 - When the setting is completed, the display returns to 1. **[End]**



18. USE the ANALOG OUTPUT FUNCTION

18-1. Description of the Analog Output Function

Data for analog output can be selected from “gap data,” “measured data,” “temperature data,” and “vibration amplification data (Analog output 2 only).” There are two analog output channels, and each channel can be set individually. Scaling can be set when “gap data” or “measured data” is selected. “Vibration amplification data” can be selected only for the analog output 2 (AOUT2 terminal block), which outputs vibrational components of gap data after amplifying them.

■ Description of output data

Display	Name	Description																												
	Gap data	<p>Outputs gap data. Scaling can be set. The factory setting for scaling is shown in the following table.</p> <table border="1"> <thead> <tr> <th>GTA-120V[] (Voltage output model)</th> <th>GTA-120A[] (Current output model)</th> </tr> </thead> <tbody> <tr> <td>Gap data: 0 to 10mm [1mm/V]</td> <td>Gap data: 0 to 16mm [1mm/mA]</td> </tr> <tr> <td>Analog output: 0 to 10V (※)</td> <td>Analog output: 4 to 20mA</td> </tr> </tbody> </table> <p>※: The analog voltage is output up to maximum 12 V (12 mm) even when exceeding 10 V.</p>	GTA-120V[] (Voltage output model)	GTA-120A[] (Current output model)	Gap data: 0 to 10mm [1mm/V]	Gap data: 0 to 16mm [1mm/mA]	Analog output: 0 to 10V (※)	Analog output: 4 to 20mA																						
GTA-120V[] (Voltage output model)	GTA-120A[] (Current output model)																													
Gap data: 0 to 10mm [1mm/V]	Gap data: 0 to 16mm [1mm/mA]																													
Analog output: 0 to 10V (※)	Analog output: 4 to 20mA																													
	Measured data	<p>Outputs measured data of the measuring function. Scaling can be set. The factory setting for scaling is the same as that for gap data.</p>																												
	Temperature data	<p>Outputs temperature data. Scaling is fixed as shown in the following table.</p> <table border="1"> <thead> <tr> <th>GTA-120V[] (Voltage output model)</th> <th>GTA-120A[] (Current output model)</th> </tr> </thead> <tbody> <tr> <td>Temperature data: 0 to 100°C [10°C/V]</td> <td>Temperature data: 0 to 160°C [10°C/mA]</td> </tr> <tr> <td>Analog output: 0 to 10V (※)</td> <td>Analog output: 4 to 20mA</td> </tr> </tbody> </table> <p>※: The analog voltage is output up to maximum 12 V (120°C) even when exceeding 10 V.</p>	GTA-120V[] (Voltage output model)	GTA-120A[] (Current output model)	Temperature data: 0 to 100°C [10°C/V]	Temperature data: 0 to 160°C [10°C/mA]	Analog output: 0 to 10V (※)	Analog output: 4 to 20mA																						
GTA-120V[] (Voltage output model)	GTA-120A[] (Current output model)																													
Temperature data: 0 to 100°C [10°C/V]	Temperature data: 0 to 160°C [10°C/mA]																													
Analog output: 0 to 10V (※)	Analog output: 4 to 20mA																													
	Vibration amplification data	<p>Outputs vibrational components of gap data after amplifying them. DC components are eliminated and only the vibrational components (AC components) are extracted. In doing so, the vibration waveform can be observed without output clipping even when the sensor position changes. The HPF cutoff frequency to eliminate DC components can be selected at four stages from 0.2 to 100 Hz. The scaling factor can be selected from x1, x10, and x100. The center value of the analog output range (6 V or 12 mA) is output without vibration (0 mm).</p> <p>■ Characters of vibration amplification data</p> <p>■ HPF cutoff frequency</p> <table border="1"> <thead> <tr> <th>Display</th> <th>HPF cutoff frequency</th> <th>Display</th> <th>HPF cutoff frequency</th> </tr> </thead> <tbody> <tr> <td></td> <td>100 Hz</td> <td></td> <td>1.6 Hz</td> </tr> <tr> <td></td> <td>13 Hz</td> <td></td> <td>0.2 Hz</td> </tr> </tbody> </table> <p>※The factory setting is .</p> <p>■ Scaling factor</p> <table border="1"> <thead> <tr> <th>Display</th> <th>Scaling factor</th> <th>GTA-120V[] (Voltage output model)</th> <th>GTA-120A[] (Current output model)</th> </tr> </thead> <tbody> <tr> <td></td> <td>x1</td> <td>(12 V: +6.00 mm) (6 V: 0.00 mm) (0 V: -6.00 mm) [1mm/V]</td> <td>(20 mA: +8.00 mm) (12 mA: 0.00 mm) (4 mA: -8.00 mm) [1mm/mA]</td> </tr> <tr> <td></td> <td>x10</td> <td>(12 V: +0.60 mm) (6 V: 0.00 mm) (0 V: -0.60 mm) [0.1mm/V]</td> <td>(20 mA: +0.80 mm) (12 mA: 0.00 mm) (4 mA: -0.08 mm) [0.1mm/mA]</td> </tr> <tr> <td></td> <td>x100</td> <td>(12 V: +0.06 mm) (6 V: 0.00 mm) (0 V: -0.06 mm) [0.01mm/V]</td> <td>(20 mA: +0.08 mm) (12 mA: 0.00 mm) (4 mA: -0.08 mm) [0.01mm/mA]</td> </tr> </tbody> </table> <p>※The factory setting is </p>	Display	HPF cutoff frequency	Display	HPF cutoff frequency		100 Hz		1.6 Hz		13 Hz		0.2 Hz	Display	Scaling factor	GTA-120V[] (Voltage output model)	GTA-120A[] (Current output model)		x1	(12 V: +6.00 mm) (6 V: 0.00 mm) (0 V: -6.00 mm) [1mm/V]	(20 mA: +8.00 mm) (12 mA: 0.00 mm) (4 mA: -8.00 mm) [1mm/mA]		x10	(12 V: +0.60 mm) (6 V: 0.00 mm) (0 V: -0.60 mm) [0.1mm/V]	(20 mA: +0.80 mm) (12 mA: 0.00 mm) (4 mA: -0.08 mm) [0.1mm/mA]		x100	(12 V: +0.06 mm) (6 V: 0.00 mm) (0 V: -0.06 mm) [0.01mm/V]	(20 mA: +0.08 mm) (12 mA: 0.00 mm) (4 mA: -0.08 mm) [0.01mm/mA]
Display	HPF cutoff frequency	Display	HPF cutoff frequency																											
	100 Hz		1.6 Hz																											
	13 Hz		0.2 Hz																											
Display	Scaling factor	GTA-120V[] (Voltage output model)	GTA-120A[] (Current output model)																											
	x1	(12 V: +6.00 mm) (6 V: 0.00 mm) (0 V: -6.00 mm) [1mm/V]	(20 mA: +8.00 mm) (12 mA: 0.00 mm) (4 mA: -8.00 mm) [1mm/mA]																											
	x10	(12 V: +0.60 mm) (6 V: 0.00 mm) (0 V: -0.60 mm) [0.1mm/V]	(20 mA: +0.80 mm) (12 mA: 0.00 mm) (4 mA: -0.08 mm) [0.1mm/mA]																											
	x100	(12 V: +0.06 mm) (6 V: 0.00 mm) (0 V: -0.06 mm) [0.01mm/V]	(20 mA: +0.08 mm) (12 mA: 0.00 mm) (4 mA: -0.08 mm) [0.01mm/mA]																											

- “Vibration amplification data” can be selected only for the analog output 2 (AOUT2 terminal block).
- The digital filter (LPF) setting is effective even when the vibration amplification data is selected. Observe the vibration waveforms after setting the digital filter at the maximum value (1 kHz) first, and then reset the digital filter according to the vibration frequency.
- Pay attention to the HPF cutoff frequency of the oscilloscope when observing the vibration amplification data with the AC coupling of the oscilloscope. For example, a vibration waveform of 5 Hz cannot be observed properly due to waveform attenuation or other causes as long as the cutoff frequency of the oscilloscope is 10 Hz, even when the HPF cutoff frequency of the amplifier is set to 0.2 Hz. In this case, the data should be observed by DC measurement of the oscilloscope.

■ Description of the gap data (measured data) scaling function

Scaling can be set when gap data or measured data is selected. To set scaling, set desired two points (Input value 1, Input value 2) of the gap data or the measured data and desired two points (Input value 3, Input value 4) of the analog output value.

Set Input value 1, Input value 2, Input value 3, and Input value 4, in this order.

① Example of setting of GTA-120V[] (voltage output model)

Condition	Scaling setting	Setting procedure
Factory setting	Gap (measured) data: 0 to 10 mm Analog output value: 0 to 10 V (※)	[1 V/mm] 0.00 mm (Input value 1) → 10.00 mm (Input value 2) → 0.00 V (Input value 3) → 10.00 V (Input value 4)
Scaling example	Gap (measured) data: 0 to 5 mm Analog output value: 0 to 10 V (※)	[2 V/mm] 0.00 mm (Input value 1) → 5.00 mm (Input value 2) → 0.00 V (Input value 3) → 10.00 V (Input value 4)

※Since the voltage output range is between 0 and 12 V, the gap data is output up to 12 V even when exceeding 10 V.

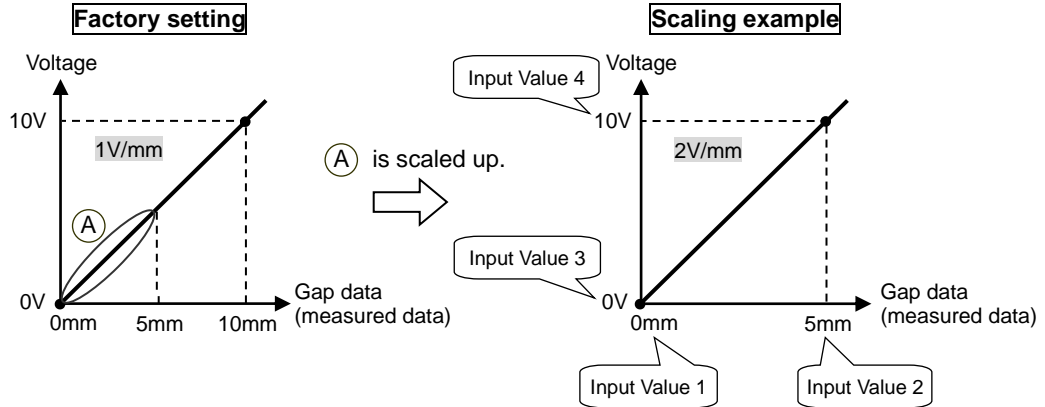

② Example of setting of GTA-120A[] (current output model)

Condition	Scaling setting	Setting procedure
Factory setting	Gap (measured) data: 0 to 16 mm Analog output value: 4 to 20 mA	[1 mA/mm] 0.00 mm (Input value 1) → 16.00 mm (Input value 2) → 4.00 mA (Input value 3) → 20.00 mA (Input value 4)
Scaling example	Gap (measured) data: 0 to 8 mm Analog output value: 4 to 20 mA	[2 mA/mm] 0.00 mm (Input value 1) → 8.00 mm (Input value 2) → 4.00 mA (Input value 3) → 20.00 mA (Input value 4)

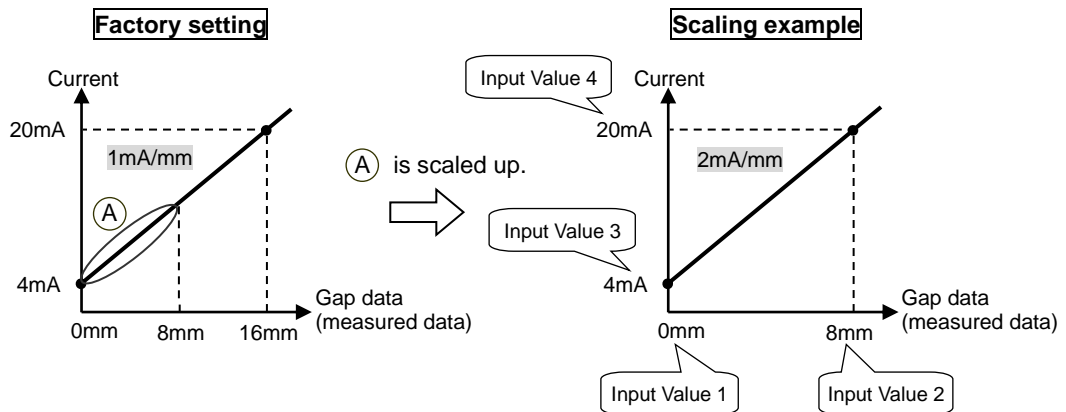

- Output is not clipped when the analog output value is set lower than its range.

For example, when 0.00 mm, 2.00 mm, 0.00 V, and 2.00 V are set to Input values 1 to 4, respectively, in the voltage output model, the voltage higher than 2.00 V is output when the gap data exceeds 2.00 mm.

- When the setting value is not correct, a warning is displayed.

18-2. Procedures for Setting the Analog Output Function

(1) Procedures for analog output of gap data or measured data

The procedures are described using the example of the table below.

Model	Scaling setting	Setting procedure
GTA-120V[] (voltage output model)	Gap (measured) data: 0 to 5 mm [2 V/mm] Analog output value: 0 to 10 V	0.00 mm (Input value 1) → 5.00 mm (Input value 2) → 0.00 V (Input value 3) → 10.00 V (Input value 4)
GTA-120A[] (current output model)	Gap (measured) data: 0 to 8 mm [2 mA/mm] Analog output value: 4 to 20 mA	0.00 mm (Input value 1) → 8.00 mm (Input value 2) → 4.00 mA (Input value 3) → 20.00 mA (Input value 4)

- For Analog output 1, set the select No. at "4" in the SET mode.
For Analog output 2, set the select No. at "5" in the SET mode.
- "ALG1" or "ALG2" is displayed.
- The analog output 1 is output from the AOUT1 terminal block, and the analog output 2 is from the AOUT2 terminal block.

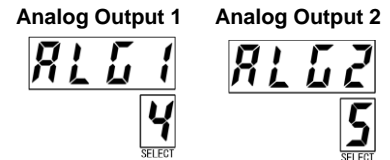

- Hold down **ENT** for about 1 second to start the setting.

- Select gap data or measured data for the output data.
- Press **↑** to change the setting data.



For Analog Output 1

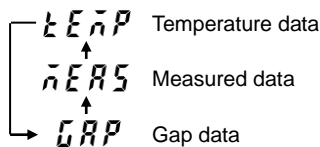

For Analog Output 2

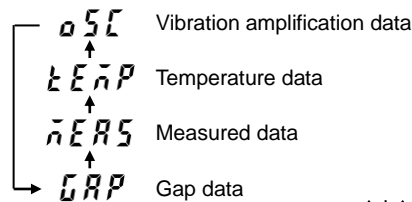

- Press **ENT**. The display blinks rapidly.
Press **ENT** again to start the next setting.

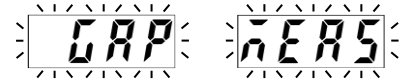

- Enter the input value 1 (gap data or measured data).

- Press **↑** to change the value at the blinking digit.
- Press **→** to change the blinking digit.
- During setting, "1" is displayed in the select display part.

In the case of GTA-120V[] (voltage output model)

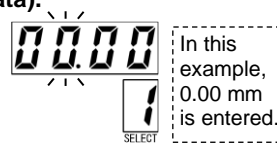

In the case of GTA-120A[] (current output model)

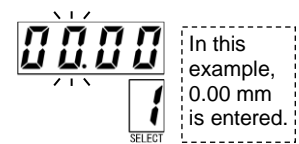

- Press **ENT**. The display blinks rapidly.
Press **ENT** again to start the next setting.



- Enter the input value 2 (gap data or measured data).

- Press **↑** to change the value at the blinking digit.
- Press **→** to change the blinking digit.
- During setting, "2" is displayed in the select display part.

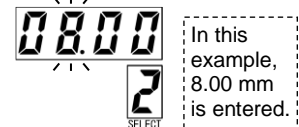
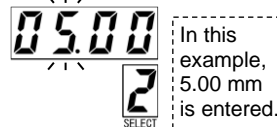

- Press **ENT**. The display blinks rapidly.
Press **ENT** again to start the next setting.

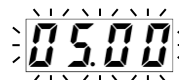

(Continued on Next Page)

- 9 Enter the input value 3 (analog output value).**
- Press to change the value at the blinking digit.
 - Press to change the blinking digit.
 - During setting, "3" is displayed in the select display part.

In the case of GTA-120V[]
(voltage output model)

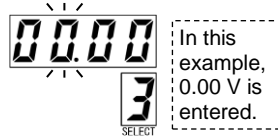

In the case of GTA-120A[]
(current output model)

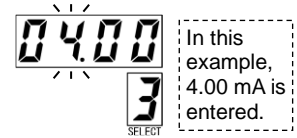

- 10** Press . The display blinks rapidly.
Press again to start the next setting.

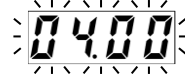

- 11 Enter the input value 4 (analog output value).**
- Press to change the value at the blinking digit.
 - Press to change the blinking digit.
 - During setting, "4" is displayed in the select display part.

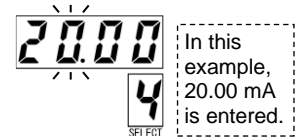
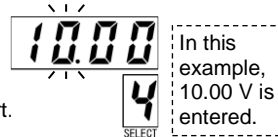

- 12** Press . The display blinks rapidly.
Press again to complete the setting.
- When the setting is completed, the display returns to 1. **[End]**



- Input values 1 and 2 for scaling can be set between 0 and 99.99 mm.
- Input values 3 and 4 for scaling can be set between 0 and 19.99 V for voltage output models and between 0 and 29.99 mA for current output models.
- When the setting value is not correct, a warning is displayed.



- The factory setting for scaling is shown in the following table.

GTA-120V[] (Voltage output model)		GTA-120A[] (Current output model)	
Gap data: 0 to 10mm	[1mm/V]	Gap data: 0 to 16mm	[1mm/mA]
Analog output: 0 to 10V (※)		Analog output: 4 to 20mA	

※Since the voltage output range is between 0 and 12 V, the gap data is output up to 12 V (12 mm) even when exceeding 10 V.

(2) Procedures for analog output of temperature data

- For Analog output 1, set the select No. at "4" in the SET mode.
 For Analog output 2, set the select No. at "5" in the SET mode.

 - "ALG1" or "ALG2" is displayed.
 - The analog output 1 is output from the AOUT1 terminal block, and the analog output 2 is from the AOUT2 terminal block.

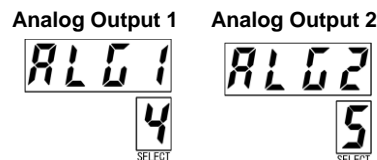

- Hold down **ENT** for about 1 second to start the setting.

- Select the temperature data for the output data.

 - Press **▲** to change the setting data.

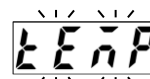

For Analog Output 1

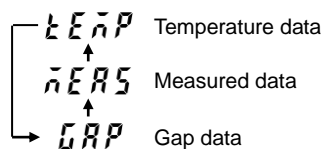

For Analog Output 2

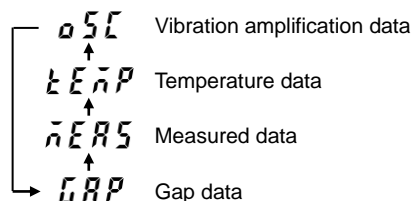

- Press **ENT**. The display blinks rapidly.

 - Press **ENT** again to complete the setting.
 - When the setting is completed, the display returns to 1. **[End]**

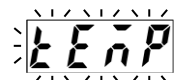

POINT

The temperature data for scaling is fixed as shown in the following table.

GTA-120V[] (Voltage output model)		GTA-120A[] (Current output model)
Temperature data: 0 to 100°C	[10°C/V]	Temperature data: 0 to 160°C
Analogue output: 0 to 10V (※)		Analogue output: 4 to 20mA
		[10°C/mA]

※Since the voltage output range is between 0 and 12 V, the gap data is output up to 12 V (120°C) even when exceeding 10 V.

(3) Procedures for analog output of vibration amplification data (Analog output 2 only)

- 1 Set the select No. at "5" in the SET mode.
 - "ALG2" is displayed.
 - The analog output 2 is output from the AOUT2 terminal block.



- 2 Hold down **[ENT]** for about 1 second to start the setting.

- 3 Select the vibration amplification data for the output data.
 - Press **▲** to change the setting data.

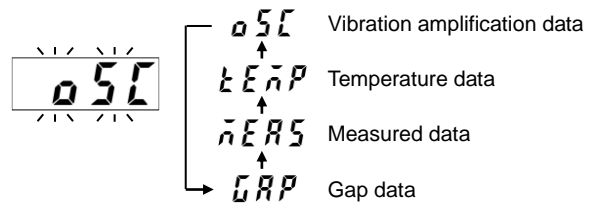

- 4 Press **[ENT]**. The display blinks rapidly.
 Press **[ENT]** again to start the next setting.



- 5 Select the HPF cutoff frequency.
 - Press **▲** to change the setting value.

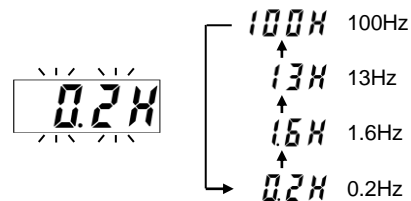

- 6 Press **[ENT]**. The display blinks rapidly.
 Press **[ENT]** again to start the next setting.

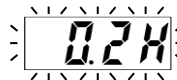

- 7 Set the scaling factor.
 - Press **▲** to change the setting value.

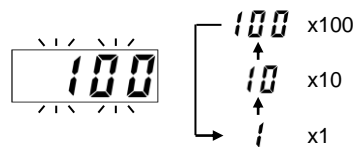

- 8 Press **[ENT]**. The display blinks rapidly.
 Press **[ENT]** again to complete the setting.
 - When the setting is completed, the display returns to 1. **[End]**



- "Vibration amplification data" can be selected only for the analog output 2 (AOUT2 terminal block).
- The digital filter (LPF) setting is effective even when the vibration amplification data is selected. Observe the vibration waveforms after setting the digital filter at the maximum value (1 kHz) first, and then reset the digital filter according to the vibration frequency.
- Pay attention to the HPF cutoff frequency of the oscilloscope when observing the vibration amplification data with the AC coupling of the oscilloscope. For example, a vibration waveform of 5 Hz cannot be observed properly due to waveform attenuation or other causes as long as the cutoff frequency of the oscilloscope is 10 Hz, even when the HPF cutoff frequency of the amplifier is set to 0.2 Hz. In this case, the data should be observed by DC measurement of the oscilloscope.



- See "15. USE the DIGITAL FILTER" for the digital filter.

19. USE the PRESET FUNCTION

19-1. Description of the Preset Function

The preset function shifts the gap data to a desired value. When the gap data has shifted slightly due to a mechanical factor after calibration, the gap data can be corrected immediately. (Note that errors which cause a shift of the linearity can be corrected but those which change the slope of the linearity cannot be corrected because the gap data shifts entirely by the preset function.)

By setting a desired preset value before executing the preset, the present gap data changes to the preset value. However, the preset cannot be executed if the original gap data is out of the acceptable range. (See the table below.) The gap data returns to the original value when the preset is cancelled. The preset display part lights up when the preset is executed, and goes off when the preset is cancelled. The execution or cancellation of the preset is made by switch operation or input signal. Note that the input signal is effective to execute the preset but not to cancel it.

The following charts show an example of executing the preset to shift the gap data 0.500 mm to 0.000 mm.

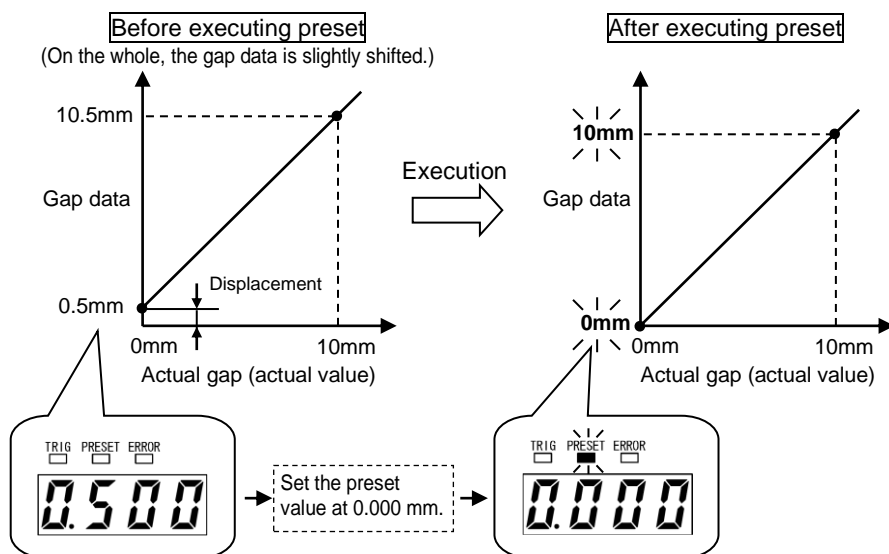

Range in which the preset can be executed

The preset cannot be executed when the gap data before executing is out of the acceptable range. For example, when the sensor type is GPS-28 and the preset value is set at 1.00 mm, the preset can be executed only when the gap data before executing the preset is within a range between -11.00 mm and +13.00 mm.

Sensor Model	Acceptable range for executing preset
GPS-17[][][]-[]	Preset value \pm 6 mm
GPS-28[][][]-[]	Preset value \pm 12 mm
GPS-60[][][]-[]	Preset value \pm 26 mm



- The gap data shifts entirely when the preset is executed. Errors which cause a shift of the linearity can be corrected but those which change the slope of the linearity cannot be corrected. In this case, perform calibration again.
- When the preset is executed beyond the acceptable range for executing, a warning nE is displayed.
- The preset cannot be executed nor cancelled when a sensor disconnected error occurs.
- The preset is cancelled when "Preset value," "Sensor type and cable length setting," "Interference prevention setting," "Sensor temperature adjustment," "Detection object material setting," "Offset cancellation," or "Calibration" is reset.



- The preset can be cancelled regardless of the acceptable range.



19-2. Procedures for Setting the Preset Value

- 1** Set the select No. at "6" in the SET mode.
- "PSET" is displayed.



- 2** Hold down **ENT** for about 1 second to start the setting.

- 3** Enter the preset value.

- Press  to change the value at the blinking digit.
- Press  to change the blinking digit.

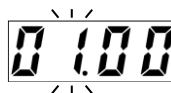

Displays in mm.
Setting range: 0~99.99 mm

- 6** Press **ENT**. The display blinks rapidly.
Press **ENT** again to complete the setting.
- When the setting is completed, the display returns to 1. **[End]**



- The preset will be cancelled if the preset value is set again when the preset is executed.

19-3. Procedures for Executing/Cancelling the Preset

(1) Procedures to execute the preset by switch operation

The procedures are described below using an example of executing the preset of the gap data at 0 mm.
(The gap data has been preset at 0 mm.)

1 Set the preset value in advance.

2 Make sure that the preset display part light turned off and the preset is cancelled.
- When the preset display part lights up, the preset should be canceled.



3 Set the select No. at "0" in the RUN mode. The gap data will be displayed.



4 Hold down **PRESET** (**ENT**) for about 1 second.
The blinking "P. on" is displayed.

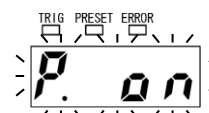

5 Press **PRESET** (**ENT**) again to execute the preset.
- The preset display part lights up and the gap data becomes the preset value. [End]



REF.

- See "19-2. Procedures for setting the preset value" for details of the procedures for setting the preset value.
- See "27-3. Timing Chart" for the timing.

(2) Procedures for cancelling the preset by switch operation

- 1** Make sure that preset display part lights up and the preset is executed.
- When the preset display part light is OFF, the preset is cancelled.



- 2** Set the select No. at "0" in the RUN mode. The gap data will be displayed.

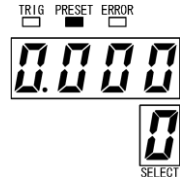

- 3** Hold down **PRESET** (**ENT**) for about 1 second.
The blinking "P. off" is displayed.



- 4** Press **PRESET** (**ENT**) again to cancel the preset.
- The preset display part light turns off and the gap data becomes the original value. [End]

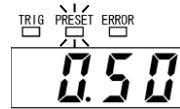

- See "27-3. Timing Chart" for the timing.

(3) Procedures for executing the preset by the input signal (No cancellation can be made by the input signal.)

- 1** Select the lock state and the RUN mode.
 - In a case other than “the lock state and the RUN mode,” the preset input signal cannot be accepted.

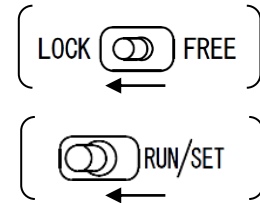

- 2** Set the select No. at “0” in the RUN mode. The gap data will be displayed.

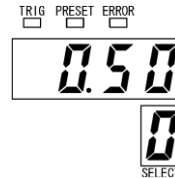

- 3** Switch the preset input signal from OFF to ON to execute the preset.
 - To execute the preset again, repeat the step 3.
 - To cancel the preset, operate the switches on the panel. **[End]**



- The preset input signal can only execute the preset.
To cancel the preset, operate the switches on the panel.
- The preset input signal is accepted only in “the lock state and the RUN mode.”
When the preset input signal is switched from OFF to ON in other cases, a warning **F r E E** is displayed.
- The preset input signal is not accepted when a sensor disconnected error occurs.
- When the I/O connector or the external power supply for the I/O is disconnected while the input signal is ON, an unexpected input may be made.



- See “4-4. I/O Connections and Functions” for details of I/O connections and functions.
- See “27-3. Timing Chart” for details of the timing.

20. RUN-OUT REDUCTION

- The RUN-OUT reduction function is available after version *B (last character is B). Refer to 25-4-(3) for checking the version seal.
- Do not change the factory setting usually. (Factory setting: r o i)
- Set correctly by following the procedures when the gap data is volatile because of RUN-OUT.

20-1. Explanation of the RUN-OUT reduction function

The RUN-OUT reduction function reduces the fluctuation of the gap data because of RUN-OUT.

(For the explanation of RUN-OUT phenomenon, refer to "27-2. RUN-OUT".)

This function will be available if the sensor model setting is "GPS-28" and the detection object material setting is "FE2".

The sensor sensitivity can be changed for RUN-OUT by changing the RUN-OUT reduction No. 1 to 5.

(The factory setting is 1, and it operates normally.)

The proper setting value is different by the detection object, so the setting should be changed by each detection object. However, execute the setting with care. Conversely, sometimes the fluctuation might be getting worse or not changing. Depending on the usage environment, the temperature characteristic might be getting worse after changing the RUN-OUT reduction No. from the factory setting.

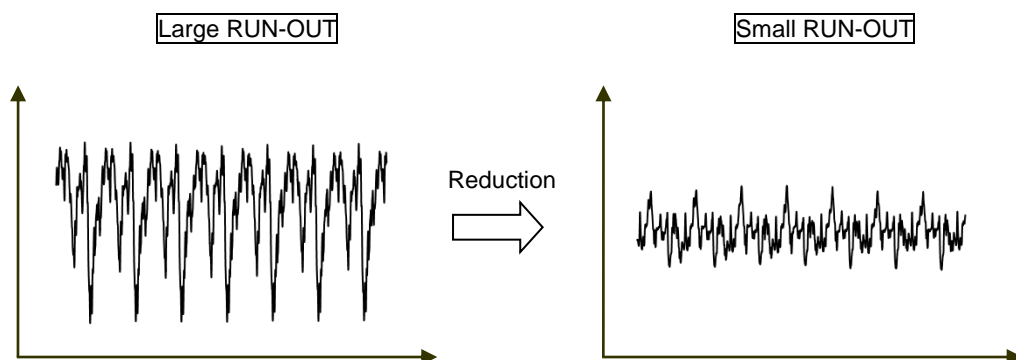

- This function will be available if the sensor model setting is "GPS-28" and the detection object material setting is "FE2".
- Reset the offset cancellation and calibration when changing the RUN-OUT reduction function.



- For the explanation of RUN-OUT phenomenon, refer to "27-2. RUN-OUT".
-

20-2. Procedures before the operation by using the RUN-OUT reduction function

Searches the number that the peak to peak of the gap data becomes the smallest value by changing the RUN-OUT reduction number. During the search, we only need the relative difference of each number. Execute the "offset cancellation" not the calibration (pt.0). After deciding the most proper number, execute the calibration normally. If you found several proper numbers, set the smallest number.

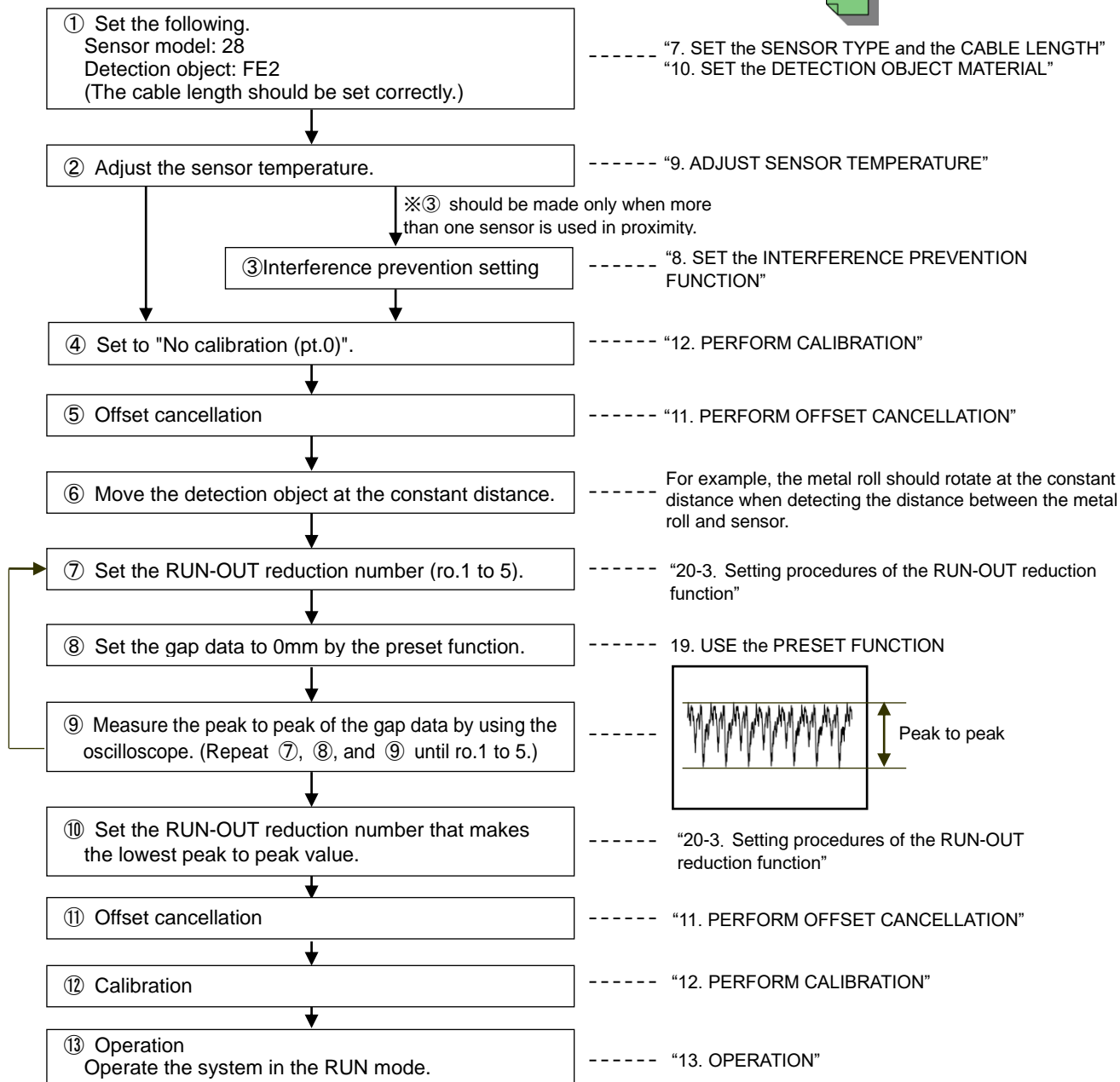

- ⑧The preset might not be need to execute in order to execute the measurement at procedure ⑨ easily.
- Measure the peak to peak by using the "measurement function (Chapter. 17)" if there is no measurement device such as a oscilloscope in procedure ⑨.
- If you found several proper numbers in procedure ⑨, set the smallest number.
For example, ro.3 and ro. 4 of the peak to peak are almost same in following figures, but select ro.3.

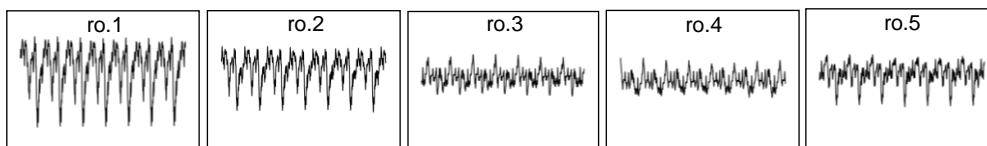

- In the case of changing RUN-OUT reduction number after the calibration in procedure ⑫, reset the offset cancellation and calibration.

20-3. Setting Procedures of the RUN-OUT Reduction Function

1 Set the following.

Sensor model: 28 (GPS-28)
 Detection object material: FE2 (FC250)

Sensor model

28

Detection object material

FE2

- **----** is displayed excepting this setting,
 but "ro. []" is not displayed in procedure 2 .

-The cable length should be set correctly.

2 Set the select No. at "7" in the SET mode.

- The current setting "ro. []" is displayed.

ro. 1

7
SELECT

3 Hold down **ENT** for about 1 second to start the setting.

4 Selects the "RUN-OUT reduction number".

- Press **↑** to change the setting value.

ro. 2

ro. 5 5th
 ↑
 ro. 1 1st

5 Press **ENT**. The display blinks rapidly.

Press **ENT** again to complete the setting.

- When the setting is completed, the display returns to 1. **[End]**

ro. 2



- This function will be available only when the sensor model setting is "GPS-28" and the detection object material setting is "FE2".

- Reset the offset cancellation and calibration when changing the RUN-OUT reduction function.

21. USE the PROGRAM FUNCTION

21-1. Description of the Program Function

The program function memorizes setting values independently in each program No.. The maximum numbers of program are four. The setting values can be switched quickly just by changing the program number. For example, once the setting values are memorized for each of detection object materials, the system can be operated immediately just by switching the program numbers when the detection object material is changed. In addition, the values can be copied between the programs; therefore, they can be used as a backup of the setting values. In addition, setting values of a specified program number can be reset to the factory setting. The program function can be used by switch operation or input signals.

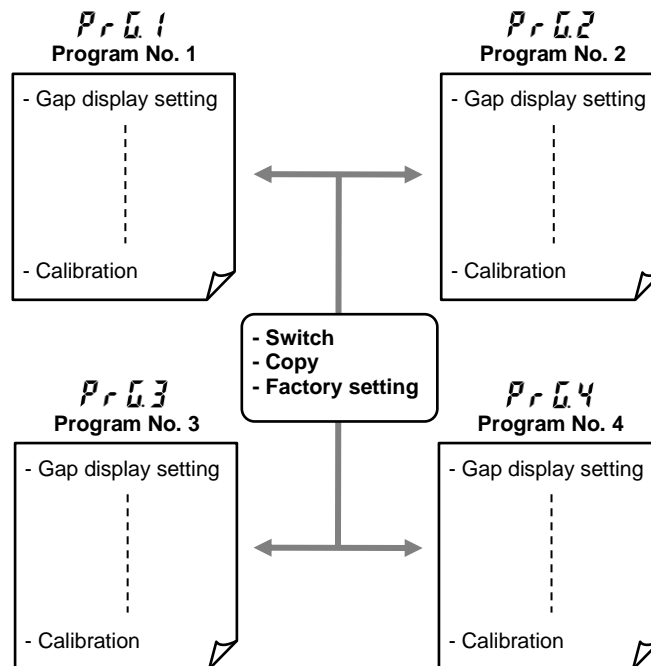

- Do not change the program number when the program function is not used.
- The factory setting is Program No. 1.



POINT

- Examples of use and advantages of the program function:
 - 1) Setting values can be used as backups by copying programs.
 - 2) Comparative tests of linearity can be conducted by changing calibration conditions.
 - 3) Set-up change is easy when more than one sensor or detection object is used.
 - 4) The amplifier can be shared among more than one user.

21-2. Procedures for Switching Programs

(1) Switch programs by switch operation

- 1** Set the select No. at "F" in the SET mode.
- The present program number is displayed.



- 2** Hold down **[ENT]** for about 1 second to start the setting.

- 3** Select the program number.
- Press **▲** to change the setting value.

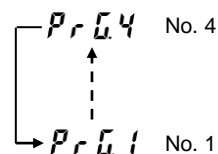
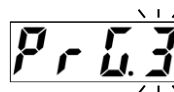

- 4** Press **[ENT]**. The display blinks rapidly.
Press **[ENT]** again to complete the setting.
- When the setting is completed, the display returns to 1. **[End]**

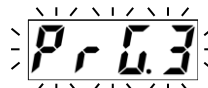

(2) Switch programs by the input signal

- 1** Select the lock state and the RUN mode.
 - In a case other than “the lock state and the RUN mode,” the program enable (PRGEN) input signal cannot be accepted.

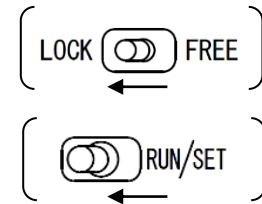

- 2** Turn on or off the program setting 0 (PRG0) and the program setting 1 (PRG1) to select the program number to enable.

- 3** Switch the program enable (PRGEN) input signal from OFF to ON to enable the selected program. **[End]**



- For switching programs, the program enable input signal is accepted only in “the lock state and the RUN mode.” When the program enable input signal is switched from OFF to ON in other cases, a warning **FrEE** is displayed.
- The program enable input signal is not accepted when a sensor disconnected error occurs.
- When the I/O connector or the external power supply for the I/O is disconnected while the input signal is ON, an unexpected input may be made.

- Functions of the program enable input signal is shown in the table below. See “4-4. I/O Connections and functions” for details.



PRG0	PRG1	PRGEN	Function
OFF	OFF	OFF→ON (ON edge)	Switches to Program 1.
ON	OFF		Switches to Program 2.
OFF	ON		Switches to Program 3.
ON	ON		Switches to Program 4.
Don't care	Don't care	ON→OFF (OFF edge)	No function

- See “27-3. Timing Chart” for details of the timing.

(3) Copy programs (only by switch operation)

Programs setting values can be copied from the present program number (source) to the other program number (destination). The procedures are described below using an example of copying the setting values from the program 1 to the program 3.

- 1** Set the select No. at "F" in the SET mode.
 - The present program No. (source) is displayed.
 - See "21-2. Procedures for Switching Programs" to change the program number.



- 2** Hold down **ENT** and **↑** for 2 seconds simultaneously to start setting.
 - This is a special operation different from others.

- 3** Select the copy.
 - Press **↑** to change the setting item.

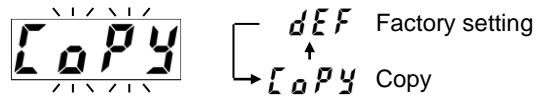

- 4** Press **ENT**. The display blinks rapidly.
 Press **ENT** again to start the next setting.



- 5** Select the program No. to copy to.
 - Press **↑** to change the setting value.
 - Note that the present program number (source) cannot be changed at this point.

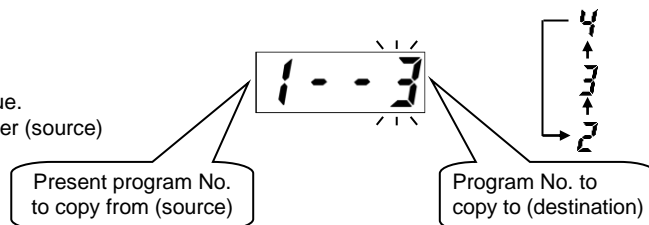

- 6** Press **ENT**. The display blinks rapidly.
 Press **ENT** again to copy the program setting values.
 - When the copying is completed, the display returns to 1. **[End]**

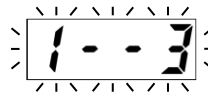

- Programs setting values can be copied from the present program number (source) to the other program number (destination).

- Check the program numbers of the copy source and destination carefully before copying.

(4) Reset program setting values to the factory setting (only by switch operation)

Program setting values can be reset to the factory setting on the currently selected program number. The procedures are described below using an example of resetting the setting values of the program 2 to the factory setting.

- 1** Set the select No. at "F" in the SET mode.
- The present program No. is displayed.
- See "21-2. Procedures for Switching Programs" to change the program number.



- 2** Hold down **ENT** and **▲** for 2 seconds simultaneously to start setting.
- This is a special operation different from others.

- 3** Select the factory setting.
- Press **▲** to change the setting item.

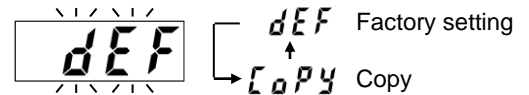

- 4** Press **ENT**. The display blinks rapidly.
Press **ENT** again to reset the setting values of the present program No. to the factory setting.
- When the resetting is completed, the display returns to 1. **[End]**



- Program setting values can be reset to the factory setting on the currently selected program number.
- Check the program number carefully before resetting it to the factory setting



- See "24-1. Reset All Settings to Factory Setting" to reset all the settings to the factory setting.

22. CHECK the PRESENT SETTING

The present setting value can be checked by specifying the select number of the setting item in the SET mode. It can be made even in the lock state. When there is more than one setting value such as for calibration, each setting value can be checked by pressing .

■Procedures for checking the present setting

The procedures are described below using an example of checking the calibration setting value.

In this example, corrected points are set as follows: Number of corrected points: three; 1st point: 0.00 mm; 2nd point: 2.00 mm; 3rd point: 4.00 mm.

- 1** Set the select No. at "E" in the SET mode.
- "CAL" is displayed.



- 2** Press  to display the number of corrected points.

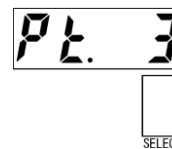

- 3** Press  again to display the setting value of the 1st point.
- "1" is displayed in the select display part

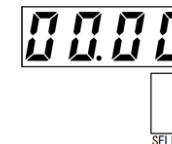

- 4** Press  again to display the setting value of the 2nd point.
- "2" is displayed in the select display part



- 5** Press  again to display the setting value of the 3rd point.
- "3" is displayed in the select display part



- 6** Press  again. The display returns to 1. [End]



POINT

- Check of the setting values can be made even in the lock state.
- The select No. display part displays the same as in setting.
- Pressing  during part of the procedure returns the display to 1.

23. LOCK the SETTING

When the LOCK/FREE switch is set to LOCK, settings are locked. In the lock state, no setting change by switch operation is accepted. When the LOCK/FREE switch is set to FREE, it becomes possible to change settings by switch operation. When the setting is locked, blinking **LOCK** is displayed for about 2 seconds. The preset input signal and the program enable input signal are accepted only in "the lock state and the RUN mode."

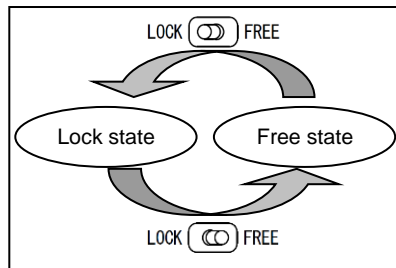

- The height of the LOCK/FREE switch is designed to be low to prevent erroneous operation. Operate the switch paying attention not to apply excessive force to it, using a flat tip screwdriver etc.
- The preset input signal and the program enable input signal are accepted only in "the lock state and the RUN mode." When the preset input signal or the program enable input signal is switched from OFF to ON in other cases, a warning **FREE** is displayed.



- When the setting is locked, blinking **LOCK** is displayed for about 2 seconds.
- When the setting is tried to be changed in the Lock state, blinking **LOCK** is displayed for about 2 seconds.
- The setting can be checked even in the Lock state.



- See "2. NOMENCLATURE" for the operating switch.

- **A rear switch can lock the setting from Version C (last character is C). Refer to 25-4-(3) for checking the version seal.**
- **The switch is hidden by a black seal when shipping from our factory. Remove the seal when using the switch.**
- **The setting is constantly locked when the rear switch is set to "LOCK" even although the front switch is set to "LOCK" or "FREE").**

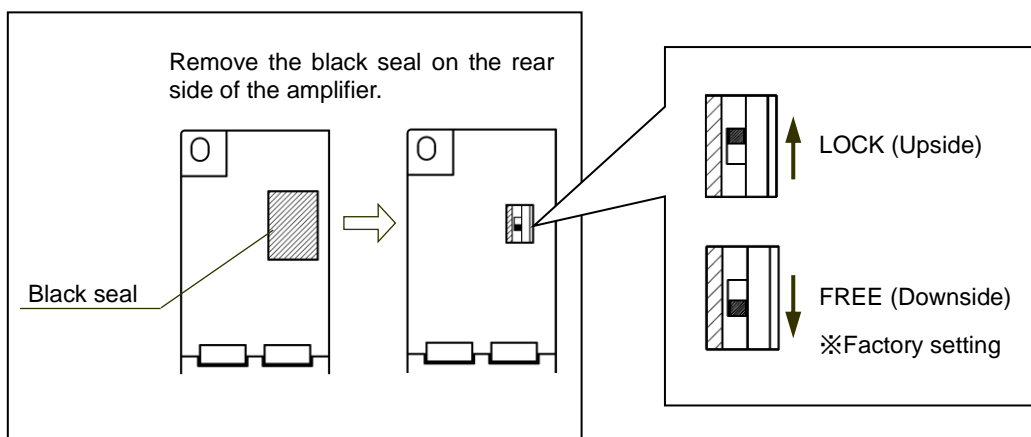

24. SPECIAL SETTING AND DISPLAY

24-1. Reset All Settings to Factory Setting

Proceed when all settings need to be reset to the factory setting, or a user memory error occurs. Since all the settings are reset to the factory setting, careful attention is necessary.

■ Procedures for resetting all settings to the factory setting

1 Turn off the power supply.

2 Set the RUN/SET switch to the SET and set the LOCK/FREE switch to the free.



* Set to "FREE" if the rear switch is used.



3 Turn on the power supply holding down  and **[ENT]**.

4 Keep holding down  and **[ENT]** for about 3 seconds.
- "ALL CLEAR" is displayed in scroll.

5 Hold down **[ENT]** for about 1 second.
- Blinking "GO" is displayed.

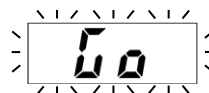

6 Press **[ENT]** again.
All settings are reset to the factory setting and "End" is displayed.

7 Turn the power OFF and then ON again. **[End]**



- Since all the settings are reset to the factory setting, careful attention is necessary.
- After "End" is displayed, it is necessary to turn the power OFF and then ON again.



- When a user memory error occurs, it is necessary to reset the amplifier to the factory setting. See "25-2. Error Message" for more details of user memory errors.
- For the rear switch, refer to "23. Locking the setting".

24-2. Display the Product Version

When the select No. is set at "F" in the RUN mode, the product version is displayed in scroll.
In the example below, the product version is "120VN_1.0_1.0".



120VN_1.0_1.0

24-3. Display the Sensor Status

When the select No. is set at "E" in the RUN mode, the sensor status is displayed.
This is the manufacturer's maintenance data and not intended for a general use.
In the example below, the sensor status is "23".



23

25. TROUBLESHOOTING

25-1. Warning Message

When the input of setting values or any other operation is incorrect, a warning message is displayed in the data display part. Check the following table and take proper measures

- Since the warning is not an error, the error display part does not light up. (ERROR )
- Since the warning is not an error, the system ready signal keeps ON.

Display of warning	Name	Description	Actions to take
<i>OVER</i>	OVER	The gap data greatly exceeds the rated detection range.	Use the system keeping the distance between the sensor and the detection object within the rated detection range. When the warning still continues, check "Sensor type and cable length setting," "Sensor temperature adjustment," and "Detection object material setting", and perform the offset cancellation and calibration again.
<i>NG</i>	NG	The entry of the setting value is not correct.	Enter the correct setting value. See the description of each item for the setting value.
<i>LOCK</i>	LOCK	This warning is issued when the LOCK/FREE switch is operated to lock the settings.	The warning is just a sign to indicate a lock state, and it is not an error.
		This warning is issued when a setting change was attempted in the lock state.	To unlock, set the LOCK/FREE switch to the free side.
<i>FREE</i>	FREE	This warning is issued when the I/O preset input or the program enable input is made in the free state and the RUN mode.	Make the I/O preset input and the program enable input in "the lock state and the RUN mode." - LOCK/FREE switch: Lock state at the lock side - RUN/SET switch: RUN mode at the RUN side

25-2. Error Message

When an error occurs, an error message is displayed. Check the following table and take proper measures.

- The error display part lights up when an error occurs. (ERROR)
- The system ready output signal is turned off when an error occurs. All the other output signals are also turned off.

Display of error	Name	Description	Actions to take
SE	Sensor disconnected error (In the SET mode, only the error display part lights up.)	The sensor is not connected.	Check whether the sensor is connected correctly. When it is connected correctly, the error is reset automatically.
Err 0	Internal data error	An error has occurred to the internal data due to external noises etc.	Turn on the power again. If the error occurs again, inform us. The internal circuit may have a breakdown.
Err 1	CPU error	The CPU made an unexpected operation.	Turn on the power again. If the error occurs again, inform us. The CPU may have a breakdown.
Err 2 Err 3	System memory error	An error has occurred to the system data of the memory due to external noises etc.	Turn on the power again. If the error occurs again, inform us. The nonvolatile memory may have a breakdown. (The system memory error is not reset even with the factory setting.)
Err 4 Err 5 Err 6 Err 7	User memory error	An error has occurred to the user data of the memory due to external noises etc.	Turn on the power again. When the error occurs again, reset the amplifier to the factory setting.  See "24-1. Reset All Settings to Factory Setting."
Err 8	Low power error	The power supply voltage is low.	The power supply may have a breakdown. Replace the power supply. Power supply voltage: 24 VDC±10% (including ripple)

25-3. Other Abnormalities

Check the following table for other abnormalities and take proper measures.

Abnormalities	Estimated causes	Actions to take
Gap data does not change. Gap data moves in an abnormal manner.	- "Sensor type and cable length setting," "Sensor temperature adjustment," or "Detection object material setting" is incorrect. - "Offset cancellation" and "Calibration" are not performed correctly.	Check the "Sensor type and cable length setting," "Sensor temperature adjustment," and "Detection object material setting," and perform the offset cancellation and calibration again.
Temperature data indicates an abnormal (extremely large/small) value.	- The connector(s) for the sensor or the extension cable is (are) loose. - The sensor or the cable has been damaged.	Check that the connector(s) for the sensor or the extension cable is (are) connected securely. If the error continues, the sensor or the cable(s) may have been damaged. Please inform us.
Vibration amplification data for analog output does not change. The amplification is smaller than the actual vibration. The response is slow.	The setting of the digital filter (LPF cutoff frequency) is lower than the observed vibration frequency.	Observe the vibration waveforms after setting the digital filter at the maximum value (1 kHz), and then reset the digital filter according to the vibration frequency.
	The setting of the HPF cutoff frequency is higher than the observed vibration frequency.	Observe the vibration waveforms after setting the HPF cutoff frequency at the minimum value (0.2 Hz), and then reset the HPF cutoff frequency according to the vibration frequency.
	The HPF cutoff frequency of AC coupling of the oscilloscope is lower than the observed vibration frequency.	Observe the vibration waveforms by DC coupling of the oscilloscope.
	The actual vibration waveform moves faster than 1 kHz.	Since the maximum responsiveness of this sensor is 1 kHz, vibration waveforms exceeding 1 kHz cannot be measured precisely.

25-4. Information Required When Reporting a Problem

Should a problem occur with this product, please contact your NSD representative as soon as possible.
Information to report

(1) Sensor model and Serial number

They are printed on the model label around the sensor connector.

MODEL	Model of the sensor
SER.	Serial No. of the sensor
CODE	
	

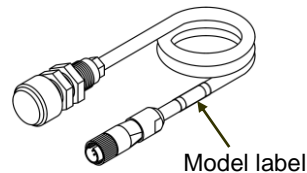

(2) Extension cable model

It is printed on the model label around the sensor connector (amplifier side).
The extension cable has no serial number.

MODEL	Model of the extension cable
	

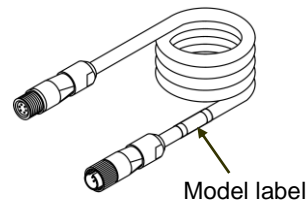

(3) Amplifier model, serial number, and version

They are printed on the model label at the left side of the amplifier.
If you cannot find the label at the left side, please see the label on the top of the amplifier.
The version is printed on the version seal which is indicated the following drawing.

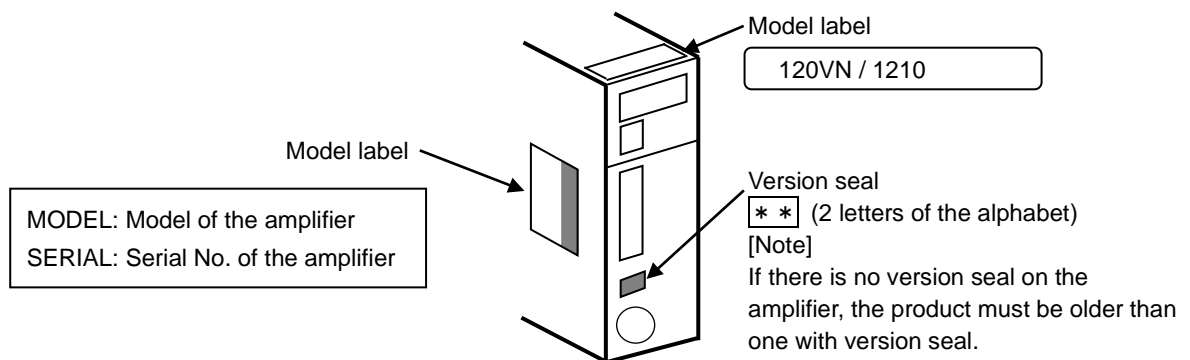

(4) Error details

- (1) Date and time of occurrence
- (2) When did the error occur
 - A. At initial power on
 - B. During test operation
 - C. During continuous operation (approx. ___ months)
- (3) Error occurrence conditions
 - A. At startup
 - B. During operation
- (4) Error description (details)
- (5) Operation conditions
 - A. Machine used
 - B. Status of connection with host controller
 - C. Ambient temperature
 - D. Ambient vibration

(5) Contact information;

Please refer to the back cover.

25-5. Warranty Period and Scope

1. Warranty Period

The warranty period is 1 year from the delivery date.

2. Scope of Warranty

In the event that the unit fails during the above warranty period due to a cause for which NSD is responsible, NSD will replace the failed parts and will perform necessary repairs.

The following problem causes, however, are outside the scope of this warranty.

- (1) Problems caused by mishandling.
- (2) Problems originating outside this unit.
- (3) Problems caused by unauthorized modifications or repairs.
- (4) Problems caused by natural disasters, catastrophes, etc.

This warranty extends only to the delivered product, and does not cover any collateral damage which a malfunction in this product may cause.

25-6. Scope of Service

The purchase price of this product does not include service fees for dispatching engineers, etc. Separate service fees will therefore be imposed for the following types of service.

- (1) Installation guidance and presence at test operation
- (2) Maintenance, inspection, adjustment, and repair
- (3) Technical guidance

26. SPECIFICATIONS

26-1. Performance Specification

Performance specification depends on the sensor type and detection object. Sensor heads with a larger diameter have a broader rated detection range. Magnetic metals (S50C, FC250, SUS430) have a superior performance specification to that of nonmagnetic metals (SUS304, A5052). It is recommended to use the magnetic metals (S50C, FC250, SUS430) unless they are inappropriate.

Items		Specifications		
Model	Sensor	GPS-17[][][-]	GPS-28[][][-]	GPS-60[][][-]
	Extension cable	GPS-C01[-]		
	Amplifier	GTA-120[][]		
Standard detection object	Material	Iron (S50C, FC250), Stainless steel (SUS304, SUS430), Aluminum (A5052)		
	Shape ※1	100 × 100mm, t=5mm	100 × 100mm, t=5mm	150 × 150mm, t=5mm
Resolution The values in parentheses indicate internal processing resolution.		1 μm (0.4 μm)		
Responsivity (-3dB)		Max. 1kHz (Selectable from 1 Hz to 1 kHz by the digital filter)		
Internal sampling frequency		320kHz ※2		
S50C FC250 SUS430	Rated detection range (F.S.)	0 to 6mm	0 to 12mm	0 to 26mm
	Linearity	For calibration at 5 or more points	±0.15% F.S.	
			±9 μm	±18 μm
	※3	For calibration at 3 points	±0.20% F.S.	
			±12 μm	±24 μm
Temperature character ※4	±0.015% F.S./°C (within a range less than a half of the rated detection range) ※5			
	±0.9 μm/°C	±1.8 μm/°C	±3.9 μm/°C	
SUS304	Rated detection range (F.S.)	0 to 5mm	0 to 10mm	0 to 18mm
	Linearity	For calibration at 5 or more points	±0.2% F.S.	
			±10 μm	±20 μm
	※3	For calibration at 3 points	±0.3% F.S.	
			±15 μm	±30 μm
Temperature character ※4	±0.040% F.S./°C (within a range less than a half of the rated detection range) ※5			
	±2 μm/°C	±4 μm/°C	±7.2 μm/°C	
A5052	Rated detection range (F.S.)	0 to 4mm	0 to 7mm	0 to 13mm
	Linearity	For calibration at 5 or more points	±0.2% F.S.	
			±8 μm	±14 μm
	※3	For calibration at 3 points	±0.3% F.S.	
			±12 μm	±21 μm
Temperature character ※4	±0.100% F.S./°C (within a range less than a half of the rated detection range) ※5			
	±4 μm/°C	±7 μm/°C	±13 μm/°C	

※1 When the shape of the detection object is largely different from that of the standard detection object, linearity errors or temperature characters may deteriorate. (e.g. Small size, thin, non-planar surface)

※2 The value at a time when the frequency of the digital filter is set higher than 30Hz is displayed.

The value decreases in proportion to the preset frequency of the digital filter when the preset frequency of the digital filter is lower than 30 Hz. (e.g. 15 Hz: 160 kHz; 4 Hz: 42 kHz)

※3 The value under the following conditions is displayed: Detection object: Standard detection object; Detection object temperature: 20°C; Sensor temperature: 20°C; Digital filter: 30 Hz

※4 Temperature characters indicate the characters when the temperatures of the detection object and the sensor are the same and fully saturated. The specification values may not be satisfied when the temperatures of the detection object and the sensor are largely different, or they are not fully saturated.

※5 The "range less than a half of the rated detection range" is, for example, 0 to 6 mm range when the rated detection range (F.S.) is 0 to 12 mm.

The temperature characters at a range exceeding a half of the rated detection range deteriorate when compared with those at a range less than a half of the rated detection range. Accordingly, the system should be used within a range less than a half of the rated detection range in an environment where temperature characters are concerned.

26-2. Sensor Specification

Items	Specifications			
Model	GPS-1718M-[L]	GPS-2818M-[L]	GPS-2824M-[L] GPS-2824M-[L]-S01	GPS-6030M-[L] GPS-6030M-[L]-S01
Material	SUS304 (The front cover is PPS.)			
Ambient operating temperature	- 10 to +105°C, Heat-resistant type (option): - 10 to +130°C (Relay connector: - 10 to +60°C)			
Protection rating	IP67			
Vibration resistance	2.0 x 10 ² m/s ² (20G) 200Hz, up/down 4 h, forward/back 2 h,			
Interconnecting cable	Length [L]	Select from 0.5 m or 2 m.		
	Diameter	Approx. φ 8		
	Sheath	Heat-resistant PVC		
Option	-		Models named with "-S01" are provided with an interconnecting cable protector (SUS304). * The protector cannot be removed, and it is not sold as a single unit.	
	The heat-resistant type is indicated by "H" after the "M" in the model codes. Ex.: GPS-2818MH-0.5			

26-3. Extension Cable Specification

Items	Specifications
Model	GPS-C01-[L]
Extension cable length [L]	Select from 5 m *1, 10 m *1, 15 m, or 20 m.
Ambient operating temperature	- 10 to +60°C
Cable diameter	Approx. φ 8
Cable sheath	PVC
Option	*1: The cable will be covered with the protection tube if the last model code is "S01" (GPS-C01-5-S01, GPS-C01-10-S01)



- The ambient operating temperature of the extension cable is lower than that of the sensor interconnecting cable.

26-4. Amplifier Specification

(1) General Specification

Items	Specifications
Power supply voltage	24VDCV±10% (including ripple)
Power consumption	10W or less
Insulation resistance	20 MΩ or more between external DC power terminals and ground (by 500 VDC insulation resistance tester)
Withstand voltage	500 VAC, 60Hz for 1 minute between external DC power terminal and ground
Vibration resistance	20m/s ² 10 to 500Hz, 10cycles of 5 minutes in 3 directions, conforms to JIS C 0040 standard
Ambient operating temperature	0 to +55°C (No freezing)
Ambient operating humidity	20 to 90 %RH (No condensation)
Ambient operating environment	Free from corrosive gases and excessive dust
Ambient storage temperature	-10 to +70°C
Grounding	Must be securely grounded (ground resistance of 100Ω or less)
Construction	Book-shelf type within enclosure, DIN rail mountable
Outside dimension (mm)	39(W) x 155(H) x 93(D) Refer to dimensions for details.
Mass	Approx. 0.4kg
Applicable standard (Only products in which standards applied)	UL508 CSA C22.2 No.142 (Compliance with c-UL standard) CE Marking (EMC directive)



- For the information of products in which standards applied, refer to APPENDIX1. and APPENDIX2..

(2) Analog Output Specification

Items	Specifications			
	GTA-120VN	GTA-120VP	GTA-120AN	GTA-120AP
Output data	Selectable among gap data, measured data, temperature data, and vibration amplification data (AOUT2 only).			
Number of output channels	2 (AOUT1, AOUT2)			
Isolation format	Photo-coupler isolation (The channels are not isolated from each other.)			
D/A resolution	16-bit			
Output format	Voltage output (Output impedance: Approx.30Ω)		Current output (Load resistance: 0 to 510Ω, 250Ω is recommended.)	
Output range	0 to 12V (Approx. 13.5V max.)		4 to 20mA (Approx. 21.5mA max.)	

(3) I/O Specification

Items		Specifications			
Model		GTA-120VN	GTA-120VP	GTA-120AN	GTA-120AP
Input	Input signals	External measuring trigger, Measuring reset, Preset, Program (3 pints)			
	Input circuit	Photo-coupler isolation, DC input			
		Sink	Source	Sink	Source
	Input logic	Negative	Positive	Negative	Positive
	Rated input voltage	12 to 24VDC (30V max.)			
	Rated input current	4mA (at 24VDC)			
	ON voltage	10VDC or more			
OFF voltage	4VDC or less				
Output	Output signals	System ready, RUN mode, Judgment (LOW, GO, HIGH), Measuring strobe			
	Output circuit	Photo-coupler isolation, Open collector			
		Sink	Source	Sink	Source
	Output logic	Negative	Positive	Negative	Positive
	Rated load voltage	12 to 24VDC (30V max.)			
	Max. load current	10mA/point			
	Max. voltage drop when ON	1.5VDC or less			

(4) Main Function

Items		Specifications
Measurement	Measuring data	Gap data, Temperature data, Judgment (LOW, GO, HIGH) Measured data (Sample Hold, Peak Hold, Bottom Hold, Peak-to-Peak Hold) Vibration amplification data (Analog output 2 only)
	Temperature drift adjustment	Adjusts the temperature drifts of the gap data automatically.
Sensor adjustment	Sensor and cable setting	Sets the type of the sensor to connect and the extension cable length. (When skipped, linearity or temperature characters deteriorate.)
	Interference prevention function	Prevents mutual interference when more than one sensor is used in proximity (up to four sensors).
	Sensor temperature adjustment	Adjusts the sensor temperature departures caused by differences among individual sensors.
	Detection object material setting	Sets detection object material.
	Offset cancellation	Cancels offset error components of gap data caused by influences of surrounding structures or the extension cable, or differences in individual amplifiers or the sensors.
	Calibration	Corrects linearity errors. Corrected points can be selected from 2 to 11 points. Gaps at corrected points can also be set freely.
Others	Gap display setting	Sets decimal point positions and update cycles of the gap display. (The minimum display unit is 1 μ m.)
	Digital filter (LPF)	Controls abrupt fluctuations caused by noises or vibrations by filtering sensor signals. The cutoff frequency can be set in 11 grades between 1 Hz and 1kHz (at -3dB).
	Analog output setting	Selects output data or sets scaling. Can be set separately for each channel.
	Sensor disconnected error	Detects disconnection of the sensor.
	Preset	Adjusts minor errors of the gap data changes, which can be set with a desired gap.
	RUN-OUT reduction function	Reduces the fluctuation of the gap data because of RUN-OUT.
	Program	Can memorize and switch separate setting values for each program. (up to four) Setting values can be copied between the programs or reset to the factory setting.

27. OTHER CHARACTERS AND NOTES

27-1. Characters of Detection Objects

■ Materials

This system has several material parameters to obtain optimal linearity precision for various types of detection objects.

Sensor performance specifications vary depending on the detection object materials. Therefore, it is recommended to use materials with a higher performance specification. The superiority of the performance specifications of standard detection objects is shown in the following order:

(S50C, FC250, SUS430) > (SUS304) > (A5052)

Magnetic metals (S50C, FC250, SUS430) have a superior performance specification to that of nonmagnetic metals (SUS304, A5052). It is recommended to use magnetic metals (S50C, FC250, SUS430) unless they are inappropriate to use.

Material of standard detection objects		Performance level
Iron	S50C (Carbon steel)	High
	FC250 (Cast iron)	High
Stainless steel	SUS304 (Nonmagnetic stainless steel)	Medium
	SUS430 (Magnetic stainless steel)	High
Aluminum	A5052	Low



POINT

- Magnetic metals (S50C, FC250, SUS430) have a superior performance specification to that of nonmagnetic metals (SUS304, A5052). It is recommended to use magnetic metals (S50C, FC250, SUS430) unless they are inappropriate to use.



- See "10. SET the DETECTION OBJECT MATERIAL" for details of the setting of detection object materials.
- See "26-1. Performance Specification" for details of performance specifications.

■ Shapes

Use detection objects with shapes most similar to those of the standard detection objects. When the detection object is smaller or thinner than the standard detection objects, or its surface is not planar, linearity errors or temperature characters may deteriorate. The table below shows the shapes of standard detection objects.

Sensor model	Shapes of standard detection objects
GPS-17[][][]-[]	100 × 100mm, t=5mm
GPS-28[][][]-[]	
GPS-60[][][]-[]	150 × 150mm, t=5mm

27-2. RUN-OUT (Notes when detected points change after calibration)

Sensor's detecting points change after calibration when a rotating body or a work which is different each time is detected.

When eddy current characters of detection objects (magnetic properties or conductivity) are not even during the detection of the above objects, the gap data may fluctuate by dozens of micrometers even when the constant distance between the sensor and the detection object does not change. This phenomenon is called "RUN-OUT".

The following drawing shows an example when the detected point changed to the point of ② after the detection object moved or rotated after calibrated at the point of ①. If the eddy current characters at ① and ② are different, the run out is occurred and the gap data may fluctuate by dozens of micrometers even when the distance (L) between the sensor and the detection object is the same.

RUN-OUT is reduced by the "RUN-OUT reduction function" when the gap data fluctuation varies by RUN-OUT. (However, there might be no effect depending on the material.)

Change the point to detect or replace the detection object even though there is no improvement.

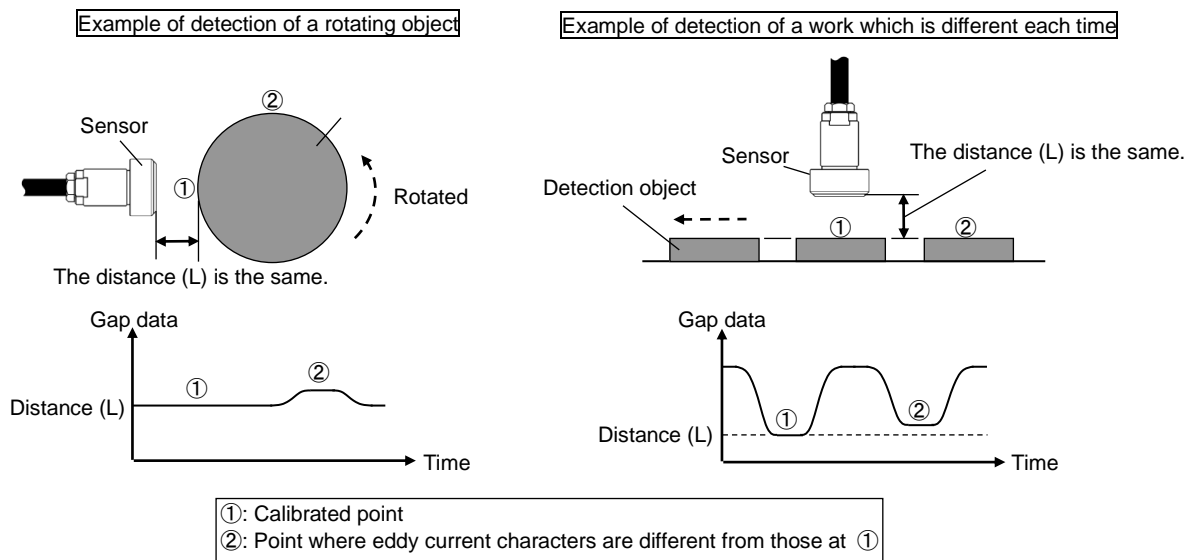

- For the RUN-OUT reduction function, refer to "20. RUN-OUT REDUCTION".

27-3. Timing Chart

(1) Preset Function

■ Preset by switch operation

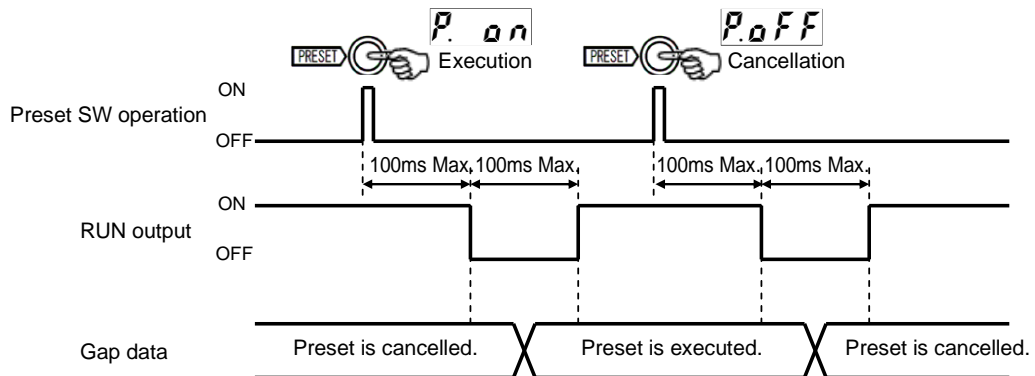

■ Preset by input signal

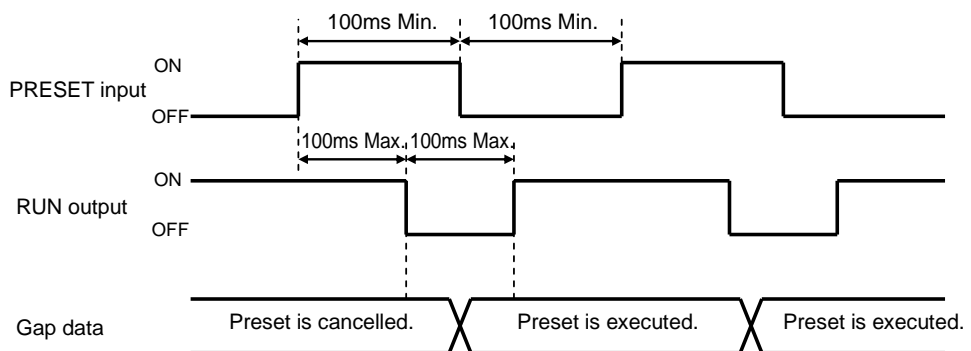

- The preset input signal can only execute the preset.
To cancel the preset, operate the switches on the panel.
- The preset input signal is accepted only in "the lock state and the RUN mode."
When the preset input signal is switched from OFF to ON in other cases, a warning *FrEE* is displayed.
- The preset input signal is not accepted when a sensor disconnected error occurs.
- When the preset input signal and the program enable input signal are accepted, the RUN mode output is kept OFF until the internal processing is completed. Another preset input signal or program enable input signal will not be accepted until the internal processing is completed.
- When the preset input signal and the program enable input signal are input simultaneously, the preset input signal is prioritized.
- When the I/O connector or the external power supply for the I/O is disconnected while the input signal is ON, an unexpected input may be made.



(2) Program Enable Function

■ Program enable by switch operation

No timing chart is prepared because it is executed in the SET mode.

■ Program enable by input signals

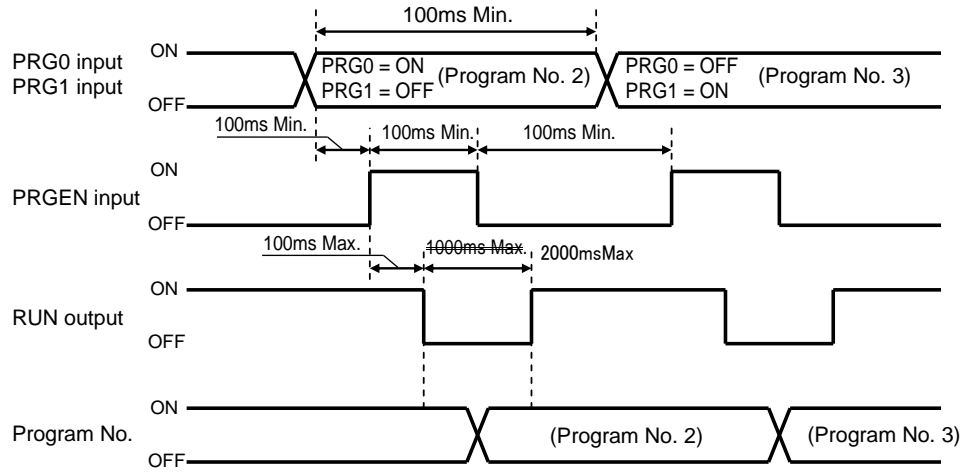

- For switching programs, the program enable input signal is accepted only in "the lock state and the RUN mode."
When the program enable input signal is switched from OFF to ON in other cases, a warning **FREE** is displayed.
- The program enable input signal is not accepted when a sensor disconnected error occurs.
- When the preset input signal and the program enable input signal are accepted, the RUN mode output is kept OFF until the internal processing is completed. Another preset input signal or program enable input signal will not be accepted until the internal processing is completed.
- PRGEN is not accepted when the program number selected using PRG0 and PRG1 is the same as the present program number.
- When the I/O connector or the external power supply for the I/O is disconnected while the input signal is ON, an unexpected input may be made.



(3) Judgment output

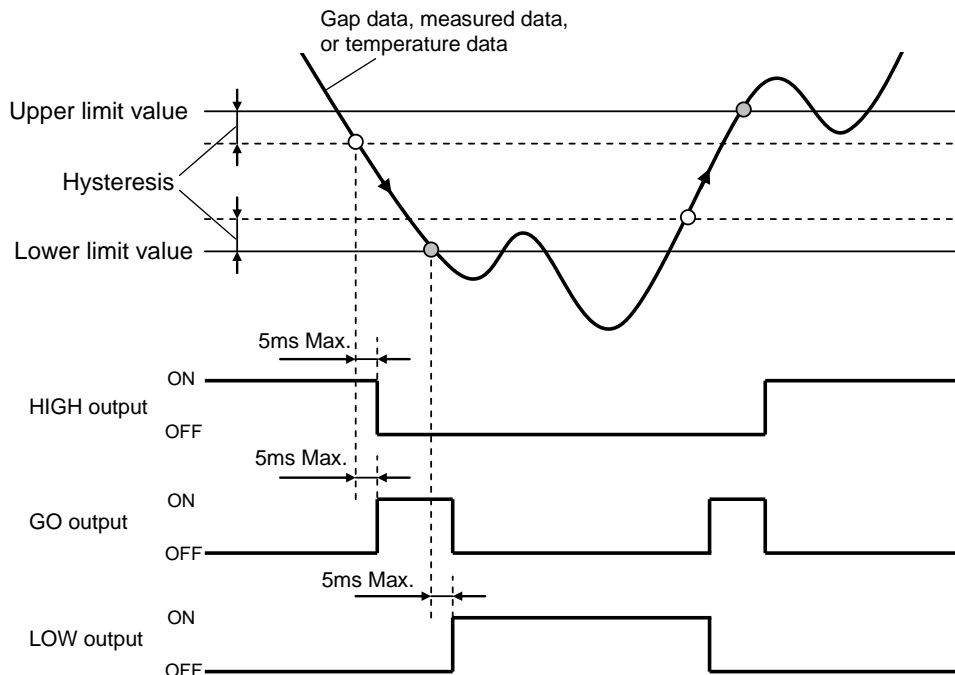

(4) Measuring Function

■ In the case of external trigger

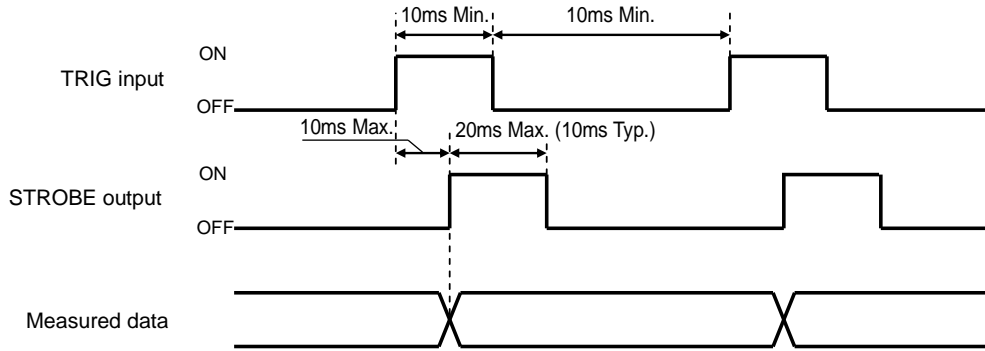

■ In the case of internal trigger

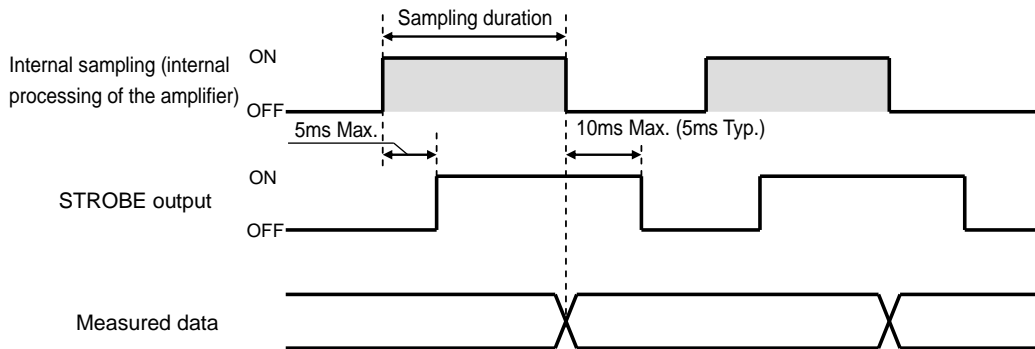

■ In the case of cycle trigger

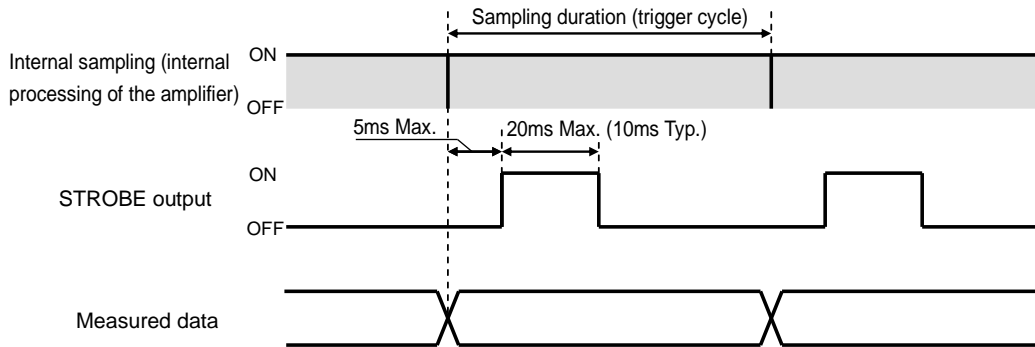

■ Measuring reset input (common timing to the setting of all trigger types)

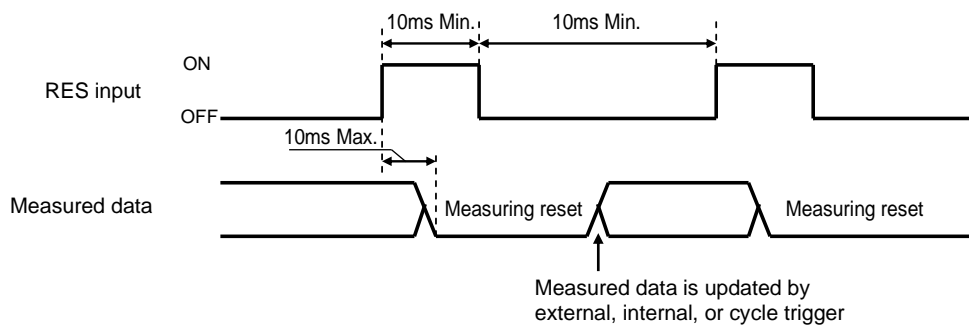

- External measuring trigger input (TRIG) is accepted only when the external trigger was selected at the trigger type.
- The function of the measuring strobe output (STROBE) depends on the trigger type. See "17-1. Description of the Measuring Function" for details.

27-4. Abrupt Fluctuations

Abrupt fluctuations are the gap data fluctuate when neither the sensor nor the detection object move.

The abrupt fluctuation width is smaller as the distance between the sensor and the detection object is shorter. It can also be reduced by the digital filter. The table below shows reference values of abrupt fluctuation width when using the standard detection objects.

Sensor model	Digital filter	Abrupt fluctuation width (reference values)	
		When the distance between the sensor and the detection object is a half of the rated detection range.	When the distance between the sensor and the detection object is the rated detection range (F.S.).
GPS-17[][][]-[]	125Hz	2 μ m	7 μ m
	30Hz	1 μ m	4 μ m
	8Hz	1 μ m	2 μ m
GPS-28[][][]-[]	125Hz	3 μ m	14 μ m
	30Hz	1 μ m	7 μ m
	8Hz	1 μ m	4 μ m
GPS-60[][][]-[]	125Hz	5 μ m	34 μ m
	30Hz	2 μ m	15 μ m
	8Hz	1 μ m	6 μ m



POINT

- The abrupt fluctuation width is smaller as the distance between the sensor and the detection object is shorter.



- See "15. USE the DIGITAL FILTER" for details of the digital filter.

28. OUTER DIMENSIONS

28-1. Sensor Dimension

(1) GPS-1718M-[L]

※ L indicates the interconnecting cable length. Select from 0.5 m or 2 m.

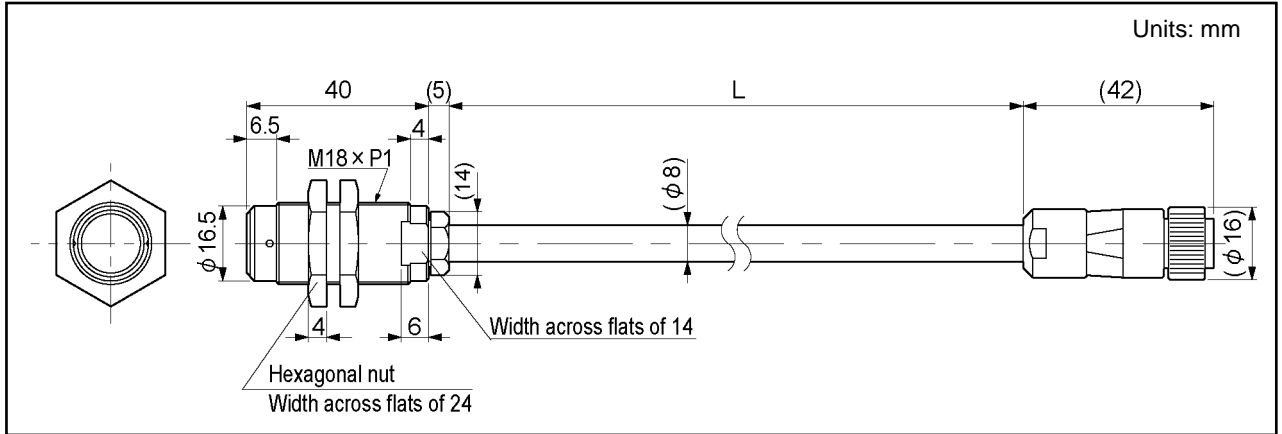

(2) GPS-2818M-[L]

※ L indicates the interconnecting cable length. Select from 0.5 m or 2 m.

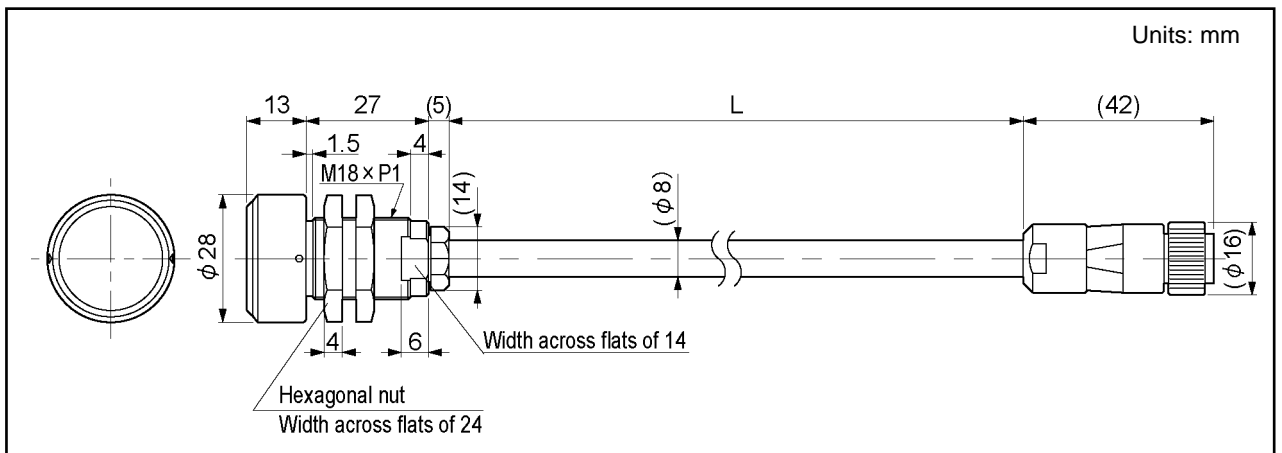

(3) GPS-2824M-[L]

※ L indicates the interconnecting cable length. Select from 0.5 m or 2 m.

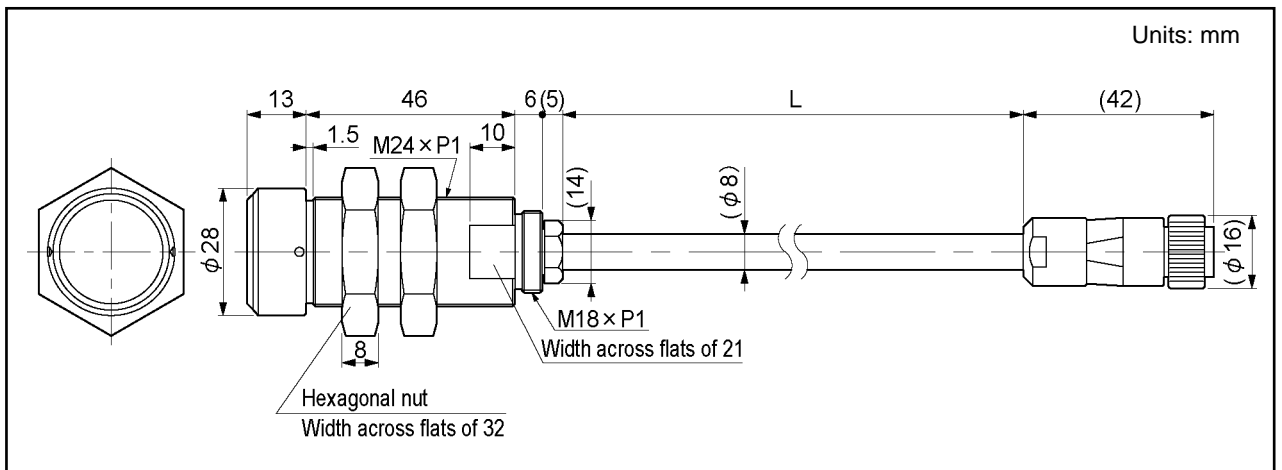

(4) GPS-2824M-[L]-S01

※ L indicates the interconnecting cable length. Select from 0.5 m or 2 m.

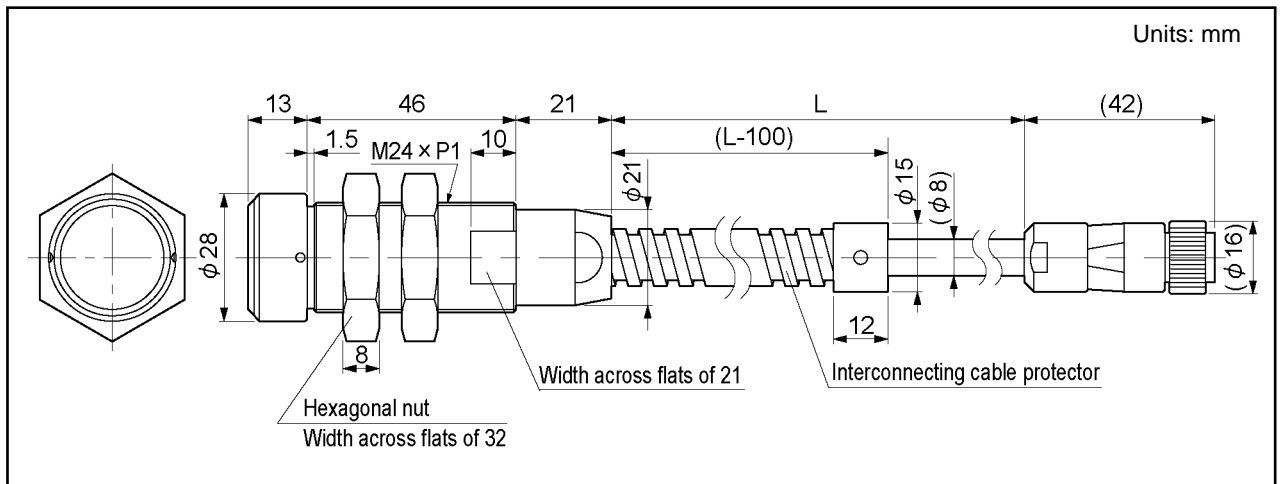

(5) GPS-6030M-[L]

※ L indicates the interconnecting cable length. Select from 0.5 m or 2 m.

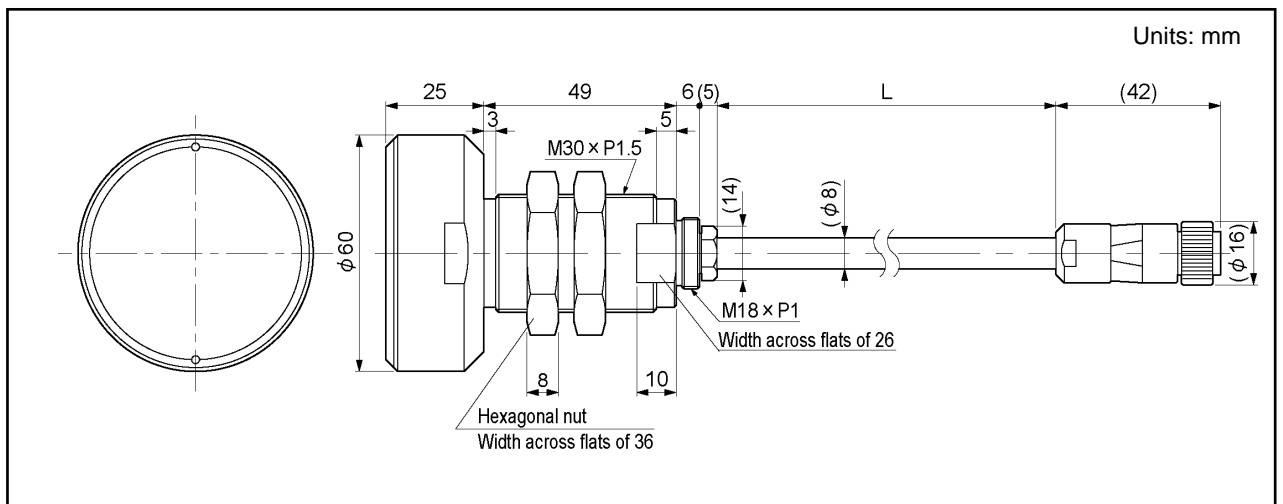

(6) GPS-6030M-[L]-S01

※ L indicates the interconnecting cable length. Select from 0.5 m or 2 m.

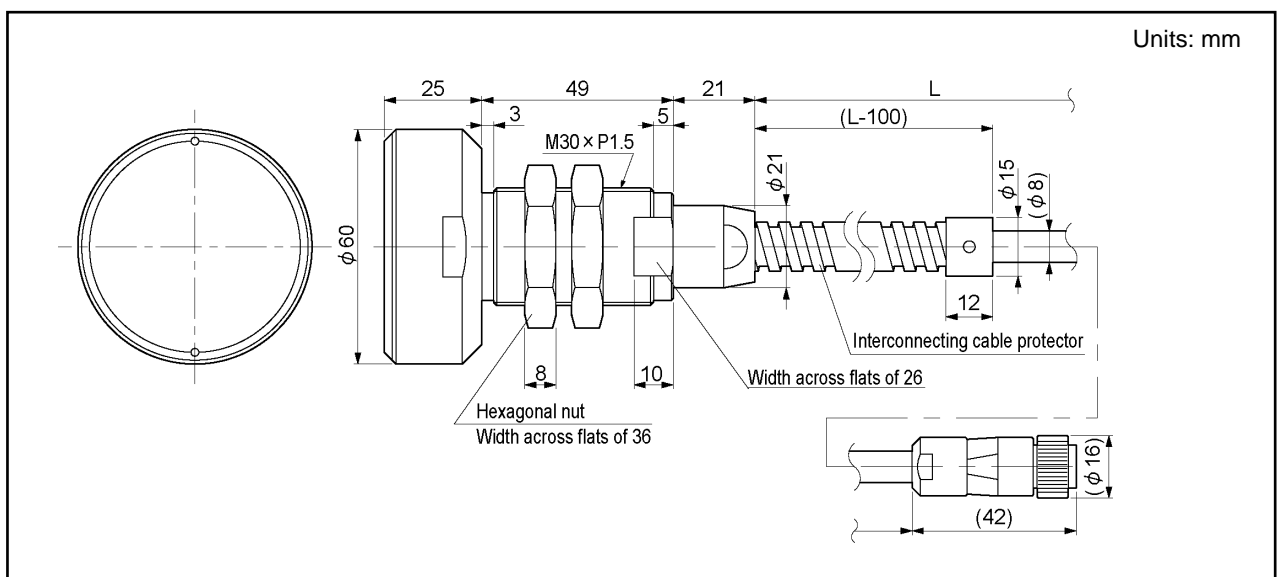

28-2. Extension Cable Dimension

(1) GPS-C01-[L]

※ L indicates the extension cable length. Select from 5 m, 10 m, 15 m, or 20 m.

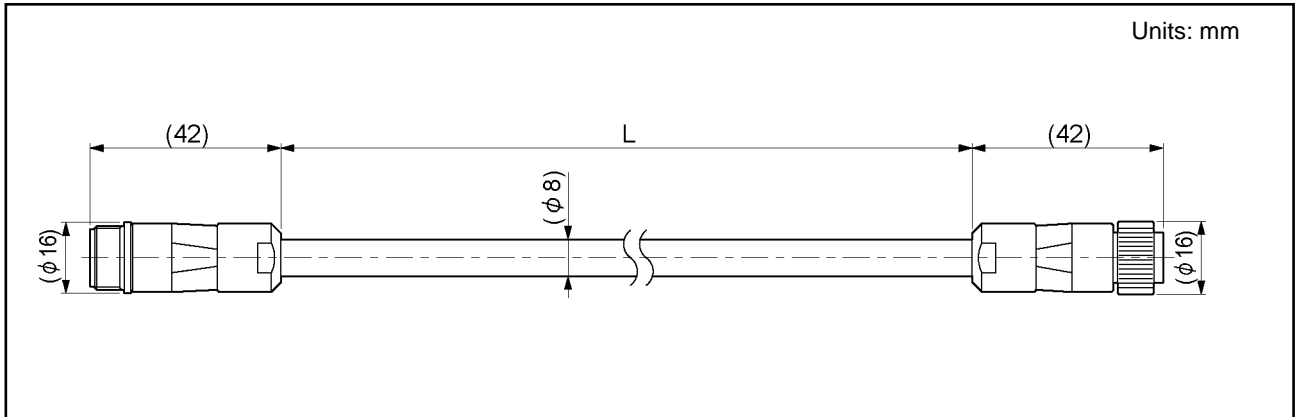

(2) GPS-C01-[L]-S01

※ L indicates the extension cable length. Select from either 5 or 10m.
(15 and 20m aren't selectable for S01 model.)

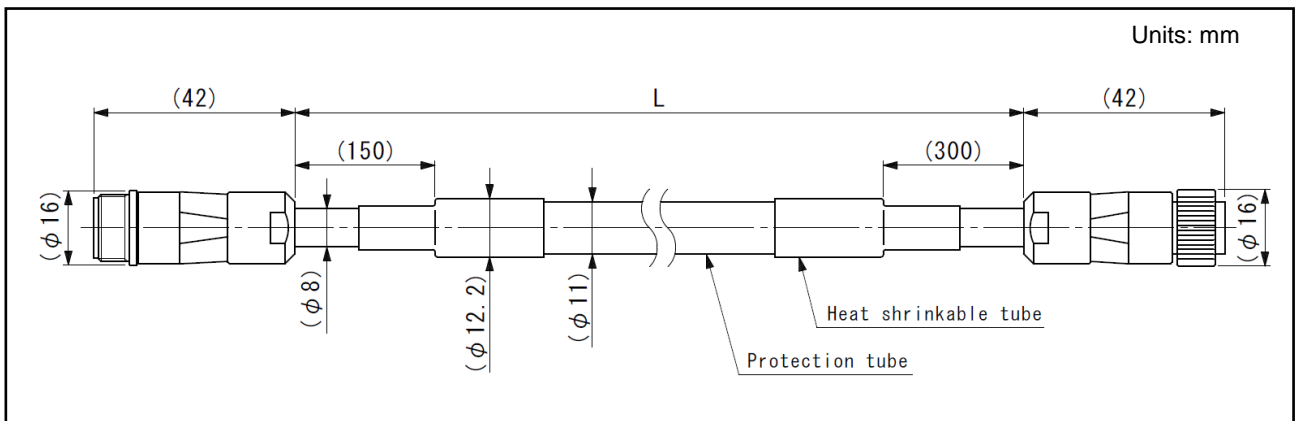

28-3. Amplifier Dimension

Common to each model.

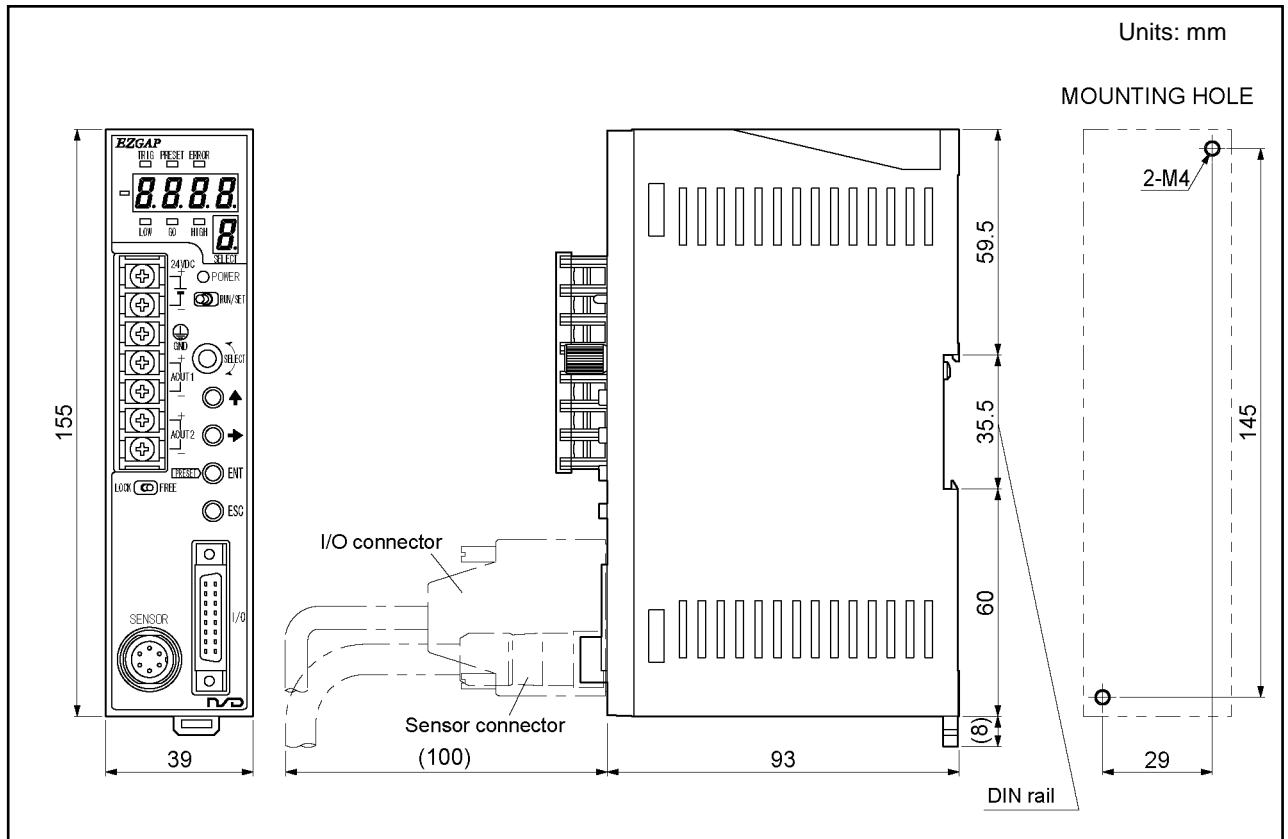

APPENDIX 1. CE MARKING

APPENDIX 1-1. Products which comply with EMC directive

If CE marking is printed on the left side of the amplifier, the amplifier complied with EMC directive.

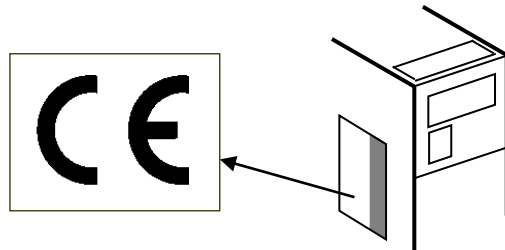

APPENDIX 1-2. EMC Directives

It is necessary to do CE marking in the customer's responsibility in the state of a final product.

Confirm EMC compliance of the machine and the entire device by customer because EMC changes configuration of the control panel, wiring, and layout.

APPENDIX 1-3. EMC Directive and Standards

EMC Directive consists of immunity and emission items.

It conforms to Table 01 (see below) of EMC standards and Testing.

Table 01 EMC Standard and Testing

Class	Standard No.	Name
EMI (Emission)	EN61000-6-4	Generic standards. Emission standard for industrial environments
	EN55011 Class A	Electromagnetic Radiation Disturbance
EMS (Immunity)	EN61000-6-2	Generic standards. Immunity standard for industrial environments
	EN61000-4-2	Electrostatic Discharge
	EN61000-4-3	Radiated, Radio frequency, Electromagnetic Field
	EN61000-4-4	Electrical Fast Transient / Burst
	EN61000-4-5	Surge Immunity
	EN61000-4-6	Conducted Disturbances, Induced by Radio-Frequency Fields
	EN61000-4-8	Power Frequency Magnetic Field

APPENDIX 1-4. Low Voltage Directive

The low voltage directive is out of the range because the amplifier is activated by 24VDC power supply.

APPENDIX 1-5. Measures for EMC Compliance and Restriction

Describes measures for EMC compliance and restriction when testing the compatibility verification.

(1) Sensor cable

When testing the compatibility verification, two clamp filters were attached to the amplifier side of the sensor cable.

If necessary for a final product, attach it.

It may be improved when clamp filter is added to the sensor cable.

- In the case of the amplifier operates faultily or sensor data fluctuates due to the influence from the peripheral device.
- In the case of the effect of reducing conducted and radiated noise is required.

■ Recommendation clamp filter

Mounting location	Clamp filter model	Manufacturer
Sensor cable	ZCAT2032-0930 (inner dimensions: $\phi 9$)	TDK

The sensor cable should be shorter than 30m.

(The maximum length of interconnecting cable is 2m, and the maximum length of extension cable is 20m. Therefore, the length of the sensor cable cannot exceed 30m or more.)

(2) I/O cable

The I/O cable should be shorter than 30m.

(3) Analog output cable

Use the twist pair cable with shield as the analog output cable, and connect the wire shield to the GND terminal block of the amplifier. (Refer to the following figure.)

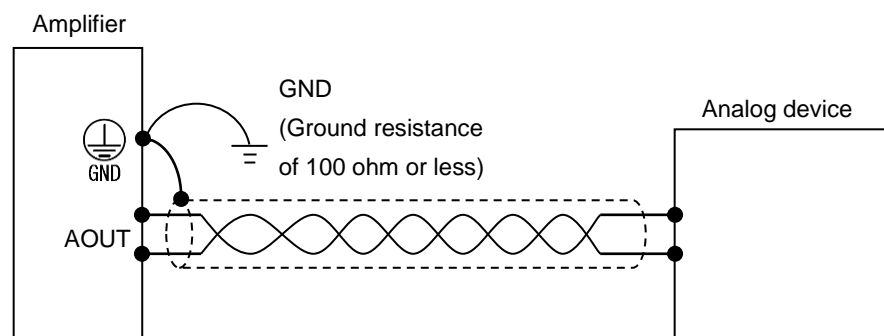

APPENDIX 2. UL STANDARD

APPENDIX 2-1. Products which comply with UL standards

If UL Listing Mark is printed on the left side of the amplifier, the amplifier complied with UL standard.

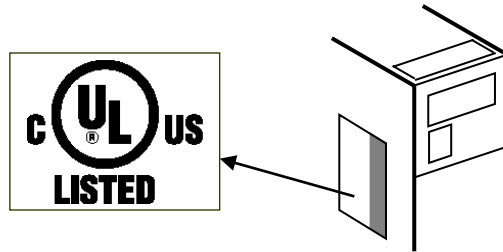

APPENDIX 2-2. Installation

- Install inside the control cabinet.
- For use in pollution degree 2 environment
- Within the surrounding air temperature 0°C to 55°C.

APPENDIX 2-3. External Power Supply

Use a "Class 2" power supply.









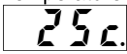

APPENDIX 2-4. Wiring to the Power Supply and Ground

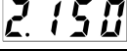
- Use field installed conductors with a temperature rating of 75°C or higher.
- Use electrical wires of copper "AWG 18 to 26" or copper strand "AWG 18 to 26".
- The terminal block tightening torque is 0.6 N·m (5.1 lb·in).

— MEMO —

APPENDIX 3 LIST of EACH MODE ITEMS

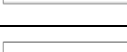
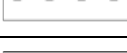
APPENDIX 3-1. List of RUN Mode Items

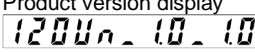
Select No.	RUN mode item	Description	Chapter No.
0	Gap data display  Preset confirmation display  (Executed)  (Cancelled)	Displays the present gap data. When a sensor disconnected error occurs,  is displayed. [Procedures for execution or cancellation of the preset by switch operation] (1) Set the preset setting value in advance in the SET mode. (2) Holding down PRESET (ENT) for a while executes or cancels the preset. (3) When the preset is cancelled, blinking <i>P.on</i> (preset executed) is displayed. Pressing PRESET (ENT) again executes the preset. When the preset is executed, blinking <i>P.oFF</i> (preset cancelled) is displayed. Pressing PRESET (ENT) again cancels the preset.	13 19
1	Temperature data display 	Displays the present sensor temperature. When a sensor disconnected error occurs,  is displayed.	13
2	Judgment result display 	Displays the judgment result. (It is also displayed in the judgment display part.) When a sensor disconnected error occurs,  is displayed.	13 16
3	Measured data display 	Measured data of the measuring function is displayed. When the measured data is updated, the measuring trigger display part blinks once. During the measuring reset,  is displayed.	13 17
4		Not in use.	—
5		Not in use.	—
6		Not in use.	—
7		Not in use.	—
8		Not in use.	—
9		Not in use.	—
A		Not in use.	—
b		Not in use.	—
c		Not in use.	—
d		Not in use.	—
E	Sensor status display 	Displays the sensor status. This is the manufacturer's maintenance data and not intended for a general use.	24-3
F	Product version display 	Displays the product version in scroll. The product version is "120VN_1.0_1.0" in this example.	24-2

APPENDIX 3-2. List of SET Mode Items

(※) indicates factory setting.

Select No.	SET mode item	Description	Chapter No.	Memo
0	Gap data display setting Update cycle Decimal point position 	[Update cycle] 1: Once per second 3: 3 times per second (※) 5: 5 times per second 10: 10 times per second [Decimal point position] 0: The decimal point positions are shifted automatically. (※) 1: Up to the first decimal place 2: Up to the second decimal place 3: Up to the third decimal place	14	
1	Digital filter setting 	1K H : 1kHz 62H : 62Hz 4H : 4Hz 500H : 500Hz 30H : 30Hz (※) 2H : 2Hz 250H : 250Hz 15H : 15Hz 1H : 1Hz 125H : 125Hz 8H : 8Hz	15	
2	Judgment setting 	(1) Target data: GAP : Gap data (※), MEAS : Measured data, TEMP : Temperature data (2) Lower limit value L (※1.00mm) (3) Upper limit value H (※5.00mm) (4) Hysteresis width h (※0.1mm)	16	
3	Measuring function setting 	(1) Measuring mode: SHP : Sample Hold (※), PEAK : Peak Hold, BO : Bottom Hold, P-P : Peak-to-Peak Hold (2) Trigger type: EXT : External trigger (※), INT : Internal trigger, CYCL : Cycle trigger (3) Trigger direction of internal trigger: UP : Leading edge, DOWN : Trailing edge	17	
4	Analog output 1 setting 	(1) Output data: GAP : Gap data (※), MEAS : Measured data, TEMP : Temperature data, OSC : Vibration amplification data (Analog output 2 only) (2) In the case of gap data or measured data, perform scaling by setting desired two points of data (Input value 1, Input value 2), and desired two points of analog output values (Input value 3, Input value 4). (3) In the case of vibration amplification data: HPF cutoff frequency: Any of 0.2 Hz, 1.6 Hz (※), 13 Hz, and 100 Hz. Scaling factor: Any of x1 (※), x10, and x100.	18	
5	Analog output 2 setting 			
6	Preset value setting 	Sets the gap to preset. (※0.00mm) When the preset is executed, the present gap data changes to the preset value.	19	
7	RUN-OUT reduction setting 	This function will be available if the sensor model setting is "GPS-28" and the detection object material setting is "FE2". 1: normal operation (※factory setting) 2 to 5: RUN-OUT reduction operation	20	
8		Not in use.	-	-
9	Sensor type and cable length setting 	(1) Sensor type 17 : GPS-17 28 : GPS-28 (※) (2) Interconnecting cable length 60 : GPS-60 - - 0.5 : 0.5m - - 2 : 2m (※) (3) Type and length of extension cable 1-20 [Type] [Length] 1 : C01 (※) 0 : Without extension cable (※) 15 : 15m (Only C01 at present) 5 : 5m 20 : 20m 10 : 10m	7	
A	Interference prevention setting 	1 : Interference Prevention No. 1 (※) 3 : Interference Prevention No. 3 2 : Interference Prevention No. 2 4 : Interference Prevention No. 4	8	
b	Sensor temperature adjustment 	Input the adjusted value of the sensor temperature (ΔT) written on the sensor model label to the amplifier.	9	
C	Detection object material setting 	FE1 : S50C (※) SUS1 : SUS304 AL : A5052 FE2 : FC250 SUS2 : SUS430	10	
d	Offset cancellation 	[Recommended distance] GPS-17: 25mm or more GPS-28: 50mm or more GPS-60: 100mm or more	11	
E	Calibration 	(1) No. of corrected points: pt. 3 0 : No correction (※) 2~11 : 2 to 11 points (2) Gaps at corrected points Enter the gap values at each corrected point in the ascending order. Example of entry: 0.00 mm → 5.00mm → 10.00 mm (correction at 3 points) When any of the setting from "sensor type and cable length setting" to offset cancellation (9 to d) is changed, make sure to perform calibration again.	12	
F	Program No. 	1 : Program No. 1 (※) [Procedures for copying the setting values of program and resetting to the factory setting] (1) Hold down and for 2 seconds. 2 : Program No. 2 3 : Program No. 3 (2) copies the setting for the present Program No. to the other Program No. 4 : Program No. 4 (3) resets the setting for the present Program No. to the factory setting.	21	



NSD Group

Manufacturer

NSD Corporation 3-31-28, OSU, NAKA-KU, NAGOYA, JAPAN 460-8302

Distributor

NSD Trading Corporation 3-31-23, OSU, NAKA-KU, NAGOYA, JAPAN 460-8302

Phone: +81-52-261-2352 Facsimile: +81-52-252-0522

URL: www.nsdcorp.com E-mail: foreign@nsdcorp.com

Copyright©2023 NSD Corporation All rights reserved.