

Mitsubishi Electric AC Servo System

MITSUBISHI ELECTRIC SERVO SYSTEM
MELSERVO-J5

MR-J5-A
User's Manual
(Parameters)

-MR-J5-_A_

SAFETY INSTRUCTIONS

Please read the instructions carefully before using the equipment.

To use the equipment correctly, do not attempt to install, operate, maintain, or inspect the equipment until you have read through this manual, installation guide, and appended documents carefully. Do not use the equipment until you have a full knowledge of the equipment, safety information and instructions.

In this manual, the safety instruction levels are classified into "WARNING" and "CAUTION".



WARNING

Indicates that incorrect handling may cause hazardous conditions, resulting in death or severe injury.



CAUTION

Indicates that incorrect handling may cause hazardous conditions, resulting in medium or slight injury.

Note that the CAUTION level may lead to a serious consequence depending on conditions.

Please follow the instructions of both levels because they are important to personnel safety.

Forbidden actions and required actions are indicated by the following diagrammatic symbols.



Indicates a forbidden action. For example, "No Fire" is indicated by .



Indicates a required action. For example, grounding is indicated by .

In this manual, precautions for hazards that can lead to property damage, instructions for other functions, and other information are shown separately in the "Point" area.

After reading this manual, keep it accessible to the operator.

[Installation/wiring]

WARNING

- To prevent an electric shock, turn off the power and wait for 15 minutes or more before starting wiring and/or inspection.
 - To prevent an electric shock, ground the servo amplifier.
 - To prevent an electric shock, any person who is involved in wiring should be fully competent to do the work.
 - To prevent an electric shock, mount the servo amplifier before wiring.
 - To prevent an electric shock, connect the protective earth (PE) terminal of the servo amplifier to the protective earth (PE) of the cabinet, then connect the grounding lead wire to the ground.
 - To prevent an electric shock, do not touch the conductive parts.
-

[Setting/adjustment]

WARNING

- To prevent an electric shock, do not operate the switches with wet hands.
-

[Operation]

WARNING

- To prevent an electric shock, do not operate the switches with wet hands.
-

[Maintenance]

WARNING

- To prevent an electric shock, any person who is involved in inspection should be fully competent to do the work.
 - To prevent an electric shock, do not operate the switches with wet hands.
-

ABOUT THE MANUAL

Point

e-Manuals are Mitsubishi Electric FA electronic book manuals that can be browsed with a dedicated tool.

e-Manuals enable the following:

- Searching for desired information in multiple manuals at the same time (manual cross searching)
- Jumping from a link in a manual to another manual for reference
- Browsing for hardware specifications by scrolling over the components shown in product illustrations
- Bookmarking frequently referenced information
- Copying sample programs to engineering software

If using the servo for the first time, prepare and use the following related manuals to ensure that the servo is used safely. For the related manuals, refer to the User's Manual (Introduction).

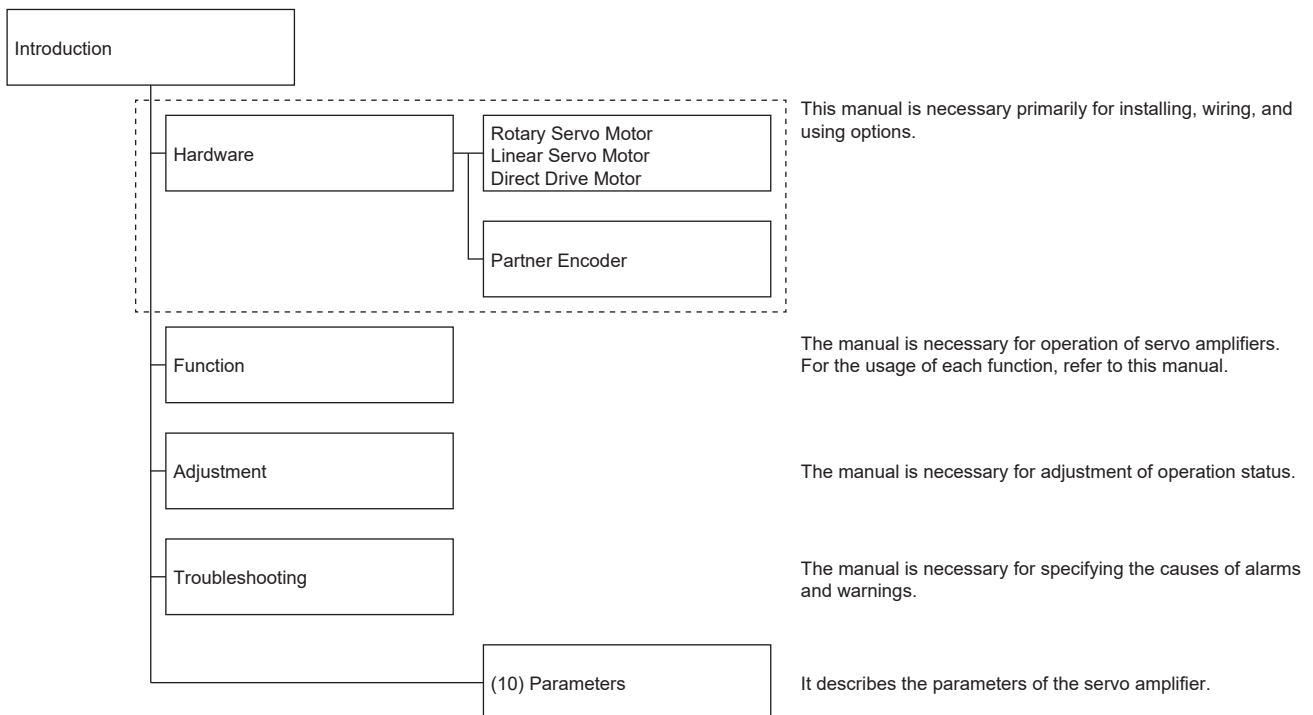

Interpreting servo parameter numbers

For a servo parameter which uses one particular digit to select a function, the position of its digit indicates the detail number of the servo parameter, and the value in hexadecimal which is set to the digit indicates the selected function.

For example, the detail number of the servo parameter in the last digit is expressed as [Pr. PA01.0]. In addition, a servo parameter which uses a combination of several digits to select a function, is expressed using "-" as seen in [Pr. PA01.0-1]. The following is an example of the servo parameter number PA01 with the setting values of "FEDCBA98" in hexadecimal.

- When setting a servo parameter with one particular digit

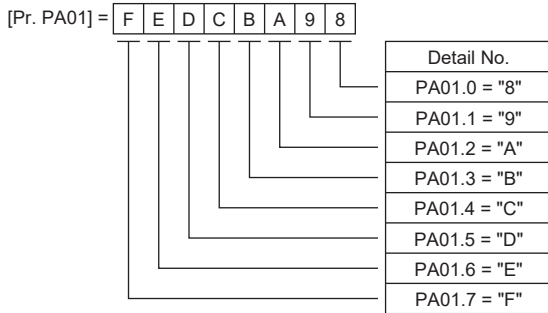

- When setting a servo parameter using a combination of several digits

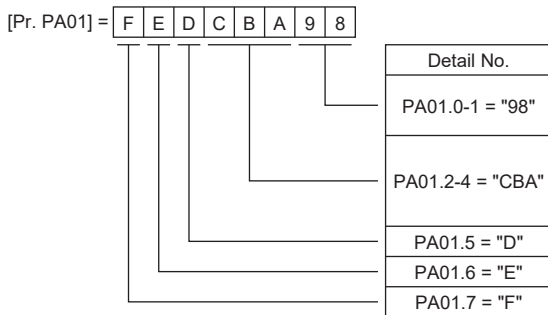

For example, if the servo parameter name is "Function selection A-1", the setting digit name is "Forced stop deceleration function selection", and the setting digit is the fourth last digit in PA04, the servo parameter is expressed as shown below.

[Pr. PA04.3 Forced stop deceleration function selection]

Servo parameter	Symbol	Name	Description
PA04.3	*AOP	Forced stop deceleration function selection	Set "Forced stop deceleration function" to enabled/disabled. Initial value: 1h (enabled)

Global standards and regulations

Compliance with the indicated global standards and regulations is current as of the release date of this manual. Some standards and regulations may have been modified or withdrawn.

U.S. CUSTOMARY UNITS

U.S. customary units are not shown in this manual. Convert the values if necessary according to the following table.

Quantity	SI (metric) unit	U.S. customary unit
Mass	1 [kg]	2.2046 [lb]
Length	1 [mm]	0.03937 [inch]
Torque	1 [N•m]	141.6 [oz•inch]
Moment of inertia	1 [(× 10 ⁻⁴ kg•m ²)]	5.4675 [oz•inch ²]
Load (thrust load/axial load)	1 [N]	0.2248 [lbf]
Temperature	N [°C] × 9/5 + 32	N [°F]

CONTENTS

SAFETY INSTRUCTIONS	1
ABOUT THE MANUAL	3
U.S. CUSTOMARY UNITS	4
CHAPTER 1 SERVO PARAMETER DETAILS	12
1.1 Explanation of servo parameters	12
1.2 Basic setting servo parameters group ([Pr. PA_ _])	13
[Pr. PA01_Operation mode (**STY)]	13
[Pr. PA02_Regenerative option (**REG)]	14
[Pr. PA03_Absolute position detection system (*ABS)]	16
[Pr. PA04_Function selection A-1 (*AOP1)]	17
[Pr. PA05_Number of command input pulses per revolution (*FBP)]	17
[Pr. PA06_Electronic gear numerator (CMX)]	17
[Pr. PA07_Electronic gear denominator (CDV)]	17
[Pr. PA08_Auto tuning mode (ATU)]	18
[Pr. PA09_Auto tuning response (RSP)]	20
[Pr. PA10_In-position range (INP)]	21
[Pr. PA11_Forward rotation torque limit (TLP)]	21
[Pr. PA12_Reverse rotation torque limit (TLN)]	21
[Pr. PA13_Command pulse input form (*PLSS)]	22
[Pr. PA14_Travel direction selection (*POL)]	24
[Pr. PA15_Encoder output pulses (*ENR)]	25
[Pr. PA16_Encoder output pulses 2 (*ENR2)]	25
[Pr. PA17_Servo motor series setting (**MSR)]	26
[Pr. PA18_Servo motor type setting (**MTY)]	27
[Pr. PA19_Servo parameter writing prohibited (*BLK)]	28
[Pr. PA20_Tough drive setting (*TDS)]	29
[Pr. PA21_Function selection A-3 (*AOP3)]	30
[Pr. PA22_Position control configuration selection (**PCS)]	30
[Pr. PA23_Drive recorder desired alarm trigger setting (DRAT)]	31
[Pr. PA24_Function selection A-4 (AOP4)]	32
[Pr. PA25_One-touch tuning - Overshoot permissible level (OTHOV)]	32
[Pr. PA26_Function selection A-5 (*AOP5)]	33
[Pr. PA28_Function selection A-6 (**AOP6)]	33
[Pr. PA34_Quick tuning - Permissible travel distance (QDIS)]	33
1.3 Gain/filter setting servo parameters group ([Pr. PB_ _])	34
[Pr. PB01_Adaptive tuning mode (adaptive filter II) (FILT)]	34
[Pr. PB02_Vibration suppression control tuning mode (advanced vibration suppression control II) (VRFT)]	35
[Pr. PB03_Position command speed adjustment time constant (position smoothing) (PST)]	35
[Pr. PB04_Feed forward gain (FFC)]	36
[Pr. PB06_Load to motor inertia ratio/load to motor mass ratio (GD2)]	36
[Pr. PB07_Model control gain (PG1)]	36
[Pr. PB08_Position control gain (PG2)]	37
[Pr. PB09_Speed control gain (VG2)]	37
[Pr. PB10_Speed integral compensation (VIC)]	38
[Pr. PB11_Speed differential compensation (VDC)]	38
[Pr. PB12_Overshoot amount compensation (OVA)]	38
[Pr. PB13_Machine resonance suppression filter 1 (NH1)]	38

[Pr. PB14_Notch shape selection 1 (NHQ1)]	39
[Pr. PB15_Machine resonance suppression filter 2 (NH2)]	39
[Pr. PB16_Notch shape selection 2 (NHQ2)]	40
[Pr. PB17_Shaft resonance suppression filter (NHF)]	41
[Pr. PB18_Low-pass filter setting (LPF)]	45
[Pr. PB19_Vibration suppression control 1 - Vibration frequency (VRF11)]	45
[Pr. PB20_Vibration suppression control 1 - Resonance frequency (VRF12)]	45
[Pr. PB21_Vibration suppression control 1 - Vibration frequency damping (VRF13)]	45
[Pr. PB22_Vibration suppression control 1 - Resonance frequency damping (VRF14)]	46
[Pr. PB23_Low-pass filter selection (VFBF)]	46
[Pr. PB24_Slight vibration suppression control (*MVS)]	47
[Pr. PB25_Function selection B-1 (*BOP1)]	47
[Pr. PB26_Gain switching function (*CDP)]	48
[Pr. PB27_Gain switching condition (CDL)]	49
[Pr. PB28_Gain switching time constant (CDT)]	49
[Pr. PB29_Gain switching - Load to motor inertia ratio/load to motor mass ratio (GD2B)]	49
[Pr. PB30_Gain switching - Position control gain (PG2B)]	49
[Pr. PB31_Gain switching - Speed control gain (VG2B)]	49
[Pr. PB32_Gain switching - Speed integral compensation (VICB)]	49
[Pr. PB33_Gain switching - Vibration suppression control 1 - Vibration frequency (VRF11B)]	50
[Pr. PB34_Gain switching - Vibration suppression control 1 - Resonance frequency (VRF12B)]	50
[Pr. PB35_Gain switching - Vibration suppression control 1 - Vibration frequency damping (VRF13B)]	50
[Pr. PB36_Gain switching - Vibration suppression control 1 - Resonance frequency damping (VRF14B)]	50
[Pr. PB45_Command notch filter (CNHF)]	51
[Pr. PB46_Machine resonance suppression filter 3 (NH3)]	54
[Pr. PB47_Notch shape selection 3 (NHQ3)]	54
[Pr. PB48_Machine resonance suppression filter 4 (NH4)]	54
[Pr. PB49_Notch shape selection 4 (NHQ4)]	55
[Pr. PB50_Machine resonance suppression filter 5 (NH5)]	55
[Pr. PB51_Notch shape selection 5 (NHQ5)]	56
[Pr. PB52_Vibration suppression control 2 - Vibration frequency (VRF21)]	56
[Pr. PB53_Vibration suppression control 2 - Resonance frequency (VRF22)]	57
[Pr. PB54_Vibration suppression control 2 - Vibration frequency damping (VRF23)]	57
[Pr. PB55_Vibration suppression control 2 - Resonance frequency damping (VRF24)]	57
[Pr. PB56_Gain switching - Vibration suppression control 2 - Vibration frequency (VRF21B)]	57
[Pr. PB57_Gain switching - Vibration suppression control 2 - Resonance frequency (VRF22B)]	58
[Pr. PB58_Gain switching - Vibration suppression control 2 - Vibration frequency damping (VRF23B)]	58
[Pr. PB59_Gain switching - Vibration suppression control 2 - Resonance frequency damping (VRF24B)]	58
[Pr. PB60_Gain switching - Model control gain (PG1B)]	58
[Pr. PB65_Gain switching 2 condition (CDL2)]	59
[Pr. PB66_Gain switching 2 time constant (CDT2)]	59
[Pr. PB67_Gain switching 2 - Load to motor inertia ratio/load to motor mass ratio (GD2C)]	59
[Pr. PB68_Gain switching 2 - Position control gain (PG2C)]	59
[Pr. PB69_Gain switching 2 - Speed control gain (VG2C)]	59
[Pr. PB70_Gain switching 2 - Speed integral compensation (VICC)]	59
[Pr. PB71_Gain switching 2 - Vibration suppression control 1 - Vibration frequency (VRF11C)]	60
[Pr. PB72_Gain switching 2 - Vibration suppression control 1 - Resonance frequency (VRF12C)]	60
[Pr. PB73_Gain switching 2 - Vibration suppression control 1 - Vibration frequency damping (VRF13C)]	60
[Pr. PB74_Gain switching 2 - Vibration suppression control 1 - Resonance frequency damping (VRF14C)]	61
[Pr. PB75_Gain switching 2 - Vibration suppression control 2 - Vibration frequency (VRF21C)]	61
[Pr. PB76_Gain switching 2 - Vibration suppression control 2 - Resonance frequency (VRF22C)]	61

	[Pr. PB77_Gain switching 2 - Vibration suppression control 2 - Vibration frequency damping (VRF23C)]	62
	[Pr. PB78_Gain switching 2 - Vibration suppression control 2 - Resonance frequency damping (VRF24C)]	62
	[Pr. PB79_Gain switching 2 - Model control gain (PG1C)]	62
	[Pr. PB81_Command filter (*CFIL)]	63
	[Pr. PB82_Position command smoothing filter time constant (PFT)]	63
1.4	Extension setting servo parameters group ([Pr. PC__])	64
	[Pr. PC01_Speed acceleration time constant (STA)]	64
	[Pr. PC02_Speed deceleration time constant (STB)]	64
	[Pr. PC03_S-pattern acceleration/deceleration time constants (STC)]	65
	[Pr. PC04_Torque command time constant (TQC)]	65
	[Pr. PC05_Internal speed 1 (SC1)]	66
	[Pr. PC06_Internal speed 2 (SC2)]	66
	[Pr. PC07_Internal speed 3 (SC3)]	66
	[Pr. PC08_Internal speed 4 (SC4)]	66
	[Pr. PC09_Internal speed 5 (SC5)]	66
	[Pr. PC10_Internal speed 6 (SC6)]	66
	[Pr. PC11_Internal speed 7 (SC7)]	67
	[Pr. PC12_Analog speed command - Maximum speed (VCM)]	67
	[Pr. PC13_Analog torque command maximum output (TLC)]	67
	[Pr. PC14_Analog monitor 1 output (MOD1)]	68
	[Pr. PC15_Analog monitor 2 output (MOD2)]	69
	[Pr. PC16_Electromagnetic brake sequence output (MBR)]	69
	[Pr. PC17_Zero speed (ZSP)]	69
	[Pr. PC18_Alarm history clear (*BPS)]	69
	[Pr. PC19_Encoder output pulses selection (*ENRS)]	70
	[Pr. PC20_Station No. setting (*SNO)]	72
	[Pr. PC21_RS-422 communication function selection (*SOP)]	73
	[Pr. PC22_Function selection C-1 (**COP1)]	74
	[Pr. PC23_Function selection C-2 (*COP2)]	75
	[Pr. PC24_Function selection C-3 (*COP3)]	76
	[Pr. PC26_Function selection C-5 (*COP5)]	77
	[Pr. PC27_Function selection C-6 (*COP6)]	78
	[Pr. PC28_Function selection C-7 (*COP7)]	78
	[Pr. PC29_Function selection C-8 (*COP8)]	79
	[Pr. PC30_Speed acceleration time constant 2 (STA2)]	79
	[Pr. PC31_Speed deceleration time constant 2 (STB2)]	80
	[Pr. PC32_Command input pulse multiplication numerator 2 (CMX2)]	80
	[Pr. PC33_Command input pulse multiplication numerator 3 (CMX3)]	80
	[Pr. PC34_Command input pulse multiplication numerator 4 (CMX4)]	80
	[Pr. PC35_Internal torque limit 2 (TL2)]	80
	[Pr. PC36_Status display selection (*DMD)]	81
	[Pr. PC37_Analog command input 1 offset (VCO)]	83
	[Pr. PC38_Analog command input 2 offset (TPO)]	83
	[Pr. PC39_Analog monitor 1 offset (MO1)]	84
	[Pr. PC40_Analog monitor 2 offset (MO2)]	84
	[Pr. PC43_Excessive error alarm trigger level (ERZ)]	84
	[Pr. PC44_Function selection C-9 (**COP9)]	84
	[Pr. PC45_Function selection C-A (**COPA)]	85
	[Pr. PC50_Function selection C-B (*COPB)]	86
	[Pr. PC51_Deceleration time constant at forced stop (RSBR)]	87
	[Pr. PC54_Vertical axis freefall prevention compensation amount (RSUP1)]	87

	[Pr. PC60_Function selection C-D (**COPD)]	88
	[Pr. PC73_Excessive error warning trigger level (ERW)]	89
	[Pr. PC90_Command frequency error threshold (PLFT)]	89
1.5	I/O setting servo parameters group ([Pr. PD_ _])	90
	[Pr. PD01_Input signal automatic ON selection 1 (*DIA1)]	90
	[Pr. PD03_Input device selection 1L (*DI1L)]	92
	[Pr. PD04_Input device selection 1H (*DI1H)]	93
	[Pr. PD05_Input device selection 2L (*DI2L)]	93
	[Pr. PD06_Input device selection 2H (*DI2H)]	93
	[Pr. PD07_Input device selection 3L (*DI3L)]	94
	[Pr. PD08_Input device selection 3H (*DI3H)]	94
	[Pr. PD09_Input device selection 4L (*DI4L)]	95
	[Pr. PD10_Input device selection 4H (*DI4H)]	95
	[Pr. PD11_Input device selection 5L (*DI5L)]	96
	[Pr. PD12_Input device selection 5H (*DI5H)]	96
	[Pr. PD13_Input device selection 6L (*DI6L)]	96
	[Pr. PD14_Input device selection 6H (*DI6H)]	97
	[Pr. PD17_Input device selection 8L (*DI8L)]	97
	[Pr. PD18_Input device selection 8H (*DI8H)]	97
	[Pr. PD19_Input device selection 9L (*DI9L)]	98
	[Pr. PD20_Input device selection 9H (*DI9H)]	98
	[Pr. PD21_Input device selection 10L (*DI10L)]	98
	[Pr. PD22_Input device selection 10H (*DI10H)]	99
	[Pr. PD23_Output device selection 1 (*DO1)]	99
	[Pr. PD24_Output device selection 2 (*DO2)]	100
	[Pr. PD25_Output device selection 3 (*DO3)]	100
	[Pr. PD26_Output device selection 4 (*DO4)]	100
	[Pr. PD28_Output device selection 6 (*DO6)]	101
	[Pr. PD29_Input filter setting (*DIF)]	101
	[Pr. PD30_Function selection D-1 (*DOP1)]	102
	[Pr. PD31_Function selection D-2 (*DOP2)]	103
	[Pr. PD32_Function selection D-3 (*DOP3)]	103
	[Pr. PD33_Function selection D-4 (*DOP4)]	103
	[Pr. PD34_Function selection D-5 (*DOP5)]	104
	[Pr. PD43_Input device selection 11L (*DI11L)]	104
	[Pr. PD44_Input device selection 11H (*DI11H)]	105
	[Pr. PD45_Input device selection 12L (*DI12L)]	105
	[Pr. PD46_Input device selection 12H (*DI12H)]	105
	[Pr. PD47_Output device selection 7 (*DO7)]	106
	[Pr. PD60_DI pin polarity selection (*DIP)]	106
1.6	Extension setting 2 servo parameters group ([Pr. PE_ _])	108
	[Pr. PE01_Fully closed loop control function selection 1 (**FCT1)]	108
	[Pr. PE03_Fully closed loop control function selection 2 (*FCT2)]	109
	[Pr. PE04_Fully closed loop control - Feedback pulse electronic gear 1 - Numerator (**FBN)]	110
	[Pr. PE05_Fully closed loop control - Feedback pulse electronic gear 1 - Denominator (**FBD)]	110
	[Pr. PE06_Fully closed loop control - Speed deviation error detection level (BC1)]	110
	[Pr. PE07_Fully closed loop control - Position deviation error detection level (BC2)]	110
	[Pr. PE08_Fully closed loop dual feedback filter (DUF)]	110
	[Pr. PE10_Fully closed loop function selection 3 (FCT3)]	111
	[Pr. PE41_Function selection E-3 (EOP3)]	111
	[Pr. PE44_Lost motion compensation positive-side compensation value selection (LMCP)]	111

[Pr. PE45_Lost motion compensation negative-side compensation value selection (LMCN)]	112
[Pr. PE46_Lost motion filter setting (LMFLT)]	112
[Pr. PE47_Unbalanced torque offset (TOF)]	112
[Pr. PE48_Lost motion compensation function selection (*LMOP)]	112
[Pr. PE49_Lost motion compensation timing (LMCD)]	113
[Pr. PE50_Lost motion compensation dead band (LMCT)]	113
[Pr. PE51_Load-side encoder resolution setting (**EDV2)]	114
1.7 Extension setting 3 servo parameters group ([Pr. PF_ _])	115
[Pr. PF02_Function selection F-2 (*FOP2)]	115
[Pr. PF09_Function selection F-5 (*FOP5)]	116
[Pr. PF15_Electronic dynamic brake operating time (DBT)]	117
[Pr. PF18_STO diagnosis error detection time (**STOD)]	117
[Pr. PF21_Drive recorder switching time setting (DRT)]	117
[Pr. PF23_Vibration tough drive - Oscillation detection level (OSCL1)]	118
[Pr. PF24_Function selection F-9 (*FOP9)]	118
[Pr. PF25_SEMI-F47 function - Instantaneous power failure detection time (Instantaneous power failure tough drive detection time) (CVAT)]	118
[Pr. PF31_Machine diagnosis function - Friction estimate area judgment speed at low speed (FRIC)]	119
[Pr. PF32_Oscillation detection alarm time (*VIBT)]	119
[Pr. PF49_Friction failure prediction - Compensation coefficient 1 (TSL)]	119
[Pr. PF50_Friction failure prediction - Compensation coefficient 2 (TIC)]	120
[Pr. PF51_Machine diagnosis function selection (*MFP)]	120
[Pr. PF52_Machine failure prediction servo parameter (MFPP)]	122
[Pr. PF53_Failure prediction - Servo motor total travel distance (FPMT)]	123
[Pr. PF54_Friction failure prediction - Average characteristics (PAV)]	123
[Pr. PF55_Friction failure prediction - Standard deviation (PSD)]	123
[Pr. PF56_Vibration failure prediction - Average characteristics (VAV)]	124
[Pr. PF57_Vibration failure prediction - Standard deviation (VSD)]	124
[Pr. PF58_Servo motor total travel distance offset (TMO)]	124
[Pr. PF62_Function selection F-14 (FOP14)]	124
[Pr. PF63_Function selection F-15 (*FOP15)]	125
[Pr. PF66_Gear setting for backlash estimation (BLG)]	126
[Pr. PF67_Backlash nominal value (BLN)]	127
[Pr. PF68_Backlash threshold multiplication (BLTT)]	127
[Pr. PF69_Static friction failure prediction - Average characteristics (SPA2)]	127
[Pr. PF70_Static friction failure prediction - Standard deviation (SPSD2)]	127
[Pr. PF71_Belt failure prediction function selection (BFP)]	128
[Pr. PF72_Belt tension on installation (SBT)]	128
[Pr. PF73_Belt tension when extended (ABT)]	128
[Pr. PF74_Static friction during installation (SSF)]	128
[Pr. PF75_Static friction when extended (ASF)]	129
[Pr. PF76_Belt tension irregular threshold (BTS)]	129
[Pr. PF80_Drive recorder - Operation condition selection (DRMC)]	130
[Pr. PF81_Drive recorder - Sampling operation selection (DRMS)]	131
[Pr. PF82_Drive recorder - Trigger operation selection (DRTM)]	131
[Pr. PF84_Drive recorder - Trigger channel selection (DRTC)]	133
[Pr. PF85_Drive recorder - Trigger level setting 1 (DRTL1)]	134
[Pr. PF86_Drive recorder - Trigger level setting 2 (DRTL2)]	134
[Pr. PF87_Drive recorder - Analog channel setting 1 (DRAC1)]	135
[Pr. PF88_Drive recorder - Analog channel setting 2 (DRAC2)]	137
[Pr. PF89_Drive recorder - Analog channel setting 3 (DRAC3)]	137

[Pr. PF90_Drive recorder - Analog channel setting 4 (DRAC4)]	138
[Pr. PF91_Drive recorder - Digital channel setting 1 (DRDC1)].	138
[Pr. PF92_Drive recorder - Digital channel setting 2 (DRDC2)].	140
[Pr. PF93_Drive recorder - Digital channel setting 3 (DRDC3)].	140
[Pr. PF94_Drive recorder - Digital channel setting 4 (DRDC4)].	141
[Pr. PF95_Drive recorder - Clear history (**DRCLR)]	141
1.8 Motor extension setting servo parameters group ([Pr. PL_ _])	142
[Pr. PL01_Function selection L-1 (**LIT1)]	142
[Pr. PL02_Linear encoder resolution setting - Numerator (**LIM)]	142
[Pr. PL03_Linear encoder resolution setting - Denominator (**LID)].	142
[Pr. PL04_Function selection L-2 (*LIT2)]	143
[Pr. PL05_Position deviation error detection level (LB1)]	143
[Pr. PL06_Speed deviation error detection level (LB2)].	143
[Pr. PL07_Torque deviation error detection level (LB3)]	144
[Pr. PL08_Function selection L-3 (*LIT3)]	144
[Pr. PL09_Magnetic pole detection voltage level (LPWM)]	144
[Pr. PL17_Magnetic pole detection - Minute position detection method - Function selection (LTSTS)]	145
[Pr. PL18_Magnetic pole detection - Minute position detection method - Identification signal amplitude (IDLV)]	146
CHAPTER 2 LISTS OF SERVO PARAMETER SUPPORTED MODES	147
2.1 Structure.	147
2.2 Lists of supported control modes	148
Basic setting servo parameters group ([Pr. PA_ _])	148
Gain/filter setting servo parameters group ([Pr. PB_ _]).	149
Extension setting servo parameters group ([Pr. PC_ _])	151
I/O setting servo parameters group ([Pr. PD_ _]).	152
Extension setting 2 servo parameters group ([Pr. PE_ _])	154
Extension setting 3 servo parameters group ([Pr. PF_ _])	155
Motor extension setting servo parameters group ([Pr. PL_ _]).	157
CHAPTER 3 LISTS OF SERVO PARAMETER INITIAL VALUES	158
3.1 Basic setting servo parameters group ([Pr. PA_ _])	158
3.2 Gain/filter setting servo parameters group ([Pr. PB_ _])	159
3.3 Extension setting servo parameters group ([Pr. PC_ _])	161
3.4 I/O setting servo parameters group ([Pr. PD_ _])	163
3.5 Extension setting 2 servo parameters group ([Pr. PE_ _])	165
3.6 Extension setting 3 servo parameters group ([Pr. PF_ _])	167
3.7 Motor extension setting servo parameters group ([Pr. PL_ _])	169
CHAPTER 4 SERVO PARAMETER SETTING METHOD	171
4.1 Engineering software	171
4.2 Operation section (push buttons)	171
CHAPTER 5 NETWORK PARAMETER DETAILS	173
5.1 Network basic parameters	174
[Pr. NPA02_IP address].	174
[Pr. NPA04_Subnet mask].	174
[Pr. NPA08_Host name].	174
[Pr. NPA12_Communication speed]	175

5.2	User authentication parameters.	176
	[Pr. NPB01_User authentication and authorization setting].	176
	[Pr. NPB04_User name No.1].	176
	[Pr. NPB05_Authorization level No.1].	176
	[Pr. NPB06_Password No.1].	177
	[Pr. NPB07_User name No.2].	177
	[Pr. NPB08_Authorization level No.2].	177
	[Pr. NPB09_Password No.2].	177
	[Pr. NPB10_User name No.3].	177
	[Pr. NPB11_Authorization level No.3].	177
	[Pr. NPB12_Password No.3].	177
	[Pr. NPB13_User name No.4].	178
	[Pr. NPB14_Authorization level No.4].	178
	[Pr. NPB15_Password No.4].	178
	[Pr. NPB16_User name No.5].	178
	[Pr. NPB17_Authorization level No.5].	178
	[Pr. NPB18_Password No.5].	178
	[Pr. NPB19_User name No.6].	178
	[Pr. NPB20_Authorization level No.6].	179
	[Pr. NPB21_Password No.6].	179
	[Pr. NPB22_User name No.7].	179
	[Pr. NPB23_Authorization level No.7].	179
	[Pr. NPB24_Password No.7].	179
	[Pr. NPB25_User name No.8].	179
	[Pr. NPB26_Authorization level No.8].	179
	[Pr. NPB27_Password No.8].	180
 CHAPTER 6 NETWORK PARAMETER SETTING METHOD		 182
6.1	Engineering software	182
	REVISIONS	184
	WARRANTY	185
	TRADEMARKS	186

1 SERVO PARAMETER DETAILS

Restrictions

Settable servo parameters and values depend on the controller model, servo amplifier firmware version, and MR Configurator2 software version. For details, refer to the controller user's manual. Refer to the Mitsubishi Electric FA site for the latest software version of MR Configurator2. In addition, the firmware version of the servo amplifier can be checked with MR Configurator2 or by other means.

When using servo motors with functional safety, executing software reset may trigger [AL. 016 Encoder initial communication error 1]. If [AL. 016] occurs, cycle the power.

Precautions

Never make a drastic adjustment or change to the servo parameter values as doing so will make the operation unstable. Do not change the servo parameter settings as described below. Doing so may cause an unexpected condition, such as failing to start up the servo amplifier.

- Changing the values of the servo parameters for manufacturer setting
- Setting a value outside the range
- Changing the fixed value in each servo parameter

When writing servo parameters with the controller, make sure that the control axis No. of the servo amplifier is set correctly. Failure to do so may cause the servo parameter settings of another axis to be written and result in the servo amplifier being in an unexpected condition.

Some servo parameters are adjusted automatically. For example, auto tuning automatically adjusts gain servo parameters.

1.1 Explanation of servo parameters

For how to interpret the servo parameter numbers, refer to the following.

☞ Page 4 Interpreting servo parameter numbers

The following explains how to read the details of servo parameters.

Item	Explanation
No.	Indicates the servo parameter No., which can be identified by the servo parameter group and number.
Symbol	Indicates the abbreviation of the servo parameter. *** added to abbreviations means the following. * or **: After setting, cycle the power or reset the software.
Name	Indicates the name of the servo parameter.
Initial value	Indicates the servo parameter initial value at factory setting. When there is a unit in the servo parameter, the unit is shown with [].
Setting range	Indicates the setting range of the servo parameter.
Ver.	Indicates the supported firmware version of the servo amplifier. The servo parameter is available on servo amplifiers with the firmware version or later.

Servo parameter No., symbols, and names are indicated as follows.

[Pr. PA01 Operation mode (STY)]**

└ Symbol
└ Name
└ No./Detail No.

1.2 Basic setting servo parameters group ([Pr. PA_ _])

[Pr. PA01_Operation mode (**STY)]

Initial value	Setting range	Ver.
10003000h	Refer to the relevant detail No.	Refer to the relevant detail No.

[Pr. PA01.0_Control mode selection]

Initial value	Setting range	Ver.
0h	Refer to the text	A0

Select a control mode.

- 0: Position control mode (P)
- 1: Position control mode and speed control mode (P/S)
- 2: Speed control mode (S)
- 3: Speed control mode and torque control mode (S/T)
- 4: Torque control mode (T)
- 5: Torque control mode and position control mode (T/P)

[Pr. PA01.1_Operation mode selection]

Initial value	Setting range	Ver.
0h	Refer to the text	A0

- 0: Standard control mode
- 4: Linear servo motor control mode
- 6: Direct drive motor control mode

[Pr. PA01.4_Fully closed loop operation mode selection]

Initial value	Setting range	Ver.
0h	Refer to the text	A5

Select whether to enable or disable the fully closed loop control mode.

The external encoder communication method of four-wire type cannot be used in the fully closed loop control mode on the MR-J5-_A_. In that case, use the MR-J5-_A_-RJ.

When this servo parameter is set to "1" in the linear servo motor control mode, [AL. 037 Parameter error] occurs.

- 0: Disabled (semi closed loop control mode)
- 1: Enabled (fully closed loop control mode)

[Pr. PA02_Regenerative option (**REG)]

Initial value	Setting range	Ver.
00000000h	Refer to the relevant detail No.	Refer to the relevant detail No.

[Pr. PA02.0-1_Regenerative option selection]

Initial value	Setting range	Ver.
00h	Refer to the text	A0

Select a regenerative option.

Incorrect setting may cause the regenerative option to burn.

Other regenerative options cannot be used together with the FR-XC-(H).

If a selected regenerative option is not for use with the servo amplifier, [AL. 037 Parameter error] occurs.

00: Regenerative option is not used.

- No regenerative resistors are used on servo amplifiers with a capacity of 100 W.
- Built-in regenerative resistors are used on servo amplifiers with a capacity of 0.2 kW to 7 kW.

01: FR-XC-(H)

02: MR-RB032

03: MR-RB12

05: MR-RB30

06: MR-RB50 (A cooling fan is required.)

08: MR-RB31

09: MR-RB51 (A cooling fan is required.)

0B: MR-RB3N

0C: MR-RB5N (A cooling fan is required.)

0D: MR-RB14

0E: MR-RB34

1C: MR-RB3Z

1D: MR-RB5Z (A cooling fan is required.)

80: MR-RB1H-4

81: MR-RB3M-4 (A cooling fan is required.)

82: MR-RB3G-4 (A cooling fan is required.)

83: MR-RB5G-4 (A cooling fan is required.)

84: MR-RB34-4 (A cooling fan is required.)

85: MR-RB54-4 (A cooling fan is required.)

91: MR-RB3U-4 (A cooling fan is required.)

92: MR-RB5U-4 (A cooling fan is required.)

93: MR-RB3Y-4 (A cooling fan is required.)

94: MR-RB5Y-4 (A cooling fan is required.)

"1C" and "1D" are available on servo amplifiers with firmware version B6 or later.

"84", "85", "91", and "92" are available on servo amplifiers with firmware version E0 or later.

[Pr. PA02.4_Simple converter selection]

Initial value	Setting range	Ver.
0h	Refer to the text	A0

When using the simple converter, set this servo parameter.

The simple converter and external regenerative option can be used together. When using an external regenerative option, set the regenerative option to be used with [Pr. PA02.0-1].

When [Pr. PA02.0-1 Regenerative option selection] is set to "01" (FR-XC-(H)), setting this servo parameter to "1" (enabled) triggers [AL. 037 Parameter error].

For MR-J5-_A4_, setting this servo parameter to "1" (enabled) triggers [AL. 037 Parameter error].

0: Simple converter is not used

1: MR-CM3K

[Pr. PA02.5_Excessive regeneration warning enabled/disabled selection]

Initial value	Setting range	Ver.
0h	Refer to the text	A0

When [Pr. PA02.4] is set to "0" (simple converter is not used), setting this servo parameter to "1" (disabled) triggers [AL. 037 Parameter error].

When the simple converter is used, whether to enable or disable the detection of [AL. 0E0.1 Excessive regeneration warning] is selectable with this servo parameter.

0: Enabled

1: Disabled

[Pr. PA03_Absolute position detection system (*ABS)]

Initial value	Setting range	Ver.
0000000h	Refer to the relevant detail No.	Refer to the relevant detail No.

[Pr. PA03.0_Absolute position detection system selection]

Initial value	Setting range	Ver.
0h	Refer to the text	A0

Set this servo parameter when using the absolute position detection system in the position control mode. If the absolute position detection system is switched to the incremental system, the home position is erased. Execute homing again when the absolute position detection system is enabled.

0: Disabled (incremental system)

1: Enabled (absolute position detection system by DIO)

2: Enabled (absolute position detection system via communications)

The absolute position detection system cannot be used when an incremental type encoder is used or when the semi closed/ fully closed loop control switching function selection is enabled. At this time, enabling the absolute position detection system triggers [AL. 037 Parameter error].

"2" is available on servo amplifiers with firmware version B6 or later.

By setting [Pr. PF63.0 [AL. 01A.5 Servo motor combination error 3] selection] to "1" (disabled) while the absolute position detection system is enabled, an in-use servo motor with a batteryless absolute position encoder can be replaced without changing the setting value of [Pr. PA03.1 Servo motor replacement preparation].

Connecting a servo motor that had not been connected at the startup of the absolute position detection system will cause [AL. 025 Absolute position erased], erasing absolute position data.

Therefore, check if a correct servo motor is connected.

[Pr. PA03.1_Servo motor replacement preparation]

Initial value	Setting range	Ver.
0h	Refer to the text	A0

To replace an in-use batteryless absolute position encoder equipped servo motor while the absolute position detection system is in enabled status, set this servo parameter to "enabled".

Selecting "1" (enabled) enables servo motor replacement. After completing the servo motor replacement preparation, the value automatically changes to "0" (disabled) and the home position is erased.

After replacing the servo motor, execute homing again.

After setting this servo parameter to "1" (enabled), cycle the power and then deactivate [AL. 01A.5 Servo motor combination error 3].

0: Disabled

1: Enabled

To set this servo parameter to "1" (enabled), refer to "Procedure of replacing a servo motor with battery-less absolute position encoder" in the User's Manual (Hardware).

[Pr. PA04_Function selection A-1 (*AOP1)]

Initial value	Setting range	Ver.
00002000h	Refer to the relevant detail No.	Refer to the relevant detail No.

[Pr. PA04.3_Forced stop deceleration function selection]

Initial value	Setting range	Ver.
2h	Refer to the text	A0

0: Forced stop deceleration function disabled (EM1 is used)

2: Forced stop deceleration function enabled (EM2 is used)

[Pr. PA05_Number of command input pulses per revolution (*FBP)]

Initial value	Setting range	Ver.
10000 [pulse]	1000 to 1000000	A0

The servo motor rotates once as per command input pulse that has been set.

The setting value of this servo parameter is enabled when [Pr. PA21.3 Electronic gear compatibility selection] is set to "1" (number of command input pulses per revolution). In the linear servo motor control mode or fully closed loop control mode, [Pr. PA21.3] cannot be set to "1".

[Pr. PA06_Electronic gear numerator (CMX)]

Initial value	Setting range	Ver.
1	1 to 2147483647	A0

Set the electronic gear numerator.

This servo parameter is enabled in the following condition: [Pr. PA21.3 Electronic gear compatibility selection] is "0" (electronic gear), "2" (J3 electronic gear setting value compatibility mode), "3" (J2S electronic gear setting value compatibility mode), or "4" (J4 electronic gear setting value compatibility mode).

The condition range of the electronic gear ratio is shown in the table below. If the set value is outside this range, noise may be generated during acceleration/deceleration, or operation may not be performed at the preset speed and/or acceleration/deceleration time constants. In addition, if the electric gear numerator exceeds "2147483647" by combining this servo parameter and [Pr. PA21.3], the electric gear numerator is limited to "2147483647".

Encoder resolution [pulse]	Setting range (CMX/CDV)
67108864	1/10 < CMX/CDV < 64000

[Pr. PA07_Electronic gear denominator (CDV)]

Initial value	Setting range	Ver.
1	1 to 2147483647	A0

Set the electronic gear denominator.

This servo parameter is enabled in the following condition: [Pr. PA21.3 Electronic gear compatibility selection] is "0" (electronic gear), "2" (J3 electronic gear setting value compatibility mode), "3" (J2S electronic gear setting value compatibility mode), or "4" (J4 electronic gear setting value compatibility mode).

[Pr. PA08_Auto tuning mode (ATU)]

Initial value	Setting range	Ver.
00000001h	Refer to the relevant detail No.	Refer to the relevant detail No.

[Pr. PA08.0_Gain adjustment mode selection]

Initial value	Setting range	Ver.
1h	Refer to the text	A0

Select the gain adjustment mode.

0: 2 gain adjustment mode 1 (interpolation mode)

1: Auto tuning mode 1

2: Auto tuning mode 2

3: Manual mode

4: 2 gain adjustment mode 2

5: Quick tuning mode

6: Load to motor inertia ratio monitor mode

Refer to the following table for details.

Setting value of [Pr. PA08.0]	Gain adjustment mode	Servo parameter adjusted automatically
0	2 gain adjustment mode 1 (interpolation mode)	[Pr. PB06 Load to motor inertia ratio/load to motor mass ratio] [Pr. PB08 Position control gain] [Pr. PB09 Speed control gain] [Pr. PB10 Speed integral compensation]
1	Auto tuning mode 1	[Pr. PB06 Load to motor inertia ratio/load to motor mass ratio] [Pr. PB07 Model control gain] [Pr. PB08 Position control gain] [Pr. PB09 Speed control gain] [Pr. PB10 Speed integral compensation]
2	Auto tuning mode 2	[Pr. PB07 Model control gain] [Pr. PB08 Position control gain] [Pr. PB09 Speed control gain] [Pr. PB10 Speed integral compensation]
3	Manual mode	—
4	2 gain adjustment mode 2	[Pr. PB08 Position control gain] [Pr. PB09 Speed control gain] [Pr. PB10 Speed integral compensation]
5	Quick tuning mode	[Pr. PB07 Model control gain] [Pr. PB08 Position control gain] [Pr. PB09 Speed control gain] [Pr. PB10 Speed integral compensation] [Pr. PB13 Machine resonance suppression filter 1] [Pr. PB14 Notch shape selection 1] [Pr. PB15 Machine resonance suppression filter 2] [Pr. PB16 Notch shape selection 2] [Pr. PB18 Low-pass filter setting] [Pr. PB23 Low-pass filter selection] [Pr. PB50 Machine resonance suppression filter 5] [Pr. PB51 Notch shape selection 5] [Pr. PE41 Function selection E-3]
6	Load to motor inertia ratio monitor mode	[Pr. PB06 Load to motor inertia ratio/load to motor mass ratio]

[Pr. PA08.4_Quick tuning - Load to motor inertia ratio setting]

Initial value	Setting range	Ver.
0h	Refer to the text	A0

Set the load to motor inertia ratio at quick tuning. If the load connected to the servo motor is larger than the load to motor inertia ratio set in the servo parameter, an overshoot may occur in positioning operation after quick tuning.

0: Load to motor inertia ratio of 30 times or less

1: Load to motor inertia ratio of 100 times or less

[Pr. PA08.5_Quick tuning - Execution selection]

Initial value	Setting range	Ver.
0h	Refer to the text	A0

Set when to execute quick tuning.

0: At initial servo-on after cycling the power

1: At every servo-on

[Pr. PA08.6_Quick tuning - Restore selection]

Initial value	Setting range	Ver.
0h	Refer to the text	A0

Set whether to return servo parameters to the values from before quick tuning.

0: Disabled

1: Enabled

By setting "1" (enabled), the following servo parameters return to the values from before quick tuning. If quick tuning has never been performed after power on or software reset, setting "1" (enabled) only keeps the current servo parameter values.

No.	Symbol	Name
PB01	FILT	Adaptive tuning mode (adaptive filter II)
PB07	PG1	Model control gain
PB08	PG2	Position control gain
PB09	VG2	Speed control gain
PB10	VIC	Speed integral compensation
PB11	VDC	Speed differential compensation
PB13	NH1	Machine resonance suppression filter 1
PB14	NHQ1	Notch shape selection 1
PB15	NH2	Machine resonance suppression filter 2
PB16	NHQ2	Notch shape selection 2
PB18	LPF	Low-pass filter setting
PB23	VFBF	Low-pass filter selection
PB50	NH5	Machine resonance suppression filter 5
PB51	NHQ5	Notch shape selection 5
PE41	EOP3	Function selection E-3 (Robust filter)

[Pr. PA09_Auto tuning response (RSP)]

Initial value	Setting range	Ver.
16	Refer to the text	A0

Set the auto tuning response.

Setting value	Machine characteristic	
	Responsiveness	Guideline for machine resonance frequency [Hz]
1	<div style="display: flex; flex-direction: column; align-items: center;"> <div style="margin-bottom: 20px;">Low response</div> <div style="margin-bottom: 20px;">↑</div> <div style="margin-bottom: 20px;">↓</div> <div style="margin-bottom: 20px;">Middle response</div> <div style="margin-bottom: 20px;">↑</div> <div style="margin-bottom: 20px;">↓</div> <div style="margin-bottom: 20px;">High response</div> </div>	2.7
2		3.6
3		4.9
4		6.6
5		10.0
6		11.3
7		12.7
8		14.3
9		16.1
10		18.1
11		20.4
12		23.0
13		25.9
14		29.2
15		32.9
16		37.0
17		41.7
18		47.0
19		52.9
20		59.6
21		67.1
22		75.6
23		85.2
24		95.9
25		108.0
26		121.7
27		137.1
28		154.4
29		173.9
30		195.9
31		220.6
32		248.5
33		279.9
34		315.3
35		355.1
36		400.0
37		446.6
38		501.2
39		571.5
40		642.7

[Pr. PA10_In-position range (INP)]

Initial value	Setting range	Ver.
400 [Refer to the text below for the unit.]	0 to 16777215	A0

Set the in-position range in the command pulse unit.

With the setting of [Pr. PC24.0 In-position range unit selection], the unit can be changed to the servo motor encoder pulse unit.

- In-position range setting

Control mode [Pr. PA01]	In-position setting range
Position, speed, and torque control modes	Range where positioning completion (INP) is output

- Selecting an encoder for in-position range control

[Pr. PA01.4 Fully closed loop operation mode selection]	In-position range unit
"0" (semi closed loop system)	Command resolution unit (motor-side encoder)
"1" (fully closed loop system)	Command resolution unit (load-side encoder)

- In-position range unit

[Pr. PA01.0 Control mode selection]	[Pr. PC24.0 In-position range unit selection]	Unit
Position, speed, and torque control modes	0 (command unit)	pulse
	1 (servo motor encoder pulse unit)	pulse

[Pr. PA11_Forward rotation torque limit (TLP)]

Initial value	Setting range	Ver.
1000.0 [%]	0.0 to 1000.0	A0

The torque or thrust generated by the servo motor can be limited.

Set this servo parameter in relation to the rated torque or continuous thrust (= 100.0 %). Set the servo parameter when limiting the torque of the servo motor for CCW power running or CW regeneration, or when limiting the thrust of the linear servo motor for positive direction power running or negative direction regeneration. If this servo parameter is set to "0.0", the servo motor does not generate torque or thrust.

When [Pr. PC50.0 Torque limit unit change] is set to "0" (maximum torque unit), set the servo parameter in relation to the maximum torque or maximum thrust (= 100.0 %).

If a value larger than the maximum torque or maximum thrust of the servo motor is set, the value will be limited to the maximum torque or maximum thrust of the servo motor.

When torque (thrust) is output with the analog monitor output, the larger value of either [Pr. PA11 Forward rotation torque limit] or [Pr. PA12 Reverse rotation torque limit] is applied to the torque (thrust) at the maximum output voltage.

[Pr. PA12_Reverse rotation torque limit (TLN)]

Initial value	Setting range	Ver.
1000.0 [%]	0.0 to 1000.0	A0

The torque or thrust generated by the servo motor can be limited.

Set this servo parameter in relation to the rated torque or continuous thrust (= 100.0 %). Set the servo parameter to limit the torque of the servo motor for CW power running or CCW regeneration, or to limit the thrust of the linear servo motor for positive direction power running or negative direction regeneration. If this servo parameter is set to "0.0", the servo motor does not generate torque or thrust.

When [Pr. PC50.0 Torque limit unit change] is set to "0" (maximum torque unit), set the servo parameter in relation to the maximum torque or maximum thrust (= 100.0 %).

If a value larger than the maximum torque or maximum thrust of the servo motor is set, the value will be limited to the maximum torque or maximum thrust of the servo motor.

When torque (thrust) is output with the analog monitor output, the larger value of either [Pr. PA11 Forward rotation torque limit] or [Pr. PA12 Reverse rotation torque limit] is applied to the torque (thrust) at the maximum output voltage.

[Pr. PA13_Command pulse input form (*PLSS)]

Initial value	Setting range	Ver.
00000100h	Refer to the relevant detail No.	Refer to the relevant detail No.

[Pr. PA13.0_Command input pulse train form selection]

Initial value	Setting range	Ver.
0h	Refer to the text	A0

0: Forward/reverse rotation pulse train

1: Signed pulse train

2: A-phase/B-phase pulse train (the servo amplifier multiplies the input pulse by 4, and captures the multiplied input pulses.)

Refer to the following table for setting values.

[Pr. PA13.1]	[Pr. PA13.0]	Pulse train form	Forward rotation (positive direction) command	Reverse rotation (negative direction) command
1	0	Negative logic Forward rotation pulse train (positive direction pulse train) Reverse rotation pulse train (negative direction pulse train)		
1	1	Positive pulse train		
1	2	A-phase pulse train B-phase pulse train		
0	0	Positive logic Forward rotation pulse train (positive direction pulse train) Reverse rotation pulse train (negative direction pulse train)		
0	1	Positive pulse train		
0	2	A-phase pulse train B-phase pulse train		

Arrows in the table indicate the timing of importing pulse trains. A-phase/B-phase pulse trains are imported after they have been multiplied by 4.

[Pr. PA13.1_Pulse train logic selection]

Initial value	Setting range	Ver.
0h	Refer to the text	A0

0: Positive logic

1: Negative logic

Match the logic of the command pulse train received from the connected controller.

Refer to the following for setting values.

☞ Page 22 [Pr. PA13.0_Command input pulse train form selection]

[Pr. PA13.2_Command input pulse train filter selection]

Initial value	Setting range	Ver.
1h	Refer to the text	A0

Selecting the appropriate filter for the command pulse frequency can increase noise tolerance.

0: Command input pulse train is 4 Mpulses/s or less

1: Command input pulse train is 1 Mpulse/s or less

2: Command input pulse train is 500 kpulses/s or less

3: Command input pulse train is 200 kpulses/s or less

"1" can be set for commands up to 1 Mpulse/s. When inputting commands exceeding 1 Mpulse/s and up to 4 Mpulses/s, set "0".

To prevent the following malfunctions, set a correct value in accordance with the command pulse frequency.

Setting a value higher than the actual command value will decrease noise tolerance.

Setting a value lower than the actual command will cause a position mismatch.

[Pr. PA14_Travel direction selection (*POL)]

Initial value	Setting range	Ver.
0	0 to 1	A0

Select the servo motor rotation direction or linear servo motor travel direction for the command input pulse.

- For position control mode

With the setting value of [Pr. PA14 Travel direction selection], the rotation and travel direction can be changed without reversing the forward/reverse rotation pulse inputs for the input pulse train.

- For speed and torque control modes

The rotation and travel direction cannot be changed with the servo parameter.

The servo motor rotation direction is as follows.

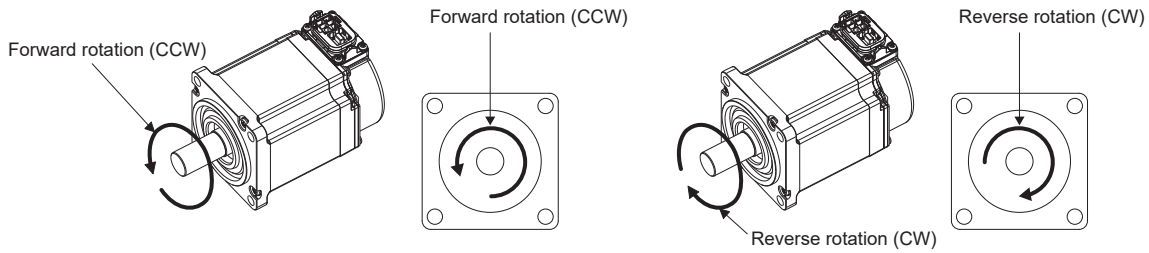

The positive and negative directions of the linear servo motor are as follows.

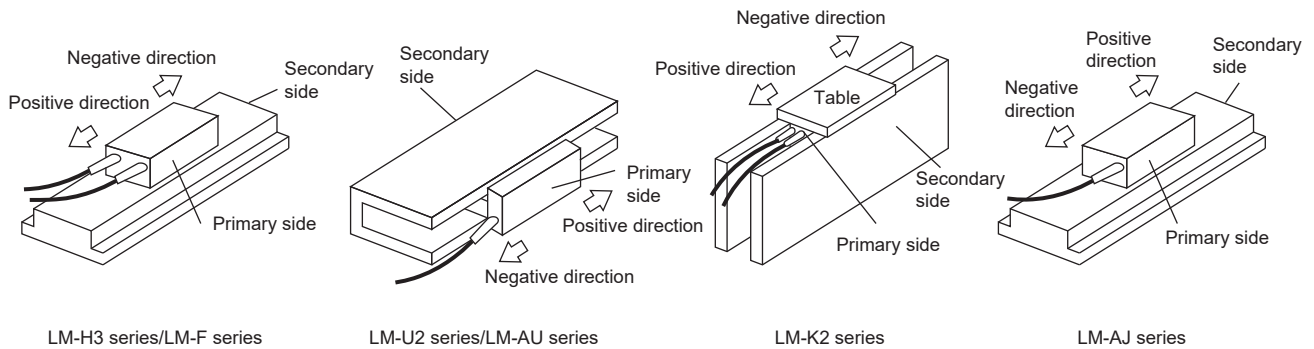

[Pr. PA15_ Encoder output pulses (*ENR)]

Initial value	Setting range	Ver.
4000 [pulse/rev]	1 to 67108864	A0

Set the encoder output pulses output from the servo amplifier, by using the number of output pulses per revolution, dividing ratio, or electronic gear ratio. (after multiplication by 4)

Selecting "1" (dividing ratio setting) in [Pr. PC19.1 Encoder output pulse setting selection] will divide the travel distance [pulse] by the setting value.

Set a numerator for the electronic gear for the A/B-phase pulse output when selecting "3" (A-phase/B-phase pulse electronic gear setting) in [Pr. PC19.1].

The maximum output frequency is 4.6 Mpulses/s. Set the value within the range.

[Pr. PA16_ Encoder output pulses 2 (*ENR2)]

Initial value	Setting range	Ver.
1	1 to 67108864	A0

Set the electronic gear denominator for the A/B-phase pulse output.

Set a denominator for the electronic gear when selecting "3" (A-phase/B-phase pulse electronic gear setting) in [Pr. PC19.1 Encoder output pulse setting selection].

Selecting "1" (dividing ratio setting) in [Pr. PC19.1] will disable the setting value.

The maximum output frequency is 4.6 Mpulses/s. Set the value within the range.

[Pr. PA17_Servo motor series setting (**MSR)]

Initial value	Setting range	Ver.
00000000h	Refer to the text	A0

To select the linear servo motor to be used, set this servo parameter and [Pr. PA18.0-3 Servo motor type setting]. Set this at the same time with [Pr. PA18.0-3]. Refer to the following table for setting values.

Linear servo motor series	Linear servo motor (primary side)	Servo parameter	
		Setting value of [Pr. PA17]	Setting value of [Pr. PA18.0-3]
LM-H3	LM-H3P2A-07P-BSS0	000000BBh	2101h
	LM-H3P3A-12P-CSS0		3101h
	LM-H3P3B-24P-CSS0		3201h
	LM-H3P3C-36P-CSS0		3301h
	LM-H3P3D-48P-CSS0		3401h
	LM-H3P7A-24P-ASS0		7101h
	LM-H3P7B-48P-ASS0		7201h
	LM-H3P7C-72P-ASS0		7301h
	LM-H3P7D-96P-ASS0		7401h
LM-U2	LM-U2PAB-05M-0SS0	000000B4h	A201h
	LM-U2PAD-10M-0SS0		A401h
	LM-U2PAF-15M-0SS0		A601h
	LM-U2PBB-07M-1SS0		B201h
	LM-U2PBD-15M-1SS0		B401h
	LM-U2PBF-22M-1SS0		2601h
	LM-U2P2B-40M-2SS0		2201h
	LM-U2P2C-60M-2SS0		2301h
	LM-U2P2D-80M-2SS0		2401h
LM-F	LM-FP2B-06M-1SS0 (natural cooling)	000000B2h	2201h
	LM-FP2D-12M-1SS0 (natural cooling)		2401h
	LM-FP2F-18M-1SS0 (natural cooling)		2601h
	LM-FP4B-12M-1SS0 (natural cooling)		4201h
	LM-FP4D-24M-1SS0 (natural cooling)		4401h
	LM-FP4F-36M-1SS0 (natural cooling)		4601h
	LM-FP4H-48M-1SS0 (natural cooling)		4801h
	LM-FP5H-60M-1SS0 (natural cooling)		5801h
	LM-FP2B-06M-1SS0 (liquid-cooling)		2202h
	LM-FP2D-12M-1SS0 (liquid-cooling)		2402h
	LM-FP2F-18M-1SS0 (liquid-cooling)		2602h
	LM-FP4B-12M-1SS0 (liquid-cooling)		4202h
	LM-FP4D-24M-1SS0 (liquid-cooling)		4402h
	LM-FP4F-36M-1SS0 (liquid-cooling)		4602h
	LM-FP4H-48M-1SS0 (liquid-cooling)		4802h
LM-FP5H-60M-1SS0 (liquid-cooling)	5802h		
LM-K2	LM-K2P1A-01M-2SS1	000000B8h	1101h
	LM-K2P1C-03M-2SS1		1301h
	LM-K2P2A-02M-1SS1		2101h
	LM-K2P2C-07M-1SS1		2301h
	LM-K2P2E-12M-1SS1		2501h
	LM-K2P3C-14M-1SS1		3301h
	LM-K2P3E-24M-1SS1		3501h

Linear servo motor series	Linear servo motor (primary side)	Servo parameter	
		Setting value of [Pr. PA17]	Setting value of [Pr. PA18.0-3]
LM-AJ	LM-AJP1B-07K-JSS0	000000DAh	1201h
	LM-AJP1D-14K-JSS0		1401h
	LM-AJP2B-12S-JSS0		2201h
	LM-AJP2D-23T-JSS0		2401h
	LM-AJP3B-17N-JSS0		3201h
	LM-AJP3D-35R-JSS0		3401h
	LM-AJP4B-22M-JSS0		4201h
	LM-AJP4D-45N-JSS0		4401h
LM-AU	LM-AUP3A-03V-JSS0	000000DBh	3102h
	LM-AUP3B-06V-JSS0		3202h
	LM-AUP3C-09V-JSS0		3302h
	LM-AUP3D-11R-JSS0		3402h
	LM-AUP4A-04R-JSS0		4102h
	LM-AUP4B-09R-JSS0		4202h
	LM-AUP4C-13P-JSS0		4302h
	LM-AUP4D-18M-JSS0		4402h
	LM-AUP4F-26P-JSS0		4602h
	LM-AUP4H-35M-JSS0		4802h

[Pr. PA18_Servo motor type setting (**MTY)]

Initial value	Setting range	Ver.
00000000h	Refer to the relevant detail No.	Refer to the relevant detail No.

[Pr. PA18.0-3_Servo motor type setting]

Initial value	Setting range	Ver.
0000h	Refer to the text	A0

When using a linear servo motor, select any linear servo motor with [Pr. PA17 Servo motor series setting] and [Pr. PA18.0-3 Servo motor type setting]. Set this at the same time with [Pr. PA17]. Refer to the following for setting values.

☞ Page 26 [Pr. PA17_Servo motor series setting (**MSR)]

[Pr. PA19_Servo parameter writing prohibited (*BLK)]

Initial value	Setting range	Ver.
000000ABh	Refer to the text	A0

Select a reference range and writing range for the servo parameter.

Refer to the following table for setting values.

[Pr. PA19]	Setting value operation	PA	PB	PC	PD	PE	PF	PO	PS	PL, PU	PT, PV	PN
Setting values not listed below	Readable	○	×	×	×	×	×	×	×	×	×	×
	Writable	○	×	×	×	×	×	×	×	×	×	×
0000000A	Readable	19 only	×	×	×	×	×	×	×	×	×	×
	Writable	19 only	×	×	×	×	×	×	×	×	×	×
0000000B	Readable	○	○	○	×	×	×	×	×	×	×	×
	Writable	○	○	○	×	×	×	×	×	×	×	×
0000000C	Readable	○	○	○	○	×	×	×	×	×	×	×
	Writable	○	○	○	○	×	×	×	×	×	×	×
0000000D	Readable	○	○	○	○	×	×	×	○	×	×	×
	Writable	○	○	○	○	×	×	×	○	×	×	×
0000000E	Readable	○	○	○	○	×	×	○	○	×	×	×
	Writable	○	○	○	○	×	×	○	○	×	×	×
0000000F	Readable	○	○	○	○	○	×	○	○	○	×	×
	Writable	○	○	○	○	○	×	○	○	○	×	×
000000AA	Readable	○	○	○	○	○	○	×	×	×	×	×
	Writable	○	○	○	○	○	○	×	×	×	×	×
000000AB (initial value)	Readable	○	○	○	○	○	○	○	○	○	○	○
	Writable	○	○	○	○	○	○	○	○	○	○	○
0000100B	Readable	○	×	×	×	×	×	×	×	×	×	×
	Writable	19 only	×	×	×	×	×	×	×	×	×	×
0000100C	Readable	○	○	○	○	×	×	×	×	×	×	×
	Writable	19 only	×	×	×	×	×	×	×	×	×	×
0000100D	Readable	○	○	○	○	×	×	×	○	×	×	×
	Writable	19 only	×	×	×	×	×	×	×	×	×	×
0000100E	Readable	○	○	○	○	×	×	○	○	×	×	×
	Writable	19 only	×	×	×	×	×	×	×	×	×	×
0000100F	Readable	○	○	○	○	○	×	○	○	○	×	×
	Writable	19 only	×	×	×	×	×	×	×	×	×	×
000010AA	Readable	○	○	○	○	○	○	×	×	×	×	×
	Writable	19 only	×	×	×	×	×	×	×	×	×	×
000010AB	Readable	○	○	○	○	○	○	○	○	○	○	○
	Writable	19 only	×	×	×	×	×	×	×	×	×	×

The settings of this servo parameter are disabled if they are read/written via engineering software (such as MR Configurator2).

[Pr. PA20_Tough drive setting (*TDS)]

Initial value	Setting range	Ver.
00000000h	Refer to the relevant detail No.	Refer to the relevant detail No.

[Pr. PA20.1_Vibration tough drive selection]

Initial value	Setting range	Ver.
0h	Refer to the text	A0

0: Disabled

1: Machine resonance suppression filter change mode enabled

2: Machine resonance suppression filter automatic setting mode

Selecting other than "0" for this servo parameter suppresses vibrations by automatically changing the setting values of [Pr. PB13 Machine resonance suppression filter 1] and [Pr. PB15 Machine resonance suppression filter 2] if the vibration exceeds the value of the oscillation level set in [Pr. PF23 Vibration tough drive - Oscillation detection level].

For "1", the vibration tough drive functions when [Pr. PB13] and [Pr. PB15] are enabled. For "2", the vibration tough drive functions even when [Pr. PB13] and [Pr. PB15] are disabled.

When using the vibration tough drive, selecting "2" (machine resonance suppression filter automatic setting mode) is recommended.

[Pr. PA20.2_SEMI-F47 function selection]

Initial value	Setting range	Ver.
0h	Refer to the text	A0

0: Disabled

1: Enabled

Selecting "1" enables to avoid triggering [AL. 010 Undervoltage] by using the electrical energy charged in the capacitor in case that an instantaneous power failure occurs during operation. In [Pr. PF25 SEMI-F47 function - Instantaneous power failure detection time (Instantaneous power failure tough drive detection time)], the time until the occurrence of [AL. 010.1 Voltage drop in the control circuit power] can be set.

[Pr. PA21_Function selection A-3 (*AOP3)]

Initial value	Setting range	Ver.
00000001h	Refer to the relevant detail No.	Refer to the relevant detail No.

[Pr. PA21.0_One-touch tuning function selection]

Initial value	Setting range	Ver.
1h	Refer to the text	A0

0: Disabled

1: Enabled

When the servo parameter is set to "0", the one-touch tuning cannot be performed.

[Pr. PA21.3_Electronic gear compatibility selection]

Initial value	Setting range	Ver.
0h	Refer to the text	A0

Set a value for the electronic gear compatibility selection.

Setting value	Function selection	Electronic gear numerator	Electronic gear denominator	Explanation
0	Electronic gear	[Pr. PA06]	[Pr. PA07]	—
1	Number of command input pulses per revolution	Encoder resolution	[Pr. PA05]	—
2	J3 electronic gear setting value compatibility mode	[Pr. PA06] × 256	[Pr. PA07]	The setting value of the electronic gear for MR-J3 can be used. Set this value when the encoder resolution of the servo motor was 262144 [pulse/rev].
3	J2S electronic gear setting value compatibility mode	[Pr. PA06] × 512	[Pr. PA07]	The setting value of the electronic gear for MR-J2S can be used. Set this value when the encoder resolution of the servo motor was 131072 [pulse/rev].
4	J4 electronic gear setting value compatibility mode	[Pr. PA06] × 16	[Pr. PA07]	The setting value of the electronic gear for MR-J4 can be used. Set this value when the encoder resolution of the servo motor was 4194304 [pulse/rev].

In the linear servo motor control mode or fully closed loop control mode, "1" is not available. Setting "1" triggers [AL. 037 Parameter error].

[Pr. PA22_Position control configuration selection (**PCS)]

Initial value	Setting range	Ver.
00000000h	Refer to the relevant detail No.	Refer to the relevant detail No.

[Pr. PA22.1_Super trace function selection]

Initial value	Setting range	Ver.
0h	Refer to the text	A5

0: Disabled

2: Enabled

[Pr. PA23_Drive recorder desired alarm trigger setting (DRAT)]

Initial value	Setting range	Ver.
00000000h	Refer to the relevant detail No.	Refer to the relevant detail No.

This servo parameter is enabled in the following conditions:

- [Pr. PF80.0 Drive recorder - Operation mode selection] = "0" (automatic setting mode)
- [Pr. PF80.0] = "1" (manual setting mode) and [Pr. PF82.0 Drive recorder - Trigger mode selection] = "0" (alarm trigger)

Ex.

To activate the drive recorder when [AL. 050 Overload 1] occurs, set "00005000h".

To activate the drive recorder when [AL. 050.3 Thermal overload error 4 during operation] occurs, set this servo parameter to "00005003h".

[Pr. PA23.0-1_Alarm detail number setting]

Initial value	Setting range	Ver.
00h	00h to FFh	A0

Set this servo parameter to execute the trigger with a desired alarm detail No. for the drive recorder function.

When "00h" is selected, only the desired alarm No. setting will be enabled.

[Pr. PA23.2-4_Alarm number setting]

Initial value	Setting range	Ver.
000h	000h to FFFh	A0

Set this to execute the trigger with a desired alarm No. for the drive recorder function.

When "000h" is selected, the desired alarm trigger of the drive recorder is disabled.

[Pr. PA24_Function selection A-4 (AOP4)]

Initial value	Setting range	Ver.
0000000h	Refer to the relevant detail No.	Refer to the relevant detail No.

[Pr. PA24.0_Vibration suppression mode selection]

Initial value	Setting range	Ver.
0h	Refer to the text	A0

0: Standard mode

1: 3 inertia mode

2: Low response mode

4: Path tracking mode

When other than "3 inertia mode" is selected, vibration suppression control 2 cannot be used.

Before changing the control mode in "3 inertia mode" or "low response mode", stop the motor.

Before changing the control mode in "path tracking mode", stop the motor.

[Pr. PA24.5_Load to motor inertia ratio/load to motor mass ratio estimation higher precision selection]

Initial value	Setting range	Ver.
0h	Refer to the text	C4

Select whether to enable or disable estimation with higher precision for the load to motor inertia ratio/load to motor mass ratio.

0: Disabled

1: Enabled

When this servo parameter is set to "0" (disabled), [Pr. PB06 Load to motor inertia ratio/load to motor mass ratio] may be estimated at a value smaller than the accurate estimation depending on the operation pattern. Therefore, this servo parameter is recommended to be set to "1" (enabled).

Setting this servo parameter to "1" (enabled) with the equipment on which the gain is adjusted may change the actual movement. Check the movement of the equipment after changing the settings.

[Pr. PA25_One-touch tuning - Overshoot permissible level (OTHOV)]

Initial value	Setting range	Ver.
0 [%]	0 to 100	A0

Set a permissible value of overshoot amount for one-touch tuning as a percentage of the in-position range.

When "0" is set, 50 % is applied.

[Pr. PA26_Function selection A-5 (*AOP5)]

Initial value	Setting range	Ver.
00000000h	Refer to the relevant detail No.	Refer to the relevant detail No.

[Pr. PA26.0_Torque limit function selection at instantaneous power failure]

Initial value	Setting range	Ver.
0h	Refer to the text	A0

0: Disabled

1: Enabled

By setting "1", if an instantaneous power failure occurs during operation, limiting the torque at acceleration saves the electric energy charged in the capacitor in the servo amplifier. And consequently the time until [AL. 010.2 Voltage drop in the main circuit power] occurs can be delayed with instantaneous power failure tough drive function. Thus, the time to be set in [Pr. PF25 SEMI-F47 function - Instantaneous power failure detection time (Instantaneous power failure tough drive detection time)] can be extended.

The torque limit function at instantaneous power failure is enabled when [Pr. PA20.2 SEMI-F47 function selection] is "1" (enabled).

[Pr. PA28_Function selection A-6 (**AOP6)]

Initial value	Setting range	Ver.
00000000h	Refer to the relevant detail No.	Refer to the relevant detail No.

[Pr. PA28.4_Speed range limit selection]

Initial value	Setting range	Ver.
0h	Refer to the text	A0

Select the speed to be used for the range restriction of the speed data.

If "1" (permissible speed) is set when the servo amplifier is connected with a servo motor of HK series, the maximum speed will be selected.

0: Maximum speed

1: Permissible speed

[Pr. PA34_Quick tuning - Permissible travel distance (QDIS)]

Initial value	Setting range	Ver.
0 [0.1 rev], [mm]	0 to 100	A0

Set the permissible travel distance for quick tuning.

If the travel distance for quick tuning exceeds the setting value, the quick tuning error occurs.

When "0" is input, the permissible travel distance for quick tuning is 1.0 rev (when a linear servo motor is used, 10 mm).

1.3 Gain/filter setting servo parameters group ([Pr. PB_ _])

[Pr. PB01_Adaptive tuning mode (adaptive filter II) (FILT)]

Initial value	Setting range	Ver.
00000000h	Refer to the relevant detail No.	Refer to the relevant detail No.

[Pr. PB01.0_Filter tuning mode selection]

Initial value	Setting range	Ver.
0h	Refer to the text	A0

Setting of the adaptive tuning is performed.

Select the adjustment mode of the machine resonance suppression filter 1.

0: Disabled

1: Automatic setting

2: Manual setting

When the servo parameter is set to "automatic setting", [Pr. PB13 Machine resonance suppression filter 1] and [Pr. PB14 Notch shape selection 1] will be set automatically. The automatic setting of machine resonance suppression filter 1 cannot be used if quick tuning is in progress. While quick tuning is in progress, adaptive filter II (adaptive tuning) does not start even if the automatic setting of machine resonance suppression filter 1 is used. The results obtained from the quick tuning are applied to [Pr. PB13] and [Pr. PB14].

Do not use the automatic setting in the torque mode.

[Pr. PB01.3_Tuning accuracy selection]

Initial value	Setting range	Ver.
0h	Refer to the text	A0

0: Standard

1: High accuracy

In the high accuracy mode, the sound during tuning may be larger than in the standard mode, but the frequency is estimated more accurately.

[Pr. PB02_Vibration suppression control tuning mode (advanced vibration suppression control II) (VRFT)]

Initial value	Setting range	Ver.
00000000h	Refer to the relevant detail No.	Refer to the relevant detail No.

[Pr. PB02.0_Vibration suppression control 1 - Tuning mode selection]

Initial value	Setting range	Ver.
0h	Refer to the text	A0

Select the tuning mode of the vibration suppression control 1.

- 0: Disabled
- 1: Automatic setting
- 2: Manual setting

[Pr. PB02.1_Vibration suppression control 2 - Tuning mode selection]

Initial value	Setting range	Ver.
0h	Refer to the text	A0

Select the tuning mode of the vibration suppression control 2. To enable the setting value, set [Pr. PA24.0 Vibration suppression mode selection] to "1" (3 inertia mode).

- 0: Disabled
- 1: Automatic setting
- 2: Manual setting

[Pr. PB03_Position command speed adjustment time constant (position smoothing) (PST)]

Initial value	Setting range	Ver.
0 [ms]	0 to 65535	A0

Set the constant of a primary delay filter for the position command in the position control mode.

The control method can be selected from "0" (primary delay) or "1" (linear acceleration/deceleration) in [Pr. PB25.1 Position acceleration/deceleration filter method selection]. When [Pr. PB25.1] is set to "1", the setting value of this servo parameter can be set within the range of "0 to 10". Even if this servo parameter is set to a value larger than "10", the acceleration/deceleration time constants of the position command will remain "10".

When the linear acceleration/deceleration is selected, do not change [Pr. PA01.0 Control mode selection] to any setting other than "0" (position control mode (P)). Doing so will cause the servo motor to make a sudden stop at the time of position control mode switching.

Ex.

When a command is given from a synchronous encoder, a synchronous operation will start smoothly even during line operation.

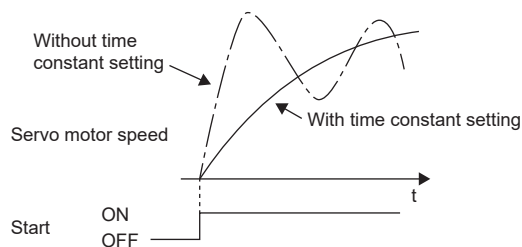
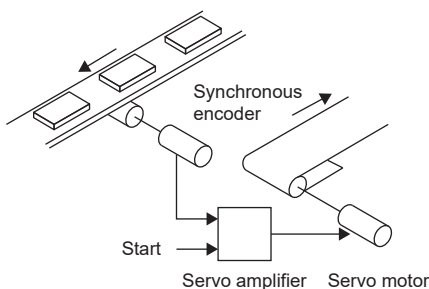

[Pr. PB04_Feed forward gain (FFC)]

Initial value	Setting range	Ver.
0 [%]	0 to 100	A0

Set the feed forward gain.

When "100" is set, the droop pulses are almost 0 in operation at the constant speed. If the super trace control is enabled, the droop pulses are almost 0 in operation at uniform acceleration/deceleration, as well as at the constant speed. However, if sudden acceleration/deceleration is performed, overshoot becomes large. When the feed forward gain is set to 100 %, set a value not smaller than 1 s for the acceleration time constant until the rated speed is reached.

[Pr. PB06_Load to motor inertia ratio/load to motor mass ratio (GD2)]

Initial value	Setting range	Ver.
7.00 [Multiplier]	0.00 to 300.00	A0

Set the load to motor inertia ratio or load to motor mass ratio. Setting a value different from the actual load moment of inertia or load mass may cause an unexpected operation such as an overshoot.

The setting of this servo parameter will be automatic or manual depending on the setting value of [Pr. PA08.0 Gain adjustment mode selection]. Refer to the following table for details. When the servo parameter is set to automatic setting, the value varies within the range of 0.00 to 100.00.

[Pr. PA08.0]	Servo parameter status
"0" (2 gain adjustment mode 1 (interpolation mode))	Automatic setting
"1" (auto tuning mode 1)	
"2" (auto tuning mode 2)	Manual setting
"3" (manual mode)	
"4" (2 gain adjustment mode 2)	
"5" (quick tuning mode)	Automatic setting
"6" (load to motor inertia ratio monitor mode)	

[Pr. PB07_Model control gain (PG1)]

Initial value	Setting range	Ver.
15.0 [rad/s]	1.0 to 8000.0	A0

Set the response gain to the target position.

Increasing the setting value improves responsiveness to the position command, but increasing the value too much raises the likelihood of vibration and noise.

The setting of this servo parameter will be automatic or manual depending on the setting value of [Pr. PA08.0]. Refer to the following table for details.

[Pr. PA08.0]	Servo parameter status
"0" (2 gain adjustment mode 1 (interpolation mode))	Manual setting
"1" (auto tuning mode 1)	Automatic setting
"2" (auto tuning mode 2)	
"3" (manual mode)	Manual setting
"4" (2 gain adjustment mode 2)	Automatic setting
"5" (quick tuning mode)	
"6" (load to motor inertia ratio monitor mode)	Manual setting

When the vibration suppression control is enabled, the settable range of [Pr. PB07 Model control gain] is limited. If [Pr. PB07] exceeds the settable range, the vibration suppression control is disabled.

[Pr. PB08_Position control gain (PG2)]

Initial value	Setting range	Ver.
37.0 [rad/s]	1.0 to 2000.0	A0

Set the gain of the position loop.

Set this servo parameter when increasing the position responsiveness to level load disturbance.

Increasing the setting value improves responsiveness to the load disturbance, but increasing the value too much raises the likelihood of vibration and noise.

The setting of this servo parameter will be automatic or manual depending on the setting value of [Pr. PA08.0 Gain adjustment mode selection]. Refer to the following table for details.

[Pr. PA08.0]	Servo parameter status
"0" (2 gain adjustment mode 1 (interpolation mode))	Automatic setting
"1" (auto tuning mode 1)	
"2" (auto tuning mode 2)	
"3" (manual mode)	Manual setting
"4" (2 gain adjustment mode 2)	Automatic setting
"5" (quick tuning mode)	
"6" (load to motor inertia ratio monitor mode)	Manual setting

[Pr. PB09_Speed control gain (VG2)]

Initial value	Setting range	Ver.
823 [rad/s]	20 to 65535	A0

Set the gain of the speed loop.

Set this servo parameter when vibration occurs on machines with low rigidity or with large backlash. Increasing the setting value improves responsiveness, but increasing the value too much raises the likelihood of vibration and noise.

The setting of this servo parameter will be automatic or manual depending on the setting value of [Pr. PA08.0 Gain adjustment mode selection]. Refer to the following for details.

 Page 37 [Pr. PB08_Position control gain (PG2)]

[Pr. PB10_Speed integral compensation (VIC)]

Initial value	Setting range	Ver.
33.7 [ms]	0.1 to 1000.0	A0

Set the integral time constant of the speed loop.

Decreasing the setting value improves responsiveness, but raises the likelihood of vibration and noise.

The setting of this servo parameter will be automatic or manual depending on the setting value of [Pr. PA08.0 Gain adjustment mode selection]. Refer to the following for details.

☞ Page 37 [Pr. PB08_Position control gain (PG2)]

[Pr. PB11_Speed differential compensation (VDC)]

Initial value	Setting range	Ver.
980	0 to 1000	A0

Set the differential compensation.

[Pr. PB12_Overshoot amount compensation (OVA)]

Initial value	Setting range	Ver.
0 [%]	0 to 100	A0

Set a dynamic friction torque in percentage to the rated torque at servo motor rated speed. Alternatively, set a percentage of dynamic friction force against the continuous thrust at linear servo motor rated speed.

If the response level is too low or if the torque/thrust is limited, the efficiency of the servo parameter may decrease.

[Pr. PB13_Machine resonance suppression filter 1 (NH1)]

Initial value	Setting range	Ver.
4500 [Hz]	10 to 9000	A0

Set the notch frequency of the machine resonance suppression filter 1.

When [Pr. PA08.0 Gain adjustment mode selection] is set to "5" (quick tuning mode), the setting value of this servo parameter reflects the adjustment result of quick tuning.

When [Pr. PB01.0 Filter tuning mode selection] is set to "1" (automatic setting), the values obtained from adaptive tuning are applied to the setting value of this servo parameter.

When [Pr. PB01.0] is set to "2" (manual setting), set the notch frequency with this servo parameter.

[Pr. PB14_Notch shape selection 1 (NHQ1)]

Initial value	Setting range	Ver.
0000000h	Refer to the relevant detail No.	Refer to the relevant detail No.

[Pr. PB14.1_Notch depth selection 1]

Initial value	Setting range	Ver.
0h	Refer to the text	A0

0: -40 dB

1: -14 dB

2: -8 dB

3: -4 dB

[Pr. PB14.2_Notch width selection 1]

Initial value	Setting range	Ver.
0h	Refer to the text	A0

0: $\alpha = 2$

1: $\alpha = 3$

2: $\alpha = 4$

3: $\alpha = 5$

[Pr. PB15_Machine resonance suppression filter 2 (NH2)]

Initial value	Setting range	Ver.
4500 [Hz]	10 to 9000	A0

Set the notch frequency of the machine resonance suppression filter 2.

When [Pr. PA08.0 Gain adjustment mode selection] is set to "5" (quick tuning mode), the setting value of this servo parameter reflects the adjustment result of quick tuning.

When [Pr. PB16.0 Machine resonance suppression filter 2 selection] is set to "1" (enabled), set the notch frequency with this servo parameter.

[Pr. PB16_Notch shape selection 2 (NHQ2)]

Initial value	Setting range	Ver.
00000000h	Refer to the relevant detail No.	Refer to the relevant detail No.

Set forms of the machine resonance suppression filter 2.

When [Pr. PA08.0 Gain adjustment mode selection] is set to "5" (quick tuning mode), the setting value of this servo parameter reflects the adjustment result of quick tuning.

[Pr. PB16.0_Machine resonance suppression filter 2 selection]

Initial value	Setting range	Ver.
0h	Refer to the text	A0

0: Disabled

1: Enabled

[Pr. PB16.1_Notch depth selection]

Initial value	Setting range	Ver.
0h	Refer to the text	A0

0: -40 dB

1: -14 dB

2: -8 dB

3: -4 dB

[Pr. PB16.2_Notch width selection]

Initial value	Setting range	Ver.
0h	Refer to the text	A0

0: $\alpha = 2$

1: $\alpha = 3$

2: $\alpha = 4$

3: $\alpha = 5$

[Pr. PB17_Shaft resonance suppression filter (NHF)]

Initial value	Setting range	Ver.
00000000h	Refer to the relevant detail No.	Refer to the relevant detail No.

Set the shaft resonance suppression filter.

Use this to suppress a high-frequency machine vibration.

When [Pr. PB23.0 Shaft resonance suppression filter selection] is set to "0" (automatic setting), the value will be calculated automatically from the servo motor used and load to motor inertia ratio. Automatic setting is not carried out when the linear servo motor is used. When "1" (manual setting) is selected, set the shaft resonance suppression filter with this servo parameter.

When [Pr. PB23.0] is set to "2" (disabled), this servo parameter setting is disabled. As a result, the filter performance may be reduced.

When [Pr. PB49.0 Machine resonance suppression filter 4 selection] is set to "1" (enabled), the shaft resonance suppression filter cannot be used.

[Pr. PB17.0-1_Shaft resonance suppression filter setting - Frequency selection]

Initial value	Setting range	Ver.
00h	Refer to the text	A0

Refer to the following table for setting values.

Set the value closest to the required frequency.

Setting value	Frequency [Hz]
00	Disabled
01	Disabled
02	4500
03	3000
04	2250
05	1800
06	1500
07	1285
08	1125
09	1000
0A	900
0B	818
0C	750
0D	692
0E	642
0F	600
10	562
11	529
12	500
13	473
14	450
15	428
16	409
17	391
18	375
19	360
1A	346
1B	333
1C	321
1D	310
1E	300

Setting value	Frequency [Hz]
1F	290
20	Disabled
21	Disabled
22	Disabled
23	Disabled
24	Disabled
25	Disabled
26	Disabled
27	Disabled
28	4500
29	4000
2A	3600
2B	3272
2C	3000
2D	2769
2E	2571
2F	2400
30	2250
31	2117
32	2000
33	1894
34	1800
35	1714
36	1636
37	1565
38	1500
39	1440
3A	1384
3B	1333
3C	1285
3D	1241
3E	1200
3F	1161
40	1125
41	1090
42	1058
43	1028
44	1000
45	972
46	947
47	923
48	900
49	878
4A	857
4B	837
4C	818
4D	800
4E	782
4F	765
50	750
51	734
52	720
53	705

Setting value	Frequency [Hz]
54	692
55	679
56	666
57	654
58	642
59	631
5A	620
5B	610
5C	600
5D	590
5E	580
5F	571
60	562
61	553
62	545
63	537
64	529
65	521
66	514
67	507
68	500
69	493
6A	486
6B	480
6C	473
6D	467
6E	461
6F	455
70	450
71	444
72	439
73	433
74	428
75	423
76	418
77	413
78	409
79	404
7A	400
7B	395
7C	391
7D	387
7E	382
7F	378
80	375
81	371
82	367
83	363
84	360
85	356
86	352
87	349
88	346

Setting value	Frequency [Hz]
89	342
8A	339
8B	336
8C	333
8D	330
8E	327
8F	324
90	321
91	318
92	315
93	313
94	310
95	307
96	305
97	302
98	300
99	297
9A	295
9B	292
9C	290
9D	288
9E	285
9F	283

[Pr. PB17.2_Notch depth selection]

Initial value	Setting range	Ver.
0h	Refer to the text	A0

- 0: -40 dB
- 1: -14 dB
- 2: -8 dB
- 3: -4 dB

[Pr. PB18_Low-pass filter setting (LPF)]

Initial value	Setting range	Ver.
3141 [rad/s]	100 to 36000	A0

Set the low-pass filter.

Refer to the table below for the status of this servo parameter and the setting values of the related servo parameter.

When [Pr. PA08.0 Gain adjustment mode selection] is set to "5" (quick tuning mode), this servo parameter returns to the initial value.

[Pr. PB23.1]	[Pr. PB18]
"0" (initial value)	Automatic setting
"1"	Setting value enabled
"2"	Setting value disabled

[Pr. PB19_Vibration suppression control 1 - Vibration frequency (VRF11)]

Initial value	Setting range	Ver.
100.0 [Hz]	0.1 to 300.0	A0

Set the vibration frequency of vibration suppression control 1 to suppress low-frequency machine vibration.

When "1" (automatic setting) is selected in [Pr. PB02.0 Vibration suppression control 1 - Tuning mode selection], this servo parameter will be set automatically. When "2" (manual setting) is selected, set the vibration frequency with this servo parameter.

If [Pr. PB25.0 Model adaptive control selection] is set to "2" (disabled), the vibration suppression control cannot be used.

The available range of [Pr. PB19 Vibration suppression control 1 - Vibration frequency] depends on the value in [Pr. PB07 Model control gain]. If the setting value of [Pr. PB19] exceeds the available range, the vibration suppression control is disabled.

[Pr. PB20_Vibration suppression control 1 - Resonance frequency (VRF12)]

Initial value	Setting range	Ver.
100.0 [Hz]	0.1 to 300.0	A0

Set the resonance frequency of vibration suppression control 1 to suppress low-frequency machine vibration.

When "1" (automatic setting) is selected in [Pr. PB02.0 Vibration suppression control 1 - Tuning mode selection], this servo parameter will be set automatically. When "2" (manual setting) is selected, set the resonance frequency with this servo parameter.

If [Pr. PB25.0 Model adaptive control selection] is set to "2" (disabled), the vibration suppression control cannot be used.

The available range of [Pr. PB20 Vibration suppression control 1 - Resonance frequency] changes depending on the value in [Pr. PB07 Model control gain]. If the setting value of [Pr. PB19] exceeds the available range, the vibration suppression control is disabled.

[Pr. PB21_Vibration suppression control 1 - Vibration frequency damping (VRF13)]

Initial value	Setting range	Ver.
0.00	0.00 to 0.30	A0

Set the damping of the vibration frequency for vibration suppression control 1 to suppress low-frequency machine vibration.

When "1" (automatic setting) is selected in [Pr. PB02.0 Vibration suppression control 1 - Tuning mode selection], this servo parameter will be set automatically. When "2" (manual setting) is selected, set the damping of the vibration frequency with this servo parameter.

[Pr. PB22_Vibration suppression control 1 - Resonance frequency damping (VRF14)]

Initial value	Setting range	Ver.
0.00	0.00 to 0.30	A0

Set the damping of the resonance frequency for vibration suppression control 1 to suppress low-frequency machine vibration. When "1" (automatic setting) is selected in [Pr. PB02.0 Vibration suppression control 1 - Tuning mode selection], this servo parameter will be set automatically. When "2" (manual setting) is selected, set the damping of the resonance frequency with this servo parameter.

[Pr. PB23_Low-pass filter selection (VFBF)]

Initial value	Setting range	Ver.
00001000h	Refer to the relevant detail No.	Refer to the relevant detail No.

[Pr. PB23.0_Shaft resonance suppression filter selection]

Initial value	Setting range	Ver.
0h	Refer to the text	A0

Select the shaft resonance suppression filter.

- 0: Automatic setting
- 1: Manual setting
- 2: Disabled

When [Pr. PB49.0 Machine resonance suppression filter 4 selection] is set to "1" (enabled), the shaft resonance suppression filter cannot be used.

[Pr. PB23.1_Low-pass filter selection]

Initial value	Setting range	Ver.
0h	Refer to the text	A0

Select the low-pass filter.

- 0: Automatic setting
- 1: Manual setting
- 2: Disabled

When "5" (quick tuning mode) is selected in [Pr. PA08.0 Gain adjustment mode selection], this servo parameter is set to "1" (manual setting).

[Pr. PB23.3_Shaft resonance suppression filter 2 selection]

Initial value	Setting range	Ver.
1h	Refer to the text	A0

- 0: Disabled
- 1: Automatic setting

[Pr. PB24_Slight vibration suppression control (*MVS)]

Initial value	Setting range	Ver.
00000000h	Refer to the relevant detail No.	Refer to the relevant detail No.

[Pr. PB24.0_Slight vibration suppression control selection]

Initial value	Setting range	Ver.
0h	Refer to the text	A0

Select the slight vibration suppression control.

0: Disabled

1: Enabled

The slight vibration suppression control is enabled when "3" (manual mode) is selected in [Pr. PA08.0 Gain adjustment mode selection].

The slight vibration suppression control selection can be used in the position mode.

[Pr. PB25_Function selection B-1 (*BOP1)]

Initial value	Setting range	Ver.
00000000h	Refer to the relevant detail No.	Refer to the relevant detail No.

[Pr. PB25.0_Model adaptive control selection]

Initial value	Setting range	Ver.
0h	Refer to the text	A0

0: Enabled (model adaptive control)

2: Disabled (PID control)

When "Disabled" is set, vibration suppression control 1 and 2 cannot be used. The overshoot compensation will be disabled.

[Pr. PB25.1_Position acceleration/deceleration filter method selection]

Initial value	Setting range	Ver.
0h	Refer to the text	A0

Select the position acceleration/deceleration filter method.

0: Primary delay

1: Linear acceleration/deceleration

When "linear acceleration/deceleration" is selected, do not switch the control mode. Doing so will cause the servo motor to make a sudden stop at the time of control mode switching.

[Pr. PB26_Gain switching function (*CDP)]

Initial value	Setting range	Ver.
00000000h	Refer to the relevant detail No.	Refer to the relevant detail No.

Select the gain switching condition.

Set conditions to enable the gain switching values set in [Pr. PB29] to [Pr. PB36] and [Pr. PB56] to [Pr. PB60] and the gain switching 2 values set in [Pr. PB67] to [Pr. PB79].

[Pr. PB26.0_Gain switching selection]

Initial value	Setting range	Ver.
0h	Refer to the text	A0

- 0: Disabled
- 1: Signal (CDP)
- 2: Command frequency
- 3: Droop pulses
- 4: Servo motor speed
- 5: Command direction

When "1" is selected, the gain changes to "Gain after gain switching" by using the input device CDP (Gain switching).

[Pr. PB26.1_Gain switching condition selection]

Initial value	Setting range	Ver.
0h	Refer to the text	A0

- 0: Gain after "Gain switching" is enabled with the value of the gain switching condition or more
- 1: Gain after "Gain switching" is enabled with the value of the gain switching condition or less

[Pr. PB26.2_Gain switching time constant - Disabling condition selection]

Initial value	Setting range	Ver.
0h	Refer to the text	A0

- 0: Switching time constant enabled
- 1: Time constant disabled at switching
- 2: Time constant disabled at return

[Pr. PB26.4_Gain switching 2 selection]

Initial value	Setting range	Ver.
0h	Refer to the text	A0

- 0: Disabled
 - 1: Signal (CDP2)
 - 2: The same condition as [Pr. PB26.0 Gain switching selection]
- When "1" is selected, the gain changes to "Gain after gain switching 2" by using the input device CDP2 (Gain switching 2).
 When "1" is set in [Pr. PB26.0] while "2" has been selected for this servo parameter, the gain changes to "Gain after gain switching 2" by the input device CDP2 (Gain switching 2).

[Pr. PB26.5_Gain switching selection during a stop]

Initial value	Setting range	Ver.
0h	Refer to the text	A0

- 0: Gain switching 2 during a stop is disabled
 - 1: Gain switching 2 during a stop is enabled
- This servo parameter is enabled in the following condition: [Pr. PB26.4 Gain switching 2 selection] is set to "2" (the same condition as [Pr. PB26.0 Gain switching selection]) and [Pr. PB26.0] is set to "5" (command direction) in the position mode.

[Pr. PB27_Gain switching condition (CDL)]

Initial value	Setting range	Ver.
10 [Refer to the text below for the unit.]	0 to 16777215	A0

Set the value of the gain switching (command frequency, droop pulses, or servo motor speed) selected in [Pr. PB26]. The set value unit differs depending on the switching condition item. The units are as follows: [kpulse/s] for command frequency, [pulse] for droop pulses, and [r/min] for servo motor speed.
If using a linear servo motor, the unit of the servo motor speed is mm/s.

[Pr. PB28_Gain switching time constant (CDT)]

Initial value	Setting range	Ver.
1 [ms]	0 to 100	A0

Set the time constant until the gain switches in response to the conditions set in [Pr. PB26] and [Pr. PB27].

[Pr. PB29_Gain switching - Load to motor inertia ratio/load to motor mass ratio (GD2B)]

Initial value	Setting range	Ver.
7.00 [Multiplier]	0.00 to 300.00	A0

Set the load to motor inertia ratio/load to motor mass ratio for when gain switching is enabled. The setting value of this servo parameter is enabled when [Pr. PA08.0 Gain adjustment mode selection] is set to "3" (manual mode).

[Pr. PB30_Gain switching - Position control gain (PG2B)]

Initial value	Setting range	Ver.
0.0 [rad/s]	0.0 to 2000.0	A0

Set the position control gain for when the gain switching is enabled. When the setting value of this servo parameter is less than "1.0", the setting value of [Pr. PB08 Position control gain] is applied. The setting value of this servo parameter is enabled when [Pr. PA08.0 Gain adjustment mode selection] is set to "3" (manual mode).

[Pr. PB31_Gain switching - Speed control gain (VG2B)]

Initial value	Setting range	Ver.
0 [rad/s]	0 to 65535	A0

Set the speed control gain for when the gain switching is enabled. When the setting value of this servo parameter is less than "20", the setting value of [Pr. PB09 Speed control gain] is applied. The setting value of this servo parameter is enabled when [Pr. PA08.0 Gain adjustment mode selection] is set to "3" (manual mode).

[Pr. PB32_Gain switching - Speed integral compensation (VICB)]

Initial value	Setting range	Ver.
0.0 [ms]	0.0 to 5000.0	A0

Set the speed integral compensation for when the gain switching is enabled. When the setting value of this servo parameter is less than "0.1", the setting value of [Pr. PB10 Speed integral compensation] is applied. The setting value of this servo parameter is enabled when [Pr. PA08.0 Gain adjustment mode selection] is set to "3" (manual mode).

[Pr. PB33_Gain switching - Vibration suppression control 1 - Vibration frequency (VRF11B)]

Initial value	Setting range	Ver.
0.0 [Hz]	0.0 to 300.0	A0

Set the vibration frequency of vibration suppression control 1 for when the gain switching is enabled.

When the setting value of this servo parameter is less than "0.1", the setting value of [Pr. PB19 Vibration suppression control 1 - Vibration frequency] is applied.

This servo parameter is enabled in the following conditions:

- [Pr. PA08.0 Gain adjustment mode selection] is set to "3" (manual mode).
- [Pr. PB02.0 Vibration suppression control 1 - Tuning mode selection] is set to "2" (manual setting).
- "1" (signal (CDP)) is selected in [Pr. PB26.0 Gain switching selection].

Switching gains during driving may cause a shock. Switch the gains after the servo motor has stopped.

[Pr. PB34_Gain switching - Vibration suppression control 1 - Resonance frequency (VRF12B)]

Initial value	Setting range	Ver.
0.0 [Hz]	0.0 to 300.0	A0

Set the resonance frequency for vibration suppression control 1 for when the gain switching is enabled.

When the setting value of this servo parameter is less than "0.1", the setting value of [Pr. PB20 Vibration suppression control 1 - Resonance frequency] is applied.

This servo parameter is enabled in the following conditions:

- [Pr. PA08.0 Gain adjustment mode selection] is set to "3" (manual mode).
- [Pr. PB02.0 Vibration suppression control 1 - Tuning mode selection] is set to "2" (manual setting).
- "1" (signal (CDP)) is selected in [Pr. PB26.0 Gain switching selection].

Switching gains during driving may cause a shock. Switch the gains after the servo motor has stopped.

[Pr. PB35_Gain switching - Vibration suppression control 1 - Vibration frequency damping (VRF13B)]

Initial value	Setting range	Ver.
0.00	0.00 to 0.30	A0

Set the damping of the vibration frequency for vibration suppression control 1 for when the gain switching is enabled.

This servo parameter is enabled in the following conditions:

- [Pr. PA08.0 Gain adjustment mode selection] is set to "3" (manual mode).
- [Pr. PB02.0 Vibration suppression control 1 - Tuning mode selection] is set to "2" (manual setting).
- "1" (signal (CDP)) is selected in [Pr. PB26.0 Gain switching selection].

Switching gains during driving may cause a shock. Switch the gains after the servo motor has stopped.

[Pr. PB36_Gain switching - Vibration suppression control 1 - Resonance frequency damping (VRF14B)]

Initial value	Setting range	Ver.
0.00	0.00 to 0.30	A0

Set the damping of the resonance frequency for vibration suppression control 1 for when the gain switching is enabled.

This servo parameter is enabled in the following conditions:

- [Pr. PA08.0 Gain adjustment mode selection] is set to "3" (manual mode).
- [Pr. PB02.0 Vibration suppression control 1 - Tuning mode selection] is set to "2" (manual setting).
- "1" (signal (CDP)) is selected in [Pr. PB26.0 Gain switching selection].

Switching gains during driving may cause a shock. Switch the gains after the servo motor has stopped.

[Pr. PB45_Command notch filter (CNHF)]

Initial value	Setting range	Ver.
00000000h	Refer to the relevant detail No.	Refer to the relevant detail No.

Set the command notch filter.

[Pr. PB45.0-1_Command notch filter setting frequency selection]

Initial value	Setting range	Ver.
00h	Refer to the text	A0

Refer to the following table for the relation of setting values to frequencies.

Setting value	Frequency [Hz]
00	Disabled
01	2000
02	1000
03	666
04	500
06	400
07	333
08	285
09	250
0A	222
0B	200
0C	181
0D	166
0F	153
10	142
11	133
12	125
13	117
14	111
15	105
16	100
17	95
19	90
1A	86
1B	83
1C	80
1D	76
1E	74
1F	71
21	66
22	62
23	58
24	55
25	52
26	50
27	47
29	45
2A	43
2B	41
2C	40
2D	38

Setting value	Frequency [Hz]
2E	37
2F	35
30	34.5
31	33.3
32	31.3
33	29.4
34	27.8
35	26.3
36	25.0
38	23.8
39	22.7
3A	21.7
3B	20.8
3C	20.0
3D	19.2
3E	18.5
3F	17.9
40	17.2
41	16.7
42	15.6
43	14.7
44	13.9
45	13.2
46	12.5
48	11.9
49	11.4
4A	10.9
4B	10.4
4C	10
4D	9.6
4E	9.3
4F	8.9
50	8.6
51	8.3
52	7.8
53	7.4
54	6.9
55	6.6
56	6.3
58	6.0
59	5.7
5A	5.4
5B	5.2
5C	5.0
5D	4.8
5E	4.6
5F	4.5
60	4.31
61	4.17
62	3.91
63	3.68
64	3.47
65	3.29

Setting value	Frequency [Hz]
66	3.13
68	2.98
69	2.84
6A	2.72
6B	2.60
6C	2.50
6D	2.40
6E	2.31
6F	2.23
71	2.08
72	1.95
73	1.84
74	1.74
75	1.64
76	1.56
78	1.49
79	1.42
7A	1.36
7B	1.30
7C	1.25
7D	1.20
7E	1.16
7F	1.12

[Pr. PB45.2_Notch depth selection]

Initial value	Setting range	Ver.
0h	Refer to the text	A0

Refer to the following table for details.

Setting value	Depth [dB]
0	-40.0
1	-24.1
2	-18.1
3	-14.5
4	-12.0
5	-10.1
6	-8.5
7	-7.2
8	-6.0
9	-5.0
A	-4.1
B	-3.3
C	-2.5
D	-1.8
E	-1.2
F	-0.6

[Pr. PB46_Machine resonance suppression filter 3 (NH3)]

Initial value	Setting range	Ver.
4500 [Hz]	10 to 9000	A0

Set the notch frequency of the machine resonance suppression filter 3.

When [Pr. PB47.0 Machine resonance suppression filter 3 selection] is set to "1" (enabled), set the notch frequency with this servo parameter.

[Pr. PB47_Notch shape selection 3 (NHQ3)]

Initial value	Setting range	Ver.
0000000h	Refer to the relevant detail No.	Refer to the relevant detail No.

Set forms of the machine resonance suppression filter 3.

[Pr. PB47.0_Machine resonance suppression filter 3 selection]

Initial value	Setting range	Ver.
0h	Refer to the text	A0

0: Disabled

1: Enabled

[Pr. PB47.1_Notch depth selection]

Initial value	Setting range	Ver.
0h	Refer to the text	A0

0: -40 dB

1: -14 dB

2: -8 dB

3: -4 dB

[Pr. PB47.2_Notch width selection]

Initial value	Setting range	Ver.
0h	Refer to the text	A0

0: $\alpha = 2$

1: $\alpha = 3$

2: $\alpha = 4$

3: $\alpha = 5$

[Pr. PB48_Machine resonance suppression filter 4 (NH4)]

Initial value	Setting range	Ver.
4500 [Hz]	10 to 9000	A0

Set the notch frequency of the machine resonance suppression filter 4.

When [Pr. PB49.0 Machine resonance suppression filter 4 selection] is set to "1" (enabled), set the notch frequency with this servo parameter.

[Pr. PB49_Notch shape selection 4 (NHQ4)]

Initial value	Setting range	Ver.
0000000h	Refer to the relevant detail No.	Refer to the relevant detail No.

Set forms of the machine resonance suppression filter 4.

[Pr. PB49.0_Machine resonance suppression filter 4 selection]

Initial value	Setting range	Ver.
0h	Refer to the text	A0

0: Disabled

1: Enabled

When this setting value is "Enabled", [Pr. PB17 Shaft resonance suppression filter] cannot be used.

[Pr. PB49.1_Notch depth selection]

Initial value	Setting range	Ver.
0h	Refer to the text	A0

0: -40 dB

1: -14 dB

2: -8 dB

3: -4 dB

[Pr. PB49.2_Notch width selection]

Initial value	Setting range	Ver.
0h	Refer to the text	A0

0: $\alpha = 2$

1: $\alpha = 3$

2: $\alpha = 4$

3: $\alpha = 5$

[Pr. PB50_Machine resonance suppression filter 5 (NH5)]

Initial value	Setting range	Ver.
4500 [Hz]	10 to 9000	A0

Set the notch frequency of the machine resonance suppression filter 5.

When [Pr. PB51.0 Machine resonance suppression filter 5 selection] is set to "1" (enabled), set the notch frequency with this servo parameter.

[Pr. PB51_Notch shape selection 5 (NHQ5)]

Initial value	Setting range	Ver.
0000000h	Refer to the relevant detail No.	Refer to the relevant detail No.

Set forms of the machine resonance suppression filter 5.

When [Pr. PA08.0 Gain adjustment mode selection] is set to "5" (quick tuning mode), the setting value of this servo parameter reflects the adjustment result of quick tuning.

When [Pr. PE41.0 Robust filter selection] is set to "1" (enabled), machine resonance suppression filter 5 cannot be used.

[Pr. PB51.0_Machine resonance suppression filter 5 selection]

Initial value	Setting range	Ver.
0h	Refer to the text	A0

0: Disabled

1: Enabled

[Pr. PB51.1_Notch depth selection]

Initial value	Setting range	Ver.
0h	Refer to the text	A0

0: -40 dB

1: -14 dB

2: -8 dB

3: -4 dB

[Pr. PB51.2_Notch width selection]

Initial value	Setting range	Ver.
0h	Refer to the text	A0

0: $\alpha = 2$

1: $\alpha = 3$

2: $\alpha = 4$

3: $\alpha = 5$

[Pr. PB52_Vibration suppression control 2 - Vibration frequency (VRF21)]

Initial value	Setting range	Ver.
100.0 [Hz]	0.1 to 300.0	A0

Set the vibration frequency of vibration suppression control 2 to suppress low-frequency machine vibration.

When "1" (automatic setting) is selected in [Pr. PB02.1 Vibration suppression control 2 - Tuning mode selection], this servo parameter will be set automatically. When "2" (manual setting) is selected, set the vibration frequency with this servo parameter.

The setting value is enabled when [Pr. PA24.0 Vibration suppression mode selection] is set to "1" (3 inertia mode).

The available range of [Pr. PB52 Vibration suppression control 2 - Vibration frequency] depends on the value in [Pr. PB07 Model control gain]. If the setting value of [Pr. PB52] exceeds the available range, the vibration suppression control is disabled.

[Pr. PB53_Vibration suppression control 2 - Resonance frequency (VRF22)]

Initial value	Setting range	Ver.
100.0 [Hz]	0.1 to 300.0	A0

Set the resonance frequency of vibration suppression control 2 to suppress low-frequency machine vibration.

When "1" (automatic setting) is selected in [Pr. PB02.1 Vibration suppression control 2 - Tuning mode selection], this servo parameter will be set automatically. When "2" (manual setting) is selected, set the resonance frequency with this servo parameter.

The setting value is enabled when [Pr. PA24.0 Vibration suppression mode selection] is set to "1" (3 inertia mode).

The available range of [Pr. PB53 Vibration suppression control 2 - Resonance frequency] changes depending on the value in [Pr. PB07 Model control gain]. If the setting value of [Pr. PB53] exceeds the available range, the vibration suppression control is disabled.

[Pr. PB54_Vibration suppression control 2 - Vibration frequency damping (VRF23)]

Initial value	Setting range	Ver.
0.00	0.00 to 0.30	A0

Set the damping of the vibration frequency for vibration suppression control 2 to suppress low-frequency machine vibration.

When "1" (automatic setting) is selected in [Pr. PB02.1 Vibration suppression control 2 - Tuning mode selection], this servo parameter will be set automatically. When "2" (manual setting) is selected, set the damping of the vibration frequency with this servo parameter.

The setting value is enabled when [Pr. PA24.0 Vibration suppression mode selection] is set to "1" (3 inertia mode).

[Pr. PB55_Vibration suppression control 2 - Resonance frequency damping (VRF24)]

Initial value	Setting range	Ver.
0.00	0.00 to 0.30	A0

Set the damping of the resonance frequency for vibration suppression control 2 to suppress low-frequency machine vibration.

When "1" (automatic setting) is selected in [Pr. PB02.1 Vibration suppression control 2 - Tuning mode selection], this servo parameter will be set automatically. When "2" (manual setting) is selected, set the damping of the resonance frequency with this servo parameter.

The setting value is enabled when [Pr. PA24.0 Vibration suppression mode selection] is set to "1" (3 inertia mode).

[Pr. PB56_Gain switching - Vibration suppression control 2 - Vibration frequency (VRF21B)]

Initial value	Setting range	Ver.
0.0 [Hz]	0.0 to 300.0	A0

Set the vibration frequency of vibration suppression control 2 for when the gain switching is enabled.

When the setting value of this servo parameter is less than "0.1", the setting value of [Pr. PB52 Vibration suppression control 2 - Vibration frequency] is applied.

This servo parameter is enabled in the following conditions:

- [Pr. PA08.0 Gain adjustment mode selection] is set to "3" (manual mode).
- [Pr. PA24.0 Vibration suppression mode selection] is set to "1" (3 inertia mode).
- [Pr. PB02.1 Vibration suppression control 2 - Tuning mode selection] is set to "2" (manual setting).
- "1" (signal (CDP)) is selected in [Pr. PB26.0 Gain switching selection].

Switching gains during driving may cause a shock. Switch the gains after the servo motor has stopped.

[Pr. PB57_Gain switching - Vibration suppression control 2 - Resonance frequency (VRF22B)]

Initial value	Setting range	Ver.
0.0 [Hz]	0.0 to 300.0	A0

Set the resonance frequency for vibration suppression control 2 for when the gain switching is enabled.

When the setting value of this servo parameter is less than "0.1", the setting value of [Pr. PB53 Vibration suppression control 2 - Resonance frequency] is applied.

This servo parameter is enabled in the following conditions:

- [Pr. PA08.0 Gain adjustment mode selection] is set to "3" (manual mode).
- [Pr. PA24.0 Vibration suppression mode selection] is set to "1" (3 inertia mode).
- [Pr. PB02.1 Vibration suppression control 2 - Tuning mode selection] is set to "2" (manual setting).
- "1" (signal (CDP)) is selected in [Pr. PB26.0 Gain switching selection].

Switching gains during driving may cause a shock. Switch the gains after the servo motor has stopped.

[Pr. PB58_Gain switching - Vibration suppression control 2 - Vibration frequency damping (VRF23B)]

Initial value	Setting range	Ver.
0.00	0.00 to 0.30	A0

Set the damping of the vibration frequency for vibration suppression control 2 for when the gain switching is enabled.

This servo parameter is enabled in the following conditions:

- [Pr. PA08.0 Gain adjustment mode selection] is set to "3" (manual mode).
- [Pr. PA24.0 Vibration suppression mode selection] is set to "1" (3 inertia mode).
- [Pr. PB02.1 Vibration suppression control 2 - Tuning mode selection] is set to "2" (manual setting).
- "1" (signal (CDP)) is selected in [Pr. PB26.0 Gain switching selection].

Switching gains during driving may cause a shock. Switch the gains after the servo motor has stopped.

[Pr. PB59_Gain switching - Vibration suppression control 2 - Resonance frequency damping (VRF24B)]

Initial value	Setting range	Ver.
0.00	0.00 to 0.30	A0

Set the damping of the resonance frequency for vibration suppression control 2 for when the gain switching is enabled.

This servo parameter is enabled in the following conditions:

- [Pr. PA08.0 Gain adjustment mode selection] is set to "3" (manual mode).
- [Pr. PA24.0 Vibration suppression mode selection] is set to "1" (3 inertia mode).
- [Pr. PB02.1 Vibration suppression control 2 - Tuning mode selection] is set to "2" (manual setting).
- "1" (signal (CDP)) is selected in [Pr. PB26.0 Gain switching selection].

Switching gains during driving may cause a shock. Switch the gains after the servo motor has stopped.

[Pr. PB60_Gain switching - Model control gain (PG1B)]

Initial value	Setting range	Ver.
0.0 [rad/s]	0.0 to 8000.0	A0

Set the model control gain for when the gain switching is enabled.

When the setting value of this servo parameter is less than "1.0", the setting value of [Pr. PB07 Model control gain] is applied.

This servo parameter is enabled in the following conditions:

- [Pr. PA08.0 Gain adjustment mode selection] is set to "3" (manual mode).
- "1" (signal (CDP)) is selected in [Pr. PB26.0 Gain switching selection].

Switching gains during driving may cause a shock. Switch the gains after the servo motor has stopped.

[Pr. PB65_Gain switching 2 condition (CDL2)]

Initial value	Setting range	Ver.
10 [Refer to the text below for the unit.]	0 to 16777215	A0

Set the value of the gain switching (command frequency, droop pulses, or servo motor speed) selected in [Pr. PB26.0 Gain switching selection].

The set value unit differs depending on the switching condition item. The units are as follows: [kpulse/s] for command frequency, [pulse] for droop pulses, and [r/min] for servo motor speed.

If using a linear servo motor, the unit of the servo motor speed is [mm/s].

The setting value is to be larger than in [Pr. PB27 Gain switching condition].

When the setting value of this servo parameter is "0", the gain is not switched to the gain switching 2.

[Pr. PB66_Gain switching 2 time constant (CDT2)]

Initial value	Setting range	Ver.
1 [ms]	0 to 100	A0

Set the time constant until the gain switches from "gain at normal use" or "gain at switching" to "gain at switching 2" in response to the conditions set in [Pr. PB26 Gain switching function] and [Pr. PB65 Gain switching 2 condition].

[Pr. PB67_Gain switching 2 - Load to motor inertia ratio/load to motor mass ratio (GD2C)]

Initial value	Setting range	Ver.
7.00 [Multiplier]	0.00 to 300.00	A0

Set the load to motor inertia ratio/load to motor mass ratio for when the gain switching 2 is enabled.

This servo parameter is enabled when [Pr. PA08.0 Gain adjustment mode selection] is set to "3" (manual mode).

[Pr. PB68_Gain switching 2 - Position control gain (PG2C)]

Initial value	Setting range	Ver.
0.0 [rad/s]	0.0 to 2000.0	A0

Set the position control gain for when the gain switching 2 is enabled.

When the setting value of this servo parameter is less than "1.0", the setting value of [Pr. PB08 Position control gain] is applied.

This servo parameter is enabled when [Pr. PA08.0 Gain adjustment mode selection] is set to "3" (manual mode).

[Pr. PB69_Gain switching 2 - Speed control gain (VG2C)]

Initial value	Setting range	Ver.
0 [rad/s]	0 to 65535	A0

Set the speed control gain for when the gain switching 2 is enabled.

When the setting value of this servo parameter is less than "20", the setting value of [Pr. PB09 Speed control gain] is applied.

This servo parameter is enabled when [Pr. PA08.0 Gain adjustment mode selection] is set to "3" (manual mode).

[Pr. PB70_Gain switching 2 - Speed integral compensation (VICC)]

Initial value	Setting range	Ver.
0.0 [ms]	0.0 to 5000.0	A0

Set the speed integral compensation for when the gain switching 2 is enabled.

When the setting value of this servo parameter is less than "0.1", the setting value of [Pr. PB10 Speed integral compensation] is applied.

This servo parameter is enabled when [Pr. PA08.0 Gain adjustment mode selection] is set to "3" (manual mode).

[Pr. PB71_Gain switching 2 - Vibration suppression control 1 - Vibration frequency (VRF11C)]

Initial value	Setting range	Ver.
0.0 [Hz]	0.0 to 300.0	A0

Set the vibration frequency of vibration suppression control 1 for when the gain switching 2 is enabled.

When the setting value of this servo parameter is less than "0.1", the setting value of [Pr. PB19 Vibration suppression control 1 - Vibration frequency] is applied.

This servo parameter is enabled in the following conditions:

- [Pr. PA08.0 Gain adjustment mode selection] is set to "3" (manual mode).
- [Pr. PB02.0 Vibration suppression control 1 - Tuning mode selection] is set to "2" (manual setting).
- [Pr. PB26.0 Gain switching selection] is set to "1" (signal (CDP)) while [Pr. PB26.4 Gain switching 2 selection] is set to "2" (the same condition as [Pr. PB26.0 Gain switching selection]), or [Pr. PB26.4] is set to "1" (signal (CDP2)).

Switching gains during driving may cause a shock. Switch the gains after the servo motor has stopped.

[Pr. PB72_Gain switching 2 - Vibration suppression control 1 - Resonance frequency (VRF12C)]

Initial value	Setting range	Ver.
0.0 [Hz]	0.0 to 300.0	A0

Set the resonance frequency for vibration suppression control 1 for when the gain switching 2 is enabled.

When the setting value of this servo parameter is less than "0.1", the setting value of [Pr. PB20 Vibration suppression control 1 - Resonance frequency] is applied.

This servo parameter is enabled in the following conditions:

- [Pr. PA08.0 Gain adjustment mode selection] is set to "3" (manual mode).
- [Pr. PB02.0 Vibration suppression control 1 - Tuning mode selection] is set to "2" (manual setting).
- [Pr. PB26.0 Gain switching selection] is set to "1" (signal (CDP)) while [Pr. PB26.4 Gain switching 2 selection] is set to "2" (the same condition as [Pr. PB26.0 Gain switching selection]), or [Pr. PB26.4] is set to "1" (signal (CDP2)).

Switching gains during driving may cause a shock. Switch the gains after the servo motor has stopped.

[Pr. PB73_Gain switching 2 - Vibration suppression control 1 - Vibration frequency damping (VRF13C)]

Initial value	Setting range	Ver.
0.00	0.00 to 0.30	A0

Set the damping of the vibration frequency for vibration suppression control 1 for when the gain switching is enabled.

This servo parameter is enabled in the following conditions:

- [Pr. PA08.0 Gain adjustment mode selection] is set to "3" (manual mode).
- [Pr. PB02.0 Vibration suppression control 1 - Tuning mode selection] is set to "2" (manual setting).
- [Pr. PB26.0 Gain switching selection] is set to "1" (signal (CDP)) while [Pr. PB26.4 Gain switching 2 selection] is set to "2" (the same condition as [Pr. PB26.0 Gain switching selection]), or [Pr. PB26.4] is set to "1" (signal (CDP2)).

Switching gains during driving may cause a shock. Switch the gains after the servo motor has stopped.

[Pr. PB74_Gain switching 2 - Vibration suppression control 1 - Resonance frequency damping (VRF14C)]

Initial value	Setting range	Ver.
0.00	0.00 to 0.30	A0

Set the damping of the resonance frequency for vibration suppression control 1 for when the gain switching is enabled.

This servo parameter is enabled in the following conditions:

- [Pr. PA08.0 Gain adjustment mode selection] is set to "3" (manual mode).
- [Pr. PB02.0 Vibration suppression control 1 - Tuning mode selection] is set to "2" (manual setting).
- [Pr. PB26.0 Gain switching selection] is set to "1" (signal (CDP)) while [Pr. PB26.4 Gain switching 2 selection] is set to "2" (the same condition as [Pr. PB26.0 Gain switching selection]), or [Pr. PB26.4] is set to "1" (signal (CDP2)).

Switching gains during driving may cause a shock. Switch the gains after the servo motor has stopped.

[Pr. PB75_Gain switching 2 - Vibration suppression control 2 - Vibration frequency (VRF21C)]

Initial value	Setting range	Ver.
0.0 [Hz]	0.0 to 300.0	A0

Set the vibration frequency of vibration suppression control 2 for when the gain switching is enabled.

When the setting value of this servo parameter is less than "0.1", the setting value of [Pr. PB52 Vibration suppression control 2 - Vibration frequency] is applied.

This servo parameter is enabled in the following conditions:

- [Pr. PA08.0 Gain adjustment mode selection] is set to "3" (manual mode).
- [Pr. PA24.0 Vibration suppression mode selection] is set to "1" (3 inertia mode).
- [Pr. PB02.1 Vibration suppression control 2 - Tuning mode selection] is set to "2" (manual setting).
- [Pr. PB26.0 Gain switching selection] is set to "1" (signal (CDP)) while [Pr. PB26.4 Gain switching 2 selection] is set to "2" (the same condition as [Pr. PB26.0 Gain switching selection]), or [Pr. PB26.4] is set to "1" (signal (CDP2)).

Switching gains during driving may cause a shock. Switch the gains after the servo motor has stopped.

[Pr. PB76_Gain switching 2 - Vibration suppression control 2 - Resonance frequency (VRF22C)]

Initial value	Setting range	Ver.
0.0 [Hz]	0.0 to 300.0	A0

Set the resonance frequency for vibration suppression control 2 for when the gain switching is enabled.

When the setting value of this servo parameter is less than "0.1", the setting value of [Pr. PB53 Vibration suppression control 2 - Resonance frequency] is applied.

This servo parameter is enabled in the following conditions:

- [Pr. PA08.0 Gain adjustment mode selection] is set to "3" (manual mode).
- [Pr. PA24.0 Vibration suppression mode selection] is set to "1" (3 inertia mode).
- [Pr. PB02.1 Vibration suppression control 2 - Tuning mode selection] is set to "2" (manual setting).
- [Pr. PB26.0 Gain switching selection] is set to "1" (signal (CDP)) while [Pr. PB26.4 Gain switching 2 selection] is set to "2" (the same condition as [Pr. PB26.0 Gain switching selection]), or [Pr. PB26.4] is set to "1" (signal (CDP2)).

Switching gains during driving may cause a shock. Switch the gains after the servo motor has stopped.

[Pr. PB77_Gain switching 2 - Vibration suppression control 2 - Vibration frequency damping (VRF23C)]

Initial value	Setting range	Ver.
0.00	0.00 to 0.30	A0

Set the damping of the vibration frequency for vibration suppression control 2 for when the gain switching is enabled.

This servo parameter is enabled in the following conditions:

- [Pr. PA08.0 Gain adjustment mode selection] is set to "3" (manual mode).
- [Pr. PA24.0 Vibration suppression mode selection] is set to "1" (3 inertia mode).
- [Pr. PB02.1 Vibration suppression control 2 - Tuning mode selection] is set to "2" (manual setting).
- [Pr. PB26.0 Gain switching selection] is set to "1" (signal (CDP)) while [Pr. PB26.4 Gain switching 2 selection] is set to "2" (the same condition as [Pr. PB26.0 Gain switching selection]), or [Pr. PB26.4] is set to "1" (signal (CDP2)).

Switching gains during driving may cause a shock. Switch the gains after the servo motor has stopped.

[Pr. PB78_Gain switching 2 - Vibration suppression control 2 - Resonance frequency damping (VRF24C)]

Initial value	Setting range	Ver.
0.00	0.00 to 0.30	A0

Set the damping of the resonance frequency for vibration suppression control 2 for when the gain switching is enabled.

This servo parameter is enabled in the following conditions:

- [Pr. PA08.0 Gain adjustment mode selection] is set to "3" (manual mode).
- [Pr. PA24.0 Vibration suppression mode selection] is set to "1" (3 inertia mode).
- [Pr. PB02.1 Vibration suppression control 2 - Tuning mode selection] is set to "2" (manual setting).
- [Pr. PB26.0 Gain switching selection] is set to "1" (signal (CDP)) while [Pr. PB26.4 Gain switching 2 selection] is set to "2" (the same condition as [Pr. PB26.0 Gain switching selection]), or [Pr. PB26.4] is set to "1" (signal (CDP2)).

Switching gains during driving may cause a shock. Switch the gains after the servo motor has stopped.

[Pr. PB79_Gain switching 2 - Model control gain (PG1C)]

Initial value	Setting range	Ver.
0.0 [rad/s]	0.0 to 8000.0	A0

Set the model control gain for when the gain switching is enabled.

When the setting value of this servo parameter is less than "1.0", the setting value of [Pr. PB07 Model control gain] is applied.

This servo parameter is enabled in the following conditions:

- [Pr. PB26.0 Gain switching selection] is set to "1" (signal (CDP)) while [Pr. PB26.4 Gain switching 2 selection] is set to "2" (the same condition as [Pr. PB26.0 Gain switching selection]), or [Pr. PB26.4] is set to "1" (signal (CDP2)).

[Pr. PB81_Command filter (*CFIL)]

Initial value	Setting range	Ver.
00000001h	Refer to the relevant detail No.	Refer to the relevant detail No.

[Pr. PB81.4_Position command smoothing filter]

Initial value	Setting range	Ver.
0h	Refer to the text	A5

This function can be used only in position mode.

This filter and [Pr. PB45 Command notch filter] are mutually exclusive. "1" (enabled) can be set in this function only when [Pr. PB45.0-1 Command notch filter setting frequency selection] is set to "00" (disabled). When a setting value other than "00" (disabled) is set in [Pr. PB45.0-1], the filter is disabled regardless of the setting value.

0: Disabled

1: Enabled

When "1" (enabled) is selected, set the filter time constant with [Pr. PB82 Position command smoothing filter time constant].

[Pr. PB82_Position command smoothing filter time constant (PFT)]

Initial value	Setting range	Ver.
0.0 [ms]	0.0 to 100.0	A5

Set the position command smoothing filter time constant.

This servo parameter can be used when [Pr. PB81.4 Position command smoothing filter] is set to "1" (enabled).

1.4 Extension setting servo parameters group ([Pr. PC_ _])

[Pr. PC01_Speed acceleration time constant (STA)]

Initial value	Setting range	Ver.
0 [ms]	0 to 50000	A0

In the speed control mode or torque control mode, set the acceleration time required to reach the rated speed from 0 r/min for VC (Analog speed command) and [Pr. PC05 Internal speed 1] to [Pr. PC11 Internal speed 7].

For example for the servo motor of 3000 r/min rated speed, set 3000 (3 s) to increase speed from 0 r/min to 1000 r/min in 1 s.

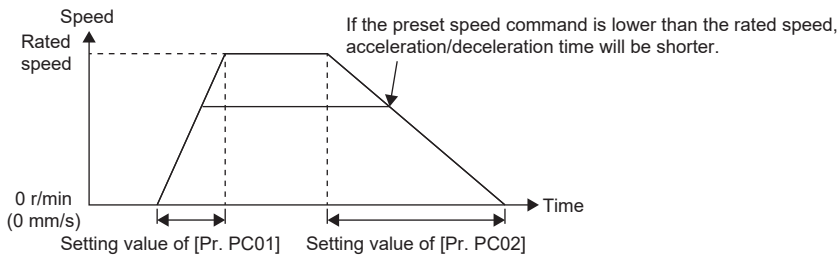

[Pr. PC02_Speed deceleration time constant (STB)]

Initial value	Setting range	Ver.
0 [ms]	0 to 50000	A0

When using the servo amplifier in the speed control mode and torque control mode, set the deceleration time for the servo motor to stop from the rated speed or the rated speed for VC (Analog speed command) and [Pr. PC05 Internal speed 1] to [Pr. PC11 Internal speed 7].

This function is enabled in the speed control mode and torque control mode.

[Pr. PC03_S-pattern acceleration/deceleration time constants (STC)]

Initial value	Setting range	Ver.
0 [ms]	0 to 5000	A0

Set the time of the arc part for S-pattern acceleration/deceleration.

By setting "0", linear acceleration/deceleration is performed.

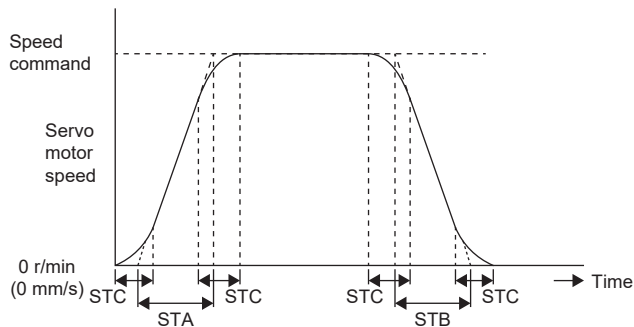

STA: Acceleration time constant ([Pr. PC01])

STB: Deceleration time constant ([Pr. PC02])

STC: S-pattern acceleration/deceleration time constant ([Pr. PC03])

If a large value is set to STA (acceleration time constant) or STB (deceleration time constant), the actual operation time for the arc part may differ from the setting value of the S-pattern acceleration/deceleration time constant.

The upper limit value of the actual time for the arc part is limited by

at acceleration $\frac{2000000}{STA}$ and at deceleration $\frac{2000000}{STB}$.

Ex.

At the setting of STA = 20000, STB = 5000 and STC = 200, the actual time for the arc part is as follows:

During acceleration: 100 ms

$$\frac{2000000}{20000} = 100 \text{ [ms]} < 200 \text{ [ms]}$$

Therefore, the time is limited to 100 [ms].

During deceleration: 200 ms

$$\frac{2000000}{5000} = 400 \text{ [ms]} > 200 \text{ [ms]}$$

Therefore, it will be 200 [ms] as set.

[Pr. PC04_Torque command time constant (TQC)]

Initial value	Setting range	Ver.
0 [ms]	0 to 50000	A0

Set the time constant of a primary delay filter for the torque command (or thrust command).

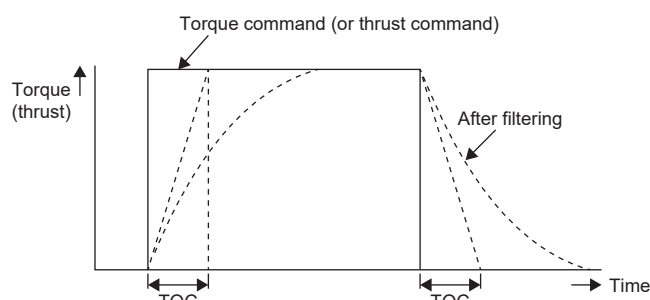

TQC: Torque command time constant

[Pr. PC05_Internal speed 1 (SC1)]

Initial value	Setting range	Ver.
100.00 [r/min], [mm/s]	0.00 to 65535.00	A0

Set a value within the range between 0 and the maximum speed. When changing the speed to the permissible speed, set the speed in [Pr. PA28.4 Speed range limit selection].

- When using the speed control mode, set the speed 1 of internal speed commands.
- When using the torque control mode, set the speed 1 of internal speed limit.

[Pr. PC06_Internal speed 2 (SC2)]

Initial value	Setting range	Ver.
500.00 [r/min], [mm/s]	0.00 to 65535.00	A0

Set a value within the range between 0 and the maximum speed. When changing to the permissible speed, set the speed in [Pr. PA28.4].

- When using the speed control mode, set the speed 2 of internal speed commands.
- When using the torque control mode, set the speed 2 of internal speed limit.

[Pr. PC07_Internal speed 3 (SC3)]

Initial value	Setting range	Ver.
1000.00 [r/min], [mm/s]	0.00 to 65535.00	A0

Set a value within the range between 0 and the maximum speed. When changing to the permissible speed, set the speed in [Pr. PA28.4].

- When using the speed control mode, set the speed 3 of internal speed commands.
- When using the torque control mode, set the speed 3 of internal speed limit.

[Pr. PC08_Internal speed 4 (SC4)]

Initial value	Setting range	Ver.
200.00 [r/min], [mm/s]	0.00 to 65535.00	A0

Set a value within the range between 0 and the maximum speed. When changing to the permissible speed, set the speed in [Pr. PA28.4].

- When using the speed control mode, set the speed 4 of internal speed commands.
- When using the torque control mode, set the speed 4 of internal speed limit.

[Pr. PC09_Internal speed 5 (SC5)]

Initial value	Setting range	Ver.
300.00 [r/min], [mm/s]	0.00 to 65535.00	A0

Set a value within the range between 0 and the maximum speed. When changing to the permissible speed, set the speed in [Pr. PA28.4].

- When using the speed control mode, set the speed 5 of internal speed commands.
- When using the torque control mode, set the speed 5 of internal speed limit.

[Pr. PC10_Internal speed 6 (SC6)]

Initial value	Setting range	Ver.
500.00 [r/min], [mm/s]	0.00 to 65535.00	A0

Set a value within the range between 0 and the maximum speed. When changing to the permissible speed, set the speed in [Pr. PA28.4].

- When using the speed control mode, set the speed 6 of internal speed commands.
- When using the torque control mode, set the speed 6 of internal speed limit.

[Pr. PC11_Internal speed 7 (SC7)]

Initial value	Setting range	Ver.
800.00 [r/min], [mm/s]	0.00 to 65535.00	A0

Set a value within the range between 0 and the maximum speed. When changing to the permissible speed, set the speed in [Pr. PA28.4].

- When using the speed control mode, set the speed 7 of internal speed commands.
- When using the torque control mode, set the speed 7 of internal speed limit.

[Pr. PC12_Analog speed command - Maximum speed (VCM)]

Initial value	Setting range	Ver.
0 [r/min], [mm/s]	0 to 50000	A0

If a command exceeding the maximum speed is input, the command will be clamped at the maximum speed. When changing to the permissible speed, set the speed in [Pr. PA28.4].

When "0" is set, the rated speed of the connected servo motor is set internally.

- When using the speed control mode, set the servo motor speed for when the input voltage of the analog speed command (VC) is 10 [V].
- When using the torque control mode, set the servo motor speed for when the input voltage of the analog speed limit (VLA) is 10 [V].

[Pr. PC13_Analog torque command maximum output (TLC)]

Initial value	Setting range	Ver.
100.0 [%]	0.0 to 1000.0	A0

Set the output torque/output thrust when the analog torque/thrust command voltage (TC = ±8 V) is +8 V in relation to the maximum torque or maximum thrust (= 100.0 %).

For example, by setting 50.0, maximum torque/thrust × (50.0/100.0) is output.

When a command value equal to or larger than the maximum torque/thrust is input to TC, the value is clamped at the maximum torque/thrust.

When [Pr. PC50.1 Analog torque command unit change] is set to "1" (rated torque unit), set the servo parameter in relation to the rated torque/thrust (=100.0 [%]).

[Pr. PC14_Analog monitor 1 output (MOD1)]

Initial value	Setting range	Ver.
00000000h	Refer to the relevant detail No.	Refer to the relevant detail No.

[Pr. PC14.0-1_Analog monitor 1 output selection]

Initial value	Setting range	Ver.
00h	Refer to the text	A0

Select the signal to be output to analog monitor 1.

- For amplifiers of 100 W to 22 kW

Setting value	Explanation	Semi closed loop system ^{*1}			Fully closed loop system ^{*1}	
		Rotary	Linear	DD	Rotary	DD
00	(Linear) servo motor speed (± 8 V/max. speed)	<input type="radio"/>	<input type="radio"/>	<input type="radio"/>	<input type="radio"/>	<input type="radio"/>
01	Torque or thrust (± 8 V/max. torque or max. thrust) ^{*3}	<input type="radio"/>	<input type="radio"/>	<input type="radio"/>	<input type="radio"/>	<input type="radio"/>
02	(Linear) servo motor speed (+8 V/max. speed)	<input type="radio"/>	<input type="radio"/>	<input type="radio"/>	<input type="radio"/>	<input type="radio"/>
03	Torque or thrust (+8 V/max. torque or max. thrust) ^{*3}	<input type="radio"/>	<input type="radio"/>	<input type="radio"/>	<input type="radio"/>	<input type="radio"/>
04	Current command (± 8 V/max. current command)	<input type="radio"/>	<input type="radio"/>	<input type="radio"/>	<input type="radio"/>	<input type="radio"/>
05	Command pulse frequency (± 10 V/ ± 4 Mpulses/s)	<input type="radio"/>	<input type="radio"/>	<input type="radio"/>	<input type="radio"/>	<input type="radio"/>
06	Servo motor-side droop pulses (± 10 V/100 pulses [control encoder unit]) ^{*2}	<input type="radio"/>	<input type="radio"/>	<input type="radio"/>	<input type="radio"/>	<input type="radio"/>
07	Servo motor-side droop pulses (± 10 V/1000 pulses [control encoder unit]) ^{*2}	<input type="radio"/>	<input type="radio"/>	<input type="radio"/>	<input type="radio"/>	<input type="radio"/>
08	Servo motor-side droop pulses (± 10 V/10000 pulses [control encoder unit]) ^{*2}	<input type="radio"/>	<input type="radio"/>	<input type="radio"/>	<input type="radio"/>	<input type="radio"/>
09	Servo motor-side droop pulses (± 10 V/100000 pulses [control encoder unit]) ^{*2}	<input type="radio"/>	<input type="radio"/>	<input type="radio"/>	<input type="radio"/>	<input type="radio"/>
0D	Bus voltage (200 V class: +8 V/400 V, 400 V class: +8 V/800 V)	<input type="radio"/>	<input type="radio"/>	<input type="radio"/>	<input type="radio"/>	<input type="radio"/>
0E	Speed command 2 (± 8 V/max. speed)	<input type="radio"/>	<input type="radio"/>	<input type="radio"/>	<input type="radio"/>	<input type="radio"/>
10 ^{*4}	Load-side droop pulses (± 10 V/100 pulses [control encoder unit]) ^{*2}	—	—	—	<input type="radio"/>	<input type="radio"/>
11 ^{*4}	Load-side droop pulses (± 10 V/1000 pulses [control encoder unit]) ^{*2}	—	—	—	<input type="radio"/>	<input type="radio"/>
12 ^{*4}	Load-side droop pulses (± 10 V/10000 pulses [control encoder unit]) ^{*2}	—	—	—	<input type="radio"/>	<input type="radio"/>
13 ^{*4}	Load-side droop pulses (± 10 V/100000 pulses [control encoder unit]) ^{*2}	—	—	—	<input type="radio"/>	<input type="radio"/>
14 ^{*4}	Load-side droop pulses (± 10 V/1 Mpulses [control encoder unit]) ^{*2}	—	—	—	<input type="radio"/>	<input type="radio"/>
15 ^{*4}	Motor/load side position deviation (± 10 V/100000 pulses [control encoder unit])	—	—	—	<input type="radio"/>	<input type="radio"/>
16 ^{*4}	Motor-side/load-side speed deviation (± 8 V/max. speed)	—	—	—	<input type="radio"/>	<input type="radio"/>
17	Internal temperature of encoder (± 10 V/ ± 128 °C)	<input type="radio"/>	—	<input type="radio"/>	<input type="radio"/>	<input type="radio"/>
18	Servo motor-side droop pulses (± 10 V/1 Mpulses) ^{*2}	<input type="radio"/>	<input type="radio"/>	<input type="radio"/>	<input type="radio"/>	<input type="radio"/>

*1 Items with are available for each operation mode.

Rotary: When rotary servo motors are used.

Linear: When linear servo motors are used.

DD: When direct drive motors are used.

*2 This is in the units of encoder pulses.

*3 The maximum torque or maximum thrust is enabled by the setting of [Pr. PA11 Forward rotation torque limit] or [Pr. PA12 Reverse rotation torque limit], whichever is larger.

*4 Available on servo amplifiers with firmware version A5 or later.

[Pr. PC15_Analog monitor 2 output (MOD2)]

Initial value	Setting range	Ver.
00000001h	Refer to the relevant detail No.	Refer to the relevant detail No.

[Pr. PC15.0-1_Analog monitor 2 output selection]

Initial value	Setting range	Ver.
01h	Refer to the text	A0

Select the signal to be output to analog monitor 2.

Refer to the following for setting values.

☞ Page 68 [Pr. PC14_Analog monitor 1 output (MOD1)]

[Pr. PC16_Electromagnetic brake sequence output (MBR)]

Initial value	Setting range	Ver.
0 [ms]	0 to 1000	A0

Set the delay time used between the MBR (Electromagnetic brake interlock) shut-off and the base circuit shut-off.

[Pr. PC17_Zero speed (ZSP)]

Initial value	Setting range	Ver.
50 [r/min], [mm/s]	0 to 10000	A0

Set an output range of the zero speed signal (ZSP).

The zero speed signal detection has a hysteresis of 20 [r/min] (20 [mm/s]).

[Pr. PC18_Alarm history clear (*BPS)]

Initial value	Setting range	Ver.
00000000h	Refer to the relevant detail No.	Refer to the relevant detail No.

[Pr. PC18.0_Alarm clear history selection]

Initial value	Setting range	Ver.
0h	Refer to the text	A0

0: Disabled

1: Enabled

When "1" (enabled) is set, the alarm history will be cleared at the next power-on or software reset. After the alarm history is cleared, "0" (disabled) will be set to this servo parameter automatically.

[Pr. PC19_ Encoder output pulses selection (*ENRS)]









Initial value	Setting range	Ver.
00000000h	Refer to the relevant detail No.	Refer to the relevant detail No.

[Pr. PC19.0_ Encoder output pulse - Phase selection]

Initial value	Setting range	Ver.
0h	Refer to the text	A0

0: Increasing A-phase 90° in CCW or positive direction

1: Increasing A-phase 90° in CW or negative direction

Setting value	Servo motor rotation direction/linear servo motor travel direction	
	CCW or positive direction	CW or negative direction
0	A-phase  B-phase 	A-phase  B-phase 
1	A-phase  B-phase 	A-phase  B-phase 

[Pr. PC19.1_Encoder output pulse setting selection]

Initial value	Setting range	Ver.
0h	Refer to the text	A0

Select the encoder output pulse setting.

When an encoder other than an A/B/Z-phase differential output type encoder is connected, setting this servo parameter to "4" causes [AL. 037 Parameter error] to occur.

0: Output pulse setting

1: Dividing ratio setting

2: The same output pulse setting as the command pulse

3: A-phase/B-phase pulse electronic gear setting

4: A/B-phase pulse through output setting

■ Settings of [Pr. PC19.1] and [Pr. PC19.2]

- When [Pr. PC19.2] = "0" (servo motor-side encoder)

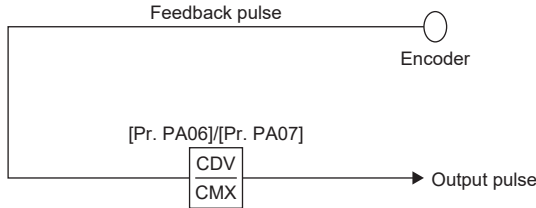
Setting value of [Pr. PC19.1]	For rotary servo motors and direct drive motors	For linear servo motors
"0" (output pulse setting)	Set the output pulses per revolution with [Pr. PA15 Encoder output pulses]. If [Pr. PC03.2] is set to "1" (load-side encoder), [AL. 037] will occur. Output pulse = Setting value of [Pr. PA15] [pulse/rev]	The output pulse setting cannot be used. When "0" is set, the condition is the same as when "1" is set.
"1" (dividing ratio setting)	Set the dividing ratio relative to the resolution per servo motor revolution with [Pr. PA15]. $\text{Output pulse} = \frac{\text{Resolution per revolution}}{\text{Setting value of [Pr. PA15]}} \text{ [pulse/rev]}$	Set the dividing ratio relative to the travel distance of the linear servo motor with [Pr. PA15]. $\text{Output pulse} = \frac{\text{Travel distance of linear servo motor}}{\text{Setting value of [Pr. PA15]}} \text{ [pulse]}$
"2" (the same output pulse setting as the command pulse)	Feedback pulses from the encoder are processed and output as follows. Feedback pulses are output in the same pulse unit as the command pulse. 	
	The settings of [Pr. PA15] and [Pr. PA16 Encoder output pulses 2] are not used.	
"3" (A-phase/B-phase pulse electronic gear setting)	Set the A-phase/B-phase pulse electronic gear with [Pr. PA15] and [Pr. PA16 Encoder output pulses 2]. $\text{Output pulse} = \frac{\text{Resolution per revolution} \times \text{Setting value of [Pr. PA15]}}{\text{Setting value of [Pr. PA16]}} \text{ [pulse/rev]}$	Set the A-phase/B-phase pulse electronic gear with [Pr. PA15] and [Pr. PA16 Encoder output pulses 2]. $\text{Output pulse} = \frac{\text{Travel distance of linear servo motor} \times \text{Setting value of [Pr. PA15]}}{\text{Setting value of [Pr. PA16]}} \text{ [pulse]}$
"4" (A/B-phase pulse through output setting) ^{*1}	<ul style="list-style-type: none"> • When a servo amplifier with a firmware version earlier than B2 is being used, [AL. 037] occurs. • A/B-phase pulses are output when an A/B/Z-phase differential output type encoder is used. If a different encoder is connected, [AL. 037] occurs. • The setting value in [Pr. PC19.0 Encoder output pulse - Phase selection] is not applied. • The setting values in [Pr. PA15] and [Pr. PA16] are not applied. Output pulse = A/B-phase pulse of A/B/Z-phase differential output type encoder [pulse]	<ul style="list-style-type: none"> • A/B-phase pulses are output when an A/B/Z-phase differential output type encoder is used. If a different encoder is connected, [AL. 037] occurs. • The setting value in [Pr. PC19.0 Encoder output pulse - Phase selection] is not applied. • The setting values in [Pr. PA15] and [Pr. PA16] are not applied. Output pulse = A/B-phase pulse of A/B/Z-phase differential output type encoder [pulse]

*1 If this value is set when using the rotary servo motor, [AL. 037] occurs.

- When [Pr. PC19.2] = "1" (load-side encoder)

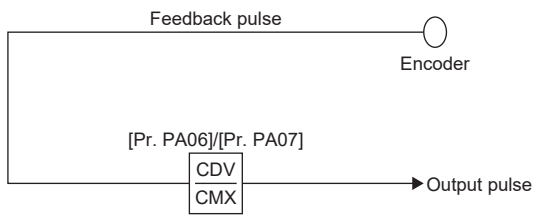
Setting value of [Pr. PC19.1]	When in the fully closed loop control mode
"0" (output pulse setting)	[AL. 037] occurs.
"1" (dividing ratio setting)	Set the dividing ratio to the resolution per servo motor revolution with [Pr. PA15]. Output pulse = $\frac{\text{Resolution per revolution}}{\text{Setting value of [Pr. PA15]}}$ [pulse/rev]
"2" (the same output pulse setting as the command pulse)	Feedback pulses from the encoder are processed and output as follows. Feedback pulses are output in the same pulse unit as the command pulse. 
	The settings of [Pr. PA15] and [Pr. PA16] are not used.
"3" (A-phase/B-phase pulse electronic gear setting)	Set the A-phase/B-phase pulse electronic gear with [Pr. PA15] and [Pr. PA16]. Output pulse = $\text{Resolution per revolution} \times \frac{\text{Setting value of [Pr. PA15]}}{\text{Setting value of [Pr. PA16]}}$ [pulse/rev]
"4" (A/B-phase pulse through output setting)	<ul style="list-style-type: none"> • A/B-phase pulses are output when an A/B/Z-phase differential output type encoder is used. If a different encoder is connected, [AL. 037] occurs. • The setting value in [Pr. PC19.0 Encoder output pulse - Phase selection] is not applied. • The setting values in [Pr. PA15] and [Pr. PA16] are not applied. Output pulse = A/B-phase pulse of A/B/Z-phase differential output type encoder [pulse]

[Pr. PC19.2_ Encoder selection for encoder output pulse]

Initial value	Setting range	Ver.
0h	Refer to the text	A5

Select the encoder that the servo amplifier will use to output encoder output pulses.

If [Pr. PC19.2] is set to "1" while [Pr. PC19.1] is set to "0", [AL. 037 Parameter error] occurs.

This servo parameter can be used only in a fully closed loop system.

If "1" is selected for a system other than a fully closed loop system, [AL. 037 Parameter error] occurs.

0: Servo motor-side encoder

1: Load-side encoder

[Pr. PC20_ Station No. setting (*SNO)]

Initial value	Setting range	Ver.
0 [station]	0 to 31	B6

Set the station No. of RS-422 communication.

Set one station for one servo amplifier. If the same station No. is used for multiple servo amplifiers, the communication will fail.

[Pr. PC21_RS-422 communication function selection (*SOP)]

Initial value	Setting range	Ver.
00000000h	Refer to the relevant detail No.	Refer to the relevant detail No.

[Pr. PC21.1_RS-422 communication - Baud rate selection]

Initial value	Setting range	Ver.
0h	Refer to the text	B6

- 0: 9600 [bps]
- 1: 19200 [bps]
- 2: 38400 [bps]
- 3: 57600 [bps]
- 4: 115200 [bps]

[Pr. PC21.2_RS-422 communication - Response delay time selection]

Initial value	Setting range	Ver.
0h	Refer to the text	B6

- 0: Disabled
- 1: Enabled (Data is returned with a delay of 800 μ s or longer.)

[Pr. PC22_Function selection C-1 (**COP1)]

Initial value	Setting range	Ver.
00000000h	Refer to the relevant detail No.	Refer to the relevant detail No.

[Pr. PC22.3_Encoder cable communication method selection]

Initial value	Setting range	Ver.
0h	Refer to the text	A0

0: Two-wire type

1: Four-wire type

When using an A/B/Z-phase differential output type encoder, set "0". Setting "1" triggers [AL. 037 Parameter error].

If the value is set incorrectly, [AL. 016 Encoder initial communication error 1] or [AL. 020 Encoder normal communication error 1] occurs. [AL. 037] occurs if this servo parameter is set to "1" while [Pr. PA01.4 Fully closed loop operation mode selection] is set to "1" (enabled (fully closed loop control mode)) on servo amplifiers other than the MR-J5-_A_RJ.

[Pr. PC23_Function selection C-2 (*COP2)]

Initial value	Setting range	Ver.
00000000h	Refer to the relevant detail No.	Refer to the relevant detail No.

[Pr. PC23.0_Servo lock selection on speed control stop]

Initial value	Setting range	Ver.
0h	Refer to the text	A0

Select the servo-lock selection at speed control stop.

In the speed control mode, the servo motor shaft can be locked to prevent the shaft from being moved by an external force.

0: Enabled (The servo motor shaft is servo-locked.)

The stop position is maintained.

1: Disabled (The servo motor shaft is not servo-locked.)

The stop position is not maintained.

The speed is controlled to be 0 r/min (0 mm/s).

[Pr. PC23.2_VC/VLA voltage average selection]

Initial value	Setting range	Ver.
0h	Refer to the text	A0

Select the VC/VLA voltage average.

Set the filtering time when the VC (Analog speed command) voltage or VLA (Analog speed limit) is imported.

When the setting value is 0, the speed changes in real time in response to the voltage changes, and as the setting value is increased, the speed changes gently in response to the voltage changes.

Setting value	Filtering time [ms]
0	0
1	0.500
2	1.000
3	2.000
4	3.500
5	7.000
6	1.500
7	4.000
8	8.000

[Pr. PC23.3_Torque controlling - Speed limit selection]

Initial value	Setting range	Ver.
0h	Refer to the text	A0

Select the speed limit at torque control.

0: Enabled

1: Disabled

Do not use this function except when configuring an external speed loop.

[Pr. PC24_Function selection C-3 (*COP3)]

Initial value	Setting range	Ver.
00000000h	Refer to the relevant detail No.	Refer to the relevant detail No.

[Pr. PC24.0_In-position range unit selection]

Initial value	Setting range	Ver.
0h	Refer to the text	A0

Select a unit of the in-position range.

If [Pr. PA01.4 Fully closed loop operation mode selection] is set to "1" (fully closed loop system), the in-position range is in the load-side encoder pulse unit.

0: Command input pulse unit

1: Servo motor encoder pulse unit

[Pr. PC24.3_Excessive error alarm trigger level/excessive error warning trigger level - Unit selection]

Initial value	Setting range	Ver.
0h	Refer to the text	A0

Select the unit used when setting the excessive error alarm trigger level in [Pr. PC43 Excessive error alarm trigger level] and setting the excessive error warning trigger level in [Pr. PC73 Excessive error warning trigger level].

0: [rev] or [mm]

1: [0.1 rev] or [0.1 mm]

2: [0.01 rev] or [0.01 mm]

3: [0.001 rev] or [0.001 mm]

This setting value is enabled in the position mode.

[Pr. PC26_Function selection C-5 (*COP5)]

Initial value	Setting range	Ver.
00000000h	Refer to the relevant detail No.	Refer to the relevant detail No.

[Pr. PC26.0_[AL. 099 Stroke limit warning] selection]

Initial value	Setting range	Ver.
0h	Refer to the text	A0

Enable or disable [AL. 099 Stroke limit warning].

When "Disabled" is selected, [AL. 099] does not occur while LSP (Forward rotation stroke end) or LSN (Reverse rotation stroke end) is off, but the operation will be stopped with the stroke limit.

0: Enabled

1: Disabled

[Pr. PC26.4_Output open-phase detection selection]

Initial value	Setting range	Ver.
0h	Refer to the text	A0

Enable or disable the detection of output open-phase detection function.

0: Disabled

1: Enabled

[Pr. PC26.6_Output open phase - Judgment speed selection]

Initial value	Setting range	Ver.
0h	Refer to the text	A0

0: Servo motor speed

1: Speed command

When "0" (servo motor speed) is set, the value of the servo motor speed is used for the speed judgment of the output open-phase detection.

When "1" (speed command) is set, the speed command value is used for the speed judgment of the output open-phase detection.

In the torque control mode, set "0". When "1" is set, [AL. 139.2 Output open-phase error] does not occur.

[Pr. PC27_Function selection C-6 (*COP6)]

Initial value	Setting range	Ver.
00000000h	Refer to the relevant detail No.	Refer to the relevant detail No.

[Pr. PC27.2_Undervoltage alarm selection]

Initial value	Setting range	Ver.
0h	Refer to the text	A0

Select the alarm or warning that occurs when the bus voltage drops to the undervoltage alarm trigger level.

0: [AL. 010 Undervoltage] occurs regardless of servo motor speed

1: [AL. 0E9 Main circuit off warning] occurs when the servo motor speed is 50 r/min (50 mm/s) or less, and [AL. 010] occurs when over 50 r/min (50 mm/s).

[Pr. PC27.4_Input open-phase detection selection]

Initial value	Setting range	Ver.
0h	Refer to the text	A0

Enable or disable the detection of input open-phase detection function.

0: Automatic

1: Warning enabled

2: Alarm enabled

3: Disabled

When "0" (automatic) is set, the input open-phase detection function is enabled or disabled in accordance with the capacity or power supply input of the servo amplifier. Details are as follows.

Servo amplifier	Servo amplifier main circuit input voltage	Servo amplifier capacity	Input open-phase detection function
MR-J5-_A(-RJ)	3-phase AC	2 kW or less	Disabled
	1-phase AC	2 kW or less	Disabled
	Main circuit DC		
	3-phase AC	3.5 kW or more	Warning occurrence
MR-J5-_A4(-RJ)	Main circuit DC	3.5 kW or more	Disabled
	3-phase AC	3.5 kW or less	Warning occurrence

[Pr. PC28_Function selection C-7 (*COP7)]

Initial value	Setting range	Ver.
00000000h	Refer to the relevant detail No.	Refer to the relevant detail No.

[Pr. PC28.3_Linear encoder multipoint Z-phase input function selection]

Initial value	Setting range	Ver.
0h	Refer to the text	A0

When multiple reference marks exist during the full stroke of the linear encoder, set "1".

0: Disabled

1: Enabled

[Pr. PC29_Function selection C-8 (*COP8)]

Initial value	Setting range	Ver.
00000120h	Refer to the relevant detail No.	Refer to the relevant detail No.

[Pr. PC29.0_[AL. 0E2.2 Servo motor temperature warning 2] selection]

Initial value	Setting range	Ver.
0h	Refer to the text	A0

Select whether to enable or disable [AL. 0E2.2 Servo motor temperature warning 2] when a servo motor with a batteryless absolute position encoder is used.

0: Enabled

1: Disabled

[Pr. PC29.3_Analog input signal selection]

Initial value	Setting range	Ver.
0h	Refer to the text	A0

Select analog input signals of the CN3-2 pin (analog command input 1) and the CN3-27 pin (analog command input 2).

For the MR-J5-_A, the resolution of the CN3-2 pin (analog command input 1) is equivalent to 14 bits.

For the MR-J5-_A_-RJ, the initial value "0" (automatic) of [Pr. PC60.1 High resolution analog input selection] is equivalent to 16 bits, however, setting [Pr. PC 60.1] to "2" (disabled) can change the resolution to the one equivalent to 14 bits.

The resolution of the CN3-27 pin (analog command input 2) is equivalent to 12 bits.

Adjust the offset with [Pr. PC37 Analog command input 1 offset] and [Pr. PC38 Analog command input 2 offset].

In the settings of [Pr. PC23.2 VC/VLA voltage average selection], filters are enabled for pins for which VC/VLA have been set. Adjust this as necessary.

Setting value	CN3-2 pin (analog command input 1)	CN3-27 pin (analog command input 2)
0	VC/VLA	TLA/TC
1	TLA/TC	VC/VLA

[Pr. PC29.4_Speed monitor unit selection]

Initial value	Setting range	Ver.
0h	Refer to the text	A0

Select the servo motor speed unit which is displayed from "Display All" of MR Configurator2.

0: 1 r/min (1 mm/s) unit

1: 0.1 r/min (0.1 mm/s) unit

[Pr. PC30_Speed acceleration time constant 2 (STA2)]

Initial value	Setting range	Ver.
0 [ms]	0 to 50000	A0

In the speed control mode or torque control mode, set the acceleration time taken by the servo motor to reach the rated speed from a full stop for the analog speed command and internal speed command.

When STAB2 (Second acceleration/deceleration selection) is turned on, the setting value of this servo parameter is enabled.

Set the acceleration time required to reach the rated speed from 0 r/min for VC (Analog speed command) and [Pr. PC05 Internal speed 1] to [Pr. PC11 Internal speed 7].

[Pr. PC31_Speed deceleration time constant 2 (STB2)]

Initial value	Setting range	Ver.
0 [ms]	0 to 50000	A0

In the speed control mode or torque control mode, set the deceleration time for the servo motor to stop from the rated speed for the analog speed command and internal speed command.

When STAB2 (Second acceleration/deceleration selection) is turned on, the setting value of this servo parameter is enabled. Set the deceleration time required to reach 0 r/min from the rated speed for VC (Analog speed command) and [Pr. PC05 Internal speed 1] to [Pr. PC11 Internal speed 7].

[Pr. PC32_Command input pulse multiplication numerator 2 (CMX2)]

Initial value	Setting range	Ver.
1	1 to 2147483647	A0

Set the multiplication factor for command input pulses.

This servo parameter is enabled when [Pr. PA21.3 Electronic gear compatibility selection] is set to "0", "2", "3", or "4".

CM1	CM2	Electronic gear
Open	Open	CMX
Shorted	Open	CMX2
Open	Shorted	CMX3
Shorted	Shorted	CMX4

[Pr. PC33_Command input pulse multiplication numerator 3 (CMX3)]

Initial value	Setting range	Ver.
1	1 to 2147483647	A0

Set the multiplication factor for command input pulses.

This servo parameter is enabled when [Pr. PA21.3 Electronic gear compatibility selection] is set to "0", "2", "3", or "4".

[Pr. PC34_Command input pulse multiplication numerator 4 (CMX4)]

Initial value	Setting range	Ver.
1	1 to 2147483647	A0

Set the multiplication factor for command input pulses.

This servo parameter is enabled when [Pr. PA21.3 Electronic gear compatibility selection] is set to "0", "2", "3", or "4".

[Pr. PC35_Internal torque limit 2 (TL2)]

Initial value	Setting range	Ver.
1000.0 [%]	0.0 to 1000.0	A0

Set the servo parameter for limiting the torque or thrust generated by the servo motor assuming the rated torque or continuous thrust as 100.0 %. If this servo parameter is set to "0.0", the servo motor does not generate torque or thrust. If TL1 (Internal torque limit selection) is turned on, the setting value of [Pr. PA11] or [Pr. PA12] is compared with [Pr. PC35 Internal torque limit 2] and the lower one will be enabled.

When [Pr. PC50.0 Torque limit unit change] is set to "0" (maximum torque unit), set the servo parameter in relation to the maximum torque or maximum thrust (= 100.0 %).

[Pr. PC36_Status display selection (*DMD)]

Initial value	Setting range	Ver.
00000000h	Refer to the relevant detail No.	Refer to the relevant detail No.

[Pr. PC36.0-1_Main unit status display selection at power on]

Initial value	Setting range	Ver.
00h	Refer to the text	A0

Select the status display shown at power-on. Setting any value other than the following will trigger [AL. 037 Parameter error].

- 00: Cumulative feedback pulses
- 01: Servo motor speed
- 02: Droop pulses
- 03: Cumulative command pulses
- 04: Command pulse frequency
- 05: Analog speed command voltage^{*1}
- 06: Analog torque command voltage^{*2}
- 07: Regenerative load ratio
- 08: Effective load ratio
- 09: Peak load ratio
- 0A: Instantaneous torque/instantaneous thrust
- 0B: Position within one-revolution/virtual position within one-revolution (1 pulse unit)
- 0C: Position within one-revolution/virtual position within one-revolution (1000 pulses unit)
- 0D: ABS counter/virtual ABS counter
- 0E: Load to motor inertia ratio/load to motor mass ratio
- 0F: Bus voltage
- 10: Internal temperature of encoder/temperature of servo motor thermistor
- 11: Settling time
- 12: Oscillation detection frequency
- 13: Number of tough drive operations
- 14: Unit power consumption (1 W unit)
- 15: Unit power consumption (1 kW unit)
- 16: Unit total power consumption (1 Wh unit)
- 17: Unit total power consumption (100 kWh unit)
- 18: Load side encoder cumulative feedback pulses^{*3}
- 19: Load-side droop pulses^{*3}
- 1A: Load-side encoder information 1 (1 pulse unit)^{*3}
- 1B: Load-side encoder information 1 (100000 pulses unit)^{*3}
- 1C: Load-side encoder ABS counter^{*3}
- 1D: Z-phase counter (1 pulse unit)^{*4}
- 1E: Z-phase counter (100000 pulses unit)^{*4}
- 1F: Electrical angle (1 pulse unit)^{*4}
- 20: Electrical angle (100000 pulses unit)^{*4}

*1 When in the speed control mode. In the torque control mode, the analog speed limit voltage is applied.

*2 When in the torque control mode. In the speed control mode and position control mode, the analog torque limit voltage is applied.

*3 If any of 18 to 1C is set in a mode other than the fully closed loop control mode, [AL. 037] occurs.

*4 If any of 1D to 20 is set in a mode other than the linear servo motor control mode, [AL. 037] occurs.

[Pr. PC36.2_Status display at power-on in corresponding control mode]

Initial value	Setting range	Ver.
0h	Refer to the text	A0

0: Depends on the control mode

1: Depends on the setting of [Pr. PC36.0-1 Main unit status display selection at power on].

Refer to the following table for the details of when "0" is set.

Control mode	Status display at power-on
Position	Cumulative feedback pulses
Position/speed	Cumulative feedback pulses/servo motor speed
Speed	Servo motor speed
Speed/torque	Servo motor speed/analog torque (thrust) command voltage
Torque	Analog torque (thrust) command voltage
Torque/position	Analog torque (thrust) command voltage/cumulative feedback pulses

[Pr. PC37_Analog command input 1 offset (VCO)]

Initial value	Setting range	Ver.
0 [mV]	-9999 to 9999	A0

Set the offset voltage for analog command input 1.

If the analog command input 1 automatic offset is used, the automatically offset voltage will be set.

VC/VLA is assigned to analog command input 1 (CN3-2 pin) when the initial value is set in [Pr. PC29.3 Analog input signal selection].

In addition, the servo amplifier is shipped from the factory with the automatically offset voltage set by executing the analog command input 1 automatic offset with the voltage being 0 between the CN3-2 pin (VC/VLA) and LG.

[Pr. PC29.3]	Control mode	Function
0 (initial value)	Speed control mode	Set the offset voltage for VC (Analog speed command). If the servo motor rotates in CCW or travels in the positive direction when ST1 (Forward rotation start) is turned on while 0 V is applied to VC, set a negative value.
	Torque control mode	Set the offset voltage for VLA (Analog speed limit). If the servo motor rotates in CCW or travels in the positive direction when RS1 (Forward rotation selection) is turned on while 0 V is applied to VLA, set a negative value.
1	Position control mode or speed control mode	Set the offset voltage for TLA (Analog torque limit).
	Torque control mode	Set the offset voltage for TC (Analog torque command).

[Pr. PC38_Analog command input 2 offset (TPO)]

Initial value	Setting range	Ver.
0 [mV]	-9999 to 9999	A0

Set the offset voltage for analog command input 2.

TLA/TC is assigned to analog command input 2 (CN3-27 pin) when the initial value is set in [Pr. PC29.3 Analog input signal selection].

[Pr. PC29.3]	Control mode	Function
0 (initial value)	Position control mode or speed control mode	Set the offset voltage for TLA (Analog torque limit).
	Torque control mode	Set the offset voltage for TC (Analog torque command).
1	Speed control mode	Set the offset voltage for VC (Analog speed command). If the servo motor rotates in CCW or travels in the positive direction when ST1 (Forward rotation start) is turned on while 0 V is applied to VC, set a negative value.
	Torque control mode	Set the offset voltage for VLA (Analog speed limit). If the servo motor rotates in CCW or travels in the positive direction when RS1 (Forward rotation selection) is turned on while 0 V is applied to VLA, set a negative value.

[Pr. PC39_Analog monitor 1 offset (MO1)]

Initial value	Setting range	Ver.
0 [mV]	-9999 to 9999	A0

Set the offset voltage of analog monitor 1.

[Pr. PC40_Analog monitor 2 offset (MO2)]

Initial value	Setting range	Ver.
0 [mV]	-9999 to 9999	A0

Set the offset voltage of analog monitor 2.

[Pr. PC43_Excessive error alarm trigger level (ERZ)]

Initial value	Setting range	Ver.
0 [rev], [mm]	0 to 1000	A0

Set an excessive error alarm trigger level.

If using a rotary servo motor or direct drive motor, set the level in units of rev. If 200 rev or higher is set, the value will be clamped to 200 rev.

If using a linear servo motor, set the level in units of mm.

When the value is set to "0", the alarm trigger level for rotary servo motors and direct drive motors is 3 rev. The alarm trigger level for linear servo motors is 100 mm.

The unit can be changed with [Pr. PC24.3 Excessive error alarm trigger level/excessive error warning trigger level - Unit selection].

[Pr. PC44_Function selection C-9 (**COP9)]

Initial value	Setting range	Ver.
00000050h	Refer to the relevant detail No.	Refer to the relevant detail No.

[Pr. PC44.3_Load-side encoder cable communication method selection]

Initial value	Setting range	Ver.
0h	Refer to the text	A0

Select an encoder cable to be connected to the CN2L connector of MR-J5-_A_-RJ.

0: Two-wire type

1: Four-wire type

When using a load-side encoder that is A/B/Z-phase differential output type, set "0". Setting "1" triggers [AL. 037 Parameter error].

If the value is set incorrectly, [AL. 070 Load-side encoder initial communication error 1] or [AL. 071 Load-side encoder normal communication error 1] occurs.

Setting "1" on servo amplifiers other than the MR-J5-_A_-RJ triggers [AL. 037 Parameter error].

[Pr. PC45_Function selection C-A (**COPA)]

Initial value	Setting range	Ver.
00000000h	Refer to the relevant detail No.	Refer to the relevant detail No.

[Pr. PC45.0_Encoder pulse count polarity selection]

Initial value	Setting range	Ver.
0h	Refer to the text	A0

Select a polarity of the load-side encoder.

In the linear servo motor control mode, the polarity of the motor-side encoder changes.

0: Encoder pulse increasing direction in the servo motor CCW or positive direction

1: Encoder pulse decreasing direction in the servo motor CCW or positive direction

[Pr. PC45.2_ABZ phase input interface encoder ABZ phase connection assessment function selection]

Initial value	Setting range	Ver.
0h	Refer to the text	A0

Select the non-signal detection status for the pulse train signal from the A/B/Z-phase input interface encoder used as a linear encoder or load-side encoder.

This function is enabled when an A/B/Z-phase input interface encoder is used.

Setting value	Detection of disconnection	Alarm status	
	Z-phase-side non-signal	Fully closed loop control mode	Linear servo motor control mode
0	Enabled	[AL. 071.6 Load-side encoder normal communication - Transmission data error 2] (Zphase)	[AL. 020.6 Encoder normal communication - Transmission data error 2] (Z-phase)
1	Disabled	—	—

[Pr. PC50_Function selection C-B (*COPB)]

Initial value	Setting range	Ver.
00000001h	Refer to the relevant detail No.	Refer to the relevant detail No.

[Pr. PC50.0_Torque limit unit change]

Initial value	Setting range	Ver.
1h	Refer to the text	A0

When "1" (rated torque unit) is set on this servo parameter, set the torque limit or thrust limit of [Pr. PA11], [Pr. PA12], and [Pr. PC35] in relation to the rated torque or continuous thrust (= 100 %). When "0" (maximum torque unit) is set, set the servo parameter in relation to the maximum torque or maximum thrust (= 100 %).

0: Maximum torque unit

1: Rated torque unit

Servo parameter	Name	Maximum torque unit [Pr. PC50.0] = "0"	Rated torque unit [Pr. PC50.0] = "1"
[Pr. PA11]	Forward rotation torque limit	Maximum	Rated
[Pr. PA12]	Reverse rotation torque limit		
[Pr. PC35]	Internal torque limit 2		

[Pr. PC50.1_Analog torque command unit change]

Initial value	Setting range	Ver.
0h	Refer to the text	A0

When "1" (rated torque unit) is set on this servo parameter, set the torque or thrust command unit of [Pr. PC13] in relation to the rated torque or continuous thrust (= 100 %). When "0" (maximum torque unit) is set, set the servo parameter in relation to the maximum torque or maximum thrust (= 100 %).

0: Maximum torque unit

1: Rated torque unit

Servo parameter	Name	Maximum torque unit [Pr. PC50.1] = "0"	Rated torque unit [Pr. PC50.1] = "1"
[Pr. PC13]	Analog torque command maximum output	Maximum	Rated

[Pr. PC51_Deceleration time constant at forced stop (RSBR)]

Initial value	Setting range	Ver.
100 [ms]	0 to 20000	A0

Set the deceleration time constant for the forced stop deceleration function.

Set the time taken from the rated speed to 0 [r/min] (0 [mm/s]) in units of ms.

When "0" is set, the deceleration time constant is the same as when "100" is set.

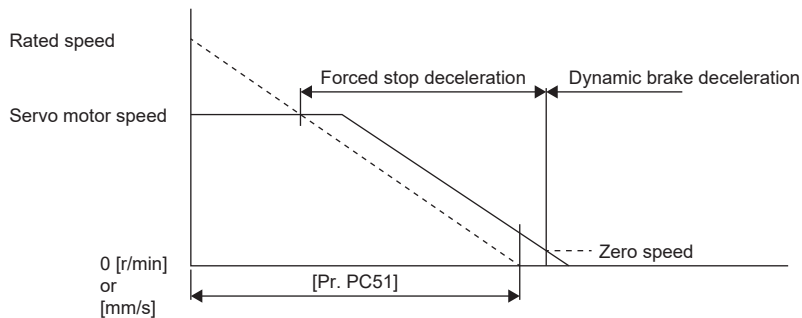

- If the servo motor torque or thrust is saturated at the maximum value during forced stop deceleration because the set time is too short, the time to stop the servo motor will be longer than the set time constant.
- [AL. 050 Overload 1] or [AL. 051 Overload 2] may occur during forced stop deceleration, depending on the set value.
- After an occurrence of an alarm to execute forced stop deceleration, if another alarm that does not execute forced stop deceleration occurs, or if the control circuit power supply is shut off, dynamic braking will start regardless of the deceleration time constant setting.
- Set a longer time than deceleration time at quick stop of the controller. If the setting time is too short, [AL. 052 Excessive error] may occur.
- During forced stop deceleration, changes in the setting value are not reflected. If the setting value is changed during forced stop deceleration, the change will be reflected after the deceleration is completed.

[Pr. PC54_Vertical axis freefall prevention compensation amount (RSUP1)]

Initial value	Setting range	Ver.
0 [0.0001 rev], [0.01 mm]	-25000 to 25000	A0

Set the compensation amount of the vertical axis freefall prevention function.

Set the compensation amount in either the servo motor rotation amount unit or linear servo motor travel distance unit.

When a positive value is set, the compensation is performed to the command address increasing direction. When a negative value is set, compensation is performed to the command address decreasing direction.

The vertical axis freefall prevention function is performed when all of the following conditions are met.

- The control mode is set for the position mode.
- The setting value of this servo parameter is other than "0".
- The forced stop deceleration function is enabled.
- An alarm has occurred or EM2 has turned off when the servo motor rotates at the zero speed or less.
- MBR (Electromagnetic brake interlock) was enabled in [Pr. PD23 Output device selection 1] to [Pr. PD28 Output device selection 6], and the base circuit shut-off delay time was set in [Pr. PC16 Electromagnetic brake sequence output].

[Pr. PC60_Function selection C-D (**COPD)]

Initial value	Setting range	Ver.
00000000h	Refer to the relevant detail No.	Refer to the relevant detail No.

[Pr. PC60.0_Motor-less operation selection]

Initial value	Setting range	Ver.
0h	Refer to the text	A0

Enable or disable motor-less operation. This operation can be used only in semi closed loop control while a rotary servo motor is used.

0: Disabled

1: Enabled

[Pr. PC60.1_High resolution analog input selection]

Initial value	Setting range	Ver.
0h	Refer to the text	A0

Select the resolution of analog command input 1 (VC/VLA or TLA/TC) set in [Pr. PC29.3 Analog input signal selection].

When the servo parameter is changed, perform offset adjustment with [Pr. PC37 Analog command input 1 offset].

The offset adjustment can be performed by executing the analog command input 1 automatic offset.

"0" (automatic) is the same setting as "2" (disabled) for the MR-J5-_A and "1" (enabled) for the MR-J5-_A_-RJ.

When the servo parameter is disabled, the resolution is equivalent to 14 bits, and when the parameter is enabled, the resolution is equivalent to 16 bits.

Setting "1" on other than MR-J5-_A_-RJ triggers [AL. 037 Parameter error].

0: Automatic

1: Enabled

2: Disabled

[Pr. PC60.4_Encoder communication circuit diagnosis mode selection]

Initial value	Setting range	Ver.
0h	Refer to the text	A0

Enable or disable the encoder communication circuit diagnosis mode.

[AL. 118.1 Encoder communication circuit diagnosis in progress] occurs during the encoder communication circuit diagnosis mode.

0: Encoder communication circuit diagnosis mode disabled

1: Encoder communication circuit diagnosis mode enabled

[Pr. PC60.6_Multipoint Z-phase linear encoder monitor selection]

Initial value	Setting range	Ver.
0h	Refer to the text	D8

When multiple reference marks exist during the full stroke of the linear encoder, set "1".

0:Automatic setting

1:Enabled

If an encoder other than the incremental linear encoder or A/B/Z-phase differential output linear encoder is connected, the setting value of this servo parameter is disabled.

[Pr. PC73_ Excessive error warning trigger level (ERW)]

Initial value	Setting range	Ver.
0 [rev], [mm]	0 to 1000	A0

Set the excessive error warning trigger level.

If using a rotary servo motor or direct drive motor, set the level in units of rev. If 200 rev or higher is set, the value will be clamped to 200 rev.

If using a linear servo motor, set the level in units of mm.

When "0" is set, [AL. 09B Excessive error warning] does not occur.

If an error reaches the set value, [AL. 09B Excessive error warning] occurs. If the error later becomes less than the setting value, the warning will be automatically canceled. The minimum pulse width of the warning signal output is 100 [ms].

Set as follows: [Pr. PC73 Excessive error warning trigger level] < [Pr. PC43 Excessive error alarm trigger level]. When set as [Pr. PC73] ≥ [Pr. PC43], [AL. 052 Excessive error] occurs before the warning.

The unit can be changed with [Pr. PC24.3 Excessive error alarm trigger level/excessive error warning trigger level - Unit selection].

[Pr. PC90_ Command frequency error threshold (PLFT)]

Initial value	Setting range	Ver.
0 [pulse/s]	0 to 2147483647	A5

Set the threshold of [AL. 035 Command frequency error].

When "0" is set, the threshold is set automatically in the servo amplifier.

1.5 I/O setting servo parameters group ([Pr. PD_ _])

[Pr. PD01_Input signal automatic ON selection 1 (*DIA1)]

Initial value	Setting range	Ver.
00000000h	Refer to the relevant detail No.	Refer to the relevant detail No.

[Pr. PD01.0_Input signal automatic ON selection]

Initial value	Setting range	Ver.
0h	Refer to the text	A0

Select input devices that turn on automatically.

Setting digit (BIN)	Function
___x	For manufacturer setting
__x_	For manufacturer setting
_x__	Servo-on (SON) 0: Use for an external input signal 1: Automatic on
x___	For manufacturer setting

[Pr. PD01.1_Input signal automatic ON selection]

Initial value	Setting range	Ver.
0h	Refer to the text	A0

Select input devices that turn on automatically.

Setting digit (BIN)	Function
___x	Proportional control (PC) 0: Use for an external input signal 1: Automatic on
__x_	External torque limit (TL) 0: Use for an external input signal 1: Automatic on
_x__	For manufacturer setting
x___	For manufacturer setting

[Pr. PD01.2_Input signal automatic ON selection]

Initial value	Setting range	Ver.
0h	Refer to the text	A0

Select input devices that turn on automatically.

Setting digit (BIN)	Function
___x	For manufacturer setting
__x_	For manufacturer setting
_x__	Forward rotation stroke end (LSP) 0: Use for an external input signal 1: Automatic on
x___	Reverse rotation stroke end (LSN) 0: Use for an external input signal 1: Automatic on

[Pr. PD01.3_Input signal automatic ON selection]

Initial value	Setting range	Ver.
0h	Refer to the text	A0

Select input devices that turn on automatically.

Setting digit (BIN)	Function
___x	Forced stop (EM2)/forced stop (EM1) 0: Use for an external input signal 1: Automatic on *1
__x_	For manufacturer setting
_x__	For manufacturer setting
x___	For manufacturer setting

*1 Use this function only in the test operation.

[Pr. PD03_Input device selection 1L (*DI1L)]

Initial value	Setting range	Ver.
00000202h	Refer to the relevant detail No.	Refer to the relevant detail No.

Select the device to be assigned to the input signal of the CN3-15 pin.

[Pr. PD03.0-1_Position control mode - Device selection]

Initial value	Setting range	Ver.
02h	Refer to the text	A0

Refer to the following table for setting values.

Setting value	Control mode ^{*1}		
	P	S	T
02	SON	SON	SON
03	RES	RES	RES
04	PC	PC	—
05	TL	TL	—
06	CR	—	—
07	—	ST1	RS2
08	—	ST2	RS1
09	TL1	TL1	—
0A	LSP	LSP	LSP ^{*4}
0B	LSN	LSN	LSN ^{*4}
0D	CDP	CDP	—
0E ^{*5}	CLD	—	—
0F ^{*5}	MECR	—	—
13 ^{*5}	PEN	—	—
20	—	SP1	SP1
21	—	SP2	SP2
22	—	SP3	SP3
23	LOP ^{*3}	LOP ^{*3}	LOP ^{*3}
24	CM1	—	—
25	CM2	—	—
26	—	STAB2	STAB2
40	CDP2	CDP2	—

*1 P: Position control mode, S: Speed control mode, T: Torque control mode

*2 Do not make a setting on the control modes with "—" in the column, as these are for manufacturer setting.

*3 When assigning LOP (Control switching), assign to the same pin in all control modes.

*4 In the torque control mode, this device cannot be used in the normal operation. This device can be used during the magnetic pole detection in the linear servo motor control mode and the direct drive motor control mode. Also, when the magnetic pole detection in the torque control mode is completed, this signal will be disabled.

*5 Available on servo amplifiers with firmware version A5 or later.

[Pr. PD03.2-3_Speed control mode - Device selection]

Initial value	Setting range	Ver.
02h	Refer to the text	A0

Refer to the following for setting values.

☞ Page 92 [Pr. PD03.0-1_Position control mode - Device selection]

[Pr. PD04_Input device selection 1H (*DI1H)]

Initial value	Setting range	Ver.
00000202h	Refer to the relevant detail No.	Refer to the relevant detail No.

Select the device to be assigned to the input signal of the CN3-15 pin.

[Pr. PD04.0-1_Torque control mode - Device selection]

Initial value	Setting range	Ver.
02h	Refer to the text	A0

Refer to the following for setting values.

☞ Page 92 [Pr. PD03_Input device selection 1L (*DI1L)]

[Pr. PD05_Input device selection 2L (*DI2L)]

Initial value	Setting range	Ver.
00002100h	Refer to the relevant detail No.	Refer to the relevant detail No.

Select the device to be assigned to the input signal of the CN3-16 pin.

[Pr. PD05.0-1_Position control mode - Device selection]

Initial value	Setting range	Ver.
00h	Refer to the text	A0

Refer to the following for setting values.

☞ Page 92 [Pr. PD03_Input device selection 1L (*DI1L)]

[Pr. PD05.2-3_Speed control mode - Device selection]

Initial value	Setting range	Ver.
21h	Refer to the text	A0

Refer to the following for setting values.

☞ Page 92 [Pr. PD03_Input device selection 1L (*DI1L)]

[Pr. PD06_Input device selection 2H (*DI2H)]

Initial value	Setting range	Ver.
00002021h	Refer to the relevant detail No.	Refer to the relevant detail No.

Select the device to be assigned to the input signal of the CN3-16 pin.

[Pr. PD06.0-1_Torque control mode - Device selection]

Initial value	Setting range	Ver.
21h	Refer to the text	A0

Refer to the following for setting values.

☞ Page 92 [Pr. PD03_Input device selection 1L (*DI1L)]

[Pr. PD07_Input device selection 3L (*DI3L)]

Initial value	Setting range	Ver.
00000704h	Refer to the relevant detail No.	Refer to the relevant detail No.

Select the device to be assigned to the input signal of the CN3-17 pin.

If the absolute position detection system with DIO is selected while [Pr. PA03.0 Absolute position detection system selection] has been set to "1" (enabled (absolute position detection system by DIO)), the CN3-17 pin becomes ABSM (ABS transfer mode).

[Pr. PD07.0-1_Position control mode - Device selection]

Initial value	Setting range	Ver.
04h	Refer to the text	A0

Refer to the following for setting values.

☞ Page 92 [Pr. PD03_Input device selection 1L (*DI1L)]

[Pr. PD07.2-3_Speed control mode - Device selection]

Initial value	Setting range	Ver.
07h	Refer to the text	A0

Refer to the following for setting values.

☞ Page 92 [Pr. PD03_Input device selection 1L (*DI1L)]

[Pr. PD08_Input device selection 3H (*DI3H)]

Initial value	Setting range	Ver.
00000707h	Refer to the relevant detail No.	Refer to the relevant detail No.

Select the device to be assigned to the input signal of the CN3-17 pin.

If the absolute position detection system with DIO is selected while [Pr. PA03.0 Absolute position detection system selection] has been set to "1" (enabled (absolute position detection system by DIO)), the CN3-17 pin becomes ABSM (ABS transfer mode).

[Pr. PD08.0-1_Torque control mode - Device selection]

Initial value	Setting range	Ver.
07h	Refer to the text	A0

Refer to the following for setting values.

☞ Page 92 [Pr. PD03_Input device selection 1L (*DI1L)]

[Pr. PD09_Input device selection 4L (*DI4L)]

Initial value	Setting range	Ver.
00000805h	Refer to the relevant detail No.	Refer to the relevant detail No.

Select the device to be assigned to the input signal of the CN3-18 pin.

If the absolute position detection system with DIO is selected while [Pr. PA03.0 Absolute position detection system selection] has been set to "1" (enabled (absolute position detection system by DIO)), the CN3-18 pin becomes ABSR (ABS transfer request).

[Pr. PD09.0-1_Position control mode - Device selection]

Initial value	Setting range	Ver.
05h	Refer to the text	A0

Refer to the following for setting values.

☞ Page 92 [Pr. PD03_Input device selection 1L (*DI1L)]

[Pr. PD09.2-3_Speed control mode - Device selection]

Initial value	Setting range	Ver.
08h	Refer to the text	A0

Refer to the following for setting values.

☞ Page 92 [Pr. PD03_Input device selection 1L (*DI1L)]

[Pr. PD10_Input device selection 4H (*DI4H)]

Initial value	Setting range	Ver.
00000808h	Refer to the relevant detail No.	Refer to the relevant detail No.

Select the device to be assigned to the input signal of the CN3-18 pin.

If the absolute position detection system with DIO is selected while [Pr. PA03.0 Absolute position detection system selection] has been set to "1" (enabled (absolute position detection system by DIO)), the CN3-18 pin becomes ABSR (ABS transfer request).

[Pr. PD10.0-1_Torque control mode - Device selection]

Initial value	Setting range	Ver.
08h	Refer to the text	A0

Refer to the following for setting values.

☞ Page 92 [Pr. PD03_Input device selection 1L (*DI1L)]

[Pr. PD11_Input device selection 5L (*DI5L)]

Initial value	Setting range	Ver.
00000303h	Refer to the relevant detail No.	Refer to the relevant detail No.

Select the device to be assigned to the input signal of the CN3-19 pin.

[Pr. PD11.0-1_Position control mode - Device selection]

Initial value	Setting range	Ver.
03h	Refer to the text	A0

Refer to the following for setting values.

☞ Page 92 [Pr. PD03_Input device selection 1L (*DI1L)]

[Pr. PD11.2-3_Speed control mode - Device selection]

Initial value	Setting range	Ver.
03h	Refer to the text	A0

Refer to the following for setting values.

☞ Page 92 [Pr. PD03_Input device selection 1L (*DI1L)]

[Pr. PD12_Input device selection 5H (*DI5H)]

Initial value	Setting range	Ver.
00003803h	Refer to the relevant detail No.	Refer to the relevant detail No.

Select the device to be assigned to the input signal of the CN3-19 pin.

[Pr. PD12.0-1_Torque control mode - Device selection]

Initial value	Setting range	Ver.
03h	Refer to the text	A0

Refer to the following for setting values.

☞ Page 92 [Pr. PD03_Input device selection 1L (*DI1L)]

[Pr. PD13_Input device selection 6L (*DI6L)]

Initial value	Setting range	Ver.
00002006h	Refer to the relevant detail No.	Refer to the relevant detail No.

Select the device to be assigned to the input signal of the CN3-41 pin.

[Pr. PD13.0-1_Position control mode - Device selection]

Initial value	Setting range	Ver.
06h	Refer to the text	A0

Refer to the following for setting values.

☞ Page 92 [Pr. PD03_Input device selection 1L (*DI1L)]

[Pr. PD13.2-3_Speed control mode - Device selection]

Initial value	Setting range	Ver.
20h	Refer to the text	A0

Refer to the following for setting values.

☞ Page 92 [Pr. PD03_Input device selection 1L (*DI1L)]

[Pr. PD14_Input device selection 6H (*DI6H)]

Initial value	Setting range	Ver.
00003920h	Refer to the relevant detail No.	Refer to the relevant detail No.

Select the device to be assigned to the input signal of the CN3-41 pin.

[Pr. PD14.0-1_Torque control mode - Device selection]

Initial value	Setting range	Ver.
20h	Refer to the text	A0

Refer to the following for setting values.

☞ Page 92 [Pr. PD03_Input device selection 1L (*DI1L)]

[Pr. PD17_Input device selection 8L (*DI8L)]

Initial value	Setting range	Ver.
000A0A0Ah	Refer to the relevant detail No.	Refer to the relevant detail No.

Select the device to be assigned to the input signal of the CN3-43 pin.

[Pr. PD17.0-1_Position control mode - Device selection]

Initial value	Setting range	Ver.
0Ah	Refer to the text	A0

Refer to the following for setting values.

☞ Page 92 [Pr. PD03_Input device selection 1L (*DI1L)]

[Pr. PD17.2-3_Speed control mode - Device selection]

Initial value	Setting range	Ver.
0Ah	Refer to the text	A0

Refer to the following for setting values.

☞ Page 92 [Pr. PD03_Input device selection 1L (*DI1L)]

[Pr. PD18_Input device selection 8H (*DI8H)]

Initial value	Setting range	Ver.
00000A00h	Refer to the relevant detail No.	Refer to the relevant detail No.

Select the device to be assigned to the input signal of the CN3-43 pin.

[Pr. PD18.0-1_Torque control mode - Device selection]

Initial value	Setting range	Ver.
00h	Refer to the text	A0

Refer to the following for setting values.

☞ Page 92 [Pr. PD03_Input device selection 1L (*DI1L)]

[Pr. PD19_Input device selection 9L (*DI9L)]

Initial value	Setting range	Ver.
000B0B0Bh	Refer to the relevant detail No.	Refer to the relevant detail No.

Select the device to be assigned to the input signal of the CN3-44 pin.

[Pr. PD19.0-1_Position control mode - Device selection]

Initial value	Setting range	Ver.
0Bh	Refer to the text	A0

Refer to the following for setting values.

☞ Page 92 [Pr. PD03_Input device selection 1L (*DI1L)]

[Pr. PD19.2-3_Speed control mode - Device selection]

Initial value	Setting range	Ver.
0Bh	Refer to the text	A0

Refer to the following for setting values.

☞ Page 92 [Pr. PD03_Input device selection 1L (*DI1L)]

[Pr. PD20_Input device selection 9H (*DI9H)]

Initial value	Setting range	Ver.
00000B00h	Refer to the relevant detail No.	Refer to the relevant detail No.

Select the device to be assigned to the input signal of the CN3-44 pin.

[Pr. PD20.0-1_Torque control mode - Device selection]

Initial value	Setting range	Ver.
00h	Refer to the text	A0

Refer to the following for setting values.

☞ Page 92 [Pr. PD03_Input device selection 1L (*DI1L)]

[Pr. PD21_Input device selection 10L (*DI10L)]

Initial value	Setting range	Ver.
002B2323h	Refer to the relevant detail No.	Refer to the relevant detail No.

Select the device to be assigned to the input signal of the CN3-45 pin.

[Pr. PD21.0-1_Position control mode - Device selection]

Initial value	Setting range	Ver.
23h	Refer to the text	A0

Refer to the following for setting values.

☞ Page 92 [Pr. PD03_Input device selection 1L (*DI1L)]

[Pr. PD21.2-3_Speed control mode - Device selection]

Initial value	Setting range	Ver.
23h	Refer to the text	A0

Refer to the following for setting values.

☞ Page 92 [Pr. PD03_Input device selection 1L (*DI1L)]

[Pr. PD22_Input device selection 10H (*DI10H)]

Initial value	Setting range	Ver.
00002B23h	Refer to the relevant detail No.	Refer to the relevant detail No.

Select the device to be assigned to the input signal of the CN3-45 pin.

[Pr. PD22.0-1_Torque control mode - Device selection]

Initial value	Setting range	Ver.
23h	Refer to the text	A0

Refer to the following for setting values.

☞ Page 92 [Pr. PD03_Input device selection 1L (*DI1L)]

[Pr. PD23_Output device selection 1 (*DO1)]

Initial value	Setting range	Ver.
00000004h	Refer to the relevant detail No.	Refer to the relevant detail No.

Select a function of the CN3-22 pin.

If the absolute position detection system with DIO is selected while [Pr. PA03.0 Absolute position detection system selection] has been set to "1" (enabled (absolute position detection system by DIO)), the CN3-22 pin functions as "ABS transmission data bit 0 (ABS0)" during the ABS transfer mode.

[Pr. PD23.0-1_Device selection]

Initial value	Setting range	Ver.
04h	Refer to the text	A0

Refer to the following table for setting values.

Setting value	Control mode ^{*1}		
	P	S	T
00	Always off	Always off	Always off
02	RD	RD	RD
03	ALM	ALM	ALM
04	INP	SA	Always off
05	MBR	MBR	MBR
06 ^{*3}	DB	DB	DB
07	TLC	TLC	VLC
08	WNG	WNG	WNG
09	BWNG	BWNG	BWNG
0A	Always off	SA	Always off
0B	Always off	Always off	VLC
0C	ZSP	ZSP	ZSP
0D	MTTR	MTTR	MTTR
0E	WNGSTOP	WNGSTOP	WNGSTOP
0F	CDPS	Always off	Always off
10 ^{*2}	CLDS	Always off	Always off
11	ABSV	Always off	Always off
18	CDPS2	CDPS2	CDPS2
19 ^{*2}	PENS	Always off	Always off
31	ALMWNG	ALMWNG	ALMWNG
32	BW9F	BW9F	BW9F

*1 P: Position control mode, S: Speed control mode, T: Torque control mode

*2 Available on servo amplifiers with firmware version A5 or later.

*3 This device is not necessary for a servo amplifier that does not support the external dynamic brake.

[Pr. PD24_Output device selection 2 (*DO2)]

Initial value	Setting range	Ver.
0000000Ch	Refer to the relevant detail No.	Refer to the relevant detail No.

Select a function of the CN3-23 pin.

If the absolute position detection system with DIO is selected while [Pr. PA03.0 Absolute position detection system selection] has been set to "1" (enabled (absolute position detection system by DIO)), the CN3-23 pin functions as "ABS transmission data bit 1 (ABSB1)" during the ABS transfer mode.

[Pr. PD24.0-1_Device selection]

Initial value	Setting range	Ver.
0Ch	Refer to the text	A0

Refer to the following for setting values.

☞ Page 99 [Pr. PD23_Output device selection 1 (*DO1)]

[Pr. PD25_Output device selection 3 (*DO3)]

Initial value	Setting range	Ver.
00000004h	Refer to the relevant detail No.	Refer to the relevant detail No.

Select a function of the CN3-24 pin.

[Pr. PD25.0-1_Device selection]

Initial value	Setting range	Ver.
04h	Refer to the text	A0

Refer to the following for setting values.

☞ Page 99 [Pr. PD23_Output device selection 1 (*DO1)]

[Pr. PD26_Output device selection 4 (*DO4)]

Initial value	Setting range	Ver.
00000007h	Refer to the relevant detail No.	Refer to the relevant detail No.

Select a function of the CN3-25 pin.

If the absolute position detection system with DIO is selected while [Pr. PA03.0 Absolute position detection system selection] has been set to "1" (enabled (absolute position detection system by DIO)), the CN3-25 pin functions as "ABS transmission data ready (ABST)" during the ABS transfer mode.

[Pr. PD26.0-1_Device selection]

Initial value	Setting range	Ver.
07h	Refer to the text	A0

Refer to the following for setting values.

☞ Page 99 [Pr. PD23_Output device selection 1 (*DO1)]

[Pr. PD28_Output device selection 6 (*DO6)]

Initial value	Setting range	Ver.
00000002h	Refer to the relevant detail No.	Refer to the relevant detail No.

Select a function of the CN3-49 pin.

[Pr. PD28.0-1_Device selection]

Initial value	Setting range	Ver.
02h	Refer to the text	A0

Refer to the following for setting values.

☞ Page 99 [Pr. PD23_Output device selection 1 (*DO1)]

[Pr. PD29_Input filter setting (*DIF)]

Initial value	Setting range	Ver.
00000007h	Refer to the relevant detail No.	Refer to the relevant detail No.

Set the function for shortening the CR signal input detection cycle and perform input signal filter settings.

[Pr. PD29.0_Input signal filter selection]

Initial value	Setting range	Ver.
7h	Refer to the text	A0

Setting value	Filtering time [ms]
0	No filter
1	0.500
2	1.000
3	1.500
4	2.000
5	2.500
6	3.000
7	3.500
8	4.000
9	4.500
A	5.000
B	5.500

[Pr. PD29.1_RES signal dedicated filter selection]

Initial value	Setting range	Ver.
0h	Refer to the text	A0

0: Disabled

1: Enabled (50 [ms])

[Pr. PD29.2_CR signal dedicated filter selection]

Initial value	Setting range	Ver.
0h	Refer to the text	A0

0: Disabled

1: Enabled (50 [ms])

[Pr. PD30_Function selection D-1 (*DOP1)]

Initial value	Setting range	Ver.
00000000h	Refer to the relevant detail No.	Refer to the relevant detail No.

Set the following: the stop processing method at LSP/LSN signal off, the status of the base circuit when the RES signal is shorted, and the enable/disable setting of the servo motor thermistor.

[Pr. PD30.0_Stop processing selection at LSP/LSN signal off]

Initial value	Setting range	Ver.
0h	Refer to the text	A0

Select the stop processing method at LSP/LSN signal off.

- 0: Quick stop
- 1: Slow stop

[Pr. PD30.1_Base circuit status selection for RES (Reset) on]

Initial value	Setting range	Ver.
0h	Refer to the text	A0

- 0: Base circuit shut-off
- 1: Base circuit not shut-off

[Pr. PD30.3_Servo motor thermistor - Enabled/disabled selection]

Initial value	Setting range	Ver.
0h	Refer to the text	A0

- 0: Enabled
- 1: Disabled

This servo parameter is enabled when a servo motor with a built-in thermistor is used. When a servo motor without a thermistor is used, the servo parameter is disabled (temperature monitoring disabled/alarm disabled) regardless of the setting value.

No alarm is detected in motor-less operation.

When the temperature monitoring of the motor thermistor is disabled, "9999 °C" is displayed.

[Pr. PD31_Function selection D-2 (*DOP2)]

Initial value	Setting range	Ver.
00000000h	Refer to the relevant detail No.	Refer to the relevant detail No.

[Pr. PD31.2_INP output signal ON condition selection]

Initial value	Setting range	Ver.
0h	Refer to the text	A0

Select a condition for outputting INP (In-position).

This function is enabled in the position control mode.

0: Within the in-position range

1: Within the in-position range and at the completion of command output

Setting value	In-position (INP) on condition	
	Droop pulses < in-position range	Command output completion ^{*1}
0	<input type="radio"/>	×
1	<input type="radio"/>	<input type="radio"/>

○: Required

×: Not required

*1 When a position command is not input for approximately 1 ms, the command output is considered to have been completed. The in-position (INP) is off immediately after servo-on or after forced stop is canceled.

[Pr. PD32_Function selection D-3 (*DOP3)]

Initial value	Setting range	Ver.
00000000h	Refer to the relevant detail No.	Refer to the relevant detail No.

Select the setting of the clear signal.

[Pr. PD32.0_CR signal - Clear method selection]

Initial value	Setting range	Ver.
0h	Refer to the text	A0

0: Delete droop pulses by turning on the device

1: Always delete droop pulses during the device on

2: Disabled

[Pr. PD33_Function selection D-4 (*DOP4)]

Initial value	Setting range	Ver.
00000000h	Refer to the relevant detail No.	Refer to the relevant detail No.

[Pr. PD33.2_Torque limit - Travel direction selection]

Initial value	Setting range	Ver.
0h	Refer to the text	A0

Select a rotation/travel direction which enables the internal torque limit 2 and the external torque limit.

0: Both of "CCW or positive direction" and "CW or negative direction" are enabled.

1: Enabled in "CCW or positive direction"

2: Enabled in "CW or negative direction"

[Pr. PD34_Function selection D-5 (*DOP5)]

Initial value	Setting range	Ver.
00000000h	Refer to the relevant detail No.	Refer to the relevant detail No.

[Pr. PD34.1_Output device status at warning occurrence]

Initial value	Setting range	Ver.
0h	Refer to the text	A0

Select ALM (Malfunction) output status at warning occurrence.

Setting value	Device status
0	<p>WNG ON OFF ALM ON OFF</p> <p>Warning occurrence</p>
1	<p>WNG ON OFF ALM ON OFF</p> <p>Warning occurrence</p>

[Pr. PD43_Input device selection 11L (*DI11L)]

Initial value	Setting range	Ver.
00000000h	Refer to the relevant detail No.	Refer to the relevant detail No.

Select the device to be assigned to the input signal of the CN3-10/CN3-37 pin.

- When "00h" is set, PP/PP2 (Forward rotation pulse/Manual pulse generator) will be assigned.
- For sink interfaces, the device is assigned to the CN3-10 pin. For source interfaces, the device is assigned to the CN3-37 pin.

[Pr. PD43.0-1_Position control mode - Device selection]

Initial value	Setting range	Ver.
00h	00h to 00h	A0

The servo parameter is disabled.

[Pr. PD43.2-3_Speed control mode - Device selection]

Initial value	Setting range	Ver.
00h	Refer to the text	A0

Refer to the following for setting values.

☞ Page 92 [Pr. PD03_Input device selection 1L (*DI1L)]

[Pr. PD44_Input device selection 11H (*DI11H)]

Initial value	Setting range	Ver.
00003A00h	Refer to the relevant detail No.	Refer to the relevant detail No.

Select the device to be assigned to the input signal of the CN3-10/CN3-37 pin.

- When "00h" is set, PP/PP2 (Forward rotation pulse/Manual pulse generator) will be assigned.
- For sink interfaces, the device is assigned to the CN3-10 pin. For source interfaces, the device is assigned to the CN3-37 pin.

[Pr. PD44.0-1_Torque control mode - Device selection]

Initial value	Setting range	Ver.
00h	Refer to the text	A0

Refer to the following for setting values.

☞ Page 92 [Pr. PD03_Input device selection 1L (*DI1L)]

[Pr. PD45_Input device selection 12L (*DI12L)]

Initial value	Setting range	Ver.
00000000h	Refer to the relevant detail No.	Refer to the relevant detail No.

Select the device to be assigned to the input signal of the CN3-35/CN3-38 pin.

- When "00h" is set, NP/NP2 (Reverse rotation pulse/Manual pulse generator) will be assigned.
- For sink interfaces, the device is assigned to the CN3-35 pin. For source interfaces, the device is assigned to the CN3-38 pin.

[Pr. PD45.0-1_Position control mode - Device selection]

Initial value	Setting range	Ver.
00h	00h to 00h	A0

The servo parameter is disabled.

[Pr. PD45.2-3_Speed control mode - Device selection]

Initial value	Setting range	Ver.
00h	Refer to the text	A0

Refer to the following for setting values.

☞ Page 92 [Pr. PD03_Input device selection 1L (*DI1L)]

[Pr. PD46_Input device selection 12H (*DI12H)]

Initial value	Setting range	Ver.
00003B00h	Refer to the relevant detail No.	Refer to the relevant detail No.

Select the device to be assigned to the input signal of the CN3-35/CN3-38 pin.

- When "00h" is set, NP/NP2 (Reverse rotation pulse/Manual pulse generator) will be assigned.
- For sink interfaces, the device is assigned to the CN3-35 pin. For source interfaces, the device is assigned to the CN3-38 pin.

[Pr. PD46.0-1_Torque control mode - Device selection]

Initial value	Setting range	Ver.
00h	Refer to the text	A0

Refer to the following for setting values.

☞ Page 92 [Pr. PD03_Input device selection 1L (*DI1L)]

[Pr. PD47_Output device selection 7 (*DO7)]

Initial value	Setting range	Ver.
00000000h	Refer to the relevant detail No.	Refer to the relevant detail No.

Select functions of the CN3-13 pin and CN3-14 pin.

[Pr. PD47.0-1_Device selection]

Initial value	Setting range	Ver.
00h	Refer to the text	A0

Any output device can be assigned to the CN3-13 pin.

Refer to the following for setting values.

☞ Page 99 [Pr. PD23_Output device selection 1 (*DO1)]

[Pr. PD47.2-3_Device selection]

Initial value	Setting range	Ver.
00h	Refer to the text	A0

Any output device can be assigned to the CN3-14 pin.

Refer to the following for setting values.

☞ Page 99 [Pr. PD23_Output device selection 1 (*DO1)]

[Pr. PD60_DI pin polarity selection (*DIP)]

Initial value	Setting range	Ver.
00000000h	Refer to the relevant detail No.	Refer to the relevant detail No.

For DI pin numbers corresponding to each relevant servo parameter, refer to the following.

If this servo parameter is set incorrectly, [AL. 037 Parameter error] may occur.

Servo parameter number	Setting digit (BIN)	Name	Model	
			MR-J5-A	MR-J5-A-RJ
[Pr. PD60.0]	___x	DI pin polarity selection 1	CN3-15	CN3-15
	_x__	DI pin polarity selection 2	CN3-16	CN3-16
	_x__	DI pin polarity selection 3	CN3-17	CN3-17
	x___	DI pin polarity selection 4	CN3-18	CN3-18
[Pr. PD60.1]	___x	DI pin polarity selection 5	CN3-19	CN3-19
	_x__	DI pin polarity selection 6	CN3-41	CN3-41
	_x__	DI pin polarity selection 7	CN3-43	CN3-43
	x___	DI pin polarity selection 8	CN3-44	CN3-44
[Pr. PD60.2]	___x	DI pin polarity selection 9	CN3-45	CN3-45
	__x_ ^{*1}	DI pin polarity selection 10	CN3-10/CN3-37	CN3-10/CN3-37
	_x__ ^{*2}	DI pin polarity selection 11	CN3-35/CN3-38	CN3-35/CN3-38
	x___	For manufacturer setting	—	—

*1 This setting digit is enabled only when the CN3-10/CN3-37 pin is used as the DI pin. If using the servo amplifier with PP/PP2 assigned to the CN3-10/CN3-37 pin, this setting digit is disabled regardless of the setting value of the servo parameter.

*2 This setting digit is enabled only when the CN3-35/CN3-38 pin is used as the DI pin. If using the servo amplifier with NP/NP2 assigned to the CN3-35/CN3-38 pin, this setting digit is disabled regardless of the setting value of the servo parameter.

[Pr. PD60.0_DI pin polarity selection]

Initial value	Setting range	Ver.
0h	Refer to the text	A5

Select the DI pin polarity.

Setting digit (BIN)	Function
___x	DI pin polarity selection 1 0: ON with 24 V input 1: ON with 0 V input
__x_	DI pin polarity selection 2 0: ON with 24 V input 1: ON with 0 V input
_x__	DI pin polarity selection 3 0: ON with 24 V input 1: ON with 0 V input
x___	DI pin polarity selection 4 0: ON with 24 V input 1: ON with 0 V input

[Pr. PD60.1_DI pin polarity selection]

Initial value	Setting range	Ver.
0h	Refer to the text	A5

Select the DI pin polarity.

Setting digit (BIN)	Function
___x	DI pin polarity selection 5 0: ON with 24 V input 1: ON with 0 V input
__x_	DI pin polarity selection 6 0: ON with 24 V input 1: ON with 0 V input
_x__	DI pin polarity selection 7 0: ON with 24 V input 1: ON with 0 V input
x___	DI pin polarity selection 8 0: ON with 24 V input 1: ON with 0 V input

[Pr. PD60.2_DI pin polarity selection]

Initial value	Setting range	Ver.
0h	Refer to the text	A5

Select the DI pin polarity.

Setting digit (BIN)	Function
___x	DI pin polarity selection 9 0: ON with 24 V input 1: ON with 0 V input
__x_	DI pin polarity selection 10 0: ON with 24 V input 1: ON with 0 V input
_x__	DI pin polarity selection 11 0: ON with 24 V input 1: ON with 0 V input
x___	For manufacturer setting

1.6 Extension setting 2 servo parameters group ([Pr. PE_ _])

[Pr. PE01_Fully closed loop control function selection 1 (**FCT1)]

Initial value	Setting range	Ver.
00000000h	Refer to the relevant detail No.	Refer to the relevant detail No.

[Pr. PE01.0_Fully closed loop function selection]

Initial value	Setting range	Ver.
0h	Refer to the text	A5

Select the fully closed loop function.

This servo parameter is enabled when "1" (enabled (fully closed loop control mode)) is selected in [Pr. PA01.4 Fully closed loop operation mode selection].

If this servo parameter is set to "1" while [Pr. PA03.0 Absolute position detection system selection] has been set to "1" (enabled (absolute position detection system by DIO)), [AL. 037 Parameter error].

0: Always enabled

1: Switching by the input device CLD (fully closed loop selection)

CLD (fully closed loop selection) *1	Control method
OFF	Semi closed loop control
ON	Fully closed loop control

*1 This is always off if CLD (fully closed loop selection) is not assigned to an input device pin.

[Pr. PE01.4_Fully closed loop control - Droop pulse clear selection]

Initial value	Setting range	Ver.
0h	Refer to the text	D4

When switching between semi closed loop control and fully closed loop control is performed, select whether to clear droop pulses.

0: Enabled

1: Disabled

When the setting value of this servo parameter is "0" (enabled), switching the semi closed loop control to the fully closed loop control clears the load-side droop pulses. In addition, switching the fully closed loop control to the semi closed loop control clears the motor-side droop pulses. For these reasons, shock is reduced at switching between semi closed loop control and fully closed loop control.

When the setting value of this servo parameter is "1" (disabled), perform switching between semi closed loop control and fully closed loop control with the motor-side and the load-side connected. If the switching between semi closed loop control and fully closed loop control is performed when the motor-side and the load-side are not connected, the servo motor may cause an unexpected operation such as sudden acceleration.

[Pr. PE03_Fully closed loop control function selection 2 (*FCT2)]

Initial value	Setting range	Ver.
00000003h	Refer to the relevant detail No.	Refer to the relevant detail No.

[Pr. PE03.0_Fully closed loop control error - Detection function selection]

Initial value	Setting range	Ver.
3h	Refer to the text	A5

0: Disabled

1: Speed deviation error detection

2: Position deviation error detection

3: Speed deviation error detection and position deviation error detection

Refer to the following table for the combination with [Pr. PE03.1 Position deviation error - Detection method selection].

○: Error detection enabled —: Error detection disabled

Setting value of [Pr. PE03.1]	Setting value of [Pr. PE03.0]	Speed deviation error	Position deviation error		
			In servo-on state		In servo-off state
			With commands	No commands (= 0)	
0	0	—	—	—	—
0	1	○	—	—	—
0	2	—	○	○	○
0	3	○	○	○	○
1	0	—	—	—	—
1	1	○	—	—	—
1	2	—	—	○	—
1	3	○	—	○	—
2	0	—	—	—	—
2	1	○	—	—	—
2	2	—	—	○	○
2	3	○	—	○	○

[Pr. PE03.1_Position deviation error - Detection method selection]

Initial value	Setting range	Ver.
0h	Refer to the text	A5

0: Continuous detection

1: Detection only at stop (An error is detected if the command is "0".)

2: Detection only at stop 2 (An error is detected while in servo-off state or if the command is "0" while in servo-on state.)

Refer to the following servo parameter table for the combination with [Pr. PE03.0 Fully closed loop control error - Detection function selection].

☞ Page 109 [Pr. PE03.0_Fully closed loop control error - Detection function selection]

[Pr. PE03.3_Fully closed loop control error - Reset selection]

Initial value	Setting range	Ver.
0h	Refer to the text	A5

0: Reset disabled (only reset by cycling the power or by software reset enabled)

1: Reset enabled

[Pr. PE04_Fully closed loop control - Feedback pulse electronic gear 1 - Numerator (**FBN)]

Initial value	Setting range	Ver.
1	1 to 4294967295	A5

If using the fully closed loop control, set the electronic gear numerator to the servo motor encoder pulses.

Set the electronic gear so that the number of the servo motor encoder pulses per servo motor revolution is converted into load-side encoder resolution.

If the reduced electronic gear numerator exceeds 2147483648 (31 bits), [AL. 037] occurs.

[Pr. PE05_Fully closed loop control - Feedback pulse electronic gear 1 - Denominator (**FBD)]

Initial value	Setting range	Ver.
1	1 to 4294967295	A5

If using the fully closed loop control, set the electronic gear denominator to the servo motor encoder pulses.

Set the electronic gear so that the number of the servo motor encoder pulses per servo motor revolution is converted into load-side encoder resolution.

If the reduced electronic gear denominator exceeds 1073741824 (30 bits), [AL. 037] occurs.

[Pr. PE06_Fully closed loop control - Speed deviation error detection level (BC1)]

Initial value	Setting range	Ver.
400 [r/min]	1 to 50000	A5

Set the detection level for triggering [AL. 042.9 Fully closed loop control error based on speed deviation] of the fully closed loop control error detection. If the difference between the speed calculated by the servo motor encoder and the speed calculated by the load-side encoder exceeds the value of this servo parameter, the alarm occurs.

[Pr. PE07_Fully closed loop control - Position deviation error detection level (BC2)]

Initial value	Setting range	Ver.
100 [kpulse]	1 to 20000	A5

Set the detection level for triggering [AL. 042.8 Fully closed loop control error based on position deviation] of the fully closed loop control error detection. If the difference between the position of the servo motor encoder and the position of the load-side encoder exceeds the value of this servo parameter, the alarm occurs.

[Pr. PE08_Fully closed loop dual feedback filter (DUF)]

Initial value	Setting range	Ver.
10 [rad/s]	1 to 4500	A5

Set a dual feedback filter band.

[Pr. PE10_Fully closed loop function selection 3 (FCT3)]

Initial value	Setting range	Ver.
00000000h	Refer to the relevant detail No.	Refer to the relevant detail No.

[Pr. PE10.1_Fully closed loop control - Position deviation error detection level - Unit selection]

Initial value	Setting range	Ver.
0h	Refer to the text	A5

0: 1 kpulse unit

1: 1 pulse unit

[Pr. PE41_Function selection E-3 (EOP3)]

Initial value	Setting range	Ver.
00000000h	Refer to the relevant detail No.	Refer to the relevant detail No.

[Pr. PE41.0_Robust filter selection]

Initial value	Setting range	Ver.
0h	Refer to the text	A0

0: Disabled

1: Enabled

When this servo parameter is set to "1", [Pr. PB51.0 Machine resonance suppression filter 5 selection] cannot be used.

[Pr. PE41.6_Unbalanced torque offset setting selection]

Initial value	Setting range	Ver.
0h	Refer to the text	A0

0: Manual setting

1: Automatic setting

If "1" (automatic setting) has been set and friction estimation by the machine diagnosis function has completed for both the forward and reverse rotations, the value of [Pr. PE47 Unbalanced torque offset] will be set automatically according to the estimated friction value. After [Pr. PE47] is set automatically, this servo parameter changes to "0" (Manual setting). The value of [Pr. PE47] will not be set automatically and this servo parameter keeps the value "1" (automatic setting) until friction estimation completes for both the forward and reverse rotations.

[Pr. PE44_Lost motion compensation positive-side compensation value selection (LMCP)]

Initial value	Setting range	Ver.
0 [0.01 %]	0 to 30000	A0

Set the lost motion compensation for when negative speed switches to positive speed in increments of 0.01 % in relation to the rated torque as 100 %.

[Pr. PE45_Lost motion compensation negative-side compensation value selection (LMCN)]

Initial value	Setting range	Ver.
0 [0.01 %]	0 to 30000	A0

Set the lost motion compensation for when positive speed switches to negative speed in increments of 0.01 % in relation to the rated torque as 100 %.

[Pr. PE46_Lost motion filter setting (LMFLT)]

Initial value	Setting range	Ver.
0 [0.1 ms]	0 to 30000	A0

When "0" is set, the value is compensated with the compensation amount of the value that was set in [Pr. PE44] and [Pr. PE45]. When a value other than "0" is set, the torque is compensated with the high-pass filter output value of the set time constant, and the lost motion compensation will continue.

[Pr. PE47_Unbalanced torque offset (TOF)]

Initial value	Setting range	Ver.
0 [0.01 %]	-10000 to 10000	A0

Set this to cancel the unbalanced torque of a vertical axis. Set this in relation to the rated torque of the servo motor as 100 %. The torque offset does not need to be set for a machine that does not generate unbalanced torque. This servo parameter can be used in applications where an unbalanced torque is generated constantly, such as when a linear servo motor or direct drive motor is operated horizontally with tension applied in one direction.

The torque offset that has been set with this servo parameter is enabled in any control mode. In the torque mode, input commands taking the torque offset into account.

[Pr. PE48_Lost motion compensation function selection (*LMOP)]

Initial value	Setting range	Ver.
00000000h	Refer to the relevant detail No.	Refer to the relevant detail No.

[Pr. PE48.0_Lost motion compensation type selection]

Initial value	Setting range	Ver.
0h	Refer to the text	A0

0: Lost motion compensation disabled

1: Lost motion compensation enabled

[Pr. PE48.1_Lost motion compensation dead band unit setting]

Initial value	Setting range	Ver.
0h	Refer to the text	A0

0: 1 pulse unit

1: 1 kpulse unit

[Pr. PE49_Lost motion compensation timing (LMCD)]

Initial value	Setting range	Ver.
0 [0.1 ms]	0 to 30000	A0

Set the lost motion compensation timing in units of 0.1 ms.

The timing to perform the lost motion compensation function can be delayed by a set time.

[Pr. PE50_Lost motion compensation dead band (LMCT)]

Initial value	Setting range	Ver.
0 [pulse], [kpulse]	0 to 65535	A0

Set the lost motion compensation dead band. When the fluctuation of droop pulses is equal to or less than the setting value, the speed is recognized as 0. The setting unit can be changed with [Pr. PE48]. Set the servo parameter per encoder unit.

[Pr. PE51_Load-side encoder resolution setting (**EDV2)]

Initial value	Setting range	Ver.
0 [pulse]	0 to 4294967295	B2

When the fully closed loop control mode or the scale measurement function is enabled, the encoder is recognized as an A/B/Z-phase differential output rotary encoder by setting a load-side encoder resolution in this servo parameter with the A/B/Z-phase differential output rotary encoder connected to the load-side. At this time, the cycle counter is displayed. A load-side encoder resolution is the number of pulses output when the encoder is rotated by one revolution.

When "0" is set in this servo parameter, the encoder is recognized as an A/B/Z-phase differential output linear encoder. At this time, the Z-phase counter (the distance from the linear encoder home position (Z-phase)) is displayed after the Z-phase is passed.

When the resolution set in this servo parameter is either less than 2^{12} or greater than 2^{26} , [AL. 037 Parameter error] occurs. As shown in the following figures, the display of the load-side encoder information 1 monitor changes depending on the setting value of this servo parameter.

- When "0" is set in [Pr. PE51]

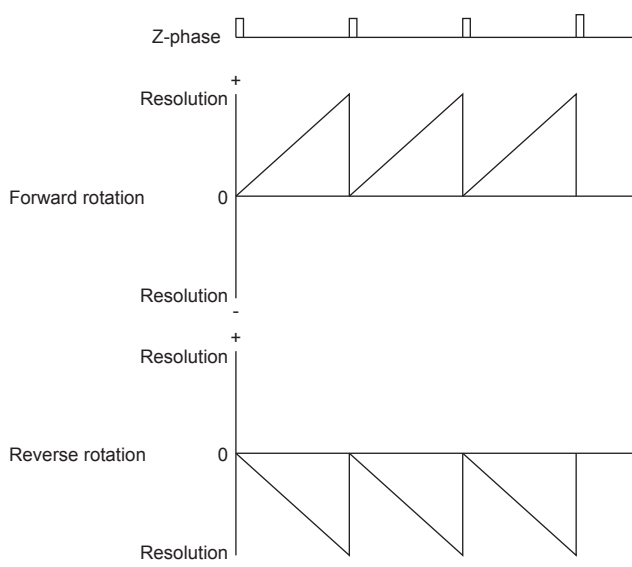

- When a load-side encoder resolution is set in [Pr. PE51]

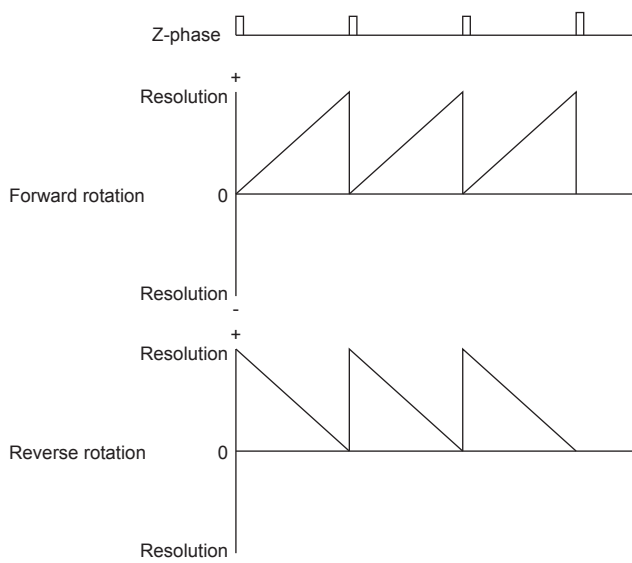

1.7 Extension setting 3 servo parameters group ([Pr. PF_ _])

[Pr. PF02_Function selection F-2 (*FOP2)]

Initial value	Setting range	Ver.
00000000h	Refer to the relevant detail No.	Refer to the relevant detail No.

[Pr. PF02.4_Memory writing frequency warning enable/disable selection]

Initial value	Setting range	Ver.
0h	Refer to the text	A0

Enable or disable [AL. 1F8.1 Memory writing frequency warning].

[AL. 1F8.1] indicates that the memory writing frequency has exceeded the guaranteed number of times.

If the servo amplifier continues to be used while the alarm is disabled with this servo parameter, the memory may be corrupted and restoration of the data, such as servo parameters, may fail.

0: Enabled

1: Disabled

[Pr. PF02.5_Memory free space warning enable/disable selection]

Initial value	Setting range	Ver.
0h	Refer to the text	A0

Select whether to enable or disable [AL. 1F8.2 Memory free space warning].

[AL. 1F8.2 Memory free space warning] indicates that the memory free space is running low.

If the servo amplifier continues to be used while the alarm is disabled with this servo parameter, [AL. 119.7 Memory free space 4-1] may occur and data restoration may fail.

0: Enabled

1: Disabled

[Pr. PF09_Function selection F-5 (*FOP5)]

Initial value	Setting range	Ver.
00000013h	Refer to the relevant detail No.	Refer to the relevant detail No.

[Pr. PF09.0_Electronic dynamic brake selection]

Initial value	Setting range	Ver.
3h	Refer to the text	A0

Enable or disable the electronic dynamic brake.

2: Disabled

3: Enabled only for specific servo motors

For specific servo motors, refer to "Precautions relating to the dynamic brake characteristics" in the User's Manual (Hardware).

[Pr. PF09.1_STO timing error selection]

Initial value	Setting range	Ver.
1h	Refer to the text	A0

Select whether [AL. 063 STO timing error] is detected.

0: Detected.

1: Not detected.

If the STO status is set at the servo motor speed shown below while "0" (detected) has been selected", [AL. 063 STO timing error] will be detected. The STO status means the status where STO1 or STO2 of CN8 has been turned off.

- Servo motor speed: 50 r/min or higher
- Linear servo motor speed: 50 mm/s or higher
- Direct drive motor speed: 5 r/min or higher

[Pr. PF15_Electronic dynamic brake operating time (DBT)]

Initial value	Setting range	Ver.
2000 [ms]	0 to 10000	A0

Set an operating time for the electronic dynamic brake.

[Pr. PF18_STO diagnosis error detection time (**STOD)]

Initial value	Setting range	Ver.
10 [s]	0 to 60	A0

Set the time from when the error of the STO input or STO circuit is detected until the occurrence of [AL. 068.1 STO signal mismatch error].

When "0" is set, [AL. 068.1] is not detected.

The safety level depends on the setting value of this servo parameter and whether STO input diagnosis is performed by TOFB output as shown in the following table.

Setting value	STO input diagnosis by TOFB output	Safety level
0	Execute	EN ISO 13849-1: 2015 Category 3 PL d, IEC 61508 SIL 2, and EN IEC 62061 maximum SIL 2
	Do not execute	
1 to 60	Execute	EN ISO 13849-1: 2015 Category 3 PL e, IEC 61508 SIL 3, and EN IEC 62061 maximum SIL 3
	Do not execute	EN ISO 13849-1: 2015 Category 3 PL d, IEC 61508 SIL 2, and EN IEC 62061 maximum SIL 2

When the STO function is not used with the short-circuit connector connected to the CN8 connector, the safety level does not change even after setting this servo parameter.

[Pr. PF21_Drive recorder switching time setting (DRT)]

Initial value	Setting range	Ver.
0 [s]	-1 to 32767	A0

Set the drive recorder switching time.

When communication is shut off during the use of a graph function, the function will be switched to the drive recorder function after the time set in this servo parameter has passed.

When any value of "10" to "32767" is set, the drive recorder function will be switched after the time set in this servo parameter has passed.

When any value of "0" to "9" is set, the drive recorder function will be switched after 10 s.

When "-1" is set, the drive recorder function is disabled.

[Pr. PF23_Vibration tough drive - Oscillation detection level (OSCL1)]

Initial value	Setting range	Ver.
20 [%]	0 to 100	A0

Set the oscillation detection level for readjusting the machine resonance suppression filter while the vibration tough drive is enabled.

When the oscillation level is higher than the setting value of this servo parameter, reset [Pr. PB13 Machine resonance suppression filter 1] or [Pr. PB15 Machine resonance suppression filter 2].

When "0" is set, the oscillation detection level is 20 %.

[Pr. PF24_Function selection F-9 (*FOP9)]

Initial value	Setting range	Ver.
00000000h	Refer to the relevant detail No.	Refer to the relevant detail No.

[Pr. PF24.0_Oscillation detection alarm selection]

Initial value	Setting range	Ver.
0h	Refer to the text	A0

Select the alarm output at oscillation detection.

Select whether to generate an alarm or a warning when an oscillation continues at a level set in [Pr. PF23 Vibration tough drive - Oscillation detection level].

This function is enabled regardless of the setting of [Pr. PA20.1 Vibration tough drive selection].

0: Alarm ([AL. 054 Oscillation detection])

1: Warning ([AL. 0F3.1 Oscillation detection warning])

2: Oscillation detection function disabled (oscillation detection not processed)

[Pr. PF25_SEMI-F47 function - Instantaneous power failure detection time (Instantaneous power failure tough drive detection time) (CVAT)]

Initial value	Setting range	Ver.
200 [ms]	30 to 500	A0

Set the time until the occurrence of [AL. 010.1 Voltage drop in the control circuit power].

To comply with SEMI-F47 standard, it is not required to change the time from the initial value (200 ms).

When the instantaneous power failure time exceeds 200 ms, and the instantaneous power failure voltage is less than 70 % of the rated input voltage, the power may be turned off normally even if a value larger than 200 ms is set in this servo parameter.

This function is disabled when [Pr. PA20.2 SEMI-F47 function selection] is set to "0" (disabled).

[Pr. PF31_Machine diagnosis function - Friction estimate area judgment speed at low speed (FRIC)]

Initial value	Setting range	Ver.
0 [r/min], [mm/s]	0 to 65535	A0

Set the servo motor speed to divide the friction estimation area between low-speed and high-speed in the friction estimation process of machine diagnosis.

When the maximum operation speed is under the rated speed, it is recommended to set half the value of the maximum operation speed.

When "0" is set, the judgment speed is half of the rated speed.

The setting value will be clamped at the permissible maximum speed.

By setting [Pr. PF51.6 Friction estimate area judgment speed setting] to "1" (automatic setting), this servo parameter value will be automatically calculated from the operation pattern during servo motor driving and overwrite the value.

Set a value larger than [Pr. PC17 Zero speed] for this servo parameter. If the value is equal to or lower than zero speed, the friction estimation process does not function.

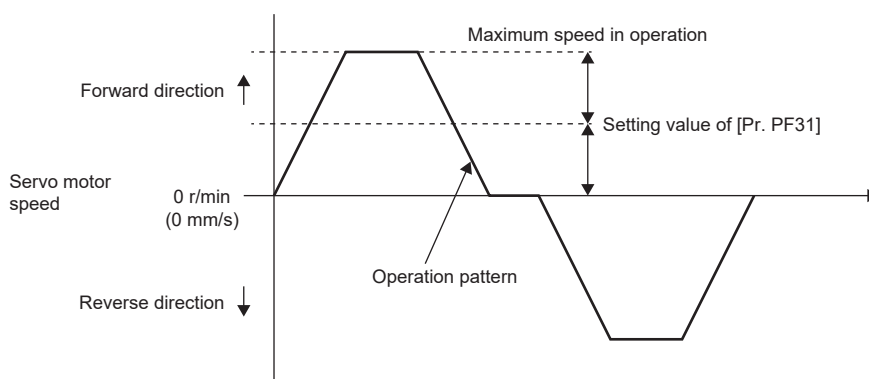

[Pr. PF32_Oscillation detection alarm time (*VIBT)]

Initial value	Setting range	Ver.
50 [100 ms]	1 to 50	A0

Set the time from when oscillation is detected until the occurrence of an alarm or warning.

When an oscillation detection alarm or warning is generated during normal operation, set a value larger than "10" (1000 ms).

[Pr. PF49_Friction failure prediction - Compensation coefficient 1 (TSL)]

Initial value	Setting range	Ver.
0 [0.0001 %/°C]	-32768 to 32767	A0

Set compensation coefficient 1 to compensate the dynamic friction being used for the friction failure prediction.

When the friction failure prediction warning selection is set to the automatic threshold setting, the value will be calculated automatically from the estimated dynamic friction.

When performing threshold manual setting on an equipment for which the threshold setting has been made once, set the value that has been calculated by the threshold automatic setting.

Setting this servo parameter decreases the possibility of erroneous detection of friction failure prediction, even with the manual threshold setting.

[Pr. PF50_Friction failure prediction - Compensation coefficient 2 (TIC)]

Initial value	Setting range	Ver.
0 [0.1 %]	-10000 to 10000	A0

Set compensation coefficient 2 to compensate the dynamic friction being used for the friction failure prediction.

When the friction failure prediction warning selection is set to the automatic threshold setting, the value will be calculated automatically from the estimated dynamic friction.

When performing threshold manual setting on an equipment for which the threshold setting has been made once, set the value that has been calculated by the threshold automatic setting.

Setting this servo parameter decreases the possibility of erroneous detection of friction failure prediction, even with the manual threshold setting.

[Pr. PF51_Machine diagnosis function selection (*MFP)]

Initial value	Setting range	Ver.
00000000h	Refer to the relevant detail No.	Refer to the relevant detail No.

[Pr. PF51.0_Friction failure prediction warning selection]

Initial value	Setting range	Ver.
0h	Refer to the text	A0

0: Disabled

1: Enabled (automatic threshold setting)

2: Enabled (manual threshold setting)

3: Threshold reset

When "2" is set, if the dynamic friction exceeds the set threshold, [AL. 0F7.2 Friction failure prediction warning] will occur.

When "3" is set, the setting of the servo parameter will change to "1" automatically after the threshold is reset.

[Pr. PF51.1_Vibration failure prediction warning selection]

Initial value	Setting range	Ver.
0h	Refer to the text	A0

0: Disabled

1: Enabled (automatic threshold setting)

2: Enabled (manual threshold setting)

3: Threshold reset

When "2" is set, if the vibration level exceeds the set threshold, [AL. 0F7.1 Vibration failure prediction warning] will occur.

When "3" is set, the setting of the servo parameter will change to "1" automatically after the threshold is reset.

[Pr. PF51.2_Servo motor total travel distance failure prediction warning selection]

Initial value	Setting range	Ver.
0h	Refer to the text	A0

0: Disabled

1: Enabled

2: Servo motor total travel distance reset

When "1" is set, if the value of the servo motor total travel distance + [Pr. PF58 Servo motor total travel distance offset] exceeds the value of [Pr. PF53 Failure prediction - Servo motor total travel distance], [AL. 0F7.3 Servo motor total travel distance failure prediction warning] will occur.

When "2" is set, the setting of the servo parameter will change to "1" automatically after the servo motor total travel distance is reset.

[Pr. PF51.5_Static friction failure prediction warning selection]

Initial value	Setting range	Ver.
0h	Refer to the text	A0

0: Disabled

1: Automatic threshold setting

2: Manual threshold setting

3: Threshold reset

When "2" is set, if the static friction exceeds the set threshold, [AL. 0F7.5 Static friction failure prediction warning] occurs.

When "3" is set, the setting of the servo parameter will change to "1" automatically after the threshold is reset.

[Pr. PF51.6_Friction estimate area judgment speed setting]

Initial value	Setting range	Ver.
0h	Refer to the text	A0

Select the setting method of "Machine diagnosis function - Friction estimate area judgment speed at low speed".

0: Manual setting

1: Automatic setting

When "1" (automatic setting) is set, [Pr. PF31 Machine diagnosis function - Friction estimate area judgment speed at low speed] will be calculated according to the servo motor operation pattern. After the calculation, [Pr. PF31] is rewritten to the calculation result, and the servo parameter will change to "0" (manual setting).

When "1" (automatic setting) is set, friction estimation stops.

[Pr. PF52_Machine failure prediction servo parameter (MFPP)]

Initial value	Setting range	Ver.
0000000h	Refer to the relevant detail No.	Refer to the relevant detail No.

[Pr. PF52.0_Friction failure prediction - Threshold multiplication]

Initial value	Setting range	Ver.
0h	0h to Fh	A0

Set a multiplying factor for calculating the threshold used in the friction failure prediction function.

The smaller the multiplying factor for the friction failure prediction threshold, the smaller the threshold used for friction failure prediction, which makes it easier to predict failure earlier, but also increases the possibility of erroneous detection.

When "0" is set, the threshold multiplying factor is 5.

[Pr. PF52.1_Vibration failure prediction - Threshold multiplication]

Initial value	Setting range	Ver.
0h	0h to Fh	A0

Set a multiplying factor for calculating the threshold used in the vibration failure prediction function.

The smaller the multiplying factor for the vibration failure prediction threshold, the smaller the threshold used for vibration failure prediction, which makes it easier to predict failure earlier, but also increases the possibility of erroneous detection.

When "0" is set, the threshold multiplying factor is 5.

[Pr. PF52.2_Friction failure prediction - Dynamic friction selection]

Initial value	Setting range	Ver.
0h	Refer to the text	A0

Select the dynamic friction to use for friction failure prediction.

0: Automatic setting

1: Dynamic friction at forward rotation torque (at rated speed)

2: Dynamic friction at reverse rotation torque (at rated speed)

3: Absolute value average at forward rotation/reverse rotation torque

When set to "0", the value changes to any of "1" to "3", depending on the operation pattern.

[Pr. PF52.4_Static friction failure prediction - Threshold multiplication]

Initial value	Setting range	Ver.
0h	0h to Fh	A0

Set a multiplying factor for calculating the threshold used in the static friction failure prediction function.

Setting a small threshold multiplication for static friction failure prediction will decrease the threshold used for static friction failure prediction. Thus, this will enable the prediction of a failure at an early stage, but will increase the possibility of erroneously detecting a failure.

When "0" is set, the threshold multiplying factor is 5.

[Pr. PF52.5_Static friction failure prediction - Static friction selection]

Initial value	Setting range	Ver.
0h	Refer to the text	A0

Select the static friction setting to use for static friction failure prediction.

0: Automatic setting

1: At forward rotation torque

2: At reverse rotation torque

3: Average at forward rotation/reverse rotation torque

When set to "0", the value changes to any of "1" to "3", depending on the operation pattern.

[Pr. PF53_Failure prediction - Servo motor total travel distance (FPMT)]

Initial value	Setting range	Ver.
0 [10 rev], [m]	0 to 4294967295	A0

Set a servo motor total travel distance required for determining the threshold used in the friction failure prediction function and the servo motor total travel distance failure prediction function.

When Servo motor total travel distance exceeds 1/2 of "Failure prediction - Servo motor total travel distance", the threshold will be automatically calculated for the friction failure prediction function.

When [Pr. PF51.2 Servo motor total travel distance failure prediction warning selection] is set to "1" (enabled), if the servo motor total travel distance + the value of [Pr. PF58 Servo motor total travel distance offset] exceeds the setting value of this servo parameter, [AL. 0F7.3 Servo motor total travel distance failure prediction warning] occurs.

[Pr. PF54_Friction failure prediction - Average characteristics (PAV)]

Initial value	Setting range	Ver.
0 [0.1 %]	-10000 to 10000	A0

Set the friction torque average value at the rated speed.

This servo parameter is enabled when [Pr. PF51 Friction failure prediction warning selection] is set to "2" (enabled (manual threshold setting)).

When [Pr. PF51 Friction failure prediction warning selection] is set to "1" (enabled (automatic threshold setting)), the value will be calculated automatically from the estimated friction torque at rated speed.

[Pr. PF55_Friction failure prediction - Standard deviation (PSD)]

Initial value	Setting range	Ver.
0 [0.1 %]	0 to 20000	A0

Set the friction torque standard deviation at the rated speed.

This servo parameter is enabled when [Pr. PF51 Friction failure prediction warning selection] is set to "2" (enabled (manual threshold setting)).

When [Pr. PF51 Friction failure prediction warning selection] is set to "1" (enabled (automatic threshold setting)), the value will be calculated automatically from the estimated friction torque at rated speed.

[Pr. PF56_Vibration failure prediction - Average characteristics (VAV)]

Initial value	Setting range	Ver.
0 [0.1 %]	0 to 10000	A0

Set a vibration level average during servo motor operation.

This servo parameter is enabled when [Pr. PF51 Friction failure prediction warning selection] is set to "2" (enabled (manual threshold setting)).

When [Pr. PF51 Friction failure prediction warning selection] is set to "1" (enabled (automatic threshold setting)), the value will be calculated automatically from the estimated friction torque at rated speed.

[Pr. PF57_Vibration failure prediction - Standard deviation (VSD)]

Initial value	Setting range	Ver.
0 [0.1 %]	0 to 20000	A0

Set the vibration level standard deviation during servo motor operation.

This servo parameter is enabled when [Pr. PF51 Friction failure prediction warning selection] is set to "2" (enabled (manual threshold setting)).

When [Pr. PF51 Friction failure prediction warning selection] is set to "1" (enabled (automatic threshold setting)), the value will be calculated automatically from the estimated friction torque at rated speed.

[Pr. PF58_Servo motor total travel distance offset (TMO)]

Initial value	Setting range	Ver.
0 [10 rev], [m]	0 to 4294967295	A0

Set an offset value for servo motor total travel distance.

After the equipment is replaced, set this servo parameter.

[Pr. PF62_Function selection F-14 (FOP14)]

Initial value	Setting range	Ver.
00000000h	Refer to the relevant detail No.	Refer to the relevant detail No.

[Pr. PF62.0_Backlash estimation unit selection]

Initial value	Setting range	Ver.
0h	Refer to the text	D0

Select the unit for "travel distance at backlash estimation" which is to be automatically set in the backlash estimation function.

0: Command pulse unit

1: Servo motor encoder pulse unit

A time-out will occur at execution of the backlash estimation function depending on the setting values for the electronic gear ([Pr. PA06 Electronic gear numerator]/[Pr. PA07 Electronic gear denominator]). When a time-out occurs, set this servo parameter to "1".

When this servo parameter is "0", the servo motor rotation amount is as follows.

Servo motor rotation amount = travel distance at backlash estimation × ([Pr. PA06]/[Pr. PA07]) [rev]

For "travel distance at backlash estimation", refer to "Gear failure diagnosis function" in the User's Manual (Function).

[Pr. PF63_Function selection F-15 (*FOP15)]

Initial value	Setting range	Ver.
00000000h	Refer to the relevant detail No.	Refer to the relevant detail No.

[Pr. PF63.0_[AL. 01A.5 Servo motor combination error 3] selection]

Initial value	Setting range	Ver.
0h	Refer to the text	D0

Select whether to enable or disable [AL. 01A.5 Servo motor combination error 3] for when a servo motor with a batteryless absolute position encoder is replaced.

0: Enabled

1: Disabled

With "1" (disabled) selected, connecting a servo motor that had not been connected at the startup of the absolute position detection system triggers [AL. 025.1 Servo motor encoder absolute position erased] instead of [AL. 01A.5 Servo motor combination error 3].

Connecting a servo motor other than the ones with a batteryless absolute position encoder triggers [AL. 01A.5].

[Pr. PF66_Gear setting for backlash estimation (BLG)]

Initial value	Setting range	Ver.
00000000h	Refer to the relevant detail No.	Refer to the relevant detail No.

[Pr. PF66.0-3_Gear for backlash estimation - Numerator]

Initial value	Setting range	Ver.
0000h	0000h to FFFFh	A0

Set the gear ratio numerator of the gear connected to the servo motor in hexadecimal. If multiple gears are connected to the servo motor, set the gear ratio up to where the load is applied.

If the gear ratio numerator and the denominator cannot be expressed by numbers up to "2¹⁶-1", round up the gear ratio and set a value equal to or less than "2¹⁶-1" for both the numerator and the denominator.

[Pr. PF66.4-7_Gear for backlash estimation - Denominator]

Initial value	Setting range	Ver.
0000h	0000h to FFFFh	A0

Set the gear ratio denominator of the gear connected to the servo motor in hexadecimal. If multiple gears are connected to the servo motor, set the gear ratio up to where the load is applied.

If the gear ratio numerator and the denominator cannot be expressed by numbers up to "2¹⁶-1", round up the gear ratio and set a value equal to or less than "2¹⁶-1" for both the numerator and the denominator.

[Pr. PF67_Backlash nominal value (BLN)]

Initial value	Setting range	Ver.
0 [0.01 degree]	0 to 3600000	A0

To set the threshold for gear failure prediction, a backlash nominal value must be set. Input a backlash value presented by the manufacturer of the gear connected to the servo motor.

When [Pr. PF66.0-3 Gear for backlash estimation - Numerator] or [Pr. PF66.4-7 Gear for backlash estimation - Denominator] is set to "0", input the backlash nominal value after converting the value into the rotation angle on the servo motor side.

When [Pr. PF66.0-3] or [Pr. PF66.4-7] is set to a value other than "0", input a value considering the gear ratio for backlash estimation.

When the setting value of this servo parameter is "0", even if backlash estimation is performed, [AL. 0F7 Machine diagnosis warning] will not be generated.

[Pr. PF68_Backlash threshold multiplication (BLTT)]

Initial value	Setting range	Ver.
0	0 to 3600000	A0

Set the threshold multiplication that will be used for setting the threshold for gear failure prediction. The threshold used for the gear failure prediction is expressed by the following equation.

Backlash threshold = [Pr. PF67 Backlash nominal value]/100 × [Pr. PF68 Backlash threshold multiplication]/10

When the setting value of this servo parameter is "0", a value twice the value of [Pr. PF67 Backlash nominal value]/100 is set as the backlash threshold.

When the backlash threshold is "0", [AL. 0F7 Machine diagnosis warning] will not be generated even if the backlash estimation is performed.

[Pr. PF69_Static friction failure prediction - Average characteristics (SPAV2)]

Initial value	Setting range	Ver.
0 [0.1 %]	0 to 10000	A0

Set a static friction torque average.

This servo parameter is enabled when [Pr. PF51.5 Static friction failure prediction warning selection] is set to "2" (manual threshold setting).

When [Pr. PF51.5 Static friction failure prediction warning selection] is set to "1" (automatic threshold setting), the value will be calculated automatically from the estimated static friction torque.

[Pr. PF70_Static friction failure prediction - Standard deviation (SPSD2)]

Initial value	Setting range	Ver.
0 [0.1 %]	0 to 20000	A0

Set a standard deviation of static friction torque.

This servo parameter is enabled when [Pr. PF51.5 Static friction failure prediction warning selection] is set to "2" (manual threshold setting).

When [Pr. PF51.5 Static friction failure prediction warning selection] is set to "1" (automatic threshold setting), the value will be calculated automatically from the estimated friction torque at rated speed.

[Pr. PF71_Belt failure prediction function selection (BFP)]

Initial value	Setting range	Ver.
00000000h	Refer to the relevant detail No.	Refer to the relevant detail No.

[Pr. PF71.0_Belt tension deterioration prediction function selection]

Initial value	Setting range	Ver.
0h	Refer to the text	A0

0: Disabled

1: Execute only belt tension estimation

2: Belt tension deterioration prediction function enabled

After the equipment goes into full-scale operation, enable the belt tension deterioration prediction function.

[Pr. PF71.1_Belt tension deterioration prediction friction selection]

Initial value	Setting range	Ver.
0h	Refer to the text	A0

Select a static friction setting used for belt tension deterioration prediction.

0: Automatic setting

1: At forward rotation torque

2: At reverse rotation torque

3: Average at forward rotation/reverse rotation torque

When set to "0", the value changes to any of "1" to "3", depending on the operation pattern.

[Pr. PF72_Belt tension on installation (SBT)]

Initial value	Setting range	Ver.
0 [0.1 N]	0 to 1000000	A0

Set a belt tension for when the belt is attached to the equipment. The servo parameter indicates the reference belt tension threshold used in the belt diagnosis function.

[Pr. PF73_Belt tension when extended (ABT)]

Initial value	Setting range	Ver.
0 [0.1 N]	0 to 1000000	A0

After the equipment is operated, set a belt tension for when the belt stretches or for when the belt is looser than at the time of the attachment. After the belt has been attached to the equipment, the time taken for the belt to stretch depends on the belt type. For the time taken for the belt to stretch, refer to the catalog or other documents from the manufacturer.

The belt tension deterioration prediction function is disabled when the setting is: [Pr. PF72 Belt tension on installation] < [Pr. PF73 Belt tension when extended].

[Pr. PF74_Static friction during installation (SSF)]

Initial value	Setting range	Ver.
0 [0.1 %]	0 to 10000	A0

Set a static friction for when the belt is attached to the equipment. Set the static friction with any of the following values estimated by the friction estimation function depending on the value of [Pr. PF71.1 Belt tension deterioration prediction friction selection]: static friction at forward rotation, static friction at reverse rotation, or the average of the estimated frictions.

[Pr. PF75_Static friction when extended (ASF)]

Initial value	Setting range	Ver.
0 [0.1 %]	0 to 10000	A0

Set a static friction for when the belt stretches or for when the belt is looser than at the time of the attachment. Set the static friction with any of the following values estimated by the friction estimation function depending on the value of [Pr. PF71.1 Belt tension deterioration prediction friction selection]: static friction at forward rotation, static friction at reverse rotation, or the average of the estimated frictions.

The belt tension deterioration prediction function is disabled when the setting is: [Pr. PF74 Static friction during installation] < [Pr. PF75 Static friction when extended].

[Pr. PF76_Belt tension irregular threshold (BTS)]

Initial value	Setting range	Ver.
0 [0.1 %]	0 to 1000	A0

Set a threshold to generate [AL. 0F7 Machine diagnosis warning]. Set this servo parameter as a percentage of [Pr. PF72 Belt tension on installation]. When using the belt diagnosis function, input a value other than "0".

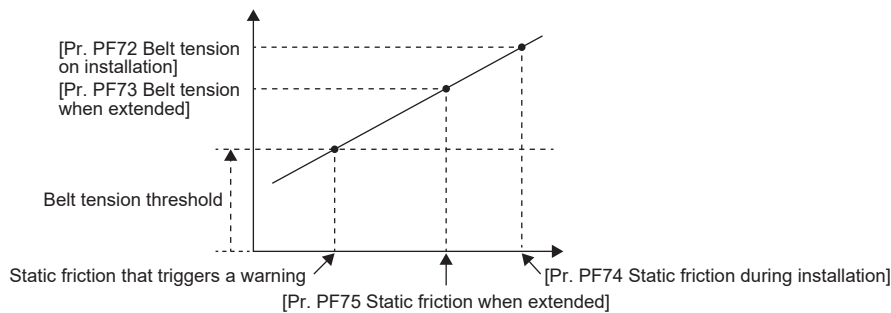

Belt tension threshold = [Pr. PF76 Belt tension irregular threshold]/100 × [Pr. PF72 Belt tension on installation]

[Pr. PF80_Drive recorder - Operation condition selection (DRMC)]

Initial value	Setting range	Ver.
00000000h	Refer to the relevant detail No.	Refer to the relevant detail No.

[Pr. PF80.0_Drive recorder - Operation mode selection]

Initial value	Setting range	Ver.
0h	Refer to the text	A0

0: Automatic setting mode

1: Manual setting mode

When "0" (automatic setting mode) is set, the setting values of [Pr. PF81 Drive recorder - Sampling operation selection] to [Pr. PF94 Drive recorder - Digital channel setting 4] are disabled. The drive recorder will be activated automatically at the same time as an alarm occurs.

When obtaining desired analog data from the drive recorder, set this servo parameter to "1" (manual setting mode) to set trigger conditions and sampling cycle, and then start sampling with [Pr. PF81.0 Drive recorder - Sampling start selection]. To disable the drive recorder, set [Pr. PF21 Drive recorder switching time setting] to "-1" (drive recorder function disabled).

[Pr. PF80.2-3_Drive recorder - Sampling cycle selection]

Initial value	Setting range	Ver.
00h	Refer to the text	A0

Set the sampling cycle of the drive recorder.

When [Pr. PF80.0] is set to "0" (automatic setting mode), the setting value of this servo parameter is disabled.

Setting value	8 kHz class
00	Automatic (250 μ s)
05	250 μ s
06	500 μ s
07	1 ms
08	2 ms
09	4 ms
0A	8 ms
0B	16 ms
0C	32 ms
0D	64 ms
0E	128 ms
0F	256 ms
10	512 ms
11	1.024 s

[Pr. PF81_Drive recorder - Sampling operation selection (DRMS)]

Initial value	Setting range	Ver.
00000000h	Refer to the relevant detail No.	Refer to the relevant detail No.

[Pr. PF81.0_Drive recorder - Sampling start selection]

Initial value	Setting range	Ver.
0h	Refer to the text	A0

Set this servo parameter to start drive recorder sampling.

When [Pr. PF80.0 Drive recorder - Operation mode selection] is set to "0" (automatic setting mode), the setting value of the servo parameter is disabled.

When this servo parameter is set to "1" or "2", if the settings of [Pr. PF80.2-3 Drive recorder - Sampling cycle selection] and [Pr. PF82 Drive recorder - Trigger operation selection] to [Pr. PF94 Drive recorder - Digital channel setting 4] are changed, the changed settings are not applied to the drive recorder. To apply the settings, cycle the power, reset the software, or set this servo parameter to "0" (stop sampling), then set "1" or "2" again.

The storage area of the servo amplifier has a limit for the number of writings. If the trigger conditions that have been set in [Pr. PF82] are frequently met, do not continue using this servo parameter when it is set to "2" (continuous sampling).

0: 0: Stop sampling

1: Start a single sampling

2: Start a consecutive sampling

When "1" (start a single sampling) is set, if the trigger conditions are fulfilled after sampling starts, the drive recorder will operate to save data once. After the data has been saved, this servo parameter will be "0" automatically.

When "2" (start a consecutive sampling) is set, if the trigger conditions are fulfilled after sampling starts, the drive recorder will operate to save data. After that, sampling will start again.

[Pr. PF82_Drive recorder - Trigger operation selection (DRTM)]

Initial value	Setting range	Ver.
00000000h	Refer to the relevant detail No.	Refer to the relevant detail No.

[Pr. PF82.0_Drive recorder - Trigger mode selection]

Initial value	Setting range	Ver.
0h	Refer to the text	A0

Select the trigger mode for the drive recorder.

When [Pr. PF80.0 Drive recorder - Operation mode selection] is set to "0" (automatic setting mode), the setting value of the servo parameter is disabled.

0: Alarm trigger

1: Analog trigger/digital trigger

When "0" (alarm trigger) is set, trigger settings other than [Pr. PA23 Drive recorder desired alarm trigger setting] and [Pr. PF84.4-5 Drive recorder - Trigger position setting] are disabled. Refer to the following table for the unavailable servo parameters.

Servo parameter	Name
PF82.1	Drive recorder - Trigger binding condition selection
PF82.2	Drive recorder - Trigger operation selection 1
PF82.3	Drive recorder - Trigger operation selection 2
PF84.0-1	Drive recorder - Trigger channel selection 1
PF84.2-3	Drive recorder - Trigger channel selection 2
PF85	Drive recorder - Trigger level setting 1
PF86	Drive recorder - Trigger level setting 2

[Pr. PF82.1_Drive recorder - Trigger binding condition selection]

Initial value	Setting range	Ver.
0h	Refer to the text	A0

Select the trigger binding condition for the drive recorder.

When this servo parameter is set to "0" (disabled), the settings of [PF84.2-3 Drive recorder - Trigger channel selection 2] and [PF86 Drive recorder - Trigger level setting 2] are disabled.

When [Pr. PF80.0 Drive recorder - Operation mode selection] is set to "0" (automatic setting mode), or [Pr. PF80.0] is set to "1" and [Pr. PF82.0 Drive recorder - Trigger mode selection] is set to "0" (alarm trigger), the setting value of this servo parameter is disabled.

0: Disabled

1: Logical AND of trigger signals

2: Logical OR of trigger signals

[Pr. PF82.2_Drive recorder - Trigger operation selection 1]

Initial value	Setting range	Ver.
0h	Refer to the text	A0

Select whether sampling starts when the signal output for the drive recorder channel set in [Pr. PF84.0-1 Drive recorder - Trigger channel selection 1] exceeds or falls below the set trigger level.

When [Pr. PF80.0 Drive recorder - Operation mode selection] is set to "0" (automatic setting mode), or [Pr. PF80.0] is set to "1" and [Pr. PF82.0] is set to "0" (alarm trigger), the setting value of this servo parameter is disabled.

0: Rising

1: Falling

[Pr. PF82.3_Drive recorder - Trigger operation selection 2]

Initial value	Setting range	Ver.
0h	Refer to the text	A0

Select whether sampling starts when the signal output for the drive recorder channel set in [Pr. PF84.2-3 Drive recorder - Trigger channel selection 2] exceeds or falls below the set trigger level.

The servo parameter is disabled in the following conditions.

- [Pr. PF80.0 Drive recorder - Operation mode selection] is set to "0" (automatic setting mode)
- [Pr. PF82.0 Drive recorder - Trigger mode selection] is set to "0" (alarm trigger)
- [Pr. PF82.1 Drive recorder - Trigger binding condition selection] is set to "0" (disabled)

0: Rising

1: Falling

[Pr. PF84_Drive recorder - Trigger channel selection (DRTC)]

Initial value	Setting range	Ver.
005A8101h	Refer to the relevant detail No.	Refer to the relevant detail No.

[Pr. PF84.0-1_Drive recorder - Trigger channel selection 1]

Initial value	Setting range	Ver.
01h	Refer to the text	A0

Set the trigger channel No. 1 of the drive recorder.

The servo parameter is disabled in the following conditions.

- [Pr. PF80.0 Drive recorder - Operation mode selection] is set to "0" (automatic setting mode)
- [Pr. PF82.0 Drive recorder - Trigger mode selection] is set to "0" (alarm trigger)

Setting value	Meaning
01	Analog channel 1
02	Analog channel 2
03	Analog channel 3
04	Analog channel 4
05	Analog channel 5
06	Analog channel 6
07	Analog channel 7
81	Digital channel 1
82	Digital channel 2
83	Digital channel 3
84	Digital channel 4
85	Digital channel 5
86	Digital channel 6
87	Digital channel 7
88	Digital channel 8

[Pr. PF84.2-3_Drive recorder - Trigger channel selection 2]

Initial value	Setting range	Ver.
81h	Refer to the text	A0

Set the trigger channel No. 2 of the drive recorder. The setting value is the same as that of [Pr. PF84.0-1].

The servo parameter is disabled in the following conditions.

- [Pr. PF80.0 Drive recorder - Operation mode selection] is set to "0" (automatic setting mode)
- [Pr. PF82.0 Drive recorder - Trigger mode selection] is set to "0" (alarm trigger)
- [Pr. PF82.1 Drive recorder - Trigger binding condition selection] is set to "0" (disabled)

[Pr. PF84.4-5_Drive recorder - Trigger position setting]

Initial value	Setting range	Ver.
5Ah	00h to 6Fh	A0

Convert trigger position 1 (0 % to 100 % of the total sampling time of the drive recorder) to a hexadecimal value, and set the value. When trigger position 1 exceeds 100 %, the value will be clamped to 100 %.

For example, to set the trigger position to 30 %, set "1Eh" in this servo parameter.

[Pr. PF85_Drive recorder - Trigger level setting 1 (DRTL1)]

Initial value	Setting range	Ver.
0	-2147483648 to 2147483647	A0

Set the trigger level of trigger channel No. 1 of the drive recorder in decimal.

Set the value considering the decimal point.

For example, if setting a torque of 100.0 [%] for the trigger level, set this servo parameter to "1000" because the torque unit is [0.1 %].

The servo parameter is disabled in the following conditions.

- [Pr. PF80.0 Drive recorder - Operation mode selection] is set to "0" (automatic setting mode)
- [Pr. PF80.0] is set to "1" (manual setting mode) and [Pr. PF82.0 Drive recorder - Trigger mode selection] is set to "0" (alarm trigger)
- A digital channel is set in the first trigger of [Pr. PF84.0-1 Drive recorder - Trigger channel selection 1]

[Pr. PF86_Drive recorder - Trigger level setting 2 (DRTL2)]

Initial value	Setting range	Ver.
0	-2147483648 to 2147483647	A0

Set the trigger level of trigger channel No. 2 of the drive recorder in decimal.

Set the value considering the decimal point.

For example, if setting a torque of 100.0 [%] for the trigger level, set this servo parameter to "1000" because the torque unit is [0.1 %].

The servo parameter is disabled in the following conditions.

- [Pr. PF80.0 Drive recorder - Operation mode selection] is set to "0" (automatic setting mode)
- [Pr. PF80.0] is set to "1" (manual setting mode) and [Pr. PF82.0 Drive recorder - Trigger mode selection] is set to "0" (alarm trigger)
- [Pr. PF82.1 Drive recorder - Trigger binding condition selection] is set to "0" (disabled)
- A digital channel is set in the second trigger of [Pr. PF84.2-3 Drive recorder - Trigger channel selection 2]

[Pr. PF87_Drive recorder - Analog channel setting 1 (DRAC1)]

Initial value	Setting range	Ver.
00020201h	Refer to the relevant detail No.	Refer to the relevant detail No.

[Pr. PF87.0-2_Drive recorder - Analog channel 1 selection]

Initial value	Setting range	Ver.
201h	Refer to the text	A0

Select the data to be assigned to analog channel 1 of the drive recorder.

The servo parameter is disabled in the following conditions.

- [Pr. PF80.0 Drive recorder - Operation mode selection] = "0" (automatic setting mode)

Refer to the following table for setting values.

Values not listed below are undefined. Only set the values that are listed in the following table.

Setting value	Data type	Unit *1	Category
000	No assigned function	—	—
001	Servo motor speed	r/min	16-bit data
002	Torque/instantaneous torque	0.1 %	
003	Current command	0.1 %	
004	Command pulse frequency	kpulse/s	
005	Command pulse frequency (speed unit)	r/min	
007	Droop pulses (1 pulse unit)	pulse	
008	Speed command	r/min	
009	Bus voltage	V	
00C	Effective load ratio	0.1 %	
00D	Regenerative load ratio	0.1 %	
00E	Position within one-revolution	16 pulses	
00F	ABS counter	rev	
010	Load to motor inertia ratio	0.01 multiplier	
011	Torque equivalent to disturbance	0.1 %	
012	Overload alarm margin	0.1 %	
014	Settling time	ms	
015	Overshoot amount	pulse	
01C *2	Load-side encoder droop pulses (1 pulse unit)	pulse	
01E *2	Motor-side/load-side position deviation (1 pulse unit)	pulse	
020 *2	Motor-side/load-side speed deviation	r/min	
021	Servo motor speed (unit of 0.1 r/min)	0.1 r/min	
022	Command pulse frequency (speed unit of 0.1 r/min)	0.1 r/min	
023	Speed command (unit of 0.1 r/min)	0.1 r/min	
024	Torque command	0.1 %	
025	Speed limit value	r/min	
026	Speed limit value (unit of 0.1 r/min)	0.1 r/min	
035	Internal temperature of encoder	°C	
03B	Load-side encoder information 1	16 pulses	
03C	Load-side encoder information 2	rev	
049	Operation mode	LSB	
04C *3	U-phase current feedback (unit of the rated current)	0.1 %	
04D *3	V-phase current feedback (unit of the rated current)	0.1 %	
04E *3	W-phase current feedback (unit of the rated current)	0.1 %	

Setting value	Data type	Unit *1	Category
201	Servo motor speed +	0.1 r/min	32-bit data
202	Command pulse frequency +	kpulse/s	
203	Command pulse frequency (speed unit) +	0.1 r/min	
204	Droop pulses (1 pulse unit) +	pulse	
205	Speed command +	0.1 r/min	
206	Position within one-revolution +	pulse	
207	Load-side encoder information 1 +	pulse	
208	Load-side encoder information 2 +	rev	
209	Load-side droop pulses +	pulse	
20B	Feedback position +	pulse	
20C	Excessive error alarm margin +	pulse	
218	Droop pulses (100 pulses unit) +	100 pulses	
219*2	Load-side encoder droop pulses (100 pulses unit) +	100 pulses	
21A	Excessive error alarm margin (100 pulses unit) +	100 pulses	
21B	Droop pulses (model position deviation) +	pulse	
21F*4	Motor-side/load-side position deviation (100 pulse unit) +	100 pulses	
220*2	Speed command 2 +	0.1 r/min	
23C*2	Droop pulses (command unit) +	pulse	
23D*4	Cumulative command pulses +	pulse	

*1 "mm/s" is used instead of "r/min" for linear servo motors.

*2 Available on servo amplifiers with firmware version A5 or later.

*3 Available on servo amplifiers with firmware version B0 or later.

*4 Available on servo amplifiers with firmware version D4 or later.

[Pr. PF87.4-6_Drive recorder - Analog channel 2 selection]

Initial value	Setting range	Ver.
002h	Refer to the text	A0

Select the data to be assigned to analog channel 2 of the drive recorder.

The servo parameter is disabled in the following conditions.

- [Pr. PF80.0 Drive recorder - Operation mode selection] is set to "0" (automatic setting mode)

Refer to the following for values that can be assigned.

☞ Page 135 [Pr. PF87.0-2_Drive recorder - Analog channel 1 selection]

[Pr. PF88_Drive recorder - Analog channel setting 2 (DRAC2)]

Initial value	Setting range	Ver.
02040003h	Refer to the relevant detail No.	Refer to the relevant detail No.

[Pr. PF88.0-2_Drive recorder - Analog channel 3 selection]

Initial value	Setting range	Ver.
003h	Refer to the text	A0

Select the data to be assigned to analog channel 3 of the drive recorder.

The servo parameter is disabled in the following conditions.

- [Pr. PF80.0 Drive recorder - Operation mode selection] is set to "0" (automatic setting mode)

Refer to the following for values that can be assigned.

☞ Page 135 [Pr. PF87.0-2_Drive recorder - Analog channel 1 selection]

[Pr. PF88.4-6_Drive recorder - Analog channel 4 selection]

Initial value	Setting range	Ver.
204h	Refer to the text	A0

Select the data to be assigned to analog channel 4 of the drive recorder.

The servo parameter is disabled in the following conditions.

- [Pr. PF80.0 Drive recorder - Operation mode selection] is set to "0" (automatic setting mode)

Refer to the following for values that can be assigned.

☞ Page 135 [Pr. PF87.0-2_Drive recorder - Analog channel 1 selection]

[Pr. PF89_Drive recorder - Analog channel setting 3 (DRAC3)]

Initial value	Setting range	Ver.
00090205h	Refer to the relevant detail No.	Refer to the relevant detail No.

[Pr. PF89.0-2_Drive recorder - Analog channel 5 selection]

Initial value	Setting range	Ver.
205h	Refer to the text	A0

Select the data to be assigned to analog channel 5 of the drive recorder.

The servo parameter is disabled in the following conditions.

- [Pr. PF80.0 Drive recorder - Operation mode selection] is set to "0" (automatic setting mode)

Refer to the following for values that can be assigned.

☞ Page 135 [Pr. PF87.0-2_Drive recorder - Analog channel 1 selection]

[Pr. PF89.4-6_Drive recorder - Analog channel 6 selection]

Initial value	Setting range	Ver.
009h	Refer to the text	A0

Select the data to be assigned to analog channel 6 of the drive recorder.

The servo parameter is disabled in the following conditions.

- [Pr. PF80.0 Drive recorder - Operation mode selection] is set to "0" (automatic setting mode)

Refer to the following for values that can be assigned.

☞ Page 135 [Pr. PF87.0-2_Drive recorder - Analog channel 1 selection]

[Pr. PF90_Drive recorder - Analog channel setting 4 (DRAC4)]

Initial value	Setting range	Ver.
0000020Ch	Refer to the relevant detail No.	Refer to the relevant detail No.

[Pr. PF90.0-2_Drive recorder - Analog channel 7 selection]

Initial value	Setting range	Ver.
20Ch	Refer to the text	A0

Select the data to be assigned to analog channel 7 of the drive recorder.

The servo parameter is disabled in the following conditions.

- [Pr. PF80.0 Drive recorder - Operation mode selection] is set to "0" (automatic setting mode)

Refer to the following for values that can be assigned.

☞ Page 135 [Pr. PF87.0-2_Drive recorder - Analog channel 1 selection]

[Pr. PF91_Drive recorder - Digital channel setting 1 (DRDC1)]

Initial value	Setting range	Ver.
00120000h	Refer to the relevant detail No.	Refer to the relevant detail No.

[Pr. PF91.0-3_Drive recorder - Digital channel 1 selection]

Initial value	Setting range	Ver.
0000h	Refer to the text	A0

Refer to the following table for setting values.

Values not listed below are undefined. Only set the values that are listed in the following table.

Setting value	Symbol	Name	Classification
0001	LSP	Forward rotation stroke end	DI
0002	LSN	Reverse rotation stroke end	
0005	PC	Proportional control	
0006	RES	Reset	
000B	ST1 (ST1/RS2)	Forward rotation start (forward rotation start/reverse rotation selection)	
000C	ST2 (ST2/RS1)	Reverse rotation start (reverse rotation start/forward rotation selection)	
0012	EM2/1	Forced stop	
0016	STO1	STO1	
0017	STO2	STO2	
001A	CDP2	Gain switching selection 2	
001B	CDP	Gain switching selection	
001C *1	CLD	Fully closed loop selection	
0000	SON	Servo-on	
0003	TL	External torque limit selection	
0004	TL1	Internal torque limit selection	
0007	CR	Clear	
0008	SP1	Speed selection 1	
0009	SP2	Speed selection 2	
000A	SP3	Speed selection 3	
000D	CM1	Electronic gear selection 1	
000E	CM2	Electronic gear selection 2	
000F	LOP	Control switching	
0014	STAB2	Second acceleration/deceleration selection	
0021	ABSM	ABS transfer mode	
0022	ABSR	ABS request	

Setting value	Symbol	Name	Classification
8000	RD	Ready	DO
8001	SA	Speed reached	
8002	ZSP	Zero speed detection	
8003	TLC	Limiting torque	
8004	VLC	Limiting speed	
8005	INP	In-position	
8007	WNG	Warning	
8008	ALM	Malfunction	
8009	OP	Z-phase output	
800A	MBR	Electromagnetic brake interlock	
800B	DB	External dynamic brake	
800F	BWNG	Battery warning	
8010	ALM2	Malfunction 2	
8015	STO	In STO state	
8016	SMPD	Magnetic pole detection completion	
8018	CDPS2	Variable gain enabled 2	
8019	CDPS	Variable gain enabled	
801A *1	CLDS	Fully closed loop control in progress	
801B	ABSV	Absolute position erased	
801D	IPF	Instantaneous power failure	
801E	SPC	Proportional control in progress	
801F	MTTR	Tough drive in progress	
8020	ABSB0	ABS transmission data Bit0	
8021	ABSB1	ABS transmission data Bit1	
8022	ABST	ABS transmission data ready	
8051	ALMWNG	Malfunction/Warning	
8052	BW9F	AL9F warning	

*1 Available on servo amplifiers with firmware version A5 or later.

[Pr. PF91.4-7_Drive recorder - Digital channel 2 selection]

Initial value	Setting range	Ver.
0012h	Refer to the text	A0

Refer to the following for values that can be assigned.

☞ Page 138 [Pr. PF91.0-3_Drive recorder - Digital channel 1 selection]

[Pr. PF92_Drive recorder - Digital channel setting 2 (DRDC2)]

Initial value	Setting range	Ver.
80058010h	Refer to the relevant detail No.	Refer to the relevant detail No.

[Pr. PF92.0-3_Drive recorder - Digital channel 3 selection]

Initial value	Setting range	Ver.
8010h	Refer to the text	A0

Refer to the following for values that can be assigned.

☞ Page 138 [Pr. PF91.0-3_Drive recorder - Digital channel 1 selection]

[Pr. PF92.4-7_Drive recorder - Digital channel 4 selection]

Initial value	Setting range	Ver.
8005h	Refer to the text	A0

Refer to the following for values that can be assigned.

☞ Page 138 [Pr. PF91.0-3_Drive recorder - Digital channel 1 selection]

[Pr. PF93_Drive recorder - Digital channel setting 3 (DRDC3)]

Initial value	Setting range	Ver.
8000800Ah	Refer to the relevant detail No.	Refer to the relevant detail No.

[Pr. PF93.0-3_Drive recorder - Digital channel 5 selection]

Initial value	Setting range	Ver.
800Ah	Refer to the text	A0

Refer to the following for values that can be assigned.

☞ Page 138 [Pr. PF91.0-3_Drive recorder - Digital channel 1 selection]

[Pr. PF93.4-7_Drive recorder - Digital channel 6 selection]

Initial value	Setting range	Ver.
8000h	Refer to the text	A0

Refer to the following for values that can be assigned.

☞ Page 138 [Pr. PF91.0-3_Drive recorder - Digital channel 1 selection]

[Pr. PF94_Drive recorder - Digital channel setting 4 (DRDC4)]

Initial value	Setting range	Ver.
801D8015h	Refer to the relevant detail No.	Refer to the relevant detail No.

[Pr. PF94.0-3_Drive recorder - Digital channel 7 selection]

Initial value	Setting range	Ver.
8015h	Refer to the text	A0

Refer to the following for values that can be assigned.

☞ Page 138 [Pr. PF91.0-3_Drive recorder - Digital channel 1 selection]

[Pr. PF94.4-7_Drive recorder - Digital channel 8 selection]

Initial value	Setting range	Ver.
801Dh	Refer to the text	A0

Refer to the following for values that can be assigned.

☞ Page 138 [Pr. PF91.0-3_Drive recorder - Digital channel 1 selection]

[Pr. PF95_Drive recorder - Clear history (**DRCLR)]

Initial value	Setting range	Ver.
00000000h	Refer to the relevant detail No.	Refer to the relevant detail No.

[Pr. PF95.0_Drive recorder - Clear history selection]

Initial value	Setting range	Ver.
0h	Refer to the text	A0

0: Disabled

1: Enabled

When "0" (enabled) is set, the drive recorder history will be cleared at the next power-on or software reset. After the drive recorder history is cleared, "0" (disabled) will be set to this servo parameter automatically.

1.8 Motor extension setting servo parameters group ([Pr. PL_ _])

[Pr. PL01_Function selection L-1 (**LIT1)]

Initial value	Setting range	Ver.
00000301h	Refer to the relevant detail No.	Refer to the relevant detail No.

Select a function of the linear servo motor or direct drive motor.

[Pr. PL01.0_Servo motor magnetic pole detection selection]

Initial value	Setting range	Ver.
1h	Refer to the text	A0

Select the magnetic pole detection method for the linear servo motor or direct drive motor.

0: Magnetic pole detection disabled

1: Magnetic pole detection at initial servo-on after cycling the power

5: Magnetic pole detection at every servo-on

The setting value "0" can be used on servo amplifiers with firmware version D0 or later when the fully closed loop system is used with a Mitsubishi Electric-manufactured direct drive motor connected by the direct drive motor control mode.

Do not set any value other than "0", "1", and "5".

[Pr. PL01.2_Homing stop interval setting]

Initial value	Setting range	Ver.
3h	Refer to the text	A0

Select the stop interval at dog type homing.

This servo parameter is enabled only for linear servo motors.

0: 2^{13} (= 8192) pulses

1: 2^{17} (= 131072) pulses

2: 2^{18} (= 262144) pulses

3: 2^{20} (= 1048576) pulses

4: 2^{22} (= 4194304) pulses

5: 2^{24} (= 16777216) pulses

6: 2^{26} (= 67108864) pulses

[Pr. PL02_Linear encoder resolution setting - Numerator (**LIM)]

Initial value	Setting range	Ver.
1000 [μm]	1 to 65535	A0

Set the linear encoder resolution with [Pr. PL02] and [Pr. PL03].

Set a numerator in [Pr. PL02].

This servo parameter is enabled for linear servo motors.

[Pr. PL03_Linear encoder resolution setting - Denominator (**LID)]

Initial value	Setting range	Ver.
1000 [μm]	1 to 65535	A0

Set the linear encoder resolution with [Pr. PL02] and [Pr. PL03].

Set a denominator in [Pr. PL03].

This servo parameter is enabled for linear servo motors.

[Pr. PL04_Function selection L-2 (*LIT2)]

Initial value	Setting range	Ver.
00000003h	Refer to the relevant detail No.	Refer to the relevant detail No.

Select a function of the linear servo motor or direct drive motor.

[Pr. PL04.0_[AL. 042 Servo control error] detection function selection]

Initial value	Setting range	Ver.
3h	Refer to the text	A0

Refer to the following table for setting values.

Setting value	Thrust/torque deviation error	Speed deviation error	Position deviation error
0	Disabled	Disabled	Disabled
1			Enabled
2		Enabled	Disabled
3	Enabled		
4	Enabled	Disabled	Disabled
5			Enabled
6		Enabled	Disabled
7			Enabled

[Pr. PL04.3_[AL. 042 Servo control error] detection controller reset condition selection]

Initial value	Setting range	Ver.
0h	Refer to the text	A0

0: Reset disabled (reset by cycling the power or by software reset enabled)

1: Reset enabled

[Pr. PL05_Position deviation error detection level (LB1)]

Initial value	Setting range	Ver.
0 [mm], [0.01 rev]	0 to 1000	A0

Set a position deviation error detection level of the servo control error detection.

When the difference between a model feedback position and actual feedback position is larger than the setting value, [AL. 042.1 Servo control error based on position deviation] will occur.

Note that when "0" is set, the level varies depending on the setting value in [Pr. PA01.1 Operation mode selection].

When a linear servo motor is used: 50 mm

When a direct drive motor is used: 0.09 rev

[Pr. PL06_Speed deviation error detection level (LB2)]

Initial value	Setting range	Ver.
0 [mm/s], [r/min]	0 to 20000	A0

Set the speed deviation error detection level of the servo control error detection.

When the difference between a model feedback speed and actual feedback speed is larger than the setting value, [AL. 042.2 Servo control error based on speed deviation] will occur.

Note that when "0" is set, the level varies depending on the setting value in [Pr. PA01.1 Operation mode selection].

When a linear servo motor is used: 1000 mm/s

When a direct drive motor is used: 100 r/min

[Pr. PL07_Torque deviation error detection level (LB3)]

Initial value	Setting range	Ver.
100 [%]	0 to 1000	A0

Set the torque/thrust deviation error detection level of the servo control error detection.

When the difference between a current command and current feedback is larger than the setting value, [AL. 042.3 Servo control error by torque/thrust deviation] occurs.

[Pr. PL08_Function selection L-3 (*LIT3)]

Initial value	Setting range	Ver.
00001010h	Refer to the relevant detail No.	Refer to the relevant detail No.

Select a function of the linear servo motor or direct drive motor.

[Pr. PL08.0_Magnetic pole detection method selection]

Initial value	Setting range	Ver.
0h	Refer to the text	A0

0: Position detection method

4: Minute position detection method

If detecting magnetic poles in a vertical axis, configure a system with equipment such as a counterweight to prevent the linear servo motor from moving with the force of gravity.

[Pr. PL08.2_Magnetic pole detection - Stroke limit enabled/disabled selection]

Initial value	Setting range	Ver.
0h	Refer to the text	A0

0: Enabled

1: Disabled

[Pr. PL09_Magnetic pole detection voltage level (LPWM)]

Initial value	Setting range	Ver.
30 [%]	0 to 100	A0

Set a direct current exciting voltage level in the magnetic pole detection.

If [AL. 032 Overcurrent], [AL. 050 Overload 1], or [AL. 051 Overload 2] occurs during the magnetic pole detection, set a smaller value.

If [AL. 027 Initial magnetic pole detection error] occurs during the magnetic pole detection, set a larger value.

[Pr. PL17_Magnetic pole detection - Minute position detection method - Function selection (LTSTS)]

Initial value	Setting range	Ver.
00000000h	Refer to the relevant detail No.	Refer to the relevant detail No.

This servo parameter is enabled when [Pr. PL08.0 Magnetic pole detection method selection] is set to "4" (minute position detection method).

[Pr. PL17.0_Response selection]

Initial value	Setting range	Ver.
0h	Refer to the text	A0

Select the responsiveness of the minute position detection method.

To make the travel distance at the magnetic pole detection smaller, set a larger value.

Refer to the following table for setting values.

Setting value of [Pr. PL17.0]	Responsiveness
"0"	
"1"	
"2"	
"3"	
"4"	
"5"	
"6"	
"7"	
"8"	
"9"	
"A"	
"B"	
"C"	
"D"	
"E"	
"F"	

Low response

Middle response

High response

[Pr. PL17.1_Load to motor mass ratio/load to motor inertia ratio selection]

Initial value	Setting range	Ver.
0h	Refer to the text	A0

Select a load to mass of the linear servo motor primary-side ratio or load to mass of the direct drive motor inertia ratio used for the minute position detection method. Select a value closest to the actual load.

Refer to the following table for setting values.

Setting value of [Pr. PL17.1]	Load to motor mass ratio/load to motor inertia ratio
"0"	10 times or less
"1"	10 multiplier
"2"	20 multiplier
"3"	30 multiplier
"4"	40 multiplier
"5"	50 multiplier
"6"	60 multiplier
"7"	70 multiplier
"8"	80 multiplier
"9"	90 multiplier
"A"	100 multiplier
"B"	110 multiplier
"C"	120 multiplier
"D"	130 multiplier
"E"	140 multiplier
"F"	150 times or more

[Pr. PL18_Magnetic pole detection - Minute position detection method - Identification signal amplitude (IDLV)]

Initial value	Setting range	Ver.
0 [%]	0 to 200	A0

Set an identification signal amplitude to be used in the minute position detection method.

This servo parameter is enabled when [Pr. PL08.0 Magnetic pole detection method selection] is set to "4".

When the setting value of this servo parameter is set to "0", the amplitude will be 100 [%].

2 LISTS OF SERVO PARAMETER SUPPORTED MODES

2.1 Structure

The following shows the meaning of each abbreviation used in the lists. "○" indicates the modes that can be used, and "—" indicates the modes that cannot be used or modes that are not used even if set.

Mode	List abbreviation	Meaning
Operation mode	Standard	Standard control mode
	Linear	Linear servo motor control mode
	DD	Direct drive motor control mode
	Semi closed	Semi closed loop control mode
	Fully closed	Fully closed loop control mode
Control mode	P	Position control mode
	S	Speed control mode
	T	Torque control mode

2.2 Lists of supported control modes

Basic setting servo parameters group ([Pr. PA_ _])

No.	Detail No.	Operation mode					Control mode		
		Semi closed			Fully closed		P	S	T
		Standard	Linear	DD	Standard	DD			
PA01	PA01.0	○	○	○	○	○	○	○	
	PA01.1	○	○	○	○	○	○	○	
	PA01.4	○	—	○	○	○	—	—	
PA02	PA02.0-1	○	○	○	○	○	○	○	
	PA02.4	○	○	○	○	○	○	○	
	PA02.5	○	○	○	○	○	○	○	
PA03	PA03.0	○	○	○	○	○	—	—	
	PA03.1	○	—	—	○	—	—	—	
PA04	PA04.3	○	○	○	○	○	○	—	
PA05	—	○	—	○	—	—	○	—	
PA06	—	○	○	○	○	○	—	—	
PA07	—	○	○	○	○	○	—	—	
PA08	PA08.0	○	○	○	○	○	○	—	
	PA08.4	○	○	○	○	○	○	—	
	PA08.5	○	○	○	○	○	○	—	
	PA08.6	○	○	○	○	○	○	—	
PA09	—	○	○	○	○	○	○	—	
PA10	—	○	○	○	○	○	—	—	
PA11	—	○	○	○	○	○	○	○	
PA12	—	○	○	○	○	○	○	○	
PA13	PA13.0	○	○	○	○	○	—	—	
	PA13.1	○	○	○	○	○	—	—	
	PA13.2	○	○	○	○	○	—	—	
PA14	—	○	○	○	○	○	—	—	
PA15	—	○	○	○	○	○	○	○	
PA16	—	○	○	○	○	○	○	○	
PA17	—	—	○	○	—	○	○	○	
PA18	PA18.0-3	—	○	○	—	○	○	○	
PA19	—	○	○	○	○	○	○	○	
PA20	PA20.1	○	○	○	○	○	○	—	
	PA20.2	○	○	○	○	○	○	○	
PA21	PA21.0	○	○	○	○	○	○	—	
	PA21.3	○	○	○	○	○	—	—	
PA22	PA22.1	○	○	○	○	○	—	—	
PA23	PA23.0-1	○	○	○	○	○	○	○	
	PA23.2-4	○	○	○	○	○	○	○	
PA24	PA24.0	○	○	○	○	○	○	—	
	PA24.5	○	○	○	○	○	○	—	
PA25	—	○	○	○	○	○	—	—	
PA26	PA26.0	○	○	○	○	○	○	—	
PA28	PA28.4	○	○	○	○	○	○	○	
PA34	—	○	○	○	○	○	○	○	

Gain/filter setting servo parameters group ([Pr. PB_ _])

No.	Detail No.	Operation mode					Control mode		
		Semi closed			Fully closed		P	S	T
		Standard	Linear	DD	Standard	DD			
PB01	PB01.0	○	○	○	○	○	○	○	
	PB01.3	○	○	○	○	○	○	—	
PB02	PB02.0	○	○	○	○	○	—	—	
	PB02.1	○	○	○	○	○	—	—	
PB03	—	○	○	○	○	○	—	—	
PB04	—	○	○	○	○	○	—	—	
PB06	—	○	○	○	○	○	○	—	
PB07	—	○	○	○	○	○	○	—	
PB08	—	○	○	○	○	○	—	—	
PB09	—	○	○	○	○	○	○	—	
PB10	—	○	○	○	○	○	○	—	
PB11	—	○	○	○	○	○	○	—	
PB12	—	○	○	○	○	○	—	—	
PB13	—	○	○	○	○	○	○	○	
PB14	PB14.1	○	○	○	○	○	○	○	
	PB14.2	○	○	○	○	○	○	○	
PB15	—	○	○	○	○	○	○	○	
PB16	PB16.0	○	○	○	○	○	○	○	
	PB16.1	○	○	○	○	○	○	○	
	PB16.2	○	○	○	○	○	○	○	
PB17	PB17.0-1	○	○	○	○	○	○	○	
	PB17.2	○	○	○	○	○	○	○	
PB18	—	○	○	○	○	○	○	—	
PB19	—	○	○	○	○	○	—	—	
PB20	—	○	○	○	○	○	—	—	
PB21	—	○	○	○	○	○	—	—	
PB22	—	○	○	○	○	○	—	—	
PB23	PB23.0	○	○	○	○	○	○	○	
	PB23.1	○	○	○	○	○	○	—	
	PB23.3	○	○	○	○	○	○	○	
PB24	PB24.0	○	○	○	○	○	—	—	
PB25	PB25.0	○	○	○	○	○	○	—	
	PB25.1	○	○	○	○	○	—	—	
PB26	PB26.0	○	○	○	○	○	○	—	
	PB26.1	○	○	○	○	○	○	—	
	PB26.2	○	○	○	○	○	○	—	
	PB26.4	○	○	○	○	○	○	—	
	PB26.5	○	○	○	○	○	—	—	
PB27	—	○	○	○	○	○	○	—	
PB28	—	○	○	○	○	○	○	—	
PB29	—	○	○	○	○	○	○	—	
PB30	—	○	○	○	○	○	—	—	
PB31	—	○	○	○	○	○	○	—	
PB32	—	○	○	○	○	○	○	—	
PB33	—	○	○	○	○	○	—	—	
PB34	—	○	○	○	○	○	—	—	
PB35	—	○	○	○	○	○	—	—	
PB36	—	○	○	○	○	○	—	—	

No.	Detail No.	Operation mode					Control mode		
		Semi closed			Fully closed		P	S	T
		Standard	Linear	DD	Standard	DD			
PB45	PB45.0-1	○	○	○	○	○	○	—	—
	PB45.2	○	○	○	○	○	○	—	—
PB46	—	○	○	○	○	○	○	○	○
PB47	PB47.0	○	○	○	○	○	○	○	○
	PB47.1	○	○	○	○	○	○	○	○
	PB47.2	○	○	○	○	○	○	○	○
PB48	—	○	○	○	○	○	○	○	○
PB49	PB49.0	○	○	○	○	○	○	○	○
	PB49.1	○	○	○	○	○	○	○	○
	PB49.2	○	○	○	○	○	○	○	○
PB50	—	○	○	○	○	○	○	○	○
PB51	PB51.0	○	○	○	○	○	○	○	○
	PB51.1	○	○	○	○	○	○	○	○
	PB51.2	○	○	○	○	○	○	○	○
PB52	—	○	○	○	○	○	○	—	—
PB53	—	○	○	○	○	○	○	—	—
PB54	—	○	○	○	○	○	○	—	—
PB55	—	○	○	○	○	○	○	—	—
PB56	—	○	○	○	○	○	○	—	—
PB57	—	○	○	○	○	○	○	—	—
PB58	—	○	○	○	○	○	○	—	—
PB59	—	○	○	○	○	○	○	—	—
PB60	—	○	○	○	○	○	○	○	—
PB65	—	○	○	○	○	○	○	○	—
PB66	—	○	○	○	○	○	○	○	—
PB67	—	○	○	○	○	○	○	○	—
PB68	—	○	○	○	○	○	○	—	—
PB69	—	○	○	○	○	○	○	○	—
PB70	—	○	○	○	○	○	○	○	—
PB71	—	○	○	○	○	○	○	—	—
PB72	—	○	○	○	○	○	○	—	—
PB73	—	○	○	○	○	○	○	—	—
PB74	—	○	○	○	○	○	○	—	—
PB75	—	○	○	○	○	○	○	—	—
PB76	—	○	○	○	○	○	○	—	—
PB77	—	○	○	○	○	○	○	—	—
PB78	—	○	○	○	○	○	○	—	—
PB79	—	○	○	○	○	○	○	○	—
PB81	PB81.4	○	○	○	○	○	○	—	—
PB82	—	○	○	○	○	○	○	—	—

Extension setting servo parameters group ([Pr. PC_ _])

No.	Detail No.	Operation mode					Control mode		
		Semi closed			Fully closed		P	S	T
		Standard	Linear	DD	Standard	DD			
PC01	—	○	○	○	—	—	—	○	○
PC02	—	○	○	○	—	—	—	○	○
PC03	—	○	○	○	—	—	—	○	○
PC04	—	○	○	○	—	—	—	—	○
PC05	—	○	○	○	—	—	—	○	○
PC06	—	○	○	○	—	—	—	○	○
PC07	—	○	○	○	—	—	—	○	○
PC08	—	○	○	○	—	—	—	○	○
PC09	—	○	○	○	—	—	—	○	○
PC10	—	○	○	○	—	—	—	○	○
PC11	—	○	○	○	—	—	—	○	○
PC12	—	○	○	○	—	—	—	○	○
PC13	—	○	○	○	—	—	—	—	○
PC14	PC14.0-1	○	○	○	○	○	○	○	○
PC15	PC15.0-1	○	○	○	○	○	○	○	○
PC16	—	○	○	○	○	○	○	○	○
PC17	—	○	○	○	○	○	○	○	○
PC18	PC18.0	○	○	○	○	○	○	○	○
PC19	PC19.0	○	○	○	○	○	○	○	○
	PC19.1	○	○	○	○	○	○	○	○
	PC19.2	○	○	○	○	○	○	—	—
PC20	—	○	○	○	○	○	○	○	○
PC21	PC21.1	○	○	○	○	○	○	○	○
	PC21.2	○	○	○	○	○	○	○	○
PC22	PC22.3	○	○	○	○	○	○	○	○
PC23	PC23.0	○	○	○	—	—	—	○	—
	PC23.2	○	○	○	—	—	—	○	○
	PC23.3	○	○	○	—	—	—	—	○
PC24	PC24.0	○	○	○	○	○	○	—	—
	PC24.3	○	○	○	○	○	○	—	—
PC26	PC26.0	○	○	○	○	○	○	○	—
	PC26.4	○	○	○	○	○	○	○	○
	PC26.6	○	○	○	○	○	○	○	○
PC27	PC27.2	○	○	○	○	○	○	○	○
	PC27.4	○	○	○	○	○	○	○	○
PC28	PC28.3	—	○	—	—	—	○	○	○
PC29	PC29.0	○	—	—	○	—	○	○	○
	PC29.3	○	○	○	○	○	○	○	○
	PC29.4	○	○	○	○	○	○	○	○
PC30	—	○	○	○	—	—	—	○	○
PC31	—	○	○	○	—	—	—	○	○
PC32	—	○	○	○	○	○	○	—	—
PC33	—	○	○	○	○	○	○	—	—
PC34	—	○	○	○	○	○	○	—	—
PC35	—	○	○	○	○	○	○	○	○
PC36	PC36.0-1	○	○	○	○	○	○	○	○
	PC36.2	○	○	○	○	○	○	○	○
PC37	—	○	○	○	○	○	○	○	○

No.	Detail No.	Operation mode					Control mode		
		Semi closed			Fully closed		P	S	T
		Standard	Linear	DD	Standard	DD			
PC38	—	○	○	○	○	○	○	○	
PC39	—	○	○	○	○	○	○	○	
PC40	—	○	○	○	○	○	○	○	
PC43	—	○	○	○	○	○	—	—	
PC44	PC44.3	○	○	○	○	○	—	—	
PC45	PC45.0	○	○	○	○	○	○	○	
	PC45.2	○	○	○	○	○	○	○	
PC50	PC50.0	○	○	○	○	○	○	○	
	PC50.1	○	○	○	—	—	—	—	○
PC51	—	○	○	○	○	○	○	—	
PC54	—	○	○	○	○	○	—	—	
PC60	PC60.0	○	—	—	—	—	○	○	○
	PC60.1	○	○	○	○	○	○	○	○
	PC60.4	○	○	○	○	○	○	○	○
	PC60.6	—	○	—	—	—	○	○	○
PC73	—	○	○	○	○	○	—	—	
PC90	—	○	○	○	○	○	—	—	

I/O setting servo parameters group ([Pr. PD_ _])

No.	Detail No.	Operation mode					Control mode		
		Semi closed			Fully closed		P	S	T
		Standard	Linear	DD	Standard	DD			
PD01	PD01.0-7	○	○	○	○	○	○	○	
PD03	PD03.0-1	○	○	○	○	○	○	—	—
	PD03.2-3	○	○	○	—	—	—	○	—
PD04	PD04.0-1	○	○	○	—	—	—	—	○
PD05	PD05.0-1	○	○	○	○	○	○	—	—
	PD05.2-3	○	○	○	—	—	—	○	—
PD06	PD06.0-1	○	○	○	—	—	—	—	○
PD07	PD07.0-1	○	○	○	○	○	○	—	—
	PD07.2-3	○	○	○	—	—	—	○	—
PD08	PD08.0-1	○	○	○	—	—	—	—	○
PD09	PD09.0-1	○	○	○	○	○	○	—	—
	PD09.2-3	○	○	○	—	—	—	○	—
PD10	PD10.0-1	○	○	○	—	—	—	—	○
PD11	PD11.0-1	○	○	○	○	○	○	—	—
	PD11.2-3	○	○	○	—	—	—	○	—
PD12	PD12.0-1	○	○	○	—	—	—	—	○
PD13	PD13.0-1	○	○	○	○	○	○	—	—
	PD13.2-3	○	○	○	—	—	—	○	—
PD14	PD14.0-1	○	○	○	—	—	—	—	○
PD17	PD17.0-1	○	○	○	○	○	○	—	—
	PD17.2-3	○	○	○	—	—	—	○	—
PD18	PD18.0-1	○	○	○	—	—	—	—	○
PD19	PD19.0-1	○	○	○	○	○	○	—	—
	PD19.2-3	○	○	○	—	—	—	○	—
PD20	PD20.0-1	○	○	○	—	—	—	—	○
PD21	PD21.0-1	○	○	○	○	○	○	—	—
	PD21.2-3	○	○	○	—	—	—	○	—
PD22	PD22.0-1	○	○	○	—	—	—	—	○

No.	Detail No.	Operation mode					Control mode		
		Semi closed			Fully closed		P	S	T
		Standard	Linear	DD	Standard	DD			
PD23	PD23.0-1	○	○	○	○	○	○	○	
PD24	PD24.0-1	○	○	○	○	○	○	○	
PD25	PD25.0-1	○	○	○	○	○	○	○	
PD26	PD26.0-1	○	○	○	○	○	○	○	
PD28	PD28.0-1	○	○	○	○	○	○	○	
PD29	PD29.0	○	○	○	○	○	○	○	
	PD29.1	○	○	○	○	○	○	○	
	PD29.2	○	○	○	○	○	—	—	
PD30	PD30.0	○	○	○	○	○	○	—	
	PD30.1	○	○	○	○	○	○	○	
	PD30.3	○	○	○	○	○	○	○	
PD31	PD31.2	○	○	○	○	○	—	—	
PD32	PD32.0	○	○	○	○	○	—	—	
PD33	PD33.2	○	○	○	○	○	○	○	
PD34	PD34.1	○	○	○	○	○	○	○	
PD43	PD43.0-1	○	○	○	○	○	○	—	
	PD43.2-3	○	○	○	—	—	—	○	
PD44	PD44.0-1	○	○	○	—	—	—	○	
PD45	PD45.0-1	○	○	○	○	○	○	—	
	PD45.2-3	○	○	○	—	—	—	○	
PD46	PD46.0-1	○	○	○	—	—	—	○	
PD47	PD47.0-1	○	○	○	○	○	○	○	
	PD47.2-3	○	○	○	○	○	○	○	
PD60	PD60.0-7	○	○	○	○	○	○	○	

Extension setting 2 servo parameters group ([Pr. PE_ _])

No.	Detail No.	Operation mode					Control mode		
		Semi closed			Fully closed		P	S	T
		Standard	Linear	DD	Standard	DD			
PE01	PE01.0	—	—	—	○	○	○	—	—
	PE01.4	—	—	—	○	○	○	—	—
PE03	PE03.0	—	—	—	○	○	○	—	—
	PE03.1	—	—	—	○	○	○	—	—
	PE03.3	—	—	—	○	○	○	—	—
PE04	—	—	—	—	○	○	○	—	—
PE05	—	—	—	—	○	○	○	—	—
PE06	—	—	—	—	○	○	○	—	—
PE07	—	—	—	—	○	○	○	—	—
PE08	—	—	—	—	○	○	○	—	—
PE10	PE10.1	—	—	—	○	○	○	—	—
PE41	PE41.0	○	○	○	○	○	○	○	○
	PE41.6	○	○	○	○	○	○	○	○
PE44	—	○	○	○	○	○	○	—	—
PE45	—	○	○	○	○	○	○	—	—
PE46	—	○	○	○	○	○	○	—	—
PE47	—	○	○	○	○	○	○	○	○
PE48	PE48.0	○	○	○	○	○	○	—	—
	PE48.1	○	○	○	○	○	○	—	—
PE49	—	○	○	○	○	○	○	—	—
PE50	—	○	○	○	○	○	○	—	—
PE51	—	—	—	—	○	○	○	○	○

Extension setting 3 servo parameters group ([Pr. PF_ _])

No.	Detail No.	Operation mode					Control mode		
		Semi closed			Fully closed		P	S	T
		Standard	Linear	DD	Standard	DD			
PF02	PF02.4	○	○	○	○	○	—	—	—
	PF02.5	○	○	○	○	○	—	—	—
PF09	PF09.0	○	—	—	○	—	○	○	○
	PF09.1	○	○	○	○	○	○	○	○
PF15	—	○	—	—	○	—	○	○	○
PF18	—	○	○	○	○	○	○	○	○
PF21	—	○	○	○	○	○	○	○	○
PF23	—	○	○	○	○	○	○	○	—
PF24	PF24.0	○	○	○	○	○	○	○	○
PF25	—	○	○	○	○	○	○	○	○
PF31	—	○	○	○	○	○	○	○	○
PF32	—	○	○	○	○	○	○	○	—
PF49	—	○	○	○	○	○	○	○	○
PF50	—	○	○	○	○	○	○	○	○
PF51	PF51.0	○	○	○	○	○	○	○	○
	PF51.1	○	○	○	○	○	○	○	○
	PF51.2	○	○	○	○	○	○	○	○
	PF51.5	○	○	○	○	○	○	○	○
	PF51.6	○	○	○	○	○	○	○	○
PF52	PF52.0	○	○	○	○	○	○	○	○
	PF52.1	○	○	○	○	○	○	○	○
	PF52.2	○	○	○	○	○	○	○	○
	PF52.4	○	○	○	○	○	○	○	○
	PF52.5	○	○	○	○	○	○	○	○
PF53	—	○	○	○	○	○	○	○	○
PF54	—	○	○	○	○	○	○	○	○
PF55	—	○	○	○	○	○	○	○	○
PF56	—	○	○	○	○	○	○	○	○
PF57	—	○	○	○	○	○	○	○	○
PF58	—	○	○	○	○	○	○	○	○
PF62	PF62.0	○	○	○	○	○	○	○	○
PF63	PF63.0	○	○	○	○	○	○	○	○
PF66	PF66.0-3	○	—	○	○	○	○	○	—
	PF66.4-7	○	—	○	○	○	○	○	—
PF67	—	○	—	○	○	○	○	○	—
PF68	—	○	—	○	○	○	○	○	—
PF69	—	○	○	○	○	○	○	○	○
PF70	—	○	○	○	○	○	○	○	○
PF71	PF71.0	○	○	○	○	○	○	○	○
	PF71.1	○	○	○	○	○	○	○	○
PF72	—	○	—	○	○	○	○	○	○
PF73	—	○	—	○	○	○	○	○	○
PF74	—	○	—	○	○	○	○	○	○
PF75	—	○	—	○	○	○	○	○	○
PF76	—	○	—	○	○	○	○	○	○
PF80	PF80.0	○	○	○	○	○	○	○	○
	PF80.2-3	○	○	○	○	○	○	○	○
PF81	PF81.0	○	○	○	○	○	○	○	○

No.	Detail No.	Operation mode					Control mode		
		Semi closed			Fully closed		P	S	T
		Standard	Linear	DD	Standard	DD			
PF82	PF82.0	○	○	○	○	○	○	○	○
	PF82.1	○	○	○	○	○	○	○	○
	PF82.2	○	○	○	○	○	○	○	○
	PF82.3	○	○	○	○	○	○	○	○
PF84	PF84.0-1	○	○	○	○	○	○	○	○
	PF84.2-3	○	○	○	○	○	○	○	○
	PF84.4-5	○	○	○	○	○	○	○	○
PF85	—	○	○	○	○	○	○	○	
PF86	—	○	○	○	○	○	○	○	
PF87	PF87.0-2	○	○	○	○	○	○	○	○
	PF87.4-6	○	○	○	○	○	○	○	○
PF88	PF88.0-2	○	○	○	○	○	○	○	○
	PF88.4-6	○	○	○	○	○	○	○	○
PF89	PF89.0-2	○	○	○	○	○	○	○	○
	PF89.4-6	○	○	○	○	○	○	○	○
PF90	PF90.0-2	○	○	○	○	○	○	○	○
PF91	PF91.0-3	○	○	○	○	○	○	○	○
	PF91.4-7	○	○	○	○	○	○	○	○
PF92	PF92.0-3	○	○	○	○	○	○	○	○
	PF92.4-7	○	○	○	○	○	○	○	○
PF93	PF93.0-3	○	○	○	○	○	○	○	○
	PF93.4-7	○	○	○	○	○	○	○	○
PF94	PF94.0-3	○	○	○	○	○	○	○	○
	PF94.4-7	○	○	○	○	○	○	○	○
PF95	PF95.0	○	○	○	○	○	○	○	○

Motor extension setting servo parameters group ([Pr. PL_ _])

No.	Detail No.	Operation mode					Control mode		
		Semi closed			Fully closed		P	S	T
		Standard	Linear	DD	Standard	DD			
PL01	PL01.0	—	○	○	—	○	○	○	
	PL01.2	—	○	—	—	—	○	○	
PL02	—	—	○	—	—	—	○	○	
PL03	—	—	○	—	—	—	○	○	
PL04	PL04.0	—	○	○	—	○	○	○	
	PL04.3	—	○	○	—	○	○	○	
PL05	—	—	○	○	—	○	—	—	
PL06	—	—	○	○	—	○	○	—	
PL07	—	—	○	○	—	○	○	○	
PL08	PL08.0	—	○	○	—	○	○	○	
	PL08.2	—	○	○	—	○	○	○	
PL09	—	—	○	○	—	○	○	○	
PL17	PL17.0	—	○	○	—	○	○	○	
	PL17.1	—	○	○	—	○	○	○	
PL18	—	—	○	○	—	○	○	○	

3 LISTS OF SERVO PARAMETER INITIAL VALUES

3.1 Basic setting servo parameters group ([Pr. PA_ _])

No.	Initial value
PA01	10003000h
PA02	00000000h
PA03	00000000h
PA04	00002000h
PA05	10000
PA06	1
PA07	1
PA08	00000001h
PA09	16
PA10	400
PA11	1000.0
PA12	1000.0
PA13	00000100h
PA14	0
PA15	4000
PA16	1
PA17	00000000h
PA18	00000000h
PA19	000000ABh
PA20	00000000h
PA21	00000001h
PA22	00000000h
PA23	00000000h
PA24	00000000h
PA25	0
PA26	00000000h
PA27	00000000h
PA28	00000000h
PA29	0
PA30	0
PA31	0
PA32	00000000h
PA33	0.0
PA34	0
PA35	00000000h
PA36	00000000h
PA37	00000000h
PA38	00000000h
PA39	00000000h
PA40	00000000h
PA41	00000000h
PA42	00000000h
PA43	00000000h
PA44	00000000h

3.2 Gain/filter setting servo parameters group ([Pr. PB_ _])

No.	Initial value
PB01	00000000h
PB02	00000000h
PB03	0
PB04	0
PB05	500
PB06	7.00
PB07	15.0
PB08	37.0
PB09	823
PB10	33.7
PB11	980
PB12	0
PB13	4500
PB14	00000000h
PB15	4500
PB16	00000000h
PB17	00000000h
PB18	3141
PB19	100.0
PB20	100.0
PB21	0.00
PB22	0.00
PB23	00001000h
PB24	00000000h
PB25	00000000h
PB26	00000000h
PB27	10
PB28	1
PB29	7.00
PB30	0.0
PB31	0
PB32	0.0
PB33	0.0
PB34	0.0
PB35	0.00
PB36	0.00
PB37	1600
PB38	0.000
PB39	0.000
PB40	0.000
PB41	00000000h
PB42	00000000h
PB43	00000000h
PB44	0.00
PB45	00000000h
PB46	4500
PB47	00000000h
PB48	4500

No.	Initial value
PB49	00000000h
PB50	4500
PB51	00000000h
PB52	100.0
PB53	100.0
PB54	0.00
PB55	0.00
PB56	0.0
PB57	0.0
PB58	0.00
PB59	0.00
PB60	0.0
PB61	0.0
PB62	00000000h
PB63	00000000h
PB64	00000000h
PB65	10
PB66	1
PB67	7.00
PB68	0.0
PB69	0
PB70	0.0
PB71	0.0
PB72	0.0
PB73	0.00
PB74	0.00
PB75	0.0
PB76	0.0
PB77	0.00
PB78	0.00
PB79	0.0
PB80	177.0
PB81	00000001h
PB82	0.0
PB83	00000000h
PB84	00000000h
PB85	00000000h
PB86	00000000h
PB87	00000000h
PB88	00000000h
PB89	00000000h
PB90	00000000h
PB91	00000000h
PB92	00000000h

3.3 Extension setting servo parameters group ([Pr. PC_ _])

No.	Initial value
PC01	0
PC02	0
PC03	0
PC04	0
PC05	100.00
PC06	500.00
PC07	1000.00
PC08	200.00
PC09	300.00
PC10	500.00
PC11	800.00
PC12	0
PC13	100.0
PC14	00000000h
PC15	00000001h
PC16	0
PC17	50
PC18	00000000h
PC19	00000000h
PC20	0
PC21	00000000h
PC22	00000000h
PC23	00000000h
PC24	00000000h
PC25	00000000h
PC26	00000000h
PC27	00000000h
PC28	00000000h
PC29	00000120h
PC30	0
PC31	0
PC32	1
PC33	1
PC34	1
PC35	1000.0
PC36	00000000h
PC37	0
PC38	0
PC39	0
PC40	0
PC41	0
PC42	0
PC43	0
PC44	00000050h
PC45	00000000h
PC46	0
PC47	0
PC48	0

No.	Initial value
PC49	0
PC50	00000001h
PC51	100
PC52	0
PC53	0
PC54	0
PC55	0
PC56	100
PC57	00000000h
PC58	0
PC59	00000000h
PC60	00000000h
PC61	00000000h
PC62	00000000h
PC63	00000000h
PC64	00000000h
PC65	00000000h
PC66	0
PC67	00000000h
PC68	0
PC69	00000000h
PC70	0
PC71	00000040h
PC72	00000000h
PC73	0
PC74	00000000h
PC75	00C00000h
PC76	00000000h
PC77	10
PC78	0
PC79	00000000h
PC80	00000000h
PC81	0.0
PC82	0.0
PC83	50.00
PC84	10
PC85	400
PC86	10
PC87	20.00
PC88	10
PC89	00000000h
PC90	0
PC91	00000000h
PC92	0
PC93	0
PC94	00000000h
PC95	00000000h
PC96	00000000h
PC97	00000000h
PC98	00000000h
PC99	00000000h

3.4 I/O setting servo parameters group ([Pr. PD_ _])

No.	Initial value
PD01	00000000h
PD02	00000000h
PD03	00000202h
PD04	00000202h
PD05	00002100h
PD06	00002021h
PD07	00000704h
PD08	00000707h
PD09	00000805h
PD10	00000808h
PD11	00000303h
PD12	00003803h
PD13	00002006h
PD14	00003920h
PD15	000C0C0Ch
PD16	00000C0Ch
PD17	000A0A0Ah
PD18	00000A00h
PD19	000B0B0Bh
PD20	00000B00h
PD21	002B2323h
PD22	00002B23h
PD23	00000004h
PD24	0000000Ch
PD25	00000004h
PD26	00000007h
PD27	00000003h
PD28	00000002h
PD29	00000007h
PD30	00000000h
PD31	00000000h
PD32	00000000h
PD33	00000000h
PD34	00000000h
PD35	00000000h
PD36	00000000h
PD37	00000000h
PD38	0
PD39	0
PD40	0
PD41	00000000h
PD42	00000000h
PD43	00000000h
PD44	00003A00h
PD45	00000000h
PD46	00003B00h
PD47	00000000h
PD48	00000000h
PD49	00000000h
PD50	00000000h
PD51	00000000h

No.	Initial value
PD52	00110001h
PD53	0
PD54	0
PD55	0
PD56	00000000h
PD57	00000000h
PD58	00000000h
PD59	00000000h
PD60	00000000h
PD61	00000000h
PD62	00000000h
PD63	00000000h
PD64	00000000h
PD65	00000000h
PD66	00000000h
PD67	00000000h
PD68	00000000h
PD69	00000000h
PD70	00000000h
PD71	00000000h
PD72	00000000h

3.5 Extension setting 2 servo parameters group ([Pr. PE_ _])

No.	Initial value
PE01	00000000h
PE02	00000000h
PE03	00000003h
PE04	1
PE05	1
PE06	400
PE07	100
PE08	10
PE09	00000000h
PE10	00000000h
PE11	00000000h
PE12	00000000h
PE13	00000000h
PE14	00000111h
PE15	20
PE16	00000000h
PE17	00000100h
PE18	00000000h
PE19	00000000h
PE20	00000000h
PE21	00000000h
PE22	00000000h
PE23	00000000h
PE24	00000000h
PE25	00000000h
PE26	00000000h
PE27	00000000h
PE28	00000000h
PE29	00000000h
PE30	00000000h
PE31	00000000h
PE32	00000000h
PE33	00000000h
PE34	1
PE35	1
PE36	0.0
PE37	0.00
PE38	0.00
PE39	20
PE40	00000000h
PE41	00000000h
PE42	0
PE43	0.0
PE44	0
PE45	0
PE46	0
PE47	0
PE48	00000000h

No.	Initial value
PE49	0
PE50	0
PE51	0
PE52	00000000h
PE53	00000000h
PE54	00000000h
PE55	00000000h
PE56	00000000h
PE57	00000000h
PE58	00000000h
PE59	00000000h
PE60	00000000h
PE61	0.000
PE62	0.000
PE63	0.000
PE64	0.000
PE65	0.0
PE66	0.0
PE67	0.0
PE68	00000000h
PE69	00000000h
PE70	00000000h
PE71	00000000h
PE72	00000000h
PE73	00000000h
PE74	00000000h
PE75	00000000h
PE76	00000000h
PE77	00000000h
PE78	0
PE79	0
PE80	00000000h
PE81	00000000h
PE82	00000000h
PE83	00000000h
PE84	00000000h
PE85	00000000h
PE86	00000000h
PE87	00000000h
PE88	00000000h

3.6 Extension setting 3 servo parameters group ([Pr. PF_ _])

No.	Initial value
PF01	00000000h
PF02	00000000h
PF03	00000000h
PF04	0
PF05	0
PF06	00000000h
PF07	1
PF08	1
PF09	0000013h
PF10	00000000h
PF11	00000000h
PF12	65535
PF13	100
PF14	100
PF15	2000
PF16	00000000h
PF17	10
PF18	10
PF19	00000000h
PF20	00000000h
PF21	0
PF22	200
PF23	20
PF24	00000000h
PF25	200
PF26	0
PF27	0
PF28	0
PF29	00000000h
PF30	0
PF31	0
PF32	50
PF33	00000000h
PF34	00000000h
PF35	00000000h
PF36	00000000h
PF37	00000000h
PF38	00000000h
PF39	00000000h
PF40	0
PF41	0
PF42	0
PF43	0
PF44	0
PF45	00000000h
PF46	0
PF47	00000000h
PF48	00000000h

No.	Initial value
PF49	0
PF50	0
PF51	00000000h
PF52	00000000h
PF53	0
PF54	0
PF55	0
PF56	0
PF57	0
PF58	0
PF59	00000000h
PF60	00000000h
PF61	00000000h
PF62	00000000h
PF63	00000000h
PF64	0
PF65	00000000h
PF66	00000000h
PF67	0
PF68	0
PF69	0
PF70	0
PF71	00000000h
PF72	0
PF73	0
PF74	0
PF75	0
PF76	0
PF77	00000000h
PF78	00000000h
PF79	00110010h
PF80	00000000h
PF81	00000000h
PF82	00000000h
PF83	00000000h
PF84	005A8101h
PF85	0
PF86	0
PF87	00020201h
PF88	02040003h
PF89	02090205h
PF90	0000020Ch
PF91	00120000h
PF92	80058010h
PF93	8000800Ah
PF94	801D8015h
PF95	00000000h
PF96	00000000h
PF97	00000000h
PF98	00000000h
PF99	00000000h

3.7 Motor extension setting servo parameters group ([Pr. PL_ _])

No.	Initial value
PL01	00000301h
PL02	1000
PL03	1000
PL04	00000003h
PL05	0
PL06	0
PL07	100
PL08	00001010h
PL09	30
PL10	5
PL11	100
PL12	500
PL13	00000000h
PL14	00000000h
PL15	20
PL16	0
PL17	00000000h
PL18	0
PL19	0
PL20	0
PL21	0
PL22	0
PL23	00000000h
PL24	0
PL25	0
PL26	00000000h
PL27	00000000h
PL28	00000000h
PL29	0
PL30	00000000h
PL31	00000000h
PL32	00000000h
PL33	00000000h
PL34	00000000h
PL35	00000000h
PL36	00000000h
PL37	00000000h
PL38	00000000h
PL39	00000000h
PL40	00000000h
PL41	00000000h
PL42	00000000h
PL43	00000000h
PL44	00000000h
PL45	00000000h
PL46	00000000h
PL47	00000000h
PL48	00000000h

No.	Initial value
PL49	00000000h
PL50	00000000h
PL51	00000000h
PL52	00000000h
PL53	0
PL54	00000000h
PL55	00000000h
PL56	00000000h
PL57	00000000h
PL58	00000000h
PL59	00000000h
PL60	00000000h
PL61	00000000h
PL62	00000000h
PL63	00000000h
PL64	00000000h
PL65	00000000h
PL66	00000000h
PL67	00000000h
PL68	00000000h
PL69	00000000h
PL70	00000000h
PL71	00000000h
PL72	00000000h

4 SERVO PARAMETER SETTING METHOD

Servo parameters can be set using the methods shown below. Set the servo parameters using one of these methods.

4.1 Engineering software

Servo parameters can be set using the engineering software manufactured by Mitsubishi Electric such as MR Configurator2. Connect a personal computer and the servo amplifier via a USB cable. For details on how to set servo parameters, refer to Help or the manual for each engineering software.

4.2 Operation section (push buttons)

For the MR-J5-_A_ servo amplifiers, servo parameters can be set by selecting the parameter mode with the operation section (push buttons).

5 NETWORK PARAMETER DETAILS

Network parameters are used to set IP addresses and other information necessary to connect the servo amplifier with the controllers and other network equipment. In this chapter, an outline of the network parameters and the contents of each setting are explained.

The network function of the servo amplifier is set with the network parameters. The network parameters are stored in the non-volatile memory of the servo amplifier, and are set to the initial value when using the factory setting. Change the settings as necessary. Refer to the following for the setting methods.

☞ Page 171 SERVO PARAMETER SETTING METHOD

Restrictions

Depending on the servo amplifier firmware version and MR Configurator2 software version, some network parameters and ranges cannot be set. Refer to the Mitsubishi Electric FA site for the latest software version of MR Configurator2.

In addition, the firmware version of the servo amplifier can be checked with MR Configurator2 or by other means.

When using servo motors with functional safety, executing software reset may trigger [AL. 016 Encoder initial communication error 1]. If [AL. 016] occurs, cycle the power.

Precautions

Do not change the network parameter settings as described below. Doing so may cause an unexpected condition, such as failing to start up the servo amplifier.

- Changing the values of the network parameters for manufacturer setting.
- Setting a value outside the range
- Changing the fixed value in each digit

If the method for reflecting the setting value of the network parameter is not stated, the value is enabled at the moment that it is changed.

Some of the network parameters support SLMP communication. For example, SLMP commands (IPAddressSet) are written to the IP addresses of the network parameters.

5.1 Network basic parameters

[Pr. NPA02_IP address]

Initial value	Setting range	Size	Ver.
192.168.3.1 (C0A80301h)	Refer to the text	4 bytes	A0

Set the IP address.

Set each octet to a value between 0 to 255.

In the eight digits of hexadecimal, the first to fourth octets are expressed with each pair of digits.

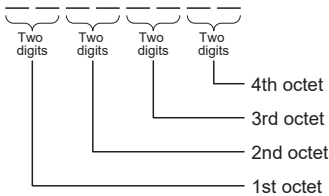

Set the IP address assigned by the network administrator.

To enable this network parameter, cycle the power or reset the software after setting.

[Pr. NPA04_Subnet mask]

Initial value	Setting range	Size	Ver.
255.255.255.0 (FFFFFF00h)	Refer to the text	4 bytes	A0

Set the subnet mask.

Set each octet to a value between 0 to 255.

In the eight digits of hexadecimal, the first to fourth octets are expressed with each pair of digits.

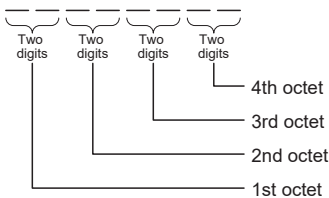

Set the subnet mask assigned by the network administrator.

To enable this network parameter, cycle the power or reset the software after setting.

[Pr. NPA08_Host name]

Initial value	Setting range	Size	Ver.
0 (All NULL)	63 characters (Refer to the text.)	64 bytes	A0

Select a host name.

Set a character string of up to 63 characters for the host name.

The characters that can be input as the host name are 0 to 9, A to Z, a to z, hyphen (-), period (.), colon (:), and underscore (_).

[Pr. NPA12_Communication speed]

Initial value	Setting range	Size	Ver.
00000002h	Refer to the text	4 bytes	B6

Set the communication speed.

1: 100 Mbps

2: Network automatic setting

To enable this network parameter, cycle the power or reset the software after setting.

Details of the communication speed are as follows:

[Pr. NPA12]	Communication speed	
	Supported firmware version	
	B6 to B9	C0 or later
2 (initial value)	1 Gbps	Automatic (1 Gbps/100 Mbps)
1	100 Mbps	100 Mbps

5.2 User authentication parameters

[Pr. NPB01_User authentication and authorization setting]

Initial value	Setting range	Size	Ver.
00000000h	Refer to the text	4 bytes	A5

Set the connection method to use for setting the user authentication parameter.

To enable this network parameter, cycle the power or reset the software after setting.

Setting value	Authorization	Description
0	Full access possible	The user authentication parameter can be set via either a USB or Ethernet connection.
1	USB only	The user authentication parameter can only be set via a USB connection.

[Pr. NPB04_User name No.1]

Initial value	Setting range	Size	Ver.
user	32 characters	36 bytes	A5

Set the user name to use when accessing the FTP server function of the servo amplifier.

Set the user name in accordance with the following restrictions. If a blank (0 character) user name is set, that account will be disabled.

Number of characters	Type of characters
1 to 32	<ul style="list-style-type: none"> • Single-byte letters (uppercase) • Single-byte letters (lowercase) • Single-byte numeric characters

If the set user name is identical to an existing account, password and authorization level parameters linked to said user name may be disabled. Ensure that no duplicate user names are set.

[Pr. NPB05_Authorization level No.1]

Initial value	Setting range	Size	Ver.
00000001h	Refer to the text	4 bytes	A5

Set the authorization level for the user (No.1).

Refer to the following table for details.

Network parameter No.	Setting digit (BIN)	Description
[Pr. NPB05.0]	___x	Firmware update permission selection 0: Prohibited 1: Permitted When "1" (permitted) is set, firmware updates can be performed via the FTP server function.
	__x_	For manufacturer setting
	_x__	Drive recorder data readout permission selection *1 0: Prohibited 1: Permitted When "1" (permitted) is set, readout of the recorded data in the drive recorder can be performed via the FTP server function.
	x___	For manufacturer setting
[Pr. NPB05.1] [Pr. NPB05.2] [Pr. NPB05.3] [Pr. NPB05.4] [Pr. NPB05.5] [Pr. NPB05.6] [Pr. NPB05.7]	For manufacturer setting	For manufacturer setting

*1 Available on servo amplifiers with firmware version B2 or later.

[Pr. NPB06_Password No.1]

Initial value	Setting range	Size	Ver.
user	—	—	A5

Set the password to use when accessing the FTP server function of the servo amplifier.

Set the password in accordance with the following restrictions.

Number of characters	Type of characters
4 to 32	<ul style="list-style-type: none"> • Single-byte letters (uppercase) • Single-byte letters (lowercase) • Single-byte numeric characters • Special characters <p>"Special characters" refers to the following characters: `~!@#\$%^&*()_+ - = { } ? : " ; ' < > ? , . / []` (additionally, a single-byte space can be used).</p>

[Pr. NPB07_User name No.2]

Initial value	Setting range	Size	Ver.
0 (All NULL)	32 characters	36 bytes	A5

Set the user name (No.2) to use when accessing the FTP server function of the servo amplifier.

☞ Page 176 [Pr. NPB04_User name No.1]

[Pr. NPB08_Authorization level No.2]

Initial value	Setting range	Size	Ver.
00000000h	Refer to the text	4 bytes	A5

Set the authorization level for the user (No.2).

☞ Page 176 [Pr. NPB05_Authorization level No.1]

[Pr. NPB09_Password No.2]

Initial value	Setting range	Size	Ver.
—	—	—	A5

Set the password (No.2) to use when accessing the FTP server function of the servo amplifier.

☞ Page 177 [Pr. NPB06_Password No.1]

[Pr. NPB10_User name No.3]

Initial value	Setting range	Size	Ver.
0 (All NULL)	32 characters	36 bytes	A5

Set the user name (No.3) to use when accessing the FTP server function of the servo amplifier.

☞ Page 176 [Pr. NPB04_User name No.1]

[Pr. NPB11_Authorization level No.3]

Initial value	Setting range	Size	Ver.
00000000h	Refer to the text	4 bytes	A5

Set the authorization level for the user (No.3).

☞ Page 176 [Pr. NPB05_Authorization level No.1]

[Pr. NPB12_Password No.3]

Initial value	Setting range	Size	Ver.
—	—	—	A5

Set the password (No.3) to use when accessing the FTP server function of the servo amplifier.

☞ Page 177 [Pr. NPB06_Password No.1]

[Pr. NPB13_User name No.4]

Initial value	Setting range	Size	Ver.
0 (All NULL)	32 characters	36 bytes	A5

Set the user name (No.4) to use when accessing the FTP server function of the servo amplifier.

☞ Page 176 [Pr. NPB04_User name No.1]

[Pr. NPB14_Authorization level No.4]

Initial value	Setting range	Size	Ver.
00000000h	Refer to the text	4 bytes	A5

Set the authorization level for the user (No.4).

☞ Page 176 [Pr. NPB05_Authorization level No.1]

[Pr. NPB15_Password No.4]

Initial value	Setting range	Size	Ver.
—	—	—	A5

Set the password (No.4) to use when accessing the FTP server function of the servo amplifier.

☞ Page 177 [Pr. NPB06_Password No.1]

[Pr. NPB16_User name No.5]

Initial value	Setting range	Size	Ver.
0 (All NULL)	32 characters	36 bytes	A5

Set the user name (No.5) to use when accessing the FTP server function of the servo amplifier.

☞ Page 176 [Pr. NPB04_User name No.1]

[Pr. NPB17_Authorization level No.5]

Initial value	Setting range	Size	Ver.
00000000h	Refer to the text	4 bytes	A5

Set the authorization level for the user (No.5).

☞ Page 176 [Pr. NPB05_Authorization level No.1]

[Pr. NPB18_Password No.5]

Initial value	Setting range	Size	Ver.
—	—	—	A5

Set the password (No.5) to use when accessing the FTP server function of the servo amplifier.

☞ Page 177 [Pr. NPB06_Password No.1]

[Pr. NPB19_User name No.6]

Initial value	Setting range	Size	Ver.
0 (All NULL)	32 characters	36 bytes	A5

Set the user name (No.6) to use when accessing the FTP server function of the servo amplifier.

☞ Page 176 [Pr. NPB04_User name No.1]

[Pr. NPB20_Authorization level No.6]

Initial value	Setting range	Size	Ver.
00000000h	Refer to the text	4 bytes	A5

Set the authorization level for the user (No.6).

☞ Page 176 [Pr. NPB05_Authorization level No.1]

[Pr. NPB21_Password No.6]

Initial value	Setting range	Size	Ver.
—	—	—	A5

Set the password (No.6) to use when accessing the FTP server function of the servo amplifier.

☞ Page 177 [Pr. NPB06_Password No.1]

[Pr. NPB22_User name No.7]

Initial value	Setting range	Size	Ver.
0 (All NULL)	32 characters	36 bytes	A5

Set the user name (No.7) to use when accessing the FTP server function of the servo amplifier.

☞ Page 176 [Pr. NPB04_User name No.1]

[Pr. NPB23_Authorization level No.7]

Initial value	Setting range	Size	Ver.
00000000h	Refer to the text	4 bytes	A5

Set the authorization level for the user (No.7).

☞ Page 176 [Pr. NPB05_Authorization level No.1]

[Pr. NPB24_Password No.7]

Initial value	Setting range	Size	Ver.
—	—	—	A5

Set the password (No.7) to use when accessing the FTP server function of the servo amplifier.

☞ Page 177 [Pr. NPB06_Password No.1]

[Pr. NPB25_User name No.8]

Initial value	Setting range	Size	Ver.
0 (All NULL)	32 characters	36 bytes	A5

Set the user name (No.8) to use when accessing the FTP server function of the servo amplifier.

☞ Page 176 [Pr. NPB04_User name No.1]

[Pr. NPB26_Authorization level No.8]

Initial value	Setting range	Size	Ver.
00000000h	Refer to the text	4 bytes	A5

Set the authorization level for the user (No.8).

☞ Page 176 [Pr. NPB05_Authorization level No.1]

[Pr. NPB27_Password No.8]

Initial value	Setting range	Size	Ver.
—	—	—	A5

Set the password (No.8) to use when accessing the FTP server function of the servo amplifier.

☞ Page 177 [Pr. NPB06_Password No.1]

6 NETWORK PARAMETER SETTING METHOD

6.1 Engineering software

The network parameters can be set with MR Configurator2. Connect a personal computer and the servo amplifier via a USB cable or a network. For details on how to set servo parameters, refer to Help or the manual for each engineering software.

REVISIONS

*The manual number is given on the bottom left of the back cover.

Revision date	*Manual number	Description
June 2019	SH(NA)-030310ENG-A	First edition
January 2020	SH(NA)-030310ENG-B	■Servo parameters related to the following functions are added: Fully closed loop system, super trace control
July 2020	SH(NA)-030310ENG-C	■Servo parameters related to the following functions are added: A/B/Z-phase differential output type encoder, regenerative option, network function
October 2020	SH(NA)-030310ENG-D	■Servo parameters related to the following functions are added: RS422 communication, network function, regenerative option
June 2021	SH(NA)-030310ENG-E	■Servo parameters related to the following servo motors are changed. HK-MT series
July 2022	SH(NA)-030310ENG-F	■Servo parameters related to the following functions are added: Gain adjustment, backlash estimation function
January 2023	SH(NA)-030310ENG-G	■Servo parameters related to the following function are added: Fully closed loop system
July 2023	SH(NA)-030310ENG-H	■Servo parameters related to the following function are added: Drive recorder
January 2024	SH(NA)-030310ENG-J	■Servo parameters related to the following function are added: Regenerative option selection
July 2024	SH(NA)-030310ENG-K	Interpreting servo parameter numbers is added.

This manual confers no industrial property rights or any rights of any other kind, nor does it confer any patent licenses. Mitsubishi Electric Corporation cannot be held responsible for any problems involving industrial property rights which may occur as a result of using the contents noted in this manual.

© 2019 MITSUBISHI ELECTRIC CORPORATION

WARRANTY

Warranty

1. Warranty period and coverage

We will repair any failure or defect hereinafter referred to as "failure" in our FA equipment hereinafter referred to as the "Product" arisen during warranty period at no charge due to causes for which we are responsible through the distributor from which you purchased the Product or our service provider. However, we will charge the actual cost of dispatching our engineer for an on-site repair work on request by customer in Japan or overseas countries. We are not responsible for any on-site readjustment and/or trial run that may be required after a defective unit are repaired or replaced.

[Term]

For terms of warranty, please contact your original place of purchase.

[Limitations]

(1) You are requested to conduct an initial failure diagnosis by yourself, as a general rule.

It can also be carried out by us or our service company upon your request and the actual cost will be charged. However, it will not be charged if we are responsible for the cause of the failure.

(2) This limited warranty applies only when the condition, method, environment, etc. of use are in compliance with the terms and conditions and instructions that are set forth in the instruction manual and user manual for the Product and the caution label affixed to the Product.

(3) Even during the term of warranty, the repair cost will be charged on you in the following cases;

1. a failure caused by your improper storing or handling, carelessness or negligence, etc., and a failure caused by your hardware or software problem
2. a failure caused by any alteration, etc. to the Product made on your side without our approval
3. a failure which may be regarded as avoidable, if your equipment in which the Product is incorporated is equipped with a safety device required by applicable laws and has any function or structure considered to be indispensable according to a common sense in the industry
4. a failure which may be regarded as avoidable if consumable parts designated in the instruction manual, etc. are duly maintained and replaced
5. any replacement of consumable parts (battery, fan, smoothing capacitor, etc.)
6. a failure caused by external factors such as inevitable accidents, including without limitation fire and abnormal fluctuation of voltage, and acts of God, including without limitation earthquake, lightning and natural disasters
7. a failure generated by an unforeseeable cause with a scientific technology that was not available at the time of the shipment of the Product from our company
8. any other failures which we are not responsible for or which you acknowledge we are not responsible for

2. Term of warranty after the stop of production

(1) We may accept the repair at charge for another seven (7) years after the production of the product is discontinued. The announcement of the stop of production for each model can be seen in our Sales and Service, etc.

(2) Please note that the Product (including its spare parts) cannot be ordered after its stop of production.

3. Service in overseas countries

Our regional FA Center in overseas countries will accept the repair work of the Product. However, the terms and conditions of the repair work may differ depending on each FA Center. Please ask your local FA center for details.

4. Exclusion of loss in opportunity and secondary loss from warranty liability

Regardless of the gratis warranty term, Mitsubishi shall not be liable for compensation to:

- (1) Damages caused by any cause found not to be the responsibility of Mitsubishi.
- (2) Loss in opportunity, lost profits incurred to the user by Failures of Mitsubishi products.
- (3) Special damages and secondary damages whether foreseeable or not, compensation for accidents, and compensation for damages to products other than Mitsubishi products.
- (4) Replacement by the user, maintenance of on-site equipment, start-up test run and other tasks.

5. Change of Product specifications

Specifications listed in our catalogs, manuals or technical documents may be changed without notice.

6. Application and use of the Product

- (1) For the use of our AC Servo, its applications should be those that may not result in a serious damage even if any failure or malfunction occurs in AC Servo, and a backup or fail-safe function should operate on an external system to AC Servo when any failure or malfunction occurs.
- (2) Our AC Servo is designed and manufactured as a general purpose product for use at general industries. Therefore, applications substantially influential on the public interest for such as atomic power plants and other power plants of electric power companies, and also which require a special quality assurance system, including applications for railway companies and government or public offices are not recommended, and we assume no responsibility for any failure caused by these applications when used.
In addition, applications which may be substantially influential to human lives or properties for such as airlines, medical treatments, railway service, incineration and fuel systems, man-operated material handling equipment, entertainment machines, safety machines, etc. are not recommended, and we assume no responsibility for any failure caused by these applications when used. We will review the acceptability of the abovementioned applications, if you agree not to require a specific quality for a specific application. Please contact us for consultation.
- (3) Mitsubishi Electric shall have no responsibility or liability for any problems involving programmable controller trouble and system trouble caused by DoS attacks, unauthorized access, computer viruses, and other cyberattacks.

TRADEMARKS

MELSERVO is a trademark or registered trademark of Mitsubishi Electric Corporation in Japan and/or other countries. All other product names and company names are trademarks or registered trademarks of their respective companies.

SH(NA)-030310ENG-K(2407)MEE

MODEL:

MODEL CODE:

MITSUBISHI ELECTRIC CORPORATION

HEAD OFFICE: TOKYO BLDG., 2-7-3, MARUNOUCHI, CHIYODA-KU, TOKYO 100-8310, JAPAN
NAGOYA WORKS: 1-14, YADA-MINAMI 5-CHOME, HIGASHI-KU, NAGOYA 461-8670, JAPAN

When exported from Japan, this manual does not require application to the
Ministry of Economy, Trade and Industry for service transaction permission.

Specifications subject to change without notice.

Compliance with the indicated global standards and regulations is current as of the release date of this manual.