

MELSOFT

Engineering Software

# CPU Module Logging Configuration Tool Version 1 Operating Manual (MELSEC iQ-R Series)

---

-SW1DNN-LLUTL-M

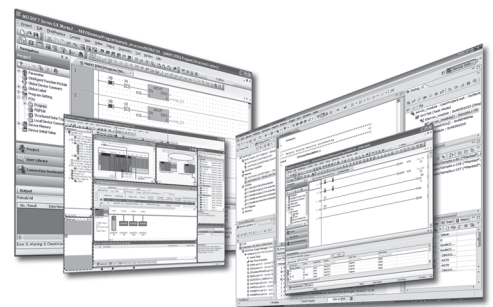



# SAFETY PRECAUTIONS



---

(Read these precautions before using this product.)

Before using this product, please read this manual carefully and pay full attention to safety to handle the product correctly. If products are used in a different way from that specified by manufacturers, the protection function of the products may not work properly.

The precautions given in this manual are concerned with this product only. For the safety precautions of the programmable controller system, refer to the user's manual for the module used and the MELSEC iQ-R Module Configuration Manual. In this manual, the safety precautions are classified into two levels: "⚠️ WARNING" and "⚠️ CAUTION".

---

|  |   |
|--|---|
|  <b>WARNING</b> | Indicates that incorrect handling may cause hazardous conditions, resulting in death or severe injury.                      |
|  <b>CAUTION</b> | Indicates that incorrect handling may cause hazardous conditions, resulting in minor or moderate injury or property damage. |

---

Under some circumstances, failure to observe the precautions given under "⚠️ CAUTION" may lead to serious consequences.

Observe the precautions of both levels because they are important for personal and system safety.

Make sure that the end users read this manual and then keep the manual in a safe place for future reference.

## [Security Precautions]

---

-  **WARNING**
- To maintain the security (confidentiality, integrity, and availability) of the programmable controller and the system against unauthorized access, denial-of-service (DoS) attacks, computer viruses, and other cyberattacks from external devices via the network, take appropriate measures such as firewalls, virtual private networks (VPNs), and antivirus solutions.
-

# CONDITIONS OF USE FOR THE PRODUCT

---

- (1) MELSEC programmable controller ("the PRODUCT") shall be used in conditions;
- i) where any problem, fault or failure occurring in the PRODUCT, if any, shall not lead to any major or serious accident; and
  - ii) where the backup and fail-safe function are systematically or automatically provided outside of the PRODUCT for the case of any problem, fault or failure occurring in the PRODUCT.
- (2) The PRODUCT has been designed and manufactured for the purpose of being used in general industries. MITSUBISHI ELECTRIC SHALL HAVE NO RESPONSIBILITY OR LIABILITY (INCLUDING, BUT NOT LIMITED TO ANY AND ALL RESPONSIBILITY OR LIABILITY BASED ON CONTRACT, WARRANTY, TORT, PRODUCT LIABILITY) FOR ANY INJURY OR DEATH TO PERSONS OR LOSS OR DAMAGE TO PROPERTY CAUSED BY the PRODUCT THAT ARE OPERATED OR USED IN APPLICATION NOT INTENDED OR EXCLUDED BY INSTRUCTIONS, PRECAUTIONS, OR WARNING CONTAINED IN MITSUBISHI ELECTRIC USER'S, INSTRUCTION AND/OR SAFETY MANUALS, TECHNICAL BULLETINS AND GUIDELINES FOR the PRODUCT.
- ("Prohibited Application")
- Prohibited Applications include, but not limited to, the use of the PRODUCT in;
- Nuclear Power Plants and any other power plants operated by Power companies, and/or any other cases in which the public could be affected if any problem or fault occurs in the PRODUCT.
  - Railway companies or Public service purposes, and/or any other cases in which establishment of a special quality assurance system is required by the Purchaser or End User.
  - Aircraft or Aerospace, Medical applications, Train equipment, transport equipment such as Elevator and Escalator, Incineration and Fuel devices, Vehicles, Manned transportation, Equipment for Recreation and Amusement, and Safety devices, handling of Nuclear or Hazardous Materials or Chemicals, Mining and Drilling, and/or other applications where there is a significant risk of injury to the public or property.
- Notwithstanding the above restrictions, Mitsubishi Electric may in its sole discretion, authorize use of the PRODUCT in one or more of the Prohibited Applications, provided that the usage of the PRODUCT is limited only for the specific applications agreed to by Mitsubishi Electric and provided further that no special quality assurance or fail-safe, redundant or other safety features which exceed the general specifications of the PRODUCTS are required. For details, please contact the Mitsubishi Electric representative in your region.
- (3) Mitsubishi Electric shall have no responsibility or liability for any problems involving programmable controller trouble and system trouble caused by DoS attacks, unauthorized access, computer viruses, and other cyberattacks.

# INTRODUCTION

---

Thank you for your patronage. We appreciate your purchase of the engineering software, MELSOFT series.

This manual describes the operations of CPU Module Logging Configuration Tool.

Before using this product, please read this manual carefully, and develop familiarity with the functions and performance of CPU Module Logging Configuration Tool to handle the product correctly.

Note that the menu names and operating procedures may differ depending on an operating system in use and its version.

When reading this manual, replace the names and procedures with the applicable ones as necessary.

# CONTENTS

|   |           |
|---|-----------|
| SAFETY PRECAUTIONS .....  | 1         |
| CONDITIONS OF USE FOR THE PRODUCT .....   | 2         |
| INTRODUCTION .....  | 3         |
| RELEVANT MANUALS .....  | 6         |
| TERMS .....   | 7         |
| GENERIC TERMS AND ABBREVIATIONS .....   | 7         |
| <b>CHAPTER 1 OVERVIEW</b> .....   | <b>8</b>  |
| <b>CHAPTER 2 SYSTEM CONFIGURATION</b> .....   | <b>10</b> |
| 2.1 Operating Environment .....   | 10        |
| 2.2 Communication Routes .....  | 10        |
| Connection to a CPU module from a personal computer .....                           | 10        |
| Connection to a CPU module via a GOT .....  | 13        |
| Connection to a process CPU (redundant mode) .....                                  | 14        |
| <b>CHAPTER 3 OBTAINING AND START of CPU Module Logging Configuration Tool</b> ..... | <b>15</b> |
| 3.1 How to Obtain .....   | 15        |
| 3.2 Installation and Uninstallation .....   | 15        |
| 3.3 Start and End .....   | 15        |
| 3.4 Display Language Switching .....  | 16        |
| <b>CHAPTER 4 SCREEN CONFIGURATION</b> .....   | <b>17</b> |
| 4.1 Main Window .....   | 17        |
| 4.2 Menu Configuration .....  | 18        |
| <b>CHAPTER 5 PROJECT MANAGEMENT</b> .....   | <b>19</b> |
| 5.1 Creating a New Project .....  | 19        |
| 5.2 Opening a Project .....   | 19        |
| 5.3 Saving a Project .....  | 19        |
| 5.4 Reading Logging Settings from an SD Memory Card .....                           | 20        |
| 5.5 Writing Logging Settings into an SD Memory Card .....                           | 21        |
| 5.6 Reading a GX Works3 Project .....   | 22        |
| <b>CHAPTER 6 DATA LOGGING SETTING</b> .....   | <b>23</b> |
| 6.1 Logging Type .....  | 23        |
| 6.2 Sampling .....  | 25        |
| 6.3 Data .....  | 26        |
| Pasting/inserting a device or label copied in another application .....             | 28        |
| Batch insertion of data .....   | 29        |
| 6.4 Trigger .....   | 30        |
| 6.5 Number of Records .....   | 31        |
| 6.6 Output .....  | 32        |
| 6.7 Save .....  | 34        |
| 6.8 File Transfer .....   | 36        |
| 6.9 Movement .....  | 38        |
| 6.10 Finish .....   | 39        |

|  |           |
|--|-----------|
| <b>CHAPTER 7 COMMON SETTING</b>  | <b>40</b> |
| 7.1 Auto Logging Common Setting .....  | 40        |
| <b>CHAPTER 8 READING/WRITING/DELETING LOGGING SETTINGS</b>                   | <b>42</b> |
| 8.1 Reading Logging Settings .....   | 44        |
| 8.2 Writing Logging Settings .....   | 45        |
| 8.3 Deleting Logging Settings .....  | 46        |
| <b>CHAPTER 9 CHECKING STATUS AND EXECUTING/STOPPING LOGGING</b>              | <b>47</b> |
| <b>CHAPTER 10 SAVING/DELETING DATA LOGGING FILES</b>                         | <b>49</b> |
| <b>CHAPTER 11 CHECKING FILE TRANSFER STATUS OF DATA LOGGING FILES</b>        | <b>51</b> |
| <b>CHAPTER 12 HELP OPERATIONS</b>  | <b>53</b> |
| 12.1 Opening Manual .....  | 53        |
| 12.2 Connection to MITSUBISHI ELECTRIC FA Global Website .....               | 53        |
| 12.3 Version Information .....   | 53        |
| <b>APPENDIX</b>  | <b>55</b> |
| <b>Appendix 1 Additions and Changes from Previous Version</b> .....          | <b>55</b> |
| <b>Appendix 2 Supported Characters</b> .....                                 | <b>57</b> |
| Supported characters for CPU Module Logging Configuration Tool .....         | 57        |
| Supported characters for the file name and the folder (directory) name ..... | 57        |
| <b>Appendix 3 USB Driver Installation Procedure</b> .....                    | <b>58</b> |
| REVISIONS .....  | 59        |
| TRADEMARKS .....   | 60        |

# RELEVANT MANUALS

| Manual name [manual number]  | Description  | Available form          |
|--|--|-------------------------|
| CPU Module Logging Configuration Tool Version 1 Operating Manual (MELSEC iQ-R Series) [SH-082478ENG] (this manual) | System configurations, operations, and setting methods when using CPU Module Logging Configuration Tool  | e-Manual PDF            |
| MELSEC iQ-R Programmable Controller CPU Module User's Manual [SH-082488ENG]  | Procedures before operation, specifications, devices, memory, functions, parameters, and troubleshooting of the programmable controller CPU module | Print book e-Manual PDF |
| MELSEC iQ-R Process CPU Module User's Manual [SH-082493ENG]  | Procedures before operation, specifications, devices, memory, functions, parameters, and troubleshooting of the process CPU module                 | Print book e-Manual PDF |
| MELSEC iQ-R CPU Module User's Manual (Application) [SH-081264ENG]  | Memory, functions, devices, and parameters of a CPU module   | Print book e-Manual PDF |

When using a safety CPU module, refer to the following:

 MELSEC iQ-R CPU Module User's Manual (Application)

## Point

e-Manual refers to the Mitsubishi Electric FA electronic book manuals that can be browsed using a dedicated tool.

e-Manual has the following features:

- Required information can be cross-searched in multiple manuals.
- Other manuals can be accessed from the links in the manual.
- Hardware specifications of each part can be found from the product figures.
- Pages that users often browse can be bookmarked.
- Sample programs can be copied to an engineering tool.





# TERMS

Unless otherwise specified, this manual uses the following terms.

| Term                         | Description   |
|------------------------------|---|
| Backup mode                  | A mode to continue operation in a redundant system. This mode can continue the operation by switching the systems from the control system to the standby system when an error occurs in the control system. |
| Device                       | A memory of a CPU module to store data. Devices such as X, Y, M, D, and others are provided depending on the intended use.  |
| Label                        | A variable consisting of a specified string used in I/O data or internal processing   |
| Process CPU (redundant mode) | A Process CPU operating in redundant mode.<br>A redundant system is configured with this CPU module. Process control function blocks and the online module change function can be used even in this mode.   |

# GENERIC TERMS AND ABBREVIATIONS



Unless otherwise specified, this manual uses the following generic terms and abbreviations.

| Generic term/abbreviation | Description   |
|---------------------------|---|
| CPU module                | R01CPU, R02CPU, R04CPU, R04ENCPU, R08CPU, R08ENCPU, R16CPU, R16ENCPU, R32CPU, R32ENCPU, R120CPU, R120ENCPU  |
| RnCPU                     | R01CPU, R02CPU, R04CPU, R08CPU, R16CPU, R32CPU, R120CPU   |
| RnENCPU                   | R04ENCPU, R08ENCPU, R16ENCPU, R32ENCPU, R120ENCPU   |
| RnENCPU (CPU part)        | A module on the left-hand side of the RnENCPU (  MELSEC iQ-R Ethernet/CC-Link IE User's Manual (Startup))  |
| RnENCPU (network part)    | A module on the right-hand side of the RnENCPU (  MELSEC iQ-R Ethernet/CC-Link IE User's Manual (Startup)) |
| Windows® 7 or later       | Windows 7, Windows 8, Windows 8.1, Windows 10, Windows 11   |
| Process CPU               | R08PCPU, R16PCPU, R32PCPU, R120PCPU   |
| Safety CPU                | R08SFPCPU, R16SFPCPU, R32SFPCPU, R120SFPCPU.<br>A module that performs both standard control and safety control and is used with a safety function module.                                  |

# 1 OVERVIEW

---

CPU Module Logging Configuration Tool is a tool to use the data logging function of a CPU module.

- Configure the data logging settings such as the logging type, sampling interval, sampling condition, and target data by following the wizard screen.  
When transferring data logging files to the FTP server, configure the data logging setting. (  Page 23 DATA LOGGING SETTING)
- When starting the data logging automatically, configure the auto logging common setting. (  Page 40 Auto Logging Common Setting)
- The data logging can be started or stopped, and a sampled data logging file can be obtained or deleted.

This manual explains the operation methods for the MELSEC iQ-R series.

For the menu configuration of CPU Module Logging Configuration Tool, refer to the following:

 Page 18 Menu Configuration



# 2 SYSTEM CONFIGURATION

This chapter explains the operating environment and the communication route of CPU Module Logging Configuration Tool.

## 2.1 Operating Environment

For details on the operating environment for CPU Module Logging Configuration Tool, refer to following manual which is stored in the installer.

 CPU Module Logging Configuration Tool/GX LogViewer Installation Instructions (BCN-P5999-0506)

The above manual is stored in the "Manual" folder which is stored in the same folder as the installer.

## 2.2 Communication Routes

The communication routes between a personal computer and a CPU module are as follows:

- Connection to a CPU module from a personal computer
- Connection to a CPU module via a GOT

### Connection to a CPU module from a personal computer

#### USB connection

Connect a personal computer and a CPU module through USB ports with a USB cable.

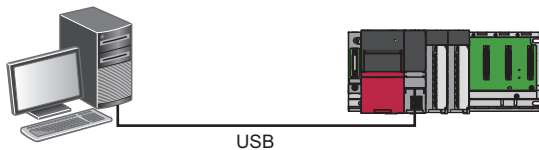

Use a USB cable. The following types of USB cables can be used:

- USB cable (USB A type — USB miniB type)
- USB cable (USB B type — USB miniB type)

Only one CPU module can be connected to a personal computer at the same time. The following connection configurations are prohibited.

- Connection to multiple CPU modules from a personal computer with multiple USB ports

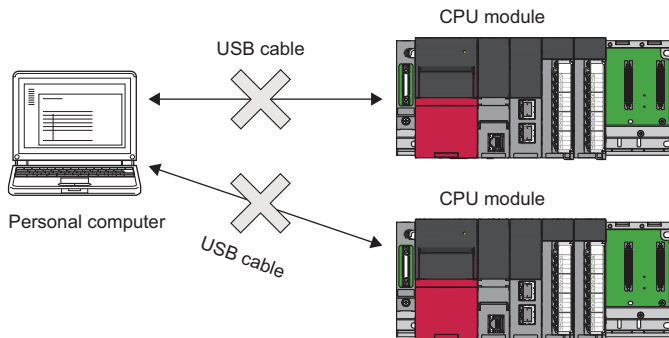

- Connection to multiple CPU modules via a USB hub

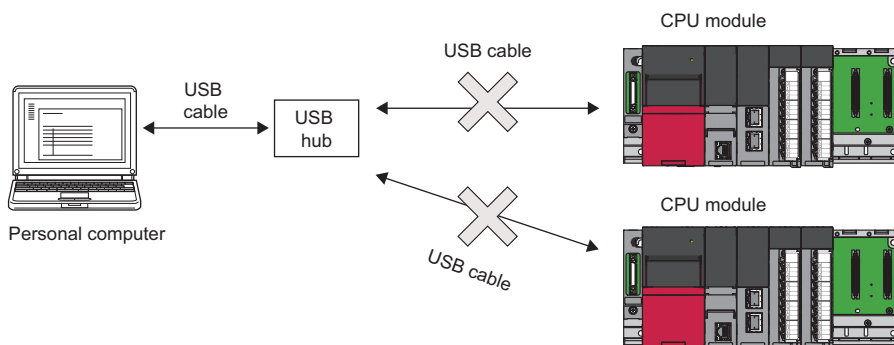

## Ethernet connection

### ■ Direct connection

A CPU module can be directly connected to a personal computer on a 1:1 basis with an Ethernet cable (crossover cable) without a hub.

Note that specifying the IP address of the CPU module is not required. (Broadcast is used.)

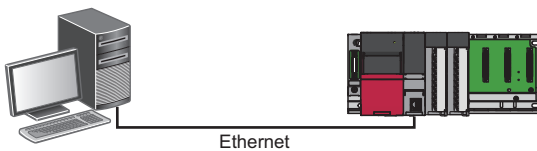

### ■ Connection via a hub

Connect a CPU module via a hub to a personal computer on the same local network.

Note that the IP address of the CPU module needs to be specified. In addition, set the same network address as the CPU module in the network settings of the personal computer.

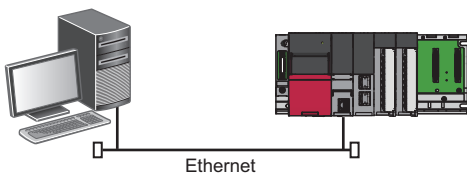

Connection can be established with a LAN cable only. Connection via the Internet is not available.

## ■ Considerations for Ethernet connection

- For an RnENCPU, use the Ethernet port of the RnENCPU (CPU part) to connect to the personal computer. An Ethernet port of the RnENCPU (network part) cannot be used for this connection.
- Do not directly connect to a personal computer via LAN line. Load imposed on the LAN line adversely affects communications by other devices.
- Do not configure the direct connection settings when connecting a CPU module to a personal computer via a hub on a 1:1 basis.
- If the following conditions are satisfied, communication by direct connection may not be available. In that case, review the settings of the module and the personal computer.

### Ex.

When all the bits of the CPU module-side IP address corresponding to the '0' parts of the personal computer-side subnet mask are ON or OFF

CPU module-side IP address: 64.64.255.255

Personal computer-side IP address: 64.64.1.1

Personal computer-side subnet mask: 255.255.0.0

### Ex.

When all the bits of the CPU module-side IP address corresponding to the host address of each class of the personal computer-side IP address are ON or OFF<sup>\*1\*2</sup>

CPU module-side IP address: 64.64.255.255

Personal computer-side IP address: 192.168.0.1

Personal computer-side subnet mask: 255.255.0.0

\*1 The IP address for each class is as follows:

- Class A: 0.x.x.x to 127.x.x.x
- Class B: 128.x.x.x to 191.x.x.x
- Class C: 192.x.x.x to 223.x.x.x

\*2 The host address for each class is 0 part in the following addresses:

- Class A: 255.0.0.0
- Class B: 255.255.0.0
- Class C: 255.255.255.0

### Ex.

When the CPU module-side IP address is automatically obtained through DHCP

- Disable Windows firewall setting, if enabled.
- Do not configure the direct connection settings in a configuration in which multiple IP addresses are enabled at the same time as shown below.
  - An IP address is assigned to each Ethernet port (network device) of a personal computer with multiple Ethernet ports.
  - A wireless LAN setting is enabled in addition to an Ethernet port of a personal computer.
  - Multiple IP addresses are assigned to a single Ethernet port of a personal computer.

## Connection to a CPU module via a GOT

The following shows the connection to a CPU module from a personal computer via a GOT by using the GOT transparent function.

- Supported GOT: GOT2000 series (except for models without Ethernet ports)
- Supported connection methods: USB, Ethernet



The connection availability and the specification method of connection destination differ depending on the connection condition between a personal computer and a GOT.

For details, refer to the following:

GOT2000 Series Connection Manual (Mitsubishi Products) For GT Works3 Version 1

### Precautions

#### ■ When performing online operations from a personal computer

During the online operation from a personal computer to a CPU module using the GOT transparent function, do not perform online operations (such as downloading project data) on a GOT from GT Designer3.

#### ■ When GOT does not monitor normally

The GOT transparent function cannot be used in the following cases.

- When a GOT does not perform normal monitoring due to CPU module errors or communication errors between the CPU module and the GOT
- During the period of time between turning ON or resetting the CPU module or GOT and the start of GOT monitoring

Check the following items if monitoring on GOT is not normal.

| Item   | Reference                  |
|--|----------------------------|
| Does the CPU module operates normally?       | GX Works3 Operating Manual |
| Is the CPU module connected to GOT normally? | Manual of GOT used         |

## Connection to a process CPU (redundant mode)

---

When connecting to a process CPU (redundant mode), select the checkbox of "Connect to RnPCPU (Redundant Mode)" and select a target connection system for "Transfer Setup System."



# 3 OBTAINING AND START of CPU Module Logging Configuration Tool

## 3.1 How to Obtain

### In Japan

CPU Module Logging Configuration Tool can be downloaded from the Mitsubishi Electric FA website.

[www.MitsubishiElectric.co.jp/fa](http://www.MitsubishiElectric.co.jp/fa)

For downloading CPU Module Logging Configuration Tool, please register for a free membership on the Mitsubishi Electric FA website in advance.

### In other countries

For the information on how to obtain CPU Module Logging Configuration Tool, please contact your local Mitsubishi Electric sales office or representative.

## 3.2 Installation and Uninstallation

For the installation/uninstallation procedure of CPU Module Logging Configuration Tool, refer to the following:

 CPU Module Logging Configuration Tool/GX LogViewer Installation Instructions (BCN-P5999-0506)

The above manual is stored in the "Manual" folder which is stored in the same folder as the installer.

## 3.3 Start and End

This section explains the operation methods for starting and ending CPU Module Logging Configuration Tool.

### Start

The following shows the three methods to start CPU Module Logging Configuration Tool.

#### ■ Starting from the Windows Start menu

Start CPU Module Logging Configuration Tool from "MELSOFT" in Windows Start.

#### ■ Starting from GX Works3

After GX Works3 is started, CPU Module Logging Configuration Tool can be started by the following operation.

- Select [Tool] ⇒ [Logging Configuration Tool].

It is started with the information (connection target device, connection target specification/connection target setting, and display language) of the GX Works3 project.

#### ■ Starting from GX LogViewer

Refer to the following:

 GX LogViewer Version 1 Operating Manual

#### Point

If an error message appears when starting CPU Module Logging Configuration Tool, start it with the administrator authority.

### End

#### Operating procedure

Select [Project] ⇒ [Exit].

## 3.4 Display Language Switching

---

CPU Module Logging Configuration Tool supports multiple languages, and therefore the display language such as one on the menu can be switched on a personal computer.\*1

\*1 For CPU Module Logging Configuration Tool with the version "1.46Y" or later

### Operating procedure

Select [View] ⇒ [Switch Display Language].

### Precautions

If the display language differs from the one for the operating system, displayed texts may get cut.

# 4 SCREEN CONFIGURATION

## 4.1 Main Window

This section explains the screen configuration when starting CPU Module Logging Configuration Tool.

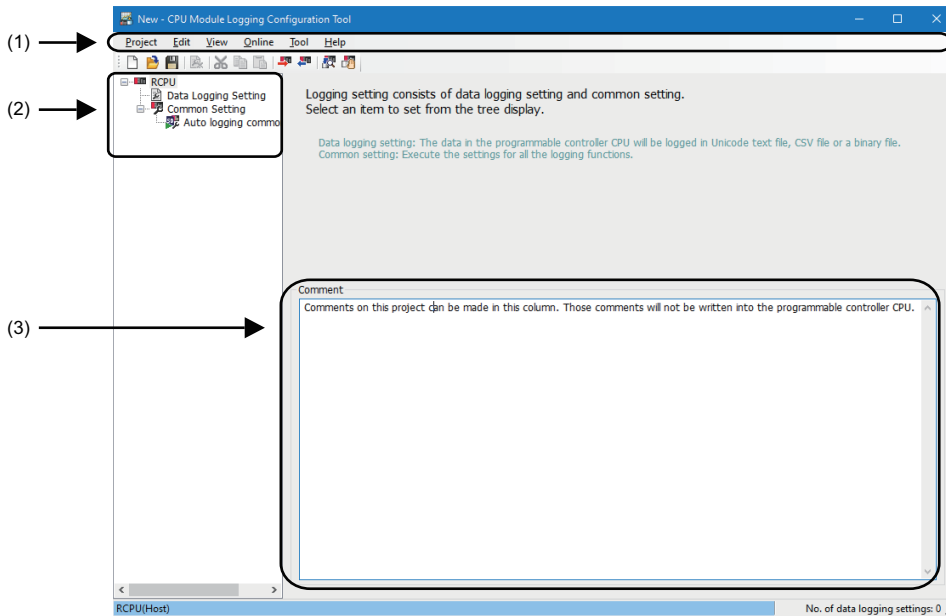

### Displayed items

| Item               | Description  | Reference  |
|--------------------|--|--|
| (1) Menu bar       | Menu items for performing each function are displayed.                                       | Page 18 Menu Configuration                             |
| (2) Edit item tree | The overall project settings are displayed in a tree.  | Page 23 DATA LOGGING SETTING<br>Page 40 COMMON SETTING |
| (3) Comment        | A comment for a project can be set.<br>This is not written to a programmable controller CPU. | —  |

## 4.2 Menu Configuration

The following table shows the menu configuration of CPU Module Logging Configuration Tool.

| Menu item |  | Description   |
|-----------|--|---|
| Project   | New  | To create a new project.  |
|           | Open   | To open a saved project file.   |
|           | Save   | To save an edited project to a file.  |
|           | Save As  | To save an edited project under a new file name.  |
|           | Read Logging Setting from Memory Card(SD)                | To read a data logging setting written in an SD memory card inserted in a personal computer.  |
|           | Write Logging Setting into Memory Card(SD)               | To write a setting being edited in a format with which a CPU module can operate. Once the setting is directly written into an SD memory card inserted in a personal computer and then the SD memory card is mounted onto the CPU module, the data logging starts. |
|           | Recent Files   | To open a file used recently.   |
|           | Read GX Works3 Project                                   | To import a GX Works3 project which is the read source for the label.   |
|           | Exit   | To end CPU Module Logging Configuration Tool.   |
| Edit      | Delete Data Logging Setting                              | To delete a data logging setting selected in the edit item tree.  |
|           | Copy and Add Data Logging Setting                        | To copy and add a data logging setting selected in the edit item tree.  |
|           | Batch Data Insertion                                     | To configure multiple setting items in a batch.   |
|           | Cut Setting Item   | To delete data in a selected row and copy the setting item to the clipboard.*1  |
|           | Copy Setting Item  | To copy the setting item in a selected row to the clipboard.*1  |
|           | Paste Setting Item                                       | To paste a copied setting item into a selected row.*2   |
|           | Paste device/label copied in other application software  | To overwrite a device or label which is copied in another application in a selected row. (Existing data in the selected row is deleted.)  |
|           | Insert and Paste Setting Item                            | If "Insert and Paste Setting Item" is executed while the setting item is copied or cut, the setting item in the clipboard is inserted above the selected row.*2   |
|           | Insert device/label copied in other application software | To paste a device or label which is copied in another application into a selected row, and shift down existing data in the selected row and below.  |
|           | Delete Setting Item                                      | To delete a setting item in a selected row.   |
|           | Move Setting Item Upward                                 | To move up a setting item in a selected row.  |
|           | Move Setting Item Downward                               | To move down a setting item in a selected row.  |
|           | Device Batch Replacement                                 | To replace devices for all settings.  |
| View      | Switch Display Language                                  | To switch the display language for menus, etc.  |
| Online    | Transfer Setup   | To configure the communication setting used when connecting to a CPU module.  |
|           | Read Logging Setting                                     | To read a setting from a CPU module.  |
|           | Write Logging Setting                                    | To write a setting to a CPU module.   |
|           | Delete Logging Setting                                   | To delete setting data from a CPU module.   |
|           | Logging Status and Operation                             | To check the data logging status.   |
|           | Logging File Operation                                   | To connect to a CPU module and read or delete files in an SD memory card inserted or data memory.   |
|           | Data Logging File Transfer Status                        | To display the transfer status of a data logging file.  |
| Tool      | Start GX LogViewer                                       | To start GX LogViewer.  |
| Help      | Open Manual  | To start e-Manual Viewer and display the manual.  |
|           | Connection to MITSUBISHI ELECTRIC FA Global Website      | To display the Mitsubishi Electric FA website.  |
|           | About Configuration tool                                 | To display the product information.   |

\*1 Once the setting item is copied or cut, the copied state will not be canceled even when the setting item is edited or the screen is transitioned. Pasting will be possible as long as the copied data exists in the clipboard.

\*2 A setting item which is copied in another application (such as a watch window of GX Works3 or GX Works2, a spreadsheet, and a text editor) can also be pasted.

# 5 PROJECT MANAGEMENT

This chapter shows the operations to create and save a project, and read from or write to an SD memory card.

## 5.1 Creating a New Project

Create a new project.

### Window

Select [Project] ⇒ [New].

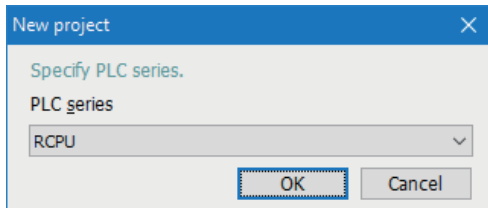

### Operating procedure

Select "RCPU," and click the [OK] button.

## 5.2 Opening a Project

Open a stored project file.

### Operating procedure

Select [Project] ⇒ [Open].

## 5.3 Saving a Project

### Overwriting

Save an edited project to a file.

### Operating procedure

Select [Project] ⇒ [Save].

### Saving under a new file name

Save an edited project under a new file name.

### Operating procedure

Select [Project] ⇒ [Save As].

## 5.4 Reading Logging Settings from an SD Memory Card

The following window is used to read the data logging setting written in an SD memory card inserted in a personal computer. Insert the SD memory card in the personal computer in advance.

### Window

Select [Project] ⇒ [Read Logging Setting from Memory Card(SD)].

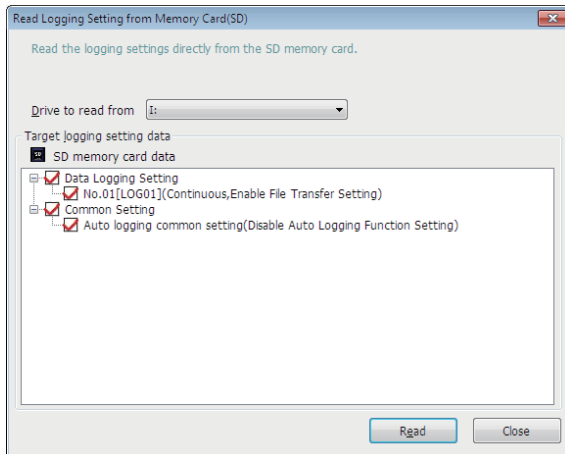

### Operating procedure

1. Select the drive in which the data to be read is stored for "Drive to read from."
2. Select the checkbox of the data to be read.
3. Click the [Read] button.

### Point

- Any existing data (data logging setting with the same setting number or common setting) on the target is overwritten.
- The PLC series of the setting data in the SD memory card must be "RCPU."

# 5.5 Writing Logging Settings into an SD Memory Card

The following window is used to write the settings being edited in a format with which the CPU module can operate. Once the settings are directly written to an SD memory card inserted in a personal computer and then the SD memory card is inserted in the CPU module, the data logging starts. (Auto logging)

For details on the auto logging function of a CPU module, refer to "Auto Logging" in the manual for the CPU module used.

## RELEVANT MANUALS

Insert the SD memory card in the personal computer in advance.

### Window

Select [Project] ⇒ [Write Logging Setting into Memory Card(SD)].

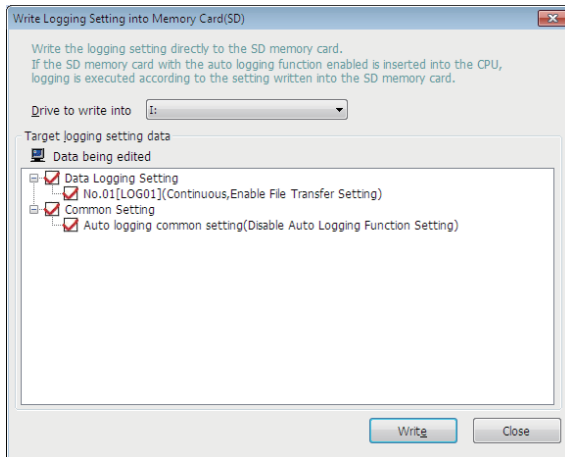

### Operating procedure

1. Select the drive in which the data to be written is stored for "Drive to write into."
2. Select the checkbox of the data to be written.
3. Click the [Write] button.

### Point

Any existing data (data logging setting with the same setting number or common setting) on the target is overwritten.

## 5.6 Reading a GX Works3 Project

The following window is used to import a GX Works3 project which is the read source for the label.

### Window

Select [Project] ⇨ [Read GX Works3 Project].

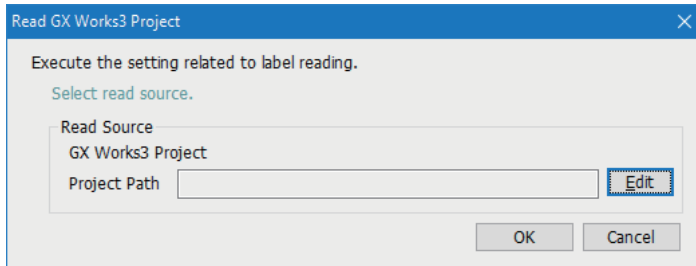

### Operating procedure

1. Click the [Edit] button, and select a project which is the read source.  
The full path of the read source project is displayed in "Project Path." When no project is read, this field is blank.
2. Click the [OK] button.

### Precautions

A GX Works3 project whose security version is '2' is not supported.

Change the security version to '1' and read a project.

For the method for changing the security version, refer to the following:

 GX Works3 Operating Manual



# 6 DATA LOGGING SETTING

This chapter shows the operations to configure the required settings in the wizard format for using the data logging function of a CPU module.

For details on the data logging function of a CPU module, refer to "DATA LOGGING FUNCTION" in the manual for the CPU module used.

☞ RELEVANT MANUALS

## Operating procedure

Select [RCPU] ⇒ [Data Logging Setting] in the edit item tree, and click the [Edit] button.

## 6.1 Logging Type

The following window is used to set the data logging type, file format, storage destination of the data logging file, and target data (device or label) of data logging.

### Window

### Displayed items

| Item                            | Description   | Setting range  | Default            |
|---------------------------------|---|--|--------------------|
| Logging type                    | Select the logging type.  | <ul style="list-style-type: none"> <li>Continuous logging</li> <li>Trigger logging</li> </ul>                                | Continuous logging |
| Logging target                  | Device* <sup>1</sup>  | Select this when using a device as the target data specified in the "Sampling," "Data," and "Trigger" settings.              | Selected           |
|                                 | Label* <sup>1</sup>   | Select this when using a label as the target data specified in the "Sampling," "Data," and "Trigger" settings.               | Not selected       |
|                                 | Target program name   | Input a target program name when specifying a local label in a program block.  | —                  |
| File format                     | Select the output file format.<br>For details, refer to "Storage format of data logging files" in the manual for the CPU module used.<br>☞ RELEVANT MANUALS | <ul style="list-style-type: none"> <li>Unicode text file</li> <li>CSV file*<sup>2*3</sup></li> <li>Binary file</li> </ul>    | Unicode text file  |
| Data storage destination memory | Select the storage destination of the data logging files.   | <ul style="list-style-type: none"> <li>SD memory card</li> <li>CPU built-in memory (function memory)*<sup>4</sup></li> </ul> | SD memory card     |

\*1 When specifying a local device and a label as the logging target, check the module type and the firmware version of a supported CPU module.

For details on the firmware version, refer to "Added and Enhanced Functions" in the manual for the CPU module used.

☞ RELEVANT MANUALS

- \*2 When setting the file format to the CSV file format, check the firmware version of the CPU module and the version of CPU Module Logging Configuration Tool (☞ Page 55 Additions and Changes from Previous Version).  
For details on the firmware version, refer to "Added and Enhanced Functions" in the manual for the CPU module used.

☞ RELEVANT MANUALS

- \*3 If the data name (device/label name), device comment, or program name contains characters that cannot be converted to ASCII (Shift-JIS), the relevant data is output as a single-byte period (.).
- \*4 When specifying the CPU built-in memory (function memory) as the data storage destination memory, check the firmware version of a supported CPU module.  
For details on the firmware version, refer to "Added and Enhanced Functions" in the manual for the CPU module used.

☞ RELEVANT MANUALS

# 6.2 Sampling

The following window is used to configure the sampling interval and sampling start conditions.

## Window

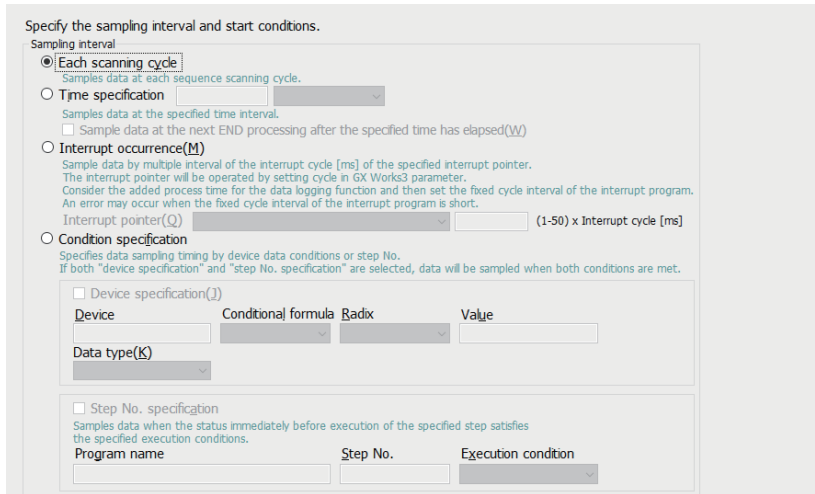

## Displayed items



| Item                    | Description   | Setting range  | Default  |                                  |
|-------------------------|---|--|--|----------------------------------|
| Each scanning cycle     | Select this to sample data on every scan.                                   | —  | —  |                                  |
| Time specification      | Sampling time value   | Specify the sampling interval value.   | • ms: 1 to 32767<br>• s: 1 to 86400  | 1 ms                             |
|                         | Sample data at the next END processing after the specified time has elapsed | Select the checkbox to sample data at a timing when the first END processing is completed after the specified time interval elapses.   | —  | Selected                         |
| Interrupt occurrence    | Interrupt pointer   | Select the interrupt cycle.  | <ul style="list-style-type: none"> <li>• I28: Interrupt by internal timer</li> <li>• I29: Interrupt by internal timer</li> <li>• I30: Interrupt by internal timer</li> <li>• I31: Interrupt by internal timer</li> <li>• I44: Inter-module synchronous interrupt</li> <li>• I45: Multiple CPU synchronous interrupt</li> <li>• I48: High speed internal timer interruption 2</li> <li>• I49: High speed internal timer interruption 1</li> </ul> | I28: Interrupt by internal timer |
|                         | Multiple  | Specify a multiple applied to the interval value.  | 1 to 50  | 1                                |
| Condition specification | Device specification <sup>*1</sup>  | Specify each item for sampling data at the END processing where the specified device condition has been satisfied. If both the step number and device are specified as conditions, the data is sampled when the both conditions are satisfied. | For details, refer to "Condition specification" in the manual for the CPU module used.<br>RELEVANT MANUALS   | Selected <sup>*3</sup>           |
|                         | Label specification <sup>*2</sup>   | Specify each item for sampling data at the END processing where the specified label condition has been satisfied. If both the step number and label are specified as conditions, the data is sampled when the both conditions are satisfied.   |  | Selected <sup>*3</sup>           |
|                         | Step No. specification  | Specify each item for sampling data when the condition is satisfied immediately before execution of the specified step number.   |  | Not selected                     |

\*1 Displayed when "Device" is specified as "Logging target" in the "Logging type" screen.  
 \*2 Displayed when "Label" is specified as "Logging target" in the "Logging type" screen.  
 \*3 The default of "Device specification" or "Label specification" when "Condition specification" is selected

# 6.3 Data

The following window is used to set the target data to be sampled.

### Point

- To paste a device/label which is copied in another application (such as a watch window of GX Works3 or GX Works2, a spreadsheet, or a text editor), use "Paste device/label copied in other application software" or "Insert device/label copied in other application software." (  Page 28 Pasting/inserting a device or label copied in another application).
- To insert a block of data into the data list all at once, use "Batch Data Insertion." (  Page 29 Batch insertion of data)

## Window

Set the data for logging.

A total of up to 128 device points can be set.  
Bit digit specification is using points corresponding to data type. (1 point for word type and 2 points for double-word type)

| No. | Device |      | Data Type | Size [Byte] | Output Format |
|-----|--------|------|-----------|-------------|---------------|
|     | Head   | Last |           |             |               |
| 001 |        |      |           |             |               |
| 002 |        |      |           |             |               |
| 003 |        |      |           |             |               |
| 004 |        |      |           |             |               |
| 005 |        |      |           |             |               |
| 006 |        |      |           |             |               |
| 007 |        |      |           |             |               |
| 008 |        |      |           |             |               |
| 009 |        |      |           |             |               |
| 010 |        |      |           |             |               |
| 011 |        |      |           |             |               |
| 012 |        |      |           |             |               |
| 013 |        |      |           |             |               |
| 014 |        |      |           |             |               |
| 015 |        |      |           |             |               |
| 016 |        |      |           |             |               |
| 017 |        |      |           |             |               |
| 018 |        |      |           |             |               |
| 019 |        |      |           |             |               |
| 020 |        |      |           |             |               |
| 021 |        |      |           |             |               |
| 022 |        |      |           |             |               |
| 023 |        |      |           |             |               |

## Displayed items

| Item          | Description   | Setting range   | Default |
|---------------|---|---|---------|
| No.           | The data setting numbers from 001 to 128 are displayed.   | —   | —       |
| Device*1      | Head  | For details, refer to "Specifying the monitored data" in the manual for the CPU module used.<br>RELEVANT MANUALS        |         |
|               | Last  |   |         |
| Label*2       | <p>Set a target label.*3*4</p> <p>■When setting a global label<br/>Input "Label name."<br/>Example: "label_w1"<br/>For the label of timer type/retentive timer type/counter type, specify the element name. (S: contact, C: coil, N: current value)<br/>Example: "label_w1.S"</p> <p>■When setting a local label<br/>Input "Program block name/Label name."<br/>Example: "ProgPou/label_w1"<br/>For the label of timer type/retentive timer type/counter type, specify the element name. (S: contact, C: coil, N: current value)<br/>Example: "ProgPou/label_w1.S"</p> <p>■When setting a structure element<br/>Input "Label.Element name."<br/>For the label of timer type/retentive timer type/counter type, specify the element name. (S: contact, C: coil, N: current value)<br/>Example: "tmLabel.S"</p> <p>■When setting an array element<br/>Input "Label name[Element number of third dimension][Element number of second dimension][Element number of first dimension]."*5*6</p> <p>■When setting a structure array member<br/>Input "Label name[Element number of third dimension][Element number of second dimension][Element number of first dimension].Member name.*5*6"</p> |   |         |
| Data Type     | Select the type of data to be sampled.<br>When a label is selected as the target data, the data type corresponding to the data type of the label is displayed.  |   |         |
| Size [Byte]   | Specify the data size when the data type is set to "String" or "Raw."   | 1 to 256 bytes  |         |
| Output Format | Clicking the [...] button at the rightmost part displays the "Output Format (integer/float)" screen for each row. Select the format to be used when data is output to the file.   | For details, refer to "Storage format of data logging files" in the manual for the CPU module used.<br>RELEVANT MANUALS |         |

\*1 Displayed when "Device" is specified as "Logging target" in the "Logging type" screen.

\*2 Displayed when "Label" is specified as "Logging target" in the "Logging type" screen.

\*3 When the input label name is valid, it is used as it is. Therefore, the case may differ between the label name defined in GX Works3 and the label name displayed in the screen.

\*4 The label that cannot be watched in GX Works3 cannot be set.

\*5 If an array element is not specified, it is handled as the start of the array ([0]). (Example: When "bLabel1[0..9]" exists and "bLabel1" is input, it is handled as "bLabel1[0].")

\*6 If the input array is out of the range, an undefined value is specified.

### Point

In CPU Module Logging Configuration Tool with the version earlier than "1.100E," the link direct device areas exceeding the following points cannot be specified.

- J□\SB/J□\SW: 512 points, J□\X/J□\Y: 16K points, J□\B: 32K points, J□\W: 128K points

To perform the data logging for areas exceeding the above points, refresh those areas to the CPU module first and perform the data logging to the refreshed device areas.

For the CPU modules and firmware versions that support the areas exceeding the above points, refer to "Added and Enhanced Functions" in the manual for the CPU module used.

RELEVANT MANUALS

In CPU Module Logging Configuration Tool with the version "1.100E" or later, the link direct device areas exceeding the above points can be specified.

# Pasting/inserting a device or label copied in another application

A device or label which is copied in another application (such as a watch window of GX Works3 or GX Works2, a spreadsheet, or a text editor) can be pasted into a selected row in the "Data" setting screen.

## Operating procedure

In the "Data" setting screen, select a row where copied data is to be pasted, and select the item from the right-click menu.

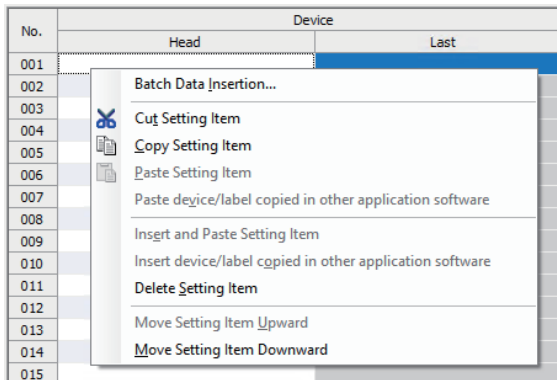

### Point

The shortcut key for "Paste device/label copied in other application software" is "**Ctrl** + **Shift** + **V**." Note that this shortcut key is valid only when the "Head" column under "Device" or "Label" column is selected.

## Operation details

The following table shows the operation details of pasting and inserting.

| Item   | Operation  |
|--|--|
| Paste device/label copied in other application software  | To overwrite a device or label which is copied in another application in a selected row. (Existing data in the selected row is deleted.) <sup>*1*2</sup><br>For devices, settings other than start devices are entered as default settings corresponding to each device.           |
| Insert device/label copied in other application software | To paste a device or label which is copied in another application into a selected row, and shift down existing data in the selected row and below. <sup>*1*2</sup><br>For devices, settings other than start devices are entered as default settings corresponding to each device. |

\*1 Strings of each row in the clipboard which are from the start to the newline or the first tab delimited are pasted or inserted.

\*2 If a copied string is invalid as a device/label, it cannot be pasted or inserted.

# Batch insertion of data

The following window is used to insert data into the data list at once. Data is inserted into blank rows in the list of the "Data" setting screen in order from the top (when a setting already exists in the target insertion row, the row is skipped without overwriting it).

## Window

Select [Edit] ⇒ [Batch Data Insertion].

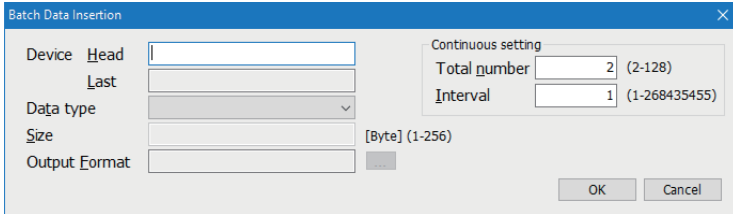

## Operating procedure

Set each item and click the [OK] button.

## Displayed items

| Item               | Description   |   |
|--------------------|---|---|
| Device             | Head  | Specify the start device number. Only global devices can be input. (Local devices cannot be input.) |
|                    | Last  | The end device number calculated based on the data type and size is displayed.                      |
| Data type          | Select a type of the data to be inserted at once.   |   |
| Size               | Specify the data size when the data type is set to "String" or "Raw."   |   |
| Output Format      | Clicking the [...] button at the rightmost part displays the "Output Format (integer/float)" screen for each row. Select the format to be used when data is output to the file. |   |
| Continuous setting | Total number  | Specify the total number of data to be inserted at once.  |
|                    | Interval  | Specify the device interval of data to be inserted at once.   |

# 6.4 Trigger

The following window is used to specify the trigger condition when the trigger logging is selected.

## Window

Make trigger setting.

Condition specification  
Sets trigger condition with device data values and step No. If both "Device change specification" and "Step No. specification" are selected, an AND condition of each setting is required to be met.

Device change specification(L)  
Device  Conditional formula  Radix  Value   
Data type(K)

Step No. specification  
Conditions met when the status immediately before execution of the specified step satisfies the specified execution conditions.  
Target program name  Step No.  Execution condition

When trigger instruction executed  
Trigger conditions met when LOGTRG instruction is executed.

## Displayed items

| Item                              | Description   | Setting range   | Default                    |
|-----------------------------------|---|---|----------------------------|
| Condition specification           | Device change specification <sup>*1</sup>                                 | For details, refer to "Trigger Conditions" in the manual for the CPU module used.<br><a href="#">RELEVANT MANUALS</a> | Selected <sup>*3</sup>     |
|                                   | Label change specification <sup>*2</sup>                                  |   | Not selected <sup>*3</sup> |
|                                   | Step No. specification  |   | —                          |
| When trigger instruction executed | Trigger condition is established when the LOGTRG instruction is executed. | —   | —                          |

\*1 Displayed when "Device" is specified as "Logging target" in the "Logging type" screen.

\*2 Displayed when "Label" is specified as "Logging target" in the "Logging type" screen.

\*3 The default of "Device change specification" or "Label change specification" when "Condition specification" is selected



# 6.5 Number of Records

The following window is used to specify the number of records to be output before and after trigger occurrences when the trigger logging is selected.

## Window

Data before and after trigger condition rises will be logged.  
Specify the numbers of records before and after trigger.

No. of records (before trigger)  [Record] (0~999999)

No. of records (after trigger)  [Record] (1~1000000)

Total No. of records  [Record] (1~1000000)

## Displayed items

| Item                            | Description   | Setting range   | Default |
|---------------------------------|---|---|---------|
| No. of records (before trigger) | Specify the number of records to be output as before-trigger record.              | • SD memory card: 0 to 999999<br>• Function memory: 0 to 49999  | 1       |
| No. of records (after trigger)  | Specify the number of records to be logged during and after a trigger occurrence. | • SD memory card: 1 to 1000000<br>• Function memory: 1 to 50000 | 1       |
| Total No. of records            | The total number of before-trigger and after-trigger records is displayed.        | —   | 2       |

# 6.6 Output

The following window is used to specify the items to be output into the file.

## Window

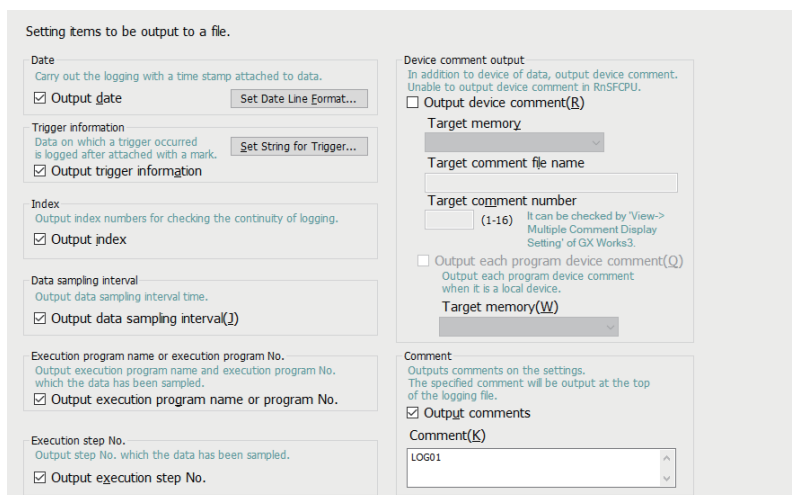

## Displayed items

| Item  |  | Description   | Setting range                                      | Default           |
|---|--|---|--|-------------------|
| Date  | Output date                                  | Add a time stamp to data for the data logging. The date/time format to be output can be specified by clicking the [Set Date Line Format] button.  | *1*2   | Selected          |
| Trigger information                             | Output trigger information                   | Add a mark to data that is associated with a trigger occurrence for the data logging. A character string to be added to the data where a trigger has occurred can be specified by clicking the [Set String for Trigger] button. | 256 characters or less                             |                   |
| Index   | Output index                                 | Output the index number used for checking the logging continuity.   | —  |                   |
| Data sampling interval                          | Output data sampling interval                | Output the data sampling interval.  |  |                   |
| Execution program name or execution program No. | Output execution program name or program No. | Output the execution program name and execution program number used for the data sampling.  |  |                   |
| Execution step No.                              | Output execution step No.                    | Output the step number used for the data sampling.  |  |                   |
| Device comment output                           | Output device comment                        | If the sampling data was specified with the device, the device comment is output in addition to the device.   |  | Not selected      |
|   | Target memory                                | Select the storage memory for the comment file used when the comment is displayed.  | • Memory Card(SD)<br>• Data memory                 | —                 |
|   | Target comment file name                     | Set the comment file name used when the comment is displayed.   | 60 characters or less                              | —                 |
|   | Target comment number*3                      | Specify the comment number to be displayed.   | 1 to 16  | —                 |
|   | Output each program device comment*4*5       | Output device comments for each program when a local device is specified as the sampling data.  | —  | Not selected      |
| Comment   | Target memory (each program device comment)  | Specify the memory in which device comment files for each program are stored.   | • Memory Card(SD)<br>• Data memory                 | —                 |
|   | Output comments                              | Output the comment at the top of the file.  | —  | Selected          |
|   | Comment*6                                    | Input the comment.  | 256 characters or less (No line feed can be used.) | LOG (setting No.) |

\*1 Data output format can be created by combining the following formats.

- Year: YYYY for four-digit expression; YY for two-digit expression
- Month: MM
- Day: DD
- Hour: hh
- Minute: mm
- Second: ss
- Millisecond: ms (three-digit expression), or s, ss, sss, ssss, sssss, ssssss, or sssssss (second unit after the decimal point, maximum of seven digits)

(Example) YY/MM/DD hh:mm:ss.sss → 10/10/13 09:44:35.241

- \*2 When either of "Year," "Month," "Day," "Hour," "Minute," or "Second" is omitted, if opening the data logging file by GX LogViewer, the index expression is used rather than the time expression.  
 GX LogViewer Version 1 Operating Manual
- \*3 The target comment number refers to the numbers, which correspond to the comment numbers in the [View] ⇨ [Multiple Comments] ⇨ [Display Setting] of GX Works3.
- \*4 The comment number of the device comments for each program is the same as that of the device comments. The device comments for each program are output only when a local device is specified. When a global device is specified, the comments in the device comment file specified for the target file name are output.
- \*5 When the checkbox of "Output each program device comment" is selected and a device comment for each program that corresponds to the program name does not exist, the comments in the device comment file specified for the target file name are output.
- \*6 When the following user action is detected, character entry will be disabled.
  - Entering a character which cannot be handled with the OS language character code.
  - Entering a character whose language code is different from the one for characters already input in the same data logging setting.

# 6.7 Save

The following window is used to configure the storage destination of data logging files and the switching timing of storage files.

## Window

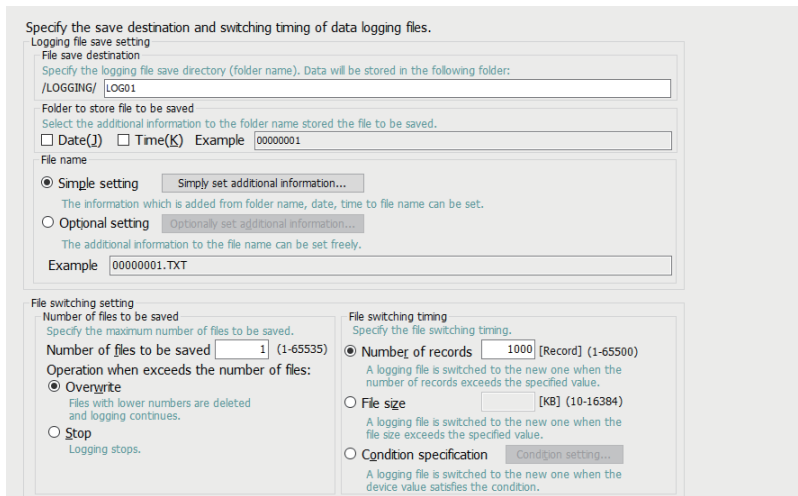

## Displayed items

| Item                      | Description                      |  | Setting range   | Default  |           |
|---------------------------|----------------------------------|--|---|--|-----------|
| Logging file save setting | File save destination            | Specify the storage folder for the data logging file.  | 60 characters or less (double-byte character not allowed)   | LOG (setting No.)  |           |
|                           | Folder to store file to be saved | Select information to be added to the name of the folder which stores the storage file.  | —   | Not selected   |           |
|                           | File name                        | Simple setting   | Select information to be added to the name of the storage file.   | —  | Selected  |
|                           |                                  | Optional setting   | Specify information format to be added to the name of the storage file.   | *1*2   | —         |
|                           | Add date type                    | Add date/time when the file switching condition is satisfied and when the file is created if the optional setting is selected. | —   | —  |           |
| File switching setting    | Number of files to be saved      | Number of files to be saved  | Specify the maximum number of storage files.  | 1 to 65535   | 1         |
|                           |                                  | Operation when exceeds the number of files   | Select the operation when the number of storage files exceeds the maximum number specified. For details, refer to "When the maximum number of storage files to be saved is exceeded" in the manual for the CPU module used.<br>☞ RELEVANT MANUALS | <ul style="list-style-type: none"> <li>Overwrite</li> <li>Stop</li> </ul>  | Overwrite |
|                           | File switching timing*3          | Number of records  | Select the timing at which the file is replaced with new one. When "Number of records" is selected, the file is replaced when the number of records exceeds the specified value.  | <ul style="list-style-type: none"> <li>SD memory card: 1 to 65500</li> <li>Function memory: 1 to 12000</li> </ul>                | —         |
|                           |                                  | File size  | When "File size" is selected, the file is replaced when the file size exceeds the specified size.   | <ul style="list-style-type: none"> <li>SD memory card: 10 to 16384K bytes</li> <li>Function memory: 10 to 1024K bytes</li> </ul> | —         |
|                           |                                  | Condition specification*4  | When "Condition specification" is selected, the file is replaced when the device value meets the condition. For details, refer to "File switching condition" in the manual for the CPU module used.<br>☞ RELEVANT MANUALS                         | For details, refer to "File switching condition" in the manual for the CPU module used.<br>☞ RELEVANT MANUALS                    | —         |

\*1 Date and/or time can be added in any format by using the following character strings.  
 · Year: YYYY for four-digit expression; YY for two-digit expression  
 · Month: MM

- Day: DD
- Day of the week: ddd (Sunday: Sun, Monday: Mon, Tuesday: Tue, Wednesday: Wed, Thursday: Thu, Friday: Fri, Saturday: Sat)
- Hour: hh
- Minute: mm
- Second: ss

(Example) For June 18, 2014 (Wednesday), 09:30:15, YYYYMMDDdddhhmmss → 20140618Wed093015\_00000001.bin

Also when using the additional information simply as a character string rather than the above format, any character string can be added by enclosing it with double-quotation marks (" ").

(Example) When adding the character string "address" to the file name, "address" → address\_00000001.bin

- \*2 Maximum of 64 single-byte characters (including an underscore (\_), a serial number (eight digits), a period, and an extension) can be used.

However, when a character string that contains double quotation marks (" ") is specified, the maximum number reduces by the number of the double quotation marks.

In a process CPU (redundant mode), since three characters of an identifier are added to a file name at system switching, the save file name should be within 61 single-byte characters (including underscores (\_), a serial number (eight digits), a period, and an extension).

For details on the file name, refer to "Storage file name" in the manual for the CPU module used.

☞ RELEVANT MANUALS

- \*3 Reducing the setting value results in frequent file switching, so that it is possible that the scan time and/or the device/label access service processing time can be extended.

- \*4 When setting specified conditions, check the firmware version of the CPU module.

For details on the firmware version, refer to "Added and Enhanced Functions" in the manual for the CPU module used.

☞ RELEVANT MANUALS

# 6.8 File Transfer

The following window is used to specify the destination when data logging files are sent to the FTP server.

## Window

Data logging files can be transferred to the specified FTP server at the file switching timing.

Transferring files to the FTP server  
If the auto logging function is enabled, this function cannot be used.  
 Auto transfer to data memory after logging is completed when users specify the function memory in data stored destination memory beforehand and do not use the function.

Server Setting...

| Transfer Destination Server Setting List |            |                 |          |                |                    |
|--|------------|-----------------|----------|----------------|--------------------|
| No.                                      | FTP Server | Login User Name | Password | Directory Path | Data Transfer Mode |
| 01                                       |            |                 |          |                |                    |
| 02                                       |            |                 |          |                |                    |
| 03                                       |            |                 |          |                |                    |
| 04                                       |            |                 |          |                |                    |
| 05                                       |            |                 |          |                |                    |
| 06                                       |            |                 |          |                |                    |
| 07                                       |            |                 |          |                |                    |
| 08                                       |            |                 |          |                |                    |
| 09                                       |            |                 |          |                |                    |
| 10                                       |            |                 |          |                |                    |

\*\*If the same directory path in the same transfer destination server is set to another CPU module, the transferred file may be overwritten.  
 Set the FTP server and directory path correctly.

FTP server connection request timeout time  [s] (1-30)



File transfer retry time  [m] (1-1440)  
Files are repeatedly resent during the file transfer retry time.

Adjust directory configuration of FTP server by CPU  
Specify a configuration stored in the directory path of transfer destination FTP server.  
 When users do not specify it, save logging files in the directory of transfer destination FTP server.

Delete files completed transfer  
Delete transferred files in SD memory card or function memory.

## Displayed items

| Item   | Description  | Setting range         | Default      |
|--|--|-----------------------|--------------|
| Transferring files to the FTP server <sup>*1</sup> | Select the checkbox to transfer files to the FTP server. | Selected/Not selected | Not selected |

| Item  | Description   | Setting range   | Default            |
|---|---|---|--------------------|
| [Server Setting] button                             | <p>Specify the FTP server with an IP address or server name.</p> <p>To specify the FTP server with an IP address, input a value in the decimal format.</p> <p>To specify the FTP server with a server name, select the server name. When specifying a server name, set DNS in GX Works3 from the following.</p> <ul style="list-style-type: none"> <li>[Module Parameter] ⇒ [Application Settings] ⇒ [DNS Settings]</li> </ul>  | <ul style="list-style-type: none"> <li>IP address<br/>0.0.0.1 to 223.255.255.254</li> <li>Server Name<br/>1 to 256 single-byte characters (alphanumeric characters and special characters*2) without " * , + / : ; &lt; = &gt; ? \  </li> </ul> | IP address (blank) |
| Port No.  | Set the FTP server control port number.   | 1 to 65535  | 21                 |
| Login User Name                                     | Set the FTP server account (user name).   | 1 to 32 ASCII characters (alphanumeric characters and special characters*2) without " , : ;   | Blank              |
| Login Password                                      | Set the FTP server login password.  | 0 to 32 characters (alphanumeric characters and special characters*2)   | Blank              |
| Confirm Login Password                              |   |   |                    |
| Directory Path                                      | Set the directory path of the file transfer destination. If the specified directory path does not exist, an error occurs at file transfer. When transferring data logging files to the same FTP server from multiple CPU modules, specify different directory paths for the file transfer destinations. If the same directory path is specified, files may be overwritten with each other.  | 1 to 64 single-byte characters (alphanumeric characters and special characters*2) without a space and " * , . : ; < > ?   | /                  |
| Data Transfer Mode                                  | Specify the FTP data transfer mode. Generally, specify the PORT mode. If communications between the CPU module and the FTP server allow only the PASV mode due to Windows firewall, specify the PASV mode.  | <ul style="list-style-type: none"> <li>PORT Mode (Normal)</li> <li>PASV Mode</li> </ul>   | PORT Mode (Normal) |
| [File Transfer Test] button                         | <p>Click this to execute the file transfer test.</p> <p>For details, refer to "File transfer test" in the manual for the CPU module used.</p> <p> RELEVANT MANUALS</p>   | —   | —                  |
| Transfer Destination Server Setting List            | Settings for each setting number configured in the "FTP Setting" screen are displayed. The contents of the settings that should not be duplicated with other settings such as directory path can be checked.  | —   | —                  |
| FTP server connection request timeout time          | Set the waiting time from when the connection request from the CPU module to the FTP server is sent to when the response is received.   | 1 to 30 seconds   | 10 seconds         |
| File transfer retry time                            | Set the time to retry the file transfer when the file transfer fails due to an error caused by communication failure such as the network error between the CPU module and the FTP server.   | 1 to 1440 minutes   | One minute         |
| Adjust directory configuration of FTP server by CPU | When the data logging files are transferred, a directory is automatically created in the directory path specified by the FTP server so that the structure is the same as the storage destination.   | Selected/Not selected   | Selected           |
| Delete files completed transfer                     | <p>At the completion of data logging file transfer, transferred files are automatically deleted. For details, refer to "Deleting files completed transfer" in the manual for the CPU module used.</p> <p> RELEVANT MANUALS</p> <p>When "CPU built-in memory (function memory)" is specified for the storage destination of the data logging files, the setting is always selected.</p> | Selected/Not selected   | Not selected       |

\*1 When using the data logging file transfer function of a CPU module, check the module type and the firmware version of a supported CPU module.

For details on the firmware version, refer to "Added and Enhanced Functions" in the manual for the CPU module used.

 RELEVANT MANUALS

\*2 A space, !"#\$%&'()\*+,-./:;<=>?@[ \ ] ^ \_ `{|}~

## 6.9 Movement

The following window is used to specify the data logging operation when the operating status of the CPU module is changed to RUN state.

### Window

Specify logging operation.

Operation at transition to RUN

Specify logging operation at data logging settings registered status when the CPU module power is ON->RUN, reset->RUN, or the CPU module operation status is STOP->RUN.

Auto Start

Start by User Operation

### Displayed items

| Item                           | Description  | Setting range  | Default    |
|--------------------------------|--|--|------------|
| Operation at transition to RUN | Select the operation when the operating status of the CPU module is switched to RUN state. | <ul style="list-style-type: none"><li>• Auto Start</li><li>• Start by User Operation</li></ul> | Auto Start |



# 6.10 Finish

The following window is used to name the data logging setting.

## Window

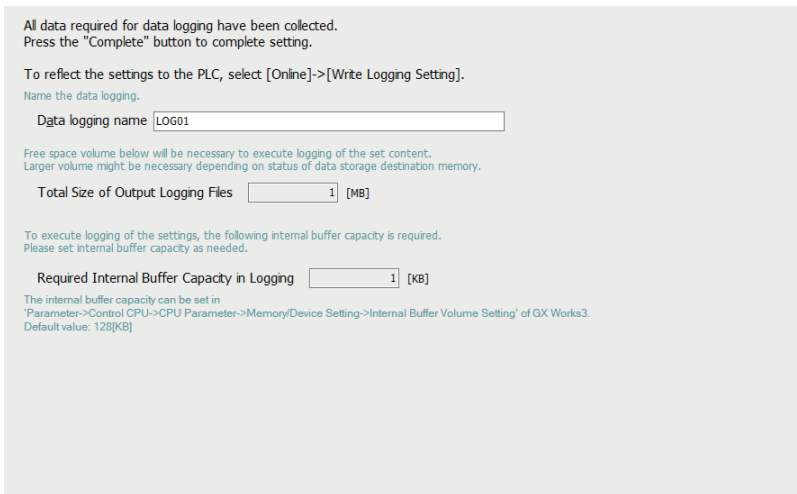

## Displayed items

| Item   | Description   | Setting range         | Default           |
|--|---|-----------------------|-------------------|
| Data logging name <sup>*1</sup>                  | Give the data logging setting being configured a name.  | 32 characters or less | LOG (setting No.) |
| Total Size of Output Logging Files <sup>*2</sup> | The total capacity of data logging files which are output based on the specified settings is displayed. It can be adjusted by items to be output to the files.  | —                     | 1                 |
| Required Internal Buffer Capacity in Logging     | The internal buffer capacity required to execute the data logging based on the specified settings is displayed. It can be specified with the internal buffer capacity setting of GX Works3. For details, refer to "Internal buffer capacity setting" in the manual for the CPU module used.<br>RELEVANT MANUALS | —                     | 1                 |

- \*1 When the following user action is detected, character entry will be disabled.
  - Entering a character which cannot be handled with the OS language character code.
  - Entering a character whose language code is different from the one for characters already input in the same data logging setting.
- \*2 For transferring a data logging file from the CPU built-in memory (function memory) to the data memory, the free space in the data memory can be checked in the "Online Data Operation" screen of GX Works3. ( GX Works3 Operating Manual)

# 7 COMMON SETTING

The common setting includes the auto logging common setting.

For details on the auto logging function of a CPU module, refer to "Auto Logging" in the manual for the CPU module used.

☞ RELEVANT MANUALS

## Operating procedure

Select [RCPU] ⇒ [Common Setting] ⇒ [Auto logging common setting] in the edit item tree.

## 7.1 Auto Logging Common Setting

The following window is used to configure the required settings for using the auto logging function.

### Window

Set for auto logging function.

Enable the auto logging function  
Inserting an SD memory card into the CPU in RUN status starts operation.  
 Save the target data logging setting in the SD memory card before inserting the card.

The auto logging function does not operate according to the logging setting in the data memory.  
 Logging being operated when the SD memory card is inserted,  
 the auto logging function does not start operating.

**Auto logging terminate condition**  
Specify conditions for terminating auto logging.  
 If two or more conditions are selected, logging will terminate when any of the conditions is met.

**Data logging stop**  
Select when to terminate auto logging operation.

When all data loggings stop  
 When any of the data loggings stops

**Timer**

Complete with timer  
Terminates logging after a specified period of time has elapsed after logging starts.

Elapsed time  [s] (1-86400)

### Displayed items

| Item                             | Description                              | Setting range  | Default                     |
|----------------------------------|--|--|-----------------------------|
| Enable the auto logging function | Select the checkbox to use auto logging. | —  | Not selected                |
| Auto logging terminate condition | Data logging stop                        | <ul style="list-style-type: none"> <li>When all data loggings stop</li> <li>When any of the data loggings stops</li> </ul> | When all data loggings stop |
|                                  | Timer                                    | Complete with timer  | —                           |
|                                  | Elapsed time                             | Specify the time from the start of the data logging until stopping it.   | 1 to 86400 seconds          |



# 8 READING/WRITING/DELETING LOGGING SETTINGS

This chapter shows the operations to read, write, and delete logging settings. To perform these operations, set a target CPU module to be connected in advance.

## Transfer setup

The following window is used to specify the communication route between a CPU module and a personal computer.

### Window

Select [Online] ⇒ [Transfer Setup].

### Operating procedure

Set each item and click the [OK] button.

### Displayed items

| Item  | Description   |                    |
|---|---|--------------------|
| PC Side I/F   | Connection Method   |                    |
|   | Select the connection interface of a personal computer on which CPU Module Logging Configuration Tool is installed. |                    |
| PLC Side I/F  | Connection Method   |                    |
|   | CPU Module  | Direct Connection  |
|   |   | Connection via hub |
|   | Select this to connect a personal computer and a CPU module directly with an Ethernet cable.                        |                    |
| Select this to connect a personal computer and a CPU module via a hub with an Ethernet cable. Enter the IP address or host name of a CPU module, and select a protocol. |   |                    |
| GOT Transparent   | Module Side   |                    |
|   | GOT Side  |                    |
| Specify the IP address of a CPU module to be connected to a GOT.  |   |                    |
| Specify the IP address, host name, or port number of a GOT to be connected to a personal computer.  |   |                    |
| Communication Time Check  |   |                    |
| Specify the communication time.   |   |                    |
| Retry Count   |   |                    |
| Specify the number of retries.  |   |                    |

| Item                               | Description   |
|------------------------------------|---|
| Connect to RnPCPU (Redundant Mode) | <p>Select the checkbox when connecting to a process CPU (redundant mode), and select a connection target system.*1</p> <p>Note that the connection target system will not change even though a system switching is performed. To change the connection target system, perform the following operations.</p> <ul style="list-style-type: none"> <li>• Opening the "Read Logging Setting" screen, "Delete Logging Setting" screen, "Logging Status and Operation" screen, and "Logging File Operation" screen again</li> <li>• Changing the selection of "Online operation" in the "Read Logging Setting" screen and the "Delete Logging Setting" screen</li> <li>• Writing logging settings again (when systems are switched after clicking the [Write] button)</li> <li>• Restarting monitoring in the "Logging Status and Operation" screen (when monitoring has stopped due to system switching)</li> </ul> |
| [Communication Test] button        | Click this to check the communication status.   |

\*1 If "Not Specified System" is selected, the personal computer is connected with the host station.

# 8.1 Reading Logging Settings

The following window is used to read the logging setting from the target memory in a CPU module.

## Window

Select [Online] ⇒ [Read Logging Setting].

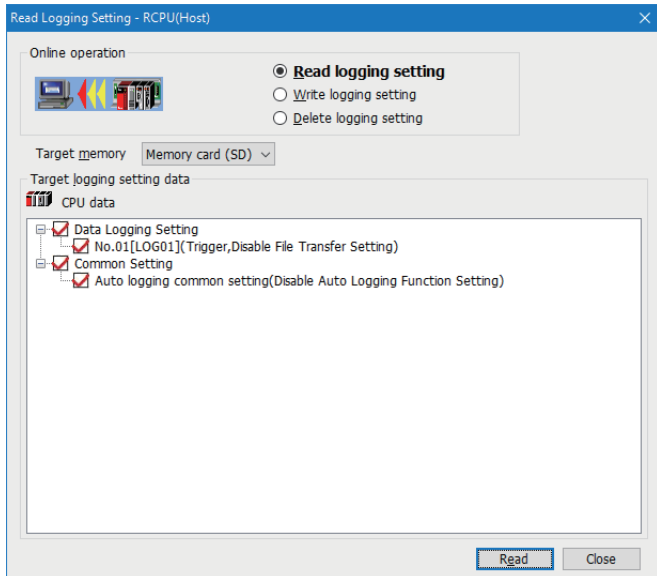

## Operating procedure

1. Select the memory where the setting data to be read is stored from "Target memory."
2. Select the checkbox of the setting data to be read in "Target logging setting data," and click the [Read] button.

### Point

Any existing data (data logging setting with the same setting number or common setting) on the target is overwritten.

## 8.2 Writing Logging Settings

The following window is used to write the logging setting to the target memory in a CPU module.

### Window

Select [Online] ⇒ [Write Logging Setting].

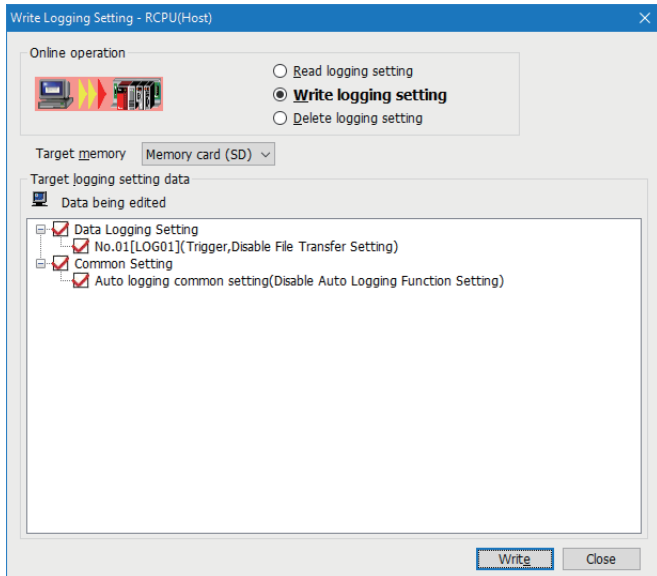

### Operating procedure

1. Select the memory to which the setting data is written from "Target memory."
  2. Select the checkbox of the setting data to be written in "Target logging setting data," and click the [Write] button.<sup>\*1\*2</sup>
- \*1 In the backup mode of a process CPU (redundant mode), data can be written to both systems or one of the systems. Click the [Write] button and a screen appears. Select whether or not to write data to both systems.
- \*2 The data logging setting using the function memory as the data storage destination memory cannot be written to the SD memory card. Therefore, the setting is not displayed when "Memory card (SD)" is selected for "Target memory."

### Point

Any existing data (data logging setting with the same setting number or common setting) on the target is overwritten.

## 8.3 Deleting Logging Settings

The following window is used to delete the logging setting on the target memory in a CPU module.

### Window

Select [Online] ⇒ [Delete Logging Setting].

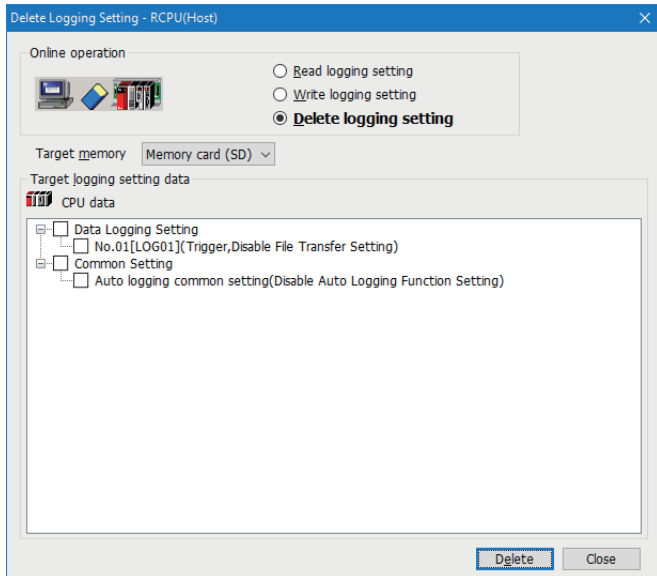

### Operating procedure

1. Select the memory where the setting data to be deleted is stored from "Target memory."
2. Select the checkbox of the setting data to be deleted in "Target logging setting data," and click the [Delete] button.



This chapter shows the operation to execute or stop the logging. Also, the logging status can be checked.

To perform this operation, a target CPU module needs to be set in the transfer setup in advance. (Page 42 Transfer setup)

## Window

Select [Online] ⇒ [Logging Status and Operation].

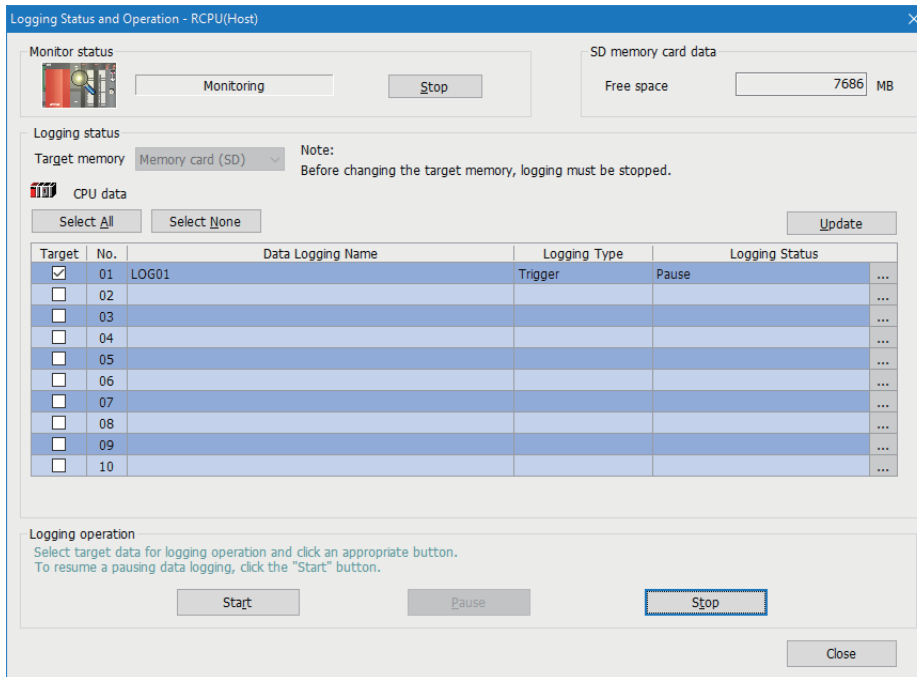

## Operating procedure

### ■ Starting or stopping monitoring

1. Start monitoring by clicking the [Start] button.

The logging status of a monitoring target is displayed under "Logging status." When an error occurs, the error details screen appears by clicking the [...] button.

2. Click the [Stop] button to stop monitoring.

### ■ Starting or stopping the data logging

1. Specify the target memory (either data memory or SD memory card) where the effective setting data is stored.

This can be selected only when all the logging statuses are "Stop."

2. Select the checkbox of the setting number to be executed. (Multiple selections allowed)

3. Start the data logging by clicking the [Start] button. (When multiple items are selected, they are executed simultaneously.)\*1

\*1 The data logging can be registered with any of the following operations if "Operation at transition to RUN" is set to "Auto Start." (The data logging is registered again when any of the following operations is performed.)

- Powering OFF and ON
- Reset
- STOP→RUN

4. Click the [Pause] button to suspend the data logging, and the [Stop] button to stop the data logging. (When multiple items are selected, they are executed simultaneously.)

**Point** 

- 
- The data logging cannot be started even when writing the setting and powering OFF and ON or resetting the CPU module. Be sure to click the [Start] button to start the data logging (except for the auto logging).
  - With regards to the trigger logging, the data logging setting registration attempt fails if the trigger condition is satisfied.
  - It takes a certain time to stop or suspend the data logging after either of these commands is issued by CPU Module Logging Configuration Tool (because the data logging is not stopped or suspended unless the data stored in the internal buffer has been transferred into the SD memory card in response to these commands).
  - There may be a case where a time-out error occurs and the logging is suspended after CPU Module Logging Configuration Tool starts the logging.
-

# 10 SAVING/DELETING DATA LOGGING FILES

This chapter shows the operation to save/delete data logging files in an SD memory card or the data memory to/from a personal computer.

To perform this operation, a target CPU module needs to be set in the transfer setup in advance. (📖 Page 42 Transfer setup)

## Window

Select [Online] ⇒ [Logging File Operation].

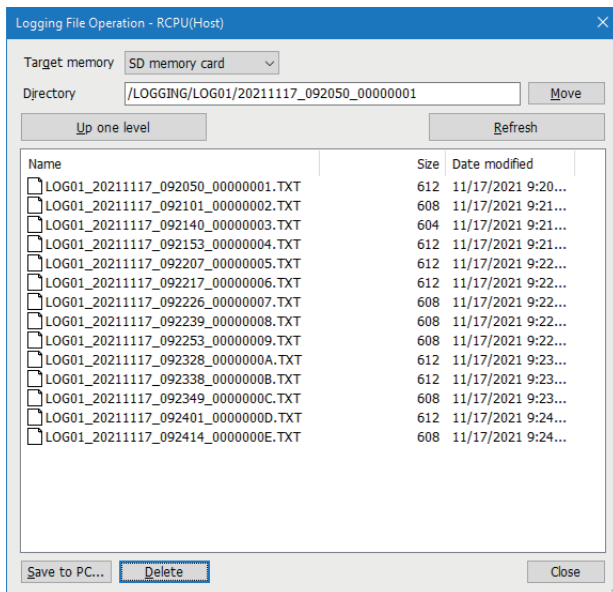

## Operating procedure

1. Select the memory where the data to be operated is stored from "Target memory."
2. Specify the directory and select the target file.
3. To save the file, click the [Save to PC] button. To delete it, click the [Delete] button.

### Point

Attempting the following operations may result in delay of other monitoring update because a certain time period is required for saving data logging files.

- Saving a data logging file while the data logging function is being performed
- Saving a large-volume data logging file

# MEMO

---

# 11 CHECKING FILE TRANSFER STATUS OF DATA LOGGING FILES

This chapter shows the operations to check the file transfer status to the FTP server.

To perform this operation, a target CPU module needs to be set in the transfer setup in advance. (☞ Page 42 Transfer setup)

## Window

Select [Online] ⇒ [Data Logging File Transfer Status].

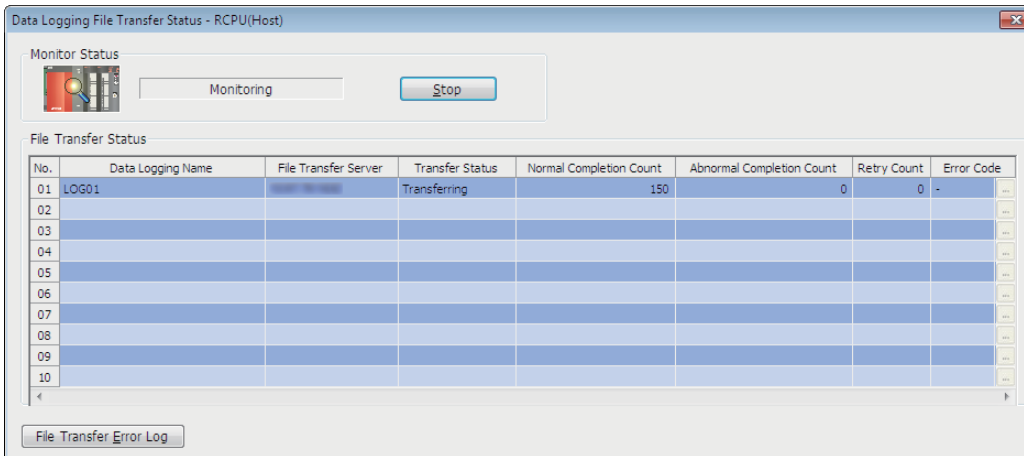

## Displayed items

| Item                             | Description  |   |
|----------------------------------|--|---|
| [Start] (Stop) button            | Click this to start monitoring while the monitoring stops and stop monitoring during the monitoring. |   |
| File Transfer Status             | No.  | The data logging setting number is displayed.   |
|                                  | Data Logging Name  | The data logging name is displayed.   |
|                                  | File Transfer Server   | When the FTP server is specified with an IP address in the server setting, only the IP address is displayed. When the FTP server is specified with a server name, both of the IP address and server name are displayed.*1   |
|                                  | Transfer Status  | The transfer status of the data logging file is displayed. <ul style="list-style-type: none"> <li>—: The data logging file transfer setting is not set.</li> <li>Stopped: File transfer is stopped.</li> <li>Retrying: The file whose transfer failed is being transferred again.</li> <li>Transferring: Files are being transferred.</li> <li>Waiting for transfer: Files are waiting to be transferred, or there is no file to be transferred.</li> </ul> |
|                                  | Normal Completion Count  | The number of data logging files that have been transferred to the FTP server is displayed.   |
|                                  | Abnormal Completion Count  | The number of data logging files that have not been transferred to the FTP server is displayed.   |
|                                  | Retry Count  | The number of retries is displayed.   |
|                                  | Error Code   | The error code of the latest data logging file transfer function error is displayed. For details on error codes, refer to "List of Error Codes" in the manual for the CPU module used. (☞ RELEVANT MANUALS)   |
| [...] button                     | This button is displayed when an error has occurred. Click this to display the error details screen. |   |
| [File Transfer Error Log] button | Click this to display the error history screen. (☞ Page 52 File transfer error log)                  |   |

\*1 When the FTP server is specified with the server name, the IP address is displayed in parentheses while the server is connected. Before the connection with the server is established, "—" is displayed in parentheses.

## File transfer error log

The following window is used to display the error history of the data logging file transfer function. Up to 20 errors are displayed. When the number of errors exceeds 20, logs are deleted in order from the oldest one. The error history is retained after the power is turned OFF and ON or the reset operation is performed.

### Window

Click the [File Transfer Error Log] button in the "Data Logging File Transfer Status" screen.

| Status | Date                | Data Logging Setting No. | File Name                          | File Transfer Server | Error Code |
|--------|---------------------|--------------------------|------------------------------------|----------------------|------------|
| Error  | 2017/11/08 16:24:52 | 01                       | LOG01_20171108_162451_00000014.TXT | 192.168.1.100        | 4COBH      |
| Error  | 2017/11/08 16:24:51 | 01                       | LOG01_20171108_162450_00000013.TXT | 192.168.1.100        | 4COBH      |
| Error  | 2017/11/08 16:24:51 | 01                       | LOG01_20171108_162450_00000012.TXT | 192.168.1.100        | 4COBH      |
| Error  | 2017/11/08 16:24:50 | 01                       | LOG01_20171108_162449_00000011.TXT | 192.168.1.100        | 4COBH      |
| Error  | 2017/11/08 16:24:50 | 01                       | LOG01_20171108_162449_00000010.TXT | 192.168.1.100        | 4COBH      |
| Error  | 2017/11/08 16:24:49 | 01                       | LOG01_20171108_162448_00000009.TXT | 192.168.1.100        | 4COBH      |
| Error  | 2017/11/08 16:24:48 | 01                       | LOG01_20171108_162448_00000008.TXT | 192.168.1.100        | 4COBH      |
| Error  | 2017/11/08 16:24:48 | 01                       | LOG01_20171108_162447_00000007.TXT | 192.168.1.100        | 4COBH      |
| Error  | 2017/11/08 16:24:47 | 01                       | LOG01_20171108_162446_00000006.TXT | 192.168.1.100        | 4COBH      |
| Error  | 2017/11/08 16:24:47 | 01                       | LOG01_20171108_162446_00000005.TXT | 192.168.1.100        | 4COBH      |
| Error  | 2017/11/08 16:24:46 | 01                       | LOG01_20171108_162445_00000004.TXT | 192.168.1.100        | 4COBH      |
| Error  | 2017/11/08 16:24:45 | 01                       | LOG01_20171108_162445_00000003.TXT | 192.168.1.100        | 4COBH      |
| Error  | 2017/11/08 16:24:45 | 01                       | LOG01_20171108_162444_00000002.TXT | 192.168.1.100        | 4COBH      |
| Error  | 2017/11/08 16:24:44 | 01                       | LOG01_20171108_162444_00000001.TXT | 192.168.1.100        | 4COBH      |
| Error  | 2017/11/08 16:24:44 | 01                       | LOG01_20171108_162443_00000000.TXT | 192.168.1.100        | 4COBH      |
| Error  | 2017/11/08 16:24:43 | 01                       | LOG01_20171108_162442_00000000.TXT | 192.168.1.100        | 4COBH      |
| Error  | 2017/11/08 16:24:43 | 01                       | LOG01_20171108_162442_00000000.TXT | 192.168.1.100        | 4COBH      |
| Error  | 2017/11/08 16:24:42 | 01                       | LOG01_20171108_162441_00000000.TXT | 192.168.1.100        | 4COBH      |
| Error  | 2017/11/08 16:24:41 | 01                       | LOG01_20171108_162440_00000000.TXT | 192.168.1.100        | 4COBH      |
| Error  | 2017/11/08 16:24:41 | 01                       | LOG01_20171108_162440_00000000.TXT | 192.168.1.100        | 4COBH      |

### Displayed items

| Item                     | Description  |
|--------------------------|--|
| Status                   | The file transfer status is displayed.<br>• Error  |
| Date                     | The date when the data logging file transfer function error occurred is displayed.   |
| Data Logging Setting No. | The data logging setting number where the data logging file transfer function error has occurred is displayed.   |
| File Name                | The data logging file name where the data logging file transfer function error has occurred is displayed.*1  |
| File Transfer Server     | The IP address of the transfer destination server where the data logging file transfer function error has occurred is displayed.*2   |
| Error Code               | The data logging file transfer function error that has occurred is displayed.<br>For details on error codes, refer to "List of Error Codes" in the manual for the CPU module used. ( RELEVANT MANUALS) |
| [...] button             | This button is displayed when an error has occurred. Click this to display the error details screen.   |
| [Update] button          | Click this to obtain the error history in a CPU module again and display it.   |
| [Clear Log] button       | Click this to clear the error history in a CPU module.   |

\*1 When the data logging file transfer is stopped or there is no file to be transferred, "-" is displayed.

\*2 Even when the FTP server is specified with the server name in the server setting, the IP address is displayed. However, when the server is not connected, "-" is displayed.

# 12 HELP OPERATIONS

---

This chapter shows the help function of CPU Module Logging Configuration Tool.

## 12.1 Opening Manual

---

e-Manual Viewer starts and the manual appears.

### Operating procedure

Select [Help] ⇒ [Open Manual].

## 12.2 Connection to MITSUBISHI ELECTRIC FA Global Website

---

Access the Mitsubishi Electric FA website.

### Operating procedure

Select [Help] ⇒ [Connection to MITSUBISHI ELECTRIC FA Global Website].

## 12.3 Version Information

---

Check the version of CPU Module Logging Configuration Tool.

### Operating procedure

Select [Help] ⇒ [About Configuration tool].

# MEMO

---



# APPENDIX

## Appendix 1 Additions and Changes from Previous Version

The following table shows the functions added and changed in CPU Module Logging Configuration Tool and the applicable software version.

SW1DNN-LLUTL-J (Japanese), SW1DNN-LLUTL-E (English), and SW1DNN-LLUTL-C (Chinese) are integrated into SW1DNN-LLUTL-M (Multiple languages) Version 1.46Y.

- SW1DNN-LLUTL-M (Multiple languages)

| Added/changed contents   | Applicable software version |
|--|-----------------------------|
| Display languages can be switched.   | 1.46Y or later              |
| MELSEC iQ-R series safety CPU modules (R08SFPCPU, R16SFPCPU, R32SFPCPU, and R120SFPCPU) are supported.   | 1.49B or later              |
| MELSEC iQ-R series CC-Link IE built-in CPU modules (R04ENCPU, R08ENCPU, R16ENCPU, R32ENCPU, and R120ENCPU) are supported.  |                             |
| The device range that can be specified is extended in the data logging function of RCPUs.  |                             |
| The following device can be specified in the data logging function of RCPUs. <ul style="list-style-type: none"> <li>• BL□IS</li> </ul>                             |                             |
| The following operating systems are supported. <ul style="list-style-type: none"> <li>• German version</li> <li>• Italian version</li> </ul>                       | 1.54G or later              |
| The following device can be specified in the data logging function of RnPCPUs. <ul style="list-style-type: none"> <li>• BL□IS</li> </ul>                           |                             |
| MELSEC iQ-R series redundant programmable controller (redundant mode of RnPCPUs) is supported.   | 1.58L or later              |
| Windows 10 (32-bit version and 64-bit version) is supported.   |                             |
| A device copied in another application can be pasted/inserted into the start device column in the "Data" setting screen.   | 1.70Y or later              |
| CPU Module Logging Configuration Tool can be started from GX Works3.   |                             |
| MELSEC iQ-R series CPU modules (R00CPU, R01CPU, and R02CPU) are supported.   | 1.76E or later              |
| Logging to the CPU built-in memory (function memory) is supported in the data logging function of RCPUs.   |                             |
| The data logging file transfer function of RCPUs is supported.   |                             |
| Windows 10 IoT Enterprise is supported.  | 1.82L or later              |
| A label/local device can be specified in the data logging function of RCPUs (RnCPU and RnENCPU).   |                             |
| An extension of the maximum number of points for link direct device of RnPCPUs is supported.   | 1.100E or later             |
| Generating the logging file in CSV format of RCPUs is supported.   | 1.112R or later             |
| Windows XP® and Windows Vista® are no longer supported.  |                             |
| "Insert Copied Setting Item" and "Insert Cut Setting Item" are changed to "Insert and Paste Setting Item."   | 1.118X or later             |
| A data logging setting item can be pasted into another data logging setting.   |                             |
| Windows 11 is supported.   | 1.130L or later             |
| Windows 7, Windows 8, and Windows 8.1 are no longer supported.   | 1.142Y or later             |
| MELSOFT Update Manager is supported.   |                             |
| A personal computer and a CPU module can be connected via a GOT (GOT transparent function). (Only Ethernet or USB connection for the GOT2000 series is supported.) |                             |

- SW1DNN-LLUTL-J (Japanese)

| Added/changed contents  | Applicable software version |
|---|-----------------------------|
| MELSEC iQ-R series CPU modules (R04CPU, R08CPU, R16CPU, R32CPU, and R120CPU) are supported.     | 1.35M                       |
| The realtime monitor function of RCPUs is supported.  | 1.40S                       |
| MELSEC iQ-R series process CPU modules (R08PCPU, R16PCPU, R32PCPU, and R120PCPU) are supported. | 1.43V                       |

A

- SW1DNN-LLUTL-E (English)

| Added/changed contents  | Applicable software version |
|---|-----------------------------|
| MELSEC iQ-R series CPU modules (R04CPU, R08CPU, R16CPU, R32CPU, and R120CPU) are supported.     | 1.35M                       |
| The realtime monitor function of RCPUs is supported.  | 1.40S                       |
| MELSEC iQ-R series process CPU modules (R08PCPU, R16PCPU, R32PCPU, and R120PCPU) are supported. | 1.43V                       |

# Appendix 2 Supported Characters

This section shows the supported characters.

## Supported characters for CPU Module Logging Configuration Tool

Any characters that can be expressed by Unicode are supported. However, the supported characters vary for each position as shown in the following table. Note that if attempting to input an unsupported character, the entry is rejected or a message screen appears in response to the improper entry.

| Place where character is used   |  | Support status of the target character |   |   |   |   |   |   |   |   |   |   |   |   |   |   |   |   |                       |   |
|---------------------------------|--|--|---|---|---|---|---|---|---|---|---|---|---|---|---|---|---|---|-----------------------|---|
|                                 |  | (SP) <sup>*1</sup>                     | " | ' | * | + | , | / | : | ; | < | > | ? | [ | \ | ] |   | . | Double-byte character |   |
| Data Logging Setting            | <ul style="list-style-type: none"> <li>Data Logging Name</li> <li>String for Indicating Trigger Occurrence</li> <li>Comment</li> </ul> | ○                                      | × | ○ | ○ | ○ | × | ○ | ○ | × | ○ | ○ | ○ | ○ | ○ | ○ | ○ | ○ | ○                     | ○ |
|                                 | Date Line Output Format  | ○                                      | × | ○ | ○ | ○ | × | ○ | ○ | × | ○ | ○ | ○ | ○ | ○ | ○ | ○ | ○ | ○                     | × |
| "Logging File Operation" screen | Directory  | ×                                      | × | ○ | × | ○ | × | ○ | × | × | × | × | ○ | × | ○ | × | × | × | ×                     |   |

\*1 (SP) means a space.



Surrogate pair characters cannot be used.

## Supported characters for the file name and the folder (directory) name

Characters in the shaded area can be used.

|   | 0    | 1 | 2    | 3 | 4 | 5 | 6 | 7 | 8 | 9 |
|---|------|---|------|---|---|---|---|---|---|---|
| 0 | NULL |   | (SP) | 0 | @ | P | ` | p |   |   |
| 1 |      |   | !    | 1 | A | Q | a | q |   |   |
| 2 |      |   | "    | 2 | B | R | b | r |   |   |
| 3 |      |   | #    | 3 | C | S | c | s |   |   |
| 4 |      |   | \$   | 4 | D | T | d | t |   |   |
| 5 |      |   | %    | 5 | E | U | e | u |   |   |
| 6 |      |   | &    | 6 | F | V | f | v |   |   |
| 7 |      |   | '    | 7 | G | W | g | w |   |   |
| 8 |      |   | (    | 8 | H | X | h | x |   |   |
| 9 |      |   | )    | 9 | I | Y | i | y |   |   |
| A |      |   | *    | : | J | Z | j | z |   |   |
| B |      |   | +    | ; | K | [ | k | { |   |   |
| C |      |   | ,    | < | L | \ | l |   |   |   |
| D |      |   | -    | = | M | ] | m | } |   |   |
| E |      |   | .    | > | N | ^ | n | ~ |   |   |
| F |      |   | /    | ? | O | _ | o |   |   |   |

# Appendix 3 USB Driver Installation Procedure

---

To communicate with a CPU module via USB, installing a USB driver is required.

## Operating procedure

1. Connect a personal computer and a CPU module with a USB cable, and turn the power of the programmable controller ON.
2. Right-click "Unknown Device" and click "Update driver" in Windows Device Manager.
3. Select "Browse my computer for drivers" in the "Update Drivers" screen, and specify 'Easysocket\USBDrivers' in the folder where CPU Module Logging Configuration Tool is installed on the next screen.

When an installation folder is not changed at the installation, the installation folder is as follows:

- 64-bit version operating system: C:\Program Files (x86)\MELSOFT\Easysocket\USBDrivers
- 32-bit version operating system: C:\Program Files\MELSOFT\Easysocket\USBDrivers

If multiple MELSOFT products are already installed, specify 'Easysocket\USBDrivers' which is in the folder of the first product installed.

If 'Easysocket\USBDrivers' does not exist, search for 'USBDrivers' in the Windows explorer.

# REVISIONS

\*The manual number is given on the bottom left of the back cover.

| Revision date | *Manual number     | Description   |
|---------------|--------------------|---|
| July 2022     | SH(NA)-082478ENG-A | First edition<br>(Due to the revision of 'MELSEC iQ-R CPU Module User's Manual (Application),' the descriptions for CPU Module Logging Configuration Tool have been separated.) |
| April 2023    | SH(NA)-082478ENG-B | ■Added or modified parts<br>Section 2.2, Section 5.6, Chapter 8, Appendix 1   |

Japanese manual number: SH-082477-B

This manual confers no industrial property rights or any rights of any other kind, nor does it confer any patent licenses. Mitsubishi Electric Corporation cannot be held responsible for any problems involving industrial property rights which may occur as a result of using the contents noted in this manual.

© 2022 MITSUBISHI ELECTRIC CORPORATION

# TRADEMARKS

---

Microsoft, Windows, Windows Vista, and Windows XP are trademarks of the Microsoft group of companies.

Unicode is either a registered trademark or a trademark of Unicode, Inc. in the United States and other countries.

The company names, system names and product names mentioned in this manual are either registered trademarks or trademarks of their respective companies.

In some cases, trademark symbols such as <sup>™</sup> or <sup>®</sup> are not specified in this manual.



SH(NA)-082478ENG-B(2304)

MODEL: SW1DNN-LLUTL-O-E

## **mitsubishi electric corporation**

HEAD OFFICE: TOKYO BLDG., 2-7-3, MARUNOUCHI, CHIYODA-KU, TOKYO 100-8310, JAPAN  
NAGOYA WORKS: 1-14, YADA-MINAMI 5-CHOME, HIGASHI-KU, NAGOYA 461-8670, JAPAN

When exported from Japan, this manual does not require application to the  
Ministry of Economy, Trade and Industry for service transaction permission.

Specifications subject to change without notice.