

Programmable Controller

MELSEC iQ-R
series

MELSEC iQ-R MELSECNET/H Network Module User's Manual (Startup)

-RJ71LP21-25
-RJ71BR11

SAFETY PRECAUTIONS



(Read these precautions before using this product.)

Before using this product, please read this manual and the relevant manuals carefully and pay full attention to safety to handle the product correctly.

If the equipment is used in a manner not specified by the manufacturer, the protection provided by the equipment may be impaired.

The precautions given in this manual are concerned with this product only. For the safety precautions of the programmable controller system, refer to the MELSEC iQ-R Module Configuration Manual.

In this manual, the safety precautions are classified into two levels: "⚠️ WARNING" and "⚠️ CAUTION".

 WARNING	Indicates that incorrect handling may cause hazardous conditions, resulting in death or severe injury.
 CAUTION	Indicates that incorrect handling may cause hazardous conditions, resulting in minor or moderate injury or property damage.

Under some circumstances, failure to observe the precautions given under "⚠️ CAUTION" may lead to serious consequences.

Observe the precautions of both levels because they are important for personal and system safety.

Make sure that the end users read this manual and then keep the manual in a safe place for future reference.

[Design Precautions]

WARNING

- Configure safety circuits external to the programmable controller to ensure that the entire system operates safely even when a fault occurs in the external power supply or the programmable controller. Failure to do so may result in an accident due to an incorrect output or malfunction.
 - (1) Emergency stop circuits, protection circuits, and protective interlock circuits for conflicting operations (such as forward/reverse rotations or upper/lower limit positioning) must be configured external to the programmable controller.
 - (2) When the programmable controller detects an abnormal condition, it stops the operation and all outputs are:
 - Turned off if the overcurrent or overvoltage protection of the power supply module is activated.
 - Held or turned off according to the parameter setting if the self-diagnostic function of the CPU module detects an error such as a watchdog timer error.
 - (3) All outputs may be turned on if an error occurs in a part, such as an I/O control part, where the CPU module cannot detect any error. To ensure safety operation in such a case, provide a safety mechanism or a fail-safe circuit external to the programmable controller. For a fail-safe circuit example, refer to "General Safety Requirements" in the MELSEC iQ-R Module Configuration Manual.
 - (4) Outputs may remain on or off due to a failure of a component such as a relay and transistor in an output circuit. Configure an external circuit for monitoring output signals that could cause a serious accident.
 - In an output circuit, when a load current exceeding the rated current or an overcurrent caused by a load short-circuit flows for a long time, it may cause smoke and fire. To prevent this, configure an external safety circuit, such as a fuse.
 - Configure a circuit so that the programmable controller is turned on first and then the external power supply. If the external power supply is turned on first, an accident may occur due to an incorrect output or malfunction.
 - For the operating status of each station after a communication failure, refer to the troubleshooting in the MELSEC iQ-R MELSECNET/H Network Module User's Manual (Application). Incorrect output or malfunction due to a communication failure may result in an accident.
 - If a coaxial cable is disconnected, the network may be unstable, resulting in a communication failure of multiple stations. Configure an interlock circuit in the sequence program to ensure that the entire system will always operate safely even if communications fail in multiple stations. Failure to do so may result in an accident due to an incorrect output or malfunction.
 - When connecting an external device with a CPU module or intelligent function module to modify data of a running programmable controller, configure an interlock circuit in the program to ensure that the entire system will always operate safely. For other forms of control (such as program modification, parameter change, forced output, or operating status change) of a running programmable controller, read the relevant manuals carefully and ensure that the operation is safe before proceeding. Improper operation may damage machines or cause accidents.
 - Especially, when a remote programmable controller is controlled by an external device, immediate action cannot be taken if a problem occurs in the programmable controller due to a communication failure. To prevent this, configure an interlock circuit in the program, and determine corrective actions to be taken between the external device and CPU module in case of a communication failure.
-

[Design Precautions]

WARNING

- Do not write any data to the "system area" and "write-protect area" of the buffer memory in the module. Also, do not use any "use prohibited" signals as an output signal from the CPU module to each module. Doing so may cause malfunction of the programmable controller system. For the "system area", "write-protect area", and the "use prohibited" signals, refer to the user's manual for the module used.
 - If a communication cable is disconnected, the network may be unstable, resulting in a communication failure of multiple stations. Configure an interlock circuit in the program to ensure that the entire system will always operate safely even if communications fail. Incorrect output or malfunction due to a communication failure may result in an accident.
-

[Design Precautions]

CAUTION

- Do not install the control lines or communication cables together with the main circuit lines or power cables. Keep a distance of 100mm or more between them. Failure to do so may result in malfunction due to noise.
 - During control of an inductive load such as a lamp, heater, or solenoid valve, a large current (approximately ten times greater than normal) may flow when the output is turned from off to on. Therefore, use a module that has a sufficient current rating.
 - After the CPU module is powered on or is reset, the time taken to enter the RUN status varies depending on the system configuration, parameter settings, and/or program size. Design circuits so that the entire system will always operate safely, regardless of the time.
 - Do not power off the programmable controller or reset the CPU module while the settings are being written. Doing so will make the data in the flash ROM and SD memory card undefined. The values need to be set in the buffer memory and written to the flash ROM and SD memory card again. Doing so also may cause malfunction or failure of the module.
-

[Security Precautions]

WARNING

- To maintain the security (confidentiality, integrity, and availability) of the programmable controller and the system against unauthorized access, denial-of-service (DoS) attacks, computer viruses, and other cyberattacks from external devices via the network, take appropriate measures such as firewalls, virtual private networks (VPNs), and antivirus solutions.
-

[Installation Precautions]

WARNING

- Shut off the external power supply (all phases) used in the system before mounting or removing the module. Failure to do so may result in electric shock or cause the module to fail or malfunction.
-

[Installation Precautions]

CAUTION

- Use the programmable controller in an environment that meets the general specifications in the Safety Guidelines included with the base unit. Failure to do so may result in electric shock, fire, malfunction, or damage to or deterioration of the product.
 - To mount a module, place the concave part(s) located at the bottom onto the guide(s) of the base unit, and push in the module until the hook(s) located at the top snaps into place. Incorrect interconnection may cause malfunction, failure, or drop of the module.
 - To mount a module with no module fixing hook, place the concave part(s) located at the bottom onto the guide(s) of the base unit, push in the module, and fix it with screw(s). Incorrect interconnection may cause malfunction, failure, or drop of the module.
 - When using the programmable controller in an environment of frequent vibrations, fix the module with a screw.
 - Tighten the screws within the specified torque range. Undertightening can cause drop of the screw, short circuit, or malfunction. Overtightening can damage the screw and/or module, resulting in drop, short circuit, or malfunction.
 - When using an extension cable, connect it to the extension cable connector of the base unit securely. Check the connection for looseness. Poor contact may cause malfunction.
 - When using an SD memory card, fully insert it into the SD memory card slot. Check that it is inserted completely. Poor contact may cause malfunction.
 - Securely insert an extended SRAM cassette or a battery-less option cassette into the cassette connector of the CPU module. After insertion, close the cassette cover and check that the cassette is inserted completely. Poor contact may cause malfunction.
 - Do not directly touch any conductive parts and electronic components of the module, SD memory card, extended SRAM cassette, battery-less option cassette, or connector. Doing so can cause malfunction or failure of the module.
-

[Wiring Precautions]

WARNING

- Shut off the external power supply (all phases) used in the system before installation and wiring. Failure to do so may result in electric shock or cause the module to fail or malfunction.
 - After installation and wiring, attach a blank cover module (RG60) to each empty slot and an included extension connector protective cover to the unused extension cable connector before powering on the system for operation. Failure to do so may result in electric shock.
-

[Wiring Precautions]

CAUTION

- Individually ground the FG and LG terminals of the programmable controller with a ground resistance of 100 ohms or less. Failure to do so may result in electric shock or malfunction.
 - Use applicable solderless terminals and tighten them within the specified torque range. If any spade solderless terminal is used, it may be disconnected when the terminal screw comes loose, resulting in failure.
 - Check the rated voltage and signal layout before wiring to the module, and connect the cables correctly. Connecting a power supply with a different voltage rating or incorrect wiring may cause fire or failure.
 - Connectors for external devices and connectors for coaxial cables must be crimped or pressed with the tool specified by the manufacturer, or must be correctly soldered. Incomplete connections may cause short circuit, fire, or malfunction.
 - Securely connect the connector to the module. Poor contact may cause malfunction.
 - Do not install the control lines or communication cables together with the main circuit lines or power cables. Keep a distance of 100mm or more between them. Failure to do so may result in malfunction due to noise.
 - Place the cables in a duct or clamp them. If not, dangling cables may swing or inadvertently be pulled, resulting in malfunction or damage to modules or cables.
In addition, the weight of the cables may put stress on modules in an environment of strong vibrations and shocks.
Do not clamp the extension cables with the jacket stripped. Doing so may change the characteristics of the cables, resulting in malfunction.
 - Check the interface type and correctly connect the cable. Incorrect wiring (connecting the cable to an incorrect interface) may cause failure of the module and external device.
 - Tighten the terminal screws or connector screws within the specified torque range. Undertightening can cause drop of the screw, short circuit, fire, or malfunction. Overtightening can damage the screw and/or module, resulting in drop, short circuit, fire, or malfunction.
 - Properly solder the parts of a soldering-type coaxial cable connector. Incomplete soldering may result in malfunction.
 - Crimp the parts of a crimping-type coaxial cable connector with proper force at a proper position. Failure to do so may cause drop of the cable or malfunction.
 - When disconnecting the cable from the module, do not pull the cable by the cable part. For the cable with connector, hold the connector part of the cable. For the cable connected to the terminal block, loosen the terminal screw. Pulling the cable connected to the module may result in malfunction or damage to the module or cable.
 - Prevent foreign matter such as dust or wire chips from entering the module. Such foreign matter can cause a fire, failure, or malfunction.
 - A protective film is attached to the top of the module to prevent foreign matter, such as wire chips, from entering the module during wiring. Do not remove the film during wiring. Remove it for heat dissipation before system operation.
-

[Wiring Precautions]

CAUTION

- Programmable controllers must be installed in control panels. Connect the main power supply to the power supply module in the control panel through a relay terminal block. Wiring and replacement of a power supply module must be performed by qualified maintenance personnel with knowledge of protection against electric shock. For wiring, refer to the MELSEC iQ-R Module Configuration Manual.
 - For Ethernet cables to be used in the system, select the ones that meet the specifications in the user's manual for the module used. If not, normal data transmission is not guaranteed.
 - For optical fiber cables and coaxial cables to be used in the system, select the ones that meet the specifications in this manual. If not, normal data transmission is not guaranteed.
-

[Startup and Maintenance Precautions]

WARNING

- Do not touch any terminal while power is on. Doing so will cause electric shock or malfunction.
 - Shut off the external power supply (all phases) used in the system before cleaning the module or retightening the terminal screws, connector screws, or module fixing screws. Failure to do so may result in electric shock.
-

[Startup and Maintenance Precautions]

CAUTION

- When connecting an external device with a CPU module or intelligent function module to modify data of a running programmable controller, configure an interlock circuit in the program to ensure that the entire system will always operate safely. For other forms of control (such as program modification, parameter change, forced output, or operating status change) of a running programmable controller, read the relevant manuals carefully and ensure that the operation is safe before proceeding. Improper operation may damage machines or cause accidents.
 - Especially, when a remote programmable controller is controlled by an external device, immediate action cannot be taken if a problem occurs in the programmable controller due to a communication failure. To prevent this, configure an interlock circuit in the program, and determine corrective actions to be taken between the external device and CPU module in case of a communication failure.
 - Do not disassemble or modify the modules. Doing so may cause failure, malfunction, injury, or a fire.
 - Use any radio communication device such as a cellular phone or PHS (Personal Handy-phone System) 25cm or more away in all directions from the programmable controller. Failure to do so may cause malfunction.
-

[Startup and Maintenance Precautions]

CAUTION

- Shut off the external power supply (all phases) used in the system before mounting or removing the module. Failure to do so may cause the module to fail or malfunction.
 - Tighten the screws within the specified torque range. Undertightening can cause drop of the component or wire, short circuit, or malfunction. Overtightening can damage the screw and/or module, resulting in drop, short circuit, or malfunction.
 - After the first use of the product, do not perform each of the following operations more than 50 times (IEC 61131-2/JIS B 3502 compliant).
Exceeding the limit may cause malfunction.
 - Mounting/removing the module to/from the base unit
 - Inserting/removing the extended SRAM cassette or battery-less option cassette to/from the CPU module
 - Mounting/removing the terminal block to/from the module
 - After the first use of the product, do not insert/remove the SD memory card to/from the CPU module more than 500 times. Exceeding the limit may cause malfunction.
 - Do not touch the metal terminals on the back side of the SD memory card. Doing so may cause malfunction or failure of the module.
 - Do not touch the integrated circuits on the circuit board of an extended SRAM cassette or a battery-less option cassette. Doing so may cause malfunction or failure of the module.
 - Startup and maintenance of a control panel must be performed by qualified maintenance personnel with knowledge of protection against electric shock. Lock the control panel so that only qualified maintenance personnel can operate it.
 - Before handling the module, touch a conducting object such as a grounded metal to discharge the static electricity from the human body. Failure to discharge the static electricity may cause the module to fail or malfunction.
 - After unpacking, eliminate static electricity from the module to prevent electrostatic discharge from affecting the module. If an electrostatically charged module comes in contact with a grounded metal object, a sudden electrostatic discharge of the module may cause failure. For details on how to eliminate static electricity from the module, refer to the following.
Antistatic Precautions Before Using MELSEC iQ-R Series Products (FA-A-0368)
-

[Operating Precautions]

CAUTION

- When changing data and operating status, and modifying program of the running programmable controller from an external device such as a personal computer connected to an intelligent function module, read relevant manuals carefully and ensure the safety before operation. Incorrect change or modification may cause system malfunction, damage to the machines, or accidents.
-

[Disposal Precautions]

CAUTION

- When disposing of this product, treat it as industrial waste.
-

[Transportation Precautions]

CAUTION

- The halogens (such as fluorine, chlorine, bromine, and iodine), which are contained in a fumigant used for disinfection and pest control of wood packaging materials, may cause failure of the product. Prevent the entry of fumigant residues into the product or consider other methods (such as heat treatment) instead of fumigation. The disinfection and pest control measures must be applied to unprocessed raw wood.
-

CONDITIONS OF USE FOR THE PRODUCT

- (1) MELSEC programmable controller ("the PRODUCT") shall be used in conditions;
- i) where any problem, fault or failure occurring in the PRODUCT, if any, shall not lead to any major or serious accident; and
 - ii) where the backup and fail-safe function are systematically or automatically provided outside of the PRODUCT for the case of any problem, fault or failure occurring in the PRODUCT.
- (2) The PRODUCT has been designed and manufactured for the purpose of being used in general industries. MITSUBISHI ELECTRIC SHALL HAVE NO RESPONSIBILITY OR LIABILITY (INCLUDING, BUT NOT LIMITED TO ANY AND ALL RESPONSIBILITY OR LIABILITY BASED ON CONTRACT, WARRANTY, TORT, PRODUCT LIABILITY) FOR ANY INJURY OR DEATH TO PERSONS OR LOSS OR DAMAGE TO PROPERTY CAUSED BY THE PRODUCT THAT ARE OPERATED OR USED IN APPLICATION NOT INTENDED OR EXCLUDED BY INSTRUCTIONS, PRECAUTIONS, OR WARNING CONTAINED IN MITSUBISHI ELECTRIC USER'S, INSTRUCTION AND/OR SAFETY MANUALS, TECHNICAL BULLETINS AND GUIDELINES FOR the PRODUCT.
- ("Prohibited Application")
- Prohibited Applications include, but not limited to, the use of the PRODUCT in;
- Nuclear Power Plants and any other power plants operated by Power companies, and/or any other cases in which the public could be affected if any problem or fault occurs in the PRODUCT.
 - Railway companies or Public service purposes, and/or any other cases in which establishment of a special quality assurance system is required by the Purchaser or End User.
 - Aircraft or Aerospace, Medical applications, Train equipment, transport equipment such as Elevator and Escalator, Incineration and Fuel devices, Vehicles, Manned transportation, Equipment for Recreation and Amusement, and Safety devices, handling of Nuclear or Hazardous Materials or Chemicals, Mining and Drilling, and/or other applications where there is a significant risk of injury to the public or property.
- Notwithstanding the above restrictions, Mitsubishi Electric may in its sole discretion, authorize use of the PRODUCT in one or more of the Prohibited Applications, provided that the usage of the PRODUCT is limited only for the specific applications agreed to by Mitsubishi Electric and provided further that no special quality assurance or fail-safe, redundant or other safety features which exceed the general specifications of the PRODUCTS are required. For details, please contact the Mitsubishi Electric representative in your region.
- (3) Mitsubishi Electric shall have no responsibility or liability for any problems involving programmable controller trouble and system trouble caused by DoS attacks, unauthorized access, computer viruses, and other cyberattacks.

INTRODUCTION

Thank you for purchasing the Mitsubishi Electric MELSEC iQ-R series programmable controllers.

This manual describes the procedures, system configuration, and wiring of the relevant products listed below.

Before using this product, please read this manual and the relevant manuals carefully and develop familiarity with the functions and performance of the MELSEC iQ-R series programmable controller to handle the product correctly.

When applying the program examples provided in this manual to an actual system, ensure the applicability and confirm that it will not cause system control problems.

Note that the menu names and operating procedures may differ depending on an operating system in use and its version.

When reading this manual, replace the names and procedures with the applicable ones as necessary.

Please make sure that the end users read this manual.

Relevant product

RJ71LP21-25

RJ71BR11

COMPLIANCE WITH EMC AND LOW VOLTAGE DIRECTIVES

Method of ensuring compliance

To ensure that Mitsubishi Electric programmable controllers maintain the EMC and Low Voltage Directives or other regulations when incorporated into other machinery or equipment, certain measures may be necessary. Please refer to one of the following manuals.

- MELSEC iQ-R Module Configuration Manual (SH-081262ENG)
- Safety Guidelines (IB-0800525)

Certification marks on the side of the programmable controller indicate compliance with the relevant regulations.

Additional measures

To ensure that this product maintains EMC and Low Voltage Directives, please refer to one of the following manuals.

- MELSEC iQ-R Module Configuration Manual (SH-081262ENG)
- Safety Guidelines (IB-0800525)

CONTENTS

SAFETY PRECAUTIONS	1
CONDITIONS OF USE FOR THE PRODUCT	9
INTRODUCTION	9
COMPLIANCE WITH EMC AND LOW VOLTAGE DIRECTIVES	10
RELEVANT MANUALS	13
TERMS	14
GENERIC TERMS AND ABBREVIATIONS	15
CHAPTER 1 PART NAMES	16
1.1 RJ71LP21-25	16
1.2 RJ71BR11	18
CHAPTER 2 SPECIFICATIONS	20
2.1 Performance Specifications	20
RJ71LP21-25	20
RJ71BR11	21
2.2 Cable Specifications	22
Optical fiber cable specifications	22
Coaxial cable specifications	22
CHAPTER 3 FUNCTION LIST	27
CHAPTER 4 PROCEDURES BEFORE OPERATION	30
CHAPTER 5 SYSTEM CONFIGURATION	32
5.1 MELSECNET/H Network Configuration	32
CHAPTER 6 WIRING	34
6.1 Wiring Methods	34
6.2 Wiring Products	41
CHAPTER 7 COMMUNICATION EXAMPLES	42
7.1 Cyclic Transmission Program	42
System configuration example	42
Setting in the control station	44
Setting in the normal stations	47
Checking the network status	49
Program example	50
7.2 Transient Transmission Program	55
System configuration example	55
Setting in the control station	55
Setting in the normal stations	55
Checking the network status	55
Program example	55
APPENDIX	60
Appendix 1 External Dimensions	60

INDEX

62

REVISIONS64
WARRANTY65
TRADEMARKS66

RELEVANT MANUALS

Manual name [manual number]	Description	Available form
MELSEC iQ-R MELSECNET/H Network Module User's Manual (Startup) [SH-082202ENG] (this manual)	System configuration, performance specifications, procedures before operation, wiring, and communication examples of the MELSECNET/H network module	Print book e-Manual PDF
MELSEC iQ-R MELSECNET/H Network Module User's Manual (Application) [SH-082204ENG]	Functions, parameter settings, programming, troubleshooting, and buffer memory of the MELSECNET/H network module	Print book e-Manual PDF
MELSEC iQ-R Ethernet, CC-Link IE, and MELSECNET/H Function Block Reference [BCN-P5999-0381]	Specifications of the following MELSEC iQ-R module function blocks: MELSEC iQ-R Ethernet equipped module function blocks, CC-Link IE TSN module function blocks, CC-Link IE Controller Network module function blocks, CC-Link IE Field Network module function blocks, and MELSECNET/H network module function blocks	e-Manual PDF
MELSEC iQ-R Programming Manual (Module Dedicated Instructions) [SH-081976ENG]	Dedicated instructions for the intelligent function modules	e-Manual PDF
GX Works3 Operating Manual [SH-081215ENG]	System configuration, parameter settings, and online operations of GX Works3	e-Manual PDF

This manual does not include detailed information on the following:

- General specifications
- Applicable combinations of CPU modules and the other modules, and the number of mountable modules
- Installation

For details, refer to the following.

 MELSEC iQ-R Module Configuration Manual

Point

e-Manual refers to the Mitsubishi Electric FA electronic book manuals that can be browsed using a dedicated tool.

e-Manual has the following features:

- Required information can be cross-searched in multiple manuals.
- Other manuals can be accessed from the links in the manual.
- The hardware specifications of each part can be found from the product figures.
- Pages that users often browse can be bookmarked.
- Sample programs can be copied to an engineering tool.

TERMS

Unless otherwise specified, this manual uses the following terms.

Term	Description
Baton pass	A data transmission method by which transmission right (token) is passed around the network.
Buffer memory	Memory in an intelligent function module to store data such as setting values and monitor values. For CPU modules, it refers to memory to store data such as setting values and monitor values of the Ethernet function, or data used for data communication of the multiple CPU system function.
Coaxial bus system	A network system used for the RJ71BR11
Control system	A system that controls a redundant system and performs network communications in a redundant system
Dedicated instruction	An instruction that simplifies programming for using functions of intelligent function modules
Device	A memory of a CPU module to store data. Devices such as X, Y, M, D, and others are provided depending on the intended use.
Engineering tool	A tool used for setting up programmable controllers, programming, debugging, and maintenance
Global label	A label that is valid for all the program data when multiple program data are created in the project. There are two types of global label: a module specific label (module label), which is generated automatically by GX Works3, and an optional label, which can be created for any specified device.
Intelligent function module	A module that has functions other than an input or output, such as an A/D converter module and D/A converter module
Link device	A device (LB, LW, LX, LY, SB, or SW) in a MELSECNET/H network module
Link refresh	Processing of data transfer between link devices of the network module and CPU module devices. Link refresh is performed in "END processing" of the sequence scan of the CPU module.
Link scan (link scan time)	Time required for all the stations on the network to transmit data. The link scan time depends on data volume and the number of transient transmission requests.
Logical channel	Eight input channels that can be changed by using a program. The channel number can be specified from 1 to 64 by changing the values in the link special register. This channel number is used to receive only the messages selected on the receiving station when they have a lot of information types. The sending station is equivalent to a broadcasting station, which sends messages to logical channels. The receiving station is equivalent to a TV receiver in household, which receives the messages in the required logical channels by switching channels.
MELSECNET/10 mode	Mode that the MELSECNET/H network module operates on the MELSECNET/10 network
MELSECNET/H extended mode	A mode in which the maximum number of link points per station in MELSECNET/H mode is extended. Values exceeding 2000 bytes to maximum 35840 bytes can be set. Set this mode for a system that uses a large number of link points per station.
MELSECNET/H mode	Mode that the MELSECNET/H network module operates on the MELSECNET/H network
Module label	A label that represents one of memory areas (I/O signals and buffer memory areas) specific to each module in a given character string. For the module used, GX Works3 automatically generates this label, which can be used as a global label.
Normal station	A station that performs cyclic transmission and transient transmission with the control station and other normal stations
Optical loop system	A network system used for the RJ71LP21-25
Process CPU (redundant mode)	A Process CPU operating in redundant mode. A redundant system is configured with this CPU module. Process control function blocks and the online module change function can be used even in this mode.
Redundant system	A system consisting of two systems that have same configuration (CPU module, power supply module, network module, and other modules). Even after an error occurs in one of the two system, the other system takes over the control of the entire system.
Relay station	A station in which multiple network modules are mounted on one programmable controller to relay data link to other stations
Standby system	A backup system in a redundant system
System switching	A function which switches the systems between the control system and the standby system to continue operation of the redundant system when a failure or an error occurs in the control system

GENERIC TERMS AND ABBREVIATIONS

Unless otherwise specified, this manual uses the following generic terms and abbreviations.

Generic term/abbreviation	Description
MELSECNET/H network module	A generic term for the following modules: <ul style="list-style-type: none">• RJ71LP21-25• RJ71BR11
Network module	A generic term for the following modules: <ul style="list-style-type: none">• Ethernet interface module• A module on CC-Link IE TSN (the RJ71GN11-T2 and a module on a remote station)• CC-Link IE Controller Network module• A module on CC-Link IE Field Network (a master/local module, and a module on a remote I/O station, a remote device station, and an intelligent device station)• MELSECNET/H network module• MELSECNET/10 network module• RnENCPU (network part)

1 PART NAMES

1.1 RJ71LP21-25

This chapter describes the names of each part of the RJ71LP21-25.

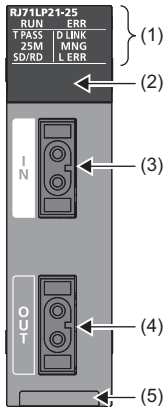

No.	Name	Description
(1)	RUN LED	On: Normal operation Off: Error (Refer to MELSEC iQ-R MELSECNET/H Network Module User's Manual (Application))
	ERR LED*1	On or flashing: Error (Refer to MELSEC iQ-R MELSECNET/H Network Module User's Manual (Application)) Off: Normal operation
	T PASS LED*1	On: Baton pass (state of connecting to the network) Flashing: Testing Off: Baton pass not executed (disconnection of the own station from the network)
	D LINK LED*1	On: Data link (state of performing cyclic transmission) Off: Data link not performed (disconnected)
	25M LED	On: Communicating at 25Mbps Off: Communicating at 10Mbps
	MNG LED*1	On: Operating as a control station or sub-control station Off: Operating as a normal station
	SD/RD LED	On: Data being sent or received Off: Data not sent nor received
	L ERR LED	On: Communication error Any of the following has occurred. <ul style="list-style-type: none"> Cable failure or noise Before receiving data, the RJ71LP21-25 has received the next data and deleted the previous one. Or, hardware failure has occurred in the RJ71LP21-25 receiving part. The number of bits whose value is one in the receive data in the frame is more than specified, or the receive data is shorter than specified. Baton pass does not return to own station within the monitoring time. Data with an abnormal code has been received. Internal processing of send data is not performed at regular intervals. Failure has occurred in the forward loop line or reverse loop line; the power supply of the adjacent station to be sent to the own station is turned off. Or, hardware failure has occurred in the sending station part of the loop. Off: No communication error
(2)	Dot matrix LED	Indicates the station number set to the RJ71LP21-25 and the status of each test. (Refer to Page 17 Dot matrix LED indication)
(3)	Optical connector (IN connector)	A connector to connect the optical fiber cable. Connect to OUT connector of another station.
(4)	Optical connector (OUT connector)	A connector to connect the optical fiber cable. Connect to IN connector of another station.
(5)	Production information marking	Indicates the production information (16 digits) of the module.

*1 The LED is always off in offline mode.

Dot matrix LED indication

Displays the station number set to the RJ71LP21-25 and the status of each test.

Module operation mode	Display	
Online mode Debug mode	Displays the station number currently set to the RJ71LP21-25. <ul style="list-style-type: none"> Control station, normal station: 1 to 64 No parameter set: "——" 	
Offline mode	"... " is displayed.	
Forward loop test	"MD3" is displayed.	The operation mode is displayed during the execution of each test. For the displayed content of each test result, refer to the following.  MELSEC iQ-R MELSECNET/H Network Module User's Manual (Application)
Reverse loop test	"MD4" is displayed.	
Station-to-station test (executing station)	"MD5" is displayed.	
Station-to-station test (non-executing station)	"MD6" is displayed.	
Self-loopback test	"MD7" is displayed.	
Internal selfloopback test	"MD8" is displayed.	
Hardware test	"MD9" is displayed.	

1.2 RJ71BR11

This section describes the names of each part of the RJ71BR11.

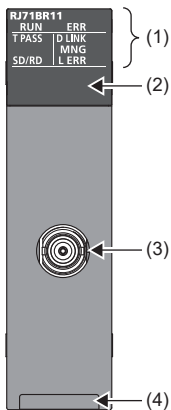

No.	Name	Description
(1)	RUN LED	On: Normal operation Off: Error (☐ MELSEC iQ-R MELSECNET/H Network Module User's Manual (Application))
	ERR LED*1	On or flashing: Error (☐ MELSEC iQ-R MELSECNET/H Network Module User's Manual (Application)) Off: Normal operation
	T PASS LED*1	On: Baton pass (state of connecting to the network) Flashing: Testing Off: Baton pass not executed (disconnection of the own station from the network)
	D LINK LED*1	On: Data link (state of performing cyclic transmission) Off: Data link not performed (disconnected)
	MNG LED*1	On: Operating as a control station or sub-control station Off: Operating as a normal station
	SD/RD LED	On: Data being sent or received Off: Data not sent nor received
	L ERR LED	On: Communication error Any of the following has occurred. <ul style="list-style-type: none"> • Cable failure or noise • Before receiving data, the RJ71BR11 has received the next data and deleted the previous one. Or, hardware failure has occurred in the RJ71BR11 receiving part. • The number of bits whose value is one in the receive data in the frame is more than specified, or the receive data is shorter than specified. • Baton pass does not return to own station within the monitoring time. • Data with an abnormal code has been received. • Internal processing of send data is not performed at regular intervals. Off: No communication error
(2)	Dot matrix LED	Indicates the station number set to the RJ71BR11 and the status of each test. (☞ Page 19 Dot matrix LED indication)
(3)	Coaxial connector	A connector to connect the coaxial cable
(4)	Production information marking	Indicates the production information (16 digits) of the module.

*1 The LED is always off in offline mode.

Dot matrix LED indication

Indicates the station number set to the RJ71BR11 and the status of each test.



Module operation mode	Display	
Online mode Debug mode	Displays the station number currently set to the RJ71BR11. <ul style="list-style-type: none"> Control station, normal station: 1 to 32 No parameter set: "———" 	
Offline mode	"... " is displayed.	
Station-to-station test (executing station)	"MD5" is displayed.	The operation mode is displayed during the execution of each test. For the displayed content of each test result, refer to the following.  MELSEC iQ-R MELSECNET/H Network Module User's Manual (Application)
Station-to-station test (non-executing station)	"MD6" is displayed.	
Self-loopback test	"MD7" is displayed.	
Internal selfloopback test	"MD8" is displayed.	
Hardware test	"MD9" is displayed.	

2 SPECIFICATIONS

2.1 Performance Specifications

RJ71LP21-25

The following table lists the performance specifications of the RJ71LP21-25.

Item		Description
Maximum number of link points per network	LB	16384 points (MELSECNET/10 mode: 8192 points)
	LW	16384 points (MELSECNET/10 mode: 8192 points)
	LX	8192 points
	LY	8192 points
Maximum number of link points per station*1	LB	<ul style="list-style-type: none"> MELSECNET/H mode, MELSECNET/10 mode $((LY + LB) \div 8 + (2 \times LW)) \leq 2000$ bytes
	LW	
	LX	<ul style="list-style-type: none"> MELSECNET/H extended mode $((LY + LB) \div 8 + (2 \times LW)) \leq 35840$ bytes
	LY	
Communication speed		25Mbps/10Mbps (MELSECNET/10 mode: 10Mbps)
Number of connected stations per network		64 stations (control station: 1, normal station: 63)
Connection cable		Optical fiber cable (obtained by user) For details, refer to the following.  Page 22 Cable Specifications
Applicable connector		2-core optical connector plug F06/F08 equivalent (JIS C5975/5977 compliant)
Overall cable distance		30km
Maximum station-to-station distance		The maximum station-to-station distance varies depending on the optical fiber cable used. For details, refer to the following.  Page 22 Optical fiber cable specifications
Maximum number of networks		239
Maximum number of groups		32 (MELSECNET/10 mode: 9)
Network topology		Duplex loop
Communication method		Token ring
Transient transmission capacity		1920 bytes maximum (MELSECNET/10 mode: 960 bytes maximum)
Number of occupied I/O points		32 points
Internal current consumption (5VDC)		0.48A
External dimensions	Height	106mm (Base unit mounting side: 98mm)
	Width	27.8mm
	Depth	110mm
Weight		0.15kg

*1 The number of points for LY for a station set as the I/O master station is the sum of LY output to all the stations in the block.

RJ71BR11

The following table lists the performance specifications of the RJ71BR11.

Item		Description
Maximum number of link points per network	LB	16384 points (MELSECNET/10 mode: 8192 points)
	LW	16384 points (MELSECNET/10 mode: 8192 points)
	LX	8192 points
	LY	8192 points
Maximum number of link points per station*1	LB	• MELSECNET/H mode, MELSECNET/10 mode
	LW	$((LY + LB) \div 8 + (2 \times LW)) \leq 2000$ bytes
	LX	• MELSECNET/H extended mode
	LY	$((LY + LB) \div 8 + (2 \times LW)) \leq 35840$ bytes
Communication speed		10Mbps
Number of connected stations per network		32 stations (control station: 1, normal station: 31)
Connection cable		Coaxial cable (obtained by user) For details, refer to the following.  Page 22 Coaxial cable specifications
Applicable connector		Connector plug for 3C-2V (obtained by user) Connector plug for 5C-2V (obtained by user) Connector plug for 5C-FB (obtained by user), connector plug for S-5C-FB (obtained by user)
Overall cable distance		3C-2V: 300m*2 5C-2V: 500m*2 5C-FB, S-5C-FB: 500m*2 Can be extended up to 2.5km with the use of a repeater unit (A6BR10, A6BR10-DC.)
Maximum station-to-station distance		3C-2V: 300m*2 5C-2V: 500m*2 5C-FB, S-5C-FB: 500m*2
Maximum number of networks		239
Maximum number of groups		32 (MELSECNET/10 mode: 9)
Network topology		Single bus
Communication method		Token bus
Transient transmission capacity		1920 bytes maximum (MELSECNET/10 mode: 960 bytes maximum)
Number of occupied I/O points		32 points
Internal current consumption (5VDC)		0.62A
External dimensions	Height	106mm (Base unit mounting side: 98mm)
	Width	27.8mm
	Depth	110mm
Weight		0.14kg

*1 The number of points for LY for a station set as the I/O master station is the sum of LY output to all the stations in the block.

*2 Some restrictions are applied to the cable length between stations depending on the number of stations connected. For details, refer to the following.

 Page 22 Cable Specifications

2.2 Cable Specifications

Optical fiber cable specifications

The following table lists the specifications of optical fiber cables.

The types of optical fiber cables that can be used vary depending on the station-to-station distance.

Type		Station-to-station distance		Applicable connector
		25Mbps	10Mbps	
SI optical fiber cable (Old type: A-2P-□)	Type L	200m	500m	F06/F08 equivalent (JIS C5975/5977 compliant)
	Type H	100m	300m	
SI optical fiber cable		200m	500m	
H-PCF optical fiber cable		400m	1000m	
Broadband H-PCF optical fiber cable		1000m	1000m	
QSI optical fiber cable/Broadband silica glass optical fiber cable		1000m	1000m	

Coaxial cable specifications

The following table lists the specifications of coaxial cables.

Use the following high frequency coaxial cables:

- 3C-2V (JIS C 3501 compliant)
- 5C-2V (JIS C 3501 compliant)
- 5C-FB (JIS C 3502 compliant)
- S-5C-FB (JIS C 3502 compliant)

The cable lengths indicated in the table below must be used according to the number of stations connected.

Number of stations connected	Coaxial cable type	Station-to-station distance	Overall cable distance
2 to 9 stations	3C-2V	1 to 300m	300m (3C-2V)
	5C-2V	1 to 500m	500m (5C-2V, 5C-FB, S-5C-FB)
	5C-FB, S-5C-FB	1 to 500m	
10 to 32 stations	3C-2V, 5C-2V, 5C-FB, S-5C-FB	1 to 5m	
	3C-2V, 5C-2V, 5C-FB, S-5C-FB	13 to 17m	
	3C-2V, 5C-2V, 5C-FB, S-5C-FB	25 to 300m	
	5C-2V, 5C-FB, S-5C-FB	300 to 500m	

Select coaxial cables that meet the operating ambient temperature (0 to 55 °C) shown in the general specifications of the programmable controller.

Item	3C-2V	5C-2V	5C-FB	S-5C-FB
Structure				
Cable diameter	5.4mm	7.4mm	7.7mm	
Allowable bend radius	23mm or more	30mm or more	30mm or more	
Internal conductor diameter	0.5mm (annealed copper wire)	0.8mm (annealed copper wire)	1.05mm (annealed copper wire)	
Insulating material diameter	3.1mm (polyethylene)	4.9mm (polyethylene)	5.0mm (polyethylene)	
External conductor diameter	3.8mm (single annealed copper wire mesh)	5.6mm (single annealed copper wire mesh)	5.7mm (aluminum foil tape and annealed copper wire mesh)	
Applicable connector	3C-2V connector plug The following connector plugs are recommended: • BNC-SP-3D2V-DA1*1 (Manufactured by DDK Ltd.) • BCP-A3*2 (Manufactured by Canare Electric Co., Ltd.)	5C-2V connector plug The following connector plugs are recommended: • BNC-P-5-NiCAu-CF*1 (Manufactured by DDK Ltd.) • BCP-A5*2 (Manufactured by Canare Electric Co., Ltd.)	5C-FB and S-5C-FB connector plug The following connector plugs are recommended: • BCP-A5F*2 (Manufactured by Canare Electric Co., Ltd.)	

*1 This connector plug is a soldering-type connector plug.

*2 This connector plug is a crimping-type connector plug.

Connecting the coaxial cable connectors

The following section explains how to connect the BNC connector (the connector plug for the coaxial cable) to the cable.

■Using a BNC connector manufactured by DDK Ltd.

The following explains how to connect the BNC-SP-3D2V-DA1 or BNC-P-5-NiCAu-CF to the cable.

- Structure of the BNC connector and coaxial cable

Components of the BNC connector

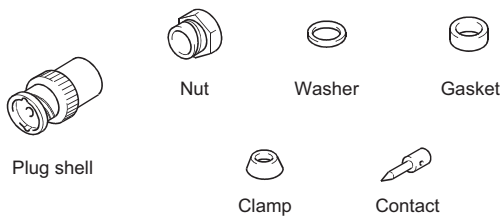

Structure of the coaxial cable

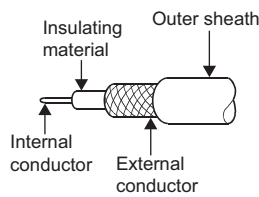

- How to connect the BNC connector and the coaxial cable

1. Cut the part of the outer sheath of the coaxial cable as shown in the figure below.

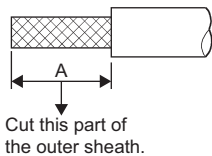

Cable	A
3C-2V	15mm
5C-2V	10mm

2. Fit the nut, washer, gasket, and clamp onto the coaxial cable, as shown below, and then loosen the external conductor.

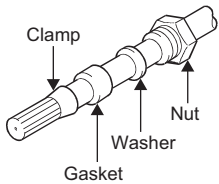

3. Cut the external conductor, insulating material, and internal conductor to the dimensions shown below. Note that the external conductor must be cut to the same dimension as the tapered section of the clamp and smoothed down to the clamp.

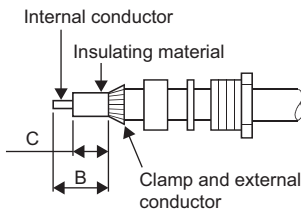

Cable	B	C
3C-2V	6mm	3mm
5C-2V	7mm	5mm

4. Solder the contact to the internal conductor.

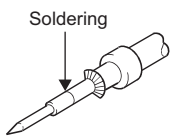

5. Insert the connector assembly shown in (4) into the plug shell and screw the nut into the plug shell.

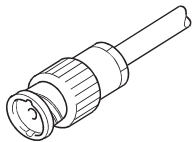

Point

- Note the following precautions when soldering the internal conductor and contact.
 - Make sure that the solder does not bead up at the soldered section.
 - Make sure there are no gaps between the connector and cable insulator or they do not cut into each other.
 - Perform soldering quickly so the insulation material does not become deformed.
- Before connecting or disconnecting the coaxial connector, touch a grounded metal object to discharge the static electricity from the human body. Failure to do so may result in a module malfunction.

■Using a BNC connector manufactured by Canare Electric Co., Ltd.

The following explains how to connect the BCP-A3, BCP-A5, or BCP-A5F to the cable.

• Structure of the BNC connector and coaxial cable

Components of the BNC connector



Structure of the coaxial cable

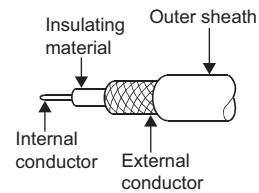

• How to connect the BNC connector and the coaxial cable

1. Thread a coaxial cable through a crimp sleeve as shown in the figure below.

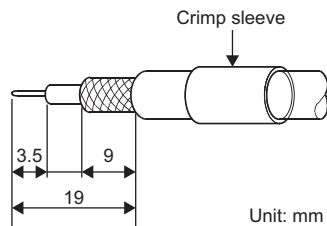

When using a cable with aluminum tape, cut the tape as shown in the figure below.

When cutting the tape, make a clean cut, without leaving any stray pieces or loose strands. Failure to do so may cause a short circuit or result in an improper crimp.

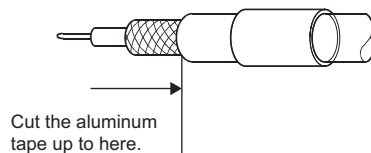

2. Insert a center contact pin into the internal conductor. Crimp the pin using a crimp tool to seal the gap between the center contact pin and the insulating material.

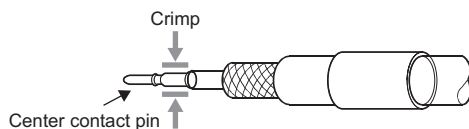

Point

- Use a crimp tool specified for a BNC connector.
- Do not crimp the junction of the insulating material and the center contact pin.
- Horizontally insert the center contact pin into the insulating material and crimp the pin. If the pin is on the tilt, straighten it.

3. After the crimp, check the crimp height of the crimp part. When the crimp height at the measurement position is between 1.4mm and 1.5mm, the pin is properly crimped.

If the crimp height is not between 1.4mm and 1.5mm, adjust the crimp tool and crimp the center contact pin again.

Measurement position of crimp height

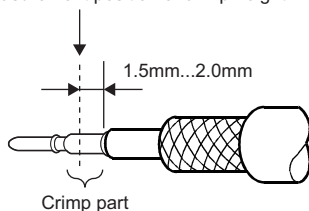

Cross section of the measurement position

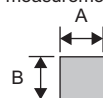

$$\text{Crimp height value} = \frac{A+B}{2} \text{ mm}$$

- 4.** Hold the root of the coaxial cable and fully insert the cable into a plug.
After inserting the cable, pull it lightly to check that the center contact pin is fixed.
Move the crimp sleeve until it contacts with the plug.

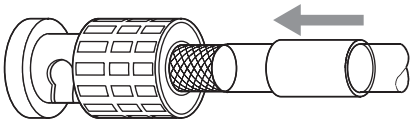

- 5.** Crimp the crimp sleeve using the crimp tool with attention paid to the orientations of the crimp tool and connector.
Do not pull the cable when crimping the sleeve.

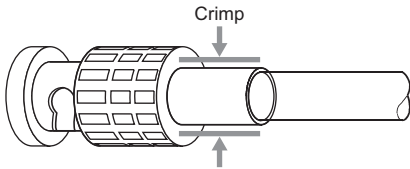

Point

Before connecting or disconnecting the coaxial connector, touch a grounded metal object to discharge the static electricity from the human body.
Failure to do so may result in a module malfunction.

3 FUNCTION LIST

This chapter describes the functions of the MELSECNET/H network module. For details on the functions, refer to the following.

📖 MELSEC iQ-R MELSECNET/H Network Module User's Manual (Application)

Cyclic transmission function

○: Available, —: Not available

Function name		Description	Availability	
			Control station	Normal station
Cyclic transmission	Communications using LB and LW	This function writes data on the link device (LB, LW) of the MELSECNET/H network module and sends the data to all stations connected in the same network.	○	○
	Communications using LX and LY	Exchanges data between the I/O master station that controls LX and LY and another station on a one-to-one (1:1) basis.	○	○
Low-speed cyclic transmission		Collectively sends data that do not require high speed transmission to another station by using link devices (LB/LW). It has the same performance as the transient transmission function.	○	○
Refresh	Link refresh	Automatically transfers data between a link device in a MELSECNET/H network module and a device in a CPU module. Refresh can be performed on labels as well.	○	○
	Direct access to link devices	Directly reads/writes link devices (LB/LW/LX/LY/SB/SW) of the MELSECNET/H network module using a program.	○	○
	Constant link scan	Keeps the link scan time at the level of the setting time.	○	—
Data assurance		Assures the cyclic data integrity in units of 32 bits or station-based units.	○	○
Interlink transmission		Transfers data in the link devices of the MELSECNET/H network module to another network module on a relay station. Between MELSEC iQ-R series modules, high-speed interlink transmission is performed without going through the CPU module.	○	○
Cyclic transmission stop and restart		Starts/Stops cyclic transmission in the specified station using MELSECNET diagnostics or a program. Transient transmission does not stop.	○	○

Transient transmission function

○: Available, —: Not available

Function name		Description	Availability	
			Control station	Normal station
Transient transmission	Communications within the same network	Performs the transient transmission to other stations using dedicated instructions and the engineering tool.	○	○
	Communications with different networks	Performs the transient transmission seamlessly to stations on different networks using dedicated instructions or the engineering tool.	○	○
	SLMP relay ^{*1*2}	In the SLMP access of another station, the MELSECNET/H network module operates as the relay station. The MELSECNET/H network module cannot be used as a starting point of the SLMP send/receive. (📖 SLMP Reference Manual)	○	○
Group transient transmission		Sends data to all stations of the same transient transmission group number with a single instruction by dividing the transient transmission target stations into groups.	○	○
Sending messages by using logical channel numbers		Sends messages by using logical channel numbers. This function is used to receive only the messages selected on the receiving station when they have a lot of information types.	○	○

*1 For the RJ71LP21-25, this function is available for the firmware version "03" or later.

*2 When the QnACPU is the target station, SLMP requests can be relayed if the Q71E71-100 is used as the connected station. However, SLMP requests cannot be relayed if the RJ71EN71 is used as the connected station.

RAS function

○: Available, —: Not available

Function name	Description	Availability	
		Control station	Normal station
Automatic return	Automatically returns the station disconnected from the network due to a data link error to the network when it recovers and restarts data link.	○	○
Control station switching	Continues data link with another normal station that serve as a sub-control station even if the control station goes down.	—	○
Control station recovery control	Shortens network downtime by resolving the cause of an error in the control station and making that station join the network as a normal station.	○	—
Loopback function* ¹	Isolates a faulty area such as a cable disconnection and faulty station to continue data link connection between normal stations.	○	○
Station detach function* ²	Even if some of the connected stations are down due to power-off, normal communication continues among other operational stations.	○	○

*1 This function is available only for the RJ71LP21-25.

*2 This function is available only for the RJ71BR11.

Troubleshooting

○: Available, —: Not available

Function name	Description	Availability	
		Control station	Normal station
Network diagnostics* ¹	Checks the line status of the network and the module setting status.	○	○

*1 The loop test and station order check test are not available for the RJ71BR11.

Applied function

○: Available, —: Not available

Function name	Description	Availability	
		Control station	Normal station
Interrupt program start	Checks interrupt conditions at every link scan, and sends an interrupt request to the CPU module to start the interrupt program if the interrupt conditions are met.	○	○
Multiplex transmission function* ¹	Performs high speed communication using duplex transmission path (forward loop and reverse loop). In the environment where the QJ71LP21-25 with multiplex transmission operates as a control station, the RJ71LP21-25 is allowed to participate in the network as a sub-control station or normal station.	—	○
Send points increase	Increases the number of send points (a maximum of 2000 bytes per station) to a maximum of 8000 bytes (when four modules are mounted) by mounting multiple MELSECNET/H network modules with the same network number to one CPU module.	○	○

*1 This function is available only for the RJ71LP21-25.

Redundant system function

○: Available, —: Not available

Function name	Description	Availability	
		Control station	Normal station
Redundant system function* ¹	Consists of a control system and standby system. When an error occurs in the control system, the standby system is switched to the new control system and cyclic transmission continues.	○	○

*1 This function is available only for the RJ71LP21-25.

Firmware update function

○: Available, —: Not available

Function name	Description	Availability	
		Control station	Normal station
Firmware update	Enables users to update the firmware versions of modules by obtaining firmware update files from the users' local Mitsubishi representatives. ( MELSEC iQ-R Module Configuration Manual)	○	○

4 PROCEDURES BEFORE OPERATION

This chapter describes the procedures before operation.

1. Network construction

Configure the system and set the parameters which are required for start-up.

- Wiring (👉 Page 34 WIRING)
- Parameter setting (📖 MELSEC iQ-R MELSECNET/H Network Module User's Manual (Application))

2. Network diagnostics

Using MELSECNET diagnostics, check if the cables are connected properly and communication is performed normally with the configured parameters.

For details, refer to the following.

📖 MELSEC iQ-R MELSECNET/H Network Module User's Manual (Application)

3. Programming

Create a program. For details, refer to the following.

👉 Page 42 COMMUNICATION EXAMPLES

5 SYSTEM CONFIGURATION

This chapter describes the system configuration of MELSECNET/H network.

5.1 MELSECNET/H Network Configuration

Single-network system

■Optical loop system (RJ71LP21-25)

A system in which the control station and normal stations are connected with optical fiber cables.

A total of 64 stations can be connected: one control station and 63 normal stations. A station with any station number can be set as the control station. Note that one system has only one control station.

In the following system configuration example, a station with station No.1 is set as the control station.

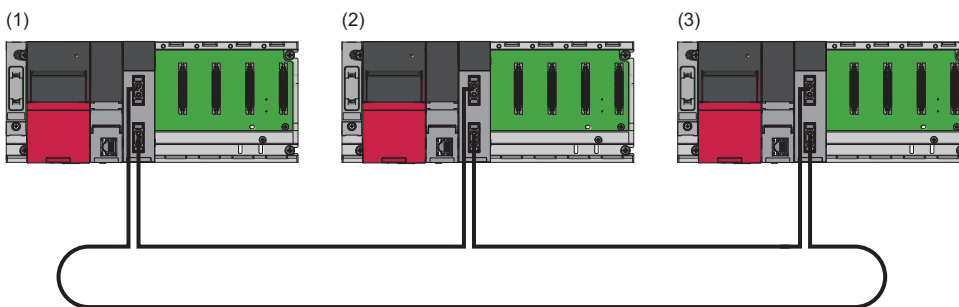

- (1) Control station (station No.1)
- (2) Normal station (station No.2)
- (3) Normal station (station No.3)

■Coaxial bus system (RJ71BR11)

A system in which the control station and normal stations are connected with coaxial cables.

In the coaxial bus system, 1 control station and 31 normal stations (a total of 32 stations) can be connected. A station with any station number can be set as the control station. Note that one system has only one control station.

In the coaxial bus system, install a terminating resistor (sold separately: A6RCON-R75) to the stations connected at both ends of the network.

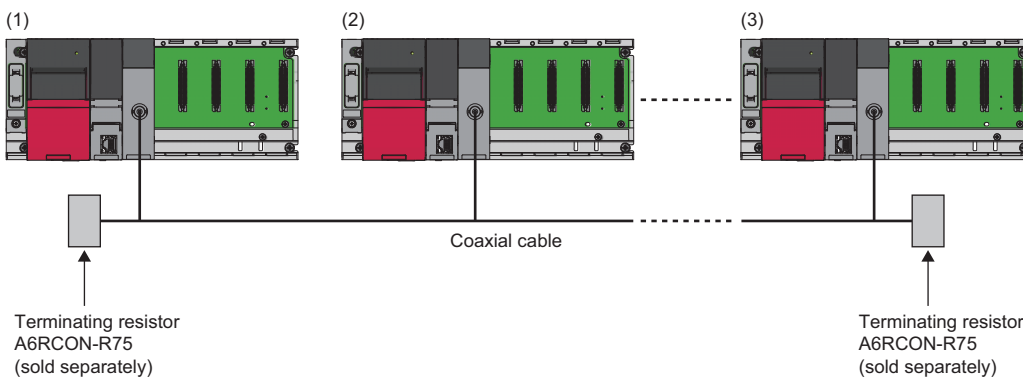

- (1) Control station (station No.1)
- (2) Normal station (station No.2)
- (3) Normal station (station No.3)

Multi-network system

A system in which multiple networks are connected at a relay station. A maximum of 239 networks can be connected regardless of the network type, such as Ethernet, CC-Link IE TSN, CC-Link IE Controller Network, and CC-Link IE Field Network.

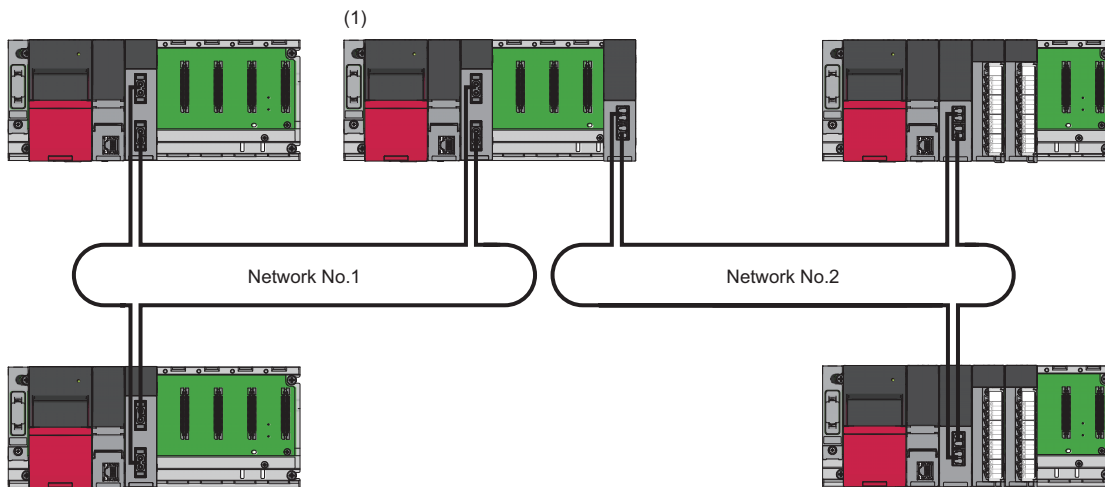

(1) Relay station

Redundant system

The RJ71LP21-25 can be used in a redundant system.

If an error occurs in the control system, the redundant system function executes system switching and continues data communications.

For details on the redundant system function, refer to the following.

📖 MELSEC iQ-R MELSECNET/H Network Module User's Manual (Application)

6 WIRING

This chapter describes the wiring when MELSECNET/H network is used.

6.1 Wiring Methods

The wiring method for MELSECNET/H network modules differs between the RJ71LP21-25 and RJ71BR11.

For the RJ71LP21-25, do the wiring based on duplex loop connection by using optical fiber cables.

For the RJ71BR11, do the wiring based on single bus connection by using coaxial cables.

RJ71LP21-25

This section describes connection and disconnection of the optical fiber cable.

The RJ71LP21-25 has IN connector and OUT connector.

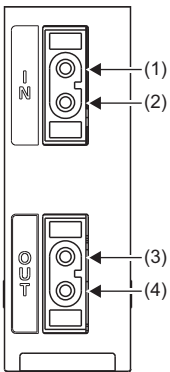

- (1) For sending reverse loop data (IN)
- (2) For receiving forward loop data (IN)
- (3) For sending forward loop data (OUT)
- (4) For receiving reverse loop data (OUT)

Connect the IN connector of own station to OUT connector of another station and OUT connector of own station to IN connector of another station.

The following shows a wiring example.

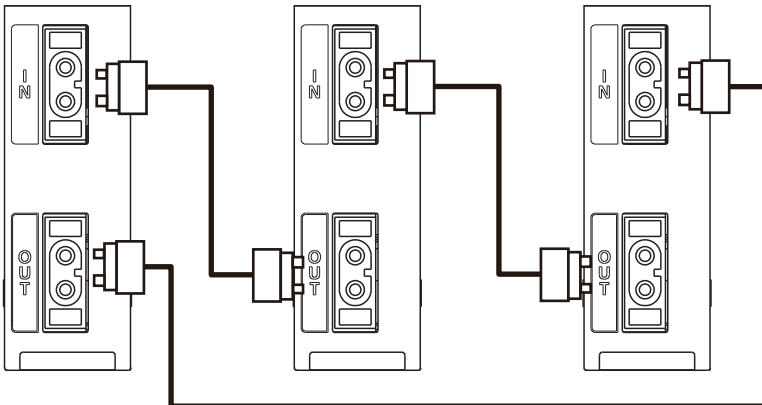

■Connecting the cable

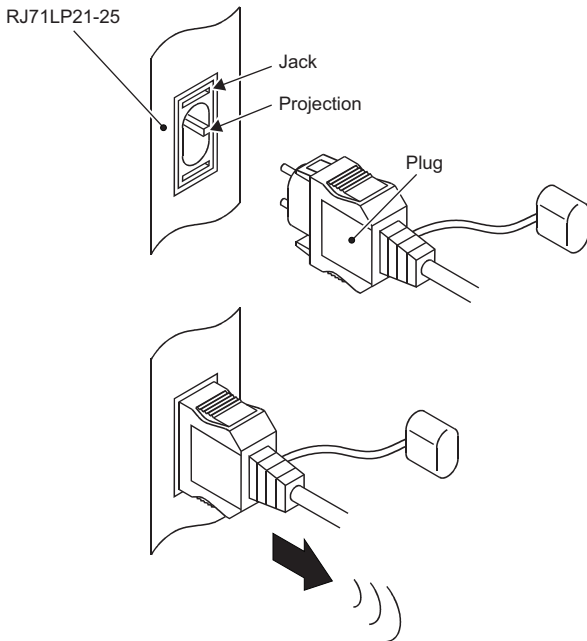

1. Turn the power off.
2. Insert the plug by aligning its groove with the projection of the jack.
3. Push the plug in until the hole for securing the plug is caught by the hook of the jack.
4. Lightly pull the plug in the direction of the arrow to check that it is securely connected.

■Disconnecting the cable

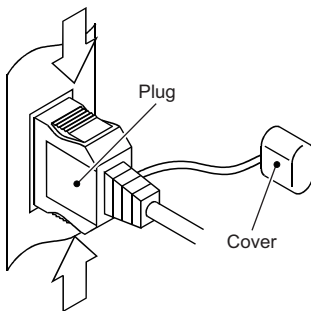

1. Turn the power off.
2. Press the side buttons that engage the locking mechanism in the direction of the arrows to pull the plug out.
3. For storage, attach the covers that were attached to both the plug and the jack before connecting them.

■Precautions

- Cables do not need to be connected in the order of station numbers.
- For the RJ71LP21-25, there is a distinction between IN connector and OUT connector. Connect the IN connector of own station to OUT connector of another station and OUT connector of own station to IN connector of another station.
- Do the wiring in a loop by using optical fiber cables.
- Use the types of optical fiber cables shown in the cable specifications. (☞ Page 22 Cable Specifications)
- The bending radius of the optical fiber cable is limited. For details, check the specifications of the cable to be used.
- Place the optical fiber cable in a duct or fix it. Otherwise, a dangling cable may swing or inadvertently be pulled, resulting in damage to the module or cables or malfunction due to poor contact.
- When handling an optical fiber cable, do not touch the optical fiber core of the cable-side or module-side connector, and protect it from dirt or dust. If oil from your hand, dirt or dust is attached to the core, it can increase transmission loss, giving rise to a problem in data link.
- When connecting/disconnecting an optical fiber cable, hold its connector part.
- Securely connect the cable-side connector and module-side connector of an optical fiber cable securely until it clicks.
- When connecting/disconnecting an optical fiber cable, shut off the external power supply (all phases) used in the system.

RJ71BR11

This section describes connection and disconnection of the coaxial cable.

An F-type connector for a coaxial cable is connected to the RJ71BR11. The two connectors of the F-type connector are not dedicated to IN and OUT. A coaxial cable can be connected to either of them.

Install a terminating resistor (sold separately: A6RCON-R75) to the stations connected at both ends.

The F-type connector (A6RCON-F) comes with the module.

The following shows a wiring example.

- Without a repeater module

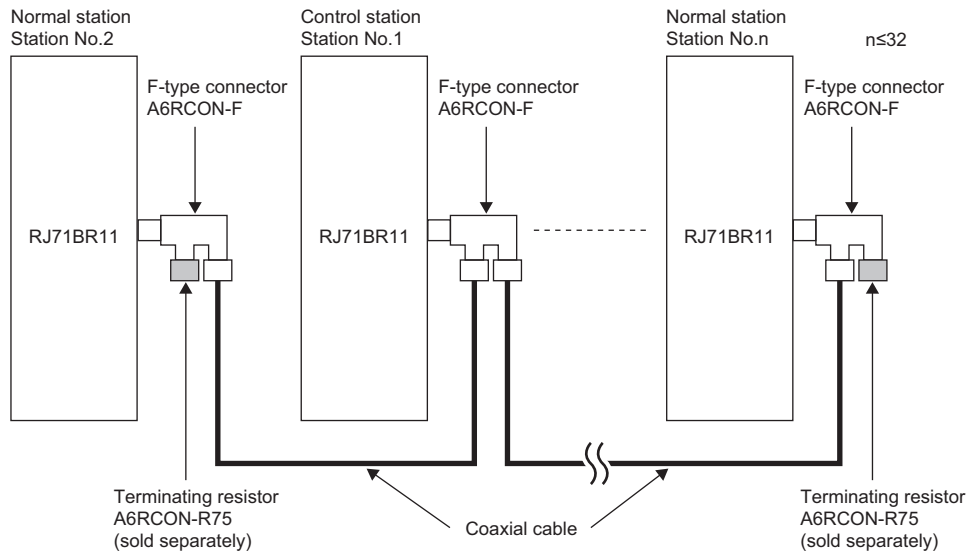

- With a repeater module (series connection)

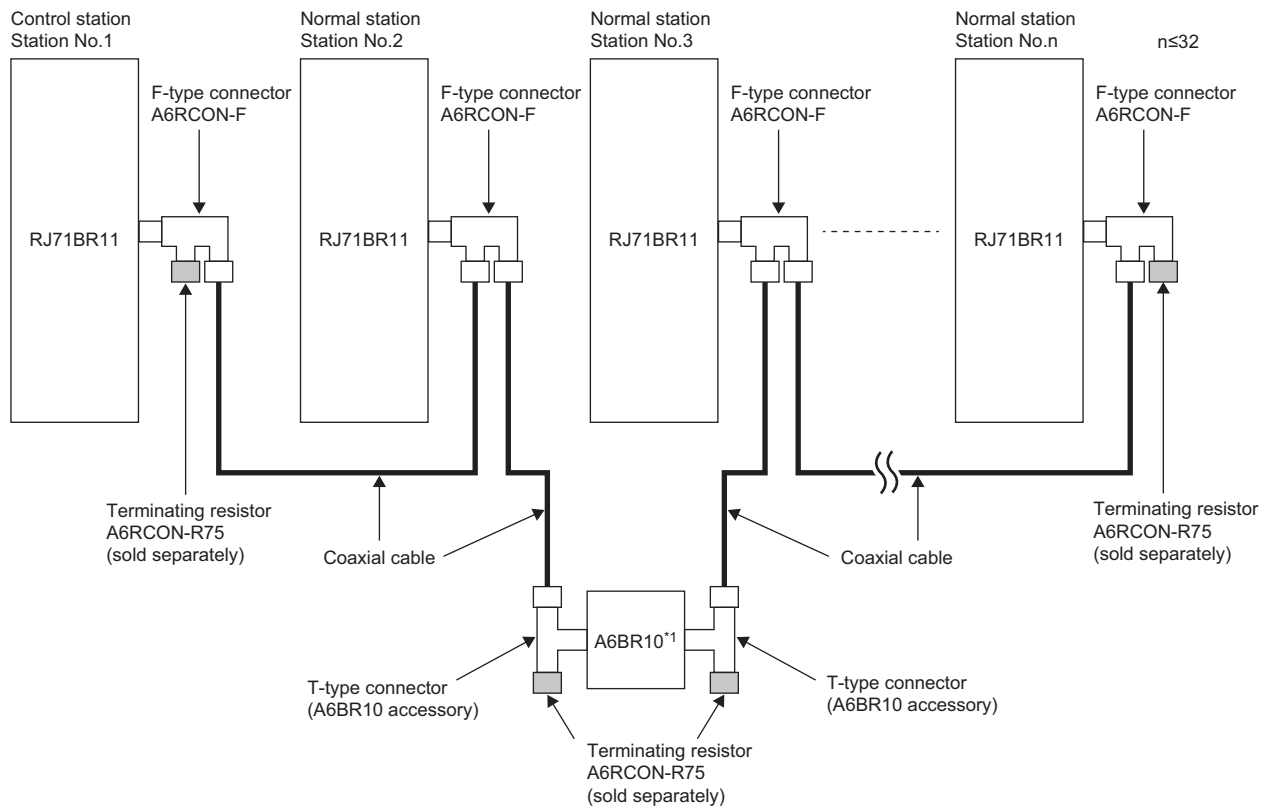

*1 For details on the repeater module (A6BR10), refer to the following.

📖 Repeater Unit for the MELSECNET/10 Coaxial Bus System type A6BR10/A6BR10-DC User's Manual

• With a repeater module (branch connection)

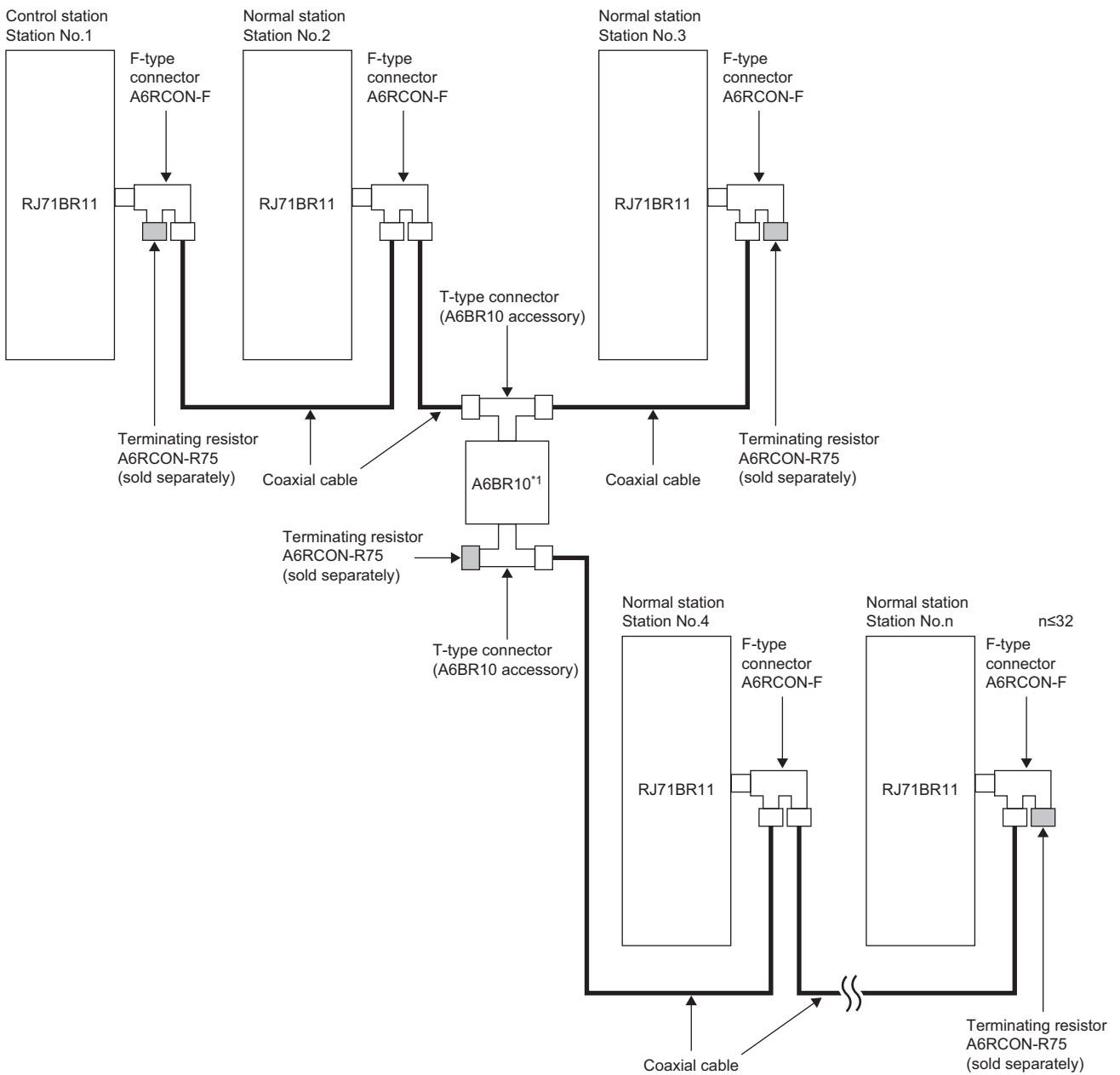

*1 For details on the repeater module (A6BR10), refer to the following.

📖 Repeater Unit for the MELSECNET/10 Coaxial Bus System type A6BR10/A6BR10-DC User's Manual

- By setting stations that will be connected in future (stations that are included in the number of stations but not actually connected) as reserved stations, a communication error can be prevented and the link scan time will not be affected.
- A terminating resistor can be placed on either side of the F-type connector.

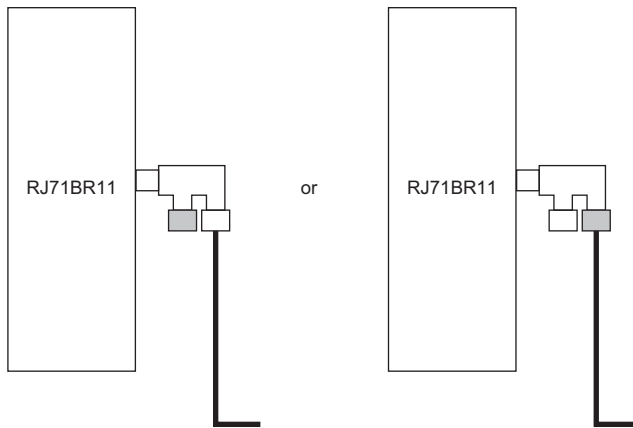

■Connecting the cable

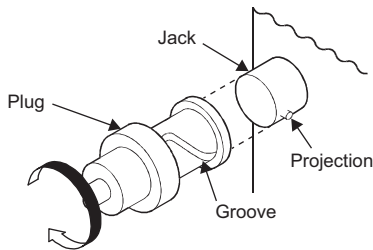

1. Turn the power off.
2. Insert the plug by aligning its groove with the projection of the jack.
3. Rotate the plug in the direction of the arrow (clockwise) securely to the position shown in the second figure from above (deepest position of the groove).

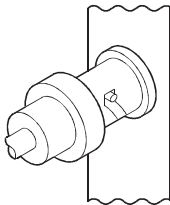

■Disconnecting the cable

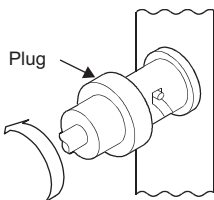

1. Turn the power off.
2. Rotate the plug in the direction of the arrow (counterclockwise) and unhook it.
3. Hold the plug by hand and pull it out in the direction of the arrow.

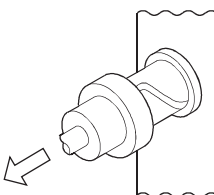

■Precautions

- Cables do not need to be connected in the order of station numbers.
- The two connectors of the F-type connector (A6RCON-F) are not dedicated to IN and OUT.
- Connect modules to form a line by using coaxial cables.
- Use the types of coaxial cables shown in the cable specifications. (☞ Page 22 Cable Specifications)
- When connecting a coaxial cable, the following restrictions on the bending radius must be observed.

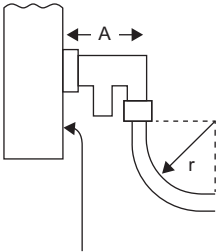

Front of the module

Cable type	Allowable bending radius r	Connector A
3C-2V	23mm	55mm
5C-2V	30mm	
5C-FB S-5C-FB	30mm	

- Place the coaxial cables in a duct or fix them. Otherwise, a dangling cable may swing or inadvertently be pulled, resulting in damage to the module or cables or malfunction due to poor contact.
- When handling a coaxial cable, do not touch the core of the cable-side or module-side connector, and protect it from dirt or dust. If oil from your hand, dirt or dust is attached to the core, it can increase transmission loss, giving rise to a problem in data link.
- When connecting/disconnecting a coaxial cable, hold its connector part.
- When connecting/disconnecting a coaxial cable, shut off the external power supply (all phases) used in the system.
- Install the coaxial cables at least 100mm away from other power cables and control cables.
- Consider to use double-shielded coaxial cables in locations where there is excessive noise.

Double shield coaxial cable	Cable close-up
<p>5C-2V-CCY (manufactured by Fujikura Dia Cable Ltd.)</p>	

5C-2V connector plug can be applied to double-shielded coaxial cable. Connect the plug to the coaxial cable inside the double-shielded coaxial cable.

Locate external conductor (ground) of the double-shielded cable approximately 10mm away from the 5C-2V connector plug so that they do not touch each other.

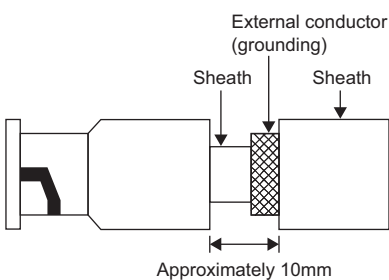

- When connecting between the MELSECNET/H network modules, the cable lengths indicated in the cable specifications must be used according to the number of stations connected. A communication error may occur if a cable length is out of the coaxial cable specifications. If there is a possibility of adding stations to extend the system, lay the cables considering the station-to-station cable length in advance. (☞ Page 22 Coaxial cable specifications)
- When using a repeater module (models A6BR10 or A6BR10-DC), only the length indicated in "10 to 32 stations" can be applied regardless of the number of stations connected or the number of repeater modules. (☞ Page 22 Coaxial cable specifications)
- Do not pull connected coaxial cables.
- Depending on the operating environment, some white oxidation deposits may be seen on the F type connector (A6RCON-F). Note that oxidation will not occur on the connection area, so there will be no problems with the function of the unit.
- When the repeater module (A6BR10 or A6BR10-DC) is powered off and on, all the stations in the network may be disconnected.

6.2 Wiring Products

RJ71LP21-25

Optical fiber cables with connectors (optical fiber cables for MELSEC) are available from Mitsubishi Electric System & Service Co., Ltd. (Catalogs for the optical fiber cables are also available.) In addition, installation work is also available for your preference. Please consult your local Mitsubishi representative.

RJ71BR11

To order or for inquiries regarding connector plugs and coaxial cables, contact your local Mitsubishi representative.

7 COMMUNICATION EXAMPLES

7.1 Cyclic Transmission Program

This section describes the procedure for creating a program using cyclic transmission.

System configuration example

The following system configuration is used to explain communication between the control station and normal station.

System configuration

- Optical loop system

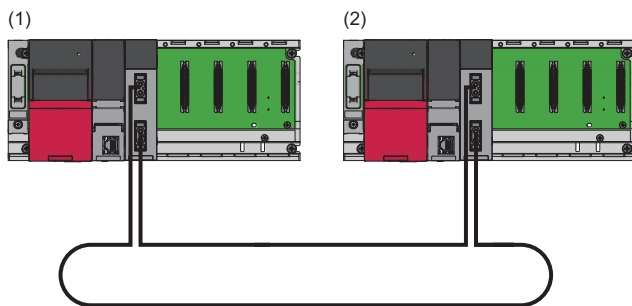

- Coaxial bus system

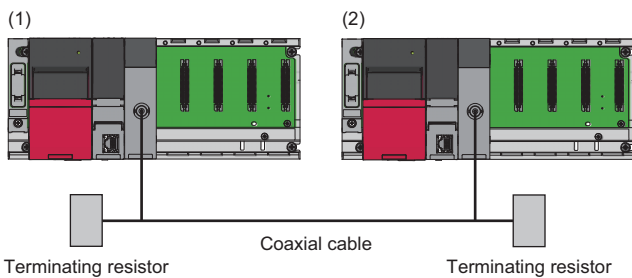

No.	Item	Model	
(1)	Control station (station No.1)	Power supply module	R61P
		CPU module	R04CPU
		MELSECNET/H network module	RJ71LP21-25 or RJ71BR11
(2)	Normal station (station No.2)	Power supply module	R61P
		CPU module	R04CPU
		MELSECNET/H network module	RJ71LP21-25 or RJ71BR11

Link device assignment

■LB and LW assignment

No.1: control station, No.2: normal station.

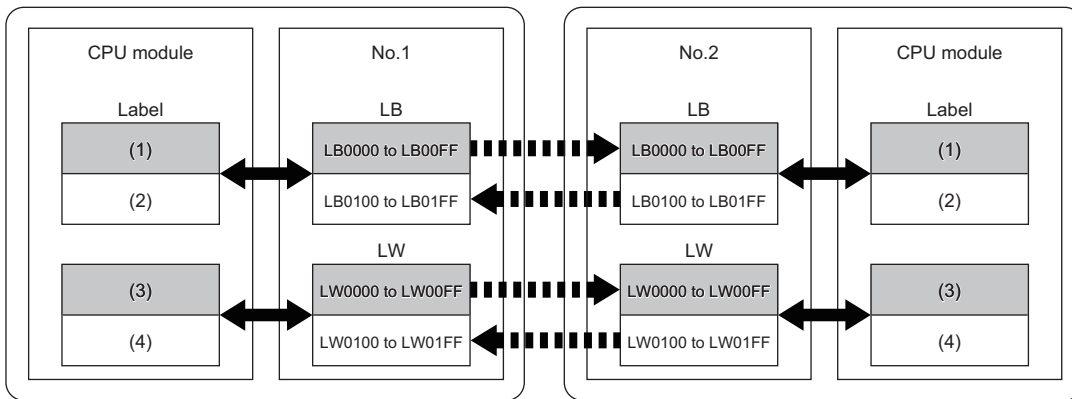

⇄ Cyclic transmission

→ Link refresh

- (1) Control station (station No.1) bit: 256 points
- (2) Normal station (station No.2) bit: 256 points
- (3) Control station (station No.1) word: 256 points
- (4) Normal station (station No.2) word: 256 points

Setting in the control station

Connect the engineering tool to the CPU module on the control station and set the parameters.

Point

For the display of the setting window, the RJ71LP21-25 is used as an example.
When using the RJ71BR11, replace RJ71LP21-25 with RJ71BR11.

1. Set the CPU module as follows.

[Project] ⇒ [New]

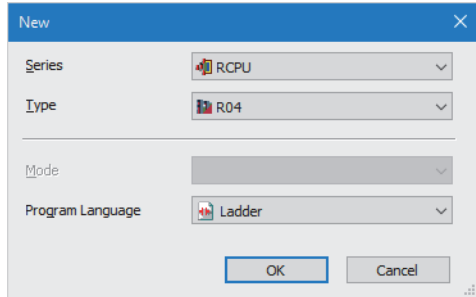

2. Click the [Setting Change] button and set "Use" for "Module Label".

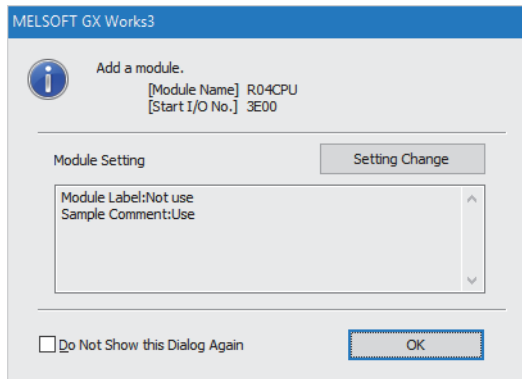

3. Set the MELSECNET/H network module as follows.

[Navigation window] ⇒ [Parameter] ⇒ [Module Information] ⇒ Right click ⇒ [Add New Module]

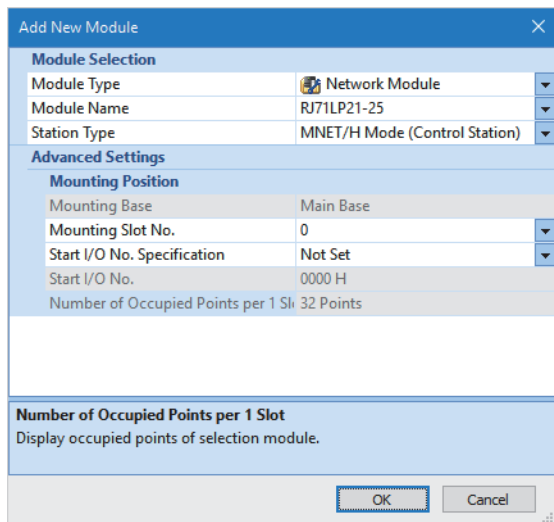

4. Click the [OK] button to add the module labels of the MELSECNET/H network module to be used.

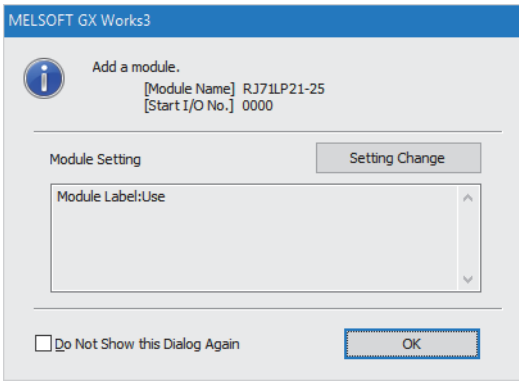

5. Set the items in "Required Settings" as follows.

[Navigation window] ⇒ [Parameter] ⇒ [Module Information] ⇒ [RJ71LP21-25] or [RJ71BR11] ⇒ [Required Settings]

Setting Item	Item	Setting
Station Type	Station Type	MNET/H Mode (Control Station)
Network No.	Network No.	1
Station No.	Station No.	1
Network Range Assignment	Network Range Assignment Setting	<Detailed Setting>
Operation after Reconnection	Operation after Reconnection	Return as Control Station
Transmission Speed	Transmission Speed	10Mbps

6. Set the network range assignment as follows and click the [Apply] button.

[Required Settings] ⇒ [Network Range Assignment] ⇒ [Detailed Setting]





Total No. of Stations		LB/LW Setting												Reserved Station		Pairing
Station No.	Station Type	LB			LW			Low Speed LB			Low Speed LW			Reserved Station	Pairing	
		Points	Start	End	Points	Start	End	Points	Start	End	Points	Start	End			
1	Control Station	256	0000	00FF	256	00000	000FF							No Setting	Disable	
2	Normal Station	256	0100	01FF	256	00100	001FF							No Setting	Disable	

7. Set the items in "Basic Settings" as follows.

 [Navigation window] ⇒ [Parameter] ⇒ [Module Information] ⇒ [RJ71LP21-25] or [RJ71BR11] ⇒ [Basic Settings]

8. Set the link refresh settings as follows and click the [Apply] button.

 [Basic Settings] ⇒ [Link Refresh Settings] ⇒ [Detailed Setting]

Setting Item											
No.	Link Side						CPU Side				
	Device Name	Points	Start	End	Target		Device Name	Points	Start	End	
-	SB	512	00000	001FF		Module Label					
-	SW	512	00000	001FF		Module Label					
1	LB	1024	00000	003FF		Specify Device	B	1024	00000	003FF	
2	LW	1024	00000	003FF		Specify Device	W	1024	00000	003FF	

9. Write the set parameters to the CPU module of the control station. Then reset the CPU module or power off and on the system.

 [Online] ⇒ [Write to PLC]

Point 

In this example, default values are used for parameters that are not shown above. For the parameters, refer to the following.

 MELSEC iQ-R MELSECNET/H Network Module User's Manual (Application)

Setting in the normal stations

Connect the engineering tool to the CPU module on the normal station and set the parameters.

Point

For the display of the setting window, the RJ71LP21-25 is used as an example.
When using the RJ71BR11, replace RJ71LP21-25 with RJ71BR11.

1. Set the CPU module and add a module label of the CPU module. The setting method of the CPU module and addition method of the module label are the same as those of the control station. (Page 44 Setting in the control station)
2. Set the MELSECNET/H network module as follows.

[Navigation window] ⇒ [Parameter] ⇒ [Module Information] ⇒ Right click ⇒ [Add New Module]

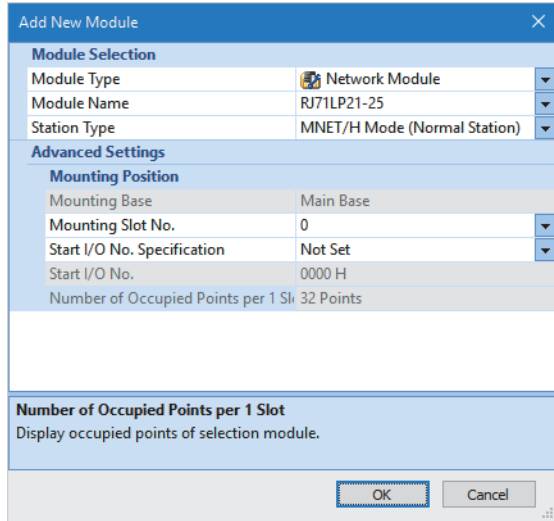

3. Add the module labels of the MELSECNET/H network module to be used. The addition method of the module label is the same as that of the control station. (Page 44 Setting in the control station)
4. Set the items in "Required Settings" as follows and click the [Apply] button.

[Navigation window] ⇒ [Parameter] ⇒ [Module Information] ⇒ [RJ71LP21-25] or [RJ71BR11] ⇒ [Required Settings]

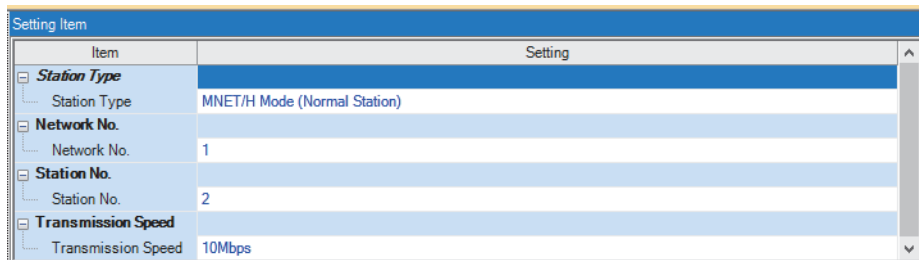





5. Set the items in "Basic Settings" as follows.

 [Navigation window] ⇒ [Parameter] ⇒ [Module Information] ⇒ [RJ71LP21-25] or [RJ71BR11] ⇒ [Basic Settings]

6. Set the link refresh settings as follows and click the [Apply] button.

 [Basic Settings] ⇒ [Link Refresh Settings] ⇒ [Detailed Setting]

Setting Item										
No.	Link Side					CPU Side				
	Device Name	Points	Start	End		Target	Device Name	Points	Start	End
-	SB	512	00000	001FF		Module Label				
-	SW	512	00000	001FF		Module Label				
1	LB	1024	00000	003FF		Specify Device	B	1024	00000	003FF
2	LW	1024	00000	003FF		Specify Device	W	1024	00000	003FF

7. Write the set parameters to the CPU module of the control station. Then reset the CPU module or power off and on the system.

 [Online] ⇒ [Write to PLC]

Point 

In this example, default values are used for parameters that are not shown above. For the parameters, refer to the following.

 MELSEC iQ-R MELSECNET/H Network Module User's Manual (Application)

Checking the network status

Once parameters are set for the control station and normal station, the MELSECNET diagnostics of the engineering tool can be used to check whether data link is normally operating.

1. Connect the engineering tool to the CPU module on the control station.
2. Start MELSECNET diagnostics.

[Diagnostics] ⇒ [MELSECNET Diagnostics]

If the following display appears, data link is normal.*1

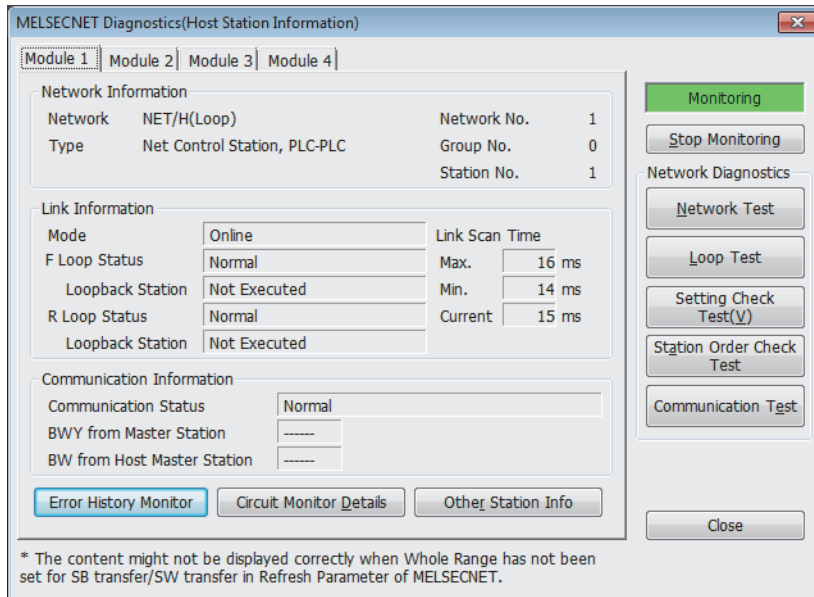

*1 The window displayed here is for the RJ71LP21-25. For the RJ71BR11, "---" is displayed in "F Loop Status", "Loopback Station" and "R Loop Status", "Loopback Station".

For details on the "MELSECNET Diagnostics(Host Station Information)" window, refer to the following.

📖 MELSEC iQ-R MELSECNET/H Network Module User's Manual (Application)

Program example

This section describes program examples.

Program example of cyclic transmission

The values in D0 to D3 of the control station (station No.1) are sent to D100 to D103 of the normal station (station No.2) through cyclic transmission.

When creating a program, configure an interlock using 'Data link error status of own station' (SB0049) and 'Data link status of each station' (SW0074 to SW0077).

■ Overview of the sending station (control station (station No.1)) program example

- When bHandShake1 and bHandShake2 are turned off, send the values in D0 to D3 (uOutputData[0] to uOutputData[3]) to W0 to W3 (uData[0] to uData[3]). To notify the receiving station that the data was sent, turn bHandShake1 on.
- Check that the receiving station received the data by checking that bHandShake2 is on, and turn bHandShake1 off to complete the send processing.

■ Overview of the receiving station (normal station (station No.2)) program example

- Check with bHandShake1 that the data was sent, and transfer (receive) the values in W0 to W3 (uData[0] to uData[3]) to D100 to D103 (uInputData[0] to uInputData[3]). To notify the sending station that the data was received, turn bHandShake2 on.
- Check that the send processing is complete by checking that bHandShake1 is off, and turn bHandShake2 off to complete the receive processing.

■ Program example (RJ71LP21-25)

- Control station (station No.1)

Classification	Label name	Description	Device																												
Module label	LP21_1.bDetect_DataLinkError	Data link error status of own station	SB0049																												
	LP21_1.bnSts_CyclicTransmissionError_Station[2]	Data link status of each station (station No.2)	SW0074.1																												
Label to be defined	Define global labels as shown below:																														
	<table border="1"> <thead> <tr> <th>Label Name</th> <th>Data Type</th> <th>Class</th> <th>Assign (Device/Label)</th> </tr> </thead> <tbody> <tr> <td>bDataLinNormal</td> <td>Bit</td> <td>VAR_GLOBAL</td> <td>M0</td> </tr> <tr> <td>uData</td> <td>Word [Unsigned]/Bit String [16-bit](0..3)</td> <td>VAR_GLOBAL</td> <td>W0</td> </tr> <tr> <td>bHandShake1</td> <td>Bit</td> <td>VAR_GLOBAL</td> <td>B0</td> </tr> <tr> <td>bHandShake2</td> <td>Bit</td> <td>VAR_GLOBAL</td> <td>B100</td> </tr> <tr> <td>uOutputData</td> <td>Word [Unsigned]/Bit String [16-bit](0..3)</td> <td>VAR_GLOBAL</td> <td>D0</td> </tr> <tr> <td>bSendRequest</td> <td>Bit</td> <td>VAR_GLOBAL</td> <td>M100</td> </tr> </tbody> </table>	Label Name	Data Type	Class	Assign (Device/Label)	bDataLinNormal	Bit	VAR_GLOBAL	M0	uData	Word [Unsigned]/Bit String [16-bit](0..3)	VAR_GLOBAL	W0	bHandShake1	Bit	VAR_GLOBAL	B0	bHandShake2	Bit	VAR_GLOBAL	B100	uOutputData	Word [Unsigned]/Bit String [16-bit](0..3)	VAR_GLOBAL	D0	bSendRequest	Bit	VAR_GLOBAL	M100		
Label Name	Data Type	Class	Assign (Device/Label)																												
bDataLinNormal	Bit	VAR_GLOBAL	M0																												
uData	Word [Unsigned]/Bit String [16-bit](0..3)	VAR_GLOBAL	W0																												
bHandShake1	Bit	VAR_GLOBAL	B0																												
bHandShake2	Bit	VAR_GLOBAL	B100																												
uOutputData	Word [Unsigned]/Bit String [16-bit](0..3)	VAR_GLOBAL	D0																												
bSendRequest	Bit	VAR_GLOBAL	M100																												

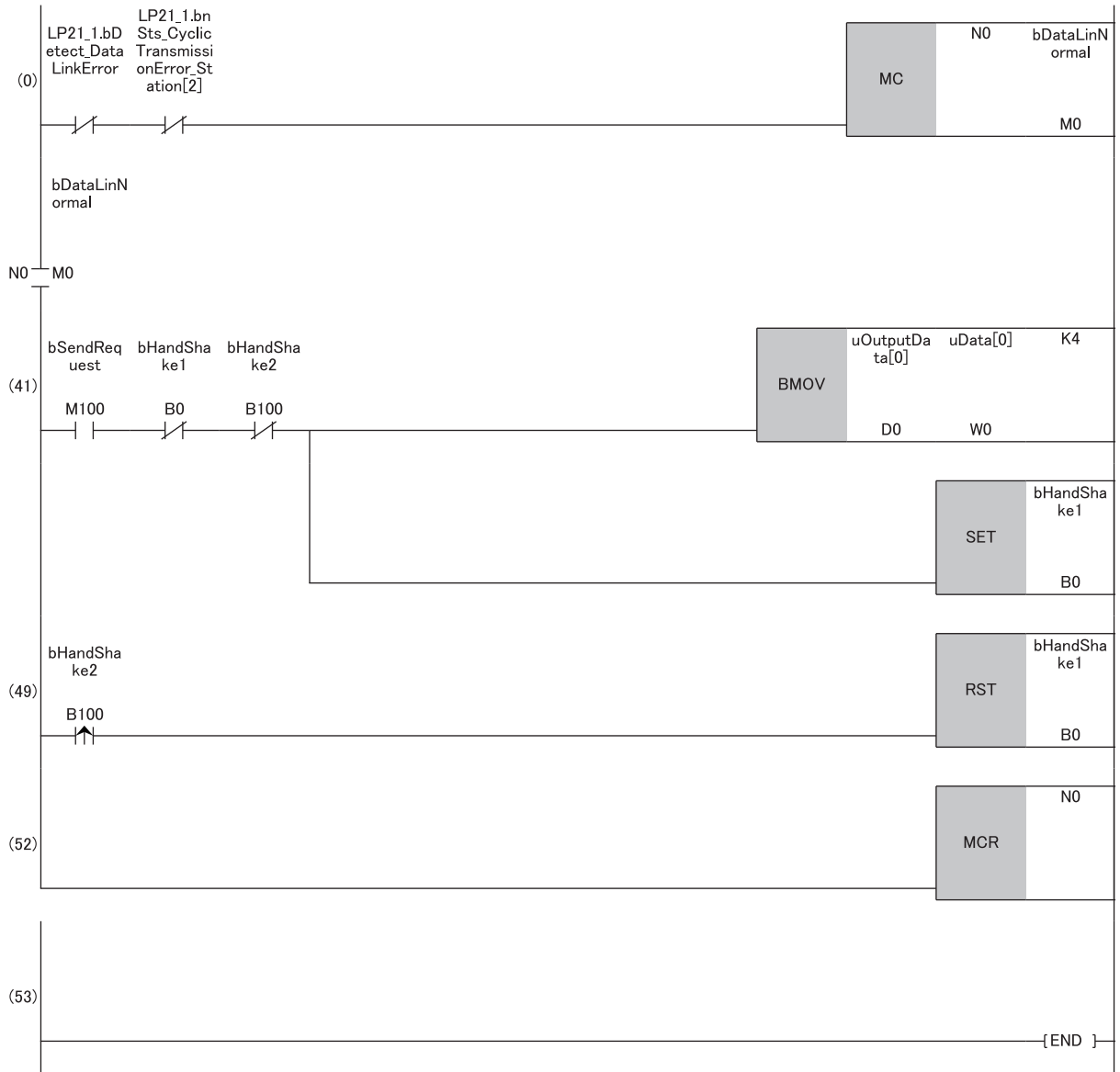

(41)When 'bSendRequest' (M100) is turned on, the contents of 'uOutputData' (D0 to D3) is stored in 'uData' (W0 to W3). When data storage is completed, 'bHandShake1' (B0) is turned on.

(49)When 'bHandShake2' (B100) in the normal station (station No.2) is turned on, 'bHandShake1' (B0) is turned off.

• Normal station (station No.2)

Classification	Label name	Description	Device																								
Module label	LP21_1.bDetect_DataLinkError	Data link error status of own station	SB0049																								
	LP21_1.bnSts_CyclicTransmissionError_Station[1]	Data link status of each station (station No.1)	SW0074.0																								
Label to be defined	Define global labels as shown below:																										
	<table border="1"> <thead> <tr> <th>Label Name</th> <th>Data Type</th> <th>Class</th> <th>Assign (Device/Label)</th> </tr> </thead> <tbody> <tr> <td>bDataLinNormal</td> <td>Bit</td> <td>VAR_GLOBAL</td> <td>M0</td> </tr> <tr> <td>uData</td> <td>Word [Unsigned]/Bit String [16-bit](0..3)</td> <td>VAR_GLOBAL</td> <td>W0</td> </tr> <tr> <td>bHandShake1</td> <td>Bit</td> <td>VAR_GLOBAL</td> <td>B0</td> </tr> <tr> <td>bHandShake2</td> <td>Bit</td> <td>VAR_GLOBAL</td> <td>B100</td> </tr> <tr> <td>uInputData</td> <td>Word [Unsigned]/Bit String [16-bit](0..3)</td> <td>VAR_GLOBAL</td> <td>D100</td> </tr> </tbody> </table>	Label Name	Data Type	Class	Assign (Device/Label)	bDataLinNormal	Bit	VAR_GLOBAL	M0	uData	Word [Unsigned]/Bit String [16-bit](0..3)	VAR_GLOBAL	W0	bHandShake1	Bit	VAR_GLOBAL	B0	bHandShake2	Bit	VAR_GLOBAL	B100	uInputData	Word [Unsigned]/Bit String [16-bit](0..3)	VAR_GLOBAL	D100		
Label Name	Data Type	Class	Assign (Device/Label)																								
bDataLinNormal	Bit	VAR_GLOBAL	M0																								
uData	Word [Unsigned]/Bit String [16-bit](0..3)	VAR_GLOBAL	W0																								
bHandShake1	Bit	VAR_GLOBAL	B0																								
bHandShake2	Bit	VAR_GLOBAL	B100																								
uInputData	Word [Unsigned]/Bit String [16-bit](0..3)	VAR_GLOBAL	D100																								

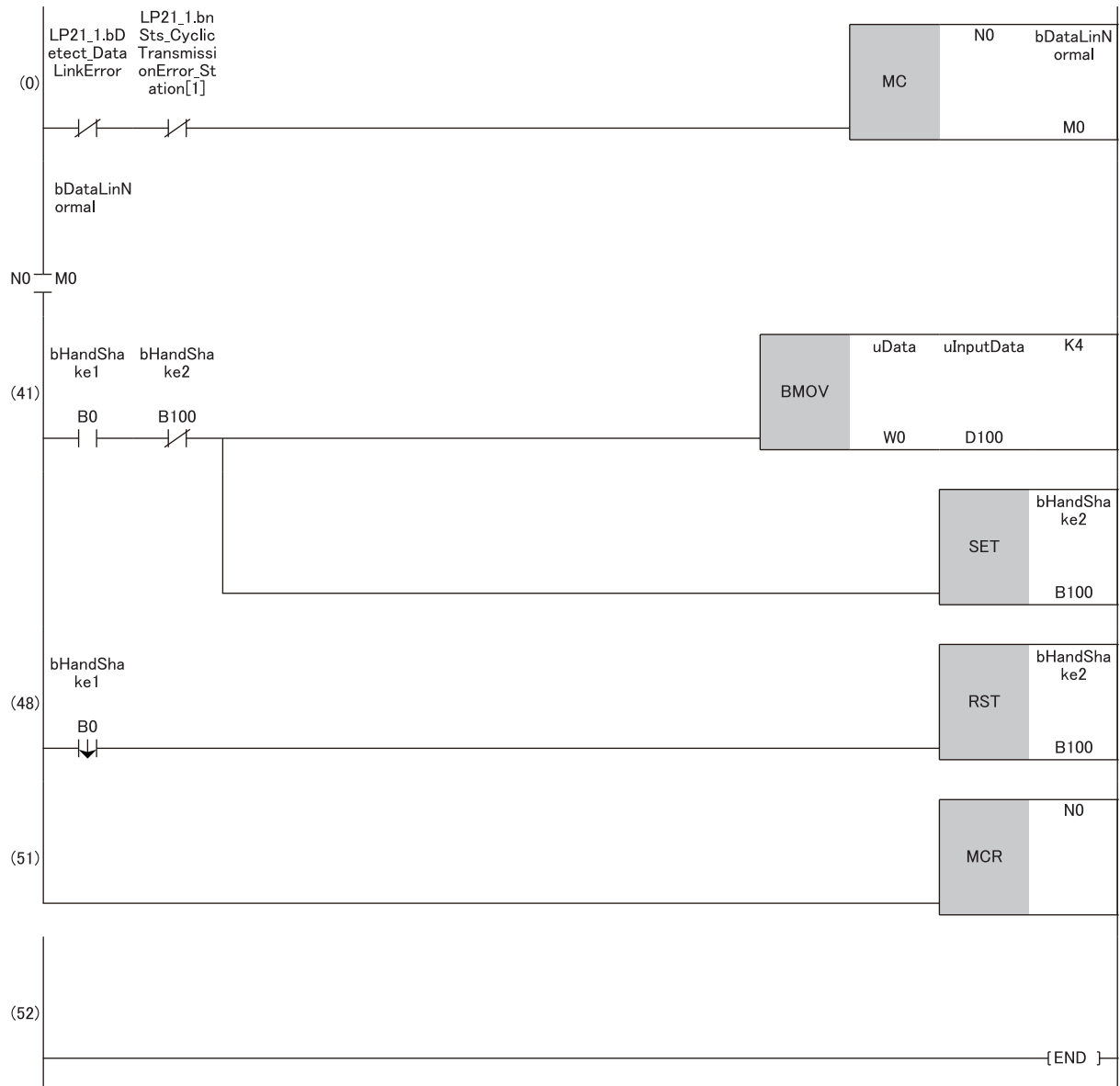

- (41)When 'bHandShake1' (B0) is turned on in the control station (station No.1), the contents of 'uData' (W0 to W3) is stored in 'uOutputData' (D100 to D103).
 When data storage is completed, 'bHandShake2' (B100) is turned on.
 (48)When 'bHandShake1' (B0) in the control station (station No.1) is turned off, 'bHandShake2' (B100) is turned off.

Program example (RJ71BR11)

- Control station (station No.1)

Classification	Label name	Description	Device																												
Module label	BR11_1.bDetect_DataLinkError	Data link error status of own station	SB0049																												
	BR11_1.bnSts_CyclicTransmissionError_Station[2]	Data link status of each station (station No.2)	SW0074.1																												
Label to be defined	Define global labels as shown below:																														
	<table border="1"> <thead> <tr> <th>Label Name</th> <th>Data Type</th> <th>Class</th> <th>Assign (Device/Label)</th> </tr> </thead> <tbody> <tr> <td>bDataLinNormal</td> <td>Bit</td> <td>VAR_GLOBAL</td> <td>M0</td> </tr> <tr> <td>uData</td> <td>Word [Unsigned]/Bit String [16-bit](0..3)</td> <td>VAR_GLOBAL</td> <td>W0</td> </tr> <tr> <td>bHandShake1</td> <td>Bit</td> <td>VAR_GLOBAL</td> <td>B0</td> </tr> <tr> <td>bHandShake2</td> <td>Bit</td> <td>VAR_GLOBAL</td> <td>B100</td> </tr> <tr> <td>uOutputData</td> <td>Word [Unsigned]/Bit String [16-bit](0..3)</td> <td>VAR_GLOBAL</td> <td>D0</td> </tr> <tr> <td>bSendRequest</td> <td>Bit</td> <td>VAR_GLOBAL</td> <td>M100</td> </tr> </tbody> </table>	Label Name	Data Type	Class	Assign (Device/Label)	bDataLinNormal	Bit	VAR_GLOBAL	M0	uData	Word [Unsigned]/Bit String [16-bit](0..3)	VAR_GLOBAL	W0	bHandShake1	Bit	VAR_GLOBAL	B0	bHandShake2	Bit	VAR_GLOBAL	B100	uOutputData	Word [Unsigned]/Bit String [16-bit](0..3)	VAR_GLOBAL	D0	bSendRequest	Bit	VAR_GLOBAL	M100		
Label Name	Data Type	Class	Assign (Device/Label)																												
bDataLinNormal	Bit	VAR_GLOBAL	M0																												
uData	Word [Unsigned]/Bit String [16-bit](0..3)	VAR_GLOBAL	W0																												
bHandShake1	Bit	VAR_GLOBAL	B0																												
bHandShake2	Bit	VAR_GLOBAL	B100																												
uOutputData	Word [Unsigned]/Bit String [16-bit](0..3)	VAR_GLOBAL	D0																												
bSendRequest	Bit	VAR_GLOBAL	M100																												

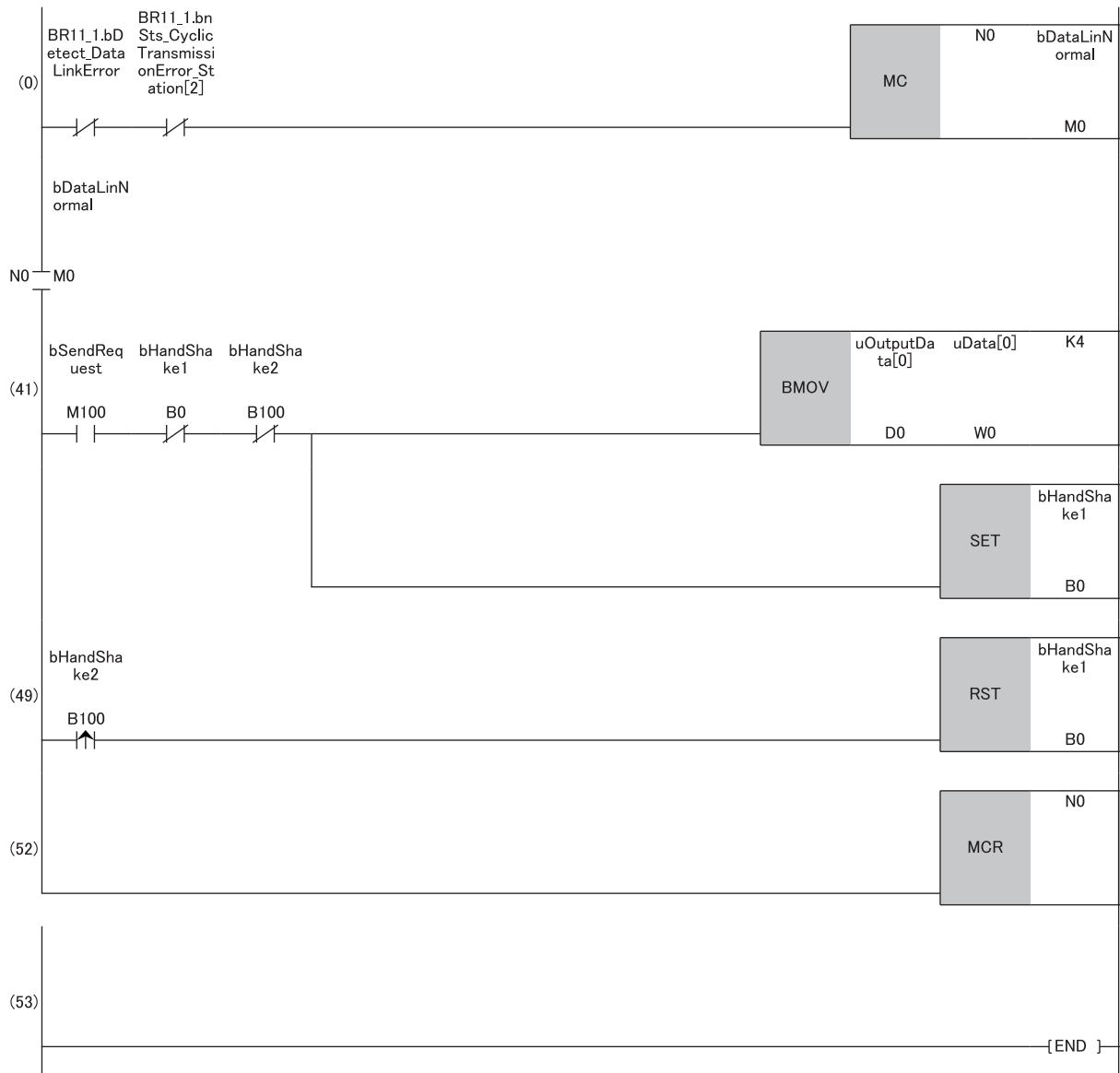

(41)When 'bSendRequest' (M100) is turned on, the contents of 'uOutputData' (D0 to D3) is stored in 'uData' (W0 to W3). When data storage is completed, 'bHandShake1' (B0) is turned on.

(49)When 'bHandShake2' (B100) in the normal station (station No.2) is turned on, 'bHandShake1' (B0) is turned off.

• Normal station (station No.2)

Classification	Label name	Description	Device																								
Module label	BR11_1.bDetect_DataLinkError	Data link error status of own station	SB0049																								
	BR11_1.bnSts_CyclicTransmissionError_Station[1]	Data link status of each station (station No.1)	SW0074.0																								
Label to be defined	Define global labels as shown below:																										
	<table border="1"> <thead> <tr> <th>Label Name</th> <th>Data Type</th> <th>Class</th> <th>Assign (Device/Label)</th> </tr> </thead> <tbody> <tr> <td>bDataLinNormal</td> <td>Bit</td> <td>VAR_GLOBAL</td> <td>M0</td> </tr> <tr> <td>uData</td> <td>Word [Unsigned]/Bit String [16-bit](0..3)</td> <td>VAR_GLOBAL</td> <td>W0</td> </tr> <tr> <td>bHandShake1</td> <td>Bit</td> <td>VAR_GLOBAL</td> <td>B0</td> </tr> <tr> <td>bHandShake2</td> <td>Bit</td> <td>VAR_GLOBAL</td> <td>B100</td> </tr> <tr> <td>uInputData</td> <td>Word [Unsigned]/Bit String [16-bit](0..3)</td> <td>VAR_GLOBAL</td> <td>D100</td> </tr> </tbody> </table>	Label Name	Data Type	Class	Assign (Device/Label)	bDataLinNormal	Bit	VAR_GLOBAL	M0	uData	Word [Unsigned]/Bit String [16-bit](0..3)	VAR_GLOBAL	W0	bHandShake1	Bit	VAR_GLOBAL	B0	bHandShake2	Bit	VAR_GLOBAL	B100	uInputData	Word [Unsigned]/Bit String [16-bit](0..3)	VAR_GLOBAL	D100		
Label Name	Data Type	Class	Assign (Device/Label)																								
bDataLinNormal	Bit	VAR_GLOBAL	M0																								
uData	Word [Unsigned]/Bit String [16-bit](0..3)	VAR_GLOBAL	W0																								
bHandShake1	Bit	VAR_GLOBAL	B0																								
bHandShake2	Bit	VAR_GLOBAL	B100																								
uInputData	Word [Unsigned]/Bit String [16-bit](0..3)	VAR_GLOBAL	D100																								

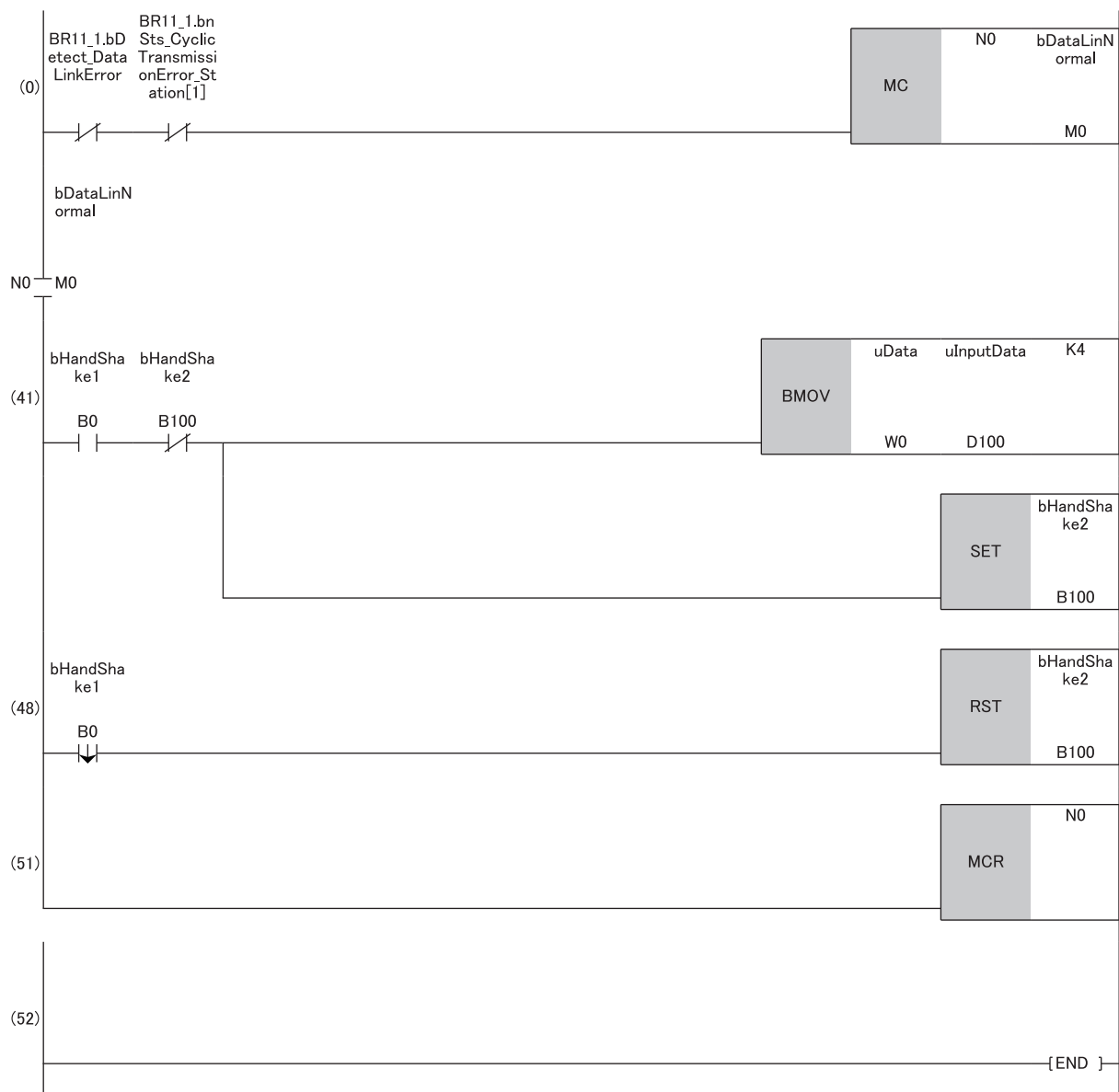

- (41)When 'bHandShake1' (B0) is turned on in the control station (station No.1), the contents of 'uData' (W0 to W3) is stored in 'uInputData' (D100 to D103). When data storage is completed, 'bHandShake2' (B100) is turned on.
- (48)When 'bHandShake1' (B0) in the control station (station No.1) is turned off, 'bHandShake2' (B100) is turned off.

7.2 Transient Transmission Program

This section describes the procedure for creating a program using transient transmission.

System configuration example

For details on the system configuration, refer to the following.

☞ Page 42 System configuration

Setting in the control station

For details on how to set parameters for the control station, refer to the following.

☞ Page 44 Setting in the control station

Setting in the normal stations

For details on how to set parameters for the normal stations, refer to the following.

☞ Page 47 Setting in the normal stations

Checking the network status

For details on how to check the network status, refer to the following.

☞ Page 49 Checking the network status

Program example

Program example of transient transmission

The following shows a program example of transient transmission.

■ Overview of the program example

Through transient transmission, by using the READ instruction, the values in D300 to D304 of the normal station (station No.2) are read to D800 to D804 of the control station (station No.1).

When creating a program, configure an interlock using 'Baton pass error status of own station' (SB0047) and 'Baton pass status of each station' (SW0070 to SW0073).

■ Program example (RJ71LP21-25)

Classification	Label name	Description	Device																																														
Module label	LP21_1.bDetect_BatonPassError	Baton pass error status of own station	SB0047																																														
	LP21_1.bnSts_BatonPassError_Station[1]	Baton pass status of each station	SW0070 to SW0073																																														
Label to be defined	Define global labels as shown below:																																																
	<table border="1"> <thead> <tr> <th>Label Name</th> <th>Data Type</th> <th>Class</th> <th>Assign (Device/Label)</th> <th>Initial Value</th> </tr> </thead> <tbody> <tr> <td>bControlDataSet</td> <td>Bit</td> <td>VAR_GLOBAL</td> <td>M1000</td> <td></td> </tr> <tr> <td>bTransientStart</td> <td>Bit</td> <td>VAR_GLOBAL</td> <td>M1001</td> <td></td> </tr> <tr> <td>uControlData</td> <td>Word (Unsigned)/Bit String [16-bit](0..17)</td> <td>VAR_GLOBAL</td> <td>D1000</td> <td></td> </tr> <tr> <td>uReadDevice</td> <td>String(32)</td> <td>VAR_GLOBAL</td> <td></td> <td>"D300"</td> </tr> <tr> <td>uOutPutData</td> <td>Word (Unsigned)/Bit String [16-bit](0..4)</td> <td>VAR_GLOBAL</td> <td>D800</td> <td></td> </tr> <tr> <td>bCompDevice</td> <td>Bit(0..1)</td> <td>VAR_GLOBAL</td> <td>M0</td> <td></td> </tr> <tr> <td>bSuccessFlg</td> <td>Bit</td> <td>VAR_GLOBAL</td> <td>M100</td> <td></td> </tr> <tr> <td>bErrFlg</td> <td>Bit</td> <td>VAR_GLOBAL</td> <td>M101</td> <td></td> </tr> </tbody> </table>				Label Name	Data Type	Class	Assign (Device/Label)	Initial Value	bControlDataSet	Bit	VAR_GLOBAL	M1000		bTransientStart	Bit	VAR_GLOBAL	M1001		uControlData	Word (Unsigned)/Bit String [16-bit](0..17)	VAR_GLOBAL	D1000		uReadDevice	String(32)	VAR_GLOBAL		"D300"	uOutPutData	Word (Unsigned)/Bit String [16-bit](0..4)	VAR_GLOBAL	D800		bCompDevice	Bit(0..1)	VAR_GLOBAL	M0		bSuccessFlg	Bit	VAR_GLOBAL	M100		bErrFlg	Bit	VAR_GLOBAL	M101	
Label Name	Data Type	Class	Assign (Device/Label)	Initial Value																																													
bControlDataSet	Bit	VAR_GLOBAL	M1000																																														
bTransientStart	Bit	VAR_GLOBAL	M1001																																														
uControlData	Word (Unsigned)/Bit String [16-bit](0..17)	VAR_GLOBAL	D1000																																														
uReadDevice	String(32)	VAR_GLOBAL		"D300"																																													
uOutPutData	Word (Unsigned)/Bit String [16-bit](0..4)	VAR_GLOBAL	D800																																														
bCompDevice	Bit(0..1)	VAR_GLOBAL	M0																																														
bSuccessFlg	Bit	VAR_GLOBAL	M100																																														
bErrFlg	Bit	VAR_GLOBAL	M101																																														

- Control station (station No.1)

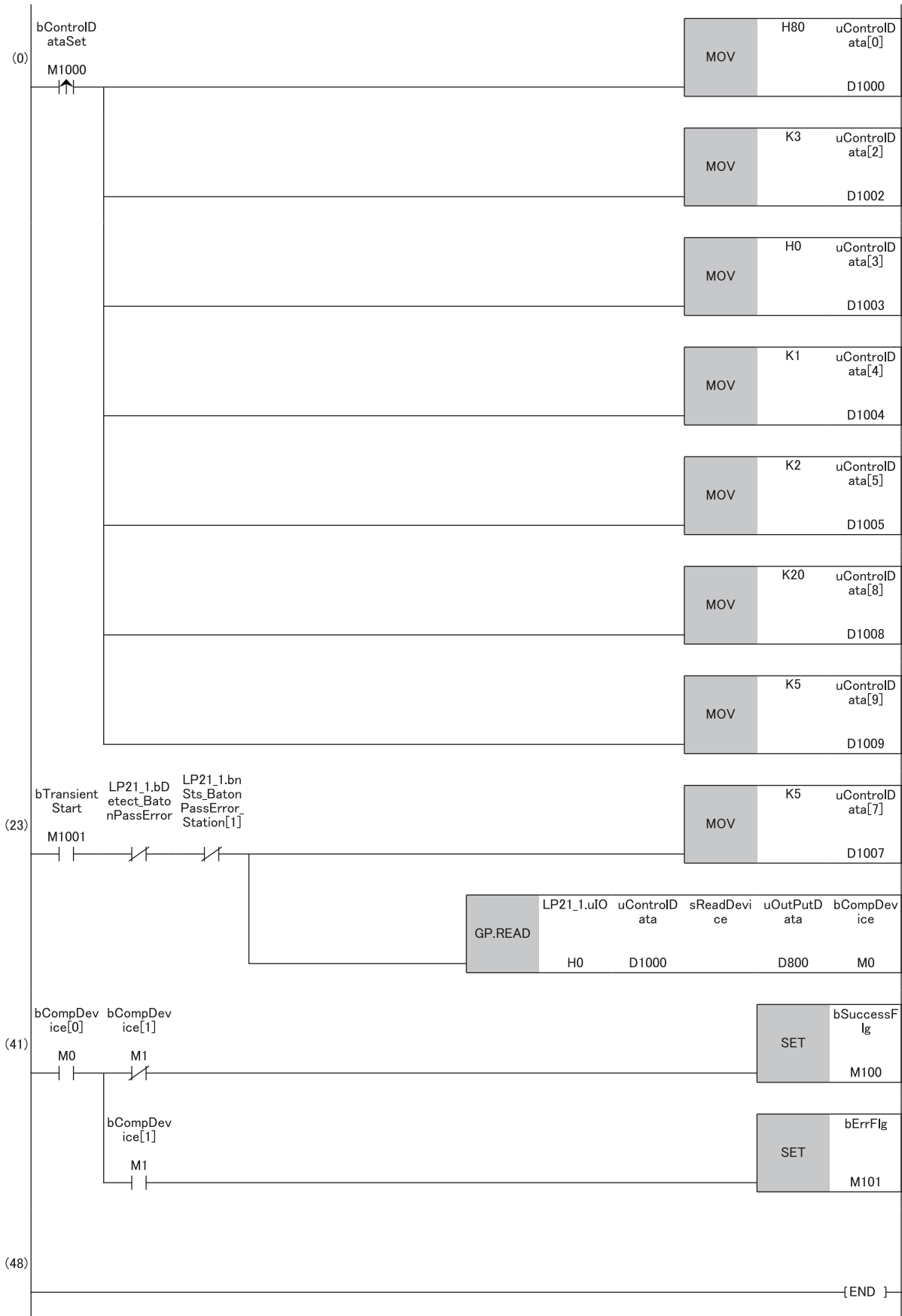

(23)When bTransientStart is turned on while there is no error in 'Baton pass error status of own station' (SB0047) and 'Baton pass status of each station' (SW0070 to SW0073), the number of resends is set and dedicated instruction GP.READ is executed.

(41)When dedicated instruction GP.READ is successfully completed, bSuccessFlg is turned on. When an error response is received, bErrFlg is turned on.

■ Program example (RJ71BR11)

Classification	Label name	Description	Device																																														
Module label	BR11_1.bDetect_BatonPassError	Baton pass error status of own station	SB0047																																														
	BR11_1.bnSts_BatonPassError_Station[1]	Baton pass status of each station	SW0070 to SW0073																																														
Label to be defined	Define global labels as shown below:																																																
	<table border="1"> <thead> <tr> <th>Label Name</th> <th>Data Type</th> <th>Class</th> <th>Assign (Device/Label)</th> <th>Initial Value</th> </tr> </thead> <tbody> <tr> <td>bControlDataSet</td> <td>Bit</td> <td>VAR_GLOBAL</td> <td>M1000</td> <td></td> </tr> <tr> <td>bTransientStart</td> <td>Bit</td> <td>VAR_GLOBAL</td> <td>M1001</td> <td></td> </tr> <tr> <td>uControlData</td> <td>Word (Unsigned)/Bit String (16-bit)(0..17)</td> <td>VAR_GLOBAL</td> <td>D1000</td> <td></td> </tr> <tr> <td>sHeadDevice</td> <td>String(32)</td> <td>VAR_GLOBAL</td> <td></td> <td>"D300"</td> </tr> <tr> <td>uOutPutData</td> <td>Word (Unsigned)/Bit String (16-bit)(0..4)</td> <td>VAR_GLOBAL</td> <td>D800</td> <td></td> </tr> <tr> <td>bCompDevice</td> <td>Bit(0..1)</td> <td>VAR_GLOBAL</td> <td>M0</td> <td></td> </tr> <tr> <td>bSuccessFlg</td> <td>Bit</td> <td>VAR_GLOBAL</td> <td>M100</td> <td></td> </tr> <tr> <td>bErrFlg</td> <td>Bit</td> <td>VAR_GLOBAL</td> <td>M101</td> <td></td> </tr> </tbody> </table>				Label Name	Data Type	Class	Assign (Device/Label)	Initial Value	bControlDataSet	Bit	VAR_GLOBAL	M1000		bTransientStart	Bit	VAR_GLOBAL	M1001		uControlData	Word (Unsigned)/Bit String (16-bit)(0..17)	VAR_GLOBAL	D1000		sHeadDevice	String(32)	VAR_GLOBAL		"D300"	uOutPutData	Word (Unsigned)/Bit String (16-bit)(0..4)	VAR_GLOBAL	D800		bCompDevice	Bit(0..1)	VAR_GLOBAL	M0		bSuccessFlg	Bit	VAR_GLOBAL	M100		bErrFlg	Bit	VAR_GLOBAL	M101	
Label Name	Data Type	Class	Assign (Device/Label)	Initial Value																																													
bControlDataSet	Bit	VAR_GLOBAL	M1000																																														
bTransientStart	Bit	VAR_GLOBAL	M1001																																														
uControlData	Word (Unsigned)/Bit String (16-bit)(0..17)	VAR_GLOBAL	D1000																																														
sHeadDevice	String(32)	VAR_GLOBAL		"D300"																																													
uOutPutData	Word (Unsigned)/Bit String (16-bit)(0..4)	VAR_GLOBAL	D800																																														
bCompDevice	Bit(0..1)	VAR_GLOBAL	M0																																														
bSuccessFlg	Bit	VAR_GLOBAL	M100																																														
bErrFlg	Bit	VAR_GLOBAL	M101																																														

- Control station (station No.1)

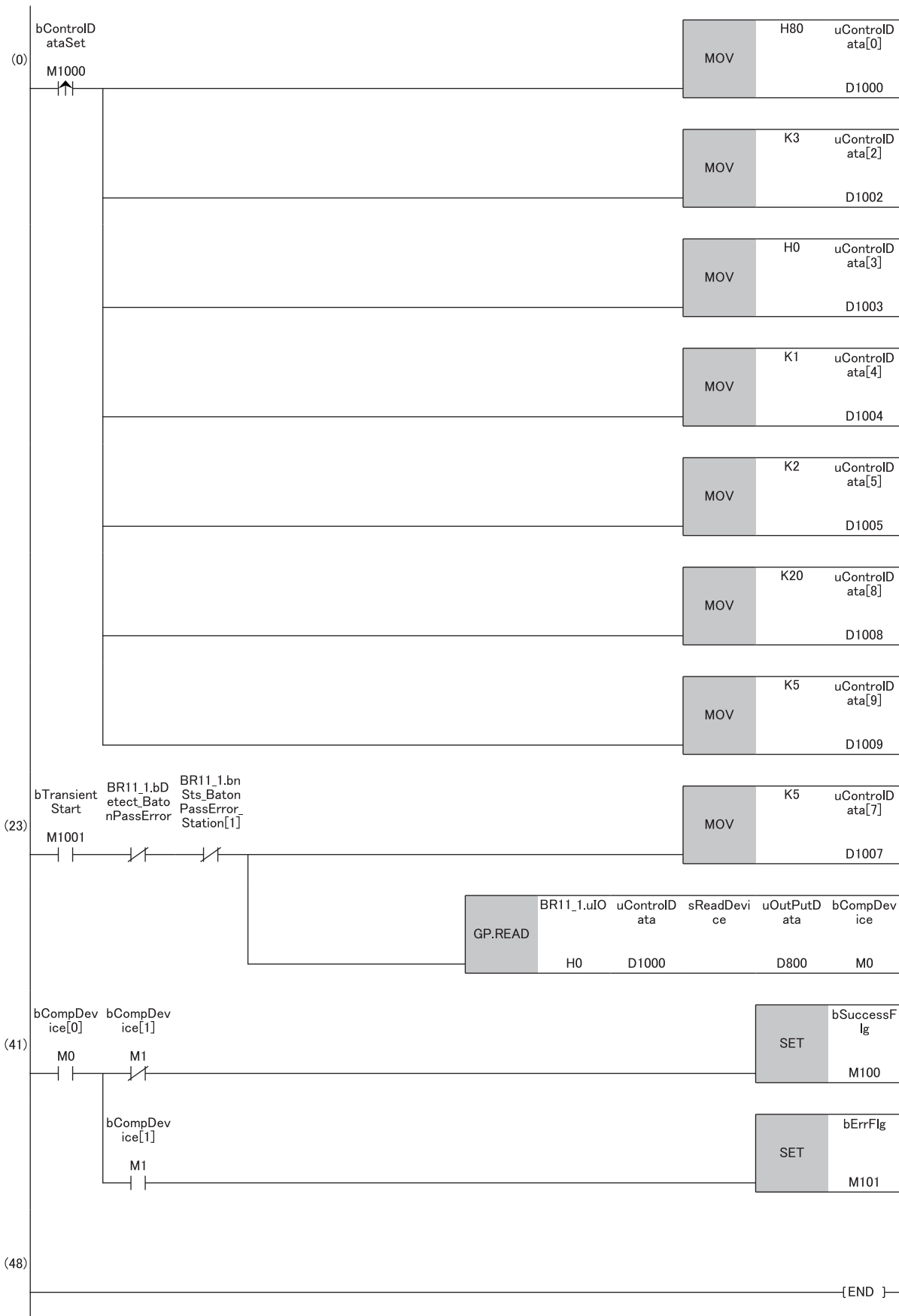

(23)When bTransientStart is turned on while there is no error in 'Baton pass error status of own station' (SB0047) and 'Baton pass status of each station' (SW0070 to SW0073), the number of resends is set and dedicated instruction GP.READ is executed.

(41)When dedicated instruction GP.READ is successfully completed, bSuccessFlg is turned on. When an error response is received, bErrFlg is turned on.

APPENDIX

Appendix 1 External Dimensions

RJ71LP21-25

This chapter describes the external dimensions of the RJ71LP21-25.

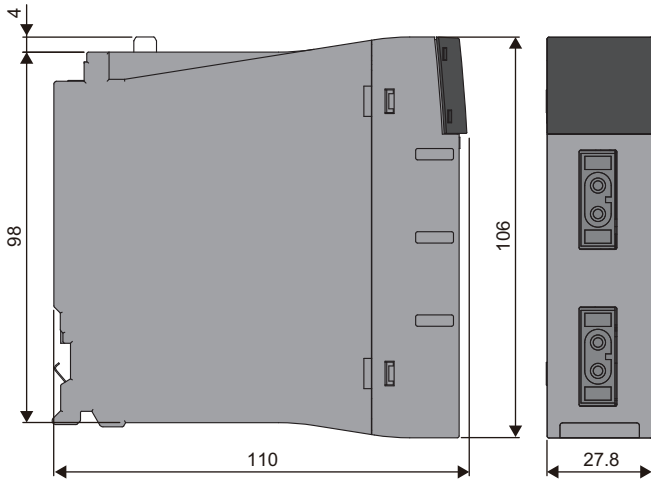

(Unit: mm)

RJ71BR11

This chapter describes the external dimensions of the RJ71BR11.

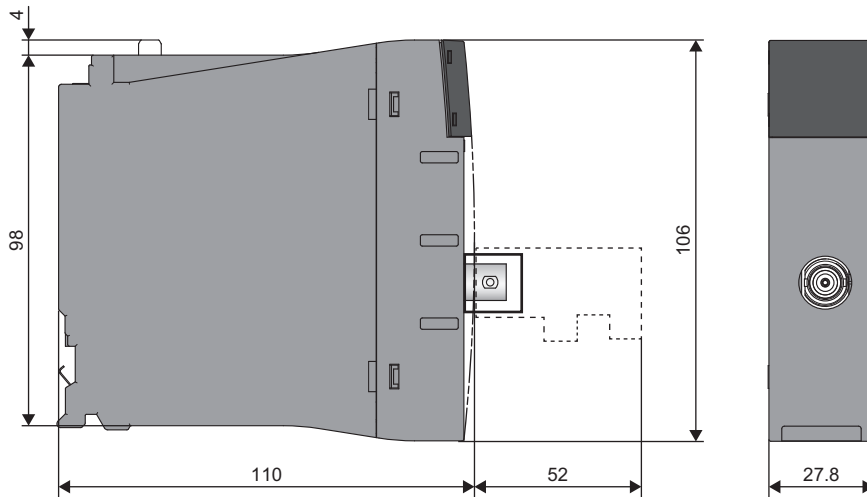

(Unit: mm)

MEMO

A

INDEX

A

Automatic return 28

C

Constant link scan 27
Control station recovery control 28
Control station switching 28
Control system 14
Cyclic transmission stop and restart 27

D

Data assurance 27
Direct access to link devices 27

G

Group transient transmission 27

I

Intelligent function module 14
Interlink transmission 27

L

Link refresh 14
Logical channel 14
Loopback function 28
Low-speed cyclic transmission 27

M

MELSECNET/10 mode 20,21
MELSECNET/H extended mode 20,21
MELSECNET/H mode 20,21

P

Process CPU (redundant mode) 14

R

RAS function 28

S

Standby system 14
Station detach function 28

MEMO

REVISIONS

*The manual number is given on the bottom left of the back cover.

Revision date	*Manual number	Description
February 2020	SH(NA)-082202ENG-A	First edition
March 2021	SH(NA)-082202ENG-B	■Added or modified parts SAFETY PRECAUTIONS, CONDITIONS OF USE FOR THE PRODUCT
February 2023	SH(NA)-082202ENG-C	■Added or modified parts SAFETY PRECAUTIONS, INTRODUCTION, Section 6.1
May 2023	SH(NA)-082202ENG-D	■Added model RJ71BR11 ■Added or modified parts SAFETY PRECAUTIONS, INTRODUCTION, TERMS, GENERIC TERMS AND ABBREVIATIONS, Section 1.1, 1.2, 2.1, 2.2, Chapter 3, Section 5.1, 6.1, 6.2, 7.1, 7.2, Appendix 1
April 2024	SH(NA)-082202ENG-E	■Added or modified part Chapter 3

Japanese manual number: SH-082201-E

This manual confers no industrial property rights or any rights of any other kind, nor does it confer any patent licenses. Mitsubishi Electric Corporation cannot be held responsible for any problems involving industrial property rights which may occur as a result of using the contents noted in this manual.

© 2020 MITSUBISHI ELECTRIC CORPORATION

WARRANTY

Please confirm the following product warranty details before using this product.

1. Gratis Warranty Term and Gratis Warranty Range

If any faults or defects (hereinafter "Failure") found to be the responsibility of Mitsubishi occurs during use of the product within the gratis warranty term, the product shall be repaired at no cost via the sales representative or Mitsubishi Service Company.

However, if repairs are required onsite at domestic or overseas location, expenses to send an engineer will be solely at the customer's discretion. Mitsubishi shall not be held responsible for any re-commissioning, maintenance, or testing on-site that involves replacement of the failed module.

[Gratis Warranty Term]

The gratis warranty term of the product shall be for one year after the date of purchase or delivery to a designated place. Note that after manufacture and shipment from Mitsubishi, the maximum distribution period shall be six (6) months, and the longest gratis warranty term after manufacturing shall be eighteen (18) months. The gratis warranty term of repair parts shall not exceed the gratis warranty term before repairs.

[Gratis Warranty Range]

- (1) The range shall be limited to normal use within the usage state, usage methods and usage environment, etc., which follow the conditions and precautions, etc., given in the instruction manual, user's manual and caution labels on the product.
- (2) Even within the gratis warranty term, repairs shall be charged for in the following cases.
 1. Failure occurring from inappropriate storage or handling, carelessness or negligence by the user. Failure caused by the user's hardware or software design.
 2. Failure caused by unapproved modifications, etc., to the product by the user.
 3. When the Mitsubishi product is assembled into a user's device, Failure that could have been avoided if functions or structures, judged as necessary in the legal safety measures the user's device is subject to or as necessary by industry standards, had been provided.
 4. Failure that could have been avoided if consumable parts (battery, backlight, fuse, etc.) designated in the instruction manual had been correctly serviced or replaced.
 5. Failure caused by external irresistible forces such as fires or abnormal voltages, and Failure caused by force majeure such as earthquakes, lightning, wind and water damage.
 6. Failure caused by reasons unpredictable by scientific technology standards at time of shipment from Mitsubishi.
 7. Any other failure found not to be the responsibility of Mitsubishi or that admitted not to be so by the user.

2. Onerous repair term after discontinuation of production

- (1) Mitsubishi shall accept onerous product repairs for seven (7) years after production of the product is discontinued. Discontinuation of production shall be notified with Mitsubishi Technical Bulletins, etc.
- (2) Product supply (including repair parts) is not available after production is discontinued.

3. Overseas service

Overseas, repairs shall be accepted by Mitsubishi's local overseas FA Center. Note that the repair conditions at each FA Center may differ.

4. Exclusion of loss in opportunity and secondary loss from warranty liability

Regardless of the gratis warranty term, Mitsubishi shall not be liable for compensation to:

- (1) Damages caused by any cause found not to be the responsibility of Mitsubishi.
- (2) Loss in opportunity, lost profits incurred to the user by Failures of Mitsubishi products.
- (3) Special damages and secondary damages whether foreseeable or not, compensation for accidents, and compensation for damages to products other than Mitsubishi products.
- (4) Replacement by the user, maintenance of on-site equipment, start-up test run and other tasks.

5. Changes in product specifications

The specifications given in the catalogs, manuals or technical documents are subject to change without prior notice.

TRADEMARKS

The company names, system names and product names mentioned in this manual are either registered trademarks or trademarks of their respective companies.

In some cases, trademark symbols such as [™] or [®] are not specified in this manual.

SH(NA)-082202ENG-E(2404)MEE

MODEL: R-NET/H-U-IN-E

MODEL CODE: 13JX1E

MITSUBISHI ELECTRIC CORPORATION

HEAD OFFICE: TOKYO BLDG., 2-7-3, MARUNOUCHI, CHIYODA-KU, TOKYO 100-8310, JAPAN
NAGOYA WORKS: 1-14, YADA-MINAMI 5-CHOME, HIGASHI-KU, NAGOYA 461-8670, JAPAN

When exported from Japan, this manual does not require application to the
Ministry of Economy, Trade and Industry for service transaction permission.

Specifications subject to change without notice.