

Programmable Controller

MELSEC iQ-R
series

MELSEC iQ-R Channel Isolated Digital-Analog
Converter Module
User's Manual (Application)

-R60DA8-G
-R60DA16-G
-RY40PT5B-AS



SAFETY PRECAUTIONS

(Read these precautions before using this product.)

Before using this product, please read this manual and the relevant manuals carefully and pay full attention to safety to handle the product correctly.

The precautions given in this manual are concerned with this product only. For the safety precautions of the programmable controller system, refer to the MELSEC iQ-R Module Configuration Manual.

In this manual, the safety precautions are classified into two levels: "⚠ WARNING" and "⚠ CAUTION".

 WARNING	Indicates that incorrect handling may cause hazardous conditions, resulting in death or severe injury.
 CAUTION	Indicates that incorrect handling may cause hazardous conditions, resulting in minor or moderate injury or property damage.

Under some circumstances, failure to observe the precautions given under "⚠ CAUTION" may lead to serious consequences.

Observe the precautions of both levels because they are important for personal and system safety.

Make sure that the end users read this manual and then keep the manual in a safe place for future reference.

[Design Precautions]

WARNING

- Configure safety circuits external to the programmable controller to ensure that the entire system operates safely even when a fault occurs in the external power supply or the programmable controller. Failure to do so may result in an accident due to an incorrect output or malfunction.
 - (1) Emergency stop circuits, protection circuits, and protective interlock circuits for conflicting operations (such as forward/reverse rotations or upper/lower limit positioning) must be configured external to the programmable controller.
 - (2) When the programmable controller detects an abnormal condition, it stops the operation and all outputs are:
 - Turned off if the overcurrent or overvoltage protection of the power supply module is activated.
 - Held or turned off according to the parameter setting if the self-diagnostic function of the CPU module detects an error such as a watchdog timer error.
 - (3) All outputs may be turned on if an error occurs in a part, such as an I/O control part, where the CPU module cannot detect any error. To ensure safety operation in such a case, provide a safety mechanism or a fail-safe circuit external to the programmable controller. For a fail-safe circuit example, refer to "General Safety Requirements" in the MELSEC iQ-R Module Configuration Manual.
 - (4) Outputs may remain on or off due to a failure of a component such as a relay and transistor in an output circuit. Configure an external circuit for monitoring output signals that could cause a serious accident.
 - In an output circuit, when a load current exceeding the rated current or an overcurrent caused by a load short-circuit flows for a long time, it may cause smoke and fire. To prevent this, configure an external safety circuit, such as a fuse.
 - For the operating status of each station after a communication failure, refer to manuals relevant to the network. Incorrect output or malfunction due to a communication failure may result in an accident.
 - When connecting an external device with a CPU module or intelligent function module to modify data of a running programmable controller, configure an interlock circuit in the program to ensure that the entire system will always operate safely. For other forms of control (such as program modification, parameter change, forced output, or operating status change) of a running programmable controller, read the relevant manuals carefully and ensure that the operation is safe before proceeding. Improper operation may damage machines or cause accidents.
 - Especially, when a remote programmable controller is controlled by an external device, immediate action cannot be taken if a problem occurs in the programmable controller due to a communication failure. To prevent this, configure an interlock circuit in the program, and determine corrective actions to be taken between the external device and CPU module in case of a communication failure.
 - Do not write any data to the "system area" and "write-protect area" of the buffer memory in the module. Also, do not use any "use prohibited" signals as an output signal from the CPU module to each module. Doing so may cause malfunction of the programmable controller system. For the "system area", "write-protect area", and the "use prohibited" signals, refer to the user's manual for the module used.
-

[Design Precautions]

WARNING

- If a communication cable is disconnected, the network may be unstable, resulting in a communication failure of multiple stations. Configure an interlock circuit in the program to ensure that the entire system will always operate safely even if communications fail. Failure to do so may result in an accident due to an incorrect output or malfunction.
- Analog outputs may remain on due to a failure of the module. Configure an external interlock circuit for output signals that could cause a serious accident.

[Precautions for using channel isolated digital-analog converter modules (standard mode)]

- Configure a circuit so that the programmable controller is turned on first and then the external power supply. If the external power supply is turned on first, an accident may occur due to an incorrect output or malfunction.

[Precautions for using channel isolated digital-analog converter modules (SIL2 mode)]

- When the R60DA8-G detects a fault in the external power supply or programmable controller, an analog output value becomes an OFF value (0V/0mA) in all channels. Configure an external circuit to ensure that the power source of a hazard is shut off when an analog output value of the R60DA8-G is an OFF value (0V/0mA). Failure to do so may result in an accident.
- When a load current exceeding the rated current or an overcurrent caused by a load short-circuit flows, the R60DA8-G detects an error and an analog output value becomes an OFF value (0V/0mA) in all channels. Note that if the overcurrent state continues for a long time, it may cause smoke and fire. To prevent this, configure an external safety circuit, such as a fuse.
- When a communication failure occurs in CC-Link IE Field Network, an analog output value of the R60DA8-G becomes an OFF value (0V/0mA) in all channels. Check the communication status information and configure an interlock circuit in the program to ensure that the entire system will operate safely. Failure to do so may result in an accident due to an incorrect output or malfunction.
- Create an interlock circuit which uses reset buttons so that the system does not restart automatically after safety functions are executed and an analog output value becomes an OFF value (0V/0mA).

[Precautions for using SIL2 analog control output modules]

- When a load current exceeding the rated current or an overcurrent caused by a load short-circuit flows, the SIL2 analog control output module detects an error and turns off all outputs. Note that if the overcurrent state continues for a long time, it may cause smoke and fire. To prevent this, configure an external safety circuit, such as a fuse.
 - Configure protection circuits, such as a fuse and breaker, external to the SIL2 analog control output module.
-

[Design Precautions]

CAUTION

- Do not install the control lines or communication cables together with the main circuit lines or power cables. Keep a distance of 100mm or more between them. Failure to do so may result in malfunction due to noise.
 - During control of an inductive load such as a lamp, heater, or solenoid valve, a large current (approximately ten times greater than normal) may flow when the output is turned from off to on. Therefore, use a module that has a sufficient current rating.
 - After the CPU module is powered on or is reset, the time taken to enter the RUN status varies depending on the system configuration, parameter settings, and/or program size. Design circuits so that the entire system will always operate safely, regardless of the time.
 - Do not power off the programmable controller or reset the CPU module while the settings are being written. Doing so will make the data in the flash ROM and SD memory card undefined. The values need to be set in the buffer memory and written to the flash ROM and SD memory card again. Doing so also may cause malfunction or failure of the module.
 - When changing the operating status of the CPU module from external devices (such as the remote RUN/STOP functions), select "Do Not Open by Program" for "Opening Method" of "Module Parameter". If "Open by Program" is selected, an execution of the remote STOP function causes the communication line to close. Consequently, the CPU module cannot reopen the line, and external devices cannot execute the remote RUN function.
 - Power on or off the external power supply while the programmable controller is on. Failure to do so may result in incorrect output or malfunction.
 - At on/off of the power or external power supply, or at the output range switching, a voltage may occur or a current may flow between output terminals for a moment. In this case, start the control after analog outputs become stable.
-

[Security Precautions]

WARNING

- To maintain the security (confidentiality, integrity, and availability) of the programmable controller and the system against unauthorized access, denial-of-service (DoS) attacks, computer viruses, and other cyberattacks from external devices via the network, take appropriate measures such as firewalls, virtual private networks (VPNs), and antivirus solutions.
-

[Installation Precautions]

WARNING

- Shut off the external power supply (all phases) used in the system before mounting or removing the module. Failure to do so may result in electric shock or cause the module to fail or malfunction.
-

[Installation Precautions]

CAUTION

- Use the programmable controller in an environment that meets the general specifications in the Safety Guidelines (IB-0800525). Failure to do so may result in electric shock, fire, malfunction, or damage to or deterioration of the product.
 - To mount a module, place the concave part(s) located at the bottom onto the guide(s) of the base unit, and push in the module until the hook(s) located at the top snaps into place. Incorrect interconnection may cause malfunction, failure, or drop of the module.
 - When using the programmable controller in an environment of frequent vibrations, fix the module with a screw.
 - Tighten the screws within the specified torque range. Undertightening can cause drop of the screw, short circuit, or malfunction. Overtightening can damage the screw and/or module, resulting in drop, short circuit, or malfunction.
 - When using an extension cable, connect it to the extension cable connector of the base unit securely. Check the connection for looseness. Poor contact may cause malfunction.
 - When using an SD memory card, fully insert it into the SD memory card slot. Check that it is inserted completely. Poor contact may cause malfunction.
 - Securely insert an extended SRAM cassette or a battery-less option cassette into the cassette connector of the CPU module. After insertion, close the cassette cover and check that the cassette is inserted completely. Poor contact may cause malfunction.
 - Do not directly touch any conductive parts and electronic components of the module, SD memory card, extended SRAM cassette, battery-less option cassette, or connector. Doing so can cause malfunction or failure of the module.
-

[Wiring Precautions]

WARNING

- Shut off the external power supply (all phases) used in the system before installation and wiring. Failure to do so may result in electric shock or cause the module to fail or malfunction.
 - After installation and wiring, attach the included terminal cover to the module before turning it on for operation. Failure to do so may result in electric shock.
-

[Wiring Precautions]

CAUTION

- Individually ground the FG and LG terminals of the programmable controller with a ground resistance of 100 ohms or less. Failure to do so may result in electric shock or malfunction.
 - Use applicable solderless terminals and tighten them within the specified torque range. If any spade solderless terminal is used, it may be disconnected when the terminal screw comes loose, resulting in failure.
 - Check the rated voltage and signal layout before wiring to the module, and connect the cables correctly. Connecting a power supply with a different voltage rating or incorrect wiring may cause fire or failure.
 - Connectors for external devices must be crimped or pressed with the tool specified by the manufacturer, or must be correctly soldered. Incomplete connections may cause short circuit, fire, or malfunction.
 - Securely connect the connector to the module. Poor contact may cause malfunction.
 - Do not install the control lines or communication cables together with the main circuit lines or power cables. Keep a distance of 100mm or more between them. Failure to do so may result in malfunction due to noise.
 - Place the cables in a duct or clamp them. If not, dangling cables may swing or inadvertently be pulled, resulting in malfunction or damage to modules or cables.
In addition, the weight of the cables may put stress on modules in an environment of strong vibrations and shocks.
Do not clamp the extension cables with the jacket stripped. Doing so may change the characteristics of the cables, resulting in malfunction.
 - Check the interface type and correctly connect the cable. Incorrect wiring (connecting the cable to an incorrect interface) may cause failure of the module and external device.
 - Tighten the terminal screws or connector screws within the specified torque range. Undertightening can cause drop of the screw, short circuit, fire, or malfunction. Overtightening can damage the screw and/or module, resulting in drop, short circuit, fire, or malfunction.
 - When disconnecting the cable from the module, do not pull the cable by the cable part. For the cable with connector, hold the connector part of the cable. For the cable connected to the terminal block, loosen the terminal screw. Pulling the cable connected to the module may result in malfunction or damage to the module or cable.
 - Prevent foreign matter such as dust or wire chips from entering the module. Such foreign matter can cause a fire, failure, or malfunction.
 - A protective film is attached to the top of the module to prevent foreign matter, such as wire chips, from entering the module during wiring. Do not remove the film during wiring. Remove it for heat dissipation before system operation.
 - Programmable controllers must be installed in control panels. Connect the main power supply to the power supply module in the control panel through a relay terminal block. Wiring and replacement of a power supply module must be performed by qualified maintenance personnel with knowledge of protection against electric shock.
For wiring, refer to the MELSEC iQ-R Module Configuration Manual.
 - For Ethernet cables to be used in the system, select the ones that meet the specifications in the user's manual for the module used. If not, normal data transmission is not guaranteed.
 - Individually ground the shielded cables of the programmable controller with a ground resistance of 100 ohms or less. Failure to do so may result in electric shock or malfunction.
-

[Startup and Maintenance Precautions]

WARNING

- Do not touch any terminal while power is on. Doing so will cause electric shock or malfunction.
 - Correctly connect the battery connector. Do not charge, disassemble, heat, short-circuit, solder, or throw the battery into the fire. Also, do not expose it to liquid or strong shock. Doing so will cause the battery to produce heat, explode, ignite, or leak, resulting in injury and fire.
 - Shut off the external power supply (all phases) used in the system before cleaning the module or retightening the terminal screws, connector screws, or module fixing screws. Failure to do so may result in electric shock.
-

[Startup and Maintenance Precautions]

CAUTION

- When connecting an external device with a CPU module or intelligent function module to modify data of a running programmable controller, configure an interlock circuit in the program to ensure that the entire system will always operate safely. For other forms of control (such as program modification, parameter change, forced output, or operating status change) of a running programmable controller, read the relevant manuals carefully and ensure that the operation is safe before proceeding. Improper operation may damage machines or cause accidents.
 - Especially, when a remote programmable controller is controlled by an external device, immediate action cannot be taken if a problem occurs in the programmable controller due to a communication failure. To prevent this, configure an interlock circuit in the program, and determine corrective actions to be taken between the external device and CPU module in case of a communication failure.
 - Do not disassemble or modify the modules. Doing so may cause failure, malfunction, injury, or a fire.
 - Use any radio communication device such as a cellular phone or PHS (Personal Handy-phone System) 25cm or more away in all directions from the programmable controller. Failure to do so may cause malfunction.
 - Shut off the external power supply (all phases) used in the system before mounting or removing the module. Failure to do so may cause the module to fail or malfunction.
 - Tighten the screws within the specified torque range. Undertightening can cause drop of the component or wire, short circuit, or malfunction. Overtightening can damage the screw and/or module, resulting in drop, short circuit, or malfunction.
 - After the first use of the product, do not perform each of the following operations more than 50 times (IEC 61131-2/JIS B 3502 compliant).
Exceeding the limit may cause malfunction.
 - Mounting/removing the module to/from the base unit
 - Inserting/removing the extended SRAM cassette or battery-less option cassette to/from the CPU module
 - Mounting/removing the terminal block to/from the module
 - After the first use of the product, do not insert/remove the SD memory card to/from the CPU module more than 500 times. Exceeding the limit may cause malfunction.
 - Do not touch the metal terminals on the back side of the SD memory card. Doing so may cause malfunction or failure of the module.
 - Do not touch the integrated circuits on the circuit board of an extended SRAM cassette or a battery-less option cassette. Doing so may cause malfunction or failure of the module.
 - Do not drop or apply shock to the battery to be installed in the module. Doing so may damage the battery, causing the battery fluid to leak inside the battery. If the battery is dropped or any shock is applied to it, dispose of it without using.
 - Startup and maintenance of a control panel must be performed by qualified maintenance personnel with knowledge of protection against electric shock. Lock the control panel so that only qualified maintenance personnel can operate it.
 - Before handling the module, touch a conducting object such as a grounded metal to discharge the static electricity from the human body. Failure to do so may cause the module to fail or malfunction.
-

[Operating Precautions]

CAUTION

- When changing data and operating status, and modifying program of the running programmable controller from an external device such as a personal computer connected to an intelligent function module, read relevant manuals carefully and ensure the safety before operation. Incorrect change or modification may cause system malfunction, damage to the machines, or accidents.
 - Do not power off the programmable controller or reset the CPU module while the setting values in the buffer memory are being written to the flash ROM in the module. Doing so will make the data in the flash ROM and SD memory card undefined. The values need to be set in the buffer memory and written to the flash ROM and SD memory card again. Doing so can cause malfunction or failure of the module.
-

[Disposal Precautions]

CAUTION

- When disposing of this product, treat it as industrial waste.
 - When disposing of batteries, separate them from other wastes according to the local regulations. For details on battery regulations in EU member states, refer to the MELSEC iQ-R Module Configuration Manual.
-

[Transportation Precautions]

CAUTION

- When transporting lithium batteries, follow the transportation regulations. For details on the regulated models, refer to the MELSEC iQ-R Module Configuration Manual.
 - The halogens (such as fluorine, chlorine, bromine, and iodine), which are contained in a fumigant used for disinfection and pest control of wood packaging materials, may cause failure of the product. Prevent the entry of fumigant residues into the product or consider other methods (such as heat treatment) instead of fumigation. The disinfection and pest control measures must be applied to unprocessed raw wood.
-

CONDITIONS OF USE FOR THE PRODUCT

- (1) MELSEC programmable controller ("the PRODUCT") shall be used in conditions;
 - i) where any problem, fault or failure occurring in the PRODUCT, if any, shall not lead to any major or serious accident; and
 - ii) where the backup and fail-safe function are systematically or automatically provided outside of the PRODUCT for the case of any problem, fault or failure occurring in the PRODUCT.
 - (2) The PRODUCT has been designed and manufactured for the purpose of being used in general industries. MITSUBISHI ELECTRIC SHALL HAVE NO RESPONSIBILITY OR LIABILITY (INCLUDING, BUT NOT LIMITED TO ANY AND ALL RESPONSIBILITY OR LIABILITY BASED ON CONTRACT, WARRANTY, TORT, PRODUCT LIABILITY) FOR ANY INJURY OR DEATH TO PERSONS OR LOSS OR DAMAGE TO PROPERTY CAUSED BY THE PRODUCT THAT ARE OPERATED OR USED IN APPLICATION NOT INTENDED OR EXCLUDED BY INSTRUCTIONS, PRECAUTIONS, OR WARNING CONTAINED IN MITSUBISHI ELECTRIC USER'S, INSTRUCTION AND/OR SAFETY MANUALS, TECHNICAL BULLETINS AND GUIDELINES FOR the PRODUCT.
("Prohibited Application")
Prohibited Applications include, but not limited to, the use of the PRODUCT in;
 - Nuclear Power Plants and any other power plants operated by Power companies, and/or any other cases in which the public could be affected if any problem or fault occurs in the PRODUCT.
 - Railway companies or Public service purposes, and/or any other cases in which establishment of a special quality assurance system is required by the Purchaser or End User.
 - Aircraft or Aerospace, Medical applications, Train equipment, transport equipment such as Elevator and Escalator, Incineration and Fuel devices, Vehicles, Manned transportation, Equipment for Recreation and Amusement, and Safety devices, handling of Nuclear or Hazardous Materials or Chemicals, Mining and Drilling, and/or other applications where there is a significant risk of injury to the public or property.Notwithstanding the above restrictions, Mitsubishi Electric may in its sole discretion, authorize use of the PRODUCT in one or more of the Prohibited Applications, provided that the usage of the PRODUCT is limited only for the specific applications agreed to by Mitsubishi Electric and provided further that no special quality assurance or fail-safe, redundant or other safety features which exceed the general specifications of the PRODUCTS are required. For details, please contact the Mitsubishi Electric representative in your region.
 - (3) Mitsubishi Electric shall have no responsibility or liability for any problems involving programmable controller trouble and system trouble caused by DoS attacks, unauthorized access, computer viruses, and other cyberattacks.
 - For the R60DA8-G (when SIL2 mode is set) and the RY40PT5B-AS
- (1) Although Mitsubishi Electric has declared Product's compliance with the international safety standards IEC61508, IEC61511, this fact does not guarantee that Product will be free from any malfunction or failure. The user of this Product shall comply with any and all applicable safety standard, regulation or law and take appropriate safety measures for the system in which the Product is installed or used and shall take the second or third safety measures other than the Product. Mitsubishi Electric is not liable for damages that could have been prevented by compliance with any applicable safety standard, regulation or law.
 - (2) Mitsubishi Electric prohibits the use of Products with or in any application involving, and Mitsubishi Electric shall not be liable for a default, a liability for defect warranty, a quality assurance, negligence or other tort and a product liability in these applications.
 - (a) power plants,
 - (b) trains, railway systems, airplanes, airline operations, other transportation systems,
 - (c) hospitals, medical care, dialysis and life support facilities or equipment,
 - (d) amusement equipments,
 - (e) incineration and fuel devices,
 - (f) handling of nuclear or hazardous materials or chemicals,
 - (g) mining and drilling,
 - (h) and other applications where the level of risk to human life, health or property are elevated.
 - (3) Mitsubishi Electric shall have no responsibility or liability for any problems involving programmable controller trouble and system trouble caused by DoS attacks, unauthorized access, computer viruses, and other cyberattacks.

INTRODUCTION

Thank you for purchasing the Mitsubishi Electric MELSEC iQ-R series programmable controllers.

This manual describes the functions, parameter settings, and troubleshooting of the relevant products listed below.

Before using this product, please read this manual and the relevant manuals carefully and develop familiarity with the functions and performance of the MELSEC iQ-R series programmable controller to handle the product correctly.

When applying the program examples provided in this manual to an actual system, ensure the applicability and confirm that it will not cause system control problems.

Please make sure that the end users read this manual.

Point

Unless otherwise specified, this manual provides program examples in which the I/O numbers of X/Y0 to X/YF are assigned to the D/A converter module. Assign I/O numbers when applying the program examples to an actual system. For I/O number assignment, refer to the following.

 MELSEC iQ-R Module Configuration Manual

Relevant products

R60DA8-G, R60DA16-G, RY40PT5B-AS

Modes

Modes of the R60DA8-G are roughly classified into two groups listed below. A mode is set using the module parameter of GX Works3. Mode transition is not possible while the module is operating.

Mode	Description
Standard mode	<ul style="list-style-type: none">The mode for using the D/A converter module in a normal systemThe standard mode is subdivided into three types: normal mode, offset/gain setting mode, and Q compatible mode.
SIL2 mode	<ul style="list-style-type: none">An operation mode of the I/O module and the intelligent function module to perform safety input and output at the SIL2 level. This mode is used when a customer builds safety applications up to IEC 61508: 2010 SIL2 or IEC 61511: 2015 SIL2.The R60DA8-G in SIL2 mode can be used to build safety functions for general industry machinery.

Note that the R60DA16-G does not support SIL2 mode and operates only in standard mode.

■Enabling/disabling the safety module

To operate the R60DA8-G in SIL2 mode, it is necessary to enable the safety module so that the set parameters become enabled.

To stop the safety I/O of the R60DA8-G operating in SIL2 mode, or to use that module in standard mode in the other system, disabling the safety module is required.

RY40PT5B-AS

The RY40PT5B-AS is a module required only when the R60DA8-G is used in SIL2 mode. The RY40PT5B-AS alone does not perform operation, unlike the other MELSEC iQ-R series output modules.

For details, refer to the following.

 Page 158 OVERVIEW

CONTENTS

SAFETY PRECAUTIONS	1
CONDITIONS OF USE FOR THE PRODUCT	11
INTRODUCTION	12
RELEVANT MANUALS	17
TERMS	18
GENERIC TERMS AND ABBREVIATIONS	18

PART 1 STANDARD MODE

CHAPTER 1 FUNCTIONS	20
1.1 Modes	21
1.2 Range Switching Function	23
1.3 D/A Conversion Enable/Disable Setting Function	24
1.4 D/A Output Enable/Disable Setting Function	24
1.5 Analog Output HOLD/CLEAR Function	25
1.6 Analog Output Test Function When the CPU Module is in STOP Status	26
1.7 Scaling Function	27
1.8 Shift Function	30
1.9 Alert Output Function	32
1.10 Rate Control Function	34
1.11 External Power Supply Disconnection Detection Function	37
1.12 Disconnection Detection Function	38
1.13 Interrupt Function	45
1.14 Error History Function	48
1.15 Event History Function	51
1.16 Backing up, Saving, and Restoring Offset/Gain Values	52
When the module-specific backup parameter is used	52
When the module-specific backup parameter is not used	55
1.17 Q Compatible Mode Function	60
CHAPTER 2 PARAMETER SETTINGS	61
2.1 Basic Setting	61
2.2 Application Setting	62
2.3 Interrupt Setting	63
2.4 Refresh Setting	64
Refresh processing time	65
CHAPTER 3 TROUBLESHOOTING	66
3.1 Troubleshooting with the LEDs	66
3.2 Checking the State of the Module	67
3.3 Troubleshooting by Symptom	69
When the D/A converter module does not start up	69
When the RUN LED flashes or turns off	69
When the ERR LED turns on	69
When the ALM LED turns on	69
When the analog output is not performed	70
When HOLD of an analog output value is not available	70

	When 'External power supply READY flag (CH1 to CH8)' (X7) and 'External power supply READY flag (CH9 to CH16)' (X17) do not turn on	70
3.4	List of Error Codes	71
3.5	List of Alarm Codes	74

APPENDICES (STANDARD MODE) 75

Appendix 1	Module Label	75
Appendix 2	I/O Signals	77
	List of I/O signals	77
	Details of input signals	79
	Details of output signals	86
Appendix 3	Buffer Memory Areas	89
	List of buffer memory addresses	89
	Details of buffer memory addresses	104
Appendix 4	Dedicated Instructions	142
	Instruction list	142
Appendix 5	Operation Examples of When the Remote Head Module Is Mounted	143
	System configuration example	143
	Setting in the master station	144
	Setting in the intelligent device station	147
	Checking the network status	150
	Program examples	150
Appendix 6	Disabling the Safety Module	153
Appendix 7	Using the Module in the Redundant System with Redundant Extension Base Unit	154
	Restrictions on functions and specifications	154
	Precautions	154
Appendix 8	Added or Modified Functions	155
	Added function	155
	Modified functions	155

PART 2 SIL2 MODE

CHAPTER 4 OVERVIEW 158

CHAPTER 5 PART NAMES 161

CHAPTER 6 SPECIFICATIONS 163

6.1	Performance Specifications	163
	Restrictions	167
6.2	Function List	168

CHAPTER 7 PROCEDURES BEFORE OPERATION 169

CHAPTER 8 SYSTEM CONFIGURATION 176

8.1	Redundant Master Station	177
8.2	Redundant Line	179
8.3	Firmware Version for SIL2 Mode	181
8.4	Reference Product	181

CHAPTER 9	INSTALLATION AND WIRING	182
9.1	Wiring Precautions	182
	Connector for external devices for the R60DA8-G	182
	18-point terminal block for the RY40PT5B-AS	183
9.2	External Wiring	184
	Signal layout for the connector for external devices	184
	Examples of external wiring	185
	Relay switching wiring	188
	Precautions for channel number and output signal	189
CHAPTER 10	FUNCTIONS	190
10.1	SIL2 Mode	191
10.2	Range Switching Function	206
10.3	D/A Conversion Enable/Disable Setting Function	207
10.4	D/A Output Enable/Disable Setting Function	207
10.5	Scaling Function	208
10.6	SIL2 D/A Conversion Function	211
	Analog output read-back function	221
	D/A conversion circuit diagnostic function	223
	Relay diagnostic function	228
	Output HOLD function	229
10.7	Self-diagnostic Function	230
10.8	RY40PT5B-AS Functions	231
	Digital output read-back function	231
	Protection function	232
10.9	Error History Function	233
10.10	Event History Function	234
CHAPTER 11	PARAMETER SETTINGS	236
11.1	Basic Settings	236
11.2	Application Settings	237
11.3	Refresh Settings	238
CHAPTER 12	EXAMPLE OF OPERATION	239
CHAPTER 13	MAINTENANCE AND INSPECTION	245
CHAPTER 14	TROUBLESHOOTING	247
14.1	Troubleshooting with the LEDs	247
14.2	Checking the State of the Module	248
14.3	Troubleshooting by Symptom	250
	When the module does not start up	250
	When the RUN LED flashes (R60DA8-G only)	250
	When the RUN LED is off	250
	When the ERR LED flashes	250
	When the ERR LED turns on (R60DA8-G only)	250
	When the S MODE LED flashes or turns off	251
	When the ALM LED flashes (R60DA8-G only)	252
	When a module parameter error is displayed in the "Module Diagnostics" window	252
	When an analog output read-back discrepancy detection error occurs	252

When a D/A conversion circuit diagnostic error occurs	253
When it takes time for the SIL2 analog output system to start up	254
When the analog output value is OFF value (0V/0mA)	254
When output cannot be performed to external output of the RY40PT5B-AS	255
When the R60DA8-G shuts down	255
14.4 Troubleshooting While Proceeding Procedures Before Operation	256
When the module parameter write to the remote head module fails	256
Troubleshooting on the "Safety Communication Setting" window	256
Troubleshooting on the "Safety Module Operation" window	256
14.5 Troubleshooting SIL2 Diagnostic FB Library	259
When the SIL2 diagnostic FB library is not registered as a product option	259
When a program conversion error occurs in GX Works3	259
When the execution status of the SIL2 diagnostic FB library is off	259
Checking by status code of the SIL2 safety program FB	259
Checking by error code of the SIL2 safety program FB	263
Checking by error code of the SIL2 standard program FB	263
14.6 List of Error Codes	264
APPENDICES (SIL2 MODE)	268
<hr/>	
Appendix 9 I/O Signals	268
List of I/O signals (R60DA8-G)	268
List of I/O signals (RY40PT5B-AS)	268
Appendix 10 Buffer Memory	269
List of buffer memory areas (R60DA8-G)	269
Details of buffer memory area (R60DA8-G)	269
List of buffer memory areas (RY40PT5B-AS)	270
Details of buffer memory area (RY40PT5B-AS)	270
Appendix 11 I/O Conversion Characteristics	271
Appendix 12 Accuracy	275
Appendix 13 Calculation Method of Safety Response Time (Maximum Value)	276
Appendix 14 Added or Modified Function	277
Appendix 15 External Dimensions	278
INDEX	280
<hr/>	
REVISIONS	282
WARRANTY	283
TRADEMARKS	286

RELEVANT MANUALS

Manual name [manual number]	Description	Available form
MELSEC iQ-R Channel Isolated Digital-Analog Converter Module User's Manual (Application) [SH-081491ENG] (this manual)	Functions, parameter settings, troubleshooting, I/O signals, and buffer memory of the D/A converter module	Print book e-Manual PDF
MELSEC iQ-R Module Configuration Manual [SH-081262ENG]	The combination of the MELSEC iQ-R series modules, common information on the installation/wiring in the system, and specifications of the power supply module, base unit, SD memory card, and battery	Print book e-Manual PDF
MELSEC iQ-R Channel Isolated Digital-Analog Converter Module User's Manual (Startup) [SH-081489ENG]	Performance specifications, procedures before operation, wiring, operation examples, and offset/gain setting of the D/A converter module	Print book e-Manual PDF
MELSEC iQ-R Programming Manual (Module Dedicated Instructions) [SH-081976ENG]	Dedicated instructions for the intelligent function modules	e-Manual PDF
MELSEC iQ-R Analog-Digital Converter Module/Digital-Analog Converter Module Function Block Reference [BCN-P5999-0375]	FBs of the A/D converter modules and D/A converter modules	e-Manual PDF
GX Works3 Operating Manual [SH-081215ENG]	System configuration, parameter settings, and online operations of GX Works3	e-Manual PDF
MELSEC iQ-R Online Module Change Manual [SH-081501ENG]	The online module change, which allows a module to be changed without stopping the system for MELSEC iQ-R series programmable controllers	Print book e-Manual PDF



e-Manual refers to the Mitsubishi Electric FA electronic book manuals that can be browsed using a dedicated tool.

e-Manual has the following features:

- Required information can be cross-searched in multiple manuals.
- Other manuals can be accessed from the links in the manual.
- The hardware specifications of each part can be found from the product figures.
- Pages that users often browse can be bookmarked.
- Sample programs can be copied to an engineering tool.

TERMS

Unless otherwise specified, this manual uses the following terms.

Term	Description
Buffer memory	A memory in an intelligent function module for storing data (such as setting values and monitored values). For a CPU module, it refers to a memory for storing data (such as setting values and monitored values of the Ethernet function, data used for data communications of the multiple CPU system function).
Engineering tool	A tool used for setting up programmable controllers, programming, debugging, and maintenance
Global label	A label that is valid for all the program data when multiple program data are created in the project. There are two types of global label: a module specific label (module label), which is generated automatically by GX Works3, and an optional label, which can be created for any specified device.
Module Label	A label that represents one of memory areas (I/O signals and buffer memory areas) specific to each module in a given character string. For the module used, GX Works3 automatically generates this label, which can be used as a global label.
Normal mode	A mode used for normal D/A conversion. In the engineering tool, the item name of the mode is displayed as "Normal mode (D/A conversion process)".
Offset/gain setting mode	A mode used for performing the offset/gain setting
Q compatible mode	A mode in which the module operates with the buffer memory map converted to the equivalent one of the MELSEC-Q series
R mode	A mode in which the module operates with the buffer memory map that has been newly laid out in the MELSEC iQ-R series
Redundant system with redundant extension base unit	A redundant system that is configured using extension base unit(s)
SIL2 mode	An operation mode of the I/O module and the intelligent function module to perform safety input and output at the SIL2 level.
Standard mode	This mode is for using the D/A converter module in a normal system.
User range	An analog output range where any value can be set. This range can be set in the offset/gain setting.
Watchdog timer error	A watchdog timer is a timer to monitor whether internal processing of a module is performed normally. A watchdog timer error is an error that occurs when internal processing is not performed normally.

GENERIC TERMS AND ABBREVIATIONS

Unless otherwise specified, this manual uses the following generic terms and abbreviations.

Generic term/abbreviation	Description
D/A converter module	An abbreviation for the MELSEC iQ-R series channel isolated digital-analog converter module
Factory default setting	A generic term for analog output ranges of 4 to 20mA, 0 to 20mA, 1 to 5V, 0 to 5V, -10 to 10V, -12 to 12V, 4 to 20mA (extended mode), and 1 to 5V (extended mode). In the window on the engineering tool, 4 to 20mA (extended mode) and 1 to 5V (extended mode) are displayed as the following: <ul style="list-style-type: none"> • 4 to 20mA (Extension) • 1 to 5V (Extension)
Remote head module	An abbreviation for the RJ72GF15-T2 CC-Link IE Field Network remote head module

This part consists of the following chapters. These chapters describe the details on using the D/A converter module in standard mode.

1 FUNCTIONS

2 PARAMETER SETTINGS

3 TROUBLESHOOTING

APPENDICES (STANDARD MODE)

1 FUNCTIONS

This chapter describes the functions of the D/A converter module and the setting procedures for those functions. For details on the I/O signals and the buffer memory, refer to the following.

☞ Page 77 I/O Signals

☞ Page 89 Buffer Memory Areas

Point

- This chapter describes I/O signals and buffer memory addresses for CH1. For details on the I/O signals and buffer memory addresses for CH2 or later, refer to the following.

☞ Page 77 List of I/O signals

☞ Page 89 List of buffer memory addresses

- □ in error codes and alarm codes indicates a channel where an error or alarm has occurred. A numerical value corresponding to the error comes in △. For details on the numerical values, refer to the following.

☞ Page 71 List of Error Codes

☞ Page 74 List of Alarm Codes

1.1 Modes

The D/A converter module has the normal mode and offset/gain setting mode. Change the mode according to the function used.

The following describes each mode.

Point

In each operation mode, the Q compatible mode function can also be selected. This function converts the buffer memory layout of the D/A converter module to the equivalent one to the MELSEC-Q series layout, and operates with it.

Normal mode

This mode is for performing the normal D/A conversion. The value set in 'CH1 Digital value' (Un\G460) is output in analog after the D/A conversion.

The following figure shows the sequence to output the value in analog.

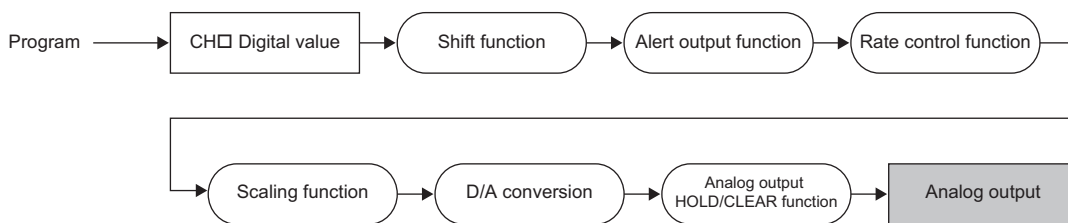

Offset/gain setting mode

This mode is for performing the offset/gain setting.

For details on the offset/gain setting, refer to the following.

📖 MELSEC iQ-R Channel Isolated Digital-Analog Converter Module User's Manual (Startup)

Mode transitions

The following figure and table describe the transition conditions for each mode.

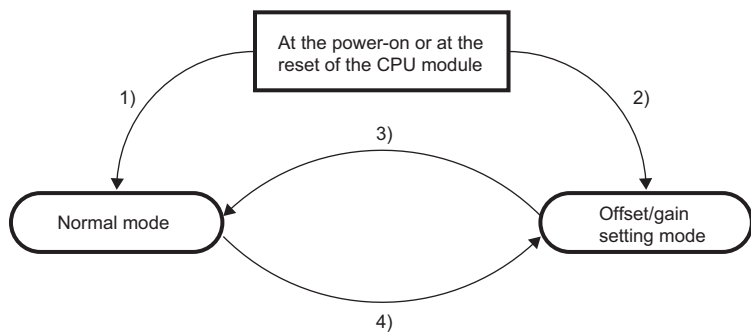

No.	Transition condition	
(1)	Set "Operation mode setting" to "Normal mode (D/A conversion process)" in "Basic setting" of the engineering tool.	
(2)	Set "Operation mode setting" to "Offset/gain setting mode" in "Basic setting" of the engineering tool.	
(3)	Perform the mode transition by either of the following methods.	
	Method 1	Execute the G(P).OFFGAN instruction (Argument "S": 0: Transition to the normal mode).
(4)	Method 2	Set the following values for 'Mode switching setting' (Un\G296, Un\G297) and turn on and off 'Operating condition setting request' (Y9). <ul style="list-style-type: none"> • Un\G296: 5260H • Un\G297: 4441H
	Method 1	Execute the G(P).OFFGAN instruction (Argument "S": 1: Transition to the offset/gain setting mode).
(4)	Method 2	Set the following values for 'Mode switching setting' (Un\G296, Un\G297) and turn on and off 'Operating condition setting request' (Y9). <ul style="list-style-type: none"> • Un\G296: 4441H • Un\G297: 5260H

Setting procedure

Set "Operation mode setting" to "Normal mode (D/A conversion process)" or "Offset/gain setting mode".

[Navigation window] ⇨ [Parameter] ⇨ [Module Information] ⇨ Module model name ⇨ [Basic setting] ⇨ [Operation mode setting function]

Checking method

The currently selected mode can be checked with the following items.

Mode	RUN LED status	'Offset/gain setting mode status flag' (XA)
Normal mode	On	Off*1
Offset/gain setting mode	Flashing	On*1

*1 When 'User range write request' (YA) is off

1.2 Range Switching Function

This function allows switching the output range of an analog output for each channel. Switching the range makes it possible to change the I/O conversion characteristic.

Operation

The data set in 'CH1 Digital value' (Un\G460) is converted to an analog value within the analog output range of the output range set in "Output range setting" and the analog value is output.

Set a value between -32768 and 32767 in 'CH1 Digital value' (Un\G460).

Setting procedure

Set the output range to be used in "Output range setting".

 [Navigation window] ⇒ [Parameter] ⇒ [Module Information] ⇒ Module model name ⇒ [Basic setting] ⇒ [Range switching function]

Output range setting	Digital input range
4 to 20mA	0 to 32000
0 to 20mA	
1 to 5V	0 to 32000
0 to 5V	
-10 to 10V	-32000 to 32000
-12 to 12V	
4 to 20mA (extended mode)	-8000 to 36000
1 to 5V (extended mode)	
User range setting 3	-32000 to 32000
User range setting 2	
User range setting 1	

After the data is written, the range is switched when the programmable controller power supply is turned off and on or when the CPU module is reset.

Point

The range can be switched or set with the following buffer memory areas.

- 'CH1 Range setting' (Un\G598)
- 'CH1 Range setting monitor' (Un\G430)

For details on the buffer memory addresses, refer to the following.

 Page 131 CH1 Range setting

 Page 113 CH1 Range setting monitor

How to output the extended part of the extended mode of the output range

The data of the extended part of the extended mode of the output range (the digital values in the range of 32768 to 36767 that correspond to the analog value higher than 20mA or 5V) can be output with the scaling function or shift function.

For details, refer to the following.

 Page 27 Scaling Function

 Page 30 Shift Function

Precautions

The output range cannot be changed for channels set to D/A conversion disabled. To change the output range, set "D/A conversion enable/disable setting" to "D/A conversion enabled" and 'CH1 Output enable/disable flag' (Y1) to OFF.

1.3 D/A Conversion Enable/Disable Setting Function

Controls whether to enable or disable the D/A conversion for each channel.

Disabling the D/A conversion for unused channels reduces the D/A conversion cycles.

Setting procedure

Set "D/A conversion enable/disable setting" to "D/A conversion enable" or "D/A conversion disable".

 [Navigation window] ⇒ [Parameter] ⇒ [Module Information] ⇒ Module model name ⇒ [Basic setting] ⇒ [D/A conversion enable/disable function]

1.4 D/A Output Enable/Disable Setting Function

Specify whether to output the D/A conversion value or the offset value for each channel.

The conversion speed is a constant, regardless of the output enable/disable state.

Setting procedure

Set to enable or disable the D/A output for each channel with 'CH1 Output enable/disable flag' (Y1).

'CH1 Output enable/disable flag' (Y1)	Analog output
Enable (ON)	The D/A conversion value is output.
Disable (OFF)	The offset value is output.

1.5 Analog Output HOLD/CLEAR Function

Set whether to hold or clear the analog output value that has been output when the operating status of the CPU module is RUN, STOP, or stop error.

The HOLD/CLEAR setting can be checked with 'CH1 HOLD/CLEAR function setting monitor' (Un\G431).

Operation

When the operating status of the CPU module is RUN, STOP, or stop error, the analog output status changes as shown in the following table, depending on the combination of the settings of the analog output HOLD/CLEAR setting, 'CH1 D/A conversion enable/disable setting' (Un\G500), and 'CH1 Output enable/disable flag' (Y1).

Execution status	'CH1 D/A conversion enable/disable setting' (Un\G500)	Enable		Disable
	'CH1 Output enable/disable flag' (Y1)	Enable		Disable
	Analog output HOLD/CLEAR setting	HOLD	CLEAR	HOLD or CLEAR
Analog output produced when the CPU module is in the RUN status		The digital value converted in analog is output.		Offset value
Analog output produced when the CPU module is in the STOP state		Hold	Offset value	Offset value ^{*2}
Analog output produced when the CPU module is in the stop error state		Hold	Offset value	Offset value
Analog output produced when a watchdog timer error ^{*1} occurs		0V/0mA	0V/0mA	0V/0mA

*1 The error occurs due to a hardware failure of the D/A converter module or other causes. 'Module READY' (X0) and the RUN LED of the D/A converter module turn off.

When a watchdog timer error occurs, 'Module READY' (X0) and the RUN LED of the D/A converter module turn off.

*2 The following operation is performed when the CPU module is in the STOP state, the D/A conversion enable/disable setting is set to D/A conversion enable (0) for the channel where HOLD is set, and 'Operating condition setting request' (Y9) is turned on and off. When Output enable/disable flag is off: Outputs 0V/0mA.

When Output enable/disable flag is turned on: Outputs the offset value.

Setting procedure

Set "Analog output HOLD/CLEAR setting" to "HOLD" or "CLEAR".

 [Navigation window] ⇒ [Parameter] ⇒ [Module Information] ⇒ Module model name ⇒ [Basic setting] ⇒ [Output mode setting function]

Precautions when the remote head module has been mounted

When the D/A converter module has been mounted on the remote head module, set whether to hold or clear the analog output value that has been output when the host station is disconnected with "CPU error output mode setting" of the module parameter.

The following describes the settings required for using "CPU error output mode setting".

- Enable the station-based block data assurance for cyclic data on the sending side.
- To hold the analog output value, set "CPU error output mode setting" to "Hold". The analog output HOLD/CLEAR function setting is disabled.

This setting is enabled for each module and cannot be set for each channel. To match the output status of when a stop error occurs or the CPU module is in the STOP state and that of when the host station is disconnected, set "Analog output HOLD/CLEAR setting" to the same value in all the channels.

Operating status	CPU error output mode setting ^{*1}	Analog output HOLD/CLEAR setting (Set the same value in all the channels.)
The analog output value is held.	Hold	HOLD
The analog output value is cleared. (The offset value is output.)	Clear	CLEAR

*1 CPU error output mode setting is enabled in the following cases.

- When the host station is disconnected due to a network error
- When the data link is stopped by the CC-Link IE Field Diagnostics of the engineering tool

1.6 Analog Output Test Function When the CPU Module is in STOP Status

This function allows performing the analog output test when the CPU module is in the STOP status.

The following functions are enabled during the analog output test.

- Scaling function (Page 27 Scaling Function)
- Shift function (Page 30 Shift Function)
- Alert output function (Page 32 Alert Output Function)

When a digital value that is out of the setting range is written, a digital value setting range error (error code: 191□H) occurs and the corresponding check code is stored in 'CH1 Set value check code' (Un\G400).

Operation

By forcibly turning on 'CH1 Output enable/disable flag' (Y1) when the CPU module is in the STOP state, the analog output value is changed from the offset value to the D/A-converted analog output value. Hereafter, when 'CH1 Digital value' (Un\G460) is updated, the analog output value is updated as well.

The following figure shows the relation between 'CH1 Output enable/disable flag' (Y1) and the analog output value of the CPU module in the STOP state when the analog output HOLD/CLEAR setting is set to CLEAR (0).

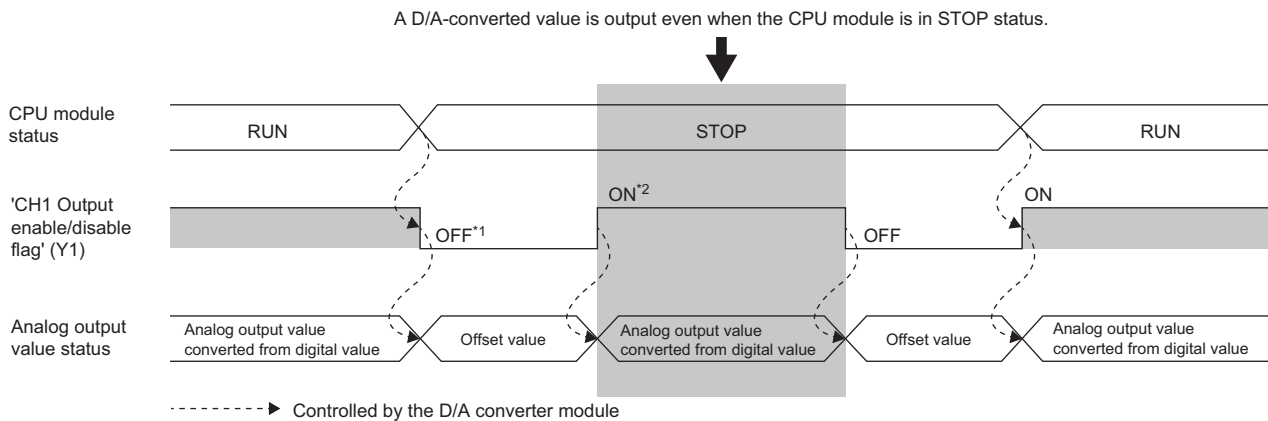

*1 'CH1 Output enable/disable flag' (Y1) turns off when the status of the CPU module is changed into STOP.

*2 By forcibly turning on 'CH1 Output enable/disable flag' (Y1), the analog output value is changed from the offset value to the D/A-converted analog output value.

Setting procedure

To perform an analog output test, configure the settings in the device test of the engineering tool following the procedure shown below.

1. Set 'CH1 D/A conversion enable/disable setting' (Un\G500) of the buffer memory to D/A conversion enabled (0).
2. Turn on 'Operating condition setting request' (Y9).
3. Check that 'Operating condition setting completed flag' (X9) turns off, and turn off 'Operating condition setting request' (Y9).
4. Set the digital value equivalent to the analog value to be output for 'CH1 Digital value' (Un\G460) in the buffer memory.
5. Turn on 'CH1 Output enable/disable flag' (Y1).

1.7 Scaling Function

This function performs the scale conversion on digital values within a specified range between a scaling upper limit value and a scaling lower limit value. This function helps reduce the time taken for creating a scale conversion program.

Operation

The scale conversion is performed for the set 'CH1 Digital value' (Un\G460) using 'CH1 Scaling upper limit value' (Un\G504) and 'CH1 Scaling lower limit value' (Un\G506), and the value after the scale conversion is used for the D/A conversion. (In the scale conversion, values after the decimal point are rounded off.)

Concept of scaling setting

The necessary settings for the scaling lower limit value and scaling upper limit value depend on whether the factory default setting or the user range setting is used for the analog output range.

■When the factory default setting is used for the analog output range

- For the scaling upper limit value, set a value corresponding to the upper limit value of the set analog output value.
- For the scaling lower limit value, set a value corresponding to the lower limit value of the set analog output value.

■When the user range setting is used for the analog output range

- Set a value corresponding to the gain value for the scaling upper limit value.
- Set a value corresponding to the offset value for the scaling lower limit value.

Calculating the scaling value

For D/A conversion, the scaling value is calculated based on the following calculation formulas.

■When the factory default setting is used for the output range

- When the voltage is 1 to 5V, 0 to 5V, or 1 to 5V (extended mode) or the current is 4 to 20mA, 0 to 20mA, or 4 to 20mA (extended mode)

$$\text{Digital value used for D/A conversion} = \frac{32000}{S_H - S_L} \times (D_X - S_L)$$

- When the voltage is -10 to 10V or -12 to 12V

$$\text{Digital value used for D/A conversion} = \frac{64000}{S_H - S_L} \times (D_X - S_L) - 32000$$

■When the user range setting is used for the output range

$$\text{Digital value used for D/A conversion} = \frac{32000}{S_H - S_L} \times (D_X - S_L)$$

Item	Description
D _X	Digital value
S _H	Scaling upper limit value
S _L	Scaling lower limit value

Point

- If the relation between the values is the scaling lower limit value > the scaling upper limit value, the scale conversion can be performed according to a negative slope.
- Set the scaling with the condition "Scaling upper limit value ≠ Scaling lower limit value".

Setting procedure

1. Set "D/A conversion enable/disable setting" to "D/A conversion enable".
 [Navigation window] ⇒ [Parameter] ⇒ [Module Information] ⇒ Module model name ⇒ [Basic setting] ⇒ [D/A conversion enable/disable function]
2. Set "Scaling enable/disable setting" to "Enable".
 [Navigation window] ⇒ [Parameter] ⇒ [Module Information] ⇒ Module model name ⇒ [Application setting] ⇒ [Scaling function]
3. Set values for "Scaling upper limit value" and "Scaling lower limit value".

Item	Setting range
Scaling upper limit value	-32000 to 32000
Scaling lower limit value	

Setting example of scaling

Ex.

When 14000 is set to the scaling upper limit value and 4000 is set to the scaling lower limit value for the channel with the output range of 0 to 5V

Analog output voltage (V)

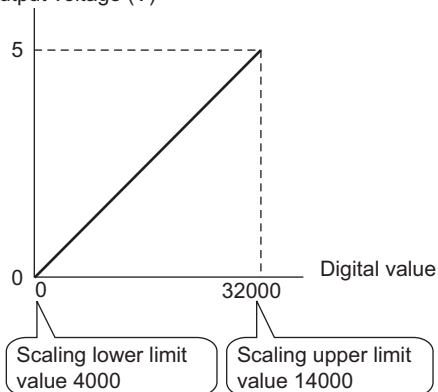

Digital value	Digital value after scaling	Output voltage (V)
4000	0	0
6000	6400	1
8000	12800	2
10000	19200	3
12000	25600	4
14000	32000	5

Outputting the analog values corresponding to the extended part of the output range

When the digital values in the extended part of the extended mode of the output range (the digital values in the range of 32768 to 36767 that correspond to the analog value higher than 20mA or 5V) are scaled to the 16-bit data range while the scaling function is enabled, the analog values corresponding to the extended part can be output.

Ex.

When 24000 is set to the scaling upper limit value and 0 is set to the scaling lower limit value for the channel with the output range of 1 to 5V (extended mode)

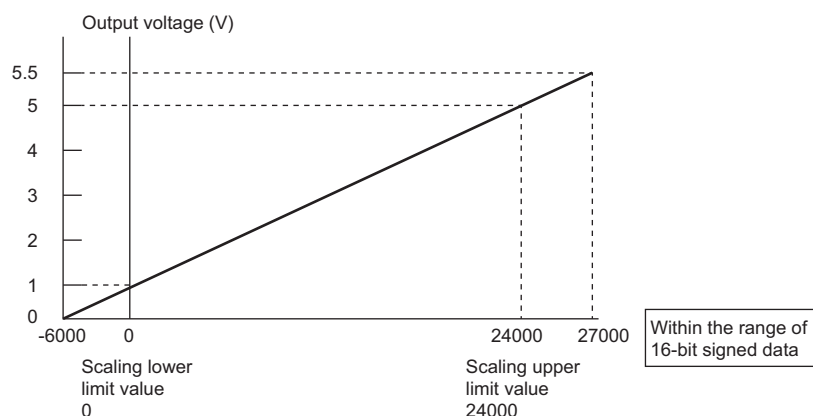

The digital value 27000 corresponds to the analog output voltage 5.5V. Thus, the analog values corresponding to the extended range can be output by setting 'CH1 Digital value' (Un\G460).

When the scaling function is used, the resolution may be reduced. To perform the D/A conversion to output the analog value while keeping the resolution, use the shift function. (☞ Page 30 Shift Function)

Precautions

- When the scaling function is used, the digital value can be set to a value out of the range between the scaling upper limit value and scaling lower limit value (in the dotted lines in the I/O conversion characteristic graph) before being scaled. However, use the scaling function within the range of the analog output practical range (in the solid line in the I/O conversion characteristic graph). If the value exceeds the analog output practical range, the maximum resolution and accuracy may not fall within the range of the performance specifications.
- The default digital value "0" may not be appropriate, depending on the scaling function setting. In particular in the examples of when the output range is 0 to 5V, an out-of-range digital value error occurs if 'CH1 Output enable/disable flag' (Y1) is turned on with the digital value "0". A digital value setting range error (error code: 191□H) occurs and 'Error flag' (XF) turns on, and the ERR LED turns on. Therefore, set an appropriate digital value within the scaling range before turning on 'CH1 Output enable/disable flag' (Y1).
- When using the user range, note that the scaling lower limit value is equal to the offset value.
- When the scaling function is enabled and the digital value after the scaling conversion is out of the digital setting range, a digital value setting range error (error code: 191□H) occurs and the corresponding check code is stored in 'CH1 Set value check code' (Un\G400).
- When the scaling function is used while the output range is set to 4 to 20mA (extended mode) or 1 to 5V (extended mode), the digital values in the extended range may exceed the range of -32768 to 32767 and the setting may be disabled.

1.8 Shift Function

This function allows adding the set input value shift amount to the digital value.

The analog output value reflects the change in the input value shift amount on a realtime basis. Therefore, fine adjustment can be easily performed when the system starts.

Operation

When the D/A conversion is performed on the digital value, the value obtained by adding 'CH1 Input value shift amount' (Un\G480) to 'CH1 Digital value' (Un\G460) is used for the D/A conversion.

When the digital value after the addition exceeds the range as the result of the shift processing, the value is fixed to the lower limit value or the upper limit value.

When a value is written to 'CH1 Input value shift amount' (Un\G480), the set value is added to the digital input value regardless of the ON/OFF state of 'Operating condition setting request' (Y9).

Setting procedure

Set a value for "Input value shift amount".

[Navigation window] ⇒ [Parameter] ⇒ [Module Information] ⇒ Module model name ⇒ [Application setting] ⇒ [Shift function]

Item	Setting range
Input value shift amount	-32768 to 32767

Setting example

Ex.

When the input value shift amount is set to +50 for the channel where the output range of 0 to 5V is set

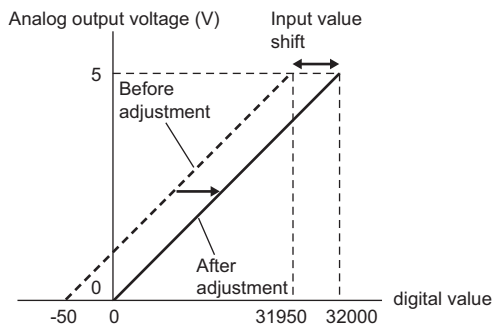

Digital value		Analog output voltage (V)
Before adjustment	After adjustment	
-50	0	0
31950	32000	5

Outputting the analog values corresponding to the extended part of the output range

By using the shift function, the analog values corresponding to the extended part of the extended mode of the output range (the digital values in the range of 32768 to 36767 that correspond to the analog value higher than 20mA or 5V) can be output. The sum of the digital value and the input value shift amount must be within the range of 32768 to 36767.

Ex.

When the output range is set to 4 to 20mA (extended mode), 'CH1 Digital value' (Un\G460) is set to 32000, and 'CH1 Input value shift amount' (Un\G480) is set to 4000

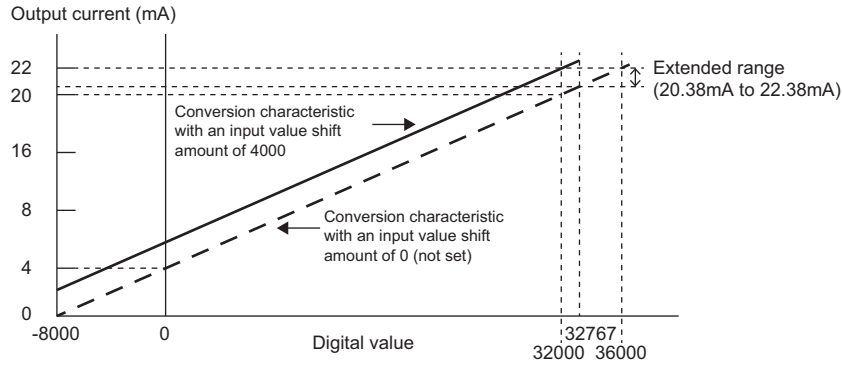

The current 22.00mA corresponding to the digital value 36000, which is the sum of 'CH1 Digital value' (Un\G460) and the input value shift amount, is output and the analog values corresponding to the extended part of the extended mode can be output.

Precautions

- Based on the digital value on which the shift-and-add is performed, the alert output function, scaling function, and rate control function are executed.
- When the value obtained by adding 'CH1 Input value shift amount' (Un\G480) to 'CH1 Digital value' (Un\G460) is out of the digital setting range, a digital value setting range error (error code: 191□H) occurs and the corresponding check code is stored in 'CH1 Set value check code' (Un\G400).

1.9 Alert Output Function

This function outputs an alert when the digital value is larger than the alert output upper limit value or is smaller than the alert output lower limit value.

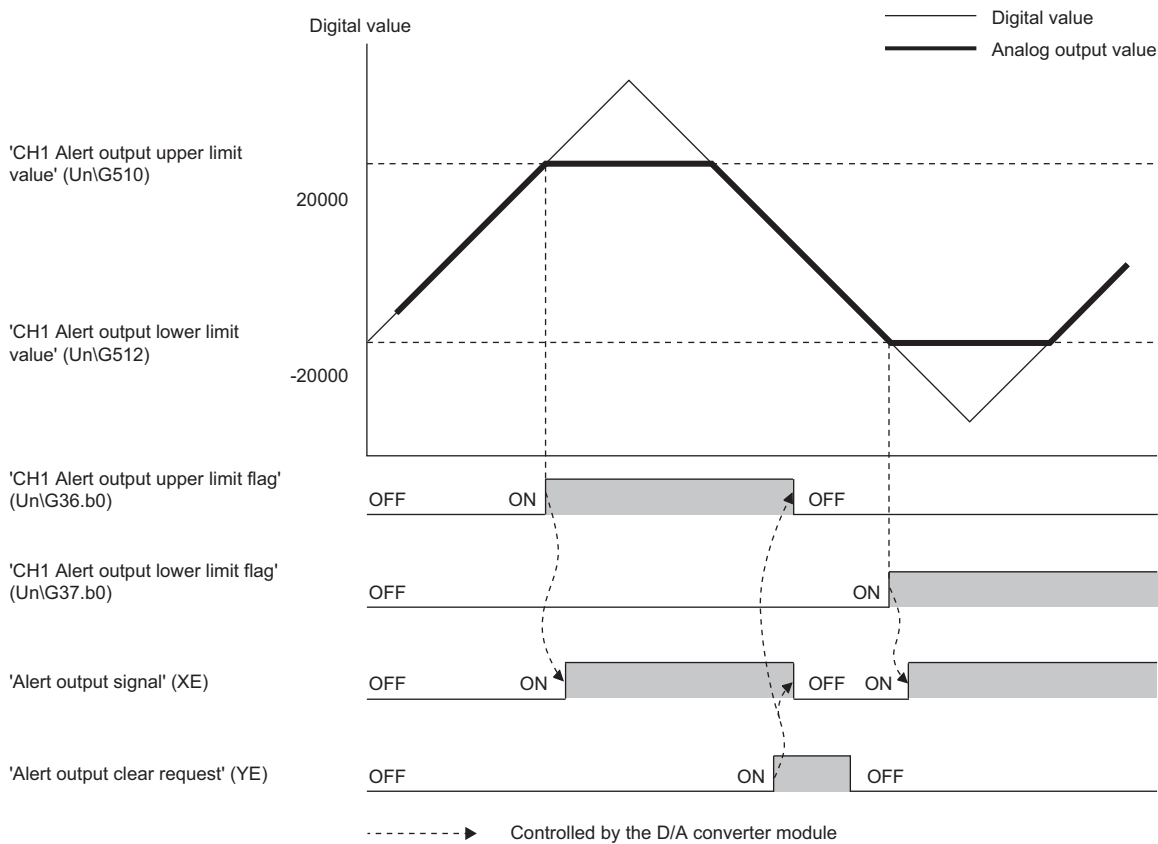

Operation

■Alert output notification

When 'CH1 Digital value' (UnG460) is larger than 'CH1 Alert output upper limit value' (UnG510) or is smaller than 'CH1 Alert output lower limit value' (UnG512), either of 'Alert output upper limit flag' (UnG36) or 'Alert output lower limit flag' (UnG37), 'Alert output signal' (XE), and the ALM LED turn on to output an alert. In addition, an alarm code (080□H or 081□H) is stored in 'Latest alarm code' (UnG2) when an alert has occurred.

When an alert has occurred, the set value of the alert output upper limit value or the alert output lower limit value is used as the digital value for the D/A conversion.

When 'CH1 Digital value' (UnG460) is changed to a value in 'CH1 Alert output upper limit value' (UnG510) or smaller or a value in 'CH1 Alert output lower limit value' (UnG512) or larger after an alert has occurred, the analog output value returns to a normal value. However, 'Alert output upper limit flag' (UnG36), 'Alert output lower limit flag' (UnG37), and 'Alert output signal' (XE) are not cleared.

Clearing an alert

The alert output can be cleared in the following two methods:

After 'CH1 Digital value' (Un\G460) is set to be smaller than 'CH1 Alert output upper limit value' (Un\G510) and larger than 'CH1 Alert output lower limit value' (Un\G512)

- Turning on and off 'Alert output clear request' (YE)
- Turning on and off 'Operating condition setting request' (Y9)

The D/A converter module arranges the following status when an alert output is cleared.

- Clearing 'Alert output upper limit flag' (Un\G36) and 'Alert output lower limit flag' (Un\G37)
- Turning off 'Alert output signal' (XE)
- Turning off the ALM LED
- Clearing the alarm code stored in 'Latest alarm code' (Un\G2)

Setting procedure

1. Set "Warning output function" to "enable".

 [Navigation window] ⇒ [Parameter] ⇒ [Module Information] ⇒ Module model name ⇒ [Application setting] ⇒ [Warning output function]

2. Set values for "Warning output upper limit value" and "Warning output lower limit value".

Item	Setting range
Alert output upper limit value	-32768 to 32767
Alert output lower limit value	

Point

Set the values that satisfy the condition "alert output upper limit value > alert output lower limit value".
When a value out of the range is set, an alert output upper lower limit value inversion error (error code: 1B1□H) occurs.

Precautions

When the shift function is used, 'CH1 Digital value' (Un\G460) on which the shift-and-add is performed is the alert detection target. Set the alert output upper/lower limit values in consideration of the shift-and-add.

1.10 Rate Control Function

This function allows prevents the sudden change of the analog output value by limiting the increment/decrement of the analog output value per 1ms.

Operation

When the change amount of 'CH1 Digital value' (Un\G460) is larger than the value set in 'CH1 Increase digital limit value' (Un\G514) or 'CH1 Decrease digital limit value' (Un\G516), this function changes 'CH1 Digital value' (Un\G460) by the limit values set for each digital limit value.

The increment/decrement values per 1ms are set for 'CH1 Increase digital limit value' (Un\G514) and 'CH1 Decrease digital limit value' (Un\G516). However, the actual update cycle of the output value of the corresponding channel is (1ms × Number of conversion enabled channels).

Therefore, the analog output value increases or decreases per update cycle as follows:

First time: The D/A conversion value of the increase/decrease digital limit value

Second time or later: The D/A conversion value of (Increase/decrease digital limit value × Number of conversion-enabled channels)

Setting procedure

1. Set "Rate control enable/disable setting" to "Enable".

 [Navigation window] ⇒ [Parameter] ⇒ [Module Information] ⇒ Module model name ⇒ [Application setting] ⇒ [Rate control function]

2. Set values for "Increase digital limit value" and "Decrease digital limit value".

Item	Setting range
Increase digital limit value	0 to 64000
Decrease digital limit value	

Precautions

- The setting of the shift function is enabled during the rate control.
- When the alert output function is enabled, the alert determination is performed to the set 'CH1 Digital value' (Un\G460). Note that an alert does not occur at the timing when the digital value changed by the rate control function exceeds the upper/lower limit value.
- The rate control does not function during the analog output test for when the CPU module is in the STOP state.
- With Analog output HOLD/CLEAR setting set to a value other than HOLD, the analog output value changes when the CPU module is in the STOP state but the rate control function does not function.
- When the CPU module status changes while the D/A conversion and D/A output are enabled and the analog output HOLD/CLEAR setting is set to CLEAR, the rate control function operates as follows:
When the CPU module status changes from RUN to STOP (error), the rate control does not function. When the CPU module status changes from STOP (error) to RUN, the rate control functions.

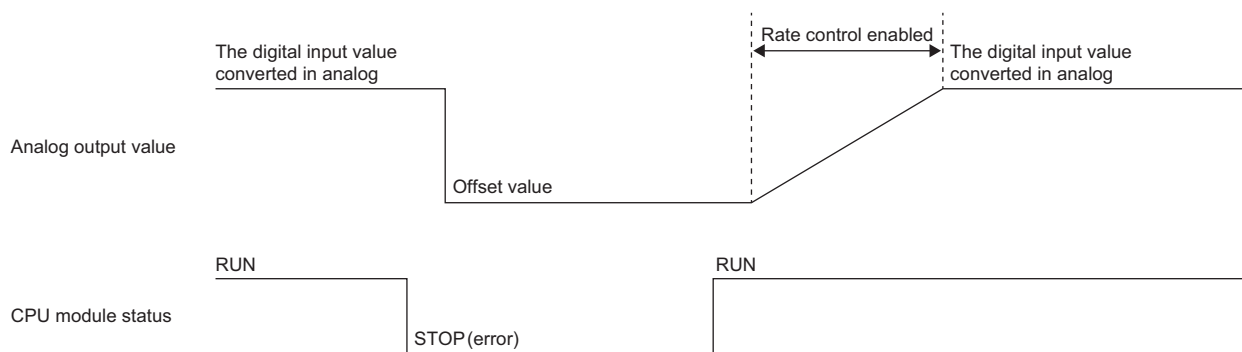

- While the rate control is enabled, the analog output is restarted from the offset value when the CPU module status is changed from STOP (error) to RUN with the D/A conversion enabled, the D/A output enabled, and the analog output set to HOLD.

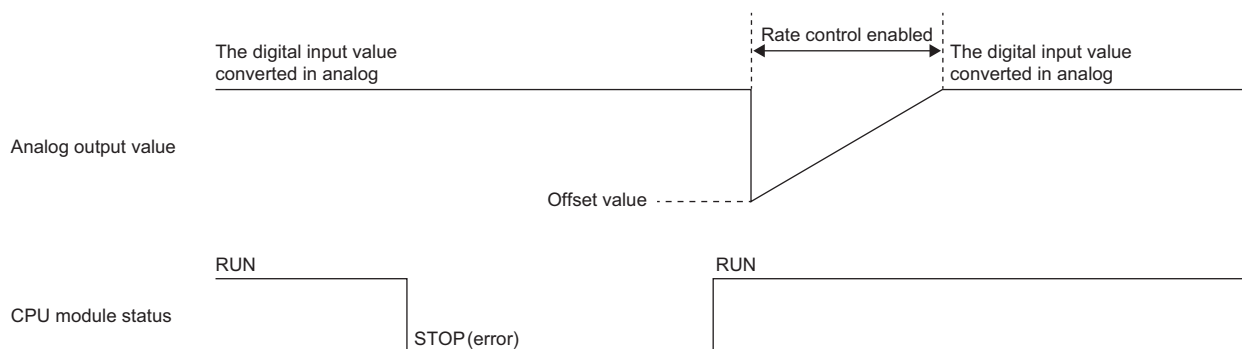

- When the D/A conversion is enabled and the D/A output is disabled, the rate control does not function.
- When a value out of the setting range is written to 'CH1 Digital value' (Un\G460) during the rate control, the rate control is performed with the upper or lower limit value of the setting range. In addition, the check result is stored in 'CH1 Setting value check code' (Un\G400).
- When the external power supply is turned off during the rate control, the rate control does not function and the analog output value changes to 0V/0mA. When the external power supply is recovered, the rate control is restarted from the offset value.

1.11 External Power Supply Disconnection Detection Function

Point

X signals used in this function differ between CH1 to CH8 (used for the R60DA8-G and the R60DA16-G) and CH9 to CH16 (used only for the R60DA16-G).

- CH1 to CH8: 'External power supply READY flag (CH1 to CH8)' (X7)
- CH9 to CH16: 'External power supply READY flag (CH9 to CH16)' (X17)

This section describes examples for CH1 to CH8. When using CH9 to CH16, regard X7 as X17.

This function detects that the external power supply 24VDC is not supplied or the supply stops.

When the external power supply disconnection is detected, 'External power supply READY flag (CH1 to CH8)' (X7) turns off, and the analog output value becomes 0V/0mA regardless of the other settings.

Operation

When the external power supply is not input or when 200ms has not yet elapsed after the power supply is input, the power supply is regarded as disconnected and 'External power supply READY flag (CH1 to CH8)' (X7) turns off.

When the external power supply input stops, the external power supply is regarded as disconnected and 'External power supply READY flag (CH1 to CH8)' (X7) turns off.

Point

Two external power supplies are provided for the R60DA16-G. One is for CH1 to CH8 and the other is for CH9 to CH16. The status of each external power supply (the power is being supplied or not) is indicated by 'External power supply READY flag (CH1 to CH8)' (X7) and 'External power supply READY flag (CH9 to CH16)' (X17).

Even when only one of the two external power supplies is on, the D/A conversion is performed in the channels of the group where the external power is being supplied (CH1 to CH8 or CH9 to CH16) without changing the conversion cycle.

Precautions

When the external power supply does not satisfy the requirements of the performance specifications, the external power supply is regarded as disconnected.

For the performance specifications of the external power supply, refer to the following.

 MELSEC iQ-R Channel Isolated Digital-Analog Converter Module User's Manual (Startup)

1.12 Disconnection Detection Function

This function allows detecting the disconnection by monitoring the analog output value. A disconnection can be detected for each channel.

The disconnection detection function can be used with the following analog output ranges.

- 4 to 20mA
- 4 to 20mA (extended mode)

Disconnection detection

When the analog output range is 4 to 20mA or 4 to 20mA (extended mode), the disconnection detection can be set to be enabled for channels where 'CH1 D/A conversion enable/disable setting' is set to D/A conversion enabled.

■Enabling the disconnection detection

- When the analog output range is 4 to 20mA

To perform the disconnection detection, set 'CH1 Disconnection detection enable/disable setting' (Un\G558) to Enable (0).

- When the analog output range is 4 to 20mA (extended mode)

To perform the disconnection detection, set 'CH1 Disconnection detection (extended mode) enable/disable setting' (Un\G559) to Enable (1).

Point

When the analog output range is 4 to 20mA (extended mode) and analog output is lower than 1mA, a disconnection cannot be detected even if the disconnection detection is enabled.

■ Setting a disconnection check monitoring time

A time taken for the module to determine a disconnection state (disconnection check monitoring time for channel 1^{*1}) can be set by using 'CH1 Number of disconnection checks' (Un\G560).

By setting 'CH1 Number of disconnection checks' (Un\G560), whether a disconnection has occurred or not can be properly checked according to performance of external devices connected.

Ex.

The following figure shows the disconnection detection operation when buffer memory areas are set as follows:

- 'CH1 D/A conversion enable/disable setting' (Un\G500): D/A conversion enabled (0)
- 'CH1 Range setting' (Un\G598): 4 to 20mA
- 'CH1 Disconnection detection enable/disable setting' (Un\G558): Enable (0)
- 'CH1 Number of disconnection checks' (Un\G560): 100

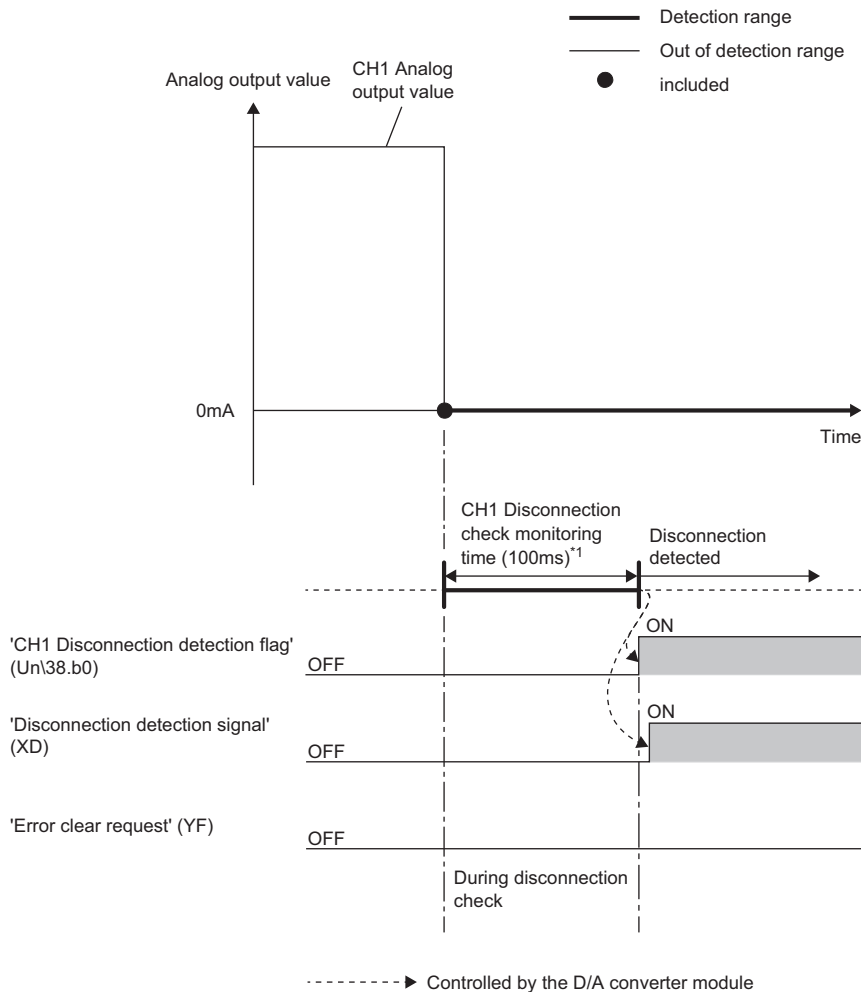

*1 CH1 Disconnection check monitoring time is calculated with the following formula.

CH1 Disconnection check monitoring time = 'CH1 Number of disconnection checks' (Un\G560) × (Number of conversion enabled channels × Conversion speed (1ms/CH))

When 'CH1 Number of disconnection checks' (Un\G560) is set to 100 and the number of conversion enabled channels is 1, CH1 Disconnection check monitoring time becomes 100ms.

Point

When a cause of disconnection is eliminated before the disconnection check monitoring time for channel 1 elapses, a disconnection is not detected. If a disconnection has occurred again and persists until the disconnection check monitoring time for channel 1 elapses, a disconnection is detected.

Operations performed when a disconnection is detected

When a disconnection is detected, it is notified by following operations.

- A value of 1 is stored in the corresponding bit of 'Disconnection detection flag' (Un\G38).
- 'Disconnection detection signal' (XD) turns on.
- The ERR LED turns on.
- An error code (1C4□H) is stored in 'Latest error code' (Un\G0).

The analog output becomes as follows depending on the setting of 'CH1 Disconnection detection auto-clear enable/disable setting' (Un\G561).

- When 'CH1 Disconnection detection auto-clear enable/disable setting' (Un\G561) is Disable (0), the analog output for channel 1 becomes 0mA.
- When 'CH1 Disconnection detection auto-clear enable/disable setting' (Un\G561) is Enable (1), the analog output continues according to the status of 'CH1 Output enable/disable flag' (Y1).

Operations performed when the module recovers from the disconnection

Operations performed after a cause of disconnection is eliminated vary depending on the setting of 'CH1 Disconnection detection auto-clear enable/disable setting' (Un\G561).

■When 'CH1 Disconnection detection auto-clear enable/disable setting' (Un\G561) is Disable (0)

Even if the disconnection cause is eliminated, the analog output for channel 1 does not restart automatically to prevent an incorrect output.

To restart the analog output for channel 1, check 'CH1 Digital value' (Un\G460) and turn on and off 'Error clear request' (YF).

According to the status of 'CH1 Output enable/disable flag' (Y1), the analog output for channel 1 restarts.

When the analog output for channel 1 restarts, the corresponding bit of 'Disconnection detection flag' (Un\G38) is cleared.

When the analog output for all channels restarts, operations are performed as follows.

- 'Disconnection detection signal' (XD) turns off.
- The ERR LED turns off.

Ex.

The following figure shows the operation when buffer memory areas for channel 1 are set as follows:

- 'CH1 D/A conversion enable/disable setting' (Un\G500): D/A conversion enabled (0)
- 'CH1 Range setting' (Un\G598): 4 to 20mA
- 'CH1 Disconnection detection enable/disable setting' (Un\G558): Enable (0)
- 'CH1 Disconnection detection auto-clear enable/disable setting' (Un\G561): Disable (0)

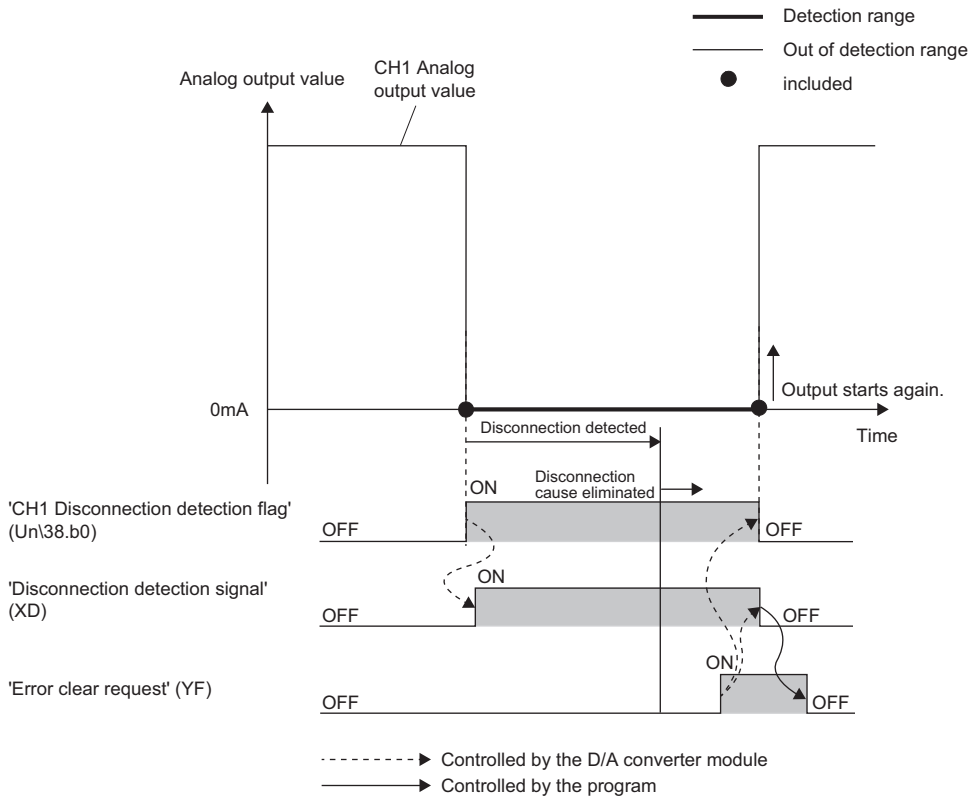

■When 'CH1 Disconnection detection auto-clear enable/disable setting' (Un\G561) is Enable (1)

After a cause of disconnection is eliminated and continuity is restored, if no disconnection has occurred until the disconnection detection auto-clear check monitoring time for channel 1*¹ elapses, the D/A converter module automatically performs the following operations.

- 'Disconnection detection signal' (XD) turns off.
- The ERR LED turns off.

Ex.

The following figure shows the operation when buffer memory areas for channel 1 are set as follows:

- 'CH1 D/A conversion enable/disable setting' (Un\G500): D/A conversion enabled (0)
- 'CH1 Range setting' (Un\G598): 4 to 20mA
- 'CH1 Disconnection detection enable/disable setting' (Un\G558): Enable (0)
- 'CH1 Disconnection detection auto-clear enable/disable setting' (Un\G561): Enable (1)
- 'CH1 Number of disconnection detection auto-clear checks' (Un\G562): 100

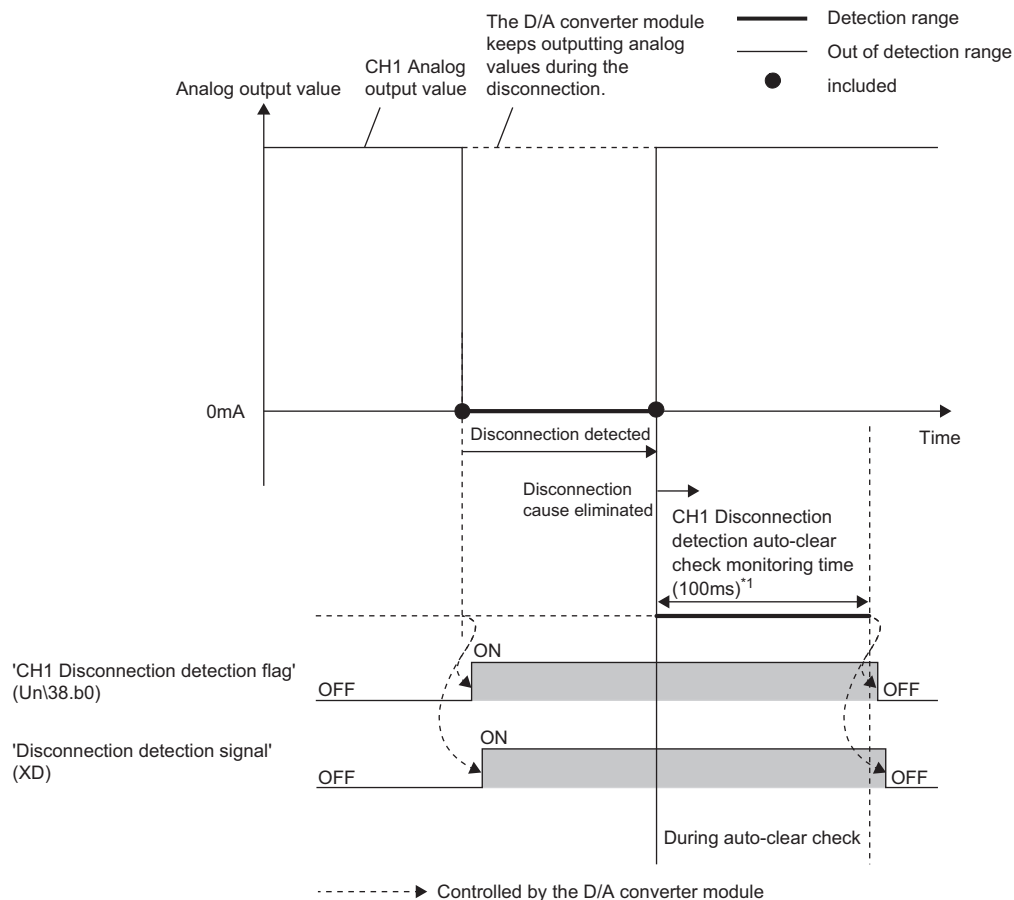

*¹ CH1 Disconnection detection auto-clear check monitoring time (time taken until the disconnection detection for channel 1 is automatically cleared) is calculated with the following formula.

$$\text{CH1 Disconnection detection auto-clear check monitoring time} = \text{'CH1 Number of disconnection detection auto-clear checks' (Un\G562)} \times (\text{Number of D/A conversion enabled channels} \times \text{Conversion speed (1ms/CH)})$$

- If the analog output is set to lower than 1mA after the disconnection detection, 'Disconnection detection flag' (Un\G38) is not automatically cleared. To clear 'Disconnection detection flag' (Un\G38) automatically, set the analog output to be 1mA or higher.
- If a disconnection has been detected before the disconnection detection auto-clear check monitoring time for channel 1 elapses, automatic operation of clearing 'Disconnection detection flag' (Un\G38) is canceled. After the disconnection cause is eliminated and continuity is restored, if no disconnection has occurred until the disconnection detection auto-clear check monitoring time for channel 1 elapses, the corresponding bit of 'Disconnection detection flag' (Un\G38) is cleared.
- Although 'Disconnection detection flag' (Un\G38) is automatically cleared, an error code stored in 'Latest error code' (Un\G0) is not automatically cleared. To clear 'Latest error code' (Un\G0), check that 'Disconnection detection flag' (Un\G38) returns to Normal (0) for all bits, and then turn on and off 'Error clear request' (YF).

Setting procedure

1. Set "CH1 Output range setting" to "4 to 20mA" or "4 to 20mA (Extension)".

 [Navigation window] ⇒ [Parameter] ⇒ [Module Information] ⇒ Module model name ⇒ [Basic setting] ⇒ [Range switching function]

2. When "4 to 20mA" is set, set "Disconnection detection enable/disable setting" to "Enable". When "4 to 20mA (Extension)" is set, set "Disconnection detection (extended mode) enable/disable setting" to "Enable".

 [Navigation window] ⇒ [Parameter] ⇒ [Module Information] ⇒ Module model name ⇒ [Application setting] ⇒ [Disconnection detection function]

3. Set a value for "CH1 Disconnection detection check count".

Item	Setting range
CH1 Disconnection detection check count	1 to 100

4. Set "CH1 Disconnection detection auto-clear enable/disable setting" to "Enable" or "Disable".

5. When "CH1 Disconnection detection auto-clear enable/disable setting" is set to "Enable", set a value for "CH1 Disconnection detection auto-clear check count".

Item	Setting range
CH1 Disconnection detection auto-clear check count	1 to 1000

Precautions

- When 'CH1 Disconnection detection auto-clear enable/disable setting' (Un\G561) is Enable (1), the analog output continues according to the status of 'CH1 Output enable/disable flag' (Y1), even in disconnection state. Before using the auto-clear function of disconnection detection, please read "Wiring Precautions" in SAFETY PRECAUTIONS carefully.

1.13 Interrupt Function

The D/A converter module executes the interrupt program of the CPU module when an interrupt factor such as a disconnection or alert output is detected.

For the D/A converter module, the maximum number of interrupt pointers available is 16 per module.

Operation

■Detecting an interrupt factor

When an interrupt factor occurs, an interrupt request is sent to the CPU module at the same time as 'Interrupt factor detection flag [n]' (Un\G4 to Un\G19) is turned to Interrupt factor (1).

■How to reset an interrupt factor

When Reset request (1) is set to 'Interrupt factor reset request [n]' (Un\G156 to Un\G171) corresponding to the interrupt factor, the specified interrupt factor is reset and 'Interrupt factor detection flag [n]' (Un\G4 to Un\G19) changes to No interrupt factor (0).

Setting procedure

To use the interrupt function, set "Condition target setting", "Condition target channel setting", "Interrupt factor transaction setting", and "Interrupt pointer" with the engineering tool. After completing the settings, write the project to enable the settings.

 [Navigation window] ⇨ [Parameter] ⇨ [Module Information] ⇨ Module model name ⇨ [Interrupt setting]

The following table shows the setting items on the interrupt setting window.

Item	Description
Condition target setting	Select a factor of the target for the interrupt detection.
Condition target channel setting	Select a target channel when the condition target setting for the interrupt detection is channel specification.
Interrupt factor transaction setting	Set an interrupt request for when the same interrupt factor occurs during the interrupt factor detection.
Interrupt pointer	Specify the number of an interrupt pointer that is initiated at the detection of an interrupt factor.

■Condition target setting

Select a factor of the condition target setting for the interrupt detection.

For details on the factors to be detected, refer to the following.

 Page 110 Condition target setting [n]

■Condition target channel setting

Select a target channel when the condition target setting for the interrupt detection is channel specification.

For details on the setting, refer to the following.

 Page 111 Condition target channel setting [n]

■Interrupt factor transaction setting

Set an interrupt request for when the same interrupt factor occurs during the interrupt factor detection.

- When Interrupt resend request (0) is set and the same interrupt factor occurs during the interrupt factor detection, an interrupt request is sent to the CPU module again.
- When No interrupt resend request (1) is set and the same interrupt factor occurs during the interrupt factor detection, an interrupt request is not sent to the CPU module.

■Interrupt pointer

Specify the number of an interrupt pointer that is initiated at the detection of an interrupt factor. For details on the interrupt pointers, refer to the following.

 MELSEC iQ-R CPU Module User's Manual (Application)

-
- If 'Condition target setting [n]' (Un\G232 to Un\G247) is Disable (0), an interrupt request is not sent to the CPU module.
 - To reset the interrupt factor, set Reset request (1) until 'Interrupt factor detection flag [n]' (Un\G4 to Un\G19) changes to No interrupt factor (0).
 - Resetting interrupt factors is executed only when 'Interrupt factor reset request [n]' (Un\G156 to Un\G171) changes from No reset request (0) to Reset request (1).
 - Multiple interrupt pointers can also share the same setting of 'Condition target setting [n]' (Un\G232 to Un\G247). When interrupts with the same settings occur in 'Condition target setting [n]' (Un\G232 to Un\G247), the interrupt program is executed in order of the priority of the interrupt pointers. For the priority of the interrupt pointers, refer to the following.

 MELSEC iQ-R CPU Module User's Manual (Application)

- When All channels (0) is set for 'Condition target channel setting [n]' (Un\G264 to Un\G279) and an interrupt detection target for each channel is set to 'Condition target setting [n]' (Un\G232 to Un\G247), the interrupt requests that have the same interrupt factor are sent to the CPU module if alerts are issued in multiple channels. In this case, the CPU module executes multiple interrupt programs and judges that the program cannot be normally finished due to the scan monitoring function, and a CPU module error may occur. When a CPU error occurs, refer to the following.

 MELSEC iQ-R CPU Module User's Manual (Application)

Setting example

Ex.

When the interrupt program (I50) is executed at the disconnection detection in any channel

- Parameter setting

Set "Interrupt setting" of the module parameter as follows.

No.	Condition target setting	Condition target channel setting	Interrupt pointer
1	Disconnection detection flag	All channels	I50

- Label settings

Classification	Label name	Description	Device										
Module Label	RCPU.stSM.bAlways_ON	Always ON	SM400										
	RCPU.stSM.bAfter_RUN1_Scan_ON	ON for one scan after RUN	SM402										
	R60DAG_1.unInterruptFactorMask_D[0]	Interrupt factor mask [1]	U0\G124.0										
	R60DAG_1.unInterruptFactorResetRequest_D[0]	Interrupt factor reset request [1]	U0\G156.0										
Labels to be defined	Define global labels as shown below:												
	<table border="1"> <thead> <tr> <th></th> <th>Label Name</th> <th>Data Type</th> <th>Class</th> <th>Assign (Device/Label)</th> </tr> </thead> <tbody> <tr> <td>1</td> <td>G_bDisconnectDetection</td> <td>Bit</td> <td>VAR_GLOBAL</td> <td>F0</td> </tr> </tbody> </table>				Label Name	Data Type	Class	Assign (Device/Label)	1	G_bDisconnectDetection	Bit	VAR_GLOBAL	F0
	Label Name	Data Type	Class	Assign (Device/Label)									
1	G_bDisconnectDetection	Bit	VAR_GLOBAL	F0									

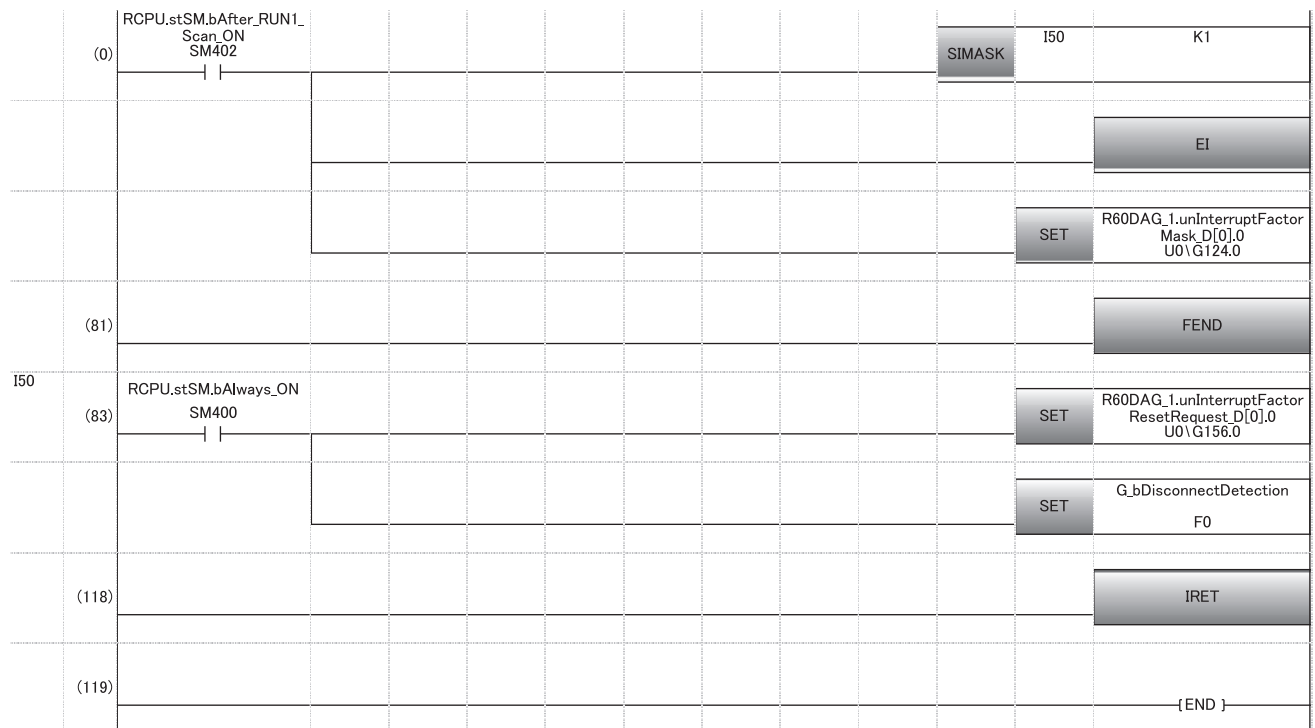

(0) Enable only the interrupt pointer I50. Enable the interruption. Clear Interrupt factor mask [1].

(83) Turn on Interrupt factor reset request [1]. Perform the processing of when a disconnection is detected.

1.14 Error History Function

This function records errors and alarms that occurred in the D/A converter module to store them into the buffer memory area. Up to 16 errors and alarms are stored.

Operation

When an error occurs, the error code and the error time are stored from 'Error history 1' (Un\G3600 to Un\G3609) in order. When an alarm occurs, the alarm code and the alarm code time are stored from 'Alarm history 1' (Un\G3760 to Un\G3769) in order.

- Detail of the error code assignment

	b15	to	b8	b7	to	b0
Un\G3600	Error code					
Un\G3601	First two digits of the year			Last two digits of the year		
Un\G3602	Month			Day		
Un\G3603	Hour			Minute		
Un\G3604	Second			Day of the week		
Un\G3605	Millisecond (Upper)			Millisecond (Lower)		
Un\G3606	System area					
to						
Un\G3609						

- Detail of the alarm code assignment

	b15	to	b8	b7	to	b0
Un\G3760	Alarm code					
Un\G3761	First two digits of the year			Last two digits of the year		
Un\G3762	Month			Day		
Un\G3763	Hour			Minute		
Un\G3764	Second			Day of the week		
Un\G3765	Millisecond (Upper)			Millisecond (Lower)		
Un\G3766	System area					
to						
Un\G3769						

Ex.

Storing example of error history and alarm history

Item	Storage contents	Storage example*1
First two digits of the year/Last two digits of the year	Stored in BCD code.	2015H
Month/Day		131H
Hour/Minute		1234H
Second		56H
Day of the week	One of the following values is stored in BCD code. Sunday: 0, Monday: 1, Tuesday: 2, Wednesday: 3 Thursday: 4, Friday: 5, Saturday: 6	6H
Millisecond (upper)	Stored in BCD code.	7H
Millisecond (lower)		89H

*1 Values stored when an error occurs at 12:34:56.789 on Saturday, January 31st, 2015.

The start address of Error history where the latest error is stored can be checked in 'Latest address of error history' (Un\G1).

The start address of Alarm history where the latest alarm is stored can be checked in 'Latest address of alarm history' (Un\G3).

Ex.

When the third error occurs:

The third error is stored in Error history 3, and the value 3620 (start address of Error history 3) is stored to 'Latest address of error history' (Un\G1).

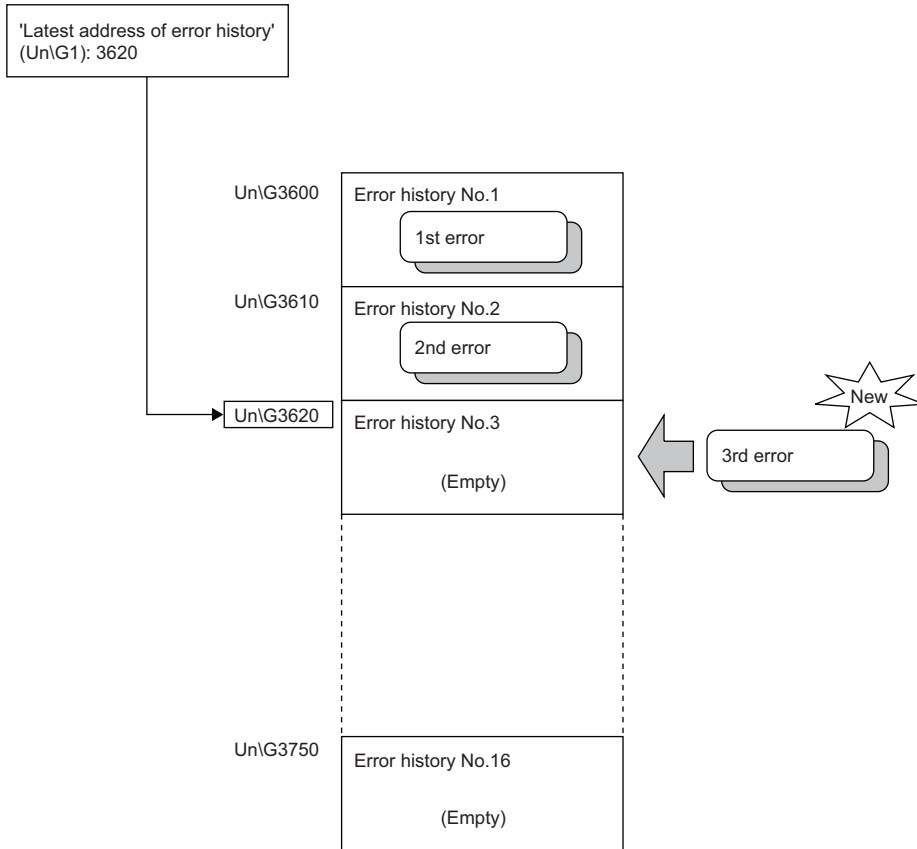

Ex.

When the 17th error occurs:

The 17th error is stored in Error history 1, and the value 3600 (start address of Error history 1) is stored to 'Latest address of error history' (Un\G1).

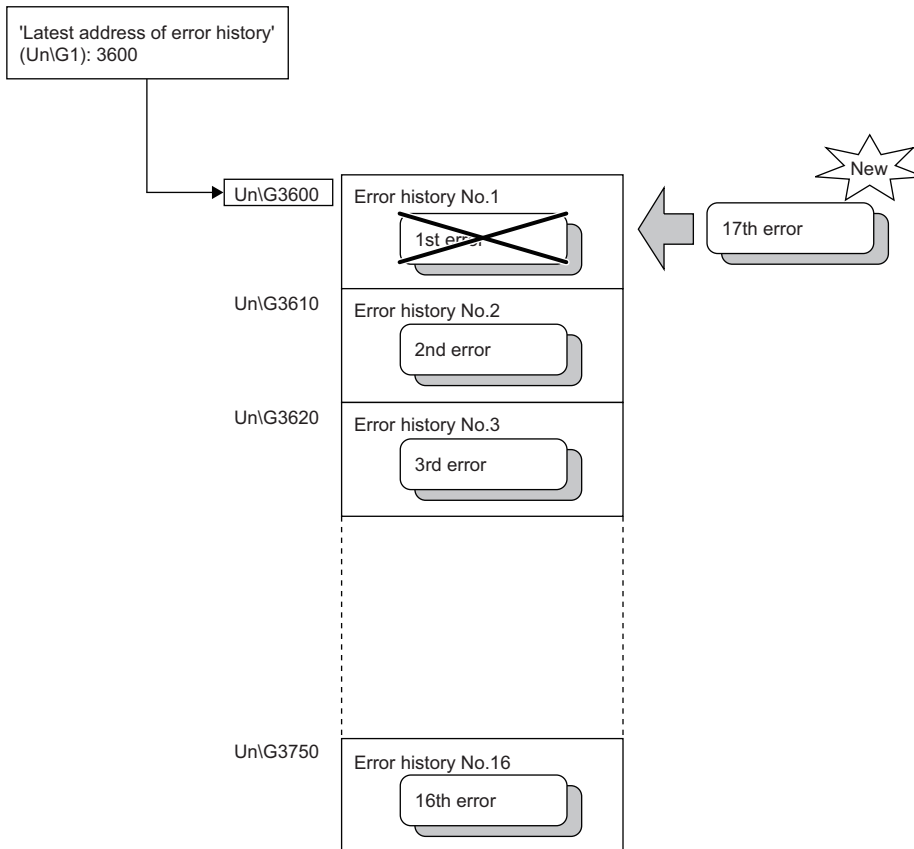
**Point**

- Once the error history storage area becomes full, subsequent error information will overwrite the existing data, starting from 'Error history 1' (Un\G3600 to Un\G3609), and continues sequentially thereafter. The overwritten history is deleted.
- The same processing is performed for Alarm history when an alarm occurs.
- The stored error history is cleared when the D/A converter module is powered off, or when the CPU module is reset.

1.15 Event History Function

This function collects generated errors, alarms, or executed operations in the D/A converter module as event information in the CPU module.

The CPU module collects the event information occurred in the D/A converter module and keeps them in the data memory inside of the CPU module or an SD memory card.

The event information collected by the CPU module can be displayed on an engineering tool to check the occurrence history in a time series.

Event type	Classification	Description
System	Error	An error detected by the self diagnostics in each module.
	Warning	A warning (alarm) detected in each module.
	Information	The operation by the normal detection of the system that is not classified as Error or Warning, or the operation performed automatically by the system.
Security	Warning	Operation that is judged as an unauthorized access to each module.
	Information	Operation that is hard to be judged as the success of unlocking passwords or an unauthorized access.
Operation	Warning	Deleting (data clear) operations that may change the action. (These operations are not judged as errors by the self diagnostics.)
	Information	Operations performed by users to change the system operation or configuration in the offset/gain setting.

Setting procedure

The event history function can be set from the event history setting window of the engineering tool. For the setting method, refer to the following.

 MELSEC iQ-R CPU Module User's Manual (Application)

Displaying event history

Access to the menu window of the engineering tool. For details on the operating procedure and how to view the contents, refer to the following.

 GX Works3 Operating Manual

List of event history data

The following table lists the events that occur in the D/A converter module when the event type is Operation.

Event code	Event classification	Event name	Event detail	Additional information
20010	Information	Offset/gain setting execution	In the user range setting, offset/gain values has been set.	Total number of writes
20100	Information	Error clear	The error clear request has been executed.	—

1.16 Backing up, Saving, and Restoring Offset/Gain Values

The offset/gain values of the user range setting of the D/A converter module can be backed up, saved, and restored.

- Back up: Creates a module-specific backup parameter and saves offset/gain values.
- Save: Saves the offset/gain information, registered in this module by making the offset/gain setting, in the CPU module.
- Restoration: Writes the information backed up and saved in the CPU module to this module.

In the event that the D/A converter module fails and needs to be replaced, the offset/gain values of the failed D/A converter module can be restored onto the new D/A converter module.

However, if the offset/gain values are saved and restored, the accuracy after the restoration decreases by approximately three times compared to that before the restoration. Reconfigure the offset/gain setting when required.

Only when the model where the offset/gain values are to be saved and the model where the offset/gain values are to be restored are the same, the offset/gain values can be saved and restored. Each procedure differs depending on whether a module-specific backup parameter is used or not.

When the module-specific backup parameter is used

Offset/gain values are automatically restored when the failed module is replaced with a new one using the online module change. For details on the online module change, refer to the following.

 MELSEC iQ-R Online Module Change Manual

Details of the module-specific backup parameter

A module-specific backup parameter is a file created in an SD memory card or the data memory of the control CPU. The contents of the parameter are the offset/gain value of the user range stored in the non-volatile memory of the D/A converter module.

The file name of a module-specific backup parameter is determined as follows based on the start I/O number of the D/A converter module.

UBPmmmn.BPR

- mmm indicates a value calculated by dividing the module I/O No. by 10H (3 digits in hexadecimal).
- nn indicates a consecutive number of the module-specific backup parameters for each module and fixed to 00.

Creating and updating a module-specific backup parameter

A module-specific backup parameter is created or updated when the offset/gain values stored in the non-volatile memory of the D/A converter module are updated.

Timing when backup data is created or updated	Description
When the offset/gain setting is completed with "Offset/gain setting" of the engineering tool	A module-specific backup parameter is created or updated when the offset/gain setting is completed with "Offset/gain setting" of the engineering tool.
When 'User range write request' (YA) is turned on in the offset/gain setting mode	A module-specific backup parameter is created or updated when the offset/gain values of the user range are changed in the offset/gain setting mode.
When 'User range write request' (YA) is turned on in the normal mode	When 'User range write request' (YA) is turned on in the normal mode, the offset/gain values of the user range are restored based on the settings of the buffer memory areas (Save data type, CH1 Factory default setting offset value to CH16 User range setting gain value). At this timing, module-specific backup parameters are updated.
When the G(P).OGSTOR instruction is executed in the normal mode	When the G(P).OGSTOR instruction is executed in the normal mode, the offset/gain values of the user range are restored. At this timing, module-specific backup parameters are updated.
When a new module is recognized after the online module change	When a new module is mounted and recognized after the online module change, the offset/gain values of the user range are restored. At this timing, module-specific backup parameters are updated.

When no module-specific backup parameter exists in the data memory of the control CPU and a module-specific backup parameter needs to be created with the current setting, change the mode of the D/A converter module to the offset/gain setting mode and turn on 'User range write request' (YA). A module-specific backup parameter is created with the current setting of the flash memory.

■Precautions

If the creation of a module-specific backup parameter fails because the data memory of the control CPU does not have sufficient free space or the module-specific backup parameter is being used, a module-specific backup parameter creation error (error code: 17E1H) occurs.

Reading of module-specific backup parameters

To read a module-specific backup parameter and restore offset/gain values, set "Auto restore of Offset/gain setting with the module change" of the module parameter to "Enable" in advance.

 [Navigation window] ⇒ [Parameter] ⇒ [Module Information] ⇒ Module model name ⇒ [Application setting] ⇒ [Online module change]

■Reading timing

Module-specific backup parameters are read when a new module is mounted and recognized after the online module change. When the programmable controller is powered off and the module is replaced with a new one, module-specific backup parameters are not read.

■Precautions

When the module-specific backup parameter for the target slot does not exist in an SD memory card or the data memory of the control CPU, the subsequent restoration of the offset/gain values is not performed. If the offset/gain values cannot be restored even though the module-specific backup parameter exists, a module-specific backup parameter restore error (error code: 17E0H) occurs.

Restoration of the offset/gain values of the user range

When reading module-specific backup parameters are completed with no errors, the values are converted (restored) into the offset/gain values of the user range for the new module, and stored in the non-volatile memory. At the same timing, the module-specific backup parameter in the data memory of the control CPU is updated with the setting of the new module.

Restrictions on the module-specific backup parameter

Offset/gain values cannot be backed up or restored with a module-specific backup parameter in the following cases.

- When the control CPU is not the process CPU
- When the programmable controller is powered off and the D/A converter module is replaced with a new one
- When "Auto restore of Offset/gain setting with the module change" of the module parameter is set to "Disable"

In any of the cases above, back up or restore offset/gain values by the following method.

 Page 55 When the module-specific backup parameter is not used

When the module-specific backup parameter is not used

Back up or restore offset/gain values by one of the following methods.

- Saving and restoring by dedicated instructions
- Saving and restoring by reading from and writing to the buffer memory

With the method above, offset/gain values can be restored to a new module, or the offset/gain values set in one module can be applied to the other modules in the same system.

- To restore offset/gain values onto a new replaced module:

1. Save offset/gain values.

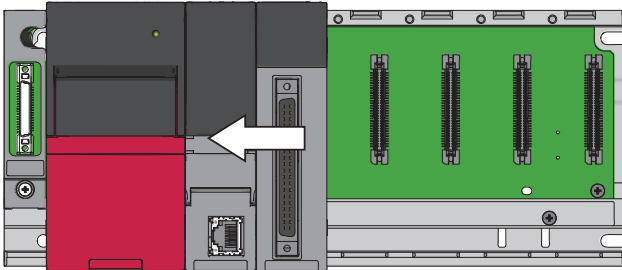

2. Power off the programmable controller and replace the D/A converter module with a new one.

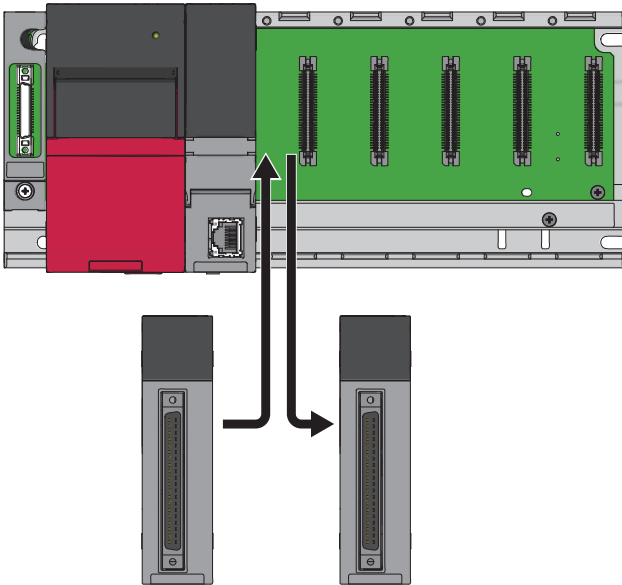

3. Restore the offset/gain values.

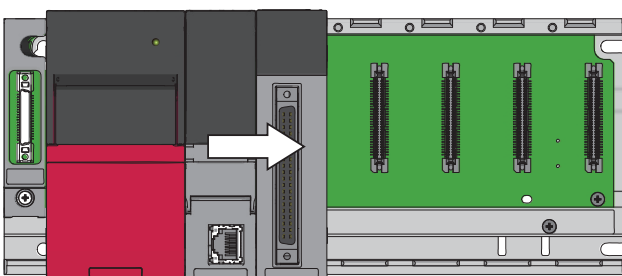

- To apply the offset/gain values set in one module to the other modules in the same system:

Ex.

When the offset/gain values in module No.1 are applied to modules No.2 to No.4

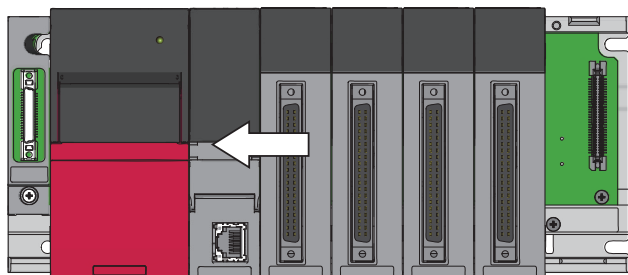

1. Save the offset/gain values in module No.1.

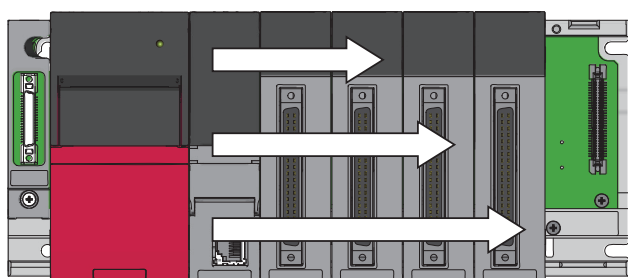

2. Apply the offset/gain values to modules No.2 to No.4

Saving and restoring by dedicated instructions

Use the dedicated instruction G(P).OGLOAD to temporarily save the offset/gain values of the source D/A converter module to the internal device of the CPU, then use G(P).OGSTOR to write the values to the destination D/A converter module. Prevent the saved offset/gain setting data from being deleted, by one of the following methods before replacing the modules:

- Use latch settings for the internal device of the destination module.
- Save the data onto an SD memory card. (To write data: use the SP.FWRITE instruction. To read data: use the SP.FREAD instruction.)
- Store the saved data.

For use of dedicated instructions, refer to the following.

 MELSEC iQ-R Programming Manual (Module Dedicated Instructions)

Saving and restoring by reading from and writing to the buffer memory

Use Save data type setting, CH1 Factory default setting offset value to CH16 User range setting gain value, and 'User range write request' (YA) to read the offset/gain values from the source D/A converter module. Use the buffer memory again to write the values to the destination D/A converter module.

The following describes the procedure for using the buffer memory.

■To restore offset/gain values onto a new replaced module:

- | | |
|--|---|
| When offset/gain values are restored onto the source D/A converter module | <ol style="list-style-type: none"> 1. Set Save data type setting. 2. Turn on and off 'Operating condition setting request' (Y9). 3. Save the stored values of Save data type setting and CH1 Factory default setting offset value to CH16 User range setting gain value. |
| When the power of the module is off | <ol style="list-style-type: none"> 4. Replace the D/A converter module. |
| When offset/gain values are restored onto the destination D/A converter module | <ol style="list-style-type: none"> 5. Write the data saved in Save data type setting and CH1 Factory default setting offset value to CH16 User range setting gain value. 6. Turn on 'User range write request' (YA). 7. Check that 'Offset/gain setting mode status flag' (XA) is on. 8. Turn off 'User range write request (YA)'.
' 9. Check whether the destination D/A converter module operates with the offset/gain values that are restored. |

Point

When replacing modules, prevent the saved offset/gain setting data from being deleted, by one of the following methods before powering off the module.

- Use latch settings for the internal device of the destination module.
- Save the data onto an SD memory card. (To write data: use the SP.FWRITE instruction. To read data: use the SP.FREAD instruction.)
- Store the saved data.

■To apply the offset/gain values set in one module to the other modules in the same system:

- | | |
|--|---|
| When offset/gain values are restored onto the source D/A converter module | <ol style="list-style-type: none"> 1. Set Save data type setting. 2. Turn on and off 'Operating condition setting request' (Y9). 3. Save the stored values of Save data type setting and CH1 Factory default setting offset value to CH16 User range setting gain value. |
| When offset/gain values are restored onto the destination D/A converter module | <ol style="list-style-type: none"> 4. Write the data saved in Save data type setting and CH1 Factory default setting offset value to CH16 User range setting gain value. 5. Turn on 'User range write request' (YA). 6. Check that 'Offset/gain setting mode status flag' (XA) is on. 7. Turn off 'User range write request (YA)'.
' 8. Check whether the destination D/A converter module operates with the offset/gain values that are restored. |

Range reference table

The following describes the range reference tables used for saving and restoring offset/gain values.

■ Factory default setting

The following describes the buffer memory addresses of the factory default setting.

R60DA8-G: 'CH1 Factory default setting offset value' (Un\G4004) to 'CH8 Factory default setting gain value' (Un\G4019)

R60DA16-G: 'CH1 Factory default setting offset value (Un\G4004)' to 'CH16 Factory default setting gain value' (Un\G4035)

- For the R60DA8-G

Address (decimal)								Description	Range type* ¹	Analog value	Reference value (hexadecimal)
CH1	CH2	CH3	CH4	CH5	CH6	CH7	CH8				
4004	4006	4008	4010	4012	4014	4016	4018	Factory default setting offset value	Voltage (0 to 5V)	0V	0A3DH
									Voltage (-10 to 10V)	0V	8000H
									Voltage (-12 to 12V)	0V	8000H
									Current (0 to 20mA)	0mA	0AD9H
4005	4007	4009	4011	4013	4015	4017	4019	Factory default setting gain value	Voltage (0 to 5V)	5V	D70AH
									Voltage (-10 to 10V)	10V	FD00H
									Voltage (-12 to 12V)	12V	FE6CH
									Current (0 to 20mA)	20mA	E3CCH

*1 The reference values differ depending on the setting of 'Save data type setting (Save data type setting 1)' (Un\G4002) (voltage or current).

- For the R60DA16-G

Address (decimal)								Description	Range type* ¹	Analog value	Reference value (hexadecimal)
CH1	CH2	CH3	CH4	CH5	CH6	CH7	CH8				
4004	4006	4008	4010	4012	4014	4016	4018	Factory default setting offset value	Voltage (0 to 5V)	0V	0A3DH
									Voltage (-10 to 10V)	0V	8000H
									Voltage (-12 to 12V)	0V	8000H
									Current (0 to 20mA)	0mA	0AD9H
4005	4007	4009	4011	4013	4015	4017	4019	Factory default setting gain value	Voltage (0 to 5V)	5V	D70AH
									Voltage (-10 to 10V)	10V	FD00H
									Voltage (-12 to 12V)	12V	FE6CH
									Current (0 to 20mA)	20mA	E3CCH

*1 The reference values differ depending on the setting of 'Save data type setting (Save data type setting 1)' (Un\G4002) (voltage or current).

Address (decimal)								Description	Range type* ²	Analog value	Reference value (hexadecimal)
CH9	CH10	CH11	CH12	CH13	CH14	CH15	CH16				
4020	4022	4024	4026	4028	4030	4032	4034	Factory default setting offset value	Voltage (0 to 5V)	0V	0A3DH
									Voltage (-10 to 10V)	0V	8000H
									Voltage (-12 to 12V)	0V	8000H
									Current (0 to 20mA)	0mA	0AD9H
4021	4023	4025	4027	4029	4031	4033	4035	Factory default setting gain value	Voltage (0 to 5V)	5V	D70AH
									Voltage (-10 to 10V)	10V	FD00H
									Voltage (-12 to 12V)	12V	FE6CH
									Current (0 to 20mA)	20mA	E3CCH

*2 The reference values differ depending on the setting of 'Save data type setting 2' (Un\G4003) (voltage or current).

■ User range setting

The following describes the buffer memory addresses of the user range setting.

R60DA8-G: 'CH1 User range setting offset value' (Un\G4020) to 'CH8 User range setting gain value' (Un\G4035)

R60DA16-G: 'CH1 User range setting offset value' (Un\G4036) to 'CH16 User range setting gain value' (Un\G4067)

- For the R60DA8-G

Address (decimal)								Description	Range type ^{*1}	Analog value	Reference value (hexadecimal)
CH1	CH2	CH3	CH4	CH5	CH6	CH7	CH8				
4020	4022	4024	4026	4028	4030	4032	4034	User range setting offset value	Current specification	4mA	363CH
									Voltage specification	0V	8000H
									Voltage specification	0V	8000H
4021	4023	4025	4027	4029	4031	4033	4035	User range setting gain value	Current specification	20mA	E3CCH
									Voltage specification	10V	E95AH
									Voltage specification	5V	BE80H

*1 The reference values differ depending on the setting of 'Save data type setting 1' (Un\G4002) (voltage or current).

- For the R60DA16-G

Address (decimal)								Description	Range type ^{*1}	Analog value	Reference value (hexadecimal)
CH1	CH2	CH3	CH4	CH5	CH6	CH7	CH8				
4036	4038	4040	4042	4044	4046	4048	4050	User range setting offset value	Current specification	4mA	363CH
									Voltage specification	0V	8000H
									Voltage specification	0V	8000H
4037	4039	4041	4043	4045	4047	4049	4051	User range setting gain value	Current specification	20mA	E3CCH
									Voltage specification	10V	E95AH
									Voltage specification	5V	BE80H

*1 The reference values differ depending on the setting of 'Save data type setting 1' (Un\G4002) (voltage or current).

Address (decimal)								Description	Range type ^{*2}	Analog value	Reference value (hexadecimal)
CH9	CH10	CH11	CH12	CH13	CH14	CH15	CH16				
4052	4054	4056	4058	4060	4062	4064	4066	User range setting offset value	Current specification	4mA	363CH
									Voltage specification	0V	8000H
									Voltage specification	0V	8000H
4053	4055	4057	4059	4061	4063	4065	4067	User range setting gain value	Current specification	20mA	E3CCH
									Voltage specification	10V	E95AH
									Voltage specification	5V	BE80H

*2 The reference values differ depending on the setting of 'Save data type setting 2' (Un\G4003) (voltage or current).

1.17 Q Compatible Mode Function

This function allows setting the same buffer memory addresses of the A/D converter module as the buffer memory addresses of the MELSEC-Q series module.

This compatibility makes it possible to reuse sequence programs that have exhibited high performance on the MELSEC-Q series modules.

The following table lists the compatible modules of the MELSEC-Q series.

MELSEC iQ-R series D/A converter module	Compatible D/A converter module
R60DA8-G	Q66DA-G

Point

The R60DA16-G does not support the Q compatible mode function.

Operation

Only the buffer memory assignment is changed in the Q compatible mode.

- The I/O signal assignment is the same as that of the R mode. Some signals have been changed. However, the signals that change the module operation maintain the compatibility. Therefore, when a MELSEC-Q series sequence program is diverted, a significant modification of the program is not required. The following table shows a difference between the R60DA8-G and Q66DA-G.

Device number	R60DA8-G	Q66DA-G
X8	Use prohibited	High resolution mode status flag (ON: High resolution mode, OFF: Normal resolution mode)
XD	Disconnection detection signal (ON: Disconnection is detected, OFF: No disconnection is detected)	Use prohibited

Point

- When a MELSEC-Q series sequence program is diverted, check digital values and the operation timing and modify the sequence program if necessary because the specifications such as the resolution and update timing are changed.
- When a MELSEC-Q series sequence program is diverted and an error code is set as the operating condition or interlock condition, the program does not operate normally.
- When the Q compatible mode function is enabled, a program that uses FB or labels cannot be created. When FB or labels is used, create a program in the R mode.

Setting procedure

1. When adding a new module, select the module whose module name has "(Q)" at the end.

 [Navigation window] ⇒ [Parameter] ⇒ [Module Information] ⇒ Right-click ⇒ [Add New Module]

2. Configure the same parameter setting as the one of when the R mode is used.
3. Restart the CPU module after the module parameter is written.

Point

- During the module operation, the mode cannot be switched between the R mode and Q compatible mode.
- The project of the compatible D/A converter module created by GX Works2 can be read with the other format read function of GX Works3. The read project keeps various settings of the compatible D/A converter module as the settings of the D/A converter module of the MELSEC iQ-R series. The settings to be kept are the switch setting, parameter setting, auto refresh setting, and I/O assignment setting.

2 PARAMETER SETTINGS

Set the parameters of each channel.

Setting parameters here eliminates the need to program them.

2

2.1 Basic Setting

Setting procedure

Open "Basic setting" of the engineering tool.

1. Start Module Parameter.

[Navigation window] ⇒ [Parameter] ⇒ [Module Information] ⇒ Module model name ⇒ [Basic setting]

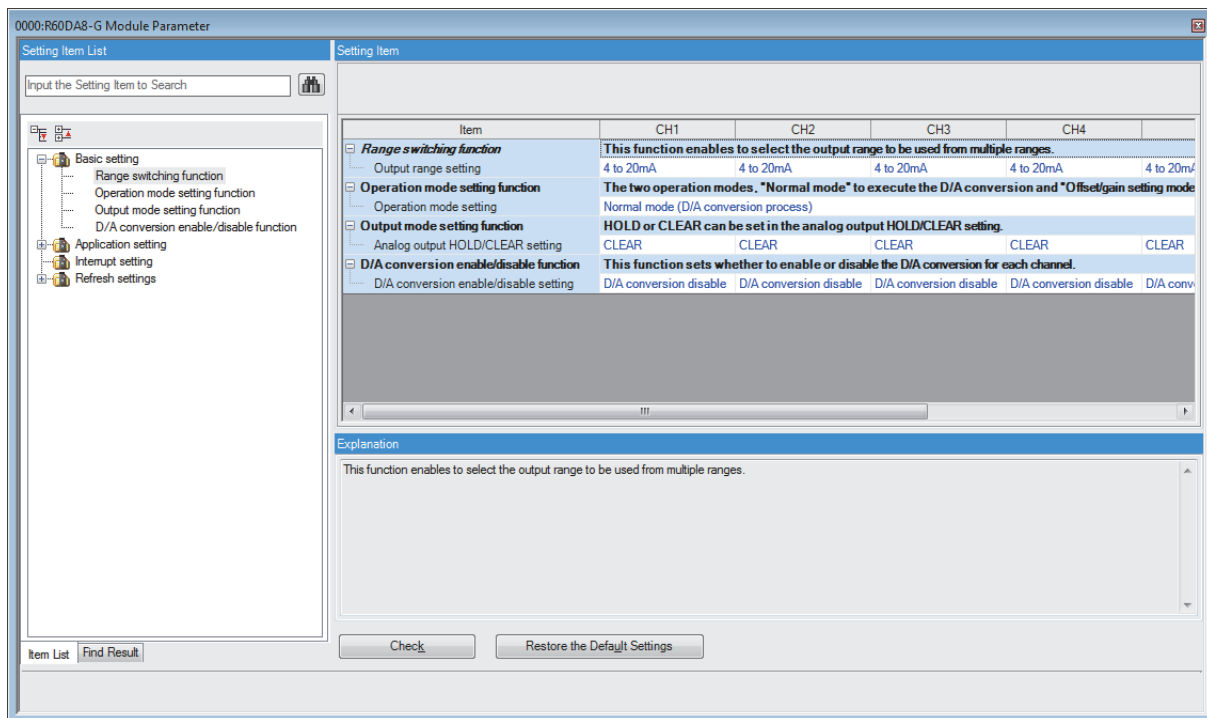

2. Enter setting values.

- Item where a value is selected from the pull-down list

Click the [▼] button of the item to be set, and from the pull-down list that appears, select the value.

2.2 Application Setting

Setting procedure

Open "Application setting" of the engineering tool.

1. Start Module Parameter.

[Navigation window] ⇒ [Parameter] ⇒ [Module Information] ⇒ Module model name ⇒ [Application setting]

Item	CH1	CH2	CH3	CH4	CH5	CH6	CH7	C
Scalings function This function enables to change the upper limit value or lower limit value of the digital value input range to any value.								
Scalings enable/disable setting	Disable	Disable	Disable	Disable	Disable	Disable	Disable	Disabl
Scalings upper limit value	0	0	0	0	0	0	0	0
Scalings lower limit value	0	0	0	0	0	0	0	0
Shift function This function adds the set amount to the digital value. A fine adjustment at the system startup can be easily performed.								
Input value shift amount	0	0	0	0	0	0	0	0
Warning output function This function outputs an Warning when the digital value is outside the setting range.								
Warning output setting	Disable	Disable	Disable	Disable	Disable	Disable	Disable	Disabl
Warning output upper limit value	0	0	0	0	0	0	0	0
Warning output lower limit value	0	0	0	0	0	0	0	0
Rate control function This function controls the increasing and decreasing amount of the analog output value per conversion cycle for one chann								
Rate control enable/disable setting	Disable	Disable	Disable	Disable	Disable	Disable	Disable	Disabl
Increase digital limit value	64000	64000	64000	64000	64000	64000	64000	64000
Decrease digital limit value	64000	64000	64000	64000	64000	64000	64000	64000
Online module change The module can be changed without the system being stopped.								
Auto restore of Offset/ gain setting with the module change	Enable							
CPU error output mode setting You can be the setting of whether to keep or not to clear the output of the module to the CPU stop error.								
CPU error output mode setting	Clear							

2. Enter setting values.

- Item where a value is selected from the pull-down list

Click the [▼] button of the item to be set, and from the pull-down list that appears, select the value.

- Item where a value is entered into the text box

Double-click the item to be set to enter the numeric value.

2.3 Interrupt Setting

Setting procedure

Open "Interrupt setting" of the engineering tool.

1. Start Module Parameter.

[Navigation window] ⇒ [Parameter] ⇒ [Module Information] ⇒ Module model name ⇒ [Interrupt setting]

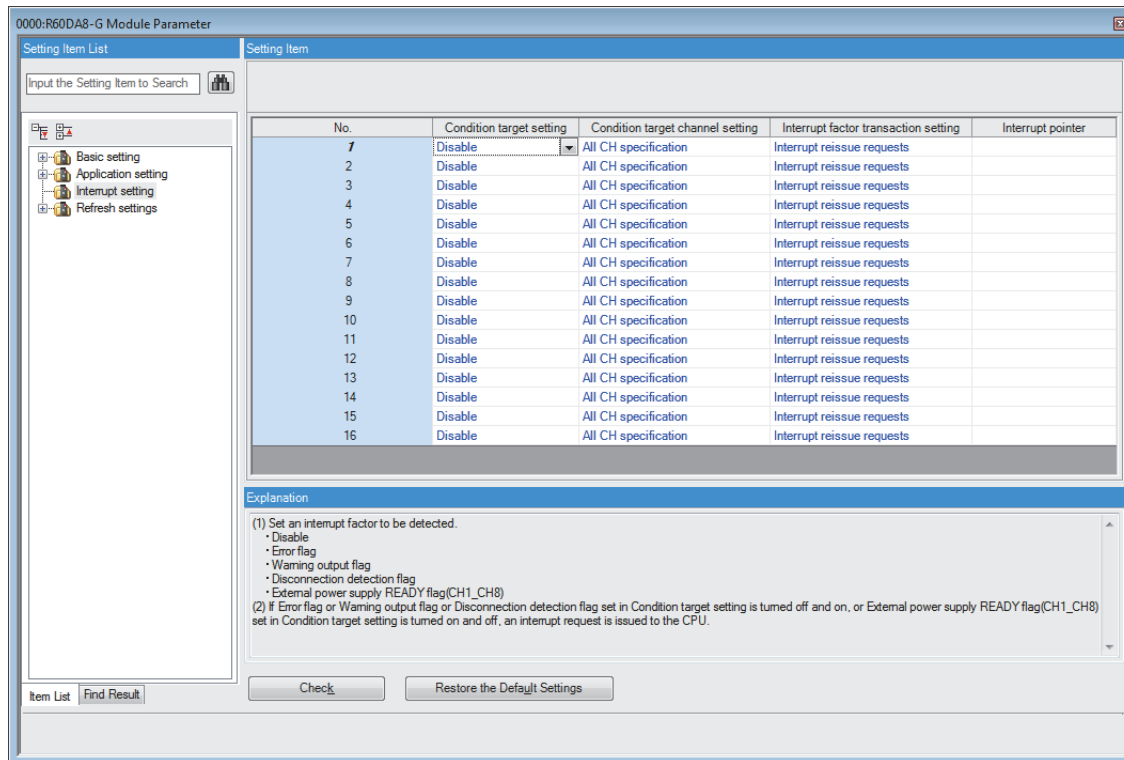

2. Click the interrupt setting number (No.1 to 16) to be changed to enter the setting value.

- Item where a value is selected from the pull-down list

Click the [▼] button of the item to be set, and from the pull-down list that appears, select the value.

- Item where a value is entered into the text box

Double-click the item to be set to enter the numeric value.

2.4 Refresh Setting

Setting procedure

Set the buffer memory area of the D/A converter module to be refreshed automatically.

This refresh setting eliminates the need for reading/writing data by programming.

1. Start Module Parameter.

[Navigation window] ⇒ [Parameter] ⇒ [Module Information] ⇒ Module model name ⇒ [Refresh settings]

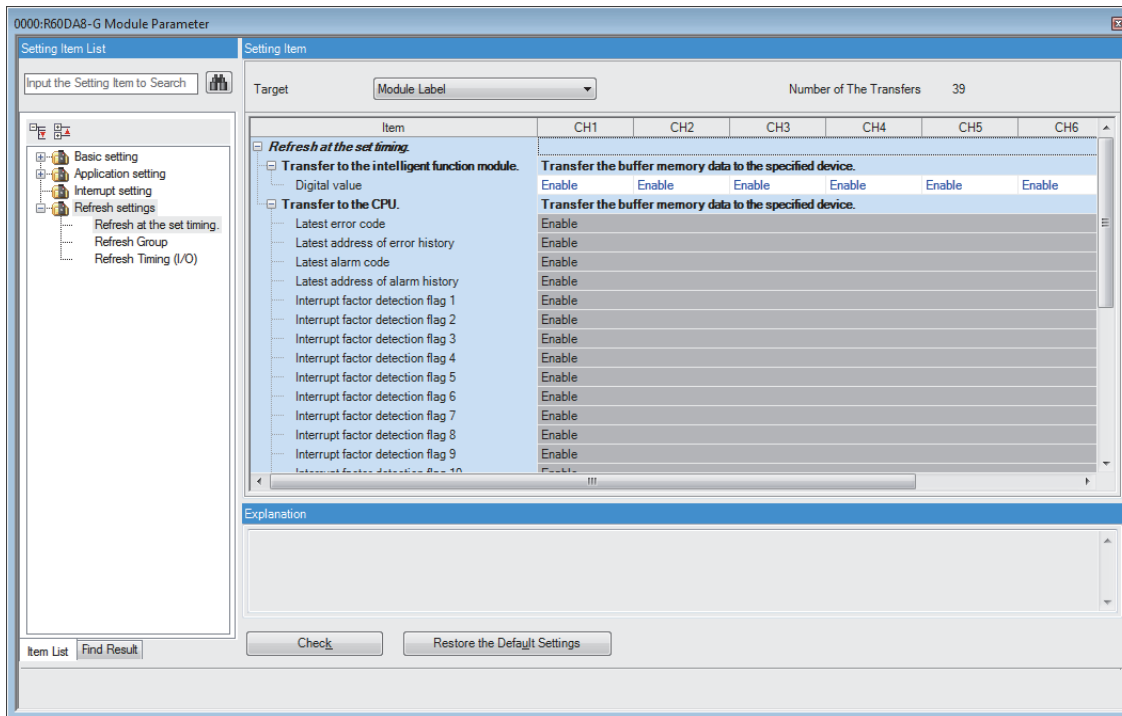

2. Click "Target" and set the refresh destination.

- When "Target" is "Module label"

Set whether to enable or disable the auto refresh by setting "Digital value" to Enable or Disable.

- When "Target" is "Refresh Data Register (RD)"

Setting the start device for "Top Device Name" automatically sets the transfer destinations for all the items.

- When "Target" is "Device"

Double-click the item to be set to enter the refresh destination device.

3. Click "Refresh Group" to set the refresh timing.

Set "Refresh Group" to "At the Execution Time of END Instruction" or "At the Execution Time of Specified Program".

When "At the Execution Time of Specified Program" is set, double-click "Group [n] (n: 1-64)" and set a value of 1 to 64.

Point

When the refresh is enabled, the values of the refresh destination are enabled at the refresh timing set with the engineering tool. At this time, the buffer memory areas are overwritten with the values of the refresh destination. To change the value in the refresh target buffer memory area, create a program to change the module label of the refresh destination and the device value.

Refresh processing time

The refresh processing time [μs] is a constituent of the scan time of the CPU module. For details on the scan time, refer to the following.

 MELSEC iQ-R CPU Module User's Manual (Application)

The refresh processing time [μs], which is taken for refresh, is given by:

- Refresh processing time [μs] = Refresh read time (time for transferring refresh data to the CPU module) + Refresh write time (time for transferring refresh data to the intelligent function module)

According to the setting of "Target", the refresh read time and the refresh write time vary.

When "Target" is a module label or a refresh data register (RD)

The following table lists the refresh read time and the refresh write time when the R□CPU is used.

Model	Classification	When using the refresh settings
R60DA8-G	Refresh read time	22.88 μs
	Refresh write time	13.82 μs
R60DA16-G	Refresh read time	31.12 μs
	Refresh write time	18.54 μs
R60DA8-G (Q compatible mode)	Refresh read time	17.96 μs
	Refresh write time	9.76 μs

When "Target" is a specified device

Calculate the refresh read time and refresh write time according to the number of items and the number of their transfer data (in units of word) that are set to be refreshed. For the calculation method, refer to the following.

 MELSEC iQ-R CPU Module User's Manual (Application)

3 TROUBLESHOOTING

This chapter describes errors that may occur while using the D/A converter module, and those troubleshooting.

3.1 Troubleshooting with the LEDs

Check the state of the LEDs to narrow down the possible causes of the trouble. This step is the first diagnostics before using the engineering tool.

A state of the D/A converter module can be checked with the RUN LED, ERR LED, and ALM LED. The following table lists the correspondence relation between each LED and the D/A converter module status.

Name	Description
RUN LED	Indicates the operating status of the module. On: Normal operation Flashing (1s cycles): In offset/gain setting mode Flashing (400ms cycles): Selected as a module for the online module change Off: 5V power supply interrupted, watchdog timer error occurred, or exchanging the module is allowed in the process of the online module change.
ERR LED	Indicates the error status of the module.*1 On: Error occurred Off: Normal operation
ALM LED	Indicates the alarm status of the module.*2 Or, indicates the wait-for-restart status after the safety module is disabled.*3 On: Alert occurred Flashing (400ms cycles): Wait-for-restart Off: Normal operation

*1 For details, refer to the following.

☞ Page 71 List of Error Codes

*2 For details, refer to the following.

☞ Page 74 List of Alarm Codes

*3 For details, refer to the following.

☞ Page 153 Disabling the Safety Module

3.2 Checking the State of the Module

The following functions are available in the "Module Diagnostics" window of the D/A converter module.

FUNCTIONS	Application
Error information	Displays the description of errors that has occurred. Clicking the [Event History] button displays the errors that have occurred on the network and the history of the errors detected and the operations executed on each module.
Module Information List	Displays each status information of the D/A converter module.

3

Error Information

Check the description and the actions of the errors that have occurred.

☞ [Diagnostics] ⇒ [System Monitor] ⇒ Right-click the module to be checked. ⇒ "Module Diagnostics"

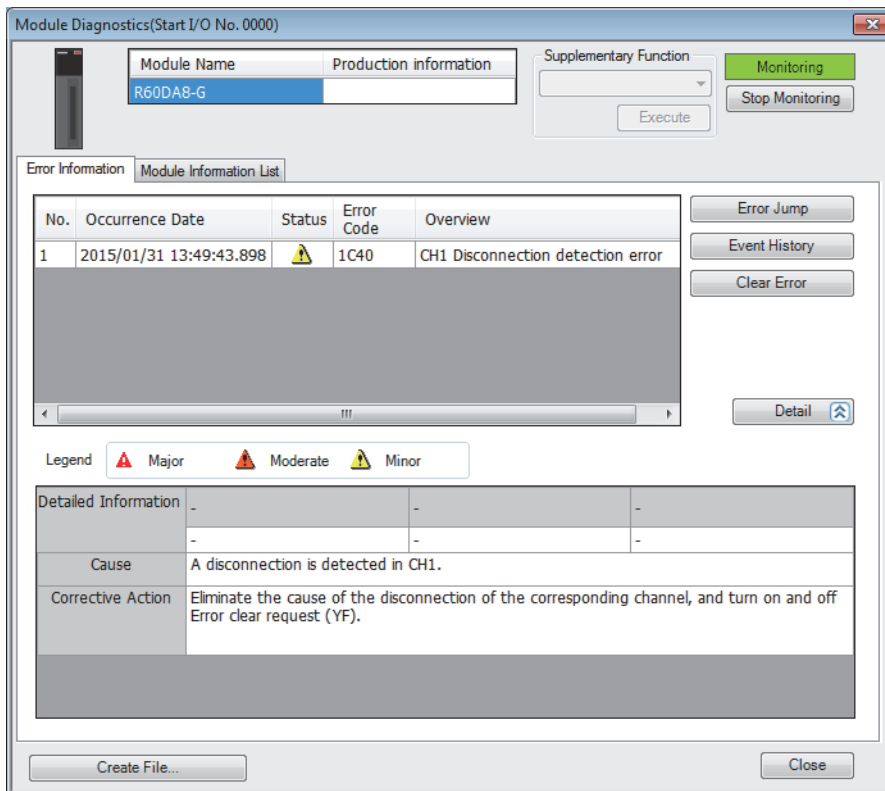

Item	Description
Status	Major: An error such as a hardware failure or memory failure. The module stops operating. Moderate: An error, such as a parameter error, which affects module operation. The module stops operating. Minor: An error such as a communication failure. The module continues operating.
Detailed Information	Displays detailed information about each error (maximum of 3 pieces).
Cause	Displays the detailed error causes.
Action	Displays the actions to eliminate the error causes.

Module Information List

Switch to the "Module Information List" tab to display each status information of the D/A converter module.

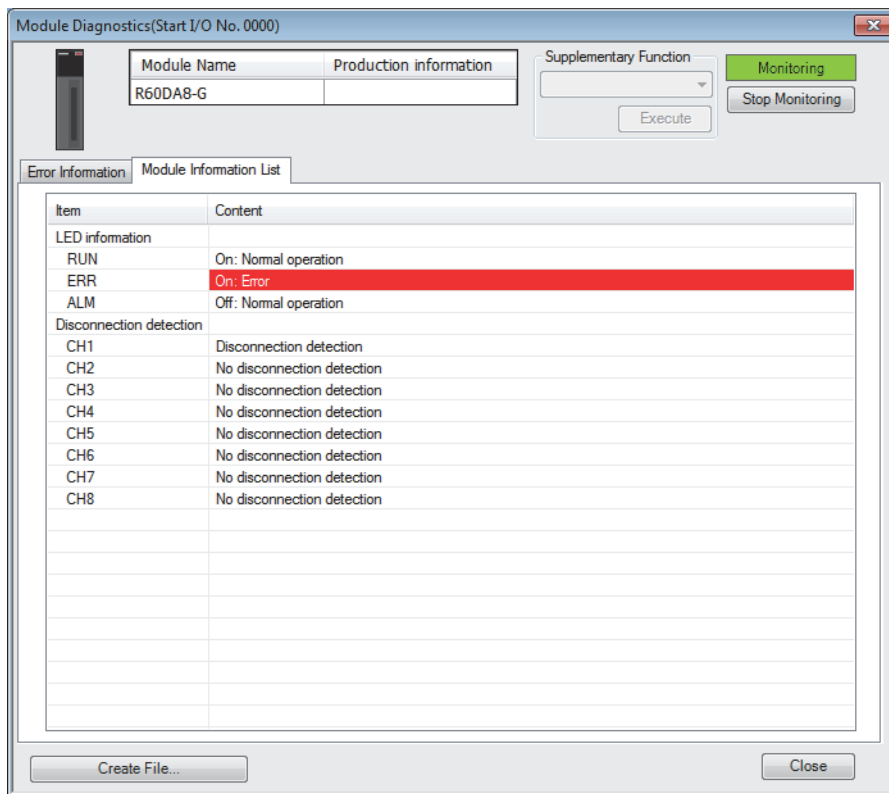

Item	Description
LED information	Displays the LED status of the D/A converter module.
Disconnection detection	Displays the detection status for the disconnection of the D/A converter module for each channel.

3.3 Troubleshooting by Symptom

When the D/A converter module does not start up

Check item	Action
Check whether 5 seconds or more has passed since the power supply module was powered off.	After the power supply module is powered off, wait at least 5 seconds before turning on the input power supply to the power supply module.

When the RUN LED flashes or turns off

3

When flashing

Check item	Cause	Action
Check whether the module is in offset/gain setting mode.	In the module parameter setting of the engineering tool, the programmable controller power supply has been turned off and on, or the CPU module has been reset when "Operation mode setting" is "Offset/gain setting mode".	In the module parameter setting of the engineering tool, set "Operation mode setting" to "Normal mode (D/A conversion process)" and turn off and on the programmable controller power supply, or reset the CPU module.
	The G(P).OFFGAN instruction has been executed with the mode switched to offset/gain setting mode.	Review the program that uses the G(P).OFFGAN instruction to check whether the mode has been switched erroneously.
	The value in the mode switching setting has been changed and the mode has been switched to offset/gain setting mode.	Review the program that uses the mode switching setting to check whether the mode has been switched erroneously.
Check whether the module is selected as the target module for online module change.	The base number and slot number of the D/A converter module are set in SD1600 and SD1601.	Turn on Module selection cancel request flag (SM1615).

When turning off

Check item	Action
Check whether the power is supplied.	Check that the supply voltage of the power supply module is within the rated range.
Check whether the capacity of the power supply module is enough.	Calculate the current consumption of mounted modules, such as the CPU module, I/O modules, and intelligent function modules to check that the power capacity is enough.
Check whether the module is mounted properly.	Check the mounting state of the module.
Check whether exchanging the module is allowed in the process of the online module change.	Perform the online module change. For details, refer to the following. □ MELSEC iQ-R Online Module Change Manual
The cases other than the above	Reset the CPU module, and check if the RUN LED turns on. If the RUN LED still remains off, the possible cause is a failure of the module. Please consult your local Mitsubishi representative.

When the ERR LED turns on

When turning on

Check item	Corrective action
Check whether any error has occurred.	Check 'Latest error code' (Un\G0) and take actions described in the list of error codes. ☞ Page 71 List of Error Codes

When the ALM LED turns on

When turning on

Check item	Corrective action
Check whether any alert has been issued.	Check 'Alert output upper limit flag' (Un\G36) or 'Alert output lower limit flag' (Un\G37). Take actions described in the list of alarm codes. (☞ Page 74 List of Alarm Codes)

When the analog output is not performed

Check item	Corrective action
Check whether the 24VDC external power supply is supplied.	Check 'External power supply READY flag (CH1 to CH8)' (X7) and 'External power supply READY flag (CH9 to CH16)' (X17). When either of the flags is off, supply 24VDC to the following pins. <ul style="list-style-type: none"> • R60DA8-G: pin number A19, A20, B19, and B20 • R60DA16-G: pin number 1A19, 1A20, 1B19, 1B20, 2A19, 2A20, 2B19, and 2B20
Check whether there is any problem with the wiring, such as looseness or disconnection of analog signal lines.	Check the faulty area by checking the signal line visually or conductively.
Check whether the CPU module is in the STOP state.	Change the state of the CPU module to RUN.
Check whether the offset/gain setting is correct.	When the output range setting is set to the user range setting 1, user range setting 2, or user range setting 3, turn on and off 'Operating condition setting request' (Y9), and compare the values of CH□ User range setting offset value and CH□ User range setting gain value with the values in the range reference tables. If the stored values are not desired offset/gain values, perform the offset/gain setting again. For the range reference table, refer to the following. ☞ Page 58 Range reference table
Check whether the output range setting is correct.	Check CH□ Range setting monitor using the engineering tool. If the output range setting is incorrect, correct the output range setting of the engineering tool or setting of CH□ Range setting.
Is D/A conversion disabled set to D/A conversion enable/disable setting of the channel to output a value?	Check CH□ D/A conversion enable/disable setting, and set D/A conversion enable/disable setting to D/A conversion enabled with a program or the engineering tool.
Check whether 'CH□ Output enable/disable flag' (Y1 to Y8, Y11 to Y18) of the channel to be output is off.	Check the on/off state of 'CH□ Output enable/disable flag' (Y1 to Y8, Y11 to Y18). If 'CH□ Output enable/disable flag' (Y1 to Y8, Y11 to Y18) is off, correct the program. Check that the CPU module is not in the STOP state.
Check whether the program to write a digital value is correct.	Check CH□ Digital value with the engineering tool. If the value set to Digital value is not stored, correct the write program.
Has 'Operating condition setting request' (Y9) been executed?	Turn on and off 'Operating condition setting request' (Y9) with the engineering tool, and check that the analog output is performed properly. If it is performed properly, check if 'Operating condition setting request' (Y9) operates correctly in the program.

When HOLD of an analog output value is not available

Check item	Action
Check whether the analog output HOLD/CLEAR function setting is correct.	Check CH□ HOLD/CLEAR function setting monitor. If the setting is incorrect, set "Analog output HOLD/CLEAR setting" to "HOLD" in the module parameter setting of the engineering tool, and turn off and on the programmable controller or reset the CPU module.

When 'External power supply READY flag (CH1 to CH8)' (X7) and 'External power supply READY flag (CH9 to CH16)' (X17) do not turn on

Check item	Action
Is the external power supply 24VDC supplied? (1) Is the external power supply correctly wired? (2) Is the external power supply 24VDC supplied within the specified range?	(1) Wire the external power supply by referring to the "External Wiring". (☞ MELSEC iQ-R Channel Isolated Digital-Analog Converter Module User's Manual (Startup)) (2) Supply 24VDC within the range of the performance specifications. (☞ MELSEC iQ-R Channel Isolated Digital-Analog Converter Module User's Manual (Startup))
The cases other than the above	The possible cause is a failure of the module. Please consult your local Mitsubishi representative.

Point

If the module does not operate properly even after the above actions are taken, the module may be failed. Please consult your local Mitsubishi representative.

3.4 List of Error Codes

When an error occurs during operation, the D/A converter module stores an error code in 'Latest error code' (Un\G0) of the buffer memory. In addition, 'Error flag' (XF) turns on. Turning on 'Error clear request' (YF) clears the error code in 'Latest error code' (Un\G0), and 'Error flag' (XF) turns off.

Error codes of the D/A converter module are classified in minor errors or moderate errors.

- Minor error: An error generated by an incorrect setting of a program or parameter. The D/A conversion continues with the parameter setting before the change. (1000H to 1FFFH)
- Moderate error: An error such as hardware failure. The D/A conversion does not continue. (3000H to 3FFFH)

The following table shows the error codes stored.

□ in error codes: Indicates the channel number of a generated error. A numerical value of 0 to F is used to correspond to channel 1 to 16.

(CH1: 0, CH2: 1, CH3: 2, CH4: 3, CH5: 4, CH6: 5, CH7: 6, CH8: 7, CH9: 8, CH10: 9, CH11: A, CH12: B, CH13: C, CH14: D, CH15: E, CH16: F)

△ in error codes: Indicates the interrupt setting corresponding to an error (0: Setting 1 to F: Setting 16).

Error code	Error name	Description and cause	Action
0000H	—	There is no error.	—
1080H	Number of writes to offset/gain settings reach limit error	The number of offset/gain settings has exceeded the guaranteed maximum number.	Any further setting of offset/gain values may not be reflected correctly.
1081H	Number of safety module status switching exceeding limit error	The number of times of enabling/disabling the safety module has exceeded the guaranteed maximum number.	Any further executions of enabling/disabling the safety module may not be reflected correctly.
1302H	Failure of disabling safety module	Disabling the safety module function failed.	Disable the safety module function again. If the same error occurs again after re-registration, the possible cause is a module failure. Please consult your local Mitsubishi representative.
17E0H	Module-specific backup parameter restore error	Offset/gain values cannot be restored with the module-specific backup parameter.	The module-specific backup parameter file may be damaged. Readjust the user range.
17E1H	Module-specific backup parameter creation error	The module-specific backup parameter has not been created.	Check the free space on the data memory of the control CPU module and the SD memory card, and recreate a module-specific backup parameter. ☞ Page 52 Backing up, Saving, and Restoring Offset/Gain Values
180△H	Interrupt factor generation setting range error	A value other than 0 to 1 is set in Interrupt factor generation setting [n].	Set Interrupt factor generation setting [n] to 0 or 1.
181△H	Condition target setting range error	A value other than 0 to 6 is set in Condition target setting [n] (for the R60DA8-G, a value other than 0 to 4).	Set Condition target setting [n] to 0 to 6 (for the R60DA8-G, 0 to 4).
182△H	Condition target channel setting range error	A value other than 0 to 16 is set in Condition target channel setting [n] (for the R60DA8-G, a value other than 0 to 8).	Set Condition target channel setting [n] to 0 to 16 (for the R60DA8-G, 0 to 8).
1860H	G(P).OGSTOR instruction execution error in offset/gain setting mode	The G(P).OGSTOR instruction has been executed in offset/gain setting mode.	Do not execute the G(P).OGSTOR instruction in the offset/gain setting mode.
1861H	Offset/gain setting continuous write occurrence error	The G(P).OGSTOR instruction has been executed continuously or a setting value has been continuously written to the flash memory 26 times or more in the offset/gain setting.	For the G(P).OGSTOR instruction, execute it only once per module. For the offset/gain setting, write the setting value only once per setting.
1862H	Model mismatch error at the execution of OGSTOR	The G(P).OGSTOR instruction has been executed on a module different from the one on which the G(P).OGLOAD instruction was executed. The G(P).OGSTOR instruction has been executed ahead of the G(P).OGLOAD instruction.	Execute the G(P).OGLOAD and G(P).OGSTOR instructions on the same module. As the other way, execute the G(P).OGLOAD instruction on the module whose data is to be restored, and then execute the G(P).OGSTOR instruction on the module to which the data is to be restored.

Error code	Error name	Description and cause	Action
1863H	Save data type setting error	<ul style="list-style-type: none"> A value outside the setting range is set in Save data type setting (Save data type setting 1) or Save data type setting 2. At the execution of the G(P).OGLoad instruction or the G(P).OGSTOR instruction, a value outside the setting range is set in Save data type setting (Save data type setting 1) or Save data type setting 2 of the control data. 	Set a value within the range of 0H to 2H for Save data type setting (Save data type setting 1) and Save data type setting 2 for each channel.
190□H	Range setting range error	A value out of the range is set in CH□ Range setting.	Set CH□ Range setting to the following values: 0 to 5, A, B, D, E, F (hexadecimal)
191□H	Digital value setting range error	A value outside the range is set for CH□ Digital value.	Set an appropriate value for CH□ Digital value.
1A0□H	Scaling enable/disable setting range error	A value other than 0 and 1 is set in CH□ Scaling enable/disable setting.	Set CH□ Scaling enable/disable setting to 0 or 1.
1A1□H	Scaling setting range error	A value other than -32000 to 32000 is set in CH□ Scaling lower limit value or CH□ Scaling upper limit value.	Set CH□ Scaling lower limit value and CH□ Scaling upper limit value to -32000 to 32000.
1A2□H	Scaling upper/lower limit value setting error	CH□ Scaling upper limit value and CH□ Scaling lower limit value are set as the scaling upper limit value = the scaling lower limit value.	Set CH□ Scaling upper limit value and CH□ Scaling lower limit value as the scaling upper limit value ≠ the scaling lower limit value.
1B0□H	Alert output setting range error	A value other than 0 and 1 is set in CH□ Alert output setting.	Set CH□ Alert output setting to 0 or 1.
1B1□H	Alert output upper/lower limit value inversion error	Values that do not satisfy the following relation are set in CH□ Alert output upper limit value and CH□ Alert output lower limit value: Upper limit value > Lower limit value	Set values so that CH□ Alert output upper limit value is larger than CH□ Alert output lower limit value.
1B8□H	Rate control enable/disable setting range error	A value other than 0 and 1 is set in CH□ Rate control enable/disable setting.	Set 0 or 1 for CH□ Rate control enable/disable setting.
1B9□H	Digital limit value range error	A value other than 0 to 64000 is set in CH□ Increase digital limit value or CH□ Decrease digital limit value.	Set a value within 0 to 64000 in CH□ Increase digital limit value and CH□ Decrease digital limit value.
1C0□H	Disconnection detection enable/disable setting range error	A value other than 0 and 1 is set in CH□ Disconnection detection enable/disable setting.	Set CH□ Disconnection detection enable/disable setting to 0 or 1.
1C1□H	Disconnection detection (extended mode) enable/disable setting range error	A value other than 0 and 1 is set in CH□ Disconnection detection (extended mode) enable/disable setting.	Set CH□ Disconnection detection (extended mode) enable/disable setting to 0 or 1.
1C2□H	Disconnection detection auto-clear enable/disable setting range error	A value other than 0 and 1 is set in CH□ Disconnection detection auto-clear enable/disable setting.	Set CH□ Disconnection detection auto-clear enable/disable setting to 0 or 1.
1C4□H	Disconnection detection error	A disconnection is detected in CH□.	Eliminate the cause of the disconnection of the corresponding channel, and turn on and off 'Error clear request' (YF).
1E50H	Offset/gain setting channel specification error	Multiple channels are set at the same time during the offset/gain setting. In the offset/gain setting, "1: Setting channel" is set for both CH□ Offset/gain setting mode (offset specification) and CH□ Offset/gain setting mode (gain specification), or "0: Disable" is set.	Correctly set CH□ Offset/gain setting mode (offset specification) and CH□ Offset/gain setting mode (gain specification).
1E51H	User range data invalid (CH identification disabled)	An invalid value is set in the offset/gain setting. The number of the channel in which this error occurs cannot be identified.	Perform the offset/gain setting again for all channels where the user range is set. If the error occurs again, the possible cause is a failure of the module. Please consult your local Mitsubishi representative.
1E52H	Analog adjustment output setting out-of-range error	A value other than -3000 to 3000 is set to Offset/gain adjustment value specification.	Set a value within the range of -3000 to 3000 to Offset/gain adjustment value specification.
1E6□H	User range data invalid (CH identification allowed)	An invalid value is set in CH□ Offset/gain setting.	Perform the offset/gain setting again for the channels where the error has occurred. If the error occurs again, the possible cause is a failure of the module. Please consult your local Mitsubishi representative.
1E7□H	Offset/gain value inversion error	The offset value and gain value to be saved in the flash memory are as follows: Offset value ≥ Gain value	Perform the offset/gain setting again so that the following condition is satisfied: Offset value < Gain value

Error code	Error name	Description and cause	Action
1E8□H	Offset/gain setting channel range error	A value other than 0 and 1 is set in CH□ Offset/gain setting mode (offset specification) and CH□ Offset/gain setting mode (gain specification).	Set CH□ Offset/gain setting mode (offset specification) and CH□ Offset/gain setting mode (gain specification) to 0 or 1.
1E9□H	Offset/gain setting range error	When the offset and gain are set, a value other than D, E, or F is set for CH□ Offset/gain setting mode (range specification).	Set D, E, or F for CH□ Offset/gain setting mode (range specification).
3001H	Hardware error	A hardware error has occurred in the module.	Power off and on the module. If the error occurs again, the possible cause is a failure of the module. Please consult your local Mitsubishi representative.
3030H	Flash memory error	The data in the flash memory is abnormal.	Check the analog output value. If the values are abnormal, please consult your local Mitsubishi representative.
3040H	Start-up in standard mode with safety validated	The module whose function as the safety module was enabled was started up in standard mode.	To use the module in standard mode, disable the safety module function. For the procedure on how to disable the safety module function, refer to the following.  Page 153 Disabling the Safety Module

3.5 List of Alarm Codes

When an alarm occurs during operation, the D/A converter module stores an alarm code in 'Latest alarm code' (Un\G2) of the buffer memory. Turning on 'Alert output clear request' (YE) or 'Operating condition setting request' (Y9) clears the alarm code in 'Latest alarm code' (Un\G2).

□ in alarm codes: Indicates the channel of a generated error. A numerical value of 0 to F is used to correspond to channel 1 to 16.

(CH1: 0, CH2: 1, CH3: 2, CH4: 3, CH5: 4, CH6: 5, CH7: 6, CH8: 7, CH9: 8, CH10: 9, CH11: A, CH12: B, CH13: C, CH14: D, CH15: E, CH16: F)

Alarm code	Alarm name	Description and cause	Action
080□H	Alert output alarm (upper limit)	The alert output alarm (upper limit) has occurred in CH□.	Adjust CH□ Digital value to fall within the range, and turn on and off 'Alert output clear request' (YE). As a result, the corresponding bit of 'Alert output upper limit flag' (Un\G36) and/or 'Alert output lower limit flag' (Un\G37), and 'Alert output signal' (XE) turn off.
081□H	Alert output alarm (lower limit)	The alert output alarm (lower limit) has occurred in CH□.	
0C0□H	CH□ Under-output range change denial alarm	The range has been switched during analog output in CH□.	To switch the range, turn off 'CH□ Output enable/disable flag' (Y1 to Y8, Y11 to Y18) of the corresponding channel, and turn on and off 'Operating condition setting request' (Y9).

APPENDICES (STANDARD MODE)

Appendix 1 Module Label

The functions of the D/A converter module can be set by using module labels.

Module labels of I/O signals

The module label names of I/O signals are defined as follows.

"Module name"_"Module number".b"Label name" or "Module name"_"Module number".b"Label name"_D

Ex.

R60DAG_1.bModuleREADY_D

■Module name

The character string of a module model name is given.

■Module number

A number starting from 1 is added to identify modules that have the same module name.

■Label name

The label identifier unique to a module is given.

■_D

This string indicates that the module label is for the direct access input (DX) or direct access output (DY). A module label without the string is for the input (X) or output (Y) of the refresh processing.

Module labels of buffer memory areas

The module label name of a buffer memory area is defined with the following structure:

"Module name"_"Module number"."Data type"_D["(Channel)"]."Data format""Label name"_D

Ex.

R60DAG_1.stnControl_D[0].wDigitalValue_D

■Module name

The character string of a module model name is given.

■Module number

A number starting from 1 is added to identify modules that have the same module name.

■Data type

The data type to sort a buffer memory area is given. Each data type is as follows:

Data type	Description
stnMonitor	Monitor
stnControl	Control
stnSetting	Setting

■Channel

The channel number corresponding to a module label is given. A numerical value of 0 to 15 is used to correspond to CH1 to CH16.

(CH1: 0, CH2: 1, CH3: 2, CH4: 3, CH5: 4, CH6: 5, CH7: 6, CH8: 7, CH9: 8, CH10: 9, CH11: 10, CH12: 11, CH13: 12, CH14: 13, CH15: 14, CH16: 15)

■Data format

The string that represents the data size of a buffer memory area is given. Each data format is as follows:

Data format	Description
u	Word [Unsigned]/Bit string [16-bit]
w	Word [Signed]
z	System area

■Label name

The label identifier unique to a module is given.

■_D

This string indicates that the module label is for the direct access. A module label without the string is for the auto refresh. The following table shows the differences between the auto refresh and direct access.

Type	Description	Access timing	Example
Auto refresh	Values that are read from or written to the module label are reflected in the module collectively at the auto refresh. The run time of the program can be reduced. To use the auto refresh, set "Target" to "Module Label" in "Refresh settings" of the module parameter.	At auto refresh	R60DAG_1.stnControl[0].wDigitalValue
Direct access	Values that are read from or written to the module label is reflected in the module instantly. Compared with the auto refresh, the run time of the program becomes longer. However, the responsiveness is high. For the instruction processing time, refer to the following.  MELSEC iQ-R Programming Manual (CPU Module Instructions, Standard Functions/Function Blocks)	At reading/writing from/to the module label	R60DAG_1.stnControl_D[0].wDigitalValue_D

Precautions

When using the R60DA8-G, do not use the module labels assigned to CH9 to CH16.

Doing so may cause malfunction.

Appendix 2 I/O Signals

List of I/O signals

The following table lists the I/O signals of the D/A converter module.

For details on the I/O signals, refer to the following.

☞ Page 79 Details of input signals

☞ Page 86 Details of output signals

Point

- The I/O signals (X/Y) described below show the case that the start I/O number of the D/A converter module is set to "0".
- Do not use the "Use prohibited" signals shown below because the system uses them. If users use (turn off and on) the signals, the functions of the D/A converter module cannot be guaranteed.

Input signal

Device number	Signal name
X0	Module READY
X1 to X6	Use prohibited
X7	External power supply READY flag (CH1 to CH8)
X8	Use prohibited
X9	Operating condition setting completed flag
XA	Offset/gain setting mode status flag
XB	Channel change completed flag
XC	Set value change completed flag
XD	Disconnection detection signal
XE	Alert output signal
XF	Error flag
X10 to X16 ^{*1}	Use prohibited
X17 ^{*1}	External power supply READY flag (CH9 to CH16)
X18 to X1F ^{*1}	Use prohibited

*1 For the R60DA8-G, only X0 to XF are available because the number of I/O points is 16.

Output signal

Device number	Signal name
Y0	Use prohibited
Y1	CH1 Output enable/disable flag
Y2	CH2 Output enable/disable flag
Y3	CH3 Output enable/disable flag
Y4	CH4 Output enable/disable flag
Y5	CH5 Output enable/disable flag
Y6	CH6 Output enable/disable flag
Y7	CH7 Output enable/disable flag
Y8	CH8 Output enable/disable flag
Y9	Operating condition setting request
YA	User range write request
YB	Channel change request
YC	Value change request
YD	Use prohibited
YE	Alert output clear request
YF	Error clear request
Y10 ^{*1}	Use prohibited
Y11 ^{*1}	CH9 Output enable/disable flag

Device number	Signal name
Y12 ^{*1}	CH10 Output enable/disable flag
Y13 ^{*1}	CH11 Output enable/disable flag
Y14 ^{*1}	CH12 Output enable/disable flag
Y15 ^{*1}	CH13 Output enable/disable flag
Y16 ^{*1}	CH14 Output enable/disable flag
Y17 ^{*1}	CH15 Output enable/disable flag
Y18 ^{*1}	CH16 Output enable/disable flag
Y19 to Y1F ^{*1}	Use prohibited

*1 For the R60DA8-G, only Y0 to YF are available because the number of I/O points is 16.

Details of input signals

The following describes the details of the input signals for the D/A converter module which are assigned to the CPU module. The I/O numbers (X/Y) described in Appendix 2 are for the case when the start I/O number of the D/A converter module is set to 0.

Point

This section describes buffer memory addresses for CH1.

For details on the buffer memory addresses after CH2, refer to the following.

 Page 89 List of buffer memory addresses

Module READY

Module READY (X0) turns on to indicate the preparation for the D/A conversion is completed after the power-on or the reset operation of the CPU module.

In the following cases, 'Module READY' (X0) turns off.

- In the offset/gain setting mode (In this case, the D/A conversion is performed.)
- When a watchdog timer error occurs in the D/A converter module (In this case, the D/A conversion is not performed.)

Device number

The following shows the device number of this input signal.

Signal name	CH1 to CH16
Module READY	X0

External power supply READY flag (CH1 to CH8)/(CH9 to CH16)

■Device number

The following shows the device number of this input signal.

Signal name	CH1 to CH8	CH9 to CH16
External power supply READY flag (CH1 to CH8)	X7	—
External power supply READY flag (CH9 to CH16)	—	X17

Point

Two external power supplies are provided for the R60DA16-G. One is for CH1 to CH8 and the other is for CH9 to CH16. The status of each external power supply (the power is being supplied or not) is indicated by 'External power supply READY flag (CH1 to CH8)' (X7) and 'External power supply READY flag (CH9 to CH16)' (X17).

The following shows examples of CH1 to CH8. When using CH9 to CH16, regard X7 as X17.

■When the external power supply is off, or when 200ms has not yet elapsed after the power-on

'External power supply READY flag (CH1 to CH8)' (X7) remains off and the D/A conversion processing is not performed.

In this case, the analog output value is 0V/0mA.

■When the external power supply is turned off and on

After 200ms, 'External power supply READY flag (CH1 to CH8)' (X7) turns on. The D/A conversion is started on the channels where the D/A conversion is enabled.

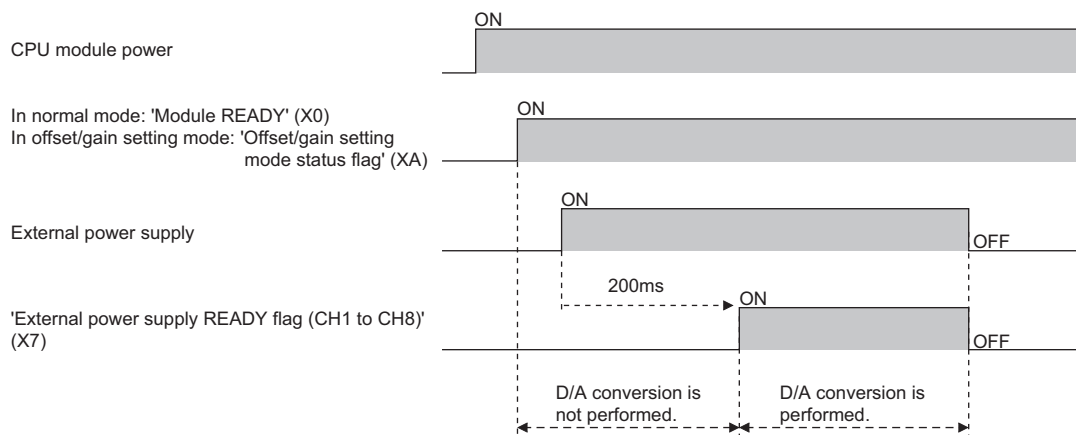

■When the external power supply is turned on and off

'External power supply READY flag (CH1 to CH8)' (X7) turns off and the D/A conversion processing stops.

In this case, the analog output value is 0V/0mA.

When the external power supply is turned off and on again, 'External power supply READY flag (CH1 to CH8)' (X7) turns on after 200ms as described above and the D/A conversion is restarted.

■Precautions

Use the external power supply that satisfies the specifications described in the performance specifications. Otherwise, 'External power supply READY flag (CH1 to CH8)' (X7) does not turn on. For the performance specifications, refer to the following.

📖 MELSEC iQ-R Channel Isolated Digital-Analog Converter Module User's Manual (Startup)

Operating condition setting completed flag

■Device number

The following shows the device number of this input signal.

Signal name	CH1 to CH16
Operating condition setting completed flag	X9

When changing the settings, use 'Operating condition setting completed flag' (X9) as an interlock condition to turn on and off 'Operating condition setting request' (Y9).

For the buffer memory addresses which require turning on and off of 'Operating condition setting request' (Y9) to enable the changed values, refer to the following.

☞ Page 89 List of buffer memory addresses

In the following state, 'Operating condition setting completed flag' (X9) turns off.

- When 'Operating condition setting request' (Y9) is on

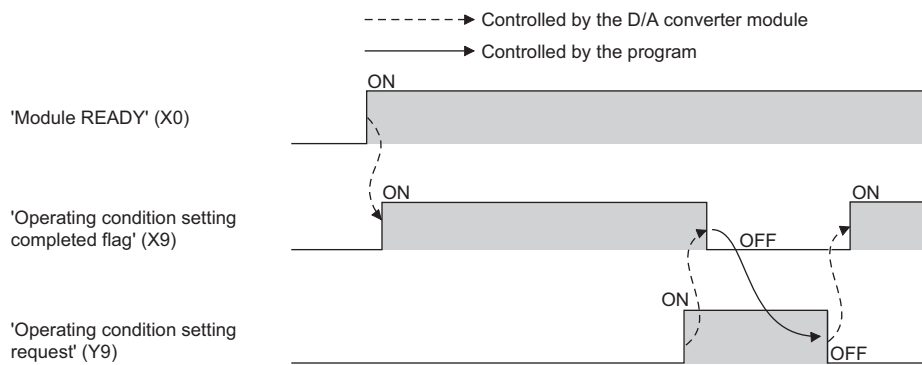

Offset/gain setting mode status flag

■Device number

The following shows the device number of this input signal.

Signal name	CH1 to CH16
Offset/gain setting mode status flag	XA

■In the offset/gain setting mode

When registering the value that has been adjusted with the offset/gain setting, use this flag as an interlock condition to turn on and off 'User range write request' (YA).

When the offset/gain setting is configured from the offset/gain setting window of an engineering tool, the setting is performed properly on the window. Therefore, a program is not required to perform the setting.

When a sequence program used for the MELSEC-Q series D/A converter module is utilized to configure the offset/gain setting, check that this flag is used as an interlock.

For the sequence programs for the MELSEC-Q series D/A converter module, refer to the following.

📖 Channel Isolated Digital-Analog Converter Module User's Manual

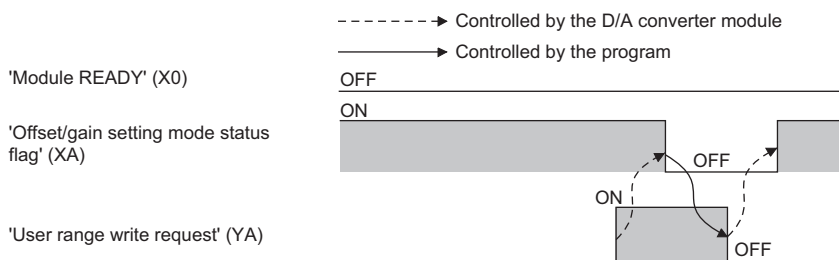

■In the normal mode

When restoring the user range setting, use this flag as an interlock condition to turn on and off 'User range write request' (YA).

For user range setting restoration, refer to the following.

📖 Page 52 Backing up, Saving, and Restoring Offset/Gain Values

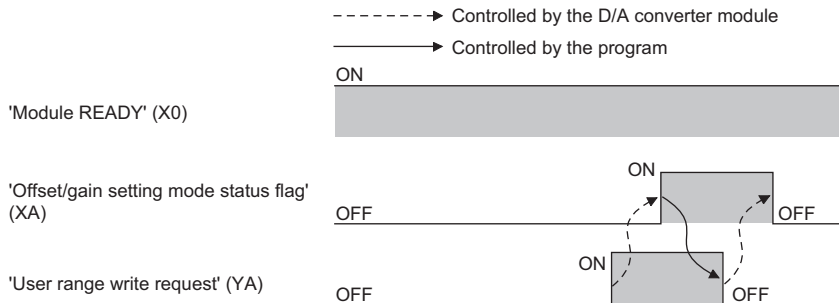

Channel change completed flag

When changing a channel to perform the offset/gain setting, use 'Channel change completed flag' (XB) as an interlock condition to turn on and off 'Channel change request' (YB).

When the offset/gain setting is configured from the offset/gain setting window of an engineering tool, the setting is performed properly on the window. Therefore, a program is not required to perform the setting.

When a sequence program used for the MELSEC-Q series D/A converter module is utilized to configure the offset/gain setting, check that this flag is used as an interlock.

For the sequence programs for the MELSEC-Q series D/A converter module, refer to the following.

Channel Isolated Digital-Analog Converter Module User's Manual

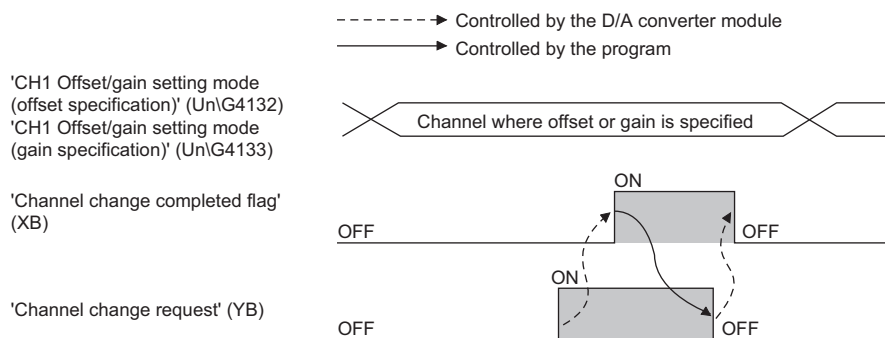

Device number

The following shows the device number of this input signal.

Signal name	CH1 to CH16
Channel change completed flag	XB

Set value change completed flag

When adjusting the offset/gain setting, use 'Set value change completed flag' (XC) as an interlock condition to turn on and off 'Value change request' (YC).

When the offset/gain setting is configured from the offset/gain setting window of an engineering tool, the setting is performed properly on the window. Therefore, a program is not required to perform the setting.

When a sequence program used for the MELSEC-Q series D/A converter module is utilized to configure the offset/gain setting, check that this flag is used as an interlock.

For the sequence programs for the MELSEC-Q series D/A converter module, refer to the following.

Channel Isolated Digital-Analog Converter Module User's Manual

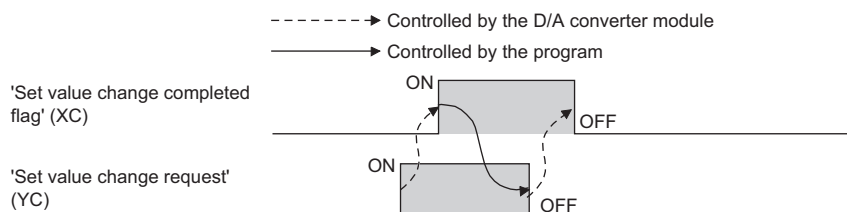

Device number

The following shows the device number of this input signal.

Signal name	CH1 to CH16
Set value change completed flag	XC

When the external power supply is off

'Set value change completed flag' (XC) does not turn on. Turn on the external power supply, and turn on and off 'Value change request' (YC) again.

A

Disconnection detection signal

'Disconnection detection signal' (XD) turns on when a disconnection is detected in any channels where the disconnection detection function is enabled.

'Disconnection detection signal' (XD) turns off by turning on and off 'Error clear request' (YF) or 'Operating condition setting request' (Y9) after the cause of the disconnection is eliminated.

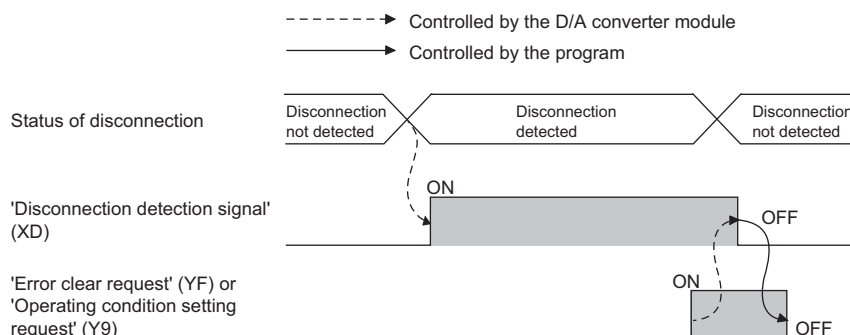

When 'CH1 Disconnection detection auto-clear enable/disable setting' (Un\G561) is Enable (1), however, if any other disconnections have not occurred until the disconnection detection auto-clear check monitoring time for channel 1*¹ elapses, 'Disconnection detection signal' (XD) automatically turns off.

*1 CH1 Disconnection detection auto-clear check monitoring time (time taken until the disconnection detection for channel 1 is automatically cleared) is calculated with the following formula.

$$\text{CH1 Disconnection detection auto-clear check monitoring time} = \text{'CH1 Number of disconnection detection auto-clear checks' (Un\G562)} \times (\text{Number of D/A conversion enabled channels} \times \text{Conversion speed (1ms/CH)})$$

Device number

The following shows the device number of this input signal.

Signal name	CH1 to CH16
Disconnection detection signal	XD

Alert output signal

Alert output signal turns on when the value in 'CH1 Digital value' (Un\G460) is larger than the value in 'CH1 Alert output upper limit value' (Un\G510) or is smaller than the value in 'CH1 Alert output lower limit value' (Un\G512) while the D/A conversion is enabled.

By turning on and off 'Alert output clear request' (YE) or 'Operating condition setting request' (Y9) after the cause of the alert is eliminated, 'Alert output signal' (XE) turns off and 'Latest alarm code' (Un\G2) is cleared.

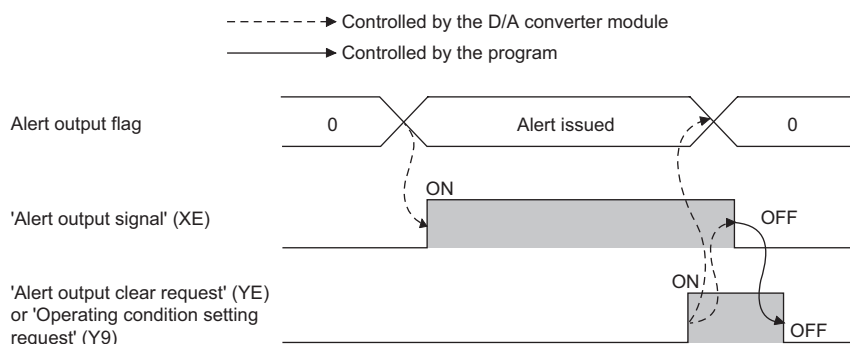

Device number

The following shows the device number of this input signal.

Signal name	CH1 to CH16
Alert output signal	XE

Error flag

'Error flag' (XF) turns on when an error occurs.

By turning on and off 'Error clear request' (YF) after the cause of the error is eliminated, 'Error flag' (XF) turns off and 'Latest error code' (Un\G0) is cleared.

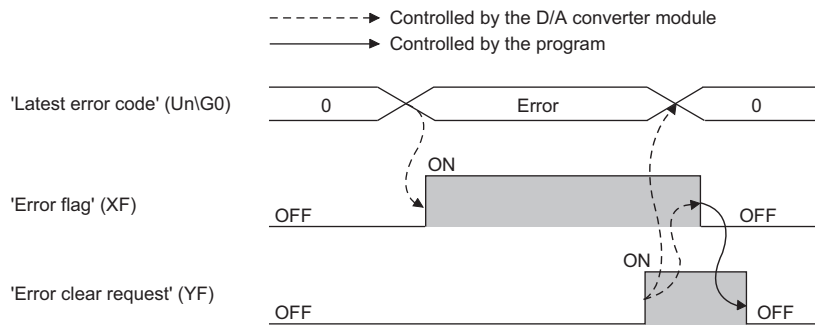

■ Device number

The following shows the device number of this input signal.

Signal name	CH1 to CH16
Error flag	XF

Details of output signals

The following describes the details of the output signals for the D/A converter module which are assigned to the CPU module. The I/O numbers (X/Y) described in Appendix 2 are for the case when the start I/O number of the D/A converter module is set to 0.

Point

This section describes I/O signals and buffer memory addresses for CH1.

For details on the buffer memory addresses after CH2, refer to the following.

☞ Page 89 List of buffer memory addresses

CH1 Output enable/disable flag

Set whether to output the D/A conversion value or offset value.

On: D/A conversion value

Off: Offset value

Device number

The following shows the device number of this output signal.

- CH□ Output enable/disable flag

CH1	CH2	CH3	CH4	CH5	CH6	CH7	CH8	CH9	CH10	CH11	CH12	CH13	CH14	CH15	CH16
Y1	Y2	Y3	Y4	Y5	Y6	Y7	Y8	Y11*1	Y12*1	Y13*1	Y14*1	Y15*1	Y16*1	Y17*1	Y18*1

*1 For the R60DA8-G, only Y0 to YF are available because the number of I/O points is 16.

Operating condition setting request

Turn on and off Operating condition setting request to enable the setting of the D/A converter module.

For the timing of turning the signal on and off, refer to the following.

☞ Page 81 Operating condition setting completed flag

For details on the buffer memory areas to be enabled, refer to the following.

☞ Page 89 List of buffer memory addresses

Device number

The following shows the device number of this output signal.

Signal name	CH1 to CH16
Operating condition setting request	Y9

User range write request

■Device number

The following shows the device number of this output signal.

Signal name	CH1 to CH16
User range write request	YA

■In the offset/gain setting mode

Turn on and off User range write request to register values adjusted with the offset/gain setting in the D/A converter module. The data is written to the flash memory when this signal is turned off and on.

For the timing of turning the signal on and off, refer to the following.

☞ Page 82 In the offset/gain setting mode

■In the normal mode

Turn on and off User range write request (YA) to restore the user range.

For the timing of turning the signal on and off, refer to the following.

☞ Page 82 In the normal mode

Channel change request

Turn on and off Channel change request (YB) to change a channel to perform the offset/gain setting.

For the timing of turning the signal on and off, refer to the following.

☞ Page 83 Channel change completed flag

■Device number

The following shows the device number of this output signal.

Signal name	CH1 to CH16
Channel change request	YB

Value change request

Turn on and off Value change request (YC) to change the analog output value to adjust the offset/gain setting.

The analog output value increases or decreases depending on the value set for 'Offset/gain adjustment value specification' (Un\G4130).

For the timing of turning the signal on and off, refer to the following.

☞ Page 83 Set value change completed flag

■Device number

The following shows the device number of this output signal.

Signal name	CH1 to CH16
Value change request	YC

Alert output clear request

Turn on and off 'Alert output clear request' (YE) to clear 'Alert output signal' (XE) and 'Latest alarm code' (Un\G2).
For the timing of turning the signal on and off, refer to the following.

 Page 84 Alert output signal

■Device number

The following shows the device number of this output signal.

Signal name	CH1 to CH16
Alert output clear request	YE

Error clear request

Turn on and off 'Error clear request' (YF) to clear 'Error flag' (XF), 'Disconnection detection signal' (XD), and 'Latest error code' (Un\G0).

For the timing of turning the signal on and off, refer to the following.

 Page 85 Error flag

■Device number

The following shows the device number of this output signal.

Signal name	CH1 to CH16
Error clear request	YF

Appendix 3 Buffer Memory Areas

List of buffer memory addresses

The following table lists the buffer memory addresses of the D/A converter module.

For details on the buffer memory addresses, refer to the following.

-  Page 104 Details of buffer memory addresses

The buffer memory areas of the D/A converter module are classified by the following data types.

Data type	Description	
Setting data	Description	Set this data according to the connected device and the use of the system.
	Write/read attribute	Data can be read and written from/to this area.
	Setting procedure	Set this data using an engineering tool or in a program.
	Setting timing	After changing the values, turn on and off 'Operating condition setting request' (Y9) to enable the set values.
Control data	Description	Use this data to control the D/A converter module.
	Write/read attribute	Data can be read and written from/to this area.
	Setting procedure	Set this data using an engineering tool or in a program.
	Setting timing	As soon as the values are changed, the set values become enabled.
Monitor data	Description	Use this data to monitor the status of the D/A converter module.
	Write/read attribute	Writing data is only allowed. Reading data is not allowed.
	Setting procedure	—
	Setting timing	—
User range setting data	Description	Use this data to update the user range setting of the D/A converter module.
	Write/read attribute	Data can be read and written from/to this area.
	Setting procedure	Set this data using an engineering tool or in a program.
	Setting timing	After changing the values, turn on and off 'User range write request' (YA) to enable the set values.

Point

- Do not write data to the system areas and areas whose data types are monitor in the buffer memory. Writing data into these areas can cause the malfunction of the module.
- When the R60DA8-G is used, the areas corresponding to CH9 to CH16 are used as system areas.

A

In R mode

■Un\G0 to Un\G399

Address (decimal)	Address (hexadecimal)	Name	Default value	Data type	Auto refresh
0	0H	Latest error code	0	Monitor	○
1	1H	Latest address of error history	0	Monitor	○
2	2H	Latest alarm code	0	Monitor	○
3	3H	Latest address of alarm history	0	Monitor	○
4 to 19	4H to 13H	Interrupt factor detection flag [n] ¹	0	Monitor	○
20 to 35	14H to 23H	System area	—	—	—
36	24H	Alert output upper limit flag	0000H	Monitor	○
37	25H	Alert output lower limit flag	0000H	Monitor	○
38	26H	Disconnection detection flag	0000H	Monitor	○
39 to 123	27H to 7BH	System area	—	—	—
124 to 139	7CH to 8BH	Interrupt factor mask [n] ¹	0	Control	×
140 to 155	8CH to 9BH	System area	—	—	—
156 to 171	9CH to ABH	Interrupt factor reset request [n] ¹	0	Control	×
172 to 199	ACH to C7H	System area	—	—	—
200 to 215	C8H to D7H	Interrupt factor generation setting [n] ¹	0	Setting	×
216 to 231	D8H to E7H	System area	—	—	—

Address (decimal)	Address (hexadecimal)	Name	Default value	Data type	Auto refresh
232 to 247	E8H to F7H	Condition target setting [n] ^{*1}	0	Setting	×
248 to 263	F8H to 107H	System area	—	—	—
264 to 279	108H to 117H	Condition target channel setting [n] ^{*1}	0	Setting	×
280 to 295	118H to 127H	System area	—	—	—
296, 297	128H, 129H	Mode switching setting	0	Setting	×
298 to 399	12AH to 18FH	System area	—	—	—

*1 [n] in the table indicates an interrupt setting number. (n = 1 to 16)

■Un\G400 to Un\G3599

Address Decimal (hexadecimal)								Name	Default value	Data type	Auto refresh
CH1	CH2	CH3	CH4	CH5	CH6	CH7	CH8	CH□ Setting value check code	0	Monitor	○
400 (190H)	600 (258H)	800 (320H)	1000 (3E8H)	1200 (4B0H)	1400 (578H)	1600 (640H)	1800 (708H)				
CH9	CH10	CH11	CH12	CH13	CH14	CH15	CH16				
2000 (7D0H)	2200 (898H)	2400 (960H)	2600 (A28H)	2800 (AF0H)	3000 (BB8H)	3200 (C80H)	3400 (D48H)				
CH1	CH2	CH3	CH4	CH5	CH6	CH7	CH8	System area	—	—	—
401 to 429 (191H to 1ADH)	601 to 629 (259H to 275H)	801 to 829 (321H to 33DH)	1001 to 1029 (3E9H to 405H)	1201 to 1229 (4B1H to 4CDH)	1401 to 1429 (579H to 595H)	1601 to 1629 (641H to 65DH)	1801 to 1829 (709H to 725H)				
CH9	CH10	CH11	CH12	CH13	CH14	CH15	CH16				
2001 to 2029 (7D1H to 7EDH)	2201 to 2229 (899H to 8B5H)	2401 to 2429 (961H to 97DH)	2601 to 2629 (A29H to A45H)	2801 to 2829 (AF1H to B0DH)	3001 to 3029 (BB9H to BD5H)	3201 to 3229 (C81H to C9DH)	3401 to 3429 (D49H to D65H)				
CH1	CH2	CH3	CH4	CH5	CH6	CH7	CH8	CH□ Range setting monitor	0000H	Monitor	×
430 (1AEH)	630 (276H)	830 (33EH)	1030 (406H)	1230 (4CEH)	1430 (596H)	1630 (65EH)	1830 (726H)				
CH9	CH10	CH11	CH12	CH13	CH14	CH15	CH16				
2030 (7EEH)	2230 (8B6H)	2430 (97EH)	2630 (A46H)	2830 (B0EH)	3030 (BD6H)	3230 (C9EH)	3430 (D66H)				
CH1	CH2	CH3	CH4	CH5	CH6	CH7	CH8	CH□ HOLD/CLEAR function setting monitor	0	Monitor	×
431 (1AFH)	631 (277H)	831 (33FH)	1031 (407H)	1231 (4CFH)	1431 (597H)	1631 (65FH)	1831 (727H)				
CH9	CH10	CH11	CH12	CH13	CH14	CH15	CH16				
2031 (7EFH)	2231 (8B7H)	2431 (97FH)	2631 (A47H)	2831 (B0FH)	3031 (BD7H)	3231 (C9FH)	3431 (D67H)				
CH1	CH2	CH3	CH4	CH5	CH6	CH7	CH8	System area	—	—	—
432 to 459 (1B0H to 1CBH)	632 to 659 (278H to 293H)	832 to 859 (340H to 35BH)	1032 to 1059 (408H to 423H)	1232 to 1259 (4D0H to 4EBH)	1432 to 1459 (598H to 5B3H)	1632 to 1659 (660H to 67BH)	1832 to 1859 (728H to 743H)				
CH9	CH10	CH11	CH12	CH13	CH14	CH15	CH16				
2032 to 2059 (7F0H to 80BH)	2232 to 2259 (8B8H to 8D3H)	2432 to 2459 (980H to 99BH)	2632 to 2659 (A48H to A63H)	2832 to 2859 (B10H to B2BH)	3032 to 3059 (BD8H to BF3H)	3232 to 3259 (CA0H to CBBH)	3432 to 3459 (D68H to D83H)				
CH1	CH2	CH3	CH4	CH5	CH6	CH7	CH8	CH□ Digital value	0	Control	○
460 (1CCH)	660 (294H)	860 (35CH)	1060 (424H)	1260 (4ECH)	1460 (5B4H)	1660 (67CH)	1860 (744H)				
CH9	CH10	CH11	CH12	CH13	CH14	CH15	CH16				
2060 (80CH)	2260 (8D4H)	2460 (99CH)	2660 (A64H)	2860 (B2CH)	3060 (BF4H)	3260 (CBCH)	3460 (D84H)				
CH1	CH2	CH3	CH4	CH5	CH6	CH7	CH8	System area	—	—	—
461 to 479 (1CDH to 1DFH)	661 to 679 (295H to 2A7H)	861 to 879 (35DH to 36FH)	1061 to 1079 (425H to 437H)	1261 to 1279 (4EDH to 4FFH)	1461 to 1479 (5B5H to 5C7H)	1661 to 1679 (67DH to 68FH)	1861 to 1879 (745H to 757H)				
CH9	CH10	CH11	CH12	CH13	CH14	CH15	CH16				
2061 to 2079 (80DH to 81FH)	2261 to 2279 (8D5H to 8E7H)	2461 to 2479 (99DH to 9AFH)	2661 to 2679 (A65H to A77H)	2861 to 2879 (B2DH to B3FH)	3061 to 3079 (BF5H to C07H)	3261 to 3279 (CBDH to CCFH)	3461 to 3479 (D85H to D97H)				

Address Decimal (hexadecimal)								Name	Default value	Data type	Auto refresh
CH1	CH2	CH3	CH4	CH5	CH6	CH7	CH8	CH□ Input value shift amount	0	Control	×
480 (1E0H)	680 (2A8H)	880 (370H)	1080 (438H)	1280 (500H)	1480 (5C8H)	1680 (690H)	1880 (758H)				
CH9	CH10	CH11	CH12	CH13	CH14	CH15	CH16				
2080 (820H)	2280 (8E8H)	2480 (9B0H)	2680 (A78H)	2880 (B40H)	3080 (C08H)	3280 (CD0H)	3480 (D98H)				
CH1	CH2	CH3	CH4	CH5	CH6	CH7	CH8	System area	—	—	—
481 to 499 (1E1H to 1F3H)	681 to 699 (2A9H to 2BBH)	881 to 899 (371H to 383H)	1081 to 1099 (439H to 44BH)	1281 to 1299 (501H to 513H)	1481 to 1499 (5C9H to 5DBH)	1681 to 1699 (691H to 6A3H)	1881 to 1899 (759H to 76BH)				
CH9	CH10	CH11	CH12	CH13	CH14	CH15	CH16				
2081 to 2099 (821H to 833H)	2281 to 2299 (8E9H to 8FBH)	2481 to 2499 (9B1H to 9C3H)	2681 to 2699 (A79H to A8BH)	2881 to 2899 (B41H to B53H)	3081 to 3099 (C09H to C1BH)	3281 to 3299 (CD1H to CE3H)	3481 to 3499 (D99H to DABH)				
CH1	CH2	CH3	CH4	CH5	CH6	CH7	CH8	CH□ D/A conversion enable/disable setting	1	Setting	×
500 (1F4H)	700 (2BCH)	900 (384H)	1100 (44CH)	1300 (514H)	1500 (5DCH)	1700 (6A4H)	1900 (76CH)				
CH9	CH10	CH11	CH12	CH13	CH14	CH15	CH16				
2100 (834H)	2300 (8FCH)	2500 (9C4H)	2700 (A8CH)	2900 (B54H)	3100 (C1CH)	3300 (CE4H)	3500 (DACH)				
CH1	CH2	CH3	CH4	CH5	CH6	CH7	CH8	System area	—	—	—
501 (1F5H)	701 (2BDH)	901 (385H)	1101 (44DH)	1301 (515H)	1501 (5DDH)	1701 (6A5H)	1901 (76DH)				
CH9	CH10	CH11	CH12	CH13	CH14	CH15	CH16				
2101 (835H)	2301 (8FDH)	2501 (9C5H)	2701 (A8DH)	2901 (B55H)	3101 (C1DH)	3301 (CE5H)	3501 (DADH)				
CH1	CH2	CH3	CH4	CH5	CH6	CH7	CH8	CH□ Scaling enable/disable setting	1	Setting	×
502 (1F6H)	702 (2BEH)	902 (386H)	1102 (44EH)	1302 (516H)	1502 (5DEH)	1702 (6A6H)	1902 (76EH)				
CH9	CH10	CH11	CH12	CH13	CH14	CH15	CH16				
2102 (836H)	2302 (8FEH)	2502 (9C6H)	2702 (A8EH)	2902 (B56H)	3102 (C1EH)	3302 (CE6H)	3502 (DAEH)				
CH1	CH2	CH3	CH4	CH5	CH6	CH7	CH8	System area	—	—	—
503 (1F7H)	703 (2BFH)	903 (387H)	1103 (44FH)	1303 (517H)	1503 (5DFH)	1703 (6A7H)	1903 (76FH)				
CH9	CH10	CH11	CH12	CH13	CH14	CH15	CH16				
2103 (837H)	2303 (8FFH)	2503 (9C7H)	2703 (A8FH)	2903 (B57H)	3103 (C1FH)	3303 (CE7H)	3503 (DAFH)				
CH1	CH2	CH3	CH4	CH5	CH6	CH7	CH8	CH□ Scaling upper limit value	0	Setting	×
504 (1F8H)	704 (2C0H)	904 (388H)	1104 (450H)	1304 (518H)	1504 (5E0H)	1704 (6A8H)	1904 (770H)				
CH9	CH10	CH11	CH12	CH13	CH14	CH15	CH16				
2104 (838H)	2304 (900H)	2504 (9C8H)	2704 (A90H)	2904 (B58H)	3104 (C20H)	3304 (CE8H)	3504 (DB0H)				
CH1	CH2	CH3	CH4	CH5	CH6	CH7	CH8	System area	—	—	—
505 (1F9H)	705 (2C1H)	905 (389H)	1105 (451H)	1305 (519H)	1505 (5E1H)	1705 (6A9H)	1905 (771H)				
CH9	CH10	CH11	CH12	CH13	CH14	CH15	CH16				
2105 (839H)	2305 (901H)	2505 (9C9H)	2705 (A91H)	2905 (B59H)	3105 (C21H)	3305 (CE9H)	3505 (DB1H)				
CH1	CH2	CH3	CH4	CH5	CH6	CH7	CH8	CH□ Scaling lower limit value	0	Setting	×
506 (1FAH)	706 (2C2H)	906 (38AH)	1106 (452H)	1306 (51AH)	1506 (5E2H)	1706 (6AAH)	1906 (772H)				
CH9	CH10	CH11	CH12	CH13	CH14	CH15	CH16				
2106 (83AH)	2306 (902H)	2506 (9CAH)	2706 (A92H)	2906 (B5AH)	3106 (C22H)	3306 (CEAH)	3506 (DB2H)				

Address Decimal (hexadecimal)								Name	Default value	Data type	Auto refresh
CH1	CH2	CH3	CH4	CH5	CH6	CH7	CH8	System area	—	—	—
507 (1FBH)	707 (2C3H)	907 (38BH)	1107 (453H)	1307 (51BH)	1507 (5E3H)	1707 (6ABH)	1907 (773H)				
CH9	CH10	CH11	CH12	CH13	CH14	CH15	CH16				
2107 (83BH)	2307 (903H)	2507 (9CBH)	2707 (A93H)	2907 (B5BH)	3107 (C23H)	3307 (CEBH)	3507 (DB3H)				
CH1	CH2	CH3	CH4	CH5	CH6	CH7	CH8	CH□ Alert output setting	1	Setting	×
508 (1FCH)	708 (2C4H)	908 (38CH)	1108 (454H)	1308 (51CH)	1508 (5E4H)	1708 (6ACH)	1908 (774H)				
CH9	CH10	CH11	CH12	CH13	CH14	CH15	CH16				
2108 (83CH)	2308 (904H)	2508 (9CCH)	2708 (A94H)	2908 (B5CH)	3108 (C24H)	3308 (CECH)	3508 (DB4H)				
CH1	CH2	CH3	CH4	CH5	CH6	CH7	CH8	CH□ Rate control enable/disable setting	1	Setting	×
509 (1FDH)	709 (2C5H)	909 (38DH)	1109 (455H)	1309 (51DH)	1509 (5E5H)	1709 (6ADH)	1909 (775H)				
CH9	CH10	CH11	CH12	CH13	CH14	CH15	CH16				
2109 (83DH)	2309 (905H)	2509 (9CDH)	2709 (A95H)	2909 (B5DH)	3109 (C25H)	3309 (CEDH)	3509 (DB5H)				
CH1	CH2	CH3	CH4	CH5	CH6	CH7	CH8	CH□ Alert output upper limit value	0	Setting	×
510 (1FEH)	710 (2C6H)	910 (38EH)	1110 (456H)	1310 (51EH)	1510 (5E6H)	1710 (6AEH)	1910 (776H)				
CH9	CH10	CH11	CH12	CH13	CH14	CH15	CH16				
2110 (83EH)	2310 (906H)	2510 (9CEH)	2710 (A96H)	2910 (B5EH)	3110 (C26H)	3310 (CEEH)	3510 (DB6H)				
CH1	CH2	CH3	CH4	CH5	CH6	CH7	CH8	System area	—	—	—
511 (1FFH)	711 (2C7H)	911 (38FH)	1111 (457H)	1311 (51FH)	1511 (5E7H)	1711 (6AFH)	1911 (777H)				
CH9	CH10	CH11	CH12	CH13	CH14	CH15	CH16				
2111 (83FH)	2311 (907H)	2511 (9CFH)	2711 (A97H)	2911 (B5FH)	3111 (C27H)	3311 (CEFH)	3511 (DB7H)				
CH1	CH2	CH3	CH4	CH5	CH6	CH7	CH8	CH□ Alert output lower limit value	0	Setting	×
512 (200H)	712 (2C8H)	912 (390H)	1112 (458H)	1312 (520H)	1512 (5E8H)	1712 (6B0H)	1912 (778H)				
CH9	CH10	CH11	CH12	CH13	CH14	CH15	CH16				
2112 (840H)	2312 (908H)	2512 (9D0H)	2712 (A98H)	2912 (B60H)	3112 (C28H)	3312 (CF0H)	3512 (DB8H)				
CH1	CH2	CH3	CH4	CH5	CH6	CH7	CH8	System area	—	—	—
513 (201H)	713 (2C9H)	913 (391H)	1113 (459H)	1313 (521H)	1513 (5E9H)	1713 (6B1H)	1913 (779H)				
CH9	CH10	CH11	CH12	CH13	CH14	CH15	CH16				
2113 (841H)	2313 (909H)	2513 (9D1H)	2713 (A99H)	2913 (B61H)	3113 (C29H)	3313 (CF1H)	3513 (DB9H)				
CH1	CH2	CH3	CH4	CH5	CH6	CH7	CH8	CH□ Increase digital limit value	64000	Setting	×
514 (202H)	714 (2CAH)	914 (392H)	1114 (45AH)	1314 (522H)	1514 (5EAH)	1714 (6B2H)	1914 (77AH)				
CH9	CH10	CH11	CH12	CH13	CH14	CH15	CH16				
2114 (842H)	2314 (90AH)	2514 (9D2H)	2714 (A9AH)	2914 (B62H)	3114 (C2AH)	3314 (CF2H)	3514 (DBAH)				
CH1	CH2	CH3	CH4	CH5	CH6	CH7	CH8	System area	—	—	—
515 (203H)	715 (2CBH)	915 (393H)	1115 (45BH)	1315 (523H)	1515 (5EBH)	1715 (6B3H)	1915 (77BH)				
CH9	CH10	CH11	CH12	CH13	CH14	CH15	CH16				
2115 (843H)	2315 (90BH)	2515 (9D3H)	2715 (A9BH)	2915 (B63H)	3115 (C2BH)	3315 (CF3H)	3515 (DBBH)				

A

Address Decimal (hexadecimal)								Name	Default value	Data type	Auto refresh
CH1	CH2	CH3	CH4	CH5	CH6	CH7	CH8	CH□ Decrease digital limit value	64000	Setting	×
516 (204H)	716 (2CCH)	916 (394H)	1116 (45CH)	1316 (524H)	1516 (5ECH)	1716 (6B4H)	1916 (77CH)				
CH9	CH10	CH11	CH12	CH13	CH14	CH15	CH16				
2116 (844H)	2316 (90CH)	2516 (9D4H)	2716 (A9CH)	2916 (B64H)	3116 (C2CH)	3316 (CF4H)	3516 (DBCH)				
CH1	CH2	CH3	CH4	CH5	CH6	CH7	CH8	System area	—	—	—
517 to 557 (205H to 22DH)	717 to 757 (2CDH to 2F5H)	917 to 957 (395H to 3BDH)	1117 to 1157 (45DH to 485H)	1317 to 1357 (525H to 54DH)	1517 to 1557 (5EDH to 615H)	1717 to 1757 (6B5H to 6DDH)	1917 to 1957 (77DH to 7A5H)				
CH9	CH10	CH11	CH12	CH13	CH14	CH15	CH16				
2117 to 2157 (845H to 86DH)	2317 to 2357 (90DH to 935H)	2517 to 2557 (9D5H to 9FDH)	2717 to 2757 (A9DH to AC5H)	2917 to 2957 (B65H to B8DH)	3117 to 3157 (C2DH to C55H)	3317 to 3357 (CF5H to D1DH)	3517 to 3557 (DBDH to DE5H)				
CH1	CH2	CH3	CH4	CH5	CH6	CH7	CH8	CH□ Disconnection detection enable/disable setting	0	Setting	×
558 (22EH)	758 (2F6H)	958 (3BEH)	1158 (486H)	1358 (54EH)	1558 (616H)	1758 (6DEH)	1958 (7A6H)				
CH9	CH10	CH11	CH12	CH13	CH14	CH15	CH16				
2158 (86EH)	2358 (936H)	2558 (9FEH)	2758 (AC6H)	2958 (B8EH)	3158 (C56H)	3358 (D1EH)	3558 (DE6H)				
CH1	CH2	CH3	CH4	CH5	CH6	CH7	CH8	CH□ Disconnection detection (extended mode) enable/disable setting	0	Setting	×
559 (22FH)	759 (2F7H)	959 (3BFH)	1159 (487H)	1359 (54FH)	1559 (617H)	1759 (6DFH)	1959 (7A7H)				
CH9	CH10	CH11	CH12	CH13	CH14	CH15	CH16				
2159 (86FH)	2359 (937H)	2559 (9FFH)	2759 (AC7H)	2959 (B8FH)	3159 (C57H)	3359 (D1FH)	3559 (DE7H)				
CH1	CH2	CH3	CH4	CH5	CH6	CH7	CH8	CH□ Number of disconnection checks	1	Setting	×
560 (230H)	760 (2F8H)	960 (3C0H)	1160 (488H)	1360 (550H)	1560 (618H)	1760 (6E0H)	1960 (7A8H)				
CH9	CH10	CH11	CH12	CH13	CH14	CH15	CH16				
2160 (870H)	2360 (938H)	2560 (A00H)	2760 (AC8H)	2960 (B90H)	3160 (C58H)	3360 (D20H)	3560 (DE8H)				
CH1	CH2	CH3	CH4	CH5	CH6	CH7	CH8	CH□ Disconnection detection auto-clear enable/disable setting	0	Setting	×
561 (231H)	761 (2F9H)	961 (3C1H)	1161 (489H)	1361 (551H)	1561 (619H)	1761 (6E1H)	1961 (7A9H)				
CH9	CH10	CH11	CH12	CH13	CH14	CH15	CH16				
2161 (871H)	2361 (939H)	2561 (A01H)	2761 (AC9H)	2961 (B91H)	3161 (C59H)	3361 (D21H)	3561 (DE9H)				
CH1	CH2	CH3	CH4	CH5	CH6	CH7	CH8	CH□ Number of disconnection detection auto-clear checks	100	Setting	×
562 (232H)	762 (2FAH)	962 (3C2H)	1162 (48AH)	1362 (552H)	1562 (61AH)	1762 (6E2H)	1962 (7AAH)				
CH9	CH10	CH11	CH12	CH13	CH14	CH15	CH16				
2162 (872H)	2362 (93AH)	2562 (A02H)	2762 (ACAH)	2962 (B92H)	3162 (C5AH)	3362 (D22H)	3562 (DEAH)				
CH1	CH2	CH3	CH4	CH5	CH6	CH7	CH8	System area	—	—	—
563 to 597 (233H to 255H)	763 to 797 (2FBH to 31DH)	963 to 997 (3C3H to 3E5H)	1163 to 1197 (48BH to 4ADH)	1363 to 1397 (553H to 575H)	1563 to 1597 (61BH to 63DH)	1763 to 1797 (6E3H to 705H)	1963 to 1997 (7ABH to 7CDH)				
CH9	CH10	CH11	CH12	CH13	CH14	CH15	CH16				
2163 to 2197 (873H to 895H)	2363 to 2397 (93BH to 95DH)	2563 to 2597 (A03H to A25H)	2763 to 2797 (ACBH to AEDH)	2963 to 2997 (B93H to BB5H)	3163 to 3197 (C5BH to C7DH)	3363 to 3397 (D23H to D45H)	3563 to 3597 (DEBH to E0DH)				

Address Decimal (hexadecimal)								Name	Default value	Data type	Auto refresh
CH1	CH2	CH3	CH4	CH5	CH6	CH7	CH8	CH□ Range setting	0	Setting	×
598 (256H)	798 (31EH)	998 (3E6H)	1198 (4AEH)	1398 (576H)	1598 (63EH)	1798 (706H)	1998 (7CEH)				
CH9	CH10	CH11	CH12	CH13	CH14	CH15	CH16				
2198 (896H)	2398 (95EH)	2598 (A26H)	2798 (AEEH)	2998 (BB6H)	3198 (C7EH)	3398 (D46H)	3598 (E0EH)				
CH1	CH2	CH3	CH4	CH5	CH6	CH7	CH8	System area	—	—	—
599 (257H)	799 (31FH)	999 (3E7H)	1199 (4AFH)	1399 (577H)	1599 (63FH)	1799 (707H)	1999 (7CFH)				
CH9	CH10	CH11	CH12	CH13	CH14	CH15	CH16				
2199 (897H)	2399 (95FH)	2599 (A27H)	2799 (AEFH)	2999 (BB7H)	3199 (C7FH)	3399 (D47H)	3599 (E0FH)				

■Error history (Un\G3600 to Un\G3759)

Address (decimal)	Address (hexadecimal)	Name			Default value	Data type	Auto refresh	
3600	E10H	Error history 1	Error code			0	Monitor	×
3601	E11H		Error time	First two digits of the year	Last two digits of the year			
3602	E12H			Month	Day			
3603	E13H			Hour	Minute			
3604	E14H			Second	Day of the week			
3605	E15H			Millisecond				
3606 to 3609	E16H to E19H	System area			—	—	—	
3610 to 3615	E1AH to E1FH	Error history 2	Same as error history 1		0	Monitor	×	
3616 to 3619	E20H to E23H	System area			—	—	—	
3620 to 3625	E24H to E29H	Error history 3	Same as error history 1		0	Monitor	×	
3626 to 3629	E2A to E2DH	System area			—	—	—	
3630 to 3635	E2EH to E33H	Error history 4	Same as error history 1		0	Monitor	×	
3636 to 3639	E34H to E37H	System area			—	—	—	
3640 to 3645	E38H to E3DH	Error history 5	Same as error history 1		0	Monitor	×	
3646 to 3649	E3EH to E41H	System area			—	—	—	
3650 to 3655	E42H to E47H	Error history 6	Same as error history 1		0	Monitor	×	
3656 to 3659	E48H to E4BH	System area			—	—	—	
3660 to 3665	E4CH to E51H	Error history 7	Same as error history 1		0	Monitor	×	
3666 to 3669	E52H to E55H	System area			—	—	—	
3670 to 3675	E56H to E5BH	Error history 8	Same as error history 1		0	Monitor	×	
3676 to 3679	E5CH to E5FH	System area			—	—	—	
3680 to 3685	E60H to E65H	Error history 9	Same as error history 1		0	Monitor	×	
3686 to 3689	E66H to E69H	System area			—	—	—	
3690 to 3695	E6AH to E6FH	Error history 10	Same as error history 1		0	Monitor	×	
3696 to 3699	E70H to E73H	System area			—	—	—	
3700 to 3705	E74H to E79H	Error history 11	Same as error history 1		0	Monitor	×	
3706 to 3709	E7AH to E7DH	System area			—	—	—	
3710 to 3715	E7EH to E83H	Error history 12	Same as error history 1		0	Monitor	×	
3716 to 3719	E84H to E87H	System area			—	—	—	
3720 to 3725	E88H to E8DH	Error history 13	Same as error history 1		0	Monitor	×	
3726 to 3729	E8EH to E91H	System area			—	—	—	
3730 to 3735	E92H to E97H	Error history 14	Same as error history 1		0	Monitor	×	
3736 to 3739	E98H to E9BH	System area			—	—	—	
3740 to 3745	E9CH to EA1H	Error history 15	Same as error history 1		0	Monitor	×	
3746 to 3749	EA2H to EA5H	System area			—	—	—	
3750 to 3755	EA6H to EABH	Error history 16	Same as error history 1		0	Monitor	×	
3756 to 3759	EACH to EAFH	System area			—	—	—	

■ Alarm history (Un\G3760 to Un\G3999)

Address (decimal)	Address (hexadecimal)	Name	Default value	Data type	Auto refresh				
3760	EB0H	Alarm history 1	0	Monitor	×				
3761	EB1H					Alarm code	Alarm time	First two digits of the year	Last two digits of the year
3762	EB2H							Month	Day
3763	EB3H					Hour	Minute		
3764	EB4H					Second	Day of the week		
3765	EB5H					Millisecond			
3766 to 3769	EB6H to EB9H	System area	—	—	—				
3770 to 3775	EBAH to EBFH	Alarm history 2	Same as alarm history 1	0	Monitor	×			
3776 to 3779	EC0H to EC3H	System area	—	—	—				
3780 to 3785	EC4H to EC9H	Alarm history 3	Same as alarm history 1	0	Monitor	×			
3786 to 3789	ECAH to ECDH	System area	—	—	—				
3790 to 3795	ECEH to ED3H	Alarm history 4	Same as alarm history 1	0	Monitor	×			
3796 to 3799	ED4H to ED7H	System area	—	—	—				
3800 to 3805	ED8H to EDDH	Alarm history 5	Same as alarm history 1	0	Monitor	×			
3806 to 3809	EDEH to EE1H	System area	—	—	—				
3810 to 3815	EE2H to EE7H	Alarm history 6	Same as alarm history 1	0	Monitor	×			
3816 to 3819	EE8H to EEBH	System area	—	—	—				
3820 to 3825	EECH to EF1H	Alarm history 7	Same as alarm history 1	0	Monitor	×			
3826 to 3829	EF2H to EF5H	System area	—	—	—				
3830 to 3835	EF6H to EFBH	Alarm history 8	Same as alarm history 1	0	Monitor	×			
3836 to 3839	EFCH to EFFH	System area	—	—	—				
3840 to 3845	F00H to F05H	Alarm history 9	Same as alarm history 1	0	Monitor	×			
3846 to 3849	F06H to F09H	System area	—	—	—				
3850 to 3855	F0AH to F0FH	Alarm history 10	Same as alarm history 1	0	Monitor	×			
3856 to 3859	F10H to F13H	System area	—	—	—				
3860 to 3865	F14H to F19H	Alarm history 11	Same as alarm history 1	0	Monitor	×			
3866 to 3869	F1AH to F1DH	System area	—	—	—				
3870 to 3875	F1EH to F23H	Alarm history 12	Same as alarm history 1	0	Monitor	×			
3876 to 3879	F24H to F27H	System area	—	—	—				
3880 to 3885	F28H to F2DH	Alarm history 13	Same as alarm history 1	0	Monitor	×			
3886 to 3889	F2EH to F31H	System area	—	—	—				
3890 to 3895	F32H to F37H	Alarm history 14	Same as alarm history 1	0	Monitor	×			
3896 to 3899	F38H to F3BH	System area	—	—	—				
3900 to 3905	F3CH to F41H	Alarm history 15	Same as alarm history 1	0	Monitor	×			
3906 to 3909	F42H to F45H	System area	—	—	—				
3910 to 3915	F46H to F4BH	Alarm history 16	Same as alarm history 1	0	Monitor	×			
3916 to 3999	F4CH to F9FH	System area	—	—	—				

■Offset/gain setting (For the R60DA8-G) (Un\G4000 to Un\G4129)

Address Decimal (hexadecimal)								Name	Default value	Data type	Auto refresh
CH1	CH2	CH3	CH4	CH5	CH6	CH7	CH8				
4000, 4001 (FA0H, FA1H)								System area	—	—	—
4002 (FA2H)								Save data type setting	0000H	User range setting	×
4003 (FA3H)								System area	—	—	—
4004 (FA4H)	4006 (FA6H)	4008 (FA8H)	4010 (FAAH)	4012 (FACH)	4014 (FAEH)	4016 (FB0H)	4018 (FB2H)	CH□ Factory default setting offset value	0	User range setting	×
4005 (FA5H)	4007 (FA7H)	4009 (FA9H)	4011 (FABH)	4013 (FADH)	4015 (FAFH)	4017 (FB1H)	4019 (FB3H)	CH□ Factory default setting gain value	0	User range setting	×
4020 (FB4H)	4022 (FB6H)	4024 (FB8H)	4026 (FBAH)	4028 (FBCH)	4030 (FBEH)	4032 (FC0H)	4034 (FC2H)	CH□ User range setting offset value	0	User range setting	×
4021 (FB5H)	4023 (FB7H)	4025 (FB9H)	4027 (FBBH)	4029 (FBDH)	4031 (FBFH)	4033 (FC1H)	4035 (FC3H)	CH□ User range setting gain value	0	User range setting	×
4036 to 4129 (FC4H to 1021H)								System area	—	—	—

■Offset/gain setting (For the R60DA16-G) (Un\G4000 to Un\G4129)

Address Decimal (hexadecimal)								Name	Default value	Data type	Auto refresh
CH1	CH2	CH3	CH4	CH5	CH6	CH7	CH8				
CH1 to CH16								System area	—	—	—
4000, 4001 (FA0H, FA1H)								Save data type setting 1	0000H	User range setting	×
CH1 to CH8											
4002 (FA2H)								Save data type setting 2	0000H	User range setting	×
CH9 to CH16											
4003 (FA3H)								CH□ Factory default setting offset value	0	User range setting	×
CH1	CH2	CH3	CH4	CH5	CH6	CH7	CH8				
4004 (FA4H)	4006 (FA6H)	4008 (FA8H)	4010 (FAAH)	4012 (FACH)	4014 (FAEH)	4016 (FB0H)	4018 (FB2H)				
CH9	CH10	CH11	CH12	CH13	CH14	CH15	CH16				
4020 (FB4H)	4022 (FB6H)	4024 (FB8H)	4026 (FBAH)	4028 (FBCH)	4030 (FBEH)	4032 (FC0H)	4034 (FC2H)	CH□ Factory default setting gain value	0	User range setting	×
CH1	CH2	CH3	CH4	CH5	CH6	CH7	CH8				
4005 (FA5H)	4007 (FA7H)	4009 (FA9H)	4011 (FABH)	4013 (FADH)	4015 (FAFH)	4017 (FB1H)	4019 (FB3H)				
CH9	CH10	CH11	CH12	CH13	CH14	CH15	CH16				
4021 (FB5H)	4023 (FB7H)	4025 (FB9H)	4027 (FBBH)	4029 (FBDH)	4031 (FBFH)	4033 (FC1H)	4035 (FC3H)	CH□ User range setting offset value	0	User range setting	×
CH1	CH2	CH3	CH4	CH5	CH6	CH7	CH8				
4036 (FC4H)	4038 (FC6H)	4040 (FC8H)	4042 (FCAH)	4044 (FCCH)	4046 (FCEH)	4048 (FD0H)	4050 (FD2H)				
CH9	CH10	CH11	CH12	CH13	CH14	CH15	CH16				
4052 (FD4H)	4054 (FD6H)	4056 (FD8H)	4058 (FDAH)	4060 (FDCH)	4062 (FDEH)	4064 (FE0H)	4066 (FE2H)	CH□ User range setting gain value	0	User range setting	×
CH1	CH2	CH3	CH4	CH5	CH6	CH7	CH8				
4037 (FC5H)	4039 (FC7H)	4041 (FC9H)	4043 (FCBH)	4045 (FCDH)	4047 (FCFH)	4049 (FD1H)	4051 (FD3H)				
CH9	CH10	CH11	CH12	CH13	CH14	CH15	CH16				
4053 (FD5H)	4055 (FD7H)	4057 (FD9H)	4059 (FDBH)	4061 (FDDH)	4063 (FDFH)	4065 (FE1H)	4067 (FE3H)	System area	—	—	—
CH1 to CH16											
4068 to 4129 (FE4H to 1021H)											

■Un\G4130 to Un\G4199

Address Decimal (hexadecimal)								Name	Default value	Data type	Auto refresh
CH1 to CH16								Offset/gain adjustment value specification	0	Control	×
4130 (1022H)											
CH1 to CH16								System area	—	—	—
4131 (1023H)											
CH1	CH2	CH3	CH4	CH5	CH6	CH7	CH8	CH□ Offset/gain setting mode (offset specification)	0	Setting	×
4132 (1024H)	4134 (1026H)	4136 (1028H)	4138 (102AH)	4140 (102CH)	4142 (102EH)	4144 (1030H)	4146 (1032H)				
CH9	CH10	CH11	CH12	CH13	CH14	CH15	CH16				
4148 (1034H)	4150 (1036H)	4152 (1038H)	4154 (103AH)	4156 (103CH)	4158 (103EH)	4160 (1040H)	4162 (1042H)				
CH1	CH2	CH3	CH4	CH5	CH6	CH7	CH8				
4133 (1025H)	4135 (1027H)	4137 (1029H)	4139 (102BH)	4141 (102DH)	4143 (102FH)	4145 (1031H)	4147 (1033H)	CH□ Offset/gain setting mode (gain specification)	0	Setting	×
CH9	CH10	CH11	CH12	CH13	CH14	CH15	CH16				
4149 (1035H)	4151 (1037H)	4153 (1039H)	4155 (103BH)	4157 (103DH)	4159 (103FH)	4161 (1041H)	4163 (1043H)				
CH1	CH2	CH3	CH4	CH5	CH6	CH7	CH8				
4164 (1044H)	4165 (1045H)	4166 (1046H)	4167 (1047H)	4168 (1048H)	4169 (1049H)	4170 (104AH)	4171 (104BH)				
CH9	CH10	CH11	CH12	CH13	CH14	CH15	CH16	CH□ Offset/gain setting mode (range specification)	0	Setting	×
4172 (104CH)	4173 (104DH)	4174 (104EH)	4175 (104FH)	4176 (1050H)	4177 (1051H)	4178 (1052H)	4179 (1053H)				
CH1 to CH16											
4180 to 4199 (1054H to 1067H)								System area	—	—	—

■Un\G4200 to Un\G9999 (For the R60DA8-G)

Address Decimal (hexadecimal)								Name	Default value	Data type	Auto refresh
4200 (1068H)								Command area for module invalidation	0	Setting	×
4201 (1069H)								Validation status area	0	Monitor	×
4202 to 9999 (106AH to 270FH)								System area	—	—	—

■Un\G4200 to Un\G9999 (For the R60DA16-G)

Address Decimal (hexadecimal)								Name	Default value	Data type	Auto refresh
4200 to 9999 (1068H to 270FH)								System area	—	—	—

In Q compatible mode

■Un\G0 to Un\G199

Address Decimal (hexadecimal)								Name	Default value	Data type	Auto refresh
CH1	CH2	CH3	CH4	CH5	CH6	CH7	CH8				
0 (0H)								D/A conversion enable/ disable setting	00FFH	Setting	×
1 (1H)	2 (2H)	3 (3H)	4 (4H)	5 (5H)	6 (6H)	7 (7H)	8 (8H)	CH□ Digital value	0	Control	○
9 (9H), 10 (AH)								System area	—	—	—
11 (BH)	12 (CH)	13 (DH)	14 (EH)	15 (FH)	16 (10H)	17 (11H)	18 (12H)	CH□ Setting value check code	0	Monitor	○
19 (13H)								Latest error code	0	Monitor	○
20 (14H)				21 (15H)				Range setting monitor (CH1 to CH4) Range setting monitor (CH5 to CH8)	0000H	Monitor	×
22 (16H)								Offset/gain setting mode (offset specification)	0000H	Setting	×
23 (17H)								Offset/gain setting mode (gain specification)	0000H	Setting	×
24 (18H)								Offset/gain adjustment value specification	0	Control	×
25 (19H)								Offset/gain setting mode (range specification)	0	Setting	×
26 (1AH)				27 (1BH)				HOLD/CLEAR function setting monitor (CH1 to CH4) HOLD/CLEAR function setting monitor (CH5 to CH8)	0	Monitor	×
28(1CH)								Disconnection detection enable/disable setting	0	Setting	×
29(1DH)								Disconnection detection (extended mode) enable/ disable setting	0	Setting	×
30(1EH)								Disconnection detection auto-clear enable/disable setting	0	Setting	×
31 to 45 (1FH to 2DH)								System area	—	—	—
46 (2EH)								Rate control enable/ disable setting	00FFH	Setting	×
47 (2FH)								Alert output setting	00FFH	Setting	×
48 (30H)								Alert output flag	0000H	Monitor	○
49 (31H)								Disconnection detection flag	0000H	Monitor	○
50 to 52 (32H to 34H)								System area	—	—	—
53 (35H)								Scaling enable/disable setting	00FFH	Setting	×
54 (36H)	56 (38H)	58 (3AH)	60 (3CH)	62 (3EH)	64 (40H)	66 (42H)	68 (44H)	CH□ Scaling lower limit value	0	Setting	×
55 (37H)	57 (39H)	59 (3BH)	61 (3DH)	63 (3FH)	65 (41H)	67 (43H)	69 (45H)	CH□ Scaling upper limit value	0	Setting	×
70 (46H)	72 (48H)	74 (4AH)	76 (4CH)	78 (4EH)	80 (50H)	82 (52H)	84 (54H)	CH□ Increase digital limit value	64000	Setting	×
71 (47H)	73 (49H)	75 (4BH)	77 (4DH)	79 (4FH)	81 (51H)	83 (53H)	85 (55H)	CH□ Decrease digital limit value	64000	Setting	×
86 (56H)	88 (58H)	90 (5AH)	92 (5CH)	94 (5EH)	96 (60H)	98 (62H)	100 (64H)	CH□ Alert output upper limit value	0	Setting	×

Address Decimal (hexadecimal)								Name	Default value	Data type	Auto refresh
CH1	CH2	CH3	CH4	CH5	CH6	CH7	CH8				
87 (57H)	89 (59H)	91 (5BH)	93 (5DH)	95 (5FH)	97 (61H)	99 (63H)	101 (65H)	CH□ Alert output lower limit value	0	Setting	×
102 (66H)	103 (67H)	104 (68H)	105 (69H)	106 (6AH)	107 (6BH)	108 (6CH)	109 (6DH)	CH□ Number of disconnection checks	1	Setting	×
110 (6EH)	111 (6FH)	112 (70H)	113 (71H)	114 (72H)	115 (73H)	116 (74H)	117 (75H)	CH□ Number of disconnection detection auto-clear checks	100	Setting	×
118 to 149 (76H to 95H)								System area	—	—	—
150 (96H)	151 (97H)	152 (98H)	153 (99H)	154 (9AH)	155 (9BH)	156 (9CH)	157 (9DH)	CH□ Input value shift amount	0	Control	×
158, 159 (9EH, 9FH)								Mode switching setting	0	Setting	×
160 to 199 (A0H to C7H)								System area	—	—	—

■Un\G200 to Un\G233

Address Decimal (hexadecimal)								Name	Default value	Data type	Auto refresh
CH1	CH2	CH3	CH4	CH5	CH6	CH7	CH8				
200 (C8H)								Save data type setting	0000H	User range setting	×
201 (C9H)								System area	—	—	—
202 (CAH)	204 (CCH)	206 (CEH)	208 (D0H)	210 (D2H)	212 (D4H)	—	—	CH□ Factory default setting offset value (CH1 to CH6)	0	User range setting	×
203 (CBH)	205 (CDH)	207 (CFH)	209 (D1H)	211 (D3H)	213 (D5H)	—	—	CH□ Factory default setting gain value (CH1 to CH6)	0	User range setting	×
214 (D6H)	216 (D8H)	218 (DAH)	220 (DCH)	222 (DEH)	224 (E0H)	—	—	CH□ User range setting offset value (CH1 to CH6)	0	User range setting	×
215 (D7H)	217 (D9H)	219 (DBH)	221 (DDH)	223 (DFH)	225 (E1H)	—	—	CH□ User range setting gain value (CH1 to CH6)	0	User range setting	×
—	—	—	—	—	—	226 (E2H)	228 (E4H)	CH□ Factory default setting offset value (CH7, CH8)	0	User range setting	×
—	—	—	—	—	—	227 (E3H)	229 (E5H)	CH□ Factory default setting gain value (CH7, CH8)	0	User range setting	×
—	—	—	—	—	—	230 (E6H)	232 (E8H)	CH□ User range setting offset value (CH7, CH8)	0	User range setting	×
—	—	—	—	—	—	231 (E7H)	233 (E9H)	CH□ User range setting gain value (CH7, CH8)	0	User range setting	×

■Un\G234 to Un\G3749

Address Decimal (hexadecimal)								Name	Default value	Data type	Auto refresh
CH1	CH2	CH3	CH4	CH5	CH6	CH7	CH8				
234 to 401 (EAH to 191H)								System area	—	—	—
402 (192H)				403 (193H)				Range setting (CH1 to CH4) Range setting (CH5 to CH8)	0	Setting	×
404 to 1799 (194H to 707H)								System area	—	—	—
1800 (708H)								Latest address of error history	0	Monitor	○
1801 to 1809 (709H to 711H)								System area	—	—	—
1810 to 1969 (712H to 7B1H)								Error history 1 to 16	0	Monitor	×
1970 to 3749 (7B2H to EA5H)								System area	—	—	—

■Un\G3750 to Un\G9999

Address (decimal)	Address (hexadecimal)	Name	Default value	Data type	Auto refresh
3750	EA6H	Latest alarm code	0	Monitor	○
3751	EA7H	Latest address of alarm history	0	Monitor	○
3752 to 3759	EA8H to EAFH	System area	—	—	—
3760 to 3919	EB0H to F4FH	Alarm history 1 to 16	0	Monitor	×
3920 to 3999	F50H to F9FH	System area	—	—	—
4000 to 4015	FA0H to FAFH	Interrupt factor detection flag [n] ^{*1}	0	Monitor	○
4016 to 4031	FB0H to FBFH	System area	—	—	—
4032 to 4047	FC0H to FCFH	Interrupt factor mask [n] ^{*1}	0	Control	×
4048 to 4063	FD0H to FDFH	System area	—	—	—
4064 to 4079	FE0H to FEFH	Interrupt factor reset request [n] ^{*1}	0	Control	×
4080 to 4095	FF0H to FFFH	System area	—	—	—
4096 to 4111	1000H to 100FH	Interrupt factor generation setting [n] ^{*1}	0	Setting	×
4112 to 4127	1010H to 101FH	System area	—	—	—
4128 to 4143	1020H to 102FH	Condition target setting [n] ^{*1}	0	Setting	×
4144 to 4159	1030H to 103FH	System area	—	—	—
4160 to 4175	1040H to 104FH	Condition target channel setting [n] ^{*1}	0	Setting	×
4176 to 4199	1050H to 1067H	System area	—	—	—
4200	1068H	Command area for module invalidation	0	Setting	×
4201	1069H	Validation status area	0	Monitor	×
4202 to 9999	106AH to 270FH	System area	—	—	—

*1 [n] in the table indicates an interrupt setting number. (n = 1 to 16)

Details of buffer memory addresses

The following section describes the details of the buffer memory addresses of the D/A converter module.



This section describes buffer memory addresses for CH1.

Latest error code

The latest error code detected in the D/A converter module is stored. For details, refer to the following.

☞ Page 71 List of Error Codes

■Buffer memory address

The following shows the buffer memory address of this area.

Buffer memory name	CH 1	CH 2	CH 3	CH 4	CH 5	CH 6	CH 7	CH 8	CH 9	CH 10	CH 11	CH 12	CH 13	CH 14	CH 15	CH 16
Latest error code	0															
Latest error code (in Q compatible mode)	19															—

■Clearing an error

Turn on and off 'Error clear request' (YF).

Latest address of error history

Among 'Error history □' (Un\G3600 to Un\G3759), a buffer memory address which stores the latest error code is stored. In the Q compatible mode, the error history is stored in Un\G1810 to Un\G1969.

■Buffer memory address

The following shows the buffer memory address of this area.

Buffer memory name	CH 1	CH 2	CH 3	CH 4	CH 5	CH 6	CH 7	CH 8	CH 9	CH 10	CH 11	CH 12	CH 13	CH 14	CH 15	CH 16
Latest address of error history	1															
Latest address of error history (in Q compatible mode)	1800															—

Latest alarm code

The latest alarm code detected in the D/A converter module is stored. For details, refer to the following.

☞ Page 74 List of Alarm Codes

■Buffer memory address

The following shows the buffer memory address of this area.

Buffer memory name	CH 1	CH 2	CH 3	CH 4	CH 5	CH 6	CH 7	CH 8	CH 9	CH 10	CH 11	CH 12	CH 13	CH 14	CH 15	CH 16
Latest alarm code	2															
Latest alarm code (in Q compatible mode)	3750															—

■Clearing an alarm

Turn on and off 'Alert output clear request' (YE) or 'Operating condition setting request' (Y9).

Latest address of alarm history

Among 'Alarm history □' (Un\G3760 to Un\G3999), a buffer memory address which stores the latest alarm code is stored.

■Buffer memory address

The following shows the buffer memory address of this area.

Buffer memory name	CH 1	CH 2	CH 3	CH 4	CH 5	CH 6	CH 7	CH 8	CH 9	CH 10	CH 11	CH 12	CH 13	CH 14	CH 15	CH 16
Latest address of alarm history	3															
Latest address of alarm history (in Q compatible mode)	3751															

Interrupt factor detection flag [n]

The detection status of the interrupt factor is stored.

Monitor value	Description
0	No interrupt factor
1	Interrupt factor

When an interrupt factor occurs, an interrupt request is sent to the CPU module at the same time as 'Interrupt factor detection flag [n]' (Un\G4 to Un\G19) is turned to Interrupt factor (1).

"n" indicates an interrupt setting number. (n = 1 to 16)

■Buffer memory address

The following shows the buffer memory address of this area.

Buffer memory name	1	2	3	4	5	6	7	8	9	10	11	12	13	14	15	16
Interrupt factor detection flag [n]	4	5	6	7	8	9	10	11	12	13	14	15	16	17	18	19
Interrupt factor detection flag [n] (in Q compatible mode)	4000	4001	4002	4003	4004	4005	4006	4007	4008	4009	4010	4011	4012	4013	4014	4015

Alert output upper limit flag

The upper limit alarm can be checked for each channel.

b15	b14	b13	b12	b11	b10	b9	b8	b7	b6	b5	b4	b3	b2	b1	b0
CH16	CH15	CH14	CH13	CH12	CH11	CH10	CH9	CH8	CH7	CH6	CH5	CH4	CH3	CH2	CH1

- 0: Normal, 1: Alert alarm ON
- b8 to b15 of the R60DA8-G are fixed to 0.

■Buffer memory address

The following shows the buffer memory address of this area.

Buffer memory name	CH 1	CH 2	CH 3	CH 4	CH 5	CH 6	CH 7	CH 8	CH 9	CH 10	CH 11	CH 12	CH 13	CH 14	CH 15	CH 16
Alert output upper limit flag	36															

■Alert output upper limit flag status

- When the value is out of the range specified in the alert output upper limit value, Alert alarm ON (1) is stored in 'Alert output upper limit flag' (Un\G36) corresponding to each channel.
- When an alert is detected in any channel where the D/A conversion and the alert output setting are enabled, 'Alert output signal' (XE) also turns on.

■Clearing Alert output upper limit flag

Turn on and off 'Alert output clear request' (YE) or 'Operating condition setting request' (Y9).

Alert output lower limit flag

The lower limit alarm can be checked for each channel.

b15	b14	b13	b12	b11	b10	b9	b8	b7	b6	b5	b4	b3	b2	b1	b0
CH16	CH15	CH14	CH13	CH12	CH11	CH10	CH9	CH8	CH7	CH6	CH5	CH4	CH3	CH2	CH1

- 0: Normal, 1: Alert alarm ON
- b8 to b15 of the R60DA8-G are fixed to 0.

■Buffer memory address

The following shows the buffer memory address of this area.

Buffer memory name	CH 1	CH 2	CH 3	CH 4	CH 5	CH 6	CH 7	CH 8	CH 9	CH 10	CH 11	CH 12	CH 13	CH 14	CH 15	CH 16
Alert output lower limit flag	37															

■Alert output lower limit flag status

- When the value is out of the range specified in the alert output lower limit value, Alert alarm ON (1) is stored in 'Alert output lower limit flag' (Un\G37) corresponding to each channel.
- When an alert is detected in any channel where the D/A conversion and the alert output setting are enabled, 'Alert output signal' (XE) also turns on.

■Clearing Alert output lower limit flag

Turn on and off 'Alert output clear request' (YE) or 'Operating condition setting request' (Y9).

Alert output flag [Q compatible mode]

When the Q compatible mode function is used, the upper/lower limit alert can be checked.

b15	b14	b13	b12	b11	b10	b9	b8	b7	b6	b5	b4	b3	b2	b1	b0
CH8	CH8	CH7	CH7	CH6	CH6	CH5	CH5	CH4	CH4	CH3	CH3	CH2	CH2	CH1	CH1
Lower limit value	Upper limit value	Lower limit value	Upper limit value	Lower limit value	Upper limit value	Lower limit value	Upper limit value	Lower limit value	Upper limit value	Lower limit value	Upper limit value	Lower limit value	Upper limit value	Lower limit value	Upper limit value

0: Normal, 1: Alarm ON

■Buffer memory address

The following shows the buffer memory address of this area.

Only the R60DA8-G can use this area.

Buffer memory name	CH1	CH2	CH3	CH4	CH5	CH6	CH7	CH8
Alert output flag (in Q compatible mode)	48							

■Alert output flag status

- When the value is out of the range specified in the alert output upper limit value or alert output lower limit value, Alert alarm ON (1) is stored in 'Alert output flag' (Un\G48) corresponding to each channel.
- When an alert is detected in any channel where the D/A conversion and the alert output setting are enabled, 'Alert output signal' (XE) also turns on.

■Clearing Alert output flag

Turn on and off 'Alert output clear request' (YE) or 'Operating condition setting request' (Y9).

Disconnection detection flag

Whether a disconnection was detected or not can be checked for each channel where the disconnection detection is enabled.

b15	b14	b13	b12	b11	b10	b9	b8	b7	b6	b5	b4	b3	b2	b1	b0
CH16	CH15	CH14	CH13	CH12	CH11	CH10	CH9	CH8	CH7	CH6	CH5	CH4	CH3	CH2	CH1

- 0: Normal, 1: Disconnection detection
- b8 to b15 of the R60DA8-G are fixed to 0.

Buffer memory address

The following shows the buffer memory address of this area.

Buffer memory name	CH 1	CH 2	CH 3	CH 4	CH 5	CH 6	CH 7	CH 8	CH 9	CH 10	CH 11	CH 12	CH 13	CH 14	CH 15	CH 16
Disconnection detection flag	38															
Disconnection detection flag (When the Q compatible mode function is used)	49															

Disconnection detection flag status

- When a disconnection is detected, Disconnection detection (1) is stored in 'Disconnection detection flag' (Un\G38) corresponding to each channel.
- When a disconnection is detected in any channel, 'Disconnection detection signal' (XD) turns on.

Clearing Disconnection detection flag

How to clear Disconnection detection flag varies depending on the setting of 'CH□ Disconnection detection auto-clear enable/disable setting'.

Setting of 'CH□ Disconnection detection auto-clear enable/disable setting'	How to clear 'Disconnection detection flag' (Un\G38)
Disable (0)	<ul style="list-style-type: none"> • Even if the disconnection cause is eliminated, the analog output does not restart automatically to prevent an incorrect output. • To restart the analog output, check 'CH□ Digital value' and turn on and off 'Error clear request' (YF). According to the status of 'CH□ Output enable/disable flag' (Y1 to Y8, Y11 to Y18), the analog output restarts. • When the analog output restarts, the corresponding channel of Disconnection detection flag is cleared.
Enable (1)	<ul style="list-style-type: none"> • The analog output continues according to the status of 'CH□ Output enable/disable flag' (Y1 to Y8, Y11 to Y18), even in disconnection state. • After the disconnection cause is eliminated and continuity is restored, if no disconnection has occurred until the disconnection detection auto-clear check monitoring time for channel □^{*1} elapses, the corresponding channel of Disconnection detection flag is automatically cleared.

- *1 CH1 Disconnection detection auto-clear check monitoring time (time taken until the disconnection detection for channel 1 is automatically cleared) is calculated with the following formula.
 CH1 Disconnection detection auto-clear check monitoring time = 'CH1 Number of disconnection detection auto-clear checks' (Un\G562) × (Number of D/A conversion enabled channels × Conversion speed (1ms/CH))



Interrupt factor mask [n]

Set Interrupt factor mask to be used.

Setting value	Setting content
0	Mask (Interrupt unused)
1	Mask clear (Interrupt used)

When 'Interrupt factor mask [n]' (Un\G124 to Un\G139) is changed to Mask clear (Interrupt used) (1) and an interrupt factor occurs, an interrupt request is sent to the CPU module. When the set value is two or larger, the setting is regarded as Mask clear (Interrupt used) (1).

"n" indicates an interrupt setting number. (n = 1 to 16)

■Buffer memory address

The following shows the buffer memory address of this area.

Buffer memory name	1	2	3	4	5	6	7	8	9	10	11	12	13	14	15	16
Interrupt factor mask [n]	124	125	126	127	128	129	130	131	132	133	134	135	136	137	13	139
Interrupt factor mask [n] (in Q compatible mode)	4032	4033	4034	4035	4036	4037	4038	4039	4040	4041	4042	4043	4044	4045	4046	4047

■Default value

The default value is set to Mask (Interrupt unused) (0) for all channels.

Interrupt factor reset request [n]

An interrupt factor reset request is sent.

Setting value	Setting content
0	No reset request
1	Reset request

When Reset request (1) is set to 'Interrupt factor reset request [n]' (Un\G156 to Un\G171) corresponding to the interrupt factor, the interrupt factor corresponding to the specified interrupt is reset. After that, 'Interrupt factor reset request [n]' (Un\G156 to Un\G171) turns to No reset request (0). When the set value is two or larger, the setting is regarded as Reset request (1).

Interrupt factors can also be reset by turning on and off 'Operating condition setting request' (Y9).

"n" indicates an interrupt setting number. (n = 1 to 16)

■Buffer memory address

The following shows the buffer memory address of this area.

Buffer memory name	1	2	3	4	5	6	7	8	9	10	11	12	13	14	15	16
Interrupt factor reset request [n]	156	157	158	159	160	161	162	163	164	165	166	167	168	169	170	171
Interrupt factor reset request [n] (in Q compatible mode)	4064	4065	4066	4067	4068	4069	4070	4071	4072	4073	4074	4075	4076	4077	4078	4079

■Default value

The default value is No reset request (0) for all buffer memory areas.

Interrupt factor generation setting [n]

Set an interrupt request for when the same interrupt factor occurs during the interrupt factor detection.

Setting value	Setting content
0	Interrupt resend request
1	No interrupt resend request

- When 'Interrupt factor generation setting [n]' (Un\G200 to Un\G215) is Interrupt resend request (0) and the same interrupt factor occurs during the interrupt factor detection, an interrupt request is sent to the CPU module again.
- When 'Interrupt factor generation setting [n]' (Un\G200 to Un\G215) is No interrupt resend request (1) and the same interrupt factor occurs during the interrupt factor detection, an interrupt request is not sent to the CPU module.

If a value other than the above is set, an interrupt factor generation setting range error (error code: 180△H) occurs.

"n" indicates an interrupt setting number. (n = 1 to 16)

■Buffer memory address

The following shows the buffer memory address of this area.

Buffer memory name	1	2	3	4	5	6	7	8	9	10	11	12	13	14	15	16
Interrupt factor generation setting [n]	200	201	202	203	204	205	206	207	208	209	210	211	212	213	214	215
Interrupt factor generation setting [n] (in Q compatible mode)	4096	4097	4098	4099	4100	4101	4102	4103	4104	4105	4106	4107	4108	4109	4110	4111

■Enabling the setting

Turn on and off 'Operating condition setting request' (Y9).

■Default value

The default value is Interrupt resend request (0) for all buffer memory areas.

Condition target setting [n]

Set an interrupt factor to be detected.

Setting value ^{*1}	Setting content
0	Disable
1	Error flag (XF)
2	Alert output flag
3	Disconnection detection flag
4	External power supply READY flag (CH1 to CH8) (X7)
5	External power supply READY flag (CH9 to CH16) (X17)
6	External power supply READY flag (CH1 to CH8) (X7) or External power supply READY flag (CH9 to CH16) (X17)

*1 When the R60DA8-G is used, only 0 to 4 can be set.

If a value other than the above is set, a condition target setting range error (error code: 181△H) occurs.

When 'Error flag' (XF) or the buffer memory areas are set in 'Condition target setting [n]' (Un\G232 to Un\G247) and turn on, an interrupt request is sent to the CPU module. When 'External power supply READY flag (CH1 to CH8)' (X7) or 'External power supply READY flag (CH9 to CH16)' (X17) is set in 'Condition target setting [n]' (Un\G232 to Un\G247) and turns off, an interrupt request is sent to the CPU module.

"n" indicates an interrupt setting number. (n = 1 to 16)

■Buffer memory address

The following shows the buffer memory address of this area.

Buffer memory name	1	2	3	4	5	6	7	8	9	10	11	12	13	14	15	16
Condition target setting [n]	232	233	234	235	236	237	238	239	240	241	242	243	244	245	246	247
Condition target setting [n] (in Q compatible mode)	4128	4129	4130	4131	4132	4133	4134	4135	4136	4137	4138	4139	4140	4141	4142	4143

■Enabling the setting

Turn on and off 'Operating condition setting request' (Y9).

■Default value

The default value is Disable (0) for all buffer memory areas.

Condition target channel setting [n]

Set a channel where an interrupt is detected.

Setting value ^{*1}	Setting content
0	All channels
1	CH1
2	CH2
3	CH3
4	CH4
5	CH5
6	CH6
7	CH7
8	CH8
9	CH9
10	CH10
11	CH11
12	CH12
13	CH13
14	CH14
15	CH15
16	CH16

*1 When the R60DA8-G is used, only 0 to 8 can be set.

When a factor for the channel specification is set to 'Condition target setting [n]' (Un\G232 to Un\G247), an interrupt factor in the channel set by this area is monitored. When a factor of the input signal (X) is set, the setting in this area is ignored. If a value other than the above is set, a condition target channel setting range error (error code: 182△H) occurs.

"n" indicates an interrupt setting number. (n = 1 to 16)

■Buffer memory address

The following shows the buffer memory address of this area.

Buffer memory name	1	2	3	4	5	6	7	8	9	10	11	12	13	14	15	16
Condition target channel setting [n]	264	265	266	267	268	269	270	271	272	273	274	275	276	277	278	279
Condition target channel setting [n] (in Q compatible mode)	4160	4161	4162	4163	4164	4165	4166	4167	4168	4169	4170	4171	4172	4173	4174	4175

■Enabling the setting

Turn on and off 'Operating condition setting request' (Y9).

■Default value

The default value is All CH specification (0) for all buffer memory areas.

Mode switching setting

Set a setting value for the mode to be switched.

Switching mode	Setting value	
	296	297
Normal mode	5260H	4441H
Offset/gain setting mode	4441H	5260H

When a value other than the above is set, the mode switching is not executed and only the operating condition is changed.

■Buffer memory address

The following shows the buffer memory address of this area.

Buffer memory name	CH 1	CH 2	CH 3	CH 4	CH 5	CH 6	CH 7	CH 8	CH 9	CH 10	CH 11	CH 12	CH 13	CH 14	CH 15	CH 16
Mode switching setting	296, 297															
Mode switching setting (in Q compatible mode)	158, 159															—

■Enabling the setting

Turn on and off 'Operating condition setting request' (Y9).

■After the mode is switched

When the mode is switched, this area is cleared to 0 and 'Operating condition setting completed flag' (X9) turns off.

After checking that 'Operating condition setting completed flag' (X9) is off, turn off 'Operating condition setting request' (Y9).

CH1 Set value check code

The check result of whether the set digital value is within the setting range can be checked.

The check target is 'CH1 Digital value' (Un\G460).

When a digital value out of the setting range is written, one of the following check codes is stored.

Check code	Description
000FH	A digital value exceeding the setting range has been written.
00F0H	A digital value falling short of the setting range has been written.
00FFH	A digital value falling short of the setting range and a digital value exceeding the setting range have been written. This check code may be stored when a check code is not reset.

Once the check code is stored, the code is not reset even when the digital value falls within the setting range.

To reset the check code, rewrite the digital value to a value within the setting range and turn on and off 'Error clear request' (YF).

When the scaling function is used, the value of 'CH1 Digital value' (Un\G460) which has undergone a scale conversion is checked. Note that some errors may be observed in the target digital value for a check code to be stored due to the calculation error of scale conversion when a scale-converted value exceeds the setting range.

■Buffer memory address

The following shows the buffer memory address of this area.

- CH□ Setting value check code

CH1	CH2	CH3	CH4	CH5	CH6	CH7	CH8	CH9	CH10	CH11	CH12	CH13	CH14	CH15	CH16
400	600	800	1000	1200	1400	1600	1800	2000	2200	2400	2600	2800	3000	3200	3400

- CH□ Setting value check code (When the Q compatible mode function is used)

CH1	CH2	CH3	CH4	CH5	CH6	CH7	CH8	CH9	CH10	CH11	CH12	CH13	CH14	CH15	CH16
11	12	13	14	15	16	17	18	—							

CH1 Range setting monitor

The output range value set to the output range setting or 'CH1 Range setting' (Un\G598) can be checked.

Monitor value	Description
0H	4 to 20mA
1H	0 to 20mA
2H	1 to 5V
3H	0 to 5V
4H	-10 to 10V
5H	-12 to 12V
AH	4 to 20mA (extended mode)
BH	1 to 5V (extended mode)
DH	User range setting 3
EH	User range setting 2
FH	User range setting 1

■ Buffer memory address

The following shows the buffer memory address of this area.

- CH□ Range setting monitor

CH1	CH2	CH3	CH4	CH5	CH6	CH7	CH8	CH9	CH10	CH11	CH12	CH13	CH14	CH15	CH16
430	630	830	1030	1230	1430	1630	1830	2030	2230	2430	2630	2830	3030	3230	3430



Because the output range cannot be changed for channels set to D/A conversion disabled, the stored value in this area is not updated. For details, refer to the following.

☞ Page 23 Range Switching Function

Range setting monitor [Q compatible mode]

When the Q compatible mode function is used, the output range value set in the output range setting can be checked.

Range setting monitor (Un\G20) (setting range CH1 to CH4)	b15 ... b12 b11 ... b8 b7 ... b4 b3 ... b0	CH4	CH3	CH2	CH1
--	--	-----	-----	-----	-----

Range setting monitor (Un\G21) (setting range CH5 to CH8)	b15 ... b12 b11 ... b8 b7 ... b4 b3 ... b0	CH8	CH7	CH6	CH5
--	--	-----	-----	-----	-----

■ Buffer memory address

The following shows the buffer memory address of this area.

Only the R60DA8-G can use this area.

Buffer memory name	CH1	CH2	CH3	CH4	CH5	CH6	CH7	CH8
Range setting monitor (in Q compatible mode)	20				21			

The monitor value of the output range is the same as the one for the R mode.



Because the output range cannot be changed for channels set to D/A conversion disabled, the bit corresponding to the relevant channel in this area is not updated. For details, refer to the following.

☞ Page 23 Range Switching Function

CH1 HOLD/CLEAR function setting monitor

The setting status of the HOLD/CLEAR function can be checked.

Monitor value	Description
0	CLEAR
1	HOLD

■Buffer memory address

The following shows the buffer memory address of this area.

- CH□ HOLD/CLEAR function setting monitor

CH1	CH2	CH3	CH4	CH5	CH6	CH7	CH8	CH9	CH10	CH11	CH12	CH13	CH14	CH15	CH16
431	631	831	1031	1231	1431	1631	1831	2031	2231	2431	2631	2831	3031	3231	3431

HOLD/CLEAR function setting monitor [Q compatible mode]

When the Q compatible mode function is used, the setting status of the HOLD/CLEAR function can be checked.

HOLD/CLEAR function setting monitor (Un\G26)	b15	...	b12	b11	...	b8	b7	...	b4	b3	...	b0
	CH4			CH3			CH2			CH1		

HOLD/CLEAR function setting monitor (Un\G27)	b15	...	b12	b11	...	b8	b7	...	b4	b3	...	b0
	CH8			CH7			CH6			CH5		

0: CLEAR, 1 to F: HOLD

■Buffer memory address

The following shows the buffer memory address of this area.

Only the R60DA8-G can use this area.

Buffer memory name	CH1	CH2	CH3	CH4	CH5	CH6	CH7	CH8
HOLD/CLEAR function setting monitor (in Q compatible mode)	26				27			

CH1 Digital value

Set the digital value in 16-bit signed binary for the D/A conversion from the CPU module.

Output range setting	When the scaling function is disabled	When the scaling function is enabled*1
	Setting range (practical range)	Setting range
0: 4 to 20mA	-768 to 32767 (practical range: 0 to 32000)	-32000 to 32000
1: 0 to 20mA		
2: 1 to 5V		
3: 0 to 5V	-32768 to 32767 (practical range: -32000 to 32000)	
4: -10 to 10V		
5: -12 to 12V		
D: User range setting 3		
E: User range setting 2	-8768 to 32767 (practical range: -8000 to 32767)	
A: 4 to 20mA (extended mode)		
B: 1 to 5V (extended mode)		
F: User range setting 1	-768 to 32767 (practical range: 0 to 32000)	

*1 The available setting range and practical range of when the scaling function is enabled differ depending on the setting of the scaling upper limit value and scaling lower limit value.

When a value out of the available setting range is written, the D/A conversion is performed with the upper or lower limit value of the available setting range.

A check code is stored in 'CH1 Set value check code' (Un\G400) and a digital value setting range error (error code: 191□H) is stored in 'Latest error code' (Un\G0).

Point

When the output range is set to 4 to 20mA (extended mode) or 1 to 5V (extended mode) and the scaling function is disabled, the analog output value ranges as shown below.

- 4 to 20mA (extended mode): 0 to 20.48mA
- 1 to 5V (extended mode): 0 to 5.12V

To output 22mA or 5.5V, use the scaling function or shift function.

For details on the scaling function and shift function, refer to the following.

☞ Page 27 Scaling Function

☞ Page 30 Shift Function

■ Buffer memory address

The following shows the buffer memory address of this area.

- CH□ Digital value

CH1	CH2	CH3	CH4	CH5	CH6	CH7	CH8	CH9	CH10	CH11	CH12	CH13	CH14	CH15	CH16
460	660	860	1060	1260	1460	1660	1860	2060	2260	2460	2660	2860	3060	3260	3460

- CH□ Digital value (When the Q compatible mode function is used)

CH1	CH2	CH3	CH4	CH5	CH6	CH7	CH8	CH9	CH10	CH11	CH12	CH13	CH14	CH15	CH16
1	2	3	4	5	6	7	8	—							

CH1 Input value shift amount

The set value is added to the digital value regardless of the on/off state of 'Operating condition setting request' (Y9).
For details on the shift function, refer to the following.

☞ Page 30 Shift Function

■Buffer memory address

The following shows the buffer memory address of this area.

- CH□ Input value shift amount

CH1	CH2	CH3	CH4	CH5	CH6	CH7	CH8	CH9	CH10	CH11	CH12	CH13	CH14	CH15	CH16
480	680	880	1080	1280	1480	1680	1880	2080	2280	2480	2680	2880	3080	3280	3480

- CH□ Input value shift amount (When the Q compatible mode function is used)

CH1	CH2	CH3	CH4	CH5	CH6	CH7	CH8	CH9	CH10	CH11	CH12	CH13	CH14	CH15	CH16
150	151	152	153	154	155	156	157	—							

■Setting range

The setting range is from -32768 to 32767.

■Default value

The default value is 0 for all channels.

CH1 D/A conversion enable/disable setting

Set whether to enable or disable the D/A conversion.

For details on the D/A conversion enable/disable function, refer to the following.

☞ Page 24 D/A Conversion Enable/Disable Setting Function

Setting value	Description
0	D/A conversion enabled
1	D/A conversion disabled

When a value other than the above is set, the value is processed as D/A conversion disabled (1).

■Buffer memory address

The following shows the buffer memory address of this area.

- CH□ D/A conversion enable/disable setting

CH1	CH2	CH3	CH4	CH5	CH6	CH7	CH8	CH9	CH10	CH11	CH12	CH13	CH14	CH15	CH16
500	700	900	1100	1300	1500	1700	1900	2100	2300	2500	2700	2900	3100	3300	3500

■Enabling the setting

Turn on and off 'Operating condition setting request' (Y9).

■Default value

The default value is D/A conversion disabled (1) for all channels.

D/A conversion enable/disable setting [Q compatible mode]

When the Q compatible mode function is used, set whether to enable or disable the D/A conversion.

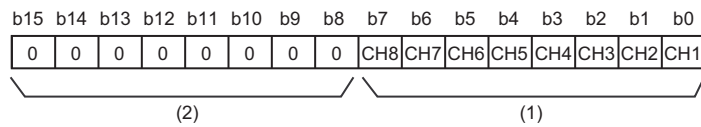

(1) 0: D/A conversion enabled, 1: D/A conversion disabled

(2) b8 to b15 are fixed to 0.

■Buffer memory address

The following shows the buffer memory address of this area.

Only the R60DA8-G can use this area.

Buffer memory name	CH1	CH2	CH3	CH4	CH5	CH6	CH7	CH8
D/A conversion enable/disable setting (in Q compatible mode)	0							

■Enabling the setting

Turn on and off 'Operating condition setting request' (Y9).

■Default value

The default value is D/A conversion disable (1) for all channels.

CH1 Scaling enable/disable setting

Set whether to enable or disable the scaling.

For details on the scaling function, refer to the following.

☞ Page 27 Scaling Function

Setting value	Description
0	Enable
1	Disable

If a value other than the above is set, a scaling enable/disable setting range error (error code: 1A0□H) occurs.

■Buffer memory address

The following shows the buffer memory address of this area.

- CH□ Scaling enable/disable setting

CH1	CH2	CH3	CH4	CH5	CH6	CH7	CH8	CH9	CH10	CH11	CH12	CH13	CH14	CH15	CH16
502	702	902	1102	1302	1502	1702	1902	2102	2302	2502	2702	2902	3102	3302	3502

■Enabling the setting

Turn on and off 'Operating condition setting request' (Y9).

■Default value

The default value is Disable (1) for all channels.

Scaling enable/disable setting [Q compatible mode]

When the Q compatible mode function is used, set whether to enable or disable the scaling.

b15	b14	b13	b12	b11	b10	b9	b8	b7	b6	b5	b4	b3	b2	b1	b0
0	0	0	0	0	0	0	0	CH8	CH7	CH6	CH5	CH4	CH3	CH2	CH1
(2)								(1)							

(1) 0: Enable, 1: Disable

(2) b8 to b15 are fixed to 0.

■Buffer memory address

The following shows the buffer memory address of this area.

Only the R60DA8-G can use this area.

Buffer memory name	CH1	CH2	CH3	CH4	CH5	CH6	CH7	CH8
Scaling enable/disable setting (in Q compatible mode)	53							

■Enabling the setting

Turn on and off 'Operating condition setting request' (Y9).

■Default value

The default value is Disable (1) for all channels.

CH1 Scaling upper limit value

Set the range of the scale conversion.

For details on the scaling function, refer to the following.

☞ Page 27 Scaling Function

■Buffer memory address

The following shows the buffer memory address of this area.

- CH□ Scaling upper limit value

CH1	CH2	CH3	CH4	CH5	CH6	CH7	CH8	CH9	CH10	CH11	CH12	CH13	CH14	CH15	CH16
504	704	904	1104	1304	1504	1704	1904	2104	2304	2504	2704	2904	3104	3304	3504

- CH□ Scaling upper limit value (in Q compatible mode)

CH1	CH2	CH3	CH4	CH5	CH6	CH7	CH8	CH9	CH10	CH11	CH12	CH13	CH14	CH15	CH16
55	57	59	61	63	65	67	69	—							

■Setting range

The setting range is from -32000 to 32000.

In the channel where a value out of the range is set, a scaling setting range error (error code: 1A1□H) occurs.

In the channel where a set value does not satisfy the condition "the scaling upper limit value ≠ the scaling lower limit value", a scaling upper/lower limit value setting error (error code: 1A2□H) occurs.

When 'CH1 Scaling enable/disable setting' (Un\G502) is set to Disable (1), the setting for 'CH1 Scaling upper limit value' (Un\G504) is ignored.

■Enabling the setting

Turn on and off 'Operating condition setting request' (Y9).

■Default value

The default value is 0 for all channels.

CH1 Scaling lower limit value

Set the range of the scale conversion.

For details on the scaling function, refer to the following.

☞ Page 27 Scaling Function

■Buffer memory address

The following shows the buffer memory address of this area.

- CH□ Scaling lower limit value

CH1	CH2	CH3	CH4	CH5	CH6	CH7	CH8	CH9	CH10	CH11	CH12	CH13	CH14	CH15	CH16
506	706	906	1106	1306	1506	1706	1906	2106	2306	2506	2706	2906	3106	3306	3506

- CH□ Scaling lower limit value (in Q compatible mode)

CH1	CH2	CH3	CH4	CH5	CH6	CH7	CH8	CH9	CH10	CH11	CH12	CH13	CH14	CH15	CH16
54	56	58	60	62	64	66	68	—							

■Setting range

The setting range is from -32000 to 32000.

In the channel where a value out of the range is set, a scaling setting range error (error code: 1A1□H) occurs.

In the channel where a set value does not satisfy the condition "the scaling upper limit value ≠ the scaling lower limit value", a scaling upper/lower limit value setting error (error code: 1A2□H) occurs.

When 'CH1 Scaling enable/disable setting' (Un\G502) is set to Disable (1), the setting for 'CH1 Scaling lower limit value' (Un\G506) is ignored.

■Enabling the setting

Turn on and off 'Operating condition setting request' (Y9).

■Default value

The default value is 0 for all channels.

CH1 Alert output setting

Set whether to enable or disable the alert output.

For details on the alert output function, refer to the following.

☞ Page 32 Alert Output Function

Setting value	Description
0	Enable
1	Disable

If a value other than the above is set, an alert output setting range error (error code: 1B0□H) occurs.

■Buffer memory address

The following shows the buffer memory address of this area.

- CH□ Alert output setting

CH1	CH2	CH3	CH4	CH5	CH6	CH7	CH8	CH9	CH10	CH11	CH12	CH13	CH14	CH15	CH16
508	708	908	1108	1308	1508	1708	1908	2108	2308	2508	2708	2908	3108	3308	3508

■Enabling the setting

Turn on and off 'Operating condition setting request' (Y9).

■Default value

The default value is Disable (1) for all channels.

Alert output setting [Q compatible mode]

When the Q compatible mode function is used, set whether to enable or disable the alert output.

b15	b14	b13	b12	b11	b10	b9	b8	b7	b6	b5	b4	b3	b2	b1	b0
0	0	0	0	0	0	0	0	CH8	CH7	CH6	CH5	CH4	CH3	CH2	CH1
(2)								(1)							

(1) 0: Alert output enable, 1: Alert output disable

(2) b8 to b15 are fixed to 0.

■Buffer memory address

The following shows the buffer memory address of this area.

Only the R60DA8-G can use this area.

Buffer memory name	CH1	CH2	CH3	CH4	CH5	CH6	CH7	CH8
Alert output setting (in Q compatible mode)	47							

■Enabling the setting

Turn on and off 'Operating condition setting request' (Y9).

■Default value

The default value is Alert output disable (1) for all channels.

CH1 Rate control enable/disable setting

Set whether to enable or disable the rate control.

For details on the rate control function, refer to the following.

☞ Page 34 Rate Control Function

Setting value	Description
0	Enable
1	Disable

If a value other than the above is set, a rate control enable/disable setting range error (error code: 1B8□H) occurs.

■Buffer memory address

The following shows the buffer memory address of this area.

- CH□ Rate control enable/disable setting

CH1	CH2	CH3	CH4	CH5	CH6	CH7	CH8	CH9	CH10	CH11	CH12	CH13	CH14	CH15	CH16
509	709	909	1109	1309	1509	1709	1909	2109	2309	2509	2709	2909	3109	3309	3509

■Enabling the setting

Turn on and off 'Operating condition setting request' (Y9).

■Default value

The default value is Disable (1) for all channels.

Rate control enable/disable setting [Q compatible mode]

When the Q compatible mode function is used, set whether to enable or disable the rate control.

b15	b14	b13	b12	b11	b10	b9	b8	b7	b6	b5	b4	b3	b2	b1	b0
0	0	0	0	0	0	0	0	CH8	CH7	CH6	CH5	CH4	CH3	CH2	CH1
(2)								(1)							

(1) 0: Rate control enable, 1: Rate control disable

(2) b8 to b15 are fixed to 0.

■Buffer memory address

The following shows the buffer memory address of this area.

Only the R60DA8-G can use this area.

Buffer memory name	CH1	CH2	CH3	CH4	CH5	CH6	CH7	CH8
Rate control enable/disable setting (in Q compatible mode)	46							

■Enabling the setting

Turn on and off 'Operating condition setting request' (Y9).

■Default value

The default value is Rate control disable (1) for all channels.

CH1 Alert output upper limit value

Set the range of digital values to output alerts.

For details on the alert output function, refer to the following.

☞ Page 32 Alert Output Function

■ Buffer memory address

The following shows the buffer memory address of this area.

- CH□ Alert output upper limit value

CH1	CH2	CH3	CH4	CH5	CH6	CH7	CH8	CH9	CH10	CH11	CH12	CH13	CH14	CH15	CH16
510	710	910	1110	1310	1510	1710	1910	2110	2310	2510	2710	2910	3110	3310	3510

- CH□ Alert output upper limit value (When the Q compatible mode function is used)

CH1	CH2	CH3	CH4	CH5	CH6	CH7	CH8	CH9	CH10	CH11	CH12	CH13	CH14	CH15	CH16
86	88	90	92	94	96	98	100	—							

■ Setting range

The setting range is from -32768 to 32767. In the channel where a set value does not satisfy the condition "alert output upper limit value > alert output lower limit value", an alert output upper/lower limit value inversion error (error code: 1B1□H) occurs. When 'CH1 Alert output setting' (Un\G508) is set to Disable (1), the setting of 'CH1 Alert output upper limit value' (Un\G510) is ignored.

■ Enabling the setting

Turn on and off 'Operating condition setting request' (Y9).

■ Default value

The default value is 0 for all channels.

■ Precautions

When the shift function is used, always set a value in consideration of 'CH1 Input value shift amount' (Un\G480).

CH1 Alert output lower limit value

Set the range of digital values to output alerts.

For details on the alert output function, refer to the following.

☞ Page 32 Alert Output Function

■ Buffer memory address

The following shows the buffer memory address of this area.

- CH□ Alert output lower limit value

CH1	CH2	CH3	CH4	CH5	CH6	CH7	CH8	CH9	CH10	CH11	CH12	CH13	CH14	CH15	CH16
512	712	912	1112	1312	1512	1712	1912	2112	2312	2512	2712	2912	3112	3312	3512

- CH□ Alert output lower limit value (When the Q compatible mode function is used)

CH1	CH2	CH3	CH4	CH5	CH6	CH7	CH8	CH9	CH10	CH11	CH12	CH13	CH14	CH15	CH16
87	89	91	93	95	97	99	101	—							

■ Setting range

The setting range is from -32768 to 32767. In the channel where a set value does not satisfy the condition "alert output upper limit value > alert output lower limit value", an alert output upper/lower limit value inversion error (error code: 1B1□H) occurs. When 'CH1 Alert output setting' (Un\G508) is set to Disable (1), the setting of 'CH1 Alert output lower limit value' (Un\G512) is ignored.

■ Enabling the setting

Turn on and off 'Operating condition setting request' (Y9).

■ Default value

The default value is 0 for all channels.

■ Precautions

When the shift function is used, always set a value in consideration of 'CH1 Input value shift amount' (Un\G480).

CH1 Increase digital limit value

Set the increment value per conversion cycle (1ms) when using the rate control function.

For details on the rate control function, refer to the following.

 Page 34 Rate Control Function

■Buffer memory address

The following shows the buffer memory address of this area.

- CH□ Increase digital limit value

CH1	CH2	CH3	CH4	CH5	CH6	CH7	CH8	CH9	CH10	CH11	CH12	CH13	CH14	CH15	CH16
514	714	914	1114	1314	1514	1714	1914	2114	2314	2514	2714	2914	3114	3314	3514

- CH□ Increase digital limit value (When the Q compatible mode function is used)

CH1	CH2	CH3	CH4	CH5	CH6	CH7	CH8	CH9	CH10	CH11	CH12	CH13	CH14	CH15	CH16
70	72	74	76	78	80	82	84	—							

■Setting range

The setting range is from 0 to 64000 (FA00H). If a value out of the setting range is set for a channel where the conversion and rate control are enabled, a digital limit value range error (error code: 1B9□H) occurs.

When the scaling setting is enabled, the increase digital limit value of the input digital value converted within the scaling range is applied.

■Enabling the setting

Turn on and off 'Operating condition setting request' (Y9).

■Default value

The default value is 64000 for all channels.

■Precautions

When a value exceeding 32767 is set in 'CH1 Increase digital limit value' (Un\G514) with the program, the value must be input in hexadecimal.

CH1 Decrease digital limit value

Set the decrement value per conversion cycle (1ms) when using the rate control function.

For details on the rate control function, refer to the following.

 Page 34 Rate Control Function

■Buffer memory address

The following shows the buffer memory address of this area.

- CH□ Decrease digital limit value

CH1	CH2	CH3	CH4	CH5	CH6	CH7	CH8	CH9	CH10	CH11	CH12	CH13	CH14	CH15	CH16
516	716	916	1116	1316	1516	1716	1916	2116	2316	2516	2716	2916	3116	3316	3516

- CH□ Decrease digital limit value (in Q compatible mode)

CH1	CH2	CH3	CH4	CH5	CH6	CH7	CH8	CH9	CH10	CH11	CH12	CH13	CH14	CH15	CH16
71	73	75	77	79	81	83	85	—							

■Setting range

The setting range is from 0 to 64000 (FA00H). If a value out of the setting range is set for a channel where the conversion and rate control are enabled, a digital limit value range error (error code: 1B9□H) occurs.

When the scaling setting is enabled, the decrease digital limit value of the input digital value converted within the scaling range is applied.

■Enabling the setting

Turn on and off 'Operating condition setting request' (Y9).

■Default value

The default value is 64000 for all channels.

■Precautions

When a value exceeding 32767 is set in 'CH1 Decrease digital limit value' (Un\G516) with the program, the value must be input in hexadecimal.

CH1 Disconnection detection enable/disable setting

When the analog output range is set to 4 to 20mA, set whether to enable or disable the disconnection detection.

For details on the disconnection detection function, refer to the following.

☞ Page 38 Disconnection Detection Function

Setting value	Description
0	Enable
1	Disable

If a value other than the above is set, a disconnection detection enable/disable setting range error (error code: 1C0□H) occurs.

■Buffer memory address

The following shows the buffer memory address of this area.

- CH□ Disconnection detection enable/disable setting

CH1	CH2	CH3	CH4	CH5	CH6	CH7	CH8	CH9	CH10	CH11	CH12	CH13	CH14	CH15	CH16
558	758	958	1158	1358	1558	1758	1958	2158	2358	2558	2758	2958	3158	3358	3558

■Enabling the setting

Turn on and off 'Operating condition setting request' (Y9).

■Default value

The default value is Enable (0) for all channels.

Disconnection detection enable/disable setting [Q compatible mode]

When the Q compatible mode function is used, set whether to enable or disable the disconnection detection for channels where the analog output range is set to 4 to 20mA.

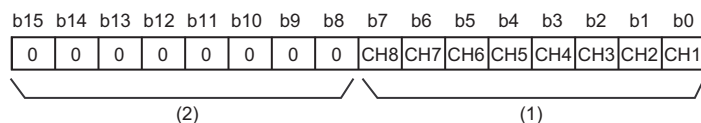

(1) 0: Enable, 1: Disable

(2) b8 to b15 are fixed to 0.

■Buffer memory address

The following shows the buffer memory address of this area.

Only the R60DA8-G can use this area.

Buffer memory name	CH1	CH2	CH3	CH4	CH5	CH6	CH7	CH8
Disconnection detection enable/disable setting (in Q compatible mode)	28							

■Enabling the setting

Turn on and off 'Operating condition setting request' (Y9).

■Default value

The default value is Enable (0) for all channels.

CH1 Disconnection detection (extended mode) enable/disable setting

When the analog output range is set to 4 to 20mA (extended mode), set whether to enable or disable the disconnection detection.

For details on the disconnection detection function, refer to the following.

☞ Page 38 Disconnection Detection Function

Setting value	Description
0	Disable*1
1	Enable*1

*1 The setting values of this buffer memory area (0 for Disable, 1 for Enable) are reversed ones of 'CH1 Disconnection detection enable/disable setting' (Un\G558) (0 for Enable, 1 for Disable). When setting parameters by a program, make sure that correct values are to be set.

If a value other than the above is set, a disconnection detection (extended mode) enable/disable setting range error (error code: 1C1□H) occurs.

■Buffer memory address

The following shows the buffer memory address of this area.

- CH□ Disconnection detection (extended mode) enable/disable setting

CH1	CH2	CH3	CH4	CH5	CH6	CH7	CH8	CH9	CH10	CH11	CH12	CH13	CH14	CH15	CH16
559	759	959	1159	1359	1559	1759	1959	2159	2359	2559	2759	2959	3159	3359	3559

■Enabling the setting

Turn on and off 'Operating condition setting request' (Y9).

■Default value

The default value is Disable (0) for all channels.

Disconnection detection (extended mode) enable/disable setting [Q compatible mode]

When the Q compatible mode function is used, set whether to enable or disable the disconnection detection for channels where the analog output range is set to 4 to 20mA (extended mode).

b15	b14	b13	b12	b11	b10	b9	b8	b7	b6	b5	b4	b3	b2	b1	b0
0	0	0	0	0	0	0	0	CH8	CH7	CH6	CH5	CH4	CH3	CH2	CH1
(2)								(1)							

(1) 0: Disable*1, 1: Enable*1

(2) b8 to b15 are fixed to 0.

*1 The setting values of this buffer memory area (0 for Disable, 1 for Enable) are reversed ones of 'CH1 Disconnection detection enable/disable setting (in Q compatible mode)' (Un\G28) (0 for Enable, 1 for Disable). When setting parameters by a program, make sure that correct values are to be set.

■Buffer memory address

The following shows the buffer memory address of this area.

Only the R60DA8-G can use this area.

Buffer memory name	CH1	CH2	CH3	CH4	CH5	CH6	CH7	CH8
Disconnection detection (extended mode) enable/disable setting (in Q compatible mode)	29							

■Enabling the setting

Turn on and off 'Operating condition setting request' (Y9).

■Default value

The default value is Disable (0) for all channels.

CH1 Number of disconnection checks

This area is used to calculate a time taken for the module to determine a disconnection state (disconnection check monitoring time).

CH1 Disconnection check monitoring time is calculated with the following formula, based on a value set in 'CH1 Number of disconnection checks' (Un\G560).

CH1 Disconnection check monitoring time = 'CH1 Number of disconnection checks' (Un\G560) × (Number of D/A conversion enabled channels × Conversion speed (1ms/CH))

For details on the disconnection detection function, refer to the following.

☞ Page 38 Disconnection Detection Function

■Buffer memory address

The following shows the buffer memory address of this area.

- CH□ Number of disconnection checks

CH1	CH2	CH3	CH4	CH5	CH6	CH7	CH8	CH9	CH10	CH11	CH12	CH13	CH14	CH15	CH16
560	760	960	1160	1360	1560	1760	1960	2160	2360	2560	2760	2960	3160	3360	3560

- CH□ Number of disconnection checks (in Q compatible mode)

CH1	CH2	CH3	CH4	CH5	CH6	CH7	CH8	CH9	CH10	CH11	CH12	CH13	CH14	CH15	CH16
102	103	104	105	106	107	108	109	—							

■Setting range

The setting range is from 1 to 100. For a channel where a value out of the range is set, the calculation is made with the set value regarded as 1.

■Enabling the setting

Turn on and off 'Operating condition setting request' (Y9).

■Default value

The default value is 1 for all channels.

CH1 Disconnection detection auto-clear enable/disable setting

When the disconnection detection function is used, set whether to enable or disable the auto-clear operation of disconnection detection.

For details on the disconnection detection function, refer to the following.

☞ Page 38 Disconnection Detection Function

Setting value	Description
0	Disable*1
1	Enable*1

*1 The setting values of this buffer memory area (0 for Disable, 1 for Enable) are reversed ones of 'CH1 Disconnection detection enable/disable setting' (Un\G558) (0 for Enable, 1 for Disable). When setting parameters by a program, make sure that correct values are to be set.

If a value other than the above is set, a disconnection detection auto-clear enable/disable setting range error (error code: 1C2□H) occurs.

■Buffer memory address

The following shows the buffer memory address of this area.

- CH□ Disconnection detection auto-clear enable/disable setting

CH1	CH2	CH3	CH4	CH5	CH6	CH7	CH8	CH9	CH10	CH11	CH12	CH13	CH14	CH15	CH16
561	761	961	1161	1361	1561	1761	1961	2161	2361	2561	2761	2961	3161	3361	3561

■Enabling the setting

Turn on and off 'Operating condition setting request' (Y9).

■Default value

The default value is Disable (0) for all channels.

Disconnection detection auto-clear enable/disable setting [Q compatible mode]

When the Q compatible mode function is used, set whether to enable or disable the auto-clear operation of disconnection detection for each channel where the disconnection detection function is enabled.

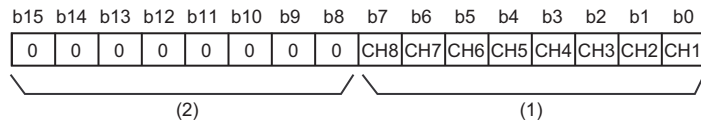

- (1) 0: Disable*1, 1: Enable*1
 (2) b8 to b15 are fixed to 0.

*1 The setting values of this buffer memory area (0 for Disable, 1 for Enable) are reversed ones of 'CH1 Disconnection detection enable/disable setting (in Q compatible mode)' (Un\G28) (0 for Enable, 1 for Disable). When setting parameters by a program, make sure that correct values are to be set.

■Buffer memory address

The following shows the buffer memory address of this area.

Only the R60DA8-G can use this area.

Buffer memory name	CH1	CH2	CH3	CH4	CH5	CH6	CH7	CH8
Disconnection detection auto-clear enable/disable setting (in Q compatible mode)	30							

■Enabling the setting

Turn on and off 'Operating condition setting request' (Y9).

■Default value

The default value is Disable (0) for all channels.

CH1 Number of disconnection detection auto-clear checks

This area is used to calculate a time taken until the disconnection detection is automatically cleared (disconnection detection auto-clear check monitoring time).

CH1 Disconnection detection auto-clear check monitoring time is calculated with the following formula, based on a value set in 'CH1 Number of disconnection detection auto-clear checks' (Un\G562).

CH1 Disconnection detection auto-clear check monitoring time = 'CH1 Number of disconnection detection auto-clear checks' (Un\G562) × (Number of D/A conversion enabled channels × Conversion speed (1ms/CH))

For details on the disconnection detection function, refer to the following.

☞ Page 38 Disconnection Detection Function

■Buffer memory address

The following shows the buffer memory address of this area.

- CH□ Number of disconnection detection auto-clear checks

CH1	CH2	CH3	CH4	CH5	CH6	CH7	CH8	CH9	CH10	CH11	CH12	CH13	CH14	CH15	CH16
562	762	962	1162	1362	1562	1762	1962	2162	2362	2562	2762	2962	3162	3362	3562

- CH□ Number of disconnection detection auto-clear checks (in Q compatible mode)

CH1	CH2	CH3	CH4	CH5	CH6	CH7	CH8	CH9	CH10	CH11	CH12	CH13	CH14	CH15	CH16
110	111	112	113	114	115	116	117	—							

■Setting range

The setting range is from 1 to 1000. For a channel where a value out of the range is set, the calculation is made with the set value regarded as 100.

■Enabling the setting

Turn on and off 'Operating condition setting request' (Y9).

■Default value

The default value is 100 for all channels.

CH1 Range setting

This area is for setting an output range.

Output range	Setting value
4 to 20mA	0H
0 to 20mA	1H
1 to 5V	2H
0 to 5V	3H
-10 to 10V	4H
-12 to 12V	5H
4 to 20mA (extended mode)	AH
1 to 5V (extended mode)	BH
User range setting 3	DH
User range setting 2	EH
User range setting 1	FH

If a value other than the above is set, a range setting range error (error code: 190□H) occurs.

To prevent a sudden change of the analog output, CH□ Under-output range change denial alarm (alarm code: 0C0□H) occurs when the range switching is attempted to be executed with the D/A conversion and output enabled. Thus, the range switching is not executed. To execute the range switching, turn off 'CH1 Output enable/disable flag' (Y1).

The output range cannot be changed for channels set to D/A conversion disabled. To change the output range, set 'CH1 D/A conversion enable/disable setting' (Un\G500) to D/A conversion enabled (0), set 'CH1 Output enable/disable flag' (Y1) to OFF, and turn on and off 'Operating condition setting request' (Y9).

■Buffer memory address

The following shows the buffer memory address of this area.

- CH□ Range setting

CH1	CH2	CH3	CH4	CH5	CH6	CH7	CH8	CH9	CH10	CH11	CH12	CH13	CH14	CH15	CH16
598	798	998	1198	1398	1598	1798	1998	2198	2398	2598	2798	2998	3198	3398	3598

■Enabling the setting

Turn on and off 'Operating condition setting request' (Y9).

■Default value

The default value is 0H for all channels.

Range setting [Q compatible mode]

This area is for setting an output range when the Q compatible mode function is used.

	b15	...	b12	b11	...	b8	b7	...	b4	b3	...	b0
Range setting (Un\G402) (setting range: CH1 to CH4)	CH4			CH3			CH2			CH1		

	b15	...	b12	b11	...	b8	b7	...	b4	b3	...	b0
Range setting (Un\G403) (setting range: CH5 to CH8)	CH8			CH7			CH6			CH5		

■Buffer memory address

The following shows the buffer memory address of this area.

Only the R60DA8-G can use this area.

Buffer memory name	CH1	CH2	CH3	CH4	CH5	CH6	CH7	CH8
Range setting (in Q compatible mode)	402				403			

The output range setting value is the same as the one for the R mode.

The output range cannot be changed for channels set to D/A conversion disabled. To change the output range, set the bit of the corresponding channel of 'CH1 D/A conversion enable/disable setting [Q compatible mode]' (Un\G0) to D/A conversion enabled (0), set 'CH1 Output enable/disable flag' (Y1) to OFF, and turn on and off 'Operating condition setting request' (Y9).

■Enabling the setting

Turn on and off 'Operating condition setting request' (Y9).

■Default value

The default value is 0H for all channels.

Error history

Up to 16 errors that occurred in the module are recorded.

	b15	to	b8	b7	to	b0
Un\G3600	Error code					
Un\G3601	First two digits of the year			Last two digits of the year		
Un\G3602	Month			Day		
Un\G3603	Hour			Minute		
Un\G3604	Second			Day of the week		
Un\G3605	Millisecond (Upper)			Millisecond (Lower)		
Un\G3606	System area					
to						
Un\G3609						

Item	Storage contents	Storage example*1
First two digits of the year/Last two digits of the year	Stored in BCD code.	2015H
Month/Day		131H
Hour/Minute		1234H
Second		56H
Day of the week	One of the following values is stored in BCD code. Sunday: 0, Monday: 1, Tuesday: 2, Wednesday: 3 Thursday: 4, Friday: 5, Saturday: 6	6H
Millisecond (upper)	Stored in BCD code.	7H
Millisecond (lower)		89H

*1 Values stored when an error occurs at 12:34:56.789 on Saturday, January 31st, 2015.

■Buffer memory address

The following shows the buffer memory address of this area.

Buffer memory name	No.1 to No.16
Error history	3600 to 3759
Error history (in Q compatible mode)	1810 to 1969

Alarm history

Up to 16 alarms that occurred in the module are recorded.

	b15	to	b8	b7	to	b0
Un\G3760	Alarm code					
Un\G3761	First two digits of the year			Last two digits of the year		
Un\G3762	Month			Day		
Un\G3763	Hour			Minute		
Un\G3764	Second			Day of the week		
Un\G3765	Millisecond (Upper)			Millisecond (Lower)		
Un\G3766	System area					
to						
Un\G3769						

Item	Storage contents	Storage example* ¹
First two digits of the year/Last two digits of the year	Stored in BCD code.	2015H
Month/Day		131H
Hour/Minute		1234H
Second		56H
Day of the week	One of the following values is stored in BCD code. Sunday: 0, Monday: 1, Tuesday: 2, Wednesday: 3 Thursday: 4, Friday: 5, Saturday: 6	6H
Millisecond (upper)	Stored in BCD code.	7H
Millisecond (lower)		89H

*¹ Values stored when an alarm occurs at 12:34:56.789 on Saturday, January 31st, 2015.

■ Buffer memory address

The following shows the buffer memory address of this area.

Buffer memory name	No.1 to No.16
Alarm history	3760 to 3919
Alarm history (in Q compatible mode)	3760 to 3919

A

Save data type setting (Save data type setting 1)



This area is intended for the R60DA8-G or CH1 to CH8 of the R60DA16-G. When using CH9 to CH16 of the R60DA16-G, refer to the following.

☞ Page 134 Save data type setting 2

This area saves and restores the offset/gain setting value in user range setting.

Specify the range setting of the offset/gain value to be saved and restored.

b15	b14	b13	b12	b11	b10	b9	b8	b7	b6	b5	b4	b3	b2	b1	b0
CH8	CH7	CH6	CH5	CH4	CH3	CH2	CH1								

00: User range setting 1, 01: User range setting 2, 10: User range setting 3

■Buffer memory address

The following shows the buffer memory address of this area.

Buffer memory name	CH1	CH2	CH3	CH4	CH5	CH6	CH7	CH8
Save data type setting (Save data type setting 1)	4002							
Save data type setting (in Q compatible mode)	200							

■Default value

The default value is 0 for all channels.

Save data type setting 2



This area is intended for CH9 to CH16 of the R60DA16-G. In using the R60DA8-G, this area is a system area. When using the R60DA8-G or CH1 to CH8 of the R60DA16-G, refer to the following.

☞ Page 134 Save data type setting (Save data type setting 1)

This area saves and restores the offset/gain setting value in user range setting.

Specify the range setting of the offset/gain value to be saved and restored.

b15	b14	b13	b12	b11	b10	b9	b8	b7	b6	b5	b4	b3	b2	b1	b0
CH16	CH15	CH14	CH13	CH12	CH11	CH10	CH9								

00: User range setting 1, 01: User range setting 2, 10: User range setting 3

■Buffer memory address

The following shows the buffer memory address of this area.

Buffer memory name	CH9	CH10	CH11	CH12	CH13	CH14	CH15	CH16
Save data type setting 2	4003							

■Default value

The default value is 0 for all channels.

CH1 Factory default setting

This area restores the offset/gain setting value in user range setting. For details, refer to the following.

☞ Page 135 CH1 User range setting

CH1 User range setting

This area restores the offset/gain setting value in user range setting.

■ Buffer memory address

The following shows the buffer memory address of this area.

- For the R60DA8-G

Buffer memory name	CH1	CH2	CH3	CH4	CH5	CH6	CH7	CH8
CH□ Factory default setting offset value	4004	4006	4008	4010	4012	4014	4016	4018
CH□ Factory default setting gain value	4005	4007	4009	4011	4013	4015	4017	4019
CH□ User range setting offset value	4020	4022	4024	4026	4028	4030	4032	4034
CH□ User range setting gain value	4021	4023	4025	4027	4029	4031	4033	4035
CH□ Factory default setting offset value (When the Q compatible mode function is used)	202	204	206	208	210	212	226	228
CH□ Factory default setting gain value (When the Q compatible mode function is used)	203	205	207	209	211	213	227	229
CH□ User range setting offset value (When the Q compatible mode function is used)	214	216	218	220	222	224	230	232
CH□ User range settings gain value (When the Q compatible mode function is used)	215	217	219	221	223	225	231	233

- For the R60DA16-G

Buffer memory name	Address							
CH□ Factory default setting offset value	CH1	CH2	CH3	CH4	CH5	CH6	CH7	CH8
	4004	4006	4008	4010	4012	4014	4016	4018
	CH9	CH10	CH11	CH12	CH13	CH14	CH15	CH16
	4020	4022	4024	4026	4028	4030	4032	4034
CH□ Factory default setting gain value	CH1	CH2	CH3	CH4	CH5	CH6	CH7	CH8
	4005	4007	4009	4011	4013	4015	4017	4019
	CH9	CH10	CH11	CH12	CH13	CH14	CH15	CH16
	4021	4023	4025	4027	4029	4031	4033	4035
CH□ User range setting offset value	CH1	CH2	CH3	CH4	CH5	CH6	CH7	CH8
	4036	4038	4040	4042	4044	4046	4048	4050
	CH9	CH10	CH11	CH12	CH13	CH14	CH15	CH16
	4052	4054	4056	4058	4060	4062	4064	4066
CH□ User range setting gain value	CH1	CH2	CH3	CH4	CH5	CH6	CH7	CH8
	4037	4039	4041	4043	4045	4047	4049	4051
	CH9	CH10	CH11	CH12	CH13	CH14	CH15	CH16
	4053	4055	4057	4059	4061	4063	4065	4067

When the following operations are performed, the data to be used is stored (saved).

- Writing the initial setting by engineering tool
- Turning off and on 'Operating condition setting request' (Y9) (Data is not saved when the mode is switched from the normal mode to the offset/gain setting mode by the mode switching setting.)
- Writing an offset/gain value in the offset/gain setting mode (When 'User range write request' (YA) is turned off and on)

When restoring the offset/gain setting value in user range setting, set the same data as the saved data in this area to the corresponding area of the D/A converter module that is the restoration destination.

For details on the offset/gain setting, refer to the following.

📖 MELSEC iQ-R Channel Isolated Digital-Analog Converter Module User's Manual (Startup)

■ Default value

The default value is 0 for all channels.

Offset/gain adjustment value specification

Set the adjustment amount of the analog output value in the offset/gain setting mode.

For details on the offset/gain setting, refer to the following.

 MELSEC iQ-R Channel Isolated Digital-Analog Converter Module User's Manual (Startup)

■Buffer memory address

The following shows the buffer memory address of this area.

Buffer memory name	CH 1	CH 2	CH 3	CH 4	CH 5	CH 6	CH 7	CH 8	CH 9	CH 10	CH 11	CH 12	CH 13	CH 14	CH 15	CH 16
Offset/gain adjustment value specification	4130															
Offset/gain adjustment value specification (When the Q compatible mode function is used)	24															

■Setting range

The setting range is from -3000 to 3000.

Ex.

When the setting value is 1000

Analog output values are adjusted as shown below.

User range setting	Analog output value
User range setting 1	Approx. 0.36mA
User range setting 2	Approx. 370mV
User range setting 3	Approx. 97mV

■Enabling the setting

Turn off and on 'Set value change request' (YC).

■Default value

The default value is 0 for all channels.

Point

When the offset/gain setting is configured from the offset/gain setting window of an engineering tool, the setting is performed properly on the window. Therefore, a program is not required to perform the setting.

When a sequence program used for the MELSEC-Q series D/A converter module is utilized to configure the offset/gain setting, check that an appropriate value has been set in this area.

For the sequence programs for the MELSEC-Q series D/A converter module, refer to the following.

 Channel Isolated Digital-Analog Converter Module User's Manual

CH1 Offset/gain setting mode

Specify the channel where the offset/gain setting is adjusted.

- Offset/gain setting mode (offset specification): Channel to adjust the offset
- Offset/gain setting mode (gain specification): Channel to adjust the gain

Setting value	Description
0	Disable
1	Setting channel

Multiple channels cannot be set at the same time. Set Disable (0) in Offset/gain setting mode (offset specification) or in Offset/gain setting mode (gain specification).

When a value other than the above is set, an offset/gain setting channel range error (error code: 1E8□H) occurs.

In the following cases, an offset/gain setting channel specification error (error code: 1E50H) occurs.

- When Setting channel (1) is set for both of Offset/gain setting mode (offset specification) and Offset/gain setting mode (gain specification)
- When Disable (0) is set for both of Offset/gain setting mode (offset specification) and Offset/gain setting mode (gain specification)
- When multiple channels are set at the same time

■Buffer memory address

The following shows the buffer memory address of this area.

- CH□ Offset/gain setting mode (offset specification)

CH1	CH2	CH3	CH4	CH5	CH6	CH7	CH8	CH9	CH10	CH11	CH12	CH13	CH14	CH15	CH16
4132	4134	4136	4138	4140	4142	4144	4146	4148	4150	4152	4154	4156	4158	4160	4162

- CH□ Offset/gain setting mode (gain specification)

CH1	CH2	CH3	CH4	CH5	CH6	CH7	CH8	CH9	CH10	CH11	CH12	CH13	CH14	CH15	CH16
4133	4135	4137	4139	4141	4143	4145	4147	4149	4151	4153	4155	4157	4159	4161	4163

■Enabling the setting

Turn off and on 'Channel change request' (YB).

■Default value

The default value is Disable (0) for all channels.

Offset/gain setting mode [Q compatible mode]

When the Q compatible mode function is used, specify the channel where the offset/gain setting is adjusted.

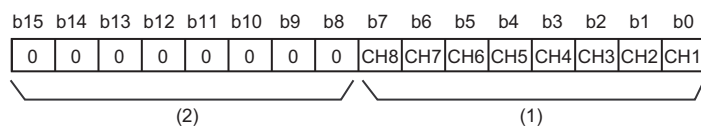

(1) 0: Disable, 1: Setting channel

(2) b8 to b15 are fixed to 0.

■Buffer memory address

The following shows the buffer memory address of this area.

Only the R60DA8-G can use this area.

Buffer memory name	CH1	CH2	CH3	CH4	CH5	CH6	CH7	CH8
Offset/gain setting mode (offset specification) (in Q compatible mode)	22							
Offset/gain setting mode (gain specification) (in Q compatible mode)	23							

■Enabling the setting

Turn off and on 'Channel change request' (YB).

■Default value

The default value is Disable (0) for all channels.

Point

When the offset/gain setting is configured from the offset/gain setting window of an engineering tool, the setting is performed properly on the window. Therefore, a program is not required to perform the setting. When a sequence program used for the MELSEC-Q series D/A converter module is utilized to configure the offset/gain setting, check that an appropriate value has been set in this area.

For the sequence programs for the MELSEC-Q series D/A converter module, refer to the following.

Channel Isolated Digital-Analog Converter Module User's Manual

CH1 Offset/gain setting mode (range specification)

The output range can be changed in the offset/gain setting.

The output range is changed to the set one by 'Channel change request' (YB).

Setting value	Description
DH	User range setting 3
EH	User range setting 2
FH	User range setting 1

When a value other than the above is set, an offset/gain setting range error (error code: 1E9□H) occurs.

■Buffer memory address

The following shows the buffer memory address of this area.

- CH□ Offset/gain setting mode (range specification)

CH1	CH2	CH3	CH4	CH5	CH6	CH7	CH8	CH9	CH10	CH11	CH12	CH13	CH14	CH15	CH16
4164	4165	4166	4167	4168	4169	4170	4171	4172	4173	4174	4175	4176	4177	4178	4179

■Enabling the setting

Turn off and on 'Channel change request' (YB).

■Default value

The default value is 0H for all channels.



When the offset/gain setting is configured from the offset/gain setting window of an engineering tool, the setting is performed properly on the window. Therefore, a program is not required to perform the setting. When a sequence program used for the MELSEC-Q series D/A converter module is utilized to configure the offset/gain setting, check that an appropriate value has been set in this area.

For the sequence programs for the MELSEC-Q series D/A converter module, refer to the following.

Channel Isolated Digital-Analog Converter Module User's Manual

Offset/gain setting mode (range specification) [Q compatible mode]

The output range can be changed in the offset/gain setting when the Q compatible mode function is used.
The setting written in 'Offset/gain setting mode (range specification)' (Un\G25) is applied to all the channels.

Setting value	Description
DH	User range setting 3
EH	User range setting 2
FH	User range setting 1

■Buffer memory address

The following shows the buffer memory address of this area.
Only the R60DA8-G can use this area.

Buffer memory name	CH1	CH2	CH3	CH4	CH5	CH6	CH7	CH8
Offset/gain setting mode (range specification) (in Q compatible mode)	25							

■Enabling the setting

Turn off and on 'Channel change request' (YB).

■Default value

The default value is 0H for all channels.

Point

When the offset/gain setting is configured from the offset/gain setting window of an engineering tool, the setting is performed properly on the window. Therefore, a program is not required to perform the setting.
When a sequence program used for the MELSEC-Q series D/A converter module is utilized to configure the offset/gain setting, check that an appropriate value has been set in this area.

For the sequence programs for the MELSEC-Q series D/A converter module, refer to the following.

 Channel Isolated Digital-Analog Converter Module User's Manual

Command area for module invalidation

For the R60DA8-G with its safety module function enabled, set this area to 1234H to disable the safety module function in standard mode.

■Buffer memory address

The following shows the buffer memory address of this area.

Only the R60DA8-G can use this area.

Buffer memory name	CH1	CH2	CH3	CH4	CH5	CH6	CH7	CH8
Command area for module invalidation	4200							

■Enabling the setting

Turn on and off 'Operating condition setting request' (Y9) to enable the setting.

Point

If this area is set to a value other than 1234H and 'Operating condition setting request' (Y9) is turned on and off, the safety module function is not disabled.

■Default value

The default value is set to 0000H.

■Procedure for disabling the safety module

For details, refer to the following.

 Page 153 Disabling the Safety Module

Validation status area

Whether the safety module function is enabled or disabled is stored.

Stored value	Description	Remarks
0	Disable	Indicates that the safety module function of the R60DA8-G is disabled.
1	Enable	Indicates that the safety module function of the R60DA8-G is enabled.

If the R60DA8-G is started up in standard mode while the stored value of this area is Enable (1), an error (start-up in standard mode with safety validated (error code: 3040H)) occurs.

■Buffer memory address

The following shows the buffer memory address of this area.

Only the R60DA8-G can use this area.

Buffer memory name	CH1	CH2	CH3	CH4	CH5	CH6	CH7	CH8
Validation status area	4201							

Appendix 4 Dedicated Instructions

Instruction list

The following table lists the dedicated instructions that can be used in the D/A converter module.

Instruction	Description
G(P).OFFGAN	Switches normal mode to offset/gain setting mode. Switches offset/gain setting mode to normal mode.
G(P).OGLOAD	Reads out the offset/gain setting value in the user range setting to write it into the CPU module.
G(P).OGSTOR	Restores the offset/gain setting value in the user range setting stored in the CPU module into the D/A converter module.

For details on the dedicated instructions, refer to the following.

 MELSEC iQ-R Programming Manual (Module Dedicated Instructions)

Appendix 5 Operation Examples of When the Remote Head Module Is Mounted

This section describes operation examples of when the remote head module is mounted

System configuration example

The following system configuration is used to explain an example of operation.

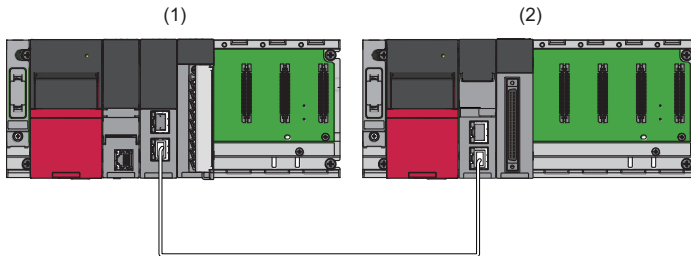

(1) Master station (Network number 1, station number 0)

- Power supply module: R61P
- CPU module: R04CPU
- Master/local module: RJ71GF11-T2 (Start I/O number: 0000H to 001FH)
- Input module: RX10 (Start I/O number: 0020H to 002FH)

(2) Intelligent device station (Network number 1, station number 1)

- Power supply module: R61P
- Remote head module: RJ72GF15-T2
- D/A converter module: R60DA8-G (Start I/O number: 0000H to 000FH)^{*1}

^{*1} In the RX/RV setting of the master station, set 1000H to 100FH as the start I/O number of the D/A converter module.

Setting in the master station

Connect the engineering tool to the CPU module of the master station and set parameters.

1. Create the project with the following settings.

 [Project] ⇒ [New]

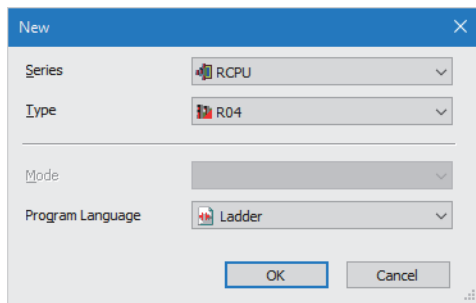

2. Click the [Setting Change] button and set the module to use the module label.
3. Click the [OK] button in the following window to add the module labels of the CPU module.

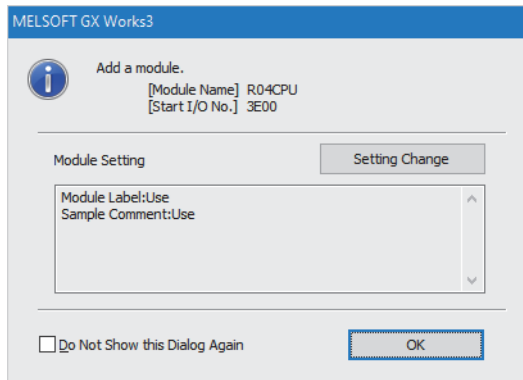

4. Add the master/local module with the following settings.

 [Navigation window] ⇒ [Parameter] ⇒ [Module Information] ⇒ Right-click ⇒ [Add New Module]

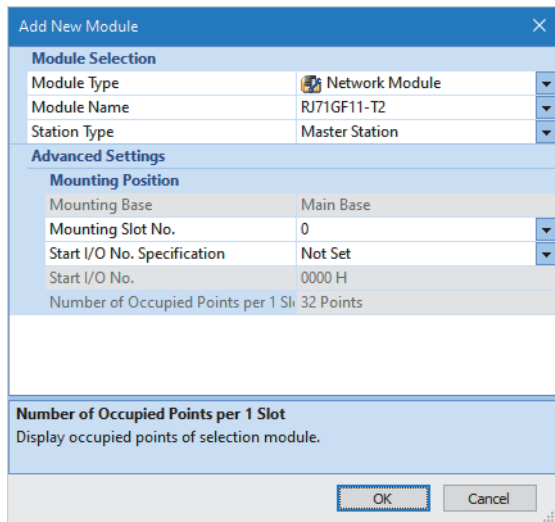

5. Click the [OK] button in the following window to add the module labels of the master/local module.

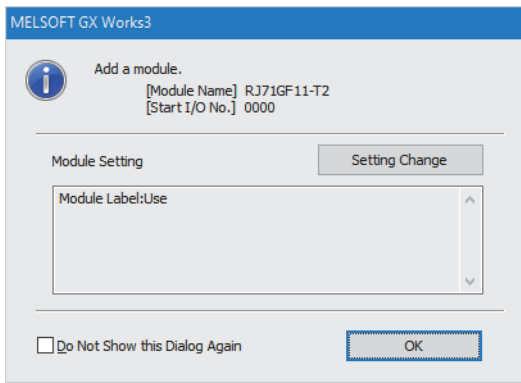

6. Set "Required Settings" of the module parameter of the master/local module as shown below.

[Navigation window] ⇒ [Parameter] ⇒ [Module Information] ⇒ [RJ71GF11-T2] ⇒ [Required Settings]

Item	Setting
Station Type	
Station Type	Master Station
Network Number	
Network Number	1
Station Number	
Setting Method	Parameter Editor
Station No.	0
Parameter Setting Method	
Setting Method of Basic/Application Settings	Parameter Editor

7. Set "Network Configuration Settings" of the module parameter of the master/local module as shown below.



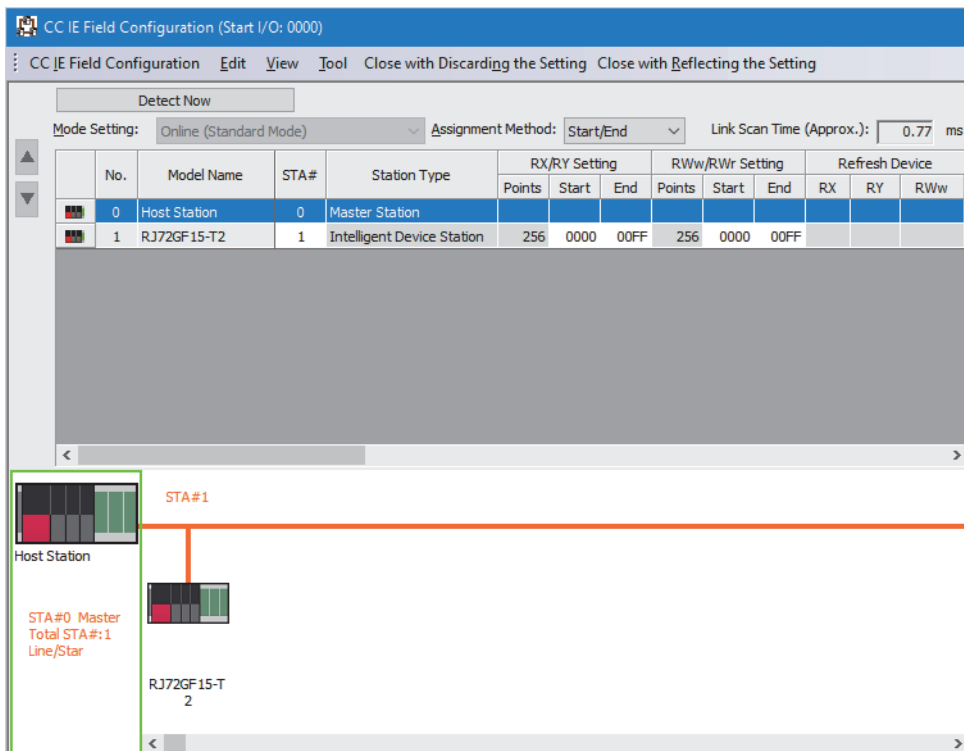



[Navigation window] ⇒ [Parameter] ⇒ [Module Information] ⇒ [RJ71GF11-T2] ⇒ [Basic Settings] ⇒ [Network Configuration Settings]



A

8. Set "Refresh Setting" of the module parameter of the master/local module as shown below.

 [Navigation window] ⇒ [Parameter] ⇒ [Module Information] ⇒ [RJ71GF11-T2] ⇒ [Basic Settings] ⇒ [Refresh Setting]

No.	Link Side						CPU Side				
	Device Name	Points	Start	End	Target		Device Name	Points	Start	End	
-	SB	512	00000	001FF		Module Label					
-	SW	512	00000	001FF		Module Label					
1	RX	256	00000	000FF		Specify Device	X	256	01000	010FF	
2	RY	256	00000	000FF		Specify Device	Y	256	01000	010FF	
3	RWw	256	00000	000FF		Specify Device	W	256	00000	000FF	
4	RWt	256	00000	000FF		Specify Device	W	256	01000	010FF	

9. Write the set parameters to the CPU module on the master station. Then reset the CPU module or power off and on the system.

 [Online] ⇒ [Write to PLC]

Point 

For parameters of the master/local module which are not described in this procedure, set default values. For details on parameters of the master/local module, refer to the following.

 MELSEC iQ-R CC-Link IE Field Network User's Manual (Application)

Setting in the intelligent device station

Connect the engineering tool to the remote head module of the intelligent device station and set parameters.

1. Create the project with the following settings.

[Project] ⇒ [New]

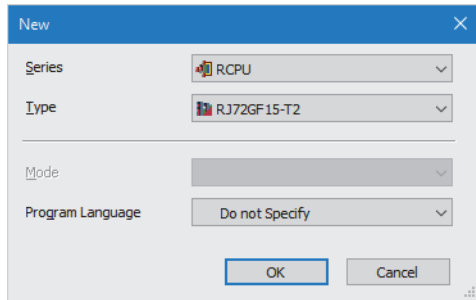

2. Set "Network Required Setting" of "CPU Parameter" of the remote head module as shown below.

[Navigation window] ⇒ [Parameter] ⇒ [RJ72GF15-T2] ⇒ [CPU Parameter] ⇒ [Network Required Setting]

Item	Setting
Network Number	
Network Number	1
Station Number	
Station No.	1

3. Add the D/A converter module with the following settings.

[Navigation window] ⇒ [Parameter] ⇒ [Module Information] ⇒ Right-click ⇒ [Add New Module]

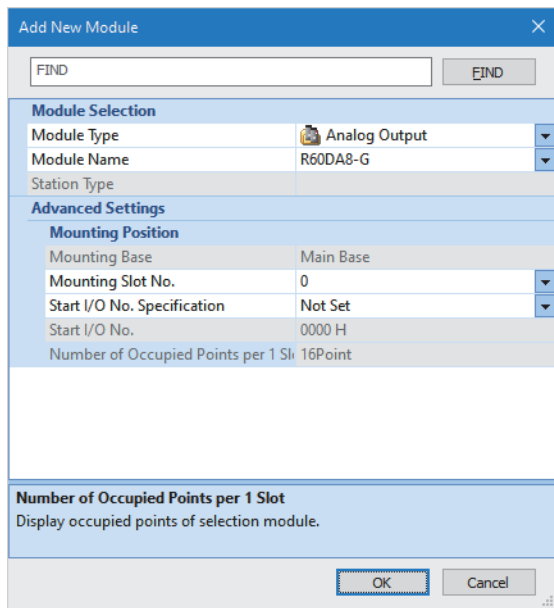

4. Configure the setting not to use the module labels.

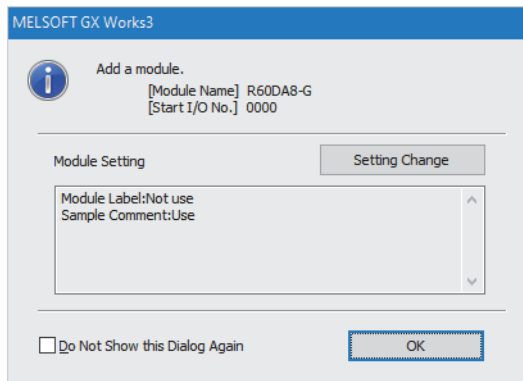

5. Set "Basic setting" of the module parameter of the D/A converter module as shown below.

[Navigation window] ⇒ [Parameter] ⇒ [Module Information] ⇒ [R60DA8-G] ⇒ [Basic setting]

Item	CH1	CH2	CH3	CH4	CH5	CH6	CH7	CH8
Range switching function	This function enables to select the output range to be used from multiple ranges.							
Output range setting	-10 to 10V	4 to 20mA	-10 to 10V	4 to 20mA	0 to 20mA	4 to 20mA	4 to 20mA	4 to 20mA
Operation mode setting function	The two operation modes, "Normal mode" to execute the D/A conversion and "Offset/gain setting mode" to execute the offset/gain setting, can be set.							
Operation mode setting	Normal mode (D/A conversion process)							
Output mode setting function	HOLD or CLEAR can be set in the analog output HOLD/CLEAR setting.							
Analog output HOLD/CLEAR setting	HOLD	CLEAR	HOLD	CLEAR	HOLD	CLEAR	HOLD	CLEAR
D/A conversion enable/disable function	This function sets whether to enable or disable the D/A conversion for each channel.							
D/A conversion enable/disable setting	D/A conversion enable	D/A conversion disable	D/A conversion enable	D/A conversion disable	D/A conversion enable	D/A conversion disable	D/A conversion enable	D/A conversion disable

6. Set "Application setting" of the module parameter of the D/A converter module as shown below.

[Navigation window] ⇒ [Parameter] ⇒ [Module Information] ⇒ [R60DA8-G] ⇒ [Application setting]

Item	CH1	CH2	CH3	CH4	CH5	CH6	CH7	CH8
Scaling function	This function enables to change the upper limit value or lower limit value of the digital value input range to any value.							
Scaling enable/disable setting	Disable	Disable	Disable	Disable	Enable	Disable	Disable	Disable
Scaling upper limit value	0	0	0	0	16000	0	0	0
Scaling lower limit value	0	0	0	0	2000	0	0	0
Shift function	This function adds the set amount to the digital value. A fine adjustment at the system startup can be easily performed.							
Input value shift amount	0	0	0	0	2000	0	0	0
Warning output function	This function outputs an Warning when the digital value is outside the setting range.							
Warning output setting	Disable	Disable	Enable	Disable	Disable	Disable	Disable	Disable
Warning output upper limit value	0	0	32000	0	0	0	0	0
Warning output lower limit value	0	0	0	0	0	0	0	0
Rate control function	This function controls the increasing and decreasing amount of the analog output value per conversion cycle for one channel.							
Rate control enable/disable setting	Enable	Disable	Disable	Disable	Disable	Disable	Disable	Disable
Increase digital limit value	8000	64000	64000	64000	64000	64000	64000	64000
Decrease digital limit value	1600	64000	64000	64000	64000	64000	64000	64000
Online module change	The module can be changed without the system being stopped.							
Auto restore of Offset/ gain setting with the module change	Enable							
CPU error output mode setting	You can be the setting of whether to keep or not to clear the output of the module to the CPU stop error.							
CPU error output mode setting	Hold							

7. Set "Refresh settings" of the module parameter of the D/A converter module as shown below.

 [Navigation window] ⇒ [Parameter] ⇒ [Module Information] ⇒ [R60DA8-G] ⇒ [Refresh settings]

Setting Item									
Target	Device							Number of transfers to intelligent function module	4
								Number of transfers to CPU	4
Item	CH1	CH2	CH3	CH4	CH5	CH6	CH7	CH8	
Refresh at the set timing.									
Transfer to the intelligent function module.									
Digital value	Transfer the buffer memory data to the specified device.								
	W1	W2	W3	W4					
Transfer to the CPU.									
Latest error code	Transfer the buffer memory data to the specified device.								
Latest address of error history	W1010								
Latest alarm code									
Latest address of alarm history									
Interrupt factor detection flag 1									
Interrupt factor detection flag 2									
Interrupt factor detection flag 3									
Interrupt factor detection flag 4									
Interrupt factor detection flag 5									
Interrupt factor detection flag 6									
Interrupt factor detection flag 7									
Interrupt factor detection flag 8									
Interrupt factor detection flag 9									
Interrupt factor detection flag 10									
Interrupt factor detection flag 11									
Interrupt factor detection flag 12									
Interrupt factor detection flag 13									
Interrupt factor detection flag 14									
Interrupt factor detection flag 15									
Interrupt factor detection flag 16									
Set value check code									
Warning output upper flag	W1008								
Warning output lower flag	W1009								
Disconnection detection flag	W1011								

8. Write the set parameters to the remote head module on the intelligent device station. Then reset the remote head module or power off and on the system.

 [Online] ⇒ [Write to PLC]

A

Point

For parameters of the remote head module which are not described in this procedure, set default values. For details on parameters of the remote head module, refer to the following.

 MELSEC iQ-R CC-Link IE Field Network Remote Head Module User's Manual (Application)

Checking the network status

After setting parameters to the master station and the intelligent device station, check whether data link is normally performed between the master station and the intelligent device station. Check the network status using the CC-Link IE Field Network diagnostics of the engineering tool.

For how to perform the CC-Link IE Field Network diagnostics from the master station, refer to the following.

MELSEC iQ-R CC-Link IE Field Network User's Manual (Application)

Program examples

For the program examples, the module labels of the master/local module are used.

Write the programs to the CPU module on the master station.

Classification	Label name	Description	Device																																																																																																																																							
Module label	GF11_1.bSts_DataLinkError	Data link error status of own station	SB0049																																																																																																																																							
	GF11_1.bnSts_DataLinkError_Station[1]	Data link status of each station (station number 1)	SW00B0.0																																																																																																																																							
Label to be defined	Define global labels as shown below:																																																																																																																																									
<table border="1"> <thead> <tr> <th></th> <th>Label Name</th> <th>Data Type</th> <th>Class</th> <th>Assign (Device/Label)</th> </tr> </thead> <tbody> <tr><td>1</td><td>ModuleREADY</td><td>Bit</td><td>VAR_GLOBAL</td><td>X1 000</td></tr> <tr><td>2</td><td>ExternalPowerSupplyREADY/Flag</td><td>Bit</td><td>VAR_GLOBAL</td><td>X1 007</td></tr> <tr><td>3</td><td>DisconnectionDetectionSignal</td><td>Bit</td><td>VAR_GLOBAL</td><td>X1 00D</td></tr> <tr><td>4</td><td>WarningOutputSignal</td><td>Bit</td><td>VAR_GLOBAL</td><td>X1 00E</td></tr> <tr><td>5</td><td>ErrorFlag</td><td>Bit</td><td>VAR_GLOBAL</td><td>X1 00F</td></tr> <tr><td>6</td><td>CH1_OutputEnableDisableFlag</td><td>Bit</td><td>VAR_GLOBAL</td><td>Y1 001</td></tr> <tr><td>7</td><td>CH3_OutputEnableDisableFlag</td><td>Bit</td><td>VAR_GLOBAL</td><td>Y1 003</td></tr> <tr><td>8</td><td>CH5_OutputEnableDisableFlag</td><td>Bit</td><td>VAR_GLOBAL</td><td>Y1 005</td></tr> <tr><td>9</td><td>CH7_OutputEnableDisableFlag</td><td>Bit</td><td>VAR_GLOBAL</td><td>Y1 007</td></tr> <tr><td>10</td><td>WarningOutputClearRequest</td><td>Bit</td><td>VAR_GLOBAL</td><td>Y1 00E</td></tr> <tr><td>11</td><td>ErrorClearRequest</td><td>Bit</td><td>VAR_GLOBAL</td><td>Y1 00F</td></tr> <tr><td>12</td><td>CH1_DiagnVal</td><td>Word (Signed)</td><td>VAR_GLOBAL</td><td>W1</td></tr> <tr><td>13</td><td>CH3_DiagnVal</td><td>Word (Signed)</td><td>VAR_GLOBAL</td><td>W2</td></tr> <tr><td>14</td><td>CH5_DiagnVal</td><td>Word (Signed)</td><td>VAR_GLOBAL</td><td>W3</td></tr> <tr><td>15</td><td>CH7_DiagnVal</td><td>Word (Signed)</td><td>VAR_GLOBAL</td><td>W4</td></tr> <tr><td>16</td><td>WarningOutputUpperFlag</td><td>Word (Signed)</td><td>VAR_GLOBAL</td><td>W1 008</td></tr> <tr><td>17</td><td>WarningOutputLowerFlag</td><td>Word (Signed)</td><td>VAR_GLOBAL</td><td>W1 009</td></tr> <tr><td>18</td><td>DisconnectionDetectionFlag</td><td>Word (Signed)</td><td>VAR_GLOBAL</td><td>W1 011</td></tr> <tr><td>19</td><td>CH3_AlmUpLimit</td><td>Bit</td><td>VAR_GLOBAL</td><td>F0</td></tr> <tr><td>20</td><td>CH3_AlmLowLimit</td><td>Bit</td><td>VAR_GLOBAL</td><td>F1</td></tr> <tr><td>21</td><td>CH7_DisconnectDetect</td><td>Bit</td><td>VAR_GLOBAL</td><td>F2</td></tr> <tr><td>22</td><td>DiagnWriteSig</td><td>Bit</td><td>VAR_GLOBAL</td><td>X2 0</td></tr> <tr><td>23</td><td>DAOutputSig</td><td>Bit</td><td>VAR_GLOBAL</td><td>X21</td></tr> <tr><td>24</td><td>WarningOutputClrSig</td><td>Bit</td><td>VAR_GLOBAL</td><td>X22</td></tr> <tr><td>25</td><td>ErrResetSig</td><td>Bit</td><td>VAR_GLOBAL</td><td>X23</td></tr> <tr><td>26</td><td>ConnectFormationFlagSt1</td><td>Bit</td><td>VAR_GLOBAL</td><td>IM0</td></tr> </tbody> </table>					Label Name	Data Type	Class	Assign (Device/Label)	1	ModuleREADY	Bit	VAR_GLOBAL	X1 000	2	ExternalPowerSupplyREADY/Flag	Bit	VAR_GLOBAL	X1 007	3	DisconnectionDetectionSignal	Bit	VAR_GLOBAL	X1 00D	4	WarningOutputSignal	Bit	VAR_GLOBAL	X1 00E	5	ErrorFlag	Bit	VAR_GLOBAL	X1 00F	6	CH1_OutputEnableDisableFlag	Bit	VAR_GLOBAL	Y1 001	7	CH3_OutputEnableDisableFlag	Bit	VAR_GLOBAL	Y1 003	8	CH5_OutputEnableDisableFlag	Bit	VAR_GLOBAL	Y1 005	9	CH7_OutputEnableDisableFlag	Bit	VAR_GLOBAL	Y1 007	10	WarningOutputClearRequest	Bit	VAR_GLOBAL	Y1 00E	11	ErrorClearRequest	Bit	VAR_GLOBAL	Y1 00F	12	CH1_DiagnVal	Word (Signed)	VAR_GLOBAL	W1	13	CH3_DiagnVal	Word (Signed)	VAR_GLOBAL	W2	14	CH5_DiagnVal	Word (Signed)	VAR_GLOBAL	W3	15	CH7_DiagnVal	Word (Signed)	VAR_GLOBAL	W4	16	WarningOutputUpperFlag	Word (Signed)	VAR_GLOBAL	W1 008	17	WarningOutputLowerFlag	Word (Signed)	VAR_GLOBAL	W1 009	18	DisconnectionDetectionFlag	Word (Signed)	VAR_GLOBAL	W1 011	19	CH3_AlmUpLimit	Bit	VAR_GLOBAL	F0	20	CH3_AlmLowLimit	Bit	VAR_GLOBAL	F1	21	CH7_DisconnectDetect	Bit	VAR_GLOBAL	F2	22	DiagnWriteSig	Bit	VAR_GLOBAL	X2 0	23	DAOutputSig	Bit	VAR_GLOBAL	X21	24	WarningOutputClrSig	Bit	VAR_GLOBAL	X22	25	ErrResetSig	Bit	VAR_GLOBAL	X23	26	ConnectFormationFlagSt1	Bit	VAR_GLOBAL	IM0
	Label Name	Data Type	Class	Assign (Device/Label)																																																																																																																																						
1	ModuleREADY	Bit	VAR_GLOBAL	X1 000																																																																																																																																						
2	ExternalPowerSupplyREADY/Flag	Bit	VAR_GLOBAL	X1 007																																																																																																																																						
3	DisconnectionDetectionSignal	Bit	VAR_GLOBAL	X1 00D																																																																																																																																						
4	WarningOutputSignal	Bit	VAR_GLOBAL	X1 00E																																																																																																																																						
5	ErrorFlag	Bit	VAR_GLOBAL	X1 00F																																																																																																																																						
6	CH1_OutputEnableDisableFlag	Bit	VAR_GLOBAL	Y1 001																																																																																																																																						
7	CH3_OutputEnableDisableFlag	Bit	VAR_GLOBAL	Y1 003																																																																																																																																						
8	CH5_OutputEnableDisableFlag	Bit	VAR_GLOBAL	Y1 005																																																																																																																																						
9	CH7_OutputEnableDisableFlag	Bit	VAR_GLOBAL	Y1 007																																																																																																																																						
10	WarningOutputClearRequest	Bit	VAR_GLOBAL	Y1 00E																																																																																																																																						
11	ErrorClearRequest	Bit	VAR_GLOBAL	Y1 00F																																																																																																																																						
12	CH1_DiagnVal	Word (Signed)	VAR_GLOBAL	W1																																																																																																																																						
13	CH3_DiagnVal	Word (Signed)	VAR_GLOBAL	W2																																																																																																																																						
14	CH5_DiagnVal	Word (Signed)	VAR_GLOBAL	W3																																																																																																																																						
15	CH7_DiagnVal	Word (Signed)	VAR_GLOBAL	W4																																																																																																																																						
16	WarningOutputUpperFlag	Word (Signed)	VAR_GLOBAL	W1 008																																																																																																																																						
17	WarningOutputLowerFlag	Word (Signed)	VAR_GLOBAL	W1 009																																																																																																																																						
18	DisconnectionDetectionFlag	Word (Signed)	VAR_GLOBAL	W1 011																																																																																																																																						
19	CH3_AlmUpLimit	Bit	VAR_GLOBAL	F0																																																																																																																																						
20	CH3_AlmLowLimit	Bit	VAR_GLOBAL	F1																																																																																																																																						
21	CH7_DisconnectDetect	Bit	VAR_GLOBAL	F2																																																																																																																																						
22	DiagnWriteSig	Bit	VAR_GLOBAL	X2 0																																																																																																																																						
23	DAOutputSig	Bit	VAR_GLOBAL	X21																																																																																																																																						
24	WarningOutputClrSig	Bit	VAR_GLOBAL	X22																																																																																																																																						
25	ErrResetSig	Bit	VAR_GLOBAL	X23																																																																																																																																						
26	ConnectFormationFlagSt1	Bit	VAR_GLOBAL	IM0																																																																																																																																						

Common program

The following figure shows an example of the program to check the data link status of the remote head module (station number 1).

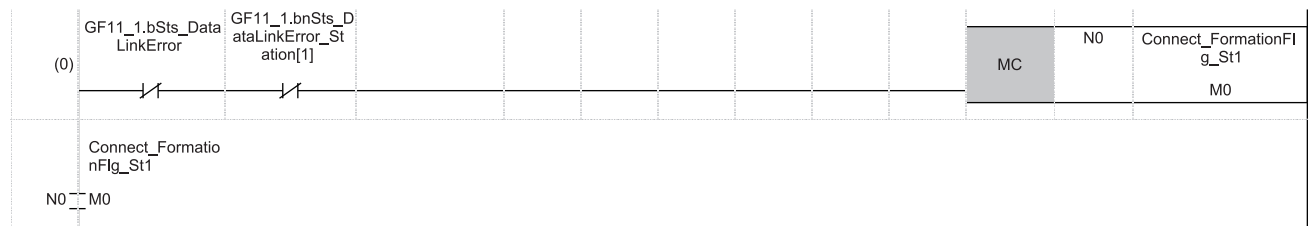

(0) Checks the data link status of the remote head module (station number 1).

Add the MCR instruction shown below to the last of the program.



Program example 1

The following figure shows an example of the program to start D/A conversion by setting the digital values for D/A conversion (CH1, CH3, CH5, CH7) and enabling analog output.

(31)	DigitWriteSig	ModuleREADY	ExternalPowerSupplyREADY_Flag	MOV	K10000	CH1_DigInVal
	X20	X1000	X1007			W1
				MOV	K10000	CH3_DigInVal
						W2
				MOV	K10000	CH5_DigInVal
						W3
				MOV	K10000	CH7_DigInVal
						W4
(106)	DAOutputSig	ModuleREADY	ExternalPowerSupplyREADY_Flag	SET		CH1_OutputEnableDisableFlag
	X21	X1000	X1007			Y1001
				SET		CH3_OutputEnableDisableFlag
						Y1003
				SET		CH5_OutputEnableDisableFlag
						Y1005
				SET		CH7_OutputEnableDisableFlag
						Y1007
(162)	DAOutputSig			RST		CH1_OutputEnableDisableFlag
	X21					Y1001
	ModuleREADY			RST		CH3_OutputEnableDisableFlag
	X1000					Y1003
	ExternalPowerSupplyREADY_Flag			RST		CH5_OutputEnableDisableFlag
	X1007					Y1005
				RST		CH7_OutputEnableDisableFlag
						Y1007

(31) Sets values in CH1 Digital value, CH3 Digital value, CH5 Digital value, and CH7 Digital value.

(106) Enables output for CH1, CH3, CH5, and CH7.

(162) Disables output for CH1, CH3, CH5, and CH7 when any of the following signals is off.

- 'D/A output enable command signal' (X21)
- 'Module READY' (X1000)
- 'External power supply READY flag (CH1 to CH8)' (X1007)

Program example 2

The following figure shows an example of the program to perform operations reacting to an alert (such as processing of when an alert has occurred or clearing an alert) if an alert occurs in CH3.

(205)	WarningOutputUpperFlag.2 W1008.2								SET	CH3_AlmUpLimit F0
(220)	WarningOutputLowerFlag.2 W1009.2								SET	CH3_AlmLowLimit F1
(225)	WarningOutClrSig X22	WarningOutputSignal X100E							SET	WarningOutputClearRequest Y100E
(243)	WarningOutputSignal X100E	WarningOutputClearRequest Y100E							RST	WarningOutputClearRequest Y100E

(205) Performs a processing of when an upper limit alert has occurred in CH3.

(220) Performs a processing of when a lower limit alert has occurred in CH3.

(225) Turns on 'Alert output clear request' (Y100E).

(243) Turns off 'Alert output clear request' (Y100E).

Program example 3

The following figure shows an example of the program to clear Disconnection detection flag, Error flag, and Latest error code if disconnection is detected in CH7 or an error occurs in any of the channels.

(261)	DisconnectionDetectionFlag.6 W1011.6								SET	CH7_DisconnectDetect F2
(274)	ErrorFlag X100F	ErrResetSig X23							SET	ErrorClearRequest Y100F
(289)	DisconnectionDetectionSignal X100D	ErrorFlag X100F	DisconnectionDetectionSignal X100D	ErrorClearRequest Y100F					RST	ErrorClearRequest Y100F

(261) Performs a processing of when disconnection was detected in CH7.

(274) Turns on 'Error clear request' (Y100F).

(289) Turns off 'Error clear request' (Y100F).

Appendix 6 Disabling the Safety Module

For the R60DA8-G whose function as the safety module for SIL2 mode was enabled in the other system, to use this module in standard mode, disabling its safety module function is required. If the R60DA8-G is started up in standard mode with the safety module function enabled, an error (start-up in standard mode with safety validated (error code: 3040H)) occurs. The R60DA8-G does not operate normally until its safety module function becomes disabled.

Safety module validity status check

Whether the safety module function is enabled or not can be checked with Validation status area (Un\G4201).

- The R60DA8-G does not operate normally in standard mode while Enable (1) is stored in Validation status area (Un\G4201). In such a case, disabling the safety module function is required. Note that for the R60DA8-G operating in standard mode, its safety module function cannot be disabled through "Safety Module Operation" of GX Works3.
- The R60DA8-G operates normally in standard mode when Disable (0) is stored in Validation status area (Un\G4201). In this case, disabling the safety module function is not required.

Procedure for disabling the safety module

1. Set Command area for module invalidation (Un\G4200) to 1234H and turn on and off 'Operating condition setting request' (Y9). This operation disables the safety module function of the R60DA8-G.
2. To check whether the safety module function becomes disabled or not, refer to the table below.

Disabling the safety module	Description
Succeeded	<ul style="list-style-type: none"> • Disable (0) is stored in Validation status area (Un\G4201). • The ALM LED flashes (400ms cycle). (The R60DA8-G waiting for restart)
Failed	<ul style="list-style-type: none"> • Enable (1) remains in Validation status area (Un\G4201). • The ALM LED does not flash (400ms cycle). • Failure of disabling safety module (error code: 1302H) is stored in 'Latest error code' (Un\G0).

3. If disabling the safety module fails, check that a set value in Command area for module invalidation (Un\G4200) is correct, and once again, turn on and off 'Operating condition setting request' (Y9) and check whether the safety module function is disabled.
4. When 'Operating condition setting request' (Y9) is turned on, 'Operating condition setting completed flag' (X9) turns off regardless of the result (succeed or fail) of disabling the safety module function.
3. After checking that the disabling has succeeded, reset the CPU module, or turn off and on the programmable controller's power to restart the R60DA8-G.
4. Check that the ALM LED is off. (The R60DA8-G is operating normally in standard mode.) If the ALM LED is on, it indicates that an alarm occurred, even though the R60DA8-G is operating in standard mode. Check 'Latest alarm code' (Un\G2), and take actions described in the list of alarm codes. (📄 Page 74 List of Alarm Codes)



Point

When disabling of the safety module is executed, the enable/disable status is saved to the flash memory inside the module, but the number of times this can be rewritten is limited. The number of possible rewrite operations combining both enabling/disabling is 250000 times. If this number of rewrite operations exceeds 250000 times, a number of safety module status switching exceeding limit error (error code: 1081H) occurs. Although rewrites of the validation status are executed, the rewrite content may not be reflected correctly.

Appendix 7 Using the Module in the Redundant System with Redundant Extension Base Unit

This chapter describes restrictions and precautions for using the D/A converter module that is mounted on the extension base unit in the redundant system.

Restrictions on functions and specifications

Functions

Function	Restriction
D/A output enable/disable setting function	If system switching occurs while the setting change of D/A conversion enable/disable setting is being attempted, the change may affect the D/A output enable/disable setting with time delay. Configure the circuit to externally turn off the analog output if necessary, for the case where the D/A output is changed to be disabled.
Interrupt function	The interrupt program cannot be executed.
Backing up, saving, and restoring offset/gain values	The function cannot be used for either of the following cases. <ul style="list-style-type: none">• When using the module-specific backup parameter• When saving and restoring the values using the dedicated instruction instead of the module-specific backup parameter

Dedicated instructions

Any dedicated instructions of the D/A converter module cannot be used.

Module FB

Name	Availability
M+R60DA_WaveDataStoreCsv	Cannot be used. When the FB is used, proper operation cannot be guaranteed.

Module parameter

■Application setting

Set "Auto restore of Offset/gain setting with the module change" to "Disable".

Precautions

When configuring the offset/gain setting

Connect the engineering tool to the CPU module of the control system.

The engineering tool cannot recognize the D/A converter module if it is connected to the CPU module of the standby system.

Program examples

Unless otherwise specified, program examples provided in this manual and the following manual are for when the module is used in the single CPU system or in the multiple CPU system.

 MELSEC iQ-R Channel Isolated Digital-Analog Converter Module User's Manual (Startup)

When using the module in the redundant system, refer to the following manual and observe the precautions on programming for when using the Process CPU (redundant mode).

 MELSEC iQ-R CPU Module User's Manual (Application)

Signal flow tracking setting

When using the module FBs and applying the program examples to an actual system, set "Signal Flow Memory Tracking Setting" to "Transfer". If not, the module FBs and programs may not work properly when system switching occurs.

 [CPU Parameter] ⇒ [Redundant System Settings] ⇒ [Tracking Setting]

Appendix 8 Added or Modified Functions

This section describes the functions added to or modified for the D/A converter module.

Added function

Addition	F: Firmware version of the D/A converter module S: Software version of the engineering tool	Reference
Disabling the safety module (R60DA8-G only)	F: "03" or later S: —	Page 153 Disabling the Safety Module

Modified functions

Modification	F: Firmware version of the D/A converter module S: Software version of the engineering tool	Reference
Disconnection detection function • 'CH1 Number of disconnection checks' (Un\G560) is added.	F: "02" or later S: "1.055H" or later	<ul style="list-style-type: none"> • Page 38 Disconnection Detection Function • Page 155 CH1 Number of disconnection checks
Disconnection detection function • 'CH1 Disconnection detection enable/disable setting' (Un\G558) is added. • 'CH1 Disconnection detection (extended mode) enable/disable setting' (Un\G559) is added. • 'CH1 Disconnection detection auto-clear enable/disable setting' (Un\G561) is added. • 'CH1 Number of disconnection detection auto-clear checks' (Un\G562) is added.	F: "04" or later S: "1.055H" or later	<ul style="list-style-type: none"> • Page 38 Disconnection Detection Function • Page 155 CH1 Disconnection detection enable/disable setting • Page 155 CH1 Disconnection detection (extended mode) enable/disable setting • Page 155 CH1 Disconnection detection auto-clear enable/disable setting • Page 156 CH1 Number of disconnection detection auto-clear checks

CH1 Number of disconnection checks

The number can be set within the range of 1 to 100.

■When a module that does not support this area is used

The module operates with this area being set to 1.

CH1 Disconnection detection enable/disable setting

When the analog output range is set to 4 to 20mA, whether to enable or disable the disconnection detection can be set with this area.

■When a module that does not support this area is used

The module operates with the disconnection detection enabled.

CH1 Disconnection detection (extended mode) enable/disable setting

When the analog output range is set to 4 to 20mA (extended mode), whether to enable or disable the disconnection detection can be set with this area.

■When a module that does not support this area is used

When the analog output range is set to 4 to 20mA (extended mode), the module operates with the disconnection detection disabled.

CH1 Disconnection detection auto-clear enable/disable setting

Whether to enable or disable the auto-clear operation of disconnection detection can be set with this area.

■When a module that does not support this area is used

The module operates with the auto-clear operation of disconnection detection disabled.

CH1 Number of disconnection detection auto-clear checks

The number can be set within the range of 1 to 1000 when the auto-clear operation of disconnection detection is enabled.

■When a module that does not support this area is used

The setting is ignored.

This part consists of the following chapters. These chapters describe the details on using the R60DA8-G in SIL2 mode and RY40PT5B-AS.

4 OVERVIEW

5 PART NAMES

6 SPECIFICATIONS

7 PROCEDURES BEFORE OPERATION

8 SYSTEM CONFIGURATION

9 INSTALLATION AND WIRING

10 FUNCTIONS

11 PARAMETER SETTINGS

12 EXAMPLE OF OPERATION

13 MAINTENANCE AND INSPECTION

14 TROUBLESHOOTING

APPENDICES (SIL2 MODE)

4 OVERVIEW

The R60AD8-G has SIL2 mode. This mode is used when a customer builds safety applications up to IEC 61508: 2010 SIL2 or IEC 61511: 2015 SIL2. Moreover, the RY40PT5B-AS, which is required to use the R60DA8-G in SIL2 mode, is certified according to the safety requirements of IEC61508: 2010 SIL2 and IEC61511: 2015 SIL2.

The R60DA8-G in SIL2 mode and the RY40PT5B-AS can be used to build safety functions for general industry machinery.

Module set

To use the R60DA8-G in SIL2 mode, it is necessary to use the following three modules in combination: one R60DA8-G module (SIL2 mode), one R60AD8-G module (normal mode), and one RY40PT5B-AS module.

This configuration of three modules is referred to as a module set in this manual. Also, a system using the module set is referred to as a SIL2 analog output system.

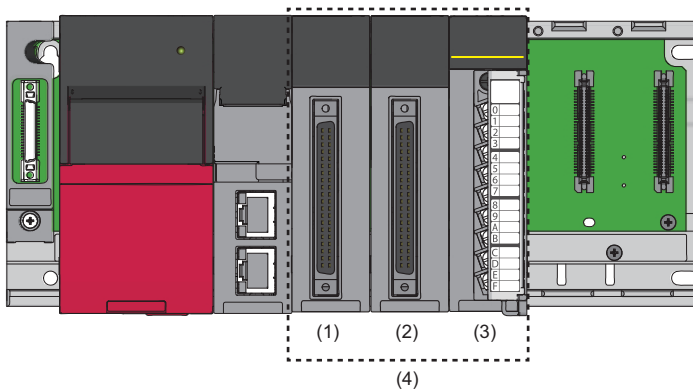

- (1) R60DA8-G set to SIL2 mode
- (2) R60AD8-G set to normal mode
- (3) RY40PT5B-AS
- (4) Module set

Further, to use the R60DA8-G in SIL2 mode, a redundant system must be configured based on a redundant master station or redundant line. The module set must be mounted with the remote head module.

For details, refer to the following.

➔ Page 176 SYSTEM CONFIGURATION

■R60DA8-G set to SIL2 mode

D/A conversion is performed according to the digital value set in the SIL2 diagnostic FB library. Since internal diagnostics of the D/A conversion circuit and other operations are performed by the R60AD8-G for diagnostics and RY40PT5B-AS, safe D/A conversion is achieved.

Set the following model name in the module configuration diagram of GX Works3 so that the R60DA8-G becomes Main in SIL2 mode.

Module	Model name in GX Works3
R60DA8-G (Main)	R60DA8-G(S2M)

■R60AD8-G

As the process of the D/A conversion circuit diagnostic function, the voltage or current is input to perform internal diagnostics of the D/A conversion circuit of the R60DA8-G.

Note that the R60AD8-G in the module set is referred to as the R60AD8-G for diagnostics in this manual.

For details on the D/A conversion circuit diagnostic function, refer to the following.

☞ Page 223 D/A conversion circuit diagnostic function

■RY40PT5B-AS

Relay is used to switch the analog output destination from the R60DA8-G.

- Analog output to external devices
- Analog output to the R60AD8-G for diagnostics

D/A conversion circuit diagnostics is executed by switching the analog output destination to the R60AD8-G for diagnostics.

SIL2 diagnostic FB library

To use the R60DA8-G in SIL2 mode, the SIL2 diagnostic FB library is required.

The SIL2 diagnostic FB library consists of SIL2 safety program FB running on the safety program and SIL2 standard program FB running on the standard program.

FB type	FB name	Description
SIL2 safety program FB (Safety program)	M+SIL2DAG_DACnv_R	Sets a digital value for the R60DA8-G. Also, relay switching is conducted by using the RY40PT5B-AS.
SIL2 standard program FB (Standard program)	M+SIL2DAG-IEF_ReadADVal_R	Obtains digital operation values from the R60AD8-G for diagnostics.

For details on the SIL2 diagnostic FB library, refer to the following.

☞ MELSEC iQ-R Channel Isolated Digital-Analog Converter Module SIL2 Diagnostic Function Block Library Reference

Safety communications

When the R60DA8-G is used in SIL2 mode, safety communications is conducted between the R60DA8-G and SIL2 Process CPU for data communication.

Safety communications are possible only through the paths with an arrow described as safety connections in the following figure.

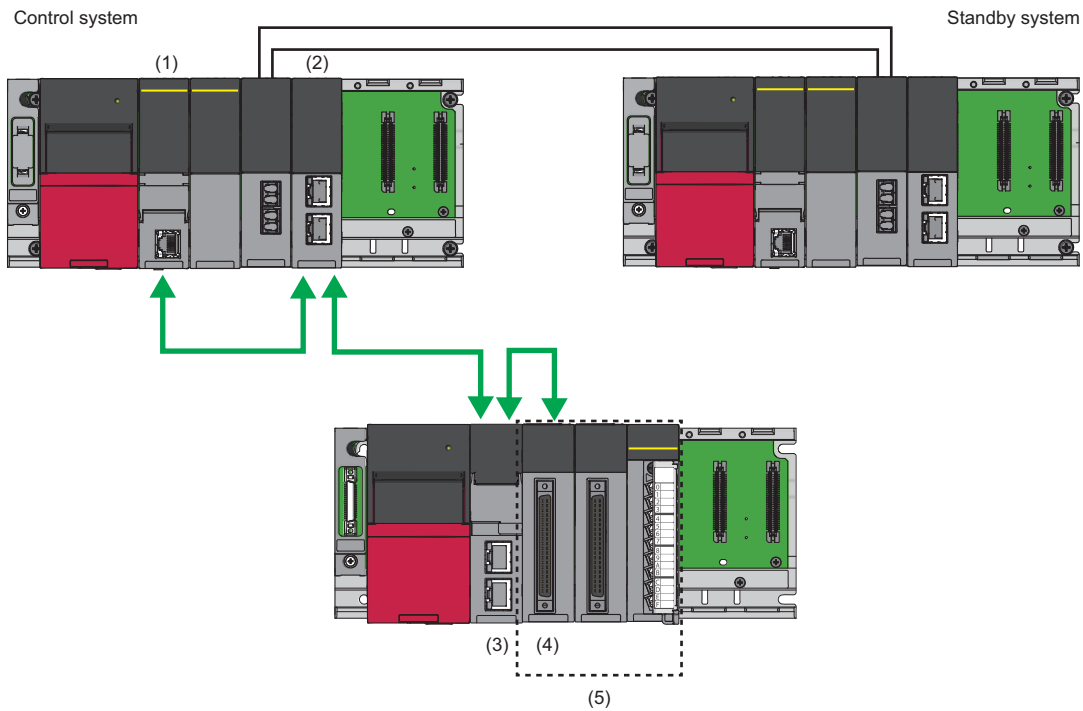

←→ Safety connection (each arrow direction indicates the direction in which a safety connection is possible)

- (1) SIL2 Process CPU
- (2) Master/local module
- (3) Remote head module
- (4) R60DA8-G
- (5) Module set

5 PART NAMES

The part names of the R60DA8-G and RY40PT5B-AS are as follows.

R60DA8-G

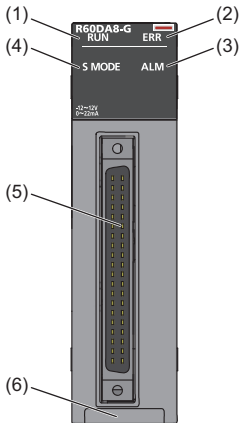

No.	Name	Description
(1)	RUN LED	Indicates the operating status of the module. On: Normal operation Off: 5V power off or a watchdog timer error occurred.
(2)	ERR LED	Indicates the error status of the module. ^{*1} On: An error occurred (minor error). Flashing: An error occurred (moderate error). Off: Normal operation
(3)	ALM LED	Indicates the wait-for-restart status after the safety module is enabled. Flashing (400ms cycles): Wait-for-restart Off: Normal operation
(4)	S MODE LED ^{*2}	Indicates the operating status of the module (SIL2 mode). On: SIL2 D/A conversion is ongoing. Flashing (1s cycles): SIL2 D/A conversion is stopped. Flashing (400ms cycles): Executing the module position check ^{*3} Off: Operating in standard mode
(5)	Connector for external devices	Connectors to connect output signal lines for external devices For details on signal layout, refer to the following. ☞ Page 184 Signal layout for the connector for external devices
(6)	Production information marking	Shows the production information (16 digits) of the module.

*1 For details, refer to the following.

☞ Page 264 List of Error Codes

*2 The LED is added to the module with production information (first four digits) of "0307" or later.

*3 For details, refer to the following.

☞ Page 200 Safety module operation

■ERR LED behavioral difference from standard mode

In standard mode, the ERR LED turns on if a minor or moderate error occurs. In SIL2 mode, the ERR LED turns on if a minor error occurs and flashes if a moderate error occurs.

RY40PT5B-AS

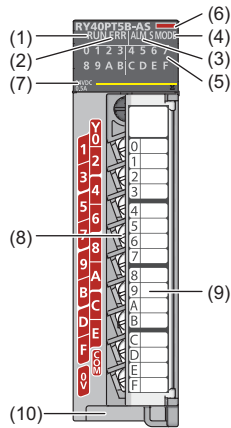

No.	Name	Description
(1)	RUN LED	Indicates the operating status. On: Operating Off: 5V power off or a watchdog timer error occurred.
(2)	ERR LED	Indicates the error status of the module.*1 Flashing: An error occurred (moderate error). Off: Normal operation
(3)	ALM LED	Indicates the wait-for-restart status after the safety module is enabled. Flashing (400ms cycles): Wait-for-restart Off: Normal operation
(4)	S MODE LED	Indicates the operating status of the module (SIL2 mode). On: Safety output in progress Flashing (1s cycles): Safety output stopped Flashing (400ms cycles): Executing the module position check*2
(5)	Output status indicator LED	Indicates the output status of each output terminal. On: Output signal turned on Off: Output signal turned off
(6)	Module identification lamp	Dark orange: Indicates output.
(7)	Rate indication	Indicates the rated voltage and the output current.
(8)	Terminal block	18-point screw terminal block. For details on its terminal layout, refer to the following. ☞ Page 166 RY40PT5B-AS
(9)	Terminal block cover	Cover to protect from electric shocks when the power is turned on
(10)	Production information marking	Shows the production information (16 digits) of the module.

*1 For details, refer to the following.

☞ Page 264 List of Error Codes

*2 For details, refer to the following.

☞ Page 200 Safety module operation

6 SPECIFICATIONS

This chapter describes the performance specifications and function list of the R60DA8-G in SIL2 mode and the RY40PT5B-AS.

6.1 Performance Specifications

R60DA8-G

This section lists performance specifications of the R60DA8-G in SIL2 mode.

Item	Specifications			
Number of analog output channels	8 channels			
Digital input	16-bit signed binary data (-32768 to 32767)			
Analog output voltage	-10 to 10VDC (External load resistance value: 1kΩ or higher)			
Analog output current	0 to 20mADC (External load resistance value: 100 to 350Ω)			
I/O conversion characteristics, resolution*1	Analog output range		Digital value	
	Voltage	0 to 5V	0 to 32000	Resolution
		1 to 5V		156.3μV
		-10 to 10V	-32000 to 32000	312.5μV
		1 to 5V (extended mode)	-8000 to 36000*2	125.0μV
		User range setting 3	-32000 to 32000	312.0μV
	Current	0 to 20mA	0 to 32000	625.0nA
		4 to 20mA		500.0nA
		4 to 20mA (extended mode)	-8000 to 36000*2	500.0nA
		User range setting 1	-32000 to 32000	360.1nA
Accuracy (Accuracy of the maximum analog output value)*3	Reference accuracy: Within ±0.1% (Voltage: ±10mV, Current: ±20μA)*4 Temperature coefficient: ±50ppm/°C (0.005%/°C)*5			
Accuracy during analog output read-back	0.8 to 8% (Voltage: ±80 to 800mV, Current: ±160 to 1600μA)*6*7*8			
Conversion speed	2ms/CH			
SIL2 D/A conversion cycle setting	2000 to 20000ms*9			
Control cycle time	2ms			
Output short circuit protection	Available			
Isolation method	Between I/O terminals and programmable controller power supply: Transformer Between analog output channels: Transformer Between external power supply and analog output channel: Transformer			
Withstand voltage	Between I/O terminals and programmable controller power supply: 500VACrms for 1 minute Between analog output channels: 1000VACrms for 1 minute Between external power supply and analog output channel: 500VACrms for 1 minute			
Isolation resistance	Between I/O terminals and programmable controller power supply: 10MΩ or higher, at 500VDC Between analog output channels: 10MΩ or higher, at 500VDC Between external power supply and analog output channel: 10MΩ or higher, at 500VDC			
Number of occupied I/O points	16 points, 1 slot (I/O assignment: Intelligent 16 points)			
External interface	40-pin connector			
Applicable wire size	When A6CON1 and A6CON4 are used	0.088 to 0.3mm ² (28 to 22 AWG) (stranded wire)		
	When A6CON2 is used	0.088 to 0.24mm ² (28 to 24 AWG) (stranded wire)		
Connector for external devices	A6CON1, A6CON2, A6CON4 (sold separately)			
External power supply	24VDC +20%, -15%			
	Ripple, spike: 500mV _{P-P} or lower			
	Inrush current: 5.0A, 810μs or lower			
	Current consumption: 0.36A			
Internal current consumption (5VDC)	0.18A			

Item		Specifications
External dimensions	Height	106mm (base unit mounting side: 98mm)
	Width	27.8mm
	Depth	110mm
Weight		0.21kg

*1 For details on the I/O conversion characteristics, refer to the following.

 Page 271 I/O Conversion Characteristics

*2 Resolution in extended mode (16 bits, 32 bits) is as follows.

Output range	16 bits		32 bits	
	Analog value	Digital value	Analog value	Digital value
1 to 5V (extended mode)	0 to 5.095V	-8000 to 32767	0 to 5.5V	-8000 to 36000
4 to 20mA (extended mode)	0 to 20.38mA	-8000 to 32767	0 to 22mA	-8000 to 36000

*3 Excluded when the wiring is influenced by noise.

*4 Accuracy in the ambient temperature when the offset/gain is set
To meet the accuracy, warm-up (power-on) for 30 minutes is required.

*5 Accuracy per 1°C temperature change

*6 The accuracy in a SIL2 analog output system is calculated by the following calculation formula.

Accuracy during analog output read-back + Accuracy of the R60DA8-G + Accuracy of the R60AD8-G for diagnostics

Set the accuracy during analog output read-back using "Allowable range setting of analog output readback". For details, refer to the following.

 Page 221 Analog output read-back function

*7 It varies depending on the setting value of "Allowable range setting of analog output readback".

Voltage: Setting value of "Allowable range setting of analog output readback" × 10mV

Current: Setting value of "Allowable range setting of analog output readback" × 20μA

*8 The analog output accuracy at safety stop is calculated by the formula used to calculate the accuracy in a SIL2 analog output system.
Example) The following example is a formula to calculate the accuracy in a SIL2 analog output system when a temperature change is 5°C (from 25°C to 30°C), "Allowable range setting of analog output readback" is set to ±0.8%, and the output range is set to -10 to 10V.

Accuracy during analog output read-back + Accuracy of the R60DA8-G + Accuracy of the R60AD8-G for diagnostics

= (±0.8%) + ((±0.1%) + (±0.0050%/°C × 5°C)) + ((±0.1%) + (±0.0035%/°C × 5°C))

= ±1.0425% (±104.25mV)

*9 The SIL2 D/A conversion cycle setting can be changed. Make this setting in "SIL2 D/A conversion cycle setting". ( Page 211 SIL2 D/A Conversion Function)

■ Output response time

The output response time of the R60DA8-G is the time needed to output a value to the external device after the digital value is set to the R60DA8-G, as defined by the following formula.

$$\bullet (SCmst \times 2) + (S2cycout \times 2.5) + RMout + SRout + (nout \times 2)$$

Symbol	Description
SCmst	Safety cycle time of the master station (safety station) ^{*1}
S2cycout	Control cycle time of the R60DA8-G ^{*2}
RMout	Safety refresh monitoring time for the output connection of the master station (safety station) ^{*3} + Safety I/O HOLD time ^{*5}
SRout	Response time of the R60DA8-G (2ms)
nout	RMout - TMrmtout - (TMrmtout ÷ 2) + a
a	TMrmtout - b (This value is effective only if a station set to Active is the RJ71GF11-T2. In other cases, the value is 0.)
b	The calculation result of TMrmtout ÷ 2, which is rounded up to a multiple of the safety cycle time ^{*4}
TMrmtout	Transmission interval monitoring time for the output connection of the master station (safety station) ^{*3}
TMrmtout	Transmission interval monitoring time of the R60DA8-G ^{*2}

*1 For details on the safety cycle time, refer to the following.

 MELSEC iQ-R CPU Module User's Manual (Application)

*2 For details, refer to the following.

 Page 163 Performance Specifications

*3 For details, refer to the following.

 MELSEC iQ-R CC-Link IE Field Network User's Manual (Application)

*4 Calculation example of b:

When the transmission interval monitoring time is 24ms and safety cycle time is 10ms, the calculation formula is $24 \div 2 = 12$, and the result is rounded up to 20, a multiple of 10.

*5 For details on the safety I/O HOLD time, refer to the following.

 MELSEC iQ-R CPU Module User's Manual (Application)

RY40PT5B-AS

Item		Specifications
Number of output points		16 points
Rated load voltage		24VDC (Allowable voltage range: 20.4 to 28.8VDC)
Maximum load current		0.5A/point, 5A/common
Maximum inrush current		Current is to be limited by the overload protection function.
Leakage current at OFF		0.3mA or lower
Maximum voltage drop at ON		1.0VDC (TYP.) 0.5A
Output response time	OFF→ON	0.5ms or less
	ON→OFF	1.5ms or less
Control cycle time		2ms
Surge suppressor		Zener diode
Fuse		None
External power supply*1	Voltage	24VDC (Ripple ratio: Within 5%) (Allowable voltage range: 20.4 to 28.8VDC)
	Current	87mA (at 24VDC)
Withstand voltage		510VACrms for one minute
Isolation resistance		10MΩ or more with isolation resistance tester
Noise immunity		Simulator noise 500Vp-p, noise width 1μs, noise frequency 25 to 60Hz (noise simulator condition)
Protection degree		IP2X
Wiring method for common		16 points/common (common terminal: TB18)
Number of occupied I/O points		32 points (I/O assignment: Output 32 points)
Protection function	Overload protection	Limited current when detecting overcurrent: 1.0A or higher/point Activated to each point. (☞ Page 232 Protection function)
	Overheat protection	Activated to each point. (☞ Page 232 Protection function)
External interface		18-point screw terminal block (M3×6 screw) ☞ Page 183 18-point terminal block for the RY40PT5B-AS
Internal current consumption (5VDC)		190mA (TYP. all points ON)
Weight		0.24kg

*1 For the external power supply, use a product that meets the following conditions.

- The overvoltage protection function is available.
- The output voltage does not exceed 35VDC in single fault state.

■Circuit configuration

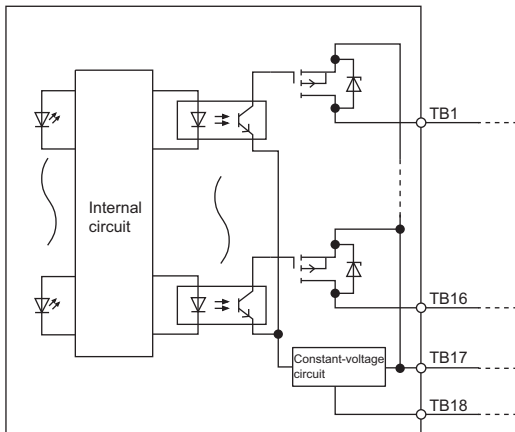

■Terminal layout

Viewed from the front of the module

Y01	1	Y00
Y03	2	Y02
Y05	4	Y04
Y07	6	Y06
Y09	8	Y08
Y0B	10	Y0A
Y0D	12	Y0C
Y0F	14	Y0E
0V	16	COM
	18	

The names Y00 to Y0F are single names.

The numbers 1 to 18 indicate terminal numbers.

Restrictions

When the input power supply to the power supply module is turned on immediately after the power supply module is powered off, the R60DA8-G, the R60AD8-G for diagnostics, or the RY40PT5B-AS may not start up. After the power supply module is powered off, wait at least five seconds before turning on the input power supply to the power supply module.

6.2 Function List

This section lists functions of the R60DA8-G in SIL2 mode and the RY40PT5B-AS.

R60DA8-G functions

Item	Description	Reference	
Range switching function	Allows switching the output range of an analog output for each channel. Switching the range makes it possible to change the I/O conversion characteristics.	Page 206 Range Switching Function	
D/A conversion enable/disable setting function	Sets whether to enable or disable the D/A conversion for each channel. Disabling the D/A conversion for unused channels reduces the conversion cycles.	Page 207 D/A Conversion Enable/Disable Setting Function	
D/A output enable/disable setting function	Specifies whether to output the D/A conversion value or the offset value for each channel. The conversion speed is constant, regardless of the output enable/disable state.	Page 207 D/A Output Enable/Disable Setting Function	
Scaling function	Performs the scale conversion on digital values within a specified range between a scaling upper limit value and a scaling lower limit value. This function helps reduce the time taken for creating a scale conversion program.	Page 208 Scaling Function	
SIL2 D/A conversion function	Analog output read-back function	Errors of the R60DA8-G are detected by checking whether the analog value output by the R60DA8-G is an output equivalent to the set value. This check is conducted by read-back verification using the R60AD8-G for diagnostics.	Page 221 Analog output read-back function
	D/A conversion circuit diagnostic function	The R60DA8-G regularly outputs an analog value and inputs it to the R60AD8-G for diagnostics to internally diagnose the D/A conversion circuit.	Page 223 D/A conversion circuit diagnostic function
	Relay diagnostic function	Micro current or micro voltage is applied to diagnose whether the relay connecting the R60DA8-G with external devices has any failures.	Page 228 Relay diagnostic function
	Output HOLD function	Holds analog output values when safety refresh data reception is interrupted.	Page 229 Output HOLD function
Self-diagnostic function	Periodically monitors statuses inside the R60DA8-G such as the operating status of the MPU (operation processing unit), the state of the power supply voltage (detection of overvoltage and undervoltage), the communication state of safety communications, and the operating status of the stored programs, for any errors.	Page 230 Self-diagnostic Function	

Restriction

The following function is not available for the R60DA8-G in SIL2 mode.

- Online module change function

RY40PT5B-AS functions

Item	Description	Reference
Output function	Performs external output in response to requests from the SIL2 diagnostic FB library.	—
Digital output read-back function	Reads back the output results of the RY40PT5B-AS for diagnosis to see if the external outputs are turned on or off correctly.	Page 231 Digital output read-back function
Protection function	Prevents trouble such as an overvoltage and overcurrent from affecting other modules in the system.	Page 232 Protection function

Common functions of R60DA8-G, RY40PT5B-AS

Item	Description	Reference
Error history function	A maximum of 16 errors of the R60DA8-G and RY40PT5B-AS error history can be checked for each module with the engineering tool.	Page 233 Error History Function
Event history function	Errors and operations in the R60DA8-G and RY40PT5B-AS are collected as event information in the remote head module.	Page 234 Event History Function

7 PROCEDURES BEFORE OPERATION

This chapter describes procedures before operation for using the R60DA8-G in SIL2 mode.

Offset/gain setting

In SIL2 mode, the user range setting is available but the offset/gain setting is not available.

To use the user range setting, configure the offset/gain setting in a different system in standard mode. (📖 MELSEC iQ-R Channel Isolated Digital-Analog Converter Module User's Manual (Startup))

Installation procedure

1. Installing the battery

Install the battery on the SIL2 Process CPU in both systems. (📖 MELSEC iQ-R CPU Module User's Manual (Startup))

2. Installing an extended SRAM cassette and SD memory card

As necessary, install an extended SRAM cassette and SD memory card on the CPU module in both systems. (📖 MELSEC iQ-R CPU Module User's Manual (Startup))

While accessing the SD memory card, do not power off, reset, or remove the SD memory card. (📖 MELSEC iQ-R CPU Module User's Manual (Application))

3. Installing the modules

Install each module on the base unit. (👉 Page 176 SYSTEM CONFIGURATION)

Wiring procedure

1. Wiring

Wire each module and external device.

Wiring location	Reference
Wiring the power supply module	• 📖 MELSEC iQ-R Module Configuration Manual
Wiring the redundant function module	• 👉 Page 176 SYSTEM CONFIGURATION • 📖 MELSEC iQ-R CPU Module User's Manual (Application)
Wiring from the master/local module to the remote head module	• 👉 Page 176 SYSTEM CONFIGURATION • 📖 MELSEC iQ-R Ethernet/CC-Link IE User's Manual (Startup) • 📖 MELSEC iQ-R CC-Link IE Field Network Remote Head Module User's Manual (Startup)
Wiring the R60DA8-G, R60AD8-G for diagnostics, and RY40PT5B-AS	• 👉 Page 176 SYSTEM CONFIGURATION • 👉 Page 182 INSTALLATION AND WIRING

2. Check the following items and then switch on the external power supply for the R60DA8-G and RY40PT5B-AS. If the power of the system is turned on before the external power supply is switched on, an error occurs in the R60DA8-G and RY40PT5B-AS.

- The power supply is wired correctly.
- The power supply voltage satisfies the specifications.

Procedure on the remote head module side

1. Powering on the system

Check the following items and then power on the system.

- The power supply is wired correctly.
- The power supply voltage satisfies the specifications.
- The remote head module is in STOP state.

2. Creating a project

Start the engineering tool and create a project. (☞ Page 191 Creating a new project (remote head module side))

3. Connecting the personal computer and remote head module

Connect the personal computer with the engineering tool installed, and the remote head module. (📖 MELSEC iQ-R CC-Link IE Field Network Remote Head Module User's Manual (Startup))

4. Initializing the remote head module

Use the engineering tool to initialize the remote head module. (📖 MELSEC iQ-R CC-Link IE Field Network Remote Head Module User's Manual (Startup))

5. Setting parameters on the remote head module side

Set the system parameters, CPU parameters, and module parameters of each module.

- System parameter and CPU parameter setting (☞ Page 191 Creating a new project (remote head module side), Page 191 Setting parameters on the remote head module side)
- Module parameter setting of each module (☞ Page 191 Setting parameters on the remote head module side)

6. Writing to the remote head module

Write the configured parameters to the remote head module using the engineering tool. (📖 MELSEC iQ-R CC-Link IE Field Network Remote Head Module User's Manual (Startup))

7. Resetting the remote head module

Use either of the following methods to restart the system on the remote head module side.

- Turning off and on the power
- Resetting the remote head module (📖 MELSEC iQ-R CC-Link IE Field Network Remote Head Module User's Manual (Startup))

Procedure on the SIL2 Process CPU side

1. Powering on the system

In both systems, check the following items and then power on the system.

- The power supply is wired correctly.
- The power supply voltage satisfies the specifications.
- The SIL2 Process CPU is in STOP state.

Power on the system and ensure that the following LEDs turn on.

- Power supply module: POWER LED
- SIL2 Process CPU: READY LED
- SIL2 function module: READY LED
- Redundant function module: RUN LED

Although the LED status of each module is as follows after this first step, proceed to the next step.

- SIL2 Process CPU: ERROR LED flashing
- SIL2 function module: ERROR LED flashing
- Redundant function module: ERR LED On
- Master/local module: ERR LED On

2. Creating a project

Start the engineering tool and create a project. (📖 Page 193 Creating a new project (SIL2 Process CPU side))

3. Connecting the personal computer and SIL2 Process CPU

On the personal computer on which the engineering tool is installed, start the engineering tool. (📖 Page 193 Creating a new project (SIL2 Process CPU side))

Connect the personal computer with the engineering tool installed, and the SIL2 Process CPU. (📖 MELSEC iQ-R CPU Module User's Manual (Application))

4. Initializing the CPU module

Use the engineering tool to initialize the SIL2 Process CPU. (📖 MELSEC iQ-R CPU Module User's Manual (Startup))
Initialize one CPU module and then connect the other SIL2 Process CPU to the personal computer.

Then, initialize the SIL2 Process CPU in the same way. (📖 MELSEC iQ-R CPU Module User's Manual (Application))

5. Setting parameters on the SIL2 Process CPU side

Set the system parameters, CPU parameters, and module parameters of each module. (👉 Page 193 Creating a new project (SIL2 Process CPU side), 👉 Page 194 Setting parameters on the SIL2 Process CPU side)

Point

Load the actual system configuration into the module configuration diagram on the engineering tool to set the system parameters.

6. Safety communication setting

Configure the safety communication setting. (👉 Page 195 Safety communication setting)

7. Writing the system A/B setting

Configure the system A/B setting using the engineering tool. (👉 Page 197 Writing the system A/B setting, 📖 MELSEC iQ-R CPU Module User's Manual (Application))

8. Setting user information

Set user information in the SIL2 Process CPU in both systems and projects. (📖 GX Works3 Operating Manual)

9. Creating programs

Create a safety program and a standard program using the SIL2 diagnostic FB library. (👉 Page 239 EXAMPLE OF OPERATION)

10. Writing to the programmable controller

Write the configured parameters and created programs to the both systems using the engineering tool. (👉 Page 197 Writing the system A/B setting, 📖 MELSEC iQ-R CPU Module User's Manual (Application))

11. Resetting the SIL2 Process CPU

Use either of the following methods to restart the both systems.

- Turning off and on the power
- Resetting the SIL2 Process CPU

12. Checking LEDs on the SIL2 Process CPU side

Check that the LED status of each module is as follows. The CARD READY LED turns on or off depending on whether the SD memory card is installed.

- Control system

R08PSFCPU	R6PSFM	R6RFM	RJ71GF11-T2
READY	READY	RUN ERR	RUN ERR
PROGRAM RUN	PROGRAM RUN	SYS [A] [CTRL	MST
USER	SAFETY COM RUN	[B] [SBY	D LINK
BATTERY	SAFETY COM ERR	[BACKUP	SD/RD
CARD READY	TEST	[SEPARATE	L ERR
CARD ACCESS		MEMORY COPY	
FUNCTION		LINK	
		L ERR	

- Standby system*¹

R08PSFCPU	R6PSFM	R6RFM	RJ71GF11-T2
READY	READY	RUN ERR	RUN ERR
PROGRAM RUN	PROGRAM RUN	SYS [A] [CTRL	MST
USER	SAFETY COM RUN	[B] [SBY	D LINK
BATTERY	SAFETY COM ERR	[BACKUP	SD/RD
CARD READY	TEST	[SEPARATE	L ERR
CARD ACCESS		MEMORY COPY	
FUNCTION		LINK	
		L ERR	

*¹ For the redundant master station system, the MST LED of the standby system master/local module flashes.

The following LEDs turn on when an error occurs. Use the engineering tool to check details of the error and remove the error cause.

- SIL2 Process CPU: ERROR LED (📖 MELSEC iQ-R CPU Module User's Manual (Startup))
- SIL2 function module: ERROR LED (📖 MELSEC iQ-R CPU Module User's Manual (Application))
- Redundant function module: ERR LED, L ERR LED (📖 MELSEC iQ-R CPU Module User's Manual (Application))
- Master/local module: ERR LED, L ERR LED (📖 MELSEC iQ-R Ethernet/CC-Link IE User's Manual (Startup))

Enabling modules

1. Safety module operation

Check that the system is powered on the SIL2 Process CPU side and the remote head module side, and use "Safety Module Operation" of the engineering tool to enable the module set to SIL2 mode. (👉 Page 200 Safety module operation)

2. Powering off the system

After enabling the module, power off the system on the SIL2 Process CPU side and the remote head module side.

3. Restarting the system

Set the RUN/STOP/RESET switch for the SIL2 Process CPU in both systems and for the remote head module to RUN, and turn the power of the systems on.

Operation check procedure

1. Checking

Check the status of each module used in the systems and program behaviors.

- Check each module to see whether an error occurred.
- Check that the LED status of each module is as follows.
- Control system

R08PSFCPU	R6PSFM	R6RFM	RJ71GF11-T2
READY <input checked="" type="checkbox"/>	READY <input checked="" type="checkbox"/>	RUN <input checked="" type="checkbox"/> ERR	RUN <input checked="" type="checkbox"/> ERR
ERROR <input type="checkbox"/>	ERROR <input type="checkbox"/>	SYS [A <input type="checkbox"/> CTRL <input type="checkbox"/>	MST <input type="checkbox"/>
PROGRAM RUN <input checked="" type="checkbox"/>	PROGRAM RUN <input checked="" type="checkbox"/>	[B <input type="checkbox"/> SBY <input type="checkbox"/>	D LINK <input checked="" type="checkbox"/>
USER <input type="checkbox"/>	SAFETY COM RUN <input checked="" type="checkbox"/>	[BACKUP <input type="checkbox"/>	SD/RD <input checked="" type="checkbox"/>
BATTERY <input type="checkbox"/>	SAFETY COM ERR <input type="checkbox"/>	[SEPARATE <input type="checkbox"/>	L ERR <input type="checkbox"/>
CARD READY <input type="checkbox"/>	TEST <input type="checkbox"/>	MEMORY COPY <input type="checkbox"/>	
CARD ACCESS <input type="checkbox"/>		LINK <input type="checkbox"/>	
FUNCTION <input type="checkbox"/>		L ERR <input type="checkbox"/>	

- Standby system*1

R08PSFCPU	R6PSFM	R6RFM	RJ71GF11-T2
READY <input checked="" type="checkbox"/>	READY <input checked="" type="checkbox"/>	RUN <input checked="" type="checkbox"/> ERR	RUN <input checked="" type="checkbox"/> ERR
ERROR <input type="checkbox"/>	ERROR <input type="checkbox"/>	SYS [A <input type="checkbox"/> CTRL <input type="checkbox"/>	MST <input type="checkbox"/>
PROGRAM RUN <input checked="" type="checkbox"/>	PROGRAM RUN <input checked="" type="checkbox"/>	[B <input type="checkbox"/> SBY <input type="checkbox"/>	D LINK <input checked="" type="checkbox"/>
USER <input type="checkbox"/>	SAFETY COM RUN <input checked="" type="checkbox"/>	[BACKUP <input type="checkbox"/>	SD/RD <input checked="" type="checkbox"/>
BATTERY <input type="checkbox"/>	SAFETY COM ERR <input type="checkbox"/>	[SEPARATE <input type="checkbox"/>	L ERR <input type="checkbox"/>
CARD READY <input type="checkbox"/>	TEST <input type="checkbox"/>	MEMORY COPY <input type="checkbox"/>	
CARD ACCESS <input type="checkbox"/>		LINK <input type="checkbox"/>	
FUNCTION <input type="checkbox"/>		L ERR <input type="checkbox"/>	

- Remote head module side*2

RJ72GF15-T2	RJ72GF15-T2	R60DA8-G	R60AD8-G	RY40PT5B-AS
RUN <input checked="" type="checkbox"/> ERR	RUN <input checked="" type="checkbox"/> ERR	RUN <input checked="" type="checkbox"/> ERR	RUN <input checked="" type="checkbox"/> ERR	RUN <input checked="" type="checkbox"/> ERR
BUS RUN <input checked="" type="checkbox"/> D LINK <input checked="" type="checkbox"/>	BUS RUN <input checked="" type="checkbox"/> D LINK <input checked="" type="checkbox"/>	S MODE <input checked="" type="checkbox"/> ALM	S MODE <input checked="" type="checkbox"/> ALM	ALM S MODE
[CTRL <input checked="" type="checkbox"/> SD/RD <input checked="" type="checkbox"/>	[CTRL <input checked="" type="checkbox"/> SD/RD <input checked="" type="checkbox"/>			0 1 2 3 4 5 6 7
[SBY <input type="checkbox"/> L ERR	[SBY <input type="checkbox"/> L ERR			8 9 A B C D E F
CC-Link IE Field		-12~12V 0~22mA	-10~10V 0~20mA	24VDC 0.5A

*1 For the redundant master station system, the MST LED of the standby system master/local module flashes.

*2 Because the remote head module is not in a redundancy configuration for the redundant master station system, the following LEDs are always turned off.

• CTRL LED · SBY LED

- Check whether an error occurred in CC-Link IE Field Network diagnostics. (📖 MELSEC iQ-R CC-Link IE Field Network User's Manual (Application))
- Check that the safety program and standard program behave normally.

2. Switching the safety operation mode

For normal operation as a safety control system via the SIL2 Process CPU, switch the safety operation mode to SAFETY MODE. Before switching the safety operation mode, set the SIL2 Process CPU to STOP state. (📖 Page 205 Switching safety operation mode, 📖 MELSEC iQ-R CPU Module User's Manual (Application))

Point

When the SIL2 Process CPU is in STOP state, a continuation error of operating status mismatch is detected in the standby system.

3. Program execution

Power off the SIL2 Process CPU in both systems and the remote head module. Then, set the RUN/STOP/RESET switch for the SIL2 Process CPU in both systems and for the remote head module to RUN, and turn the power of the systems on. Check that the PROGRAM RUN LED of the control system CPU module is on.

Point

If the RUN/STOP/RESET switch is set to RUN in power-on state, a continuation error of operating status mismatch is detected in the standby system.

4. Program monitoring

Use the engineering tool to check that programs run normally.

8 SYSTEM CONFIGURATION

This chapter describes the system configuration to use the R60DA8-G in SIL2 mode. For application in SIL2 mode, a redundant system must be configured based on a redundant master station or redundant line. In such a case, mount the R60DA8-G with a remote head module.

8.1 Redundant Master Station

The following diagram shows the system configuration with a redundant master station.

- System configuration diagram

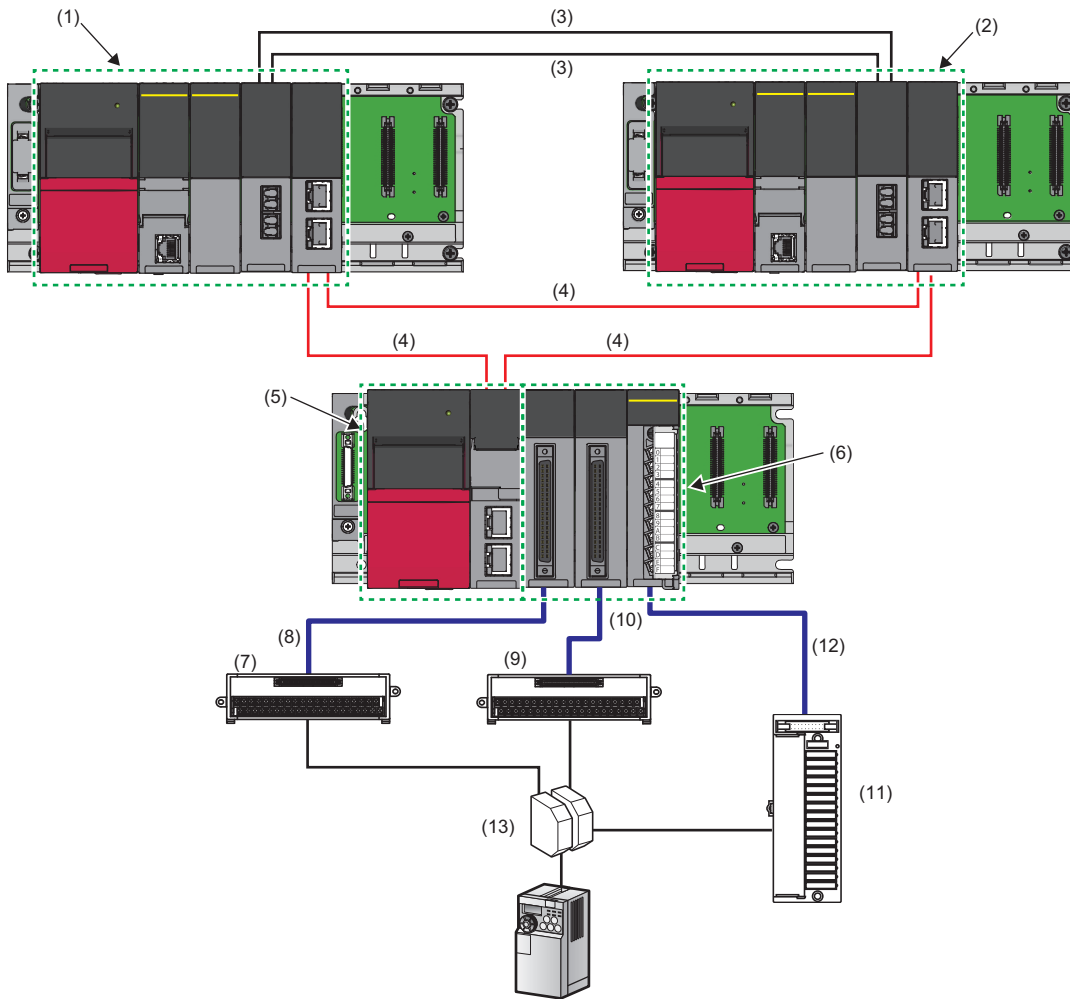

- List of components

No.	Name	Description
(1)	System A system	<p>Composed of the following modules:</p> <ul style="list-style-type: none"> • RnPSFCPU • R6PSFM • R6RFM • RJ71GF11-T2 <p>■Precautions</p> <ul style="list-style-type: none"> • Each module has restrictions on use in a system on the system configuration diagram. For details, refer to the User's Manual (Application) for each module. • Mount the above modules on the same base unit. Mount the modules so that they are arranged in the following order: RnPSFCPU → R6PSFM → R6RFM → RJ71GF11-T2, starting from the right side of the power supply module.
(2)	System B system	<p>Composed of the following modules:</p> <ul style="list-style-type: none"> • RnPSFCPU • R6PSFM • R6RFM • RJ71GF11-T2 <p>■Precautions</p> <ul style="list-style-type: none"> • Each module has restrictions on use in a system on the system configuration diagram. For details, refer to the User's Manual (Application) for each module. • Mount the above modules on the same base unit. Mount the modules so that they are arranged in the following order: RnPSFCPU → R6PSFM → R6RFM → RJ71GF11-T2, starting from the right side of the power supply module.
(3)	Tracking cable	Use cables designed for use by the R6RFM. (Refer to MELSEC iQ-R CPU Module User's Manual (Startup))

No.	Name	Description
(4)	CC-Link IE Field Network supporting cable	Use cables supporting CC-Link IE Field Network. (📖 MELSEC iQ-R Ethernet/CC-Link IE User's Manual (Startup))
(5)	Remote head module	Use the RJ72GF15-T2. Note that the module has restrictions on use in a system on the system configuration diagram. For details, refer to the MELSEC iQ-R CC-Link IE Field Network Remote Head Module User's Manual (Application).
(6)	Module set	<p>Composed of the following modules:</p> <ul style="list-style-type: none"> • R60DA8-G • R60AD8-G for diagnostics • RY40PT5B-AS <p>■Precautions</p> <ul style="list-style-type: none"> • When using the R60DA8-G in SIL2 mode, there is a restriction on the version. For details, refer to Page 181 Firmware Version for SIL2 Mode. • Mount the above modules on the same base unit. Mount the modules so that they are arranged in the following order: R60DA8-G → R60AD8-G for diagnostics → RY40PT5B-AS, starting from the right side of the remote head module.
(7)	Connector/terminal block converter module for the R60DA8-G	<p>Use the following products.</p> <p>📖 Page 181 Connector/terminal block converter module for the R60DA8-G</p>
(8)	Connector/terminal block converter module connection cable for the R60DA8-G	<p>This cable is a special cable for connecting the R60DA8-G and the connector/terminal block converter module. Use the following products.</p> <p>📖 Page 181 Connector/terminal block converter module for the R60DA8-G</p>
(9)	Connector/terminal block converter module for the R60AD8-G for diagnostics	<p>Use the following products.</p> <p>📖 Page 181 Connector/terminal block converter module for the R60AD8-G for diagnostics</p>
(10)	Connector/terminal block converter module connection cable for the R60AD8-G for diagnostics	<p>This cable is a special cable for connecting the R60AD8-G for diagnostics and the connector/terminal block converter module. Use the following products.</p> <p>📖 Page 181 Connector/terminal block converter module for the R60AD8-G for diagnostics</p>
(11)	Terminal module for the RY40PT5B-AS	<p>This module is used to connect the relay switching RY40PT5B-AS with the analog switching module. Use the following product.</p> <p>📖 Page 181 Terminal module for the RY40PT5B-AS</p>
(12)	Terminal module connection cable for the RY40PT5B-AS	<p>This cable is a special cable used to connect the RY40PT5B-AS with the terminal module. Use the following products.</p> <p>📖 Page 181 Terminal module for the RY40PT5B-AS</p>
(13)	Relay	<p>Use the following products.</p> <p>📖 Page 181 Relay</p>

8.2 Redundant Line

The following diagram shows the system configuration with a redundant line.

- System configuration diagram

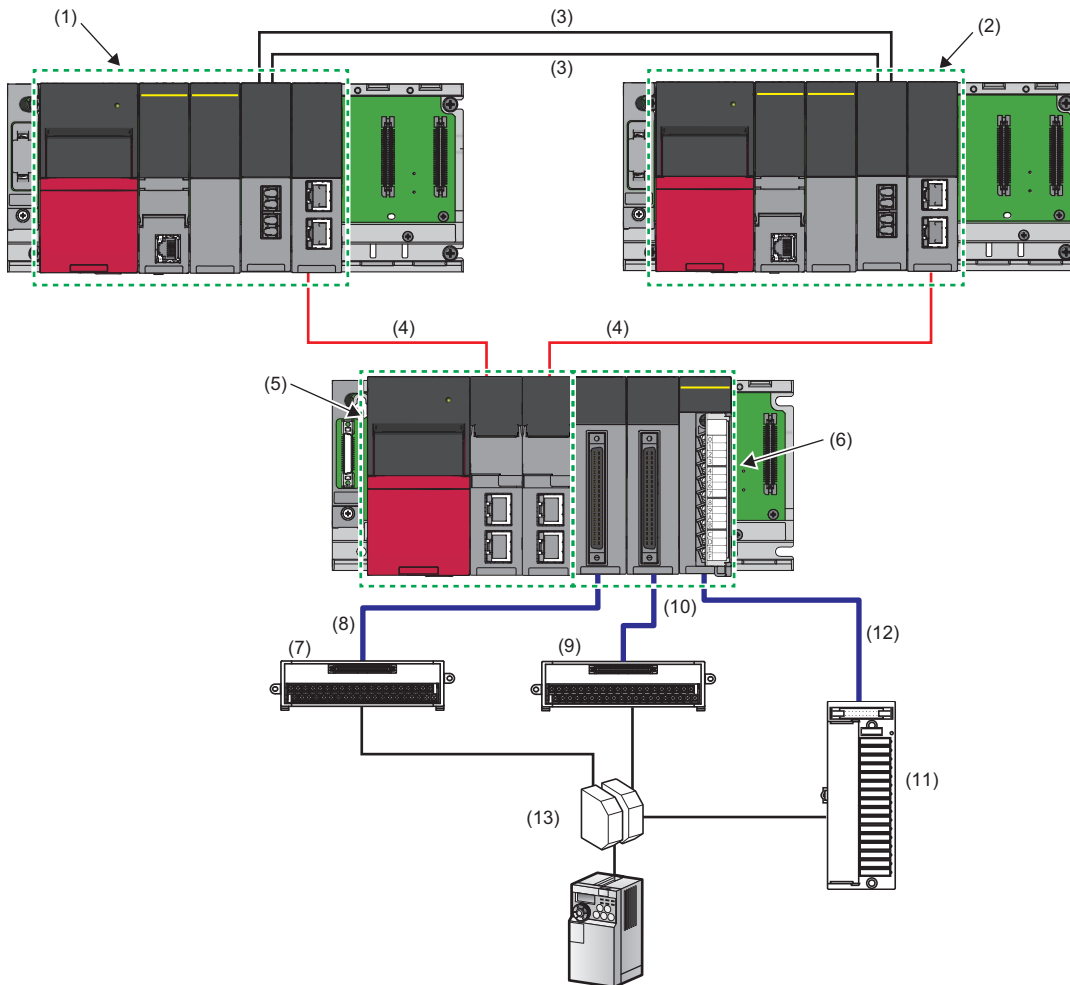

- List of components

No.	Name	Description
(1)	System A system	<p>Composed of the following modules:</p> <ul style="list-style-type: none"> • RnPSFCPU • R6PSFM • R6RFM • RJ71GF11-T2 <p>■Precautions</p> <ul style="list-style-type: none"> • Each module has restrictions on use in a system on the system configuration diagram. For details, refer to the User's Manual (Application) for each module. • Mount the above modules on the same base unit. Mount the modules so that they are arranged in the following order: RnPSFCPU → R6PSFM → R6RFM → RJ71GF11-T2, starting from the right side of the power supply module.
(2)	System B system	<p>Composed of the following modules:</p> <ul style="list-style-type: none"> • RnPSFCPU • R6PSFM • R6RFM • RJ71GF11-T2 <p>■Precautions</p> <ul style="list-style-type: none"> • Each module has restrictions on use in a system on the system configuration diagram. For details, refer to the User's Manual (Application) for each module. • Mount the above modules on the same base unit. Mount the modules so that they are arranged in the following order: RnPSFCPU → R6PSFM → R6RFM → RJ71GF11-T2, starting from the right side of the power supply module.
(3)	Tracking cable	Use cables designed for use by the R6RFM. (Refer to MELSEC iQ-R CPU Module User's Manual (Startup))

No.	Name	Description
(4)	CC-Link IE Field Network supporting cable	Use cables supporting CC-Link IE Field Network. (📖 MELSEC iQ-R Ethernet/CC-Link IE User's Manual (Startup))
(5)	Remote head module	Use the RJ72GF15-T2. Note that the module has restrictions on use in a system on the system configuration diagram. For details, refer to the MELSEC iQ-R CC-Link IE Field Network Remote Head Module User's Manual (Application).
(6)	Module set	<p>Composed of the following modules:</p> <ul style="list-style-type: none"> • R60DA8-G • R60AD8-G for diagnostics • RY40PT5B-AS <p>■Precautions</p> <ul style="list-style-type: none"> • When using the R60DA8-G in SIL2 mode, there is a restriction on the version. For details, refer to Page 181 Firmware Version for SIL2 Mode. • Mount the above modules on the same base unit. Mount the modules so that they are arranged in the following order: R60DA8-G → R60AD8-G for diagnostics → RY40PT5B-AS, starting from the right side of the remote head module.
(7)	Connector/terminal block converter module for the R60DA8-G	<p>Use the following products.</p> <p>📖 Page 181 Connector/terminal block converter module for the R60DA8-G</p>
(8)	Connector/terminal block converter module connection cable for the R60DA8-G	<p>This cable is a special cable for connecting the R60DA8-G and the connector/terminal block converter module. Use the following products.</p> <p>📖 Page 181 Connector/terminal block converter module for the R60DA8-G</p>
(9)	Connector/terminal block converter module for the R60AD8-G for diagnostics	<p>Use the following products.</p> <p>📖 Page 181 Connector/terminal block converter module for the R60AD8-G for diagnostics</p>
(10)	Connector/terminal block converter module connection cable for the R60AD8-G for diagnostics	<p>This cable is a special cable for connecting the R60AD8-G for diagnostics and the connector/terminal block converter module. Use the following products.</p> <p>📖 Page 181 Connector/terminal block converter module for the R60AD8-G for diagnostics</p>
(11)	Terminal module for the RY40PT5B-AS	<p>This module is used to connect the relay switching RY40PT5B-AS with the analog switching module. Use the following product.</p> <p>📖 Page 181 Terminal module for the RY40PT5B-AS</p>
(12)	Terminal module connection cable for the RY40PT5B-AS	<p>This cable is a special cable used to connect the RY40PT5B-AS with the terminal module. Use the following products.</p> <p>📖 Page 181 Terminal module for the RY40PT5B-AS</p>
(13)	Relay	<p>Use the following products.</p> <p>📖 Page 181 Relay</p>

8.3 Firmware Version for SIL2 Mode

For application in SIL2 mode, use the R60DA8-G with the following conditions.

- Use a module with firmware version 03 or later.
- Use a module with production information (first four digits) of 0307 or later.

For how to check the firmware version and production information, refer to the MELSEC iQ-R Module Configuration Manual.

8.4 Reference Product

Connector/terminal block converter module for the R60DA8-G

Product	Model	Remarks	Contact
Connector/terminal block converter module	FA1-TBS40DAG	—	Mitsubishi Electric Engineering Co., Ltd.
	FA-LTB40DAG	—	
Special cable	FA1-CBL05R60DA8G	Cable length: 0.5m	
	FA1-CBL10R60DA8G	Cable length: 1.0m	
	FA1-CBL20R60DA8G	Cable length: 2.0m	
	FA1-CBL30R60DA8G	Cable length: 3.0m	

Connector/terminal block converter module for the R60AD8-G for diagnostics

Product	Model	Remarks	Contact
Connector/terminal block converter module	FA1-TBS40ADGN	—	Mitsubishi Electric Engineering Co., Ltd.
	FA-LTB40ADGN	—	
Special cable	FA-CBL05Q68ADGN	Cable length: 0.5m	
	FA-CBL10Q68ADGN	Cable length: 1.0m	
	FA-CBL20Q68ADGN	Cable length: 2.0m	
	FA-CBL30Q68ADGN	Cable length: 3.0m	

Terminal module for the RY40PT5B-AS

Product	Model	Remarks	Contact
Terminal module	FA-THE16YTR20S	—	Mitsubishi Electric Engineering Co., Ltd.
Special cable	FA-CBL06TMV20	Cable length: 0.6m	
	FA-CBL10TMV20	Cable length: 1.0m	
	FA-CBL20TMV20	Cable length: 2.0m	
	FA-CBL30TMV20	Cable length: 3.0m	

Relay

Product	Model	Remarks	Contact
Analog switching module	M2MNV-23-R/CE-X: Special Product No. 36153	When using the voltage output range with the R60DA8-G, please use this product.	M-System Co., Ltd.
	M2MNV-13-R/CE-X: Special Product No. 36111	When using the current output range with the R60DA8-G, please use this product.	

9 INSTALLATION AND WIRING

This chapter describes wiring for the R60DA8-G and RY40PT5B-AS.

9.1 Wiring Precautions

- Check the signal layout before wiring the R60DA8-G, and connect the cables correctly. For details on signal layout, refer to the following.

 Page 184 Signal layout for the connector for external devices

- Use a single-point ground for the shield of shield wires and shielded cables.

Connector for external devices for the R60DA8-G

Precautions

Tighten connector screws within the specified torque range.

Screw	Tightening torque range
Connector screw (M2.6)	0.20 to 0.29N·m

- Use copper wire with a temperature rating of 75°C or higher for the connector.
- Use UL listed connectors if necessary for UL compliance.

Applicable connectors

Connectors for external devices used for the R60DA8-G should be ordered by the customers.

The type of applicable connectors and a reference product of crimping tool are as follows.

■40-pin connector

Type	Model	Applicable wire size
Soldering type connector (straight type)	A6CON1*1	0.088 to 0.3mm ² (28 to 22 AWG) (stranded wire)
Crimping type connector (straight type)	A6CON2	0.088 to 0.24mm ² (28 to 24 AWG) (stranded wire)
Soldering type connector (dual purpose (straight/oblique) type)	A6CON4*1	0.088 to 0.3mm ² (28 to 22 AWG) (stranded wire)

*1 For application with 40 wires, use a wire with its sheath outside diameter at 1.3mm or less.
Select an adequate wire for your current value.



A6CON3 (IDC type connector (straight type)) cannot be used.

■40-pin connector crimping tool

Type	Model	Contact
Crimping tool	N363TT005H	OTAX Corporation

For how to wire connectors and how to use the crimping tool, contact the manufacturer.

Connector wiring, installation procedure, disconnection procedure

For connector wiring, installation procedure, and disconnection procedure, refer to the following.

 MELSEC iQ-R Module Configuration Manual

18-point terminal block for the RY40PT5B-AS

Precautions

- For terminal block wiring, use a solderless terminal whose thickness is 0.8mm or less. Do not connect more than two solderless terminals to a terminal.
- A solderless terminal with an insulation sleeve cannot be used in a terminal block. To prevent a short-circuit when a terminal block screw becomes loose, we recommend putting a mark tube or insulation tube on the wire connection section of a solderless terminal.
- Use the following for a wire connecting to a terminal block.

Applicable wire size	Material	Temperature rating
0.3 to 0.75mm ² (22 to 18 AWG) (stranded wire) Outside diameter: 2.8mm or less ^{*1}	Copper wire	75°C or more

- For a solderless terminal, use R1.25-3, which is UL listed.
- Tighten terminal block screws within the following torque ranges.

Screw	Tightening torque range
Terminal block screw (M3 screw)	0.42 to 0.58N-m
Terminal block mounting screw (M3.5 screw)	0.66 to 0.89N-m

*1 When 0.75mm² or bigger cables are used, the horizontal overhang will become so large that cables interfere with the terminal blocks or connectors of adjacent modules, eventually giving stress to the modules. Therefore, use 0.75mm² or smaller cables. When the type of terminal block is changed to a spring clamp terminal block (Q6TE-18SN), 0.3 to 1.5mm² (22 to 16 AWG) cables can be used. To use cables bigger than the above, manage by using FA goods manufactured by Mitsubishi Electric Engineering Co., Ltd. (such as FA-TB161AC+ FA-CBL20D).

- The RY40PT5B-AS only monitors the output status of the module's output terminals. To monitor the output status of connected devices, implement another monitoring function in the system.

Terminal block wiring, installation, and disconnection procedures

For terminal block wiring, installation procedure, and disconnection procedure, refer to the following.

 MELSEC iQ-R Module Configuration Manual

9.2 External Wiring

Signal layout for the connector for external devices

The signal layout for connector for external devices of the R60DA8-G is as follows.

Pin layout (front module view)	Pin number	Signal name	Pin number	Signal name
A1	A1	CH1 V+/I+	B1	CH1 V-/I-
A2	A2	—	B2	—
A3	A3	CH2 V+/I+	B3	CH2 V-/I-
A4	A4	—	B4	—
A5	A5	CH3 V+/I+	B5	CH3 V-/I-
A6	A6	—	B6	—
A7	A7	CH4 V+/I+	B7	CH4 V-/I-
A8	A8	—	B8	—
A9	A9	—	B9	—
A10	A10	CH5 V+/I+	B10	CH5 V-/I-
A11	A11	—	B11	—
A12	A12	CH6 V+/I+	B12	CH6 V-/I-
A13	A13	—	B13	—
A14	A14	CH7 V+/I+	B14	CH7 V-/I-
A15	A15	—	B15	—
A16	A16	CH8 V+/I+	B16	CH8 V-/I-
A17	A17	—	B17	—
A18	A18	—	B18	—
A19	A19	24VDC	B19	24VDC
A20	A20	DC24 G	B20	DC24 G

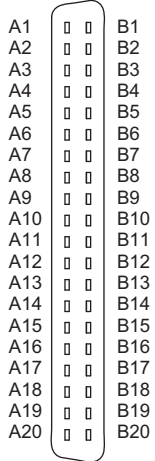

Examples of external wiring

Examples of external wiring are as follows.

Point

For wiring for the R60AD8-G for diagnostics, refer to the following.

 MELSEC iQ-R Channel Isolated Analog-Digital Converter Module User's Manual (Startup)

Voltage output

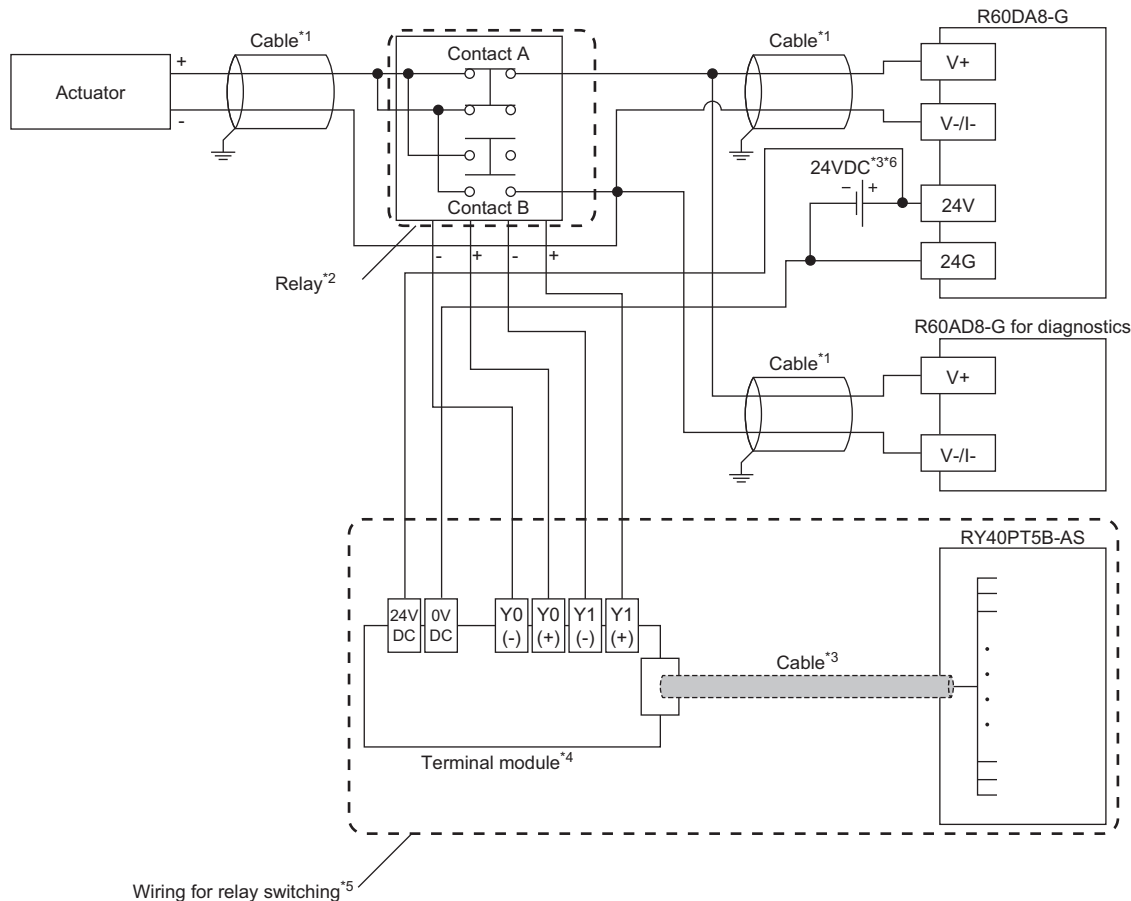

*1 For the application below, use shielded cables and single point grounding for the shield.

- Between actuator and relay
- Between the R60DA8-G and relay
- Between the R60AD8-G and relay

*2 Install the relay and the programmable controller within the same panel.

*3 If the R60DA8-G must comply with the EMC and Low Voltage Directives, please refer to one of the following manuals.

 MELSEC iQ-R Module Configuration Manual

 Safety Guidelines (IB-0800525)

*4 Since the relay cannot receive the 24V output signal, it cannot be connected directly to the RY40PT5B-AS.

*5 For details on wiring for relay switching, refer to the following.

 Page 188 Relay switching wiring

*6 For the external power supply, use a product that meets the following conditions.

- The overvoltage protection function is available.
- The output voltage does not exceed 35VDC in single fault state.

Current output

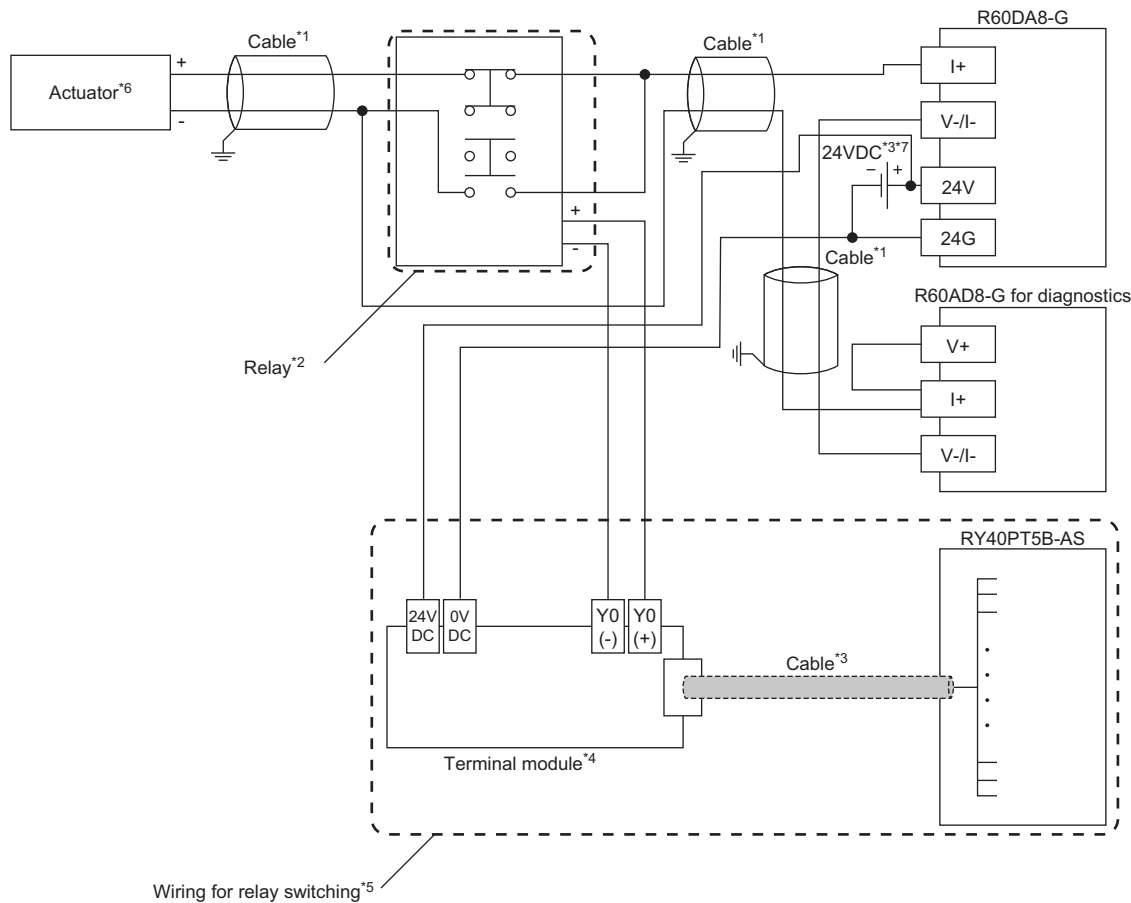

*1 For the application below, use shielded cables and single point grounding for the shield.

- Between actuator and relay
- Between the R60DA8-G and relay
- Between the R60AD8-G and relay

*2 Install the relay and the programmable controller within the same panel.

*3 If the R60DA8-G must comply with the EMC and Low Voltage Directives, please refer to one of the following manuals.

- 📖 MELSEC iQ-R Module Configuration Manual
- 📖 Safety Guidelines (IB-0800525)

*4 Since the relay cannot receive the 24V output signal, it cannot be connected directly to the RY40PT5B-AS.

*5 For details on wiring for relay switching, refer to the following.

- 📖 Page 188 Relay switching wiring

*6 When an internal load resistance value of the external device is less than 100Ω , connect the resistor in series so that the resistance value is 100Ω or more in total.

*7 For the external power supply, use a product that meets the following conditions.

- The overvoltage protection function is available.
- The output voltage does not exceed 35VDC in single fault state.

When the connector/terminal block converter module is used

The connector/terminal block converter module and special cable for the R60DA8-G can be used for wiring. When the connector/terminal block converter module is used, the wiring should be as follows.

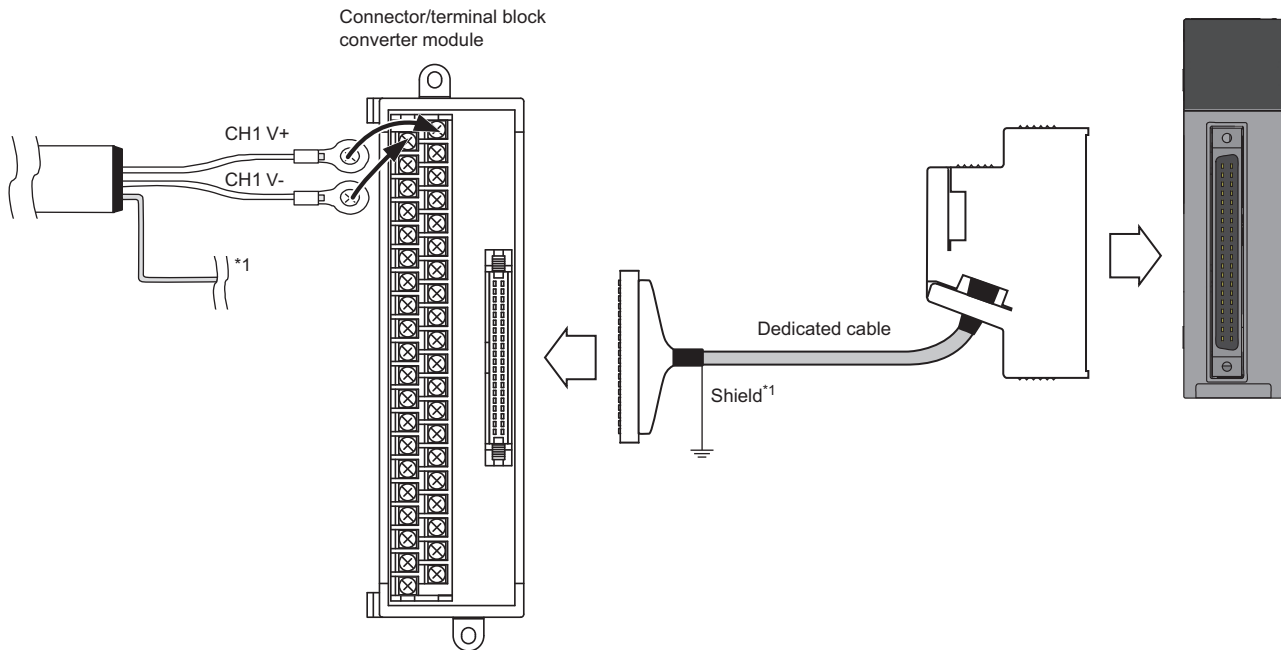

*1 Be sure to use a shielded cable. And be sure to ground the shield.

For available connector/terminal block converter modules and special cables, refer to the following.

📖 Page 181 Connector/terminal block converter module for the R60DA8-G

Point

Factory default setting of the R60DA8-G uses the offset/gain setting adjusted per module.

If a connector/terminal block converter module and a special cable are used, they may cause an error on the conversion characteristics due to effect of conductor resistance.

If the effect of conductor resistance is a problem, set offset and gain values and use the user range setting.

For the offset/gain setting, refer to the following.

📖 MELSEC iQ-R Channel Isolated Digital-Analog Converter Module User's Manual (Startup)

Relay switching wiring

Relay switching wiring is as follows.

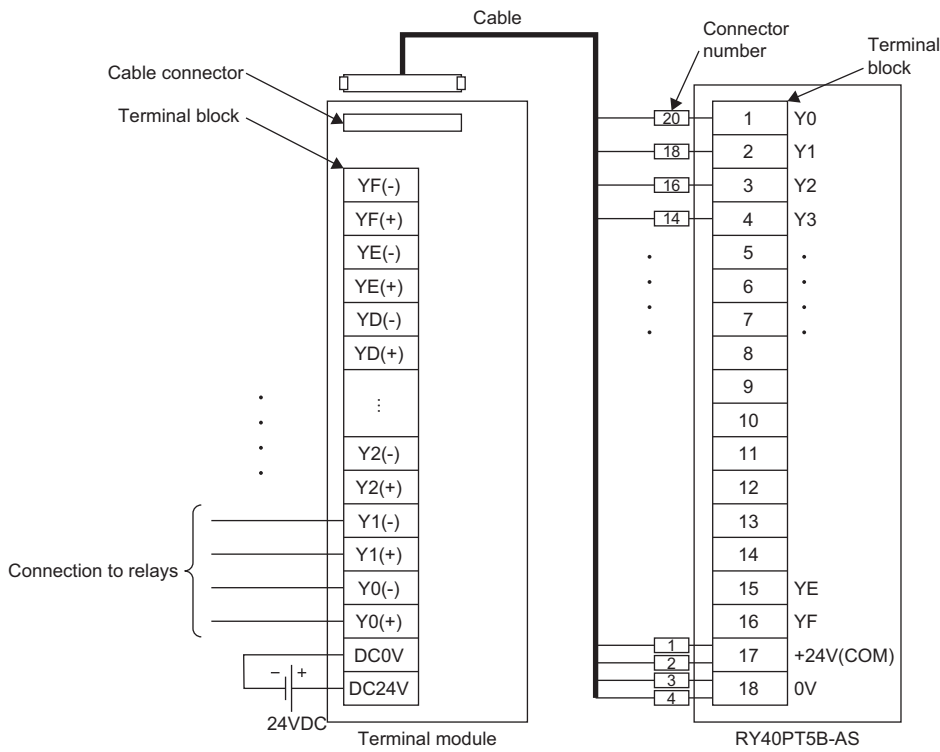

For the terminal module and special cable that can be used, refer to the following.

☞ Page 181 Terminal module for the RY40PT5B-AS

For the external power supply (24VDC), use a product that meets the following conditions.

- The overvoltage protection function is available.
- The output voltage does not exceed 35VDC in single fault state.

Precautions for channel number and output signal

Before wiring for SIL2 mode, pay attention to the following points.

Precautions for channel number

All the channels used for the R60DA8-G and R60AD8-G for diagnostics should use the same channel number.

Ex.

When the R60DA8-G uses CH1 to make D/A conversion, the R60AD8-G for diagnostics must use CH1.

Precautions for output signal

When wiring the relay and RY40PT5B-AS, the output signals used for the RY40PT5B-AS should be wired as follows.

Output signals used for the RY40PT5B-AS	Channel used by the R60DA8-G															
	Voltage								Current							
	CH1	CH2	CH3	CH4	CH5	CH6	CH7	CH8	CH1	CH2	CH3	CH4	CH5	CH6	CH7	CH8
Contact A	Y0	Y2	Y4	Y6	Y8	YA	YC	YE	Y0	Y2	Y4	Y6	Y8	YA	YC	YE
Contact B	Y1	Y3	Y5	Y7	Y9	YB	YD	YF	—							

Ex.

When the R60DA8-G uses CH1 to make voltage output, the RY40PT5B-AS must use Y0 and Y1.

10 FUNCTIONS

This chapter describes details of functions that can be used by the R60DA8-G in SIL2 mode and their setting procedures.

Point

Numerical values corresponding to the channel where an error has occurred fit in the □ of an error code described in this chapter. For details on the numerical values, refer to the following.

 Page 264 List of Error Codes

10.1 SIL2 Mode

This section describes the setting required to run the R60DA8-G in SIL2 mode.

Creating a new project (remote head module side)

Create a new project with the remote head module, and add necessary modules.

1. Create a project with the remote head module. Depending on the system configuration, specify the RJ72GF15-T2 or RJ72GF15-T2 (LR).
2. Depending on the system configuration, add "R60DA8-G (S2M)", "R60AD8-G", or "RY40PT5B-AS".

Setting parameters on the remote head module side

With the created project, set the parameters.

1. Configure "Network Required Setting" in "CPU Parameter" for the remote head module.
2. Set the module parameters for the "R60DA8-G (S2M)" and "R60AD8-G".
 - ☞ Page 192 Module parameters for "R60DA8-G (S2M)"
 - ☞ Page 192 Module parameters for "R60AD8-G"
 - The module parameters for "RY40PT5B-AS" are automatically issued from "R60DA8-G (S2M)", so there are no items to set.
3. Write the set parameters to the remote head module on the intelligent device station. Then reset the remote head module or turn off and on the power.
4. Save the project.

Point

The project on the remote head module side is used for safety communication setting in a project on the SIL2 Process CPU side. For details, refer to the following.

☞ Page 195 Safety communication setting

■Module parameters for "R60DA8-G (S2M)"

For details on each parameter, refer to the details of each function.

Module parameter		Reference
Basic setting	D/A conversion enable/disable setting	Page 207 D/A Conversion Enable/Disable Setting Function
	Output range setting	Page 206 Range Switching Function
	Transmission interval monitoring time	Page 211 SIL2 D/A Conversion Function
Application setting	Scaling enable/disable setting	Page 208 Scaling Function
	Scaling upper limit value	
	Scaling lower limit value	
	Allowable range setting of analog output readback	Page 221 Analog output read-back function
	SIL2 D/A conversion cycle setting	Page 211 SIL2 D/A Conversion Function
	D/A converter circuit Diagnostic cycle setting	Page 223 D/A conversion circuit diagnostic function

■Module parameters for "R60AD8-G"

To operate the module as the R60AD8-G for diagnostics, make the following settings. For parameters other than the following, use the default values.

Module parameter		Description
Basic setting	Input range setting	Set the same setting value as that for "Output range setting" of "R60DA8-G (S2M)". If "User range setting 1" or "User range setting 3" is set for "R60DA8-G (S2M)", set "User range setting" for "R60AD8-G".
	Operation mode setting	Do not change the value from the default value "Normal mode (A/D conversion process)".
	A/D conversion enable/disable setting	Set "A/D conversion enable" to the same channel number as the D/A conversion enabled channel number of "R60DA8-G(S2M)".
Application setting	Scaling enable/disable setting	Set the same values as "Scaling enable/disable setting", "Scaling upper limit value", and "Scaling lower limit value" of "R60DA8-G(S2M)".
	Scaling upper limit value	
	Scaling lower limit value	
	Auto restore of Offset/gain setting with the module change	Do not change the default value. However, in the SIL2 analog output system, the system operates as "Disable".
Refresh settings	Digital output value	Set W1000 to W1007 to CH1 to CH8 in ascending order of channel number. Example: CH1: W1000, CH2: W1001, ..., CH7: W1006, CH8: W1007
	Digital operation value	Set W1008 to W100F to CH1 to CH8 in ascending order of channel number. Example: CH1: W1008, CH2: W1009, ..., CH7: W100E, CH8: W100F

Creating a new project (SIL2 Process CPU side)

Create a new project with the SIL2 Process CPU, and add necessary modules.

1. Create a project with the SIL2 Process CPU.

☞ [Project] ⇒ [New]

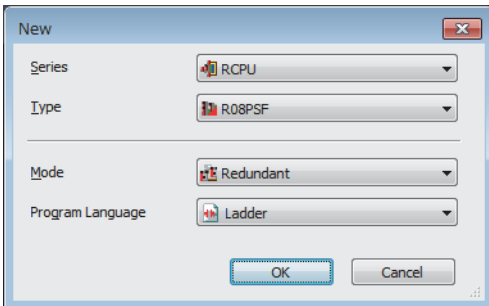

2. Add the user "Administrators" to the project and log on to the system.
3. Initialize the SIL2 Process CPU (built-in memory and user information) of the both systems.
4. Depending on the system configuration, add the R6PSFM and R6RFM.

☞ [Navigation window] ⇒ [Module Configuration] ⇒ [Element Selection window] ⇒ [CPU Extension]

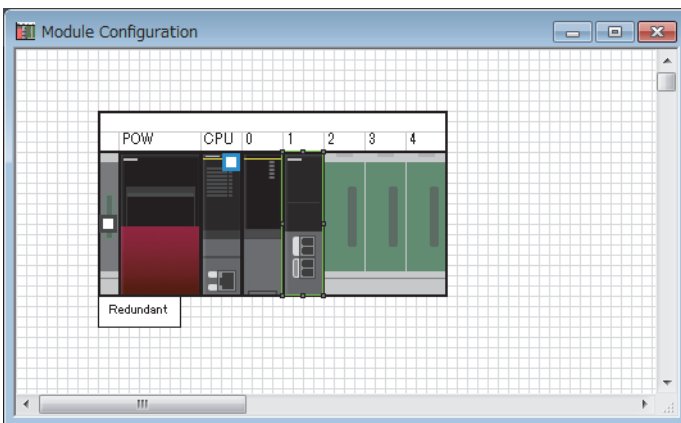

5. Depending on the system configuration, add the RJ71GF11-T2 (MR) or RJ71GF11-T2 (LR) as a master station.

☞ [Navigation window] ⇒ [Parameter] ⇒ [Module Information] ⇒ Right-click ⇒ [Add New Module]

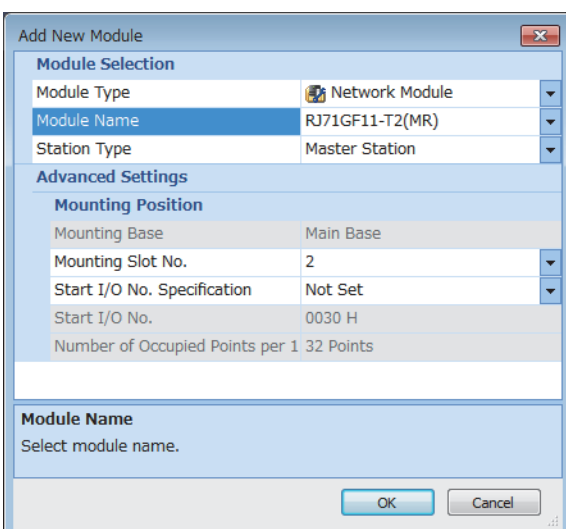

Setting parameters on the SIL2 Process CPU side

With the created project, set the parameters.

1. Set "CPU Parameter" according to the system configuration.

For details on item and setting procedure, refer to MELSEC iQ-R CPU Module User's Manual (Application).

2. Set "Required Settings" of the module parameter for the master/local module.

[Navigation window] ⇒ [Parameter] ⇒ [Module Information] ⇒ Target module ⇒ [Required Setting]

3. Using "Network Configuration Settings" of the module parameter for the master/local module, set the intelligent device station. For the intelligent device station, set RJ72GF15-T2 or RJ72GF15-T2 (LR) depending on the system configuration.

[Navigation window] ⇒ [Parameter] ⇒ [Module Information] ⇒ Target module ⇒ [Basic Settings] ⇒ [Network Configuration Settings]

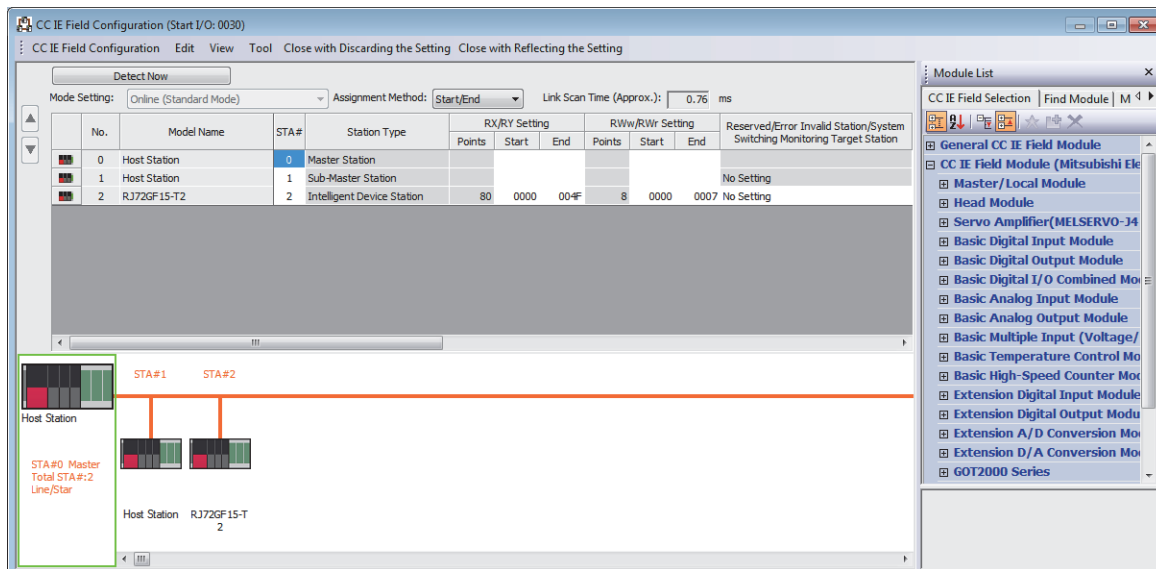

4. Set "Refresh Setting" of the module parameter for the master/local module as shown below.

[Navigation window] ⇒ [Parameter] ⇒ [Module Information] ⇒ [RJ71GF11-T2] ⇒ [Basic Settings] ⇒ [Refresh Setting]

No.	Link Side					CPU Side				
	Device Name	Points	Start	End		Target	Device Name	Points	Start	End
-	SB				↔					
-	SW				↔					
1	RWr	16	00000	0000F	↔	Specify Device	W	16	01000	0100F
2	RX	16	00010	0001F	↔	Specify Device	X	16	01000	0100F
3	RY	16	00010	0001F	↔	Specify Device	Y	16	01000	0100F
4					↔					
5					↔					
6					↔					
7					↔					
8					↔					
9					↔					

5. Save the project.

Safety communication setting

Configure the safety communication setting using the project on the remote head module side. For details on safety communications, refer to the MELSEC iQ-R CC-Link IE Field Network User's Manual (Application).

1. Open a project on the SIL2 Process CPU side.
2. Set "To Use or Not to Use the Safety Communication Setting" of the module parameter for the master/local module to "Use".

 [Navigation window] ⇒ [Parameter] ⇒ [Module Information] ⇒ Target module ⇒ [Application setting] ⇒ [Safety Communication Setting]

3. Double-click "Safety Communication Setting" of the module parameter for the master/local module, and display the "Safety Communication Setting" window.

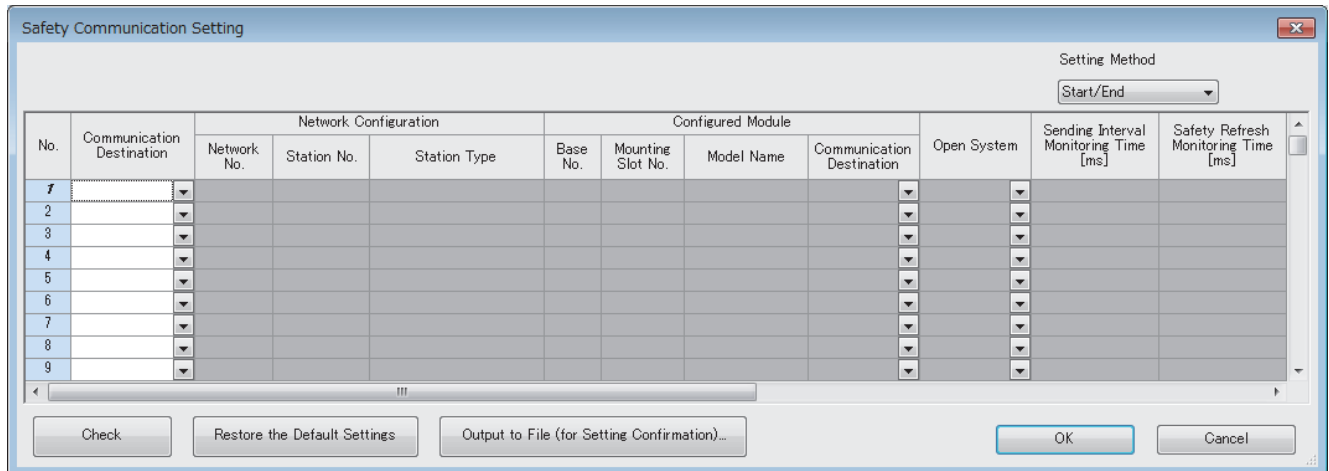

No.	Communication Destination	Network Configuration			Configured Module			Communication Destination	Open System	Sending Interval Monitoring Time [ms]	Safety Refresh Monitoring Time [ms]
		Network No.	Station No.	Station Type	Base No.	Mounting Slot No.	Model Name				
1											
2											
3											
4											
5											
6											
7											
8											
9											

4. Select "Local Network" for "Communication Destination", and display the "Select the target module for the Safety Communication Setting" window.

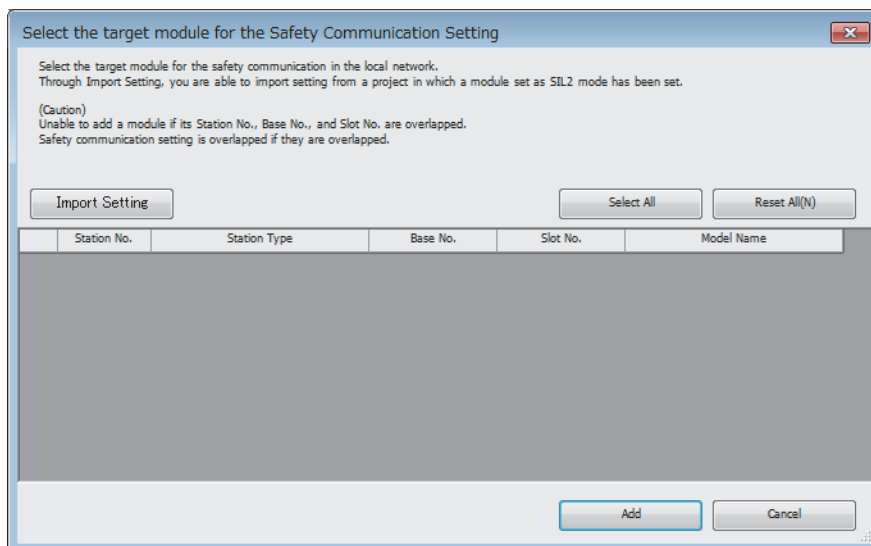

Select the target module for the safety communication in the local network.
Through Import Setting, you are able to import setting from a project in which a module set as SIL2 mode has been set.

(Caution)
Unable to add a module if its Station No., Base No., and Slot No. are overlapped.
Safety communication setting is overlapped if they are overlapped.

Import Setting Select All Reset All(N)

Station No.	Station Type	Base No.	Slot No.	Model Name

Add Cancel

5. Click the [Import Setting] button, and select the SIL2 system (remote head module side) project.

6. Select the check box for the safety communication setting target module, and click the [Add] button.

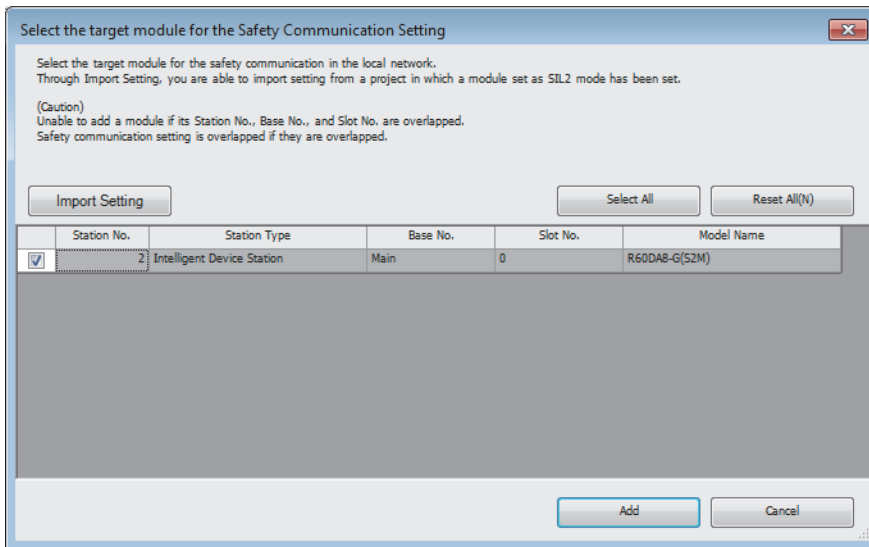

7. On the "Safety Communication Setting" window, configure the safety communication setting for the module added.

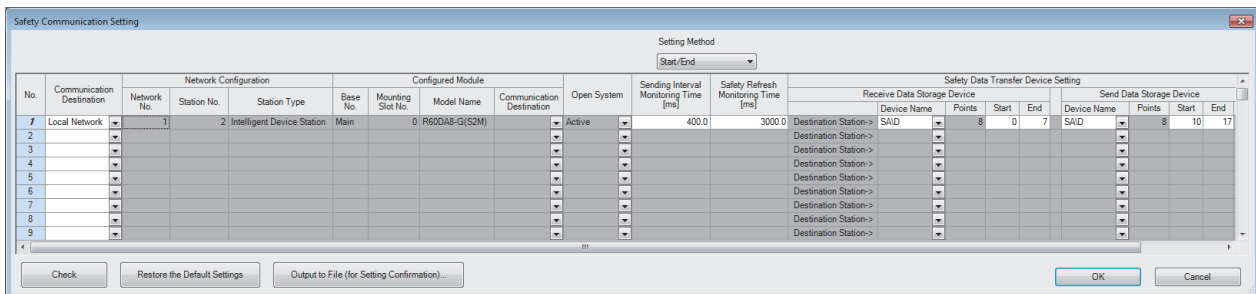

Item	Description
Sending Interval Monitoring Time [ms]	Refer to the following manual and set a value appropriate to your system. MELSEC iQ-R CC-Link IE Field Network User's Manual (Application) Set the time satisfying both of the following conditions. <ul style="list-style-type: none"> • $TM \geq S2cyc \times 3$ • $TM \geq (SCmst \times 2) + (LS \times 2)$ TM: Sending Interval Monitoring Time S2cyc: Control cycle time of the R60DA8-G (Page 163 Performance Specifications) SCmst: Safety cycle time of the master station (MELSEC iQ-R CPU Module User's Manual (Application)) LS: Link scan time (MELSEC iQ-R CC-Link IE Field Network User's Manual (Application))
Safety Refresh Monitoring Time [ms]	Refer to the following manual and set a value appropriate to your system. MELSEC iQ-R CC-Link IE Field Network User's Manual (Application)
Receive Data Storage Device	Select "SAID" or "SAIW" for "Device Name" to set the device for 8 points.
Send Data Storage Device	Select "SAID" or "SAIW" for "Device Name" to set the device for 8 points.

8. Write the set parameters to the SIL2 Process CPU and then reset the SIL2 Process CPU or turn off and on the power.

Writing the system A/B setting

Set system A/B to the SIL2 Process CPU in both systems. For details on setting procedure, refer to MELSEC iQ-R CPU Module User's Manual (Application). After the setting, both systems need to be restarted.

Setting user information

Set user information to set up access restrictions on the SIL2 Process CPU in both systems and projects. For details on setting procedure, refer to GX Works3 Operating Manual.

The set user information must be written into the SIL2 Process CPU in both systems.

Creating programs

Create a safety program and a standard program using the SIL2 diagnostic FB library. Refer to the following to create programs.

☞ Page 239 EXAMPLE OF OPERATION

■Pasting the SIL2 diagnostic FB library into programs

- Past the SIL2 safety program FB into the safety program of the fixed scan execution type program.
- Past the SIL2 standard program FB into the standard program of the scan execution type program.

Point

When more than one SIL2 safety program FB and SIL2 standard program FB are used, ensure that each FB has different instance name. If there is more than one FB with the same instance name, the target FB does not operate normally.

■Standard/safety shared label definition

Follow the procedure below to define a standard/safety shared label.

The defined standard/safety shared label is used in SIL2 safety program FB and SIL2 standard program FB.

1. Open the "New Data" window.

☞ [Navigation window] ⇒ [Label] ⇒ Right-click ⇒ [Add New Data]

2. Set the following contents and click the "OK" button. Set any name in "Data Name" but it must not be duplicated with any other "Data Name".

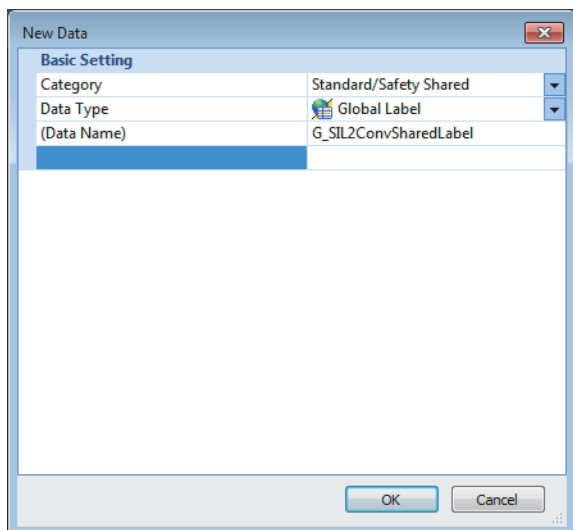

3. Set "Label Name". Set any name in "Label Name" but it must not be duplicated with any other "Label Name".

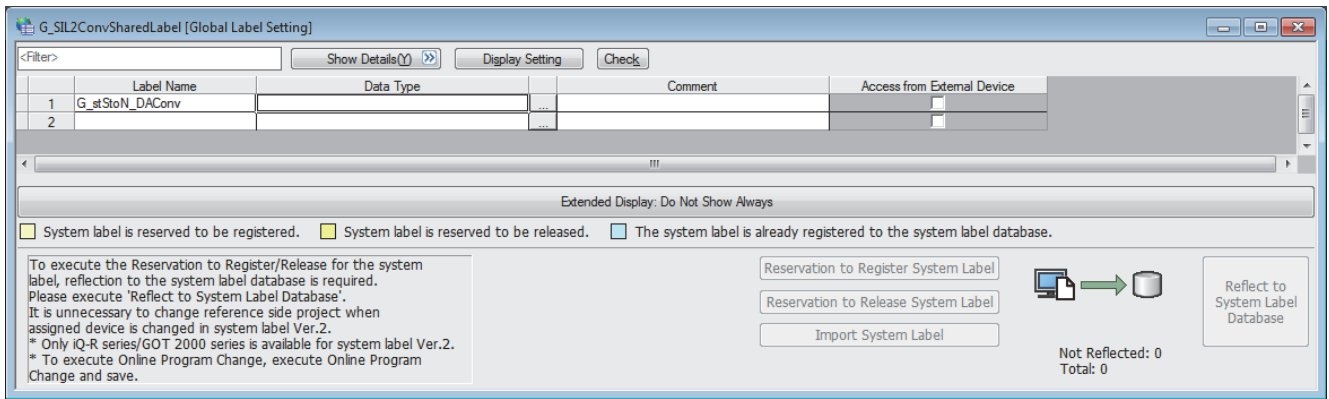

4. Click the [...] button to display the "Data Type Selection" window.
5. Set the following contents and click the "OK" button.

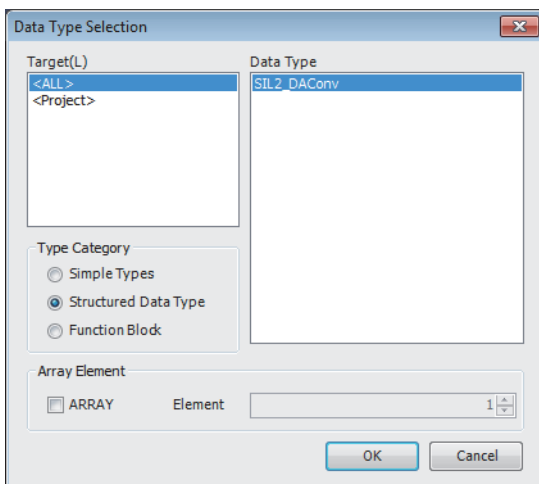

Point

When more than one SIL2 diagnostic FB library (SIL2 safety program FB and SIL2 standard program FB) are used, use each SIL2 diagnostic FB library as a single set. In addition, use a different standard/safety shared label for each set.



Safety module operation

Use the "Safety Module Operation" of the engineering tool to enable the R60DA8-G and allow its use in SIL2 mode.

Point

Before performing safety module operation, pay attention to the following points.

- Ensure that the engineering tool is directly connected to the SIL2 Process CPU in the control system (specify "No Specification" for the engineering tool connection destination setting) before starting "Safety Module Operation". Do not connect the engineering tool directly to the SIL2 Process CPU in the standby system. Depending on the system configuration, performing the safety module operation with the engineering tool directly connected to the SIL2 Process CPU in the standby system may cause a timeout. A time that triggers a timeout is Set time in "Check at Communication Time" (second) × 3. (The default value for "Check at Communication Time" is 30 seconds.) For details on "Check at Communication Time", refer to the GX Works3 Operating Manual.
- Safety module operation is not possible unless the safety operation mode of the SIL2 process CPU is TEST MODE. After checking that the safety operation mode of the SIL2 Process CPU is TEST MODE, perform safety module operation. For details on TEST MODE, refer to the MELSEC iQ-R CPU Module User's Manual (Application).

1. Open a project on the SIL2 Process CPU side.
2. Confirm that the safety operation mode of the SIL2 Process CPU is TEST MODE.
 [Diagnostics] ⇒ [Module Diagnostics (CPU Diagnostics)]
3. If the safety operation mode is SAFETY MODE, switch to TEST MODE.
 [Online] ⇒ [Safety PLC Operation] ⇒ [Switch Safety Operation Mode]
4. Start the "Safety Module Operation" window.
 [Online] ⇒ [Safety PLC Operation] ⇒ [Safety Module Operation]
5. Select the master/local module in the network where safety module operation is performed. The R60DA8-G to be enabled is displayed.

6. Select the check box for the R60DA8-G to be enabled, and click the [Update] button. The current enabled/disabled status of the SIL2 analog output system is displayed for "Module Status".

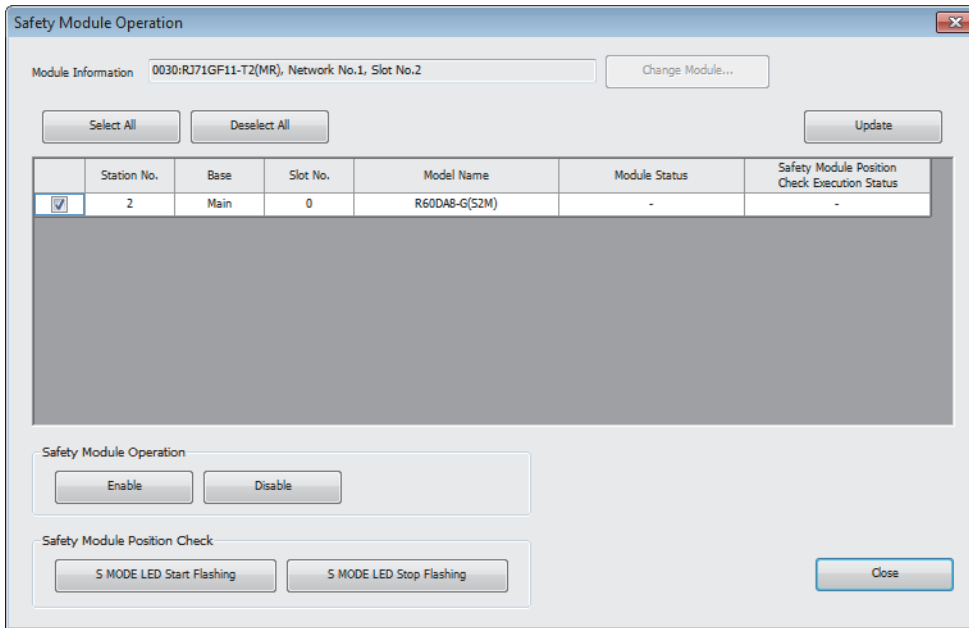

Module Status	Description
—	The information is not acquired.
Valid	The safety module is enabled and the configured parameters are valid.
Invalid	The safety module is not enabled and the configured parameters are not valid.
Valid (Reset Wait)	The safety module has just been enabled. In this state, the R60DA8-G needs to be reset, and the module status will be enabled after the reset. At this time, the ALM LED flashes every 0.4 seconds.
Invalid (Reset Wait)	The module has just been disabled. In this state, the R60DA8-G needs to be reset, and the module status will be disabled after the reset. At this time, the ALM LED flashes every 0.4 seconds.
Timeout	A timeout occurred because no response was returned from the target module. Check the settings or status of the target module. (☞ Page 257 When "Timeout" is displayed for "Module Status") <ul style="list-style-type: none"> • Is the module set to SIL2 mode? • Has an error occurred?

7. Select the check box for the R60DA8-G to be enabled, and click the [S MODE LED Start Flashing] button. Check that the S MODE LED of the R60DA8-G to be enabled is flashing (0.4s cycle). (At this time, the S MODE LED of the RY40PT5B-AS also flashes (0.4s cycles).) This operation makes it possible to check that there is no error on the operation target module before enabling it. In this case, the position checking status is displayed for "Safety Module Position Check Execution Status".

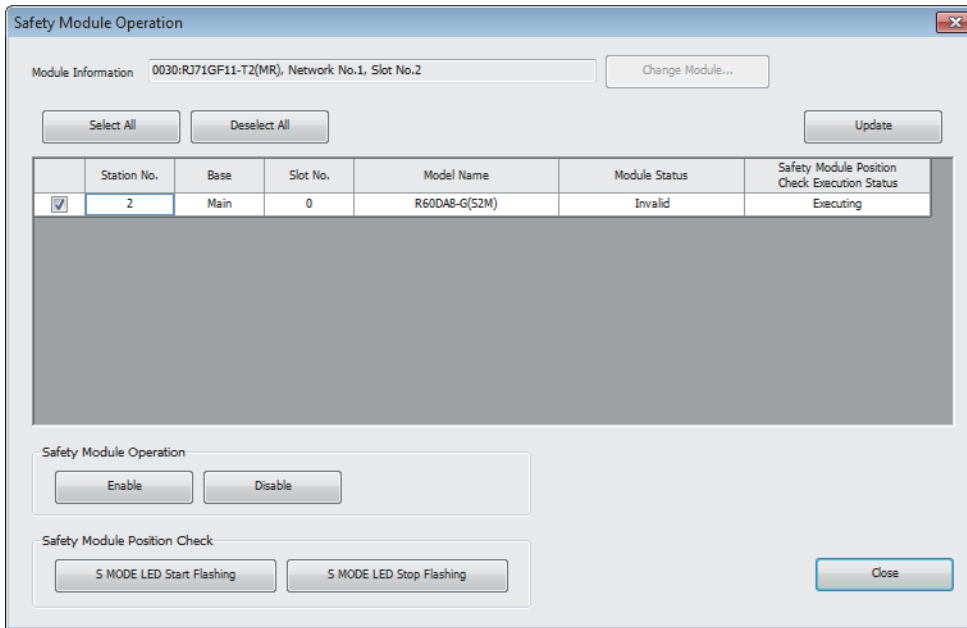

Safety Module Position Check Execution Status	Description
—	The information is not acquired.
Executing	The safety module position check is in process.
Stopping	The safety module position check is not executed.
Timeout	A timeout occurred because no response was returned from the target module. Check the settings or status of the target module. <ul style="list-style-type: none"> • Is the module set to SIL2 mode? • Has an error occurred?

8. After checking that the S MODE LED of the R60DA8-G to be enabled is flashing (0.4s cycle), click the [S MODE LED Stop Flashing] button to stop S MODE LED flashing.

Point

After clicking the [S MODE LED Start Flashing] button, the S MODE LED of the R60DA8-G will continue flashing (0.4s cycles) until the [S MODE LED Stop Flashing] button is clicked. Therefore, when the "Safety Module Operation" window is closed with the S MODE LED flashing (0.4s cycles), the S MODE LED of the R60DA8-G will continue flashing (0.4s cycles).

To stop the flashing of the S MODE LED (0.4s cycles) of the R60DA8-G, open the "Safety Module Operation" window again and click the [S MODE LED Stop Flashing] button.

9. Click the [Enable] button. In this case, the current enabled/disabled status of the safety module is displayed for "Module Status".

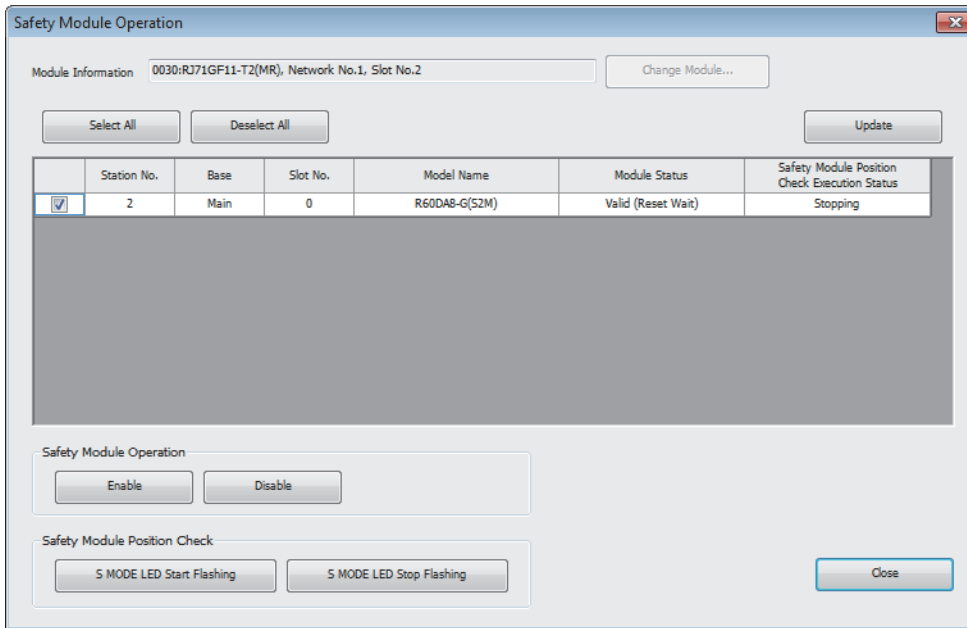

Module Status	Description
—	The information is not acquired.
Valid (Reset Wait)	The safety module has just been enabled. In this state, the R60DA8-G needs to be reset, and the module status will be enabled after the reset. At this time, the ALM LED flashes every 0.4 seconds.
Verification Failed	The module parameters are different between the SIL2 Process CPU project and the remote head module project. Ensure that the module parameters are consistent.
Enabling Failed (Module Error)	The safety module failed to be enabled. Check wiring or other items and retry it. If the error occurs again, the possible cause is a failure of the module.
Enabling Failed (Data Error)	
Timeout	A timeout occurred because no response was returned from the target module. Check the settings or status of the target module. (Page 257 When "Timeout" is displayed for "Module Status") <ul style="list-style-type: none"> • Is the module set to SIL2 mode? • Has an error occurred?

10. Check that "Valid (Reset Wait)" is displayed for "Module Status". The operations to enable and disable are reflected to the R60DA8-G after the remote head module is reset or after the power is turned off and on.
11. Reset the remote head module or turn off and on the power, and click the [Update] button.
12. Check that "Valid" is displayed for "Module Status".

Point

- If a module that is already enabled is attempted to be enabled, the status does not change to "Valid (Reset Wait)" while the status is in "Valid".
- When changing a module parameter of the R60DA8-G, enabling the safety module is required again.
- When enabling or disabling of the safety module is executed, the enable/disable status is saved to the flash memory inside the module, but the number of times this can be rewritten is limited. The number of possible rewrite operations combining both enabling/disabling is 250000 times. If this number of rewrite operations exceeds 250000 times, a number of safety module status switching exceeding limit error (error code: 1081H) occurs. Although rewrites of the validation status are executed, the rewrite content may not be reflected correctly.

■Disabling the safety module

A module enabled by "Safety Module Operation" can be disabled. Disable the module when checking the status of the module by stopping safety I/O or using the enabled module in standard mode.

1. In the "Safety Module Operation" window, select the check box for the R60DA8-G to be disabled, and click the [Disable] button. In this case, the current enabled/disabled status of the safety module is displayed for "Module Status".

Module Status	Description
—	The information is not acquired.
Invalid (Reset Wait)	The module has just been disabled. In this state, the R60DA8-G needs to be reset, and the module status will be disabled after the reset. At this time, the ALM LED flashes every 0.4 seconds.
Enabling Failed (Module Error)	The safety module failed to be enabled. Check wiring or other items and retry it. If the error occurs again, the possible cause is a failure of the module.
Enabling Failed (Data Error)	
Timeout	A timeout occurred because no response was returned from the target module. Check the settings or status of the target module. (☞ Page 257 When "Timeout" is displayed for "Module Status") <ul style="list-style-type: none"> • Is the module set to SIL2 mode? • Has an error occurred?

2. Check that "Invalid (Reset Wait)" is displayed for "Module Status" in the "Safety Module Operation" window. The operations to enable and disable are reflected to the R60DA8-G after the remote head module is reset or after the power is turned off and on.

Operation check

Check the status of each module used in the systems and program behaviors. For details on the check procedure, refer to the following.

☞ Page 169 PROCEDURES BEFORE OPERATION

1. Power off the SIL2 Process CPU in both systems and the remote head module.
2. Set the RUN/STOP/RESET switch for the SIL2 Process CPU in both systems and for the remote head module to RUN, and turn the power of the systems on.
3. Check each module to see if an error did not occur.
4. Check the LED on/off status of each module.

• Control system

R08PSFCPU	R6PSFM	R6RFM	RJ71GF11-T2
READY <input checked="" type="checkbox"/> ERROR <input type="checkbox"/> PROGRAM RUN <input checked="" type="checkbox"/> USER <input type="checkbox"/> BATTERY <input type="checkbox"/> CARD READY <input type="checkbox"/> CARD ACCESS <input type="checkbox"/> FUNCTION <input type="checkbox"/>	READY <input checked="" type="checkbox"/> ERROR <input type="checkbox"/> PROGRAM RUN <input checked="" type="checkbox"/> SAFETY COM RUN <input checked="" type="checkbox"/> SAFETY COM ERR <input type="checkbox"/> TEST <input checked="" type="checkbox"/>	RUN <input checked="" type="checkbox"/> ERR <input type="checkbox"/> SYS [A <input checked="" type="checkbox"/> CTRL <input type="checkbox"/> [B <input checked="" type="checkbox"/> SBY <input type="checkbox"/> [BACKUP <input checked="" type="checkbox"/> [SEPARATE <input type="checkbox"/> MEMORY COPY <input type="checkbox"/> LINK <input checked="" type="checkbox"/> L ERR <input type="checkbox"/>	RUN <input checked="" type="checkbox"/> ERR <input type="checkbox"/> MST <input checked="" type="checkbox"/> D LINK <input checked="" type="checkbox"/> SD/RD <input checked="" type="checkbox"/> L ERR <input type="checkbox"/>

• Standby system

R08PSFCPU	R6PSFM	R6RFM	RJ71GF11-T2
READY <input checked="" type="checkbox"/> ERROR <input type="checkbox"/> PROGRAM RUN <input checked="" type="checkbox"/> USER <input type="checkbox"/> BATTERY <input type="checkbox"/> CARD READY <input type="checkbox"/> CARD ACCESS <input type="checkbox"/> FUNCTION <input type="checkbox"/>	READY <input checked="" type="checkbox"/> ERROR <input type="checkbox"/> PROGRAM RUN <input checked="" type="checkbox"/> SAFETY COM RUN <input checked="" type="checkbox"/> SAFETY COM ERR <input type="checkbox"/> TEST <input checked="" type="checkbox"/>	RUN <input checked="" type="checkbox"/> ERR <input type="checkbox"/> SYS [A <input checked="" type="checkbox"/> CTRL <input type="checkbox"/> [B <input checked="" type="checkbox"/> SBY <input type="checkbox"/> [BACKUP <input checked="" type="checkbox"/> [SEPARATE <input type="checkbox"/> MEMORY COPY <input type="checkbox"/> LINK <input checked="" type="checkbox"/> L ERR <input type="checkbox"/>	RUN <input checked="" type="checkbox"/> ERR <input type="checkbox"/> MST <input checked="" type="checkbox"/> D LINK <input checked="" type="checkbox"/> SD/RD <input checked="" type="checkbox"/> L ERR <input type="checkbox"/>

• Remote head module side*1

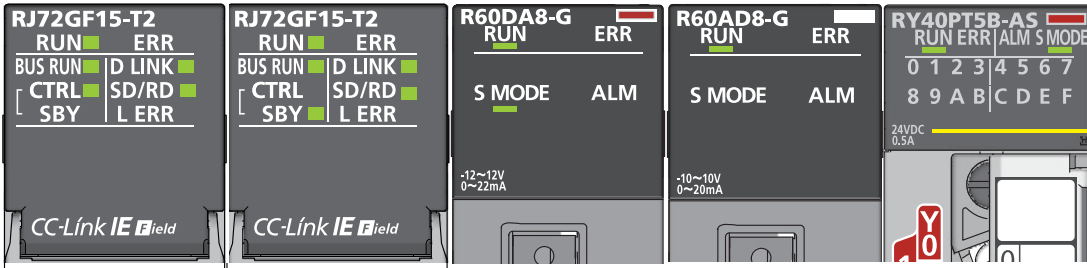

*1 Because the remote head module is not in a redundancy configuration for the redundant master station system, the following LEDs are always turned off.

- CTRL LED ·SBY LED

5. Check that no error occurred in CC-Link IE Field Network diagnostics.
 (MELSEC iQ-R CC-Link IE Field Network User's Manual (Application))

6. Check the behaviors of the safety program and standard program.

Switching safety operation mode

For normal operation as a SIL2 analog output system, switch the safety operation mode.

1. Power off the SIL2 Process CPU in both systems.
2. Set the RUN/STOP/RESET switch for the SIL2 Process CPU in both systems to STOP, and turn on the power.
3. With "Switch Safety Operation Mode" in the engineering tool, switch to the SAFETY MODE.
 [Online] ⇒ [Safety PLC Operation] ⇒ [Switch Safety Operation Mode]
4. Power off the SIL2 Process CPU in both systems and the remote head module.
5. Set the RUN/STOP/RESET switch for the SIL2 Process CPU in both systems and for the remote head module to RUN, and turn the power of the systems on.
6. Ensure that the TEST LED for the R6PSFM is off.

10.2 Range Switching Function

This function allows switching the output range of an analog output for each channel. Switching the range makes it possible to change the I/O conversion characteristics.

Setting procedure

Set the output range to be used in "Output range setting".

 [Navigation window] ⇒ [Parameter] ⇒ [Module Information] ⇒ Module model name ⇒ [Basic setting] ⇒ [Range switching function]

Output range setting	Digital input range
4 to 20mA	0 to 32000
0 to 20mA	
1 to 5V	0 to 32000
0 to 5V	
-10 to 10V	-32000 to 32000
4 to 20mA (Extension)	-8000 to 36000
1 to 5V (Extension)	
User range setting 3	-32000 to 32000
User range setting 1	

After the data is written, the output range is switched when the programmable controller power supply is turned off and on or when the CPU module is reset.

Behavioral difference from standard mode

- Since the R60AD8-G for diagnostics does not support 12V analog input, it is not possible to use the -12V to 12V range and user range setting 2 (-12V to 12V) with the R60DA8-G in SIL2 mode.
- In SIL2 mode, the user range setting can be used, but offset/gain setting is not possible. To use the user range setting in SIL2 mode, configure the offset/gain setting in standard mode in advance.

For details on the offset/gain setting, refer to the following manual.

 MELSEC iQ-R Channel Isolated Digital-Analog Converter Module User's Manual (Startup)

10.3 D/A Conversion Enable/Disable Setting Function

This function sets whether to enable or disable the D/A conversion for each channel. Disabling the D/A conversion for unused channels reduces the conversion cycles.

Setting procedure

Set "D/A conversion enable/disable setting" to "D/A conversion enable" or "D/A conversion disable".

 [Navigation window] ⇒ [Parameter] ⇒ [Module Information] ⇒ Module model name ⇒ [Basic setting] ⇒ [D/A conversion enable/disable function]

10.4 D/A Output Enable/Disable Setting Function

This function specifies whether to output the D/A conversion value or the offset value for each channel. The conversion speed is constant, regardless of the output enable/disable state.

Setting procedure

Use the `i_uOutputEnable` (output enable request) of SIL2 safety program FB to make the D/A output enable/disable setting.

<code>i_uOutputEnable</code> (output enable request)	Analog output
Output is disabled (Off)	The offset value is output.
Output is enabled (On)	The D/A conversion value is output.

10.5 Scaling Function

This function performs the scale conversion on digital values within a specified range between a scaling upper limit value and a scaling lower limit value. This function helps reduce the time taken for creating a scale conversion program.

Operation

The scale conversion is performed for the set "Digital value" using "Scaling upper limit value" and "Scaling lower limit value", and the value after the scale conversion is used for the D/A conversion. (In scale conversion, values are rounded off to the nearest whole number.)

Concept of scaling setting

The necessary settings for the scaling lower limit value and scaling upper limit value depend on whether the factory default setting or the user range setting is used for the analog output range.

■When the factory default setting is used for the analog output range

- For the scaling upper limit value, set a value corresponding to the upper limit value (analog output value) of the set output range.
- For the scaling lower limit value, set a value corresponding to the lower limit value (analog output value) of the set output range.

■When the user range setting is used for the analog output range

- Set a value corresponding to the gain value for the scaling upper limit value.
- Set a value corresponding to the offset value for the scaling lower limit value.

Calculating the scaling value

For D/A conversion, the scaling value is calculated based on the following calculation formulas.

■When the factory default setting is used for the output range

- When the voltage is 1 to 5V, 0 to 5V, or 1 to 5V (extended mode) or the current is 4 to 20mA, 0 to 20mA, or 4 to 20mA (extended mode)

$$\text{Digital value used for D/A conversion} = \frac{32000}{S_H - S_L} \times (D_X - S_L)$$

- When the voltage is -10 to 10V

$$\text{Digital value used for D/A conversion} = \frac{64000}{S_H - S_L} \times (D_X - S_L) - 32000$$

■When the user range setting is used for the output range

$$\text{Digital value used for D/A conversion} = \frac{32000}{S_H - S_L} \times (D_X - S_L)$$

Item	Description
D _X	Digital value
S _H	Scaling upper limit value
S _L	Scaling lower limit value

Point

- If the relation between the values is the scaling lower limit value > the scaling upper limit value, the scale conversion can be performed according to a negative slope.
- Set the scaling with the condition "Scaling upper limit value ≠ Scaling lower limit value".

Setting procedure

1. Set "D/A conversion enable/disable setting" to "D/A conversion enable".
 [Navigation window] ⇒ [Parameter] ⇒ [Module Information] ⇒ Module model name ⇒ [Basic setting] ⇒ [D/A conversion enable/disable function]
2. Set "Scaling enable/disable setting" to "Enable".
 [Navigation window] ⇒ [Parameter] ⇒ [Module Information] ⇒ Module model name ⇒ [Application setting] ⇒ [Scaling function]
3. Set values for "Scaling upper limit value" and "Scaling lower limit value".

Item	Setting range
Scaling upper limit value	-32000 to 32000
Scaling lower limit value	

Setting example of scaling

Ex.

When 14000 is set to the scaling upper limit value and 4000 is set to the scaling lower limit value for the channel with the output range of 0 to 5V

Analog output voltage (V)

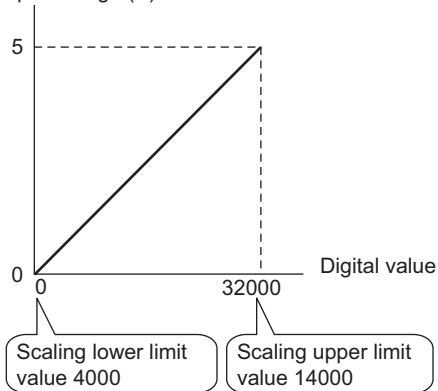

Digital value	Digital value after scaling	Output voltage (V)
4000	0	0
6000	6400	1
8000	12800	2
10000	19200	3
12000	25600	4
14000	32000	5

Outputting the analog values corresponding to the extended part of the output range

When the digital values in the extended part of the extended mode of the output range (the digital values in the range of 32768 to 36767 that correspond to the analog value higher than 20mA or 5V) are scaled to the 16-bit data range while the scaling function is enabled, the analog values corresponding to the extended part can be output.

Ex.

When 24000 is set to the scaling upper limit value and 0 is set to the scaling lower limit value for the channel with the output range of 1 to 5V (extended mode)

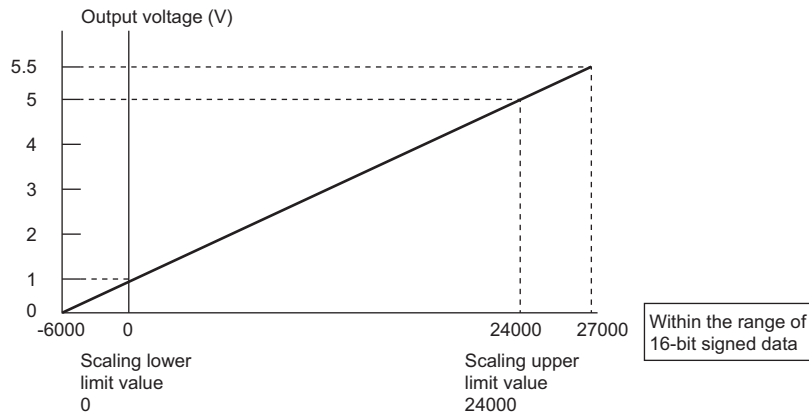

The digital value 27000 corresponds to the analog output voltage 5.5V. Thus, the analog values corresponding to the extended range can be output by setting "Digital value".

When the scaling function is used, the resolution may be reduced.

Precautions

- When the scaling function is used, the digital value can be set to a value out of the range between the scaling upper limit value and scaling lower limit value (in the dotted lines in the I/O conversion characteristic graph) before being scaled. However, use the scaling function within the range of the analog output practical range (in the solid line in the I/O conversion characteristic graph). If the value exceeds the analog output practical range, the maximum resolution and accuracy may not fall within the range of the performance specifications.
- When using the user range, note that the scaling lower limit value is equal to the offset value.
- When the scaling function is enabled and the digital value after the scaling conversion is out of the digital setting range, a digital value setting range error (error code: 191□H) occurs.
- When the scaling function is used while the output range is set to 4 to 20mA (extended mode) or 1 to 5V (extended mode), the digital values in the extended range may exceed the range of -32768 to 32767 and the setting may be disabled.

10.6 SIL2 D/A Conversion Function

The R60DA8-G, R60AD8-G for diagnostics, and RY40PT5B-AS use this function based on the time set in "SIL2 D/A conversion cycle setting" to execute D/A conversion that satisfies the safety level defined by IEC61508: 2010 SIL2 and IEC61511: 2015 SIL2 while executing error detection functions, such as analog output read-back discrepancy detection, and regular diagnostics for failure, such as D/A conversion circuit diagnostics or relay diagnostics. This function is realized using the SIL2 diagnostic FB library.

The functions executed as part of the SIL2 D/A conversion function, the SIL2 diagnostic FB library that is used, and the status of modules when an error is detected are shown below.

Function name	SIL2 diagnostic FB library used	Module status at error detection		
		Error description	Safety output status	Relay connection destination
Analog output read-back function	<ul style="list-style-type: none"> SIL2 safety program FB (M+SIL2DAG_DACnv_R) SIL2 standard program FB (M+SIL2DAG-IEF_ReadADVal_R) 	Analog output read-back discrepancy detection error (error code: 1ED□H)	The analog output value of the channel where the error occurred is turned off.	Disconnect the external device.
D/A conversion circuit diagnostic function		D/A conversion circuit diagnostic error (error code: 1EF□H)		
Relay diagnostic function				
Output HOLD function	—	Safety I/O HOLD time exceeded error (error code: 1500H)	Analog output values of all channels are turned off.	

SIL2 diagnostic FB library

The safety devices specified by the SIL2 diagnostic FB library and the corresponding I/O labels are as follows.

■SIL2 safety program FB (M+SIL2DAG_DACnv_R)

- Symbol

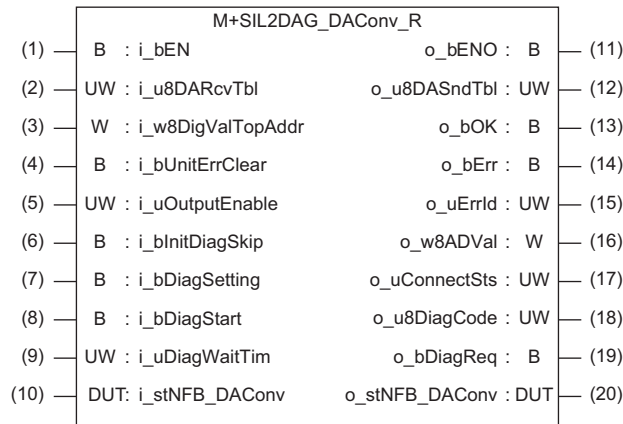

- Input labels

No.	Variable name	Name	Data type	Scope	Description
(1)	i_bEN	Execution command	Bit	On or off	On: The FB is activated. Off: The FB is not activated. For a setting example of this input label, refer to the following. ☞ Page 239 EXAMPLE OF OPERATION
(2)	i_u8DARcvTbl	Safety communications receive area	Word [unsigned]	Valid device range	The label sets the start device of the receive data storage device (8 words) for the safety communication setting.
(3)	i_w8DigValTopAddr	Digital value	Word [signed]	Valid device range	The label sets digital values to be output to the R60DA8-G. Areas of 8 words are required regardless of the number of D/A conversion enabled channels.
(4)	i_bUnitErrClear	Module error clear	Bit	On or off	Turn on this label to clear an occurring error. Turn off this label after the error is cleared.

No.	Variable name	Name	Data type	Scope	Description																			
(5)	i_uOutputEnable	Output enable request	Word [unsigned]	—	<p>The label specifies the channels for which an analog output from the R60DA8-G is enabled. b0 to b7 correspond to CH1 to CH8. b8 to b15 are not used.</p> <p>b15 ... b8 b7 b6 b5 b4 b3 b2 b1 b0</p> <table border="1" style="width: 100%; text-align: center;"> <tr> <td style="width: 12.5%;"></td> <td style="width: 12.5%;"></td> <td style="width: 12.5%;"></td> <td style="width: 12.5%;"></td> <td style="width: 12.5%;"></td> <td style="width: 12.5%;"></td> <td style="width: 12.5%;"></td> <td style="width: 12.5%;"></td> <td style="width: 12.5%;"></td> <td style="width: 12.5%;"></td> <td style="width: 12.5%;"></td> <td style="width: 12.5%;"></td> <td style="width: 12.5%;"></td> <td style="width: 12.5%;"></td> <td style="width: 12.5%;"></td> <td style="width: 12.5%;"></td> <td style="width: 12.5%;"></td> <td style="width: 12.5%;"></td> <td style="width: 12.5%;"></td> </tr> </table> <ul style="list-style-type: none"> • On: Output is enabled • Off: Output is disabled 																			
(6)	i_bInitDiagSkip	Start-up diagnostics skip request	Bit	On or off	<p>The label selects whether start-up diagnostics is to be performed or not. This option is available only if the safety operation mode of the SIL2 Process CPU is in TEST MODE. If the mode is not in TEST MODE, the diagnostics is performed regardless of this setting.</p> <ul style="list-style-type: none"> • On: No start-up diagnostics is performed. • Off: Start-up diagnostics is performed. 																			
(7)	i_bDiagSetting	Circuit diagnostics execution setting	Bit	On or off	<p>The label sets whether to execute D/A conversion circuit diagnostics automatically or manually.</p> <ul style="list-style-type: none"> • Off: Auto • On: Manual 																			
(8)	i_bDiagStart	Circuit diagnostics start request	Bit	On or off	<p>When i_bDiagSetting (circuit diagnostics execution setting) is set to Manual (on) and o_bDiagReq (D/A conversion circuit diagnostics waiting flag) is on, D/A conversion circuit diagnostics starts by turning on this flag. After o_bDiagReq (D/A conversion circuit diagnostics waiting flag) turns off, turn off this flag.</p>																			
(9)	i_uDiagWaitTim	Circuit diagnostics request WAIT time	Word [unsigned]	1 to 120 (min)	<p>When i_bDiagSetting (circuit diagnostics execution setting) is set to Manual (on) and o_bDiagReq (D/A conversion circuit diagnostics waiting flag) is on, a value set with this label determines how long to wait before i_bDiagStart (circuit diagnostics start request) is turned on. A value smaller than "D/A converter circuit Diagnostic cycle setting" must be set.</p>																			
(10)	i_stNFB_DACnv	Standard/safety shared input data	Structure	—	<p>Data from a SIL2 safety program FB to a SIL2 standard program FB is stored. For labels to be specified, refer to the following.</p> <p>☞ Page 198 Standard/safety shared label definition</p>																			

• Output labels

No.	Variable name	Name	Data type	Default value	Description																			
(11)	o_bENO	Execution status	Bit	Off	<p>On: The execution command is on. Off: The execution command is off.</p>																			
(12)	o_u8DASndTbl	Safety communications send area	Word [unsigned]	0	<p>The label sets the start device of the send data storage device (8 words) for the safety communication setting.</p>																			
(13)	o_bOK	Normal completion	Bit	Off	<p>The on state indicates that the FB processing has been completed successfully.</p>																			
(14)	o_bErr	Error completion	Bit	Off	<p>The on state indicates that the FB processing has been completed with an error.</p>																			
(15)	o_uErrld	Error code	Word [unsigned]	0	<p>The error code is stored at error completion.</p>																			
(16)	o_w8ADVal	Digital obtained value	Word [signed]	0	<p>Digital values obtained from the SIL2 standard program FB are output. This label specifies a safety device area for the CH1 storage location. For CH2 and subsequent channels, safety device areas are assigned and numbered sequentially starting from the next area of that specified for CH1.</p> <p>Areas of 8 words are required regardless of the number of D/A conversion enabled channels.</p>																			
(17)	o_uConnectSts	External device connection status	Word [unsigned]	0	<p>The label indicates the connection status between the R60DA8-G and an actuator.</p> <p>b15 ... b8 b7 b6 b5 b4 b3 b2 b1 b0</p> <table border="1" style="width: 100%; text-align: center;"> <tr> <td style="width: 12.5%;"></td> <td style="width: 12.5%;"></td> <td style="width: 12.5%;"></td> <td style="width: 12.5%;"></td> <td style="width: 12.5%;"></td> <td style="width: 12.5%;"></td> <td style="width: 12.5%;"></td> <td style="width: 12.5%;"></td> <td style="width: 12.5%;"></td> <td style="width: 12.5%;"></td> <td style="width: 12.5%;"></td> <td style="width: 12.5%;"></td> <td style="width: 12.5%;"></td> <td style="width: 12.5%;"></td> <td style="width: 12.5%;"></td> <td style="width: 12.5%;"></td> <td style="width: 12.5%;"></td> <td style="width: 12.5%;"></td> <td style="width: 12.5%;"></td> </tr> </table> <ul style="list-style-type: none"> • On: Connected • Off: Disconnected 																			

No.	Variable name	Name	Data type	Default value	Description
(18)	o_u8DiagCode	Status code	Word [unsigned]	0	A status code for each channel is stored. This label specifies a safety device area for the CH1 storage location. For CH2 and subsequent channels, safety device areas are assigned and numbered sequentially starting from the next area of that specified for CH1. Areas of 8 words are required regardless of the number of D/A conversion enabled channels.
(19)	o_bDiagReq	D/A conversion circuit diagnostics waiting flag	Bit	Off	When i_bDiagSetting (circuit diagnostics execution setting) is set to Manual (on) and the D/A conversion circuit diagnostic cycle has elapsed, the label outputs ON. When i_bDiagStart (circuit diagnostics start request) turns on or when i_uDiagWaitTim (circuit diagnostics request WAIT time) has elapsed, the label outputs OFF.
(20)	o_stNFB_DAConv	Standard/safety shared output data	Structure	—	Output data from a SIL2 safety program FB to a SIL2 standard program FB is set. For labels to be set, refer to the following.  Page 198 Standard/safety shared label definition

■ SIL2 standard program FB (M+SIL2ADG-IEF_WriteDAVal_R)

• Symbol

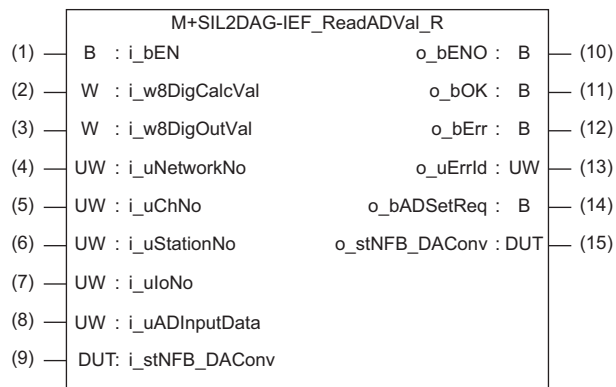

• Input labels

No.	Variable name	Name	Data type	Scope	Description
(1)	i_bEN	Execution command	Bit	On or off	On: The FB is activated. Off: The FB is not activated.
(2)	i_w8DigCalcVal	Digital operation value	Word [signed]	Valid device range	The label sets the device assigned to the CH□ digital operation value obtained from the R60AD8-G for diagnostics.
(3)	i_w8DigOutVal	Digital output value	Word [signed]	Valid device range	The label sets the device assigned to the CH□ digital output value obtained from the R60AD8-G for diagnostics.
(4)	i_uNetworkNo	Target network number	Word [unsigned]	1 to 239	The label sets the network number that was set in the network required setting of the remote head module.
(5)	i_uChNo	Own station channel	Word [unsigned]	1 to 32	The label sets the channel used for the network between the remote head module and the CPU module.
(6)	i_uStationNo	Target station number	Word [unsigned]	1 to 120	The label sets the station number that was set in the network required setting of the remote head module.
(7)	i_uIoNo	Target station start I/O number	Word [unsigned]	00H to FEH	The label sets the first three digits of the four-digit hexadecimal number that represents the start I/O number of the intelligent function module.
(8)	i_uADInputData	A/D module input information	Word [unsigned]	—	The label sets the device assigned to from 'Module READY' (X0) to 'Error flag' (XF) of the R60AD8-G for diagnostics.
(9)	i_stNFB_DACnv	Standard/safety shared input data	Structure	—	The label sets input data from the SIL2 safety program FB to the SIL2 standard program FB. For labels to be set, refer to the following. ☞ Page 198 Standard/safety shared label definition

• Output labels

No.	Variable name	Name	Data type	Default value	Description
(10)	o_bENO	Execution status	Bit	Off	The label outputs the execution status of the FB. On: Executing Off: Not executing
(11)	o_bOK	Normal completion	Bit	Off	The on state indicates that the FB processing has been completed successfully.
(12)	o_bErr	Error completion	Bit	Off	The on state indicates that the FB processing has been completed with an error.
(13)	o_uErrId	Error code	Word [unsigned]	0	The error code is stored at error completion.
(14)	o_bADSetReq	Operating condition setting request	Bit	Off	The label sets the device assigned to 'Operating condition setting request' (Y9) of the R60AD8-G for diagnostics.
(15)	o_stNFB_DACnv	Standard/safety shared output data	Structure	—	The label sets output data from the SIL2 standard program FB to the SIL2 safety program FB. For labels to be set, refer to the following. ☞ Page 198 Standard/safety shared label definition

Setting procedure

To use the SIL2 D/A conversion function, the following parameter settings and a program by the SIL2 diagnostic FB library are required.

- "SIL2 D/A conversion cycle setting"
- "Transmission interval monitoring time"

■ "SIL2 D/A conversion cycle setting"

Set the time until completion of the analog output read-back function.

 [Navigation window] ⇒ [Parameter] ⇒ [Module Information] ⇒ [R60DA8-G (S2M)] ⇒ [Basic setting] ⇒ [SIL2 D/A conversion cycle setting]

Item	Setting range
SIL2 D/A conversion cycle setting	2000 to 20000 (ms)

The following are the calculation formulas for the following recommended range settings. For "SIL2 D/A conversion cycle setting", set a value equal to or greater than the values obtained by the following calculation formulas.

Note that the larger calculation result of the following becomes a rough indication for a setting value.

- $(SCmst \times 8) + (RM \times 3) + (LS \times 12) + 16ms + (CHda \times 2ms \times 2)$
- $(SM \times 80) + (SCmst \times 6) + (RM \times 2) + (LS \times 4) + 4ms$

The following table lists symbols.

Symbol	Description
SCmst	Safety cycle time of master station (safety station)* ¹
RM	Safety refresh monitoring time* ²
LS	Link scan time
CHda	Number of D/A conversion enabled channels
SM	Sequence scan time of the master station (safety station)

*1 For the safety cycle time, refer to the following.

 MELSEC iQ-R CPU Module User's Manual (Application)

*2 For details on the safety refresh monitoring time, refer to the following.

 MELSEC iQ-R CC-Link IE Field Network User's Manual (Application)

Ex.

Calculation example with the following conditions:

- SCmst: 50ms
- RM: 400ms
- LS: 2ms
- CHda: 4 (D/A conversion enabled for CH1, CH2, CH3, CH8)
- SM: 100ms

Substituting the above conditions into the calculation formulas will result in the following.

- $(SCmst \times 8) + (RM \times 3) + (LS \times 12) + 16ms + (CHda \times 2ms \times 2) = (50ms \times 8) + (400ms \times 3) + (2ms \times 12) + 16ms + (4 \times 2ms \times 2) = 1656ms$
- $(SM \times 80) + (SCmst \times 6) + (RM \times 2) + (LS \times 4) + 4ms = (100ms \times 80) + (50ms \times 6) + (400ms \times 2) + (2ms \times 4) + 4ms = 9112ms$

9112ms becomes a rough indication for a setting value. With the above conditions, set "SIL2 D/A conversion cycle setting" to 9112ms or higher.

■ "Transmission interval monitoring time"

"Transmission interval monitoring time" of the R60DA8-G is the time used for monitoring where the master station detects an error on safety communications (data transmission from the R60DA8-G to the master station). If the interval of safety communications from the R60DA8-G exceeds the time set in "Transmission interval monitoring time", the master station detects it as disconnection.

 [Navigation window] ⇨ [Parameter] ⇨ [Module Information] ⇨ [R60DA8-G (S2M)] ⇨ [Basic Setting] ⇨ [Transmission interval monitoring time]

Item	Setting range
Transmission interval monitoring time	30 to 3000 (ms)

Set "Transmission interval monitoring time" of the R60DA8-G to the same value as that set in "Sending Interval Monitoring Time [ms]" on the "Safety Communication Setting" window. ( Page 195 Safety communication setting)

■ Program by SIL2 diagnostic FB library

With a project on the SIL2 Process CPU side, create a safety program and standard program and define the I/O of the SIL2 diagnostic FB library. Refer to the following to create programs.

 Page 239 EXAMPLE OF OPERATION

Timing chart of SIL2 D/A conversion function

The behavior of this function differs depending on whether normal operation or D/A conversion circuit diagnostic function execution is in progress.

■During normal operation

Odd number channel analog output read-back function and even number channel analog output read-back function are repeated alternately for each SIL2 D/A conversion cycle.

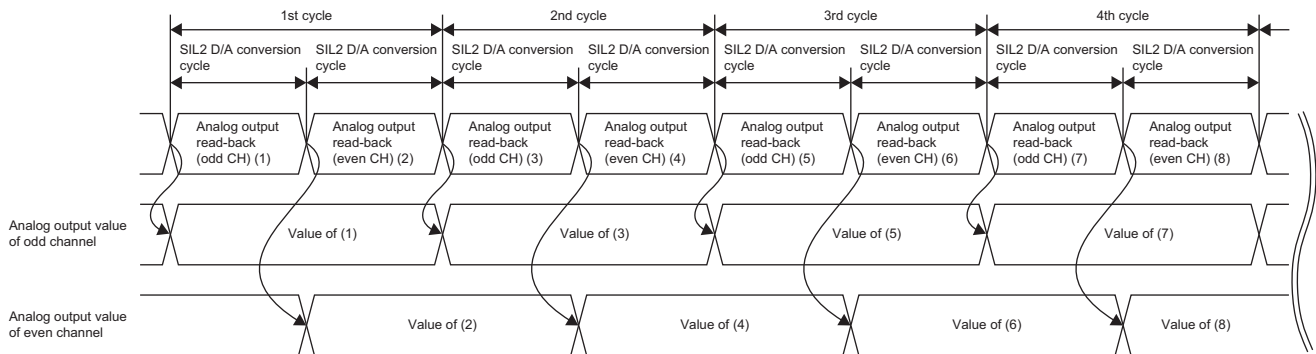

■During D/A conversion circuit diagnostic function execution

D/A conversion circuit diagnostics consists of a relay diagnostics phase and a D/A conversion circuit diagnostics phase, and it is carried out at every "D/A converter circuit Diagnostics cycle setting".

In the relay diagnostics phase, two patterns are executed, and after this, in the D/A conversion circuit diagnostics phase, 18 cycles are executed.

The timing chart of D/A conversion circuit diagnostics is shown below.

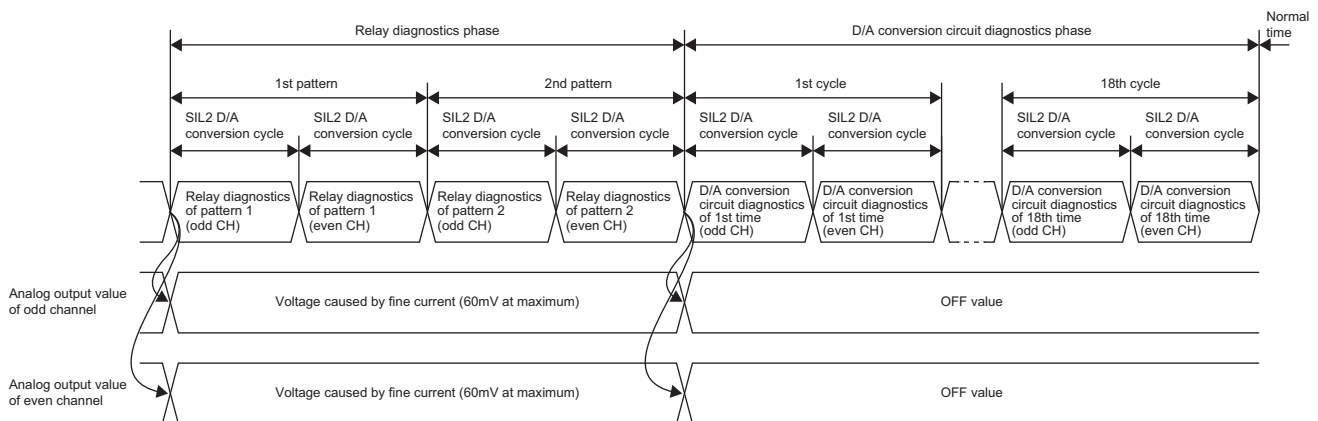

Analog output value update cycle

The cycle at which the analog output value is updated varies according to the following formula.

- SIL2 D/A conversion cycle setting × N

N is determined by the following.

D/A conversion enabled channels	N
Odd number channel only, or even number channel only	1
Enabled on odd and even number channels	2



If change of the cycle with which the analog output value is updated needs to be considered, build a system with the cycle calculated with $N = 2$.

Operation

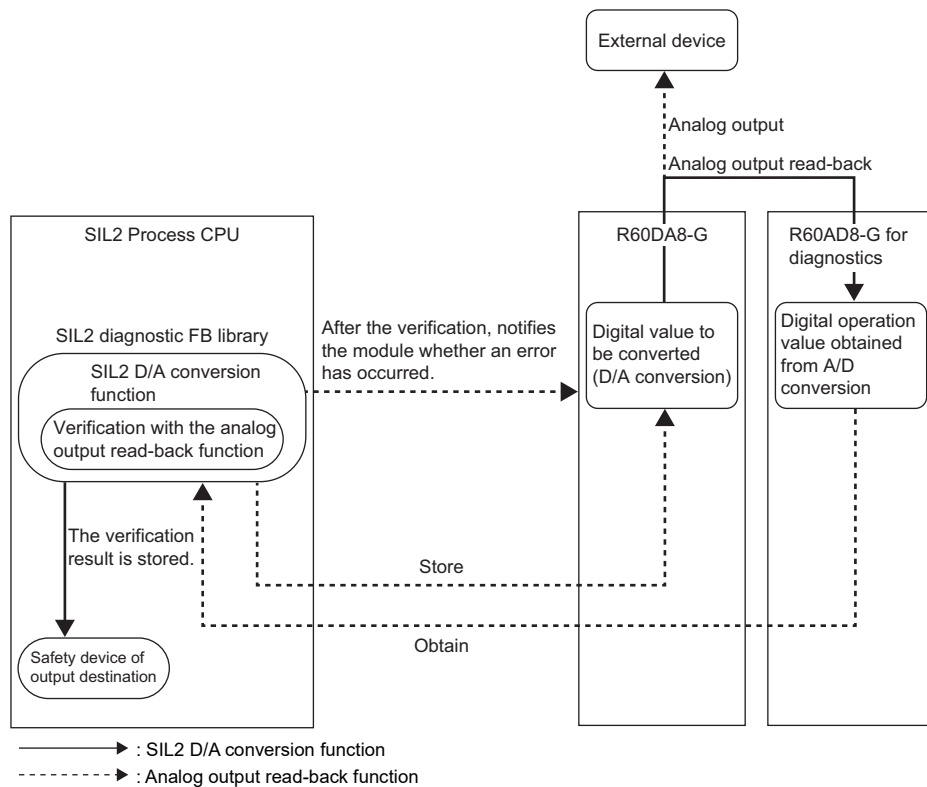

When an error is not detected by the analog output read-back function, a digital operation value obtained from the R60AD8-G is stored in the safety device specified by the SIL2 diagnostic FB library, and analog output continues.

For channels in which an analog output read-back discrepancy detection error or a D/A conversion circuit diagnostic error is detected, analog output is the OFF value (equivalent to 0V/0mA).

■ Digital value when analog output is OFF value (equivalent to 0V/0mA)

When an error is detected, the digital value of the OFF value (equivalent to 0V/0mA) in each output range is as follows.

Output range		Digital value when error is detected
Voltage	0 to 5V	0
	1 to 5V	-768
	1 to 5V (extended mode)	-8000
	-10 to 10V	0
	User range setting 3	Offset value
Current	0 to 20mA	0
	4 to 20mA	-768
	4 to 20mA (extended mode)	-8000
	User range setting 1	Offset value

■ Analog output at error clear

Errors detected by the R60DA8-G (analog output read-back discrepancy detection error or safety I/O HOLD time exceeded error) can be cleared by the SIL2 safety program FB or GX Works3.

Analog output value at error clear is as follows. After execution of error clear, the analog output value is updated from the OFF value to the specified value in the next analog output read-back phase.

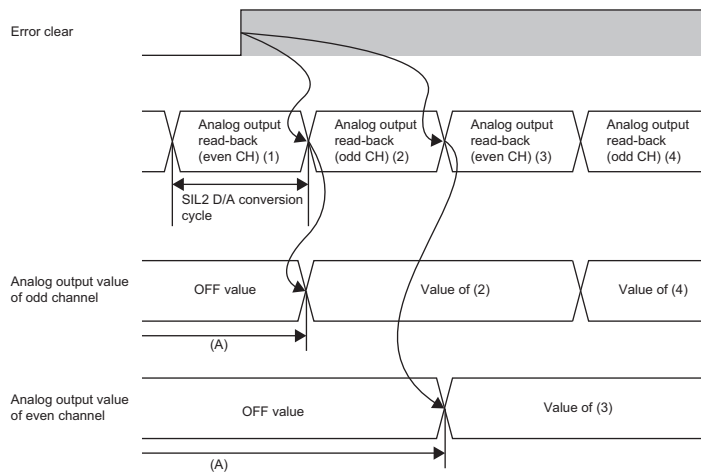

(A) After execution of error clear, the analog output value continues to be the OFF value until the phase shifts to next "analog output read-back (odd CH)" or next "analog output read-back (even CH)".

The above case is when an analog output read-back discrepancy detection error occurs.

- When an analog output read-back discrepancy detection error occurs, the analog output value is the OFF value only for a channel where an error occurred.
- When a safety I/O HOLD time exceeded error occurs, the analog output values of all channels are the OFF value.

Relay switching operation

This operation consists in controlling the RY40PT5B-AS from the R60DA8-G, and switching the connected relay.

- When the analog output read-back function is executed, analog values are output from the R60DA8-G to the external device by switching the relay.
- When D/A conversion circuit diagnostics is executed, analog values are output from the R60DA8-G to the R60AD8-G for diagnostics by switching the relay.
- When an error is detected, analog output from the R60DA8-G to the external device is shut off by switching the relay.

Analog output read-back function

In the SIL2 analog output system, the digital value is set to the R60DA8-G in SIL2 mode by safety communications from the SIL2 safety program FB and analog output is performed for the external device. At the same time, analog output to the R60AD8-G for diagnostics is also performed. SIL2 standard program FB acquires the digital operation value from the R60AD8-G for diagnostics and sends it to SIL2 safety program FB.

The SIL2 safety program FB verifies the digital value set to the R60DA8-G and the digital operation value sent from the R60AD8-G for diagnostics on channels to which output enable was requested and judges whether they are within the tolerance set in the "Allowable range setting of analog output readback".

This function is operated using the SIL2 safety program FB (M+SIL2DAG_DACnv_R) and SIL2 standard program FB (M+SIL2DAG-IEF_ReadADVal_R).

Point

If system switching occurs during analog output read-back, the analog output read-back is suspended, and after the system switching is complete, the verification processing is resumed at the point where it was suspended.

Setting procedure

To use the analog output read-back function, the following module parameter settings and a program by the SIL2 diagnostic FB library are required.

- "Allowable range setting of analog output readback"

■"Allowable range setting of analog output readback"

This setting is used to set the allowable error range when comparing the digital value set to the R60DA8-G and the digital operation value acquired by the R60AD8-G for diagnostics.

 [Navigation window] ⇒ [Parameter] ⇒ [Module Information] ⇒ [R60DA8-G(S2M)] ⇒ [Application setting] ⇒ [Allowable range setting of analog output readback]

Item	Setting range
Allowable range setting of analog output readback	±0.8 to ±8.0%

Point

- Adjust this setting if an analog output read-back discrepancy detection error (error code: 1ED□H) occurs frequently due to a noise affecting the digital operation value in noisy electrical environment.
- The setting of "Allowable range setting of analog output readback" is also applied to the error range of D/A conversion circuit diagnostics. ( Page 223 D/A conversion circuit diagnostic function)

■Program by SIL2 diagnostic FB library

With a project on the SIL2 Process CPU side, create a safety program and standard program and define the I/O of the SIL2 diagnostic FB library. Refer to the following to create programs.

 Page 239 EXAMPLE OF OPERATION

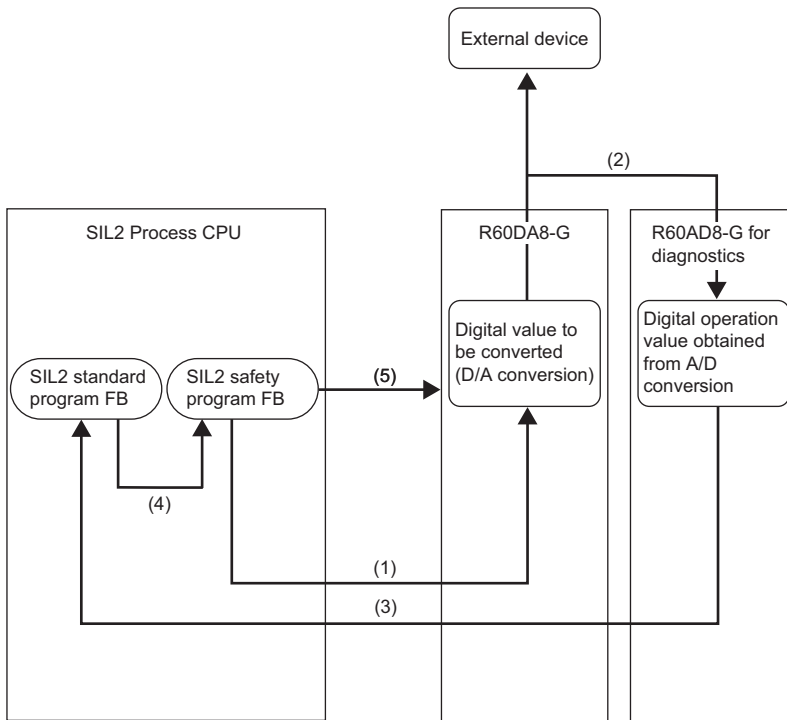

(1) Save the digital value from SIL2 safety program FB to the R60DA8-G.

(2) The R60DA8-G converts the stored digital value to an analog value and performs analog output of this value to the R60AD8-G for diagnostics.

(3) SIL2 standard program FB acquires the digital operation value A/D-converted by the R60AD8-G for diagnostics.

(4) SIL2 safety program FB acquires the digital operation value from SIL2 standard program FB and checks it against the digital value stored in the R60DA8-G.

(5) When the verification result shows that they are not within the error tolerance or does not show consistency within the SIL2 D/A conversion cycle, an analog output read-back discrepancy detection error (error code: 1ED□H) occurs.

■Precautions for the analog output range

- Use within the practical analog output range of each output range (☞ Page 271 I/O Conversion Characteristics). If the value exceeding the practical analog output range is used, an analog output read-back discrepancy detection error (error code: 1ED□H) may occur.
- To use the user range setting, perform offset/gain setting so that setting is within the practical analog output range. If offset/gain setting performed exceeds the practical analog output range, an analog output read-back discrepancy detection error (error code: 1ED□H) may be caused when using the user range setting.

D/A conversion circuit diagnostic function

The R60DA8-G regularly outputs an analog value and inputs it to the R60AD8-G for diagnostics to internally diagnose the D/A conversion circuit.

Internal diagnostics is executed at the following timing.

- When the power supply is turned on and the entire system starts normal operation (at initialization)
- At every time set in "D/A converter circuit Diagnostic cycle setting" (during operation)

This function is realized by using SIL2 safety program FB (M+SIL2DAG_DAConv_R) and SIL2 standard program FB (M+SIL2DAG-IEF_ReadADVal_R).

Point

- When system switching occurs during D/A conversion circuit diagnostics, the D/A conversion circuit diagnostics is interrupted and diagnostics is restarted from the point of interruption after the completion of system switching.
- D/A conversion circuit diagnostics is not executed in a channel in which an analog output read-back discrepancy detection error (error code: 1ED□H) occurred.
- When the safety operation mode of the SIL2 Process CPU is TEST MODE, skipping D/A conversion circuit diagnostics is allowed at initialization by turning on `i_blnitDiagSkip` (start-up diagnostics skip request) of SIL2 safety program FB (M+SIL2DAG_DAConv_R).

Setting procedure

To use the D/A conversion circuit diagnostic function, the following module parameter setting is required.

- "D/A converter circuit Diagnostic cycle setting"

Additionally, `i_bDiagSetting` (circuit diagnostics execution setting) of the SIL2 safety program FB can be used to set whether D/A conversion circuit diagnostics is executed automatically or manually at each cycle of D/A conversion circuit diagnostics. The default value is automatic execution.

■ "D/A converter circuit Diagnostic cycle setting"

Set the cycle at which to execute D/A conversion circuit diagnostics.

 [Navigation window] ⇒ [Parameter] ⇒ [Module Information] ⇒ [R60DA8-G (S2M)] ⇒ [Application setting] ⇒ [D/A converter circuit Diagnostic cycle setting]

Item	Setting range
D/A converter circuit Diagnostic cycle setting	60 to 480min

■ When `i_bDiagSetting` (circuit diagnostics execution setting) of the SIL2 safety program FB is set to Auto (off)

D/A conversion circuit diagnostics automatically starts at each cycle specified in "D/A converter circuit Diagnostic cycle setting", and analog output from the R60DA8-G to the external device is shut off by relay control during diagnostics.

The diagnostics time varies depending on the following formula.

- SIL2 D/A conversion cycle setting $\times 20 \times N$

N is determined by the following.

D/A conversion enabled channels	N
Odd number channel only, or even number channel only	1
Enabled on odd and even number channels	2

■When i_bDiagSetting (circuit diagnostics execution setting) of the SIL2 safety program FB is set to Manual (on)

At each cycle specified in "D/A converter circuit Diagnostic cycle setting", o_bDiagReq (D/A conversion circuit diagnostics waiting flag) of SIL2 safety program FB turns on. By turning on i_bDiagStart (circuit diagnostics start request) of the SIL2 safety program FB at this state, D/A conversion circuit diagnostics is started.

When either of following conditions is satisfied, o_bDiagReq (D/A conversion circuit diagnostics waiting flag) turns off.

- i_bDiagStart (circuit diagnostics start request) is turned on
- The time specified in i_uDiagWaitTim (circuit diagnostics request WAIT time) has elapsed after o_bDiagReq (D/A conversion circuit diagnostics waiting flag) turns on.

Operation

The operation of D/A conversion circuit diagnostics is shown below.

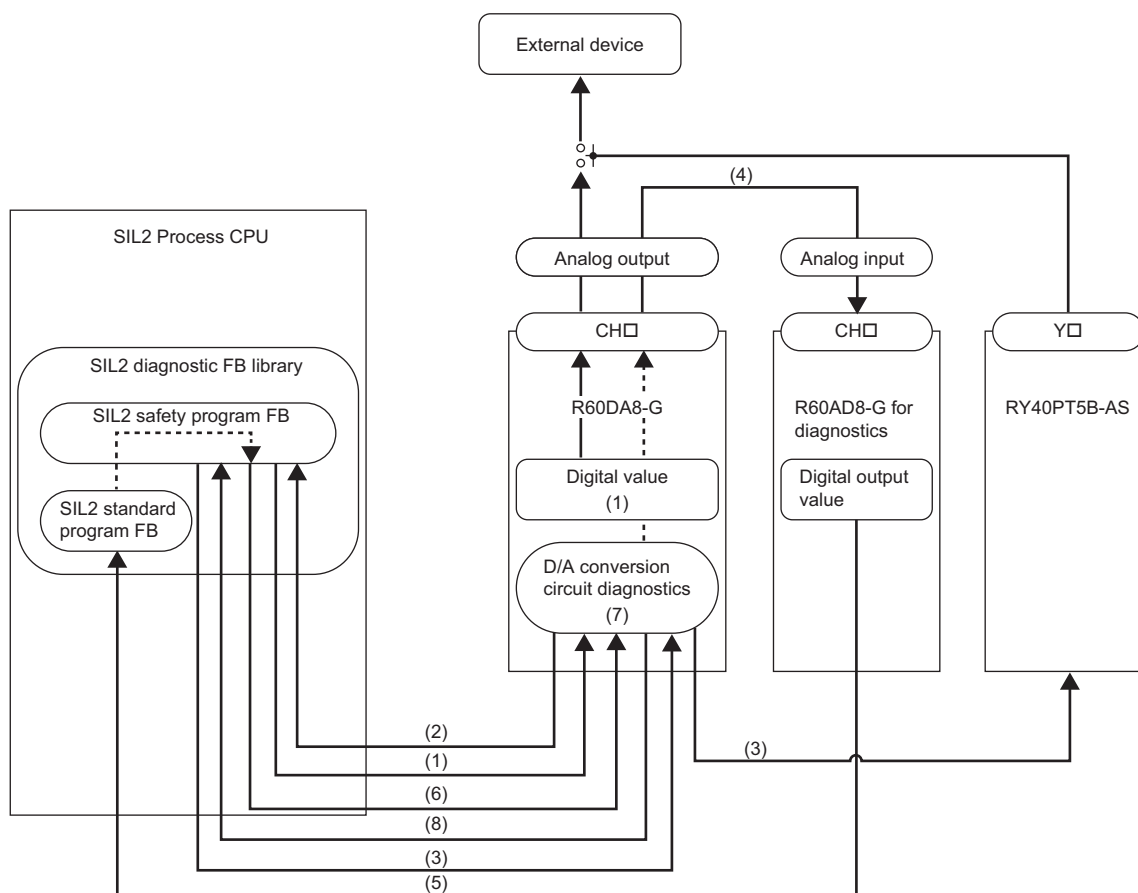

No.	Description
(1)	A diagnostics execution request and diagnostics pattern are sent from SIL2 safety program FB to the R60DA8-G.
(2)	The R60DA8-G sets a diagnostics digital value corresponding to the diagnostics pattern and returns a diagnostics execution response to SIL2 safety program FB.
(3)	A relay control request is sent from SIL2 safety program FB to the R60DA8-G. The R60DA8-G controls the relay and disconnects the external device.
(4)	The R60DA8-G converts the digital value for diagnostics to an analog value and outputs this value to the R60AD8-G for diagnostics.
(5)	The SIL2 standard program FB obtains a digital output value of the R60AD8-G for diagnostics and send it to the SIL2 safety program FB.
(6)	The SIL2 safety program FB stores the obtained digital output value to the R60DA8-G.
(7)	The R60DA8-G verifies whether a digital value for diagnostics of the R60DA8-G and a digital output value of the R60AD8-G for diagnostics are within the range specified in "Allowable range setting of analog output readback".
(8)	The verification result is sent to SIL2 safety program FB.
(9)	If there is a channel whose verification result is FAIL, steps (5) to (8) are repeated during the time specified in "SIL2 D/A conversion cycle setting". As the result of verification, a D/A conversion circuit diagnostic error (error code: 1E□□H) occurs in the channel where the error was judged to have occurred.

Point

- For verification, the setting value of "Allowable range setting of analog output readback" is automatically applied as the allowable error range. If D/A conversion circuit diagnostic errors occur frequently, adjust the setting of "Allowable range setting of analog output readback".
- When i_bEN (execution command) of SIL2 safety program FB is turned off, D/A conversion circuit diagnostics is not executed even if the D/A conversion circuit diagnostic cycle has elapsed, and instead D/A conversion circuit diagnostics is executed at the point when i_bEN (execution command) is turned on.
- During execution of the D/A conversion circuit diagnostic function, the analog output value output to the external device is the OFF value (equivalent to 0V/0mA).

■Diagnostics processing time of D/A conversion circuit diagnostics

The diagnostics processing time of D/A conversion circuit diagnostics both at initialization and operation are as the following formula.

- SIL2 D/A conversion cycle setting $\times 20 \times N$

N is determined by the following.

D/A conversion enabled channels	N
Odd number channel only, or even number channel only	1
Enabled on odd and even number channels	2

When SIL2 D/A conversion cycle setting is 2000ms (default value) and N = 2 as above, the diagnostics processing time is 80s.

Regarding the execution of D/A conversion circuit diagnostics by SIL2 safety program FB

■When Auto (off) is set for i_bDiagSetting (circuit diagnostics execution setting)

SIL2 safety program FB sends a diagnostics start request to the R60DA8-G when the D/A conversion circuit diagnostics elapsed time reaches "D/A converter circuit Diagnostic cycle setting". At this time, the D/A conversion circuit diagnostics elapsed time is cleared to 0.

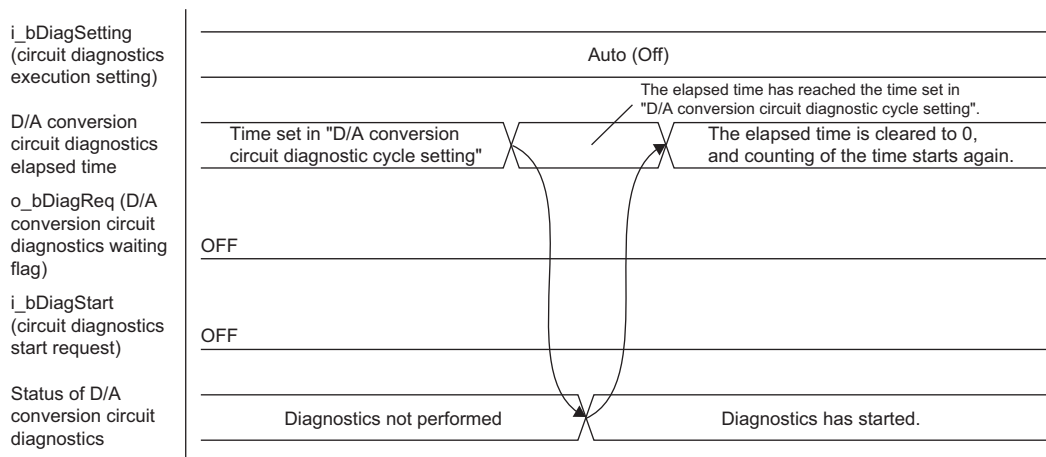

■When Manual (on) is set for i_bDiagSetting (circuit diagnostics execution setting)

SIL2 safety program FB turns on o_bDiagReq (D/A conversion circuit diagnostics waiting flag) when the D/A conversion circuit diagnostics elapsed time reaches "D/A converter circuit Diagnostic cycle setting".

When o_bDiagReq (D/A conversion circuit diagnostics waiting flag) is on, by turning on i_bDiagStart (circuit diagnostics start request) of the SIL2 safety program FB, the SIL2 safety program FB sends a diagnostics start request to the R60DA8-G.

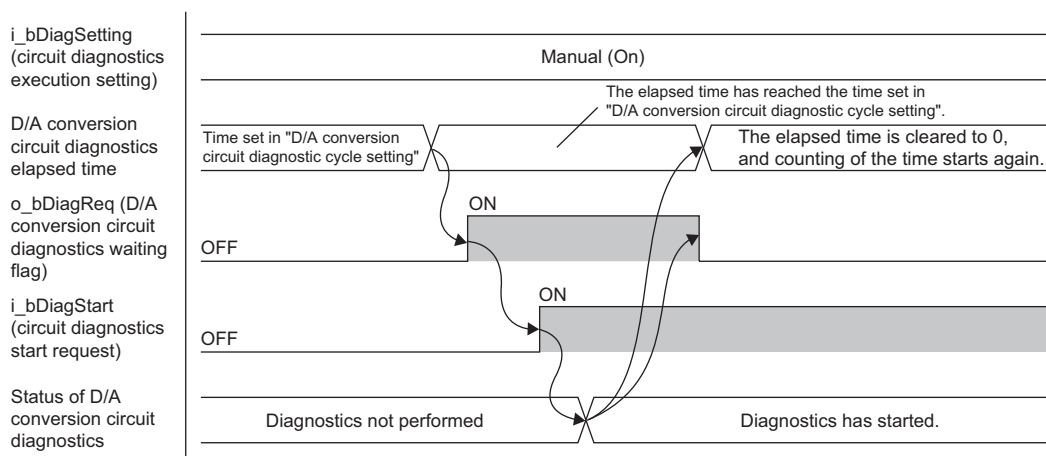

Moreover, if i_uDiagWaitTim (circuit diagnostics request WAIT time) has elapsed while o_bDiagReq (D/A conversion circuit diagnostics waiting flag) is on, o_bDiagReq (D/A conversion circuit diagnostics waiting flag) turns off.

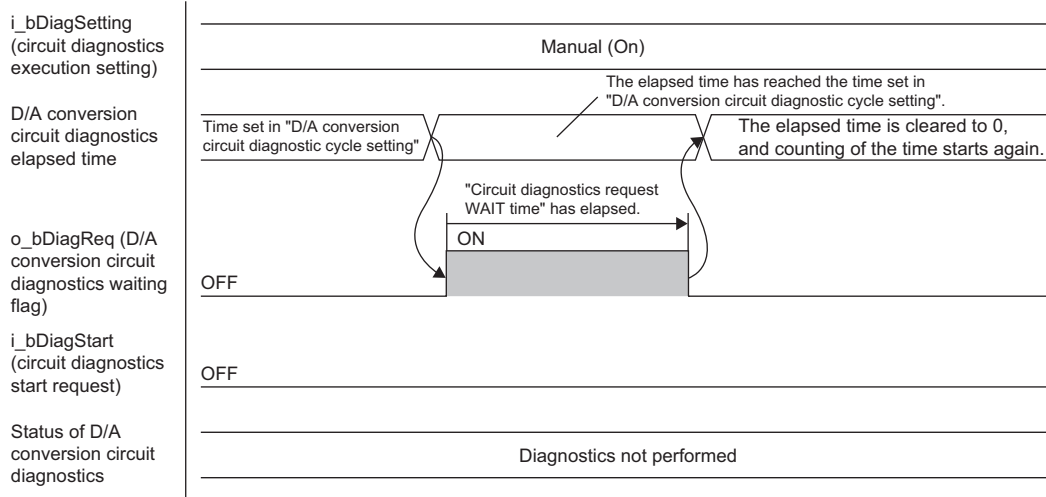

Relay diagnostic function

Micro current or micro voltage is applied to diagnose whether the relay connecting the R60DA8-G with external devices has any failures. For the D/A conversion circuit diagnostic function or detection of moderate error, the R60DA8-G needs to be connected with or shut off from the external device by controlling the relay. For this reason, whether or not the relay operates normally is also subject to diagnostics.

- When the voltage output range is set to the R60DA8-G, the failure status such as open of the relay, short, or drift is detected by applying micro current. Note that during relay diagnostics, voltage (maximum 60mV) generated by micro current may be applied to an external device.
- When the current output range is set to the R60DA8-G, the failure status such as open of the relay, short, or drift is detected by applying micro voltage. When the current output range is set, unlike the voltage output range, voltage is not applied to an external device.
- The relay diagnostic function is executed before the D/A conversion circuit diagnostic function.

Output HOLD function

This function holds the analog output value from when safety refresh data reception is interrupted until the specified time.

Output HOLD occurrence

When the R60DA8-G detects that safety refresh data receiving has an interrupt, the R60DA8-G holds the analog output value immediately before the interrupt.

Output HOLD release

After an output HOLD occurs (safety refresh data reception is interrupted), the hold on the analog output value is released when safety refresh data is received normally within the time set with "Safety I/O Hold Time" in "CPU Parameter".

Safety I/O HOLD time exceeded error

When the time of holding an analog output value exceeds the time set with "Safety I/O Hold Time" in "CPU Parameter", a safety I/O HOLD time exceeded error (error code: 1500H) occurs. Moreover, the analog output values of all channels are the OFF value (equivalent to 0V/0mA).

The safety I/O HOLD time exceeded error (error code: 1500H) can be cleared by any of the following.

- `i_bUnitErrClear` (module error clear) of SIL2 safety program FB
- [Clear Error] button on the "Module Diagnostics" window

10.7 Self-diagnostic Function

This function periodically monitors statuses inside the R60DA8-G such as the operating status of the MPU (operation processing unit), the state of the power supply voltage (detection of overvoltage and undervoltage), the communication state of safety communications, and the operating status of the stored programs.

When an error is detected by the self-diagnostic function, the analog output value becomes the OFF value (equivalent to 0V/0mA) for all the channels, and safety communications are stopped in the safety layer. Furthermore, if a hardware failure (error code: 3001H) is detected by the self-diagnostic function, a safety mutual monitoring error (error code: 3020H) occurs in the RY40PT5B-AS.

Self-diagnostic function list

Diagnostic name	Diagnostics	Diagnostic timing ^{*1}		Error that occurs at error detection	Diagnostic cycle
		At initialization ^{*2}	During operation ^{*3}		
Hardware diagnostic function	Diagnoses whether the MPU (operation processing unit) inside the R60DA8-G is operating normally.	○	○	Hardware failure (error code: 3001H)	8 hours or less
Power supply diagnostic function	Monitors the power supply voltage in the R60DA8-G, and when an error is detected, stops the operation of the MPU and shuts it down. ^{*5}	○	○	Hardware failure (error code: 3001H)	8 hours or less
Safety layer diagnostic function	Monitors the safety communications status between the R60DA8-G and SIL2 Process CPU.	×	○	^{*4}	Every 2ms
Firmware operation monitoring function	Monitors program operating status in the R60DA8-G.	○	○	Hardware failure (error code: 3001H)	Every 2ms

*1 ○ indicates applicability, and × indicates non-applicability.

*2 The diagnostic function is executed immediately after power-on. In the SIL2 analog output system, operation starts after completion of diagnostics at initialization. For this reason, operation of the SIL2 analog output system takes longer to start compared with a normal system due to the time required for the diagnostic function to run.

*3 The diagnostic function runs periodically after the SIL2 analog output system starts operating normally. Note that since the data on the safety device is not updated during the diagnostics, the data update interval of the safety device is lengthened.

*4 The error code that is generated depends on the error detection result.

· When an error is detected in the module's send/receive data: Hardware failure (error code: 3001H)

· When an error is detected in the data link: No error code is generated. The error is recorded in the event history.

*5 This indicates that power stops being supplied to the various circuits such as microcomputers, and the module enters the safe state. At shutdown, the module will be in the following state.

· On the system monitor window of GX Works3, the module is not mounted.

· The module's RUN LED, ERR LED, ALM LED, and S MODE LED are turned off.

10.8 RY40PT5B-AS Functions

Digital output read-back function

This function reads back the output results of the RY40PT5B-AS for diagnostics to see if the external output are turned on or off correctly. By performing diagnostics to see if the output terminal state and the output data match, the function detects an error in the module's output operation. To use this function, parameter setting of the R60DA8-G and RY40PT5B-AS is unnecessary.

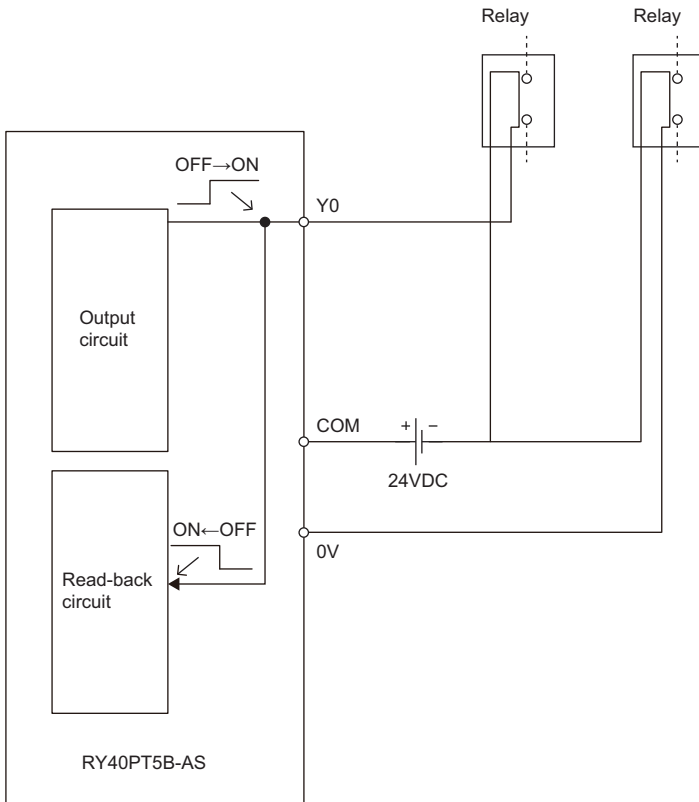

Operation when an error is detected

When an error is detected during digital output read-back diagnostics, a digital output read-back error (error code: 2002H) occurs in the RY40PT5B-AS.

For the output point where a digital output read-back error was detected, check it with Digital output read-back error detection state (Un\G1536) of the RY40PT5B-AS because a bit of the corresponding output point in this buffer memory area turns on.

Protection function

The following table lists protection functions.

Function name	Purpose	Description
Module power supply overvoltage protection	Protects against ignition and burnout originated from the RY40PT5B-AS due to an overvoltage on the primary side.	Activated when an overvoltage occurs in the module power supply.
Module power supply overcurrent protection	Protects against ignition and burnout originated from the RY40PT5B-AS due to an overcurrent on the primary side.	Activated when an overcurrent occurs in the module power supply.
Overload protection	Protects against ignition and burnout originated from the RY40PT5B-AS due to an overcurrent or overheating attributable to a short-circuit in the output circuit.	Activated when a current exceeding the rated value flows. In addition, a digital output read-back error (error code: 2002H) occurs in the RY40PT5B-AS. Returns to the normal state when the remote head module is reset or the power is turned off and on after the load goes down to the level of the rated load.
Overheat protection	Protects against ignition and burnout originated from the RY40PT5B-AS due to overheating attributable to an overcurrent in the output circuit.	When a high heat is detected inside the module, the outputs of the RY40PT5B-AS are turned off. In addition, a digital output read-back error (error code: 2002H) occurs in the RY40PT5B-AS. Returns to the normal state when the remote head module is reset or the power is turned off and on after the heat decreases to a certain level.

Point

- The protection functions protect the module's internal circuits, not intended to protect external devices.
- When an overload (overvoltage, overcurrent) occurs, the temperature inside the module may rise, which may deteriorate output elements or discolor the case or printed circuit board. When a load error occurs, turn off the module power supply immediately and eliminate the cause.

10.9 Error History Function

A maximum of 16 errors of the R60DA8-G and RY40PT5B-AS error history can be checked with the engineering tool.

[Diagnostics] ⇒ [System Monitor] ⇒ Right-click the target module. ⇒ [Module Diagnostics]

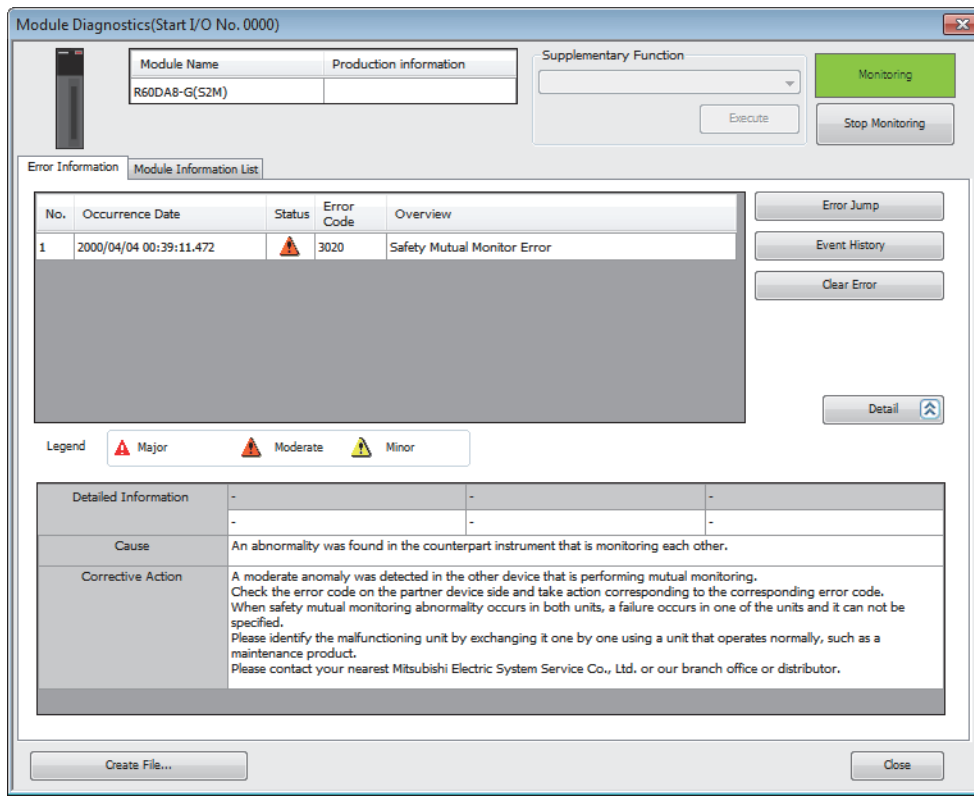

Point

When the error history exceeded 16 errors, the items will sequentially be overwritten starting from the first one as the error history continues to be recorded. And any items to be overwritten will be deleted.

How to clear error history

The error history can be cleared by any of the following methods.

- Turn the programmable controller's power off.
- Reset the remote head module.

10.10 Event History Function

This function collects errors and operations in the R60DA8-G and RY40PT5B-AS as event information in the remote head module.

The remote head module collects the event information occurred in the R60DA8-G and RY40PT5B-AS and holds them in the data memory inside of the remote head module.

The event information collected in the remote head module can be displayed using the engineering tool and the occurrence history can be checked in chronological order.

Event type	Classification	Description
System	Error	Self-diagnostics error detected in each module
	Warning	Warning (alarm) detected in each module
	Information	Operation normally detected by the system not classified as an error or a warning, or operation performed automatically by the system
Security	Warning	Operation that is judged as an unauthorized access to each module
	Information	Operation that could not be judged as a successful unlock of a password or an unauthorized access
Operation	Warning	Among operations performed on modules, delete operation (data clear) that is not judged as an error by self-diagnostics but likely to change the behavior
	Information	Operations performed by users including operation which changes system behavior and the structure

Details on the event history function

Refer to the following.

 MELSEC iQ-R CC-Link IE Field Network Remote Head Module User's Manual (Application)

Displaying event history

Display the event history from the menu of the engineering tool. For details on the operating procedure and how to view the contents, refer to the following.

 GX Works3 Operating Manual

List of event history data

■R60DA8-G

The following table lists the events that occur in the R60DA8-G.

Event code	Event classification	Event name	Description	Additional information
00150	Information	Safety communication start	Safety communications were started.	—
00151	Information	Safety communication stop	Safety communications were stopped.	—
00A00* ¹	Warning	Safety communication error	A safety communication error was detected.	—
00A02* ¹	Warning	Response monitoring timeout with safety communication connection being established	A response timeout occurred while a safety communication connection was being established.	—
00A03* ¹	Warning	Response monitoring timeout during safety communication refresh	A response timeout occurred during safety communication refresh.	—
00A04* ¹	Warning	Response monitoring timeout during safety communication error processing	A timeout occurred during the safety communication error response.	—
00A05* ¹	Warning	Safety communication reception interval monitoring timeout	No response was returned within the specified safety refresh monitoring time.	—
00A06* ¹	Warning	Safety communication receive data delay detection	Consecutive receive data is not complete.	—
00A07* ¹	Warning	Safety communication receive data loss detection	A loss of consecutive receive data was detected.	—
00A08* ¹	Warning	Application data error	A safety communication data frame error was detected.	—
00A10	Warning	Safety module validation match failure	An error was detected at the verification of safety parameter.	—
00A13	Warning	Safety module disabled (parameter error)	A module parameter error was detected and the state transited to the safety module disabled state.	—
00A14	Warning	Safety module disabled (safety disabled module detection)	A safety disabled module was detected in the module set and the state transited to the safety module disabled state.	—
00A15	Warning	Disabling the safety module (parameter mismatch when enabling the safety module)	The system switched to the safety module disabled state because the parameter information saved in the non-volatile memory and the module parameters do not match when enabling the safety module.	—
20100	Information	Error release (error clear)	An error clear request was executed.	—

*1 This event may occur when changing the SIL2 Process CPU system, but the analog output value is held during the time interval during which the output hold function is enabled (the time set with "Safety I/O Hold Time" in "CPU Parameter").

■RY40PT5B-AS

The following table lists the events that occur in the RY40PT5B-AS.

Event code	Event classification	Event name	Description	Additional information
00150	Information	Safety communication start	Safety communications were started.	—
00151	Information	Safety communication stop	Safety communications were stopped.	—
00A00* ¹	Warning	Safety communication error	A safety communication error was detected.	—
00A02* ¹	Warning	Response monitoring timeout with safety communication connection being established	A response timeout occurred while a safety communication connection was being established.	—
00A03* ¹	Warning	Response monitoring timeout during safety communication refresh	A response timeout occurred during safety communication refresh.	—
00A04* ¹	Warning	Response monitoring timeout during safety communication error processing	A timeout occurred during the safety communication error response.	—
00A05* ¹	Warning	Safety communication reception interval monitoring timeout	No response was returned within the specified safety refresh monitoring time.	—
00A06* ¹	Warning	Safety communication receive data delay detection	Consecutive receive data is not complete.	—
00A07* ¹	Warning	Safety communication receive data loss detection	A loss of consecutive receive data was detected.	—
00A08* ¹	Warning	Application data error	A safety communication data frame error was detected.	—

*1 This event may occur when switching the SIL2 Process CPU system, but the output value will be held for the time when the output HOLD function of the R60DA8-G is enabled (time set in "Safety I/O Hold Time" in "CPU Parameter").

11 PARAMETER SETTINGS

Set the parameters of the R60DA8-G.

The module parameters of the RY40PT5B-AS are automatically issued from the R60DA8-G, so there are no items to set.

11.1 Basic Settings

Setting procedure

Open "Basic setting" of the engineering tool.

1. Start Module Parameter.

[Navigation window] ⇒ [Parameter] ⇒ [Module Information] ⇒ Target module ⇒ [Basic setting]

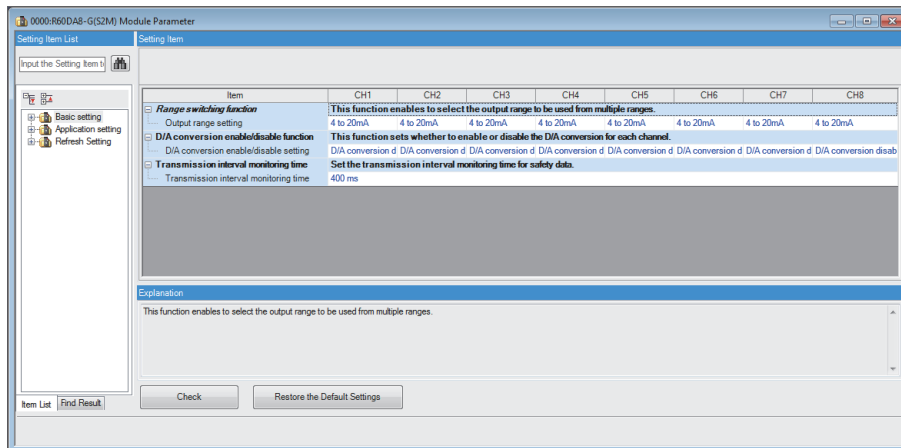

2. Double-click on an item to be changed and enter a setting value.

- Item where a value is selected from a drop-down list

Click the [▼] button of the item to be set to display a drop-down list. Select an item.

- Item where a value is entered into a text box

Double-click on the item to be set and enter a numerical value.

11.2 Application Settings

Setting procedure

Open "Application setting" of the engineering tool.

1. Start Module Parameter.

[Navigation window] ⇒ [Parameter] ⇒ [Module Information] ⇒ Target module ⇒ [Application setting]

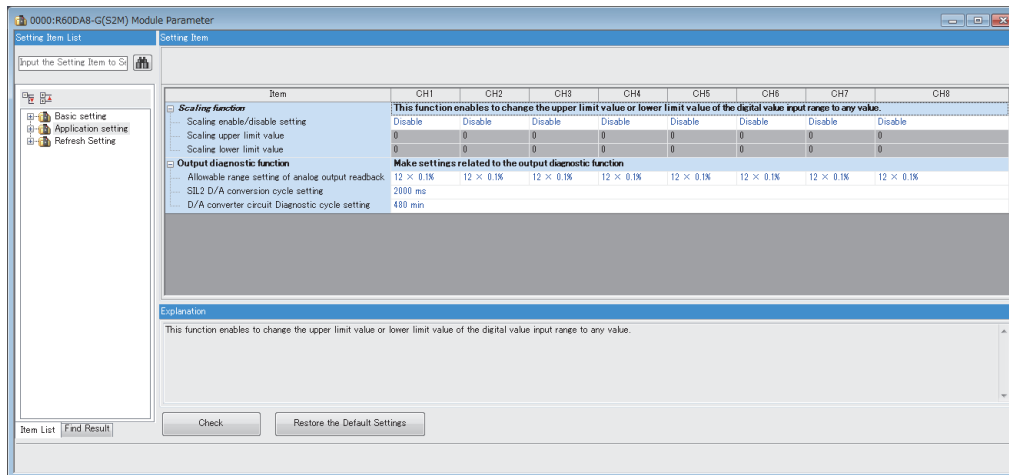

2. Double-click on an item to be changed and enter a setting value.

- Item where a value is selected from a drop-down list

Click the [▼] button of the item to be set to display a drop-down list. Select an item.

- Item where a value is entered into a text box

Double-click on the item to be set and enter a numerical value.

11.3 Refresh Settings

Module parameter refresh settings are not available for the R60DA8-G that is set to SIL2 mode.

12 EXAMPLE OF OPERATION

This chapter provides a program example to operate the R60DA8-G in SIL2 mode.

System configuration

The following system configuration is used to explain an example of operation.

☞ Page 177 Redundant Master Station

Program conditions

- The D/A conversion enabled channels are CH1, CH2, CH3, and CH4.
- The output range is 0 to 5V for all channels

Procedures before operation

Build a system and set parameters according to the following procedure.

☞ Page 169 PROCEDURES BEFORE OPERATION

However, to operate under the system configuration and program conditions shown in this operation example, make the following settings in each parameter setting window.

■"CPU Parameter" for the SIL2 Process CPU

Item	Description
Safety Cycle Time	100.0ms

■"Basic Settings" of master/local module

Item	Description																																																																										
Network Configuration Setting	<table border="1"> <thead> <tr> <th rowspan="2">No.</th> <th rowspan="2">Model Name</th> <th rowspan="2">STA#</th> <th rowspan="2">Station Type</th> <th colspan="3">RX/Ry Setting</th> <th colspan="3">RWw/RWr Setting</th> <th rowspan="2">Reserved/Error Invalid Station/System Switching Monitoring Target Station</th> </tr> <tr> <th>Points</th> <th>Start</th> <th>End</th> <th>Points</th> <th>Start</th> <th>End</th> </tr> </thead> <tbody> <tr> <td>0</td> <td>Host Station</td> <td>0</td> <td>Master Station</td> <td></td> <td></td> <td></td> <td></td> <td></td> <td></td> <td></td> </tr> <tr> <td>1</td> <td>Host Station</td> <td>1</td> <td>Sub-Master Station</td> <td></td> <td></td> <td></td> <td></td> <td></td> <td></td> <td>No Setting</td> </tr> <tr> <td>2</td> <td>RJ72GF15-T2</td> <td>2</td> <td>Intelligent Device Station</td> <td>80</td> <td>0000</td> <td>004F</td> <td>8</td> <td>0000</td> <td>0007</td> <td>No Setting</td> </tr> </tbody> </table>	No.	Model Name	STA#	Station Type	RX/Ry Setting			RWw/RWr Setting			Reserved/Error Invalid Station/System Switching Monitoring Target Station	Points	Start	End	Points	Start	End	0	Host Station	0	Master Station								1	Host Station	1	Sub-Master Station							No Setting	2	RJ72GF15-T2	2	Intelligent Device Station	80	0000	004F	8	0000	0007	No Setting																								
No.	Model Name					STA#	Station Type	RX/Ry Setting			RWw/RWr Setting			Reserved/Error Invalid Station/System Switching Monitoring Target Station																																																													
		Points	Start	End	Points			Start	End																																																																		
0	Host Station	0	Master Station																																																																								
1	Host Station	1	Sub-Master Station							No Setting																																																																	
2	RJ72GF15-T2	2	Intelligent Device Station	80	0000	004F	8	0000	0007	No Setting																																																																	
Refresh Setting	<table border="1"> <thead> <tr> <th rowspan="2">No.</th> <th colspan="4">Link Side</th> <th rowspan="2"></th> <th colspan="4">CPU Side</th> </tr> <tr> <th>Device Name</th> <th>Points</th> <th>Start</th> <th>End</th> <th>Target</th> <th>Device Name</th> <th>Points</th> <th>Start</th> <th>End</th> </tr> </thead> <tbody> <tr> <td>-</td> <td>SB</td> <td></td> <td></td> <td></td> <td>↔</td> <td></td> <td></td> <td></td> <td></td> <td></td> </tr> <tr> <td>-</td> <td>SW</td> <td></td> <td></td> <td></td> <td>↔</td> <td></td> <td></td> <td></td> <td></td> <td></td> </tr> <tr> <td>1</td> <td>RWr</td> <td>16</td> <td>0000</td> <td>0000F</td> <td>↔</td> <td>Specify Device</td> <td>W</td> <td>16</td> <td>01000</td> <td>0100F</td> </tr> <tr> <td>2</td> <td>RX</td> <td>16</td> <td>00010</td> <td>0001F</td> <td>↔</td> <td>Specify Device</td> <td>X</td> <td>16</td> <td>01000</td> <td>0100F</td> </tr> <tr> <td>3</td> <td>RY</td> <td>16</td> <td>00010</td> <td>0001F</td> <td>↔</td> <td>Specify Device</td> <td>Y</td> <td>16</td> <td>01000</td> <td>0100F</td> </tr> </tbody> </table>	No.	Link Side					CPU Side				Device Name	Points	Start	End	Target	Device Name	Points	Start	End	-	SB				↔						-	SW				↔						1	RWr	16	0000	0000F	↔	Specify Device	W	16	01000	0100F	2	RX	16	00010	0001F	↔	Specify Device	X	16	01000	0100F	3	RY	16	00010	0001F	↔	Specify Device	Y	16	01000	0100F
No.	Link Side					CPU Side																																																																					
	Device Name	Points	Start	End		Target	Device Name	Points	Start	End																																																																	
-	SB				↔																																																																						
-	SW				↔																																																																						
1	RWr	16	0000	0000F	↔	Specify Device	W	16	01000	0100F																																																																	
2	RX	16	00010	0001F	↔	Specify Device	X	16	01000	0100F																																																																	
3	RY	16	00010	0001F	↔	Specify Device	Y	16	01000	0100F																																																																	

■"Application Settings" of master/local module

Item	Description																																								
Safety communication setting	<table border="1"> <thead> <tr> <th colspan="10">Safety Data Transfer Device Setting</th> </tr> <tr> <th colspan="5">Receive Data Storage Device</th> <th colspan="5">Send Data Storage Device</th> </tr> <tr> <th></th> <th>Device Name</th> <th>Points</th> <th>Start</th> <th>End</th> <th>Device Name</th> <th>Points</th> <th>Start</th> <th>End</th> <th></th> </tr> </thead> <tbody> <tr> <td>Destination Station-></td> <td>SAID</td> <td>8</td> <td>0</td> <td>7</td> <td>SAID</td> <td>8</td> <td>10</td> <td>17</td> <td>->Destination Station</td> </tr> </tbody> </table>	Safety Data Transfer Device Setting										Receive Data Storage Device					Send Data Storage Device						Device Name	Points	Start	End	Device Name	Points	Start	End		Destination Station->	SAID	8	0	7	SAID	8	10	17	->Destination Station
Safety Data Transfer Device Setting																																									
Receive Data Storage Device					Send Data Storage Device																																				
	Device Name	Points	Start	End	Device Name	Points	Start	End																																	
Destination Station->	SAID	8	0	7	SAID	8	10	17	->Destination Station																																

■Module parameters for "R60DA8-G (S2M)"

Perform the following settings. For parameters other than the following, use the default values.

Module parameter		Description
Basic setting	D/A conversion enable/disable setting	CH1 to CH4: D/A conversion enable
	Output range setting	CH1: 0 to 5V CH2: 0 to 5V CH3: 0 to 5V CH4: 0 to 5V
Application setting	SIL2 D/A conversion cycle setting	2500ms

■Module parameters for "R60AD8-G"

Perform the following settings. For parameters other than the following, use the default values.

Module parameter		Description
Basic setting	A/D conversion enable/disable setting	CH1 to CH4: A/D conversion enable
	Input range setting	CH1: 0 to 5V CH2: 0 to 5V CH3: 0 to 5V CH4: 0 to 5V
Refresh settings	Digital output value	Set W1000 to W1007 to CH1 to CH8 in ascending order of channel number. Example: CH1: W1000, CH2: W1001, ..., CH7: W1006, CH8: W1007
	Digital operation value	Set W1008 to W100F to CH1 to CH8 in ascending order of channel number. Example: CH1: W1008, CH2: W1009, ..., CH7: W100E, CH8: W100F

Devices used

■ SIL2 safety program FB

Device	Description
SAISD1008.0	Execution command Sets the safety refresh communication status of connection number 1 for slot 1 of the remote head module.
SAISM1800	System switching signal
SAM1001	Module error clear
SAM1002	Start-up diagnostics skip request
SAM1003	Circuit diagnostics execution setting
SAM1004	Circuit diagnostics start request
SAM1005	Execution status
SAM1006	Normal completion
SAM1007	Error completion
SAM1008	System switching signal latch
SAM1009	D/A conversion circuit diagnostics waiting flag
SAM1010	System error
SAM1011 to SAM1018 ^{*3}	Channel error: CH1 to CH8
SAM1020 to SAM1035 ^{*2}	Output enable request: SAM1020 to SAM1027 correspond to Channel 1 to 8. SAM1028 to SAM1035 are not used.
SAID0000 to SAID0007	Safety communications receive area
SAID0010 to SAID0017	Safety communications send area
SAID1100 to SAID1107 ^{*1}	Digital value
SAID1110	Circuit diagnostics request WAIT time
SAID1020	Error code
SAID1030 to SAID1037 ^{*1}	Digital obtained value: CH1 to CH8
SAID1040	External device connection status
SAID1050 to SAID1057 ^{*1}	Status code: CH1 to CH8

*1 Consecutive eight word areas are required regardless of number of D/A conversion enabled channels.

*2 Consecutive 16-bit areas are required regardless of the number of D/A conversion enabled channels.

*3 Consecutive 8-bit areas are required regardless of the number of D/A conversion enabled channels.

■ SIL2 standard program FB

Device	Description
SM400	Execution command (always ON)
M1001	Execution status
M1002	Normal completion
M1003	Error completion
D1000	Target network number
D1001	Own station channel
D1002	Target station number
D1003	Target station start I/O number
D1010	Error code
W1000 to W1007 ^{*1}	Digital output value of the R60AD8-G for diagnostics
W1008 to W100F ^{*1}	Digital operation value of the R60AD8-G for diagnostics
X1000 to X100F	'Module READY' (X0) to 'Error flag' (XF) of the R60AD8-G for diagnostics
Y1009	Operating condition setting request of the R60AD8-G for diagnostics

*1 Consecutive eight word areas are required regardless of number of D/A conversion enabled channels.

The function block used

The following function block is used in this program example.

■ SIL2 safety program FB

- M+SIL2DAG_DACnv_R_00A

■ SIL2 standard program FB

- M+SIL2DAG-IEF_ReadADVal_R_00A

Program example

- When the safety refresh communication status is normal, digital values are output to CH1 to CH4 of the R60DA8-G.
- To skip the start-up diagnostics, turn on Start-up diagnostics skip request (SAM1002).
- When Execution status (SAM1005) and Normal completion (SAM1006) of the SIL2 safety program FB are on, processing runs according to Status code (SA\D1050 to SA\D1053) of each channel. For channels whose Status code is Analog output read-back completed (8004H), processing for normal state runs. For channels whose Status code indicates an error (C001H or larger), Channel error (SAM1011 to SAM1014) turns on.
- Execution status (SAM1005) and Error completion (SAM1007) of the SIL2 safety program FB are on, System error (SAM1010) turns on.
- To clear the errors currently occurring, turn on Module error clear (SAM1001). Turn off Module error clear (SAM1001) after checking the error reset.
- For a channel whose digital value output to the R60DA8-G is to be stopped, turn off Output enable request (SAM1020 to SAM1027). The channel whose Output enable request (SAM1020 to SAM1027) was turned off stops output of the digital value.
- To clear the errors currently occurring, turn off and on Execution status (M1001).

SIL2 safety program FB

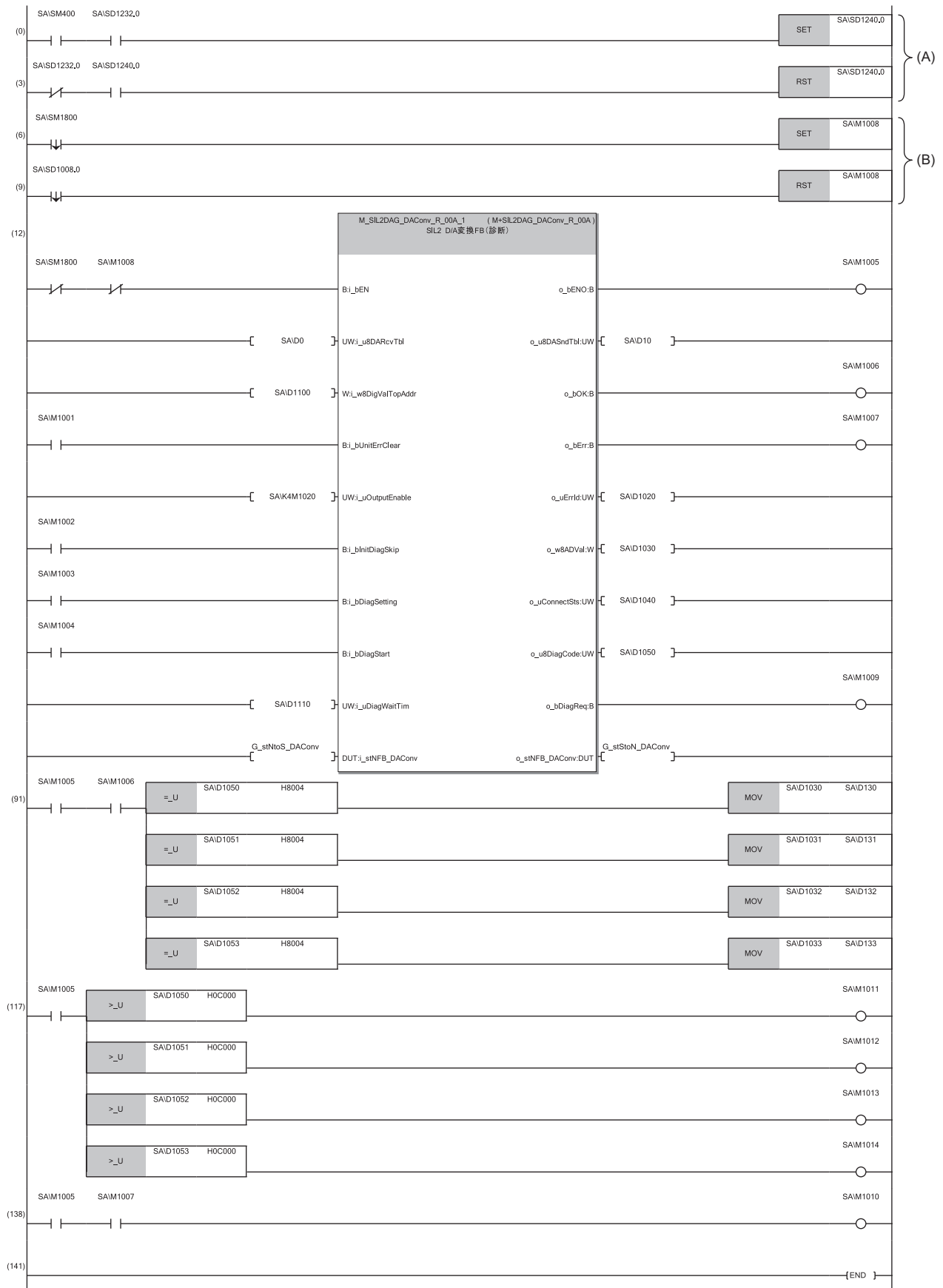

The program (A) is required to continue safety communications after system switching. When using the SIL2 safety program FB, include the program (A).

The program (B) is required to notify the SIL2 safety program FB of the operation timing after system switching. When using the SIL2 safety program FB, include the program (B).

■SIL2 standard program FB

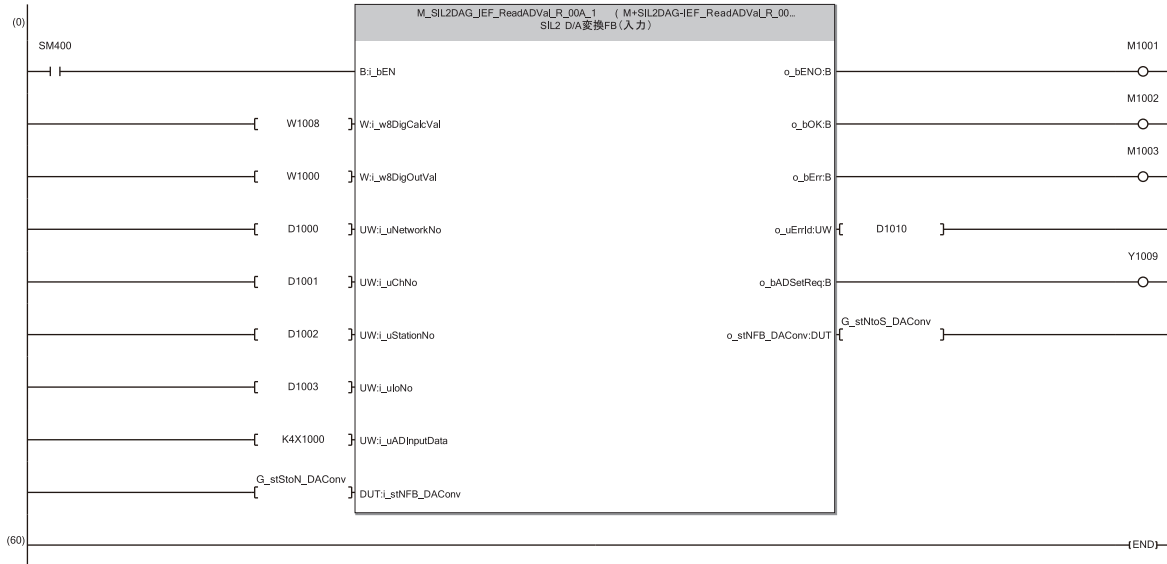

13 MAINTENANCE AND INSPECTION

This chapter describes inspection to be performed for using the R60DA8-G in SIL2 mode.

Periodic inspection

Perform the following inspection one or two times in 6 months to a year. Perform it as well after equipment is transferred or modified, or wiring is changed.

- Check that the relay switching is properly performed by a continuity check for relays.

For other inspection items, refer to the following.

 MELSEC iQ-R Module Configuration Manual

MEMO

14 TROUBLESHOOTING

This chapter describes errors that may occur in the use of the R60DA8-G and RY40PT5B-AS and those troubleshooting.

14.1 Troubleshooting with the LEDs

Check the state of the LEDs to narrow down the possible causes of the trouble. This step is the first diagnostics before using the engineering tool.

R60DA8-G

A state of the R60DA8-G can be checked with the RUN LED, ERR LED, ALM LED, and S MODE LED. The following table shows the correspondence of these LEDs and a state of the R60DA8-G.

Name	Description
RUN LED	Indicates the operating status of the module. On: Normal operation Flashing (1s cycles): In offset/gain setting mode Off: 5V power off or a watchdog timer error occurred.
ERR LED	Indicates the error status of the module.*1 On: An error occurred (minor error). Flashing: An error occurred (moderate error). Off: Normal operation
ALM LED	Indicates the wait-for-restart status after the safety module is enabled. Flashing (400ms cycles): Wait-for-restart Off: Normal operation
S MODE LED	Indicates the operating status of the module (SIL2 mode). On: SIL2 D/A conversion is ongoing. Flashing (1s cycles): SIL2 D/A conversion is stopped. Flashing (400ms cycles): Executing the module position check*2 Off: Operating in standard mode

*1 For details, refer to the following.

☞ Page 264 List of Error Codes

*2 For details, refer to the following.

☞ Page 200 Safety module operation

RY40PT5B-AS

The state of the RY40PT5B-AS can be checked with the RUN LED, ERR LED, ALM LED, and S MODE LED. The following table shows the correspondence of these LEDs and the state of the RY40PT5B-AS.

Name	Description
RUN LED	Indicates the operating status. On: Operating Off: 5V power off or a watchdog timer error occurred.
ERR LED	Indicates the error status of the module.*1 Flashing: An error occurred (moderate error). Off: Normal operation
ALM LED	Indicates the wait-for-restart status after the safety module is enabled. Flashing (400ms cycles): Wait-for-restart Off: Normal operation
S MODE LED	Indicates the operating status of the module (SIL2 mode). On: Safety output in progress Flashing (1s cycles): Safety output stopped Flashing (400ms cycles): Executing the module position check*2

*1 For details, refer to the following.

☞ Page 264 List of Error Codes

*2 For details, refer to the following.

☞ Page 200 Safety module operation

14.2 Checking the State of the Module

The following functions are available in the "Module Diagnostics" window of the R60DA8-G and RY40PT5B-AS.

Function	Application
Error Information	Displays the details of the currently occurring error. Clicking the [Event History] button displays the errors that have occurred on the network and the history of the errors detected and the operations executed on each module.
Module Information List	Displays each status information of the R60DA8-G and RY40PT5B-AS.

Error Information

Check the description and the actions of the errors that have occurred.

[Diagnostics] ⇒ [System Monitor] ⇒ Right-click the module to be checked. ⇒ "Module Diagnostics"

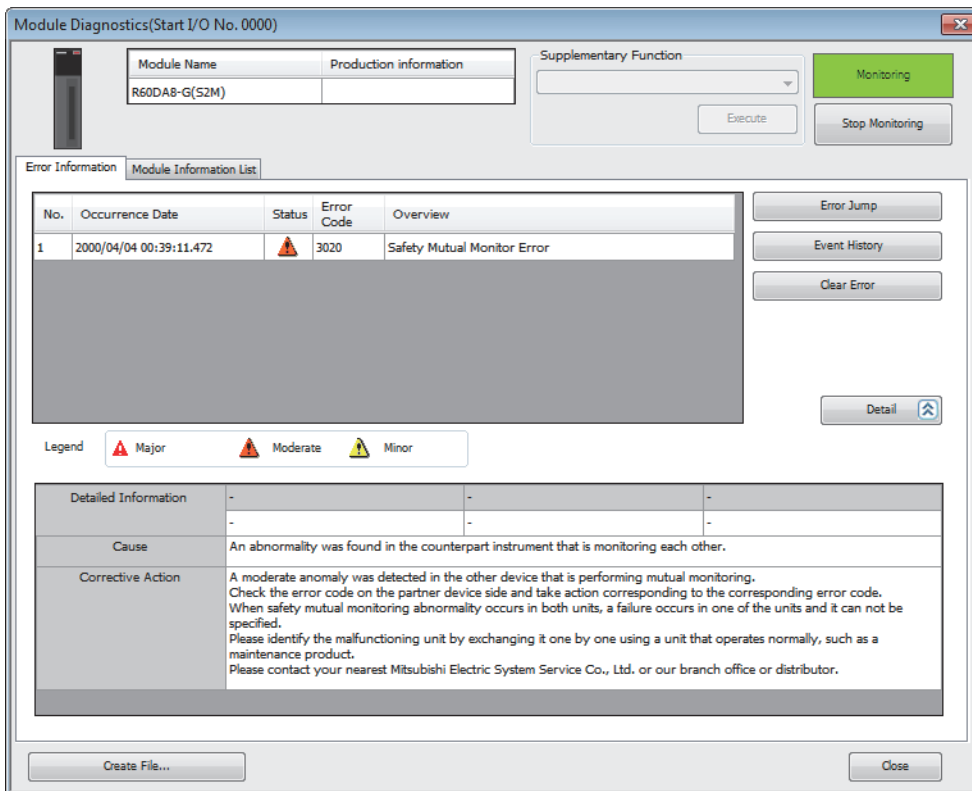

Item	Description
Status	Major: An error such as a hardware failure or memory failure. The module stops operating.
	Moderate: An error, such as a parameter error, which affects module operation. The module stops operating.
	Minor: An error such as a communication failure. The module continues operating.
Detailed Information	Displays detailed information about each error (maximum of 3 pieces).
Cause	Displays the details of the cause of each error.
Corrective Action	Displays actions against the error.

Module Information List

Switch to the "Module Information List" tab to display each status information of the R60DA8-G and RY40PT5B-AS.

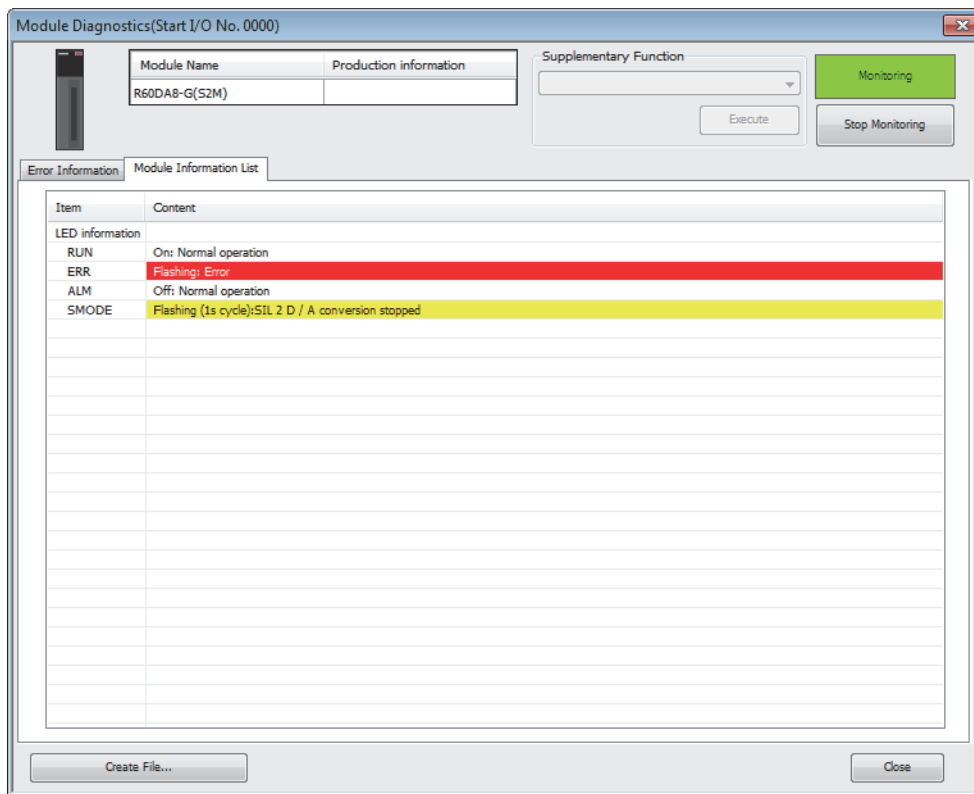

Item	Description
LED information	Displays the LED status of the R60DA8-G and RY40PT5B-AS.

14.3 Troubleshooting by Symptom

When the module does not start up

Check item	Action
Check that five seconds have passed since the power supply module is powered off.	After the power supply module is powered off, wait at least five seconds before turning on the input power supply to the power supply module.

When the RUN LED flashes (R60DA8-G only)

Check item	Action
Check whether the R60DA8-G is in standard mode and offset/gain setting mode.	Check the module configuration diagram of GX Works3. When the module configuration diagram of GX Works3 is "R60DA8-G", the R60DA8-G is operating in standard mode and in offset/gain setting mode. Change the R60DA8-G to the SIL2 mode module ("R60DA8-G (S2M)").



When the RUN LED is off

Check item	Action
Check whether the power is supplied.	Check that the supply voltage of the power supply module is within the rated range.
Check whether the capacity of the power supply module is enough.	Calculate the current consumption of the mounted modules, such as the remote head module, I/O modules, and intelligent function modules, to check that the power capacity is enough.
Check whether the modules are mounted properly.	Check the mounting state of each module.
Cases other than the above	Reset the remote head module and check that the RUN LED turns on. If the RUN LED still remains off, the possible cause is a failure of the module. Please consult your local Mitsubishi representative.

When the ERR LED flashes

Check item	Action
Check whether a moderate error has occurred.	Check the error code in the "Module Diagnostics" window and take the action described in the list of error codes.  Page 264 List of Error Codes

When the ERR LED turns on (R60DA8-G only)

Check item	Action
Check whether a minor error has occurred.	Check the error code in the "Module Diagnostics" window and take the action described in the list of error codes.  Page 264 List of Error Codes If an analog output read-back discrepancy detection error (error code: 1ED□H) or D/A conversion circuit diagnostic error (error code: 1EF□H) has occurred, take actions described as follows.  Page 252 When an analog output read-back discrepancy detection error occurs  Page 253 When a D/A conversion circuit diagnostic error occurs

When the S MODE LED flashes or turns off

When flashing (1s cycles)

Check item	Action
Check whether the remote head module is in the STOP state.	Check the RUN/STOP/RESET switch for the remote head module and if it is set to STOP, change it to RUN.
Check whether [Import Setting] was performed to the project written to the remote head module, by using "Safety Communication Setting" of the SIL2 Process CPU project.	Save the project that was written to the remote head module. In addition, follow the steps below again starting from "Safety communication setting". ☞ Page 171 Procedure on the SIL2 Process CPU side
Check whether the status is in "Safety station interlock status".	Monitor the 'Interlock status of each safety connection (1st module)' (SA\SD1232 to SA\SD1239) ^{*1} , and check the interlock status of the R60DA8-G. When the interlock status is in "Interlocked", use the 'Interlock release request for each safety connection (1st module)' (SA\SD1240 to SA\SD1247) ^{*1} corresponding to the R60DA8-G to clear the interlock status of the R60DA8-G. For details on the safety special register, refer to the following. 📖 MELSEC iQ-R CPU Module User's Manual (Application)
Check whether the R60DA8-G is in safety module disabled state.	Enable the safety module. If enabling the safety module fails, follow the steps below again starting from "Safety communication setting". ☞ Page 171 Procedure on the SIL2 Process CPU side
Check whether the wiring between the master station and the remote head module is correct.	Check the wiring between the master station and the remote head module.
Check whether momentary power failure occurred in the remote head module. (Check whether power failure (error code: 1000H) has occurred in the remote head module. (📖 MELSEC iQ-R CC-Link IE Field Network Remote Head Module User's Manual (Application)))	When a momentary power failure occurs in the remote head module, safety communications may stop if the value of "Transmission interval monitoring time" of the master station or the R60DA8-G is smaller than the value stated in the precautions regarding momentary power failure of the remote head module. Follow the procedure below as necessary. <ul style="list-style-type: none"> • Take measures against momentary power failure. (📖 MELSEC iQ-R Module Configuration Manual) • Check "Transmission interval monitoring time" of the R60DA8-G. (☞ Page 216 "Transmission interval monitoring time") • Check "Transmission interval monitoring time" of the master station. (📖 MELSEC iQ-R CC-Link IE Field Network User's Manual (Application)) For precautions regarding momentary power failure of the remote head module, refer to the following. 📖 MELSEC iQ-R CC-Link IE Field Network Remote Head Module User's Manual (Application)

*1 For details on the safety special register (2nd module or later), refer to the following.
📖 MELSEC iQ-R CPU Module User's Manual (Application)

Point

Changing the module parameter of the R60DA8-G and writing it to the remote head module causes a change in the safety parameter, and thus the R60DA8-G automatically shifts to the safety module disabled state. To set the R60DA8-G to the safety module enabled state again, it is required to perform [Import Setting] to the changed project of the remote head module by using "Safety Communication Setting" of the CPU module project, and then to enable the safety module.

When flashing (400ms cycles)

Check item	Action
Check whether the module position check has been executed.	With "Safety Module Operation" in the engineering tool, select the relevant module and click [S MODE LED Stop Flashing] button.

When turning off

Check item	Action
Check whether the R60DA8-G in the module configuration diagram is the SIL2 mode module.	In the module configuration diagram of GX Works3, check that the R60DA8-G is "R60DA8-G(S2M)".
Check whether the project was written to the remote head module.	If no project was written to the remote head module, follow the steps below again starting from "Writing to the remote head module". ☞ Page 170 Procedure on the remote head module side

When the ALM LED flashes (R60DA8-G only)

Check item	Action
Check whether the system was restarted after enabling or disabling the safety module.	Restart the system when the safety module is enabled or disabled.

When a module parameter error is displayed in the "Module Diagnostics" window

Check item	Action
Check whether the module configuration is correct.	Check that the module configuration diagram set in GX Works3 is correct. For details, refer to the following. ☞ Page 176 SYSTEM CONFIGURATION
Check whether a module incompatible with the SIL2 mode is used.	Check that modules whose firmware version and production information are compatible with the SIL2 mode are used. Incompatible modules do not operate normally in SIL2 mode. For details, refer to the following. ☞ Page 181 Firmware Version for SIL2 Mode





When an analog output read-back discrepancy detection error occurs

Check item	Action
Check whether the module parameters of the R60AD8-G for diagnostics are correct.	Check that the settings of the module parameters of the R60AD8-G for diagnostics are correct. For details, refer to the following. ☞ Page 192 Module parameters for "R60AD8-G"
Check whether there is any problem with analog signal lines for modules and relay, such as looseness or disconnection.	Identify the faulty area by a visual check and continuity check for analog signal lines and relay of the channel where an error occurred.
Check whether any measures have been taken to reduce noise.	To reduce noise, take measures such as the use of shielded cables for connection.
Check "Allowable range setting of analog output readback".	In GX Works3, set the setting of "Allowable range setting of analog output readback" to allow the customer's system error range including the effect of noise.
Check whether there is any incorrect wiring or incorrect connection.	Identify the faulty area by a continuity check for analog signal lines of the channel where an error occurred.
Check whether a relay has any failure.	Identify the faulty area by a continuity check for the relay of the channel where an error occurred.



If operation is not performed normally even after the actions described above are taken, the possible cause is a module failure. Please consult your local Mitsubishi representative.

When a D/A conversion circuit diagnostic error occurs

Check item	Action
Check whether the R60AD8-G for diagnostics is operating normally.	On the "Module Diagnostics" window, check the error code of the R60AD8-G for diagnostics. Refer to the following manual and take actions described in the list of error codes.  MELSEC iQ-R Channel Isolated Analog-Digital Converter Module User's Manual (Application)
Check whether the module parameters of the R60AD8-G for diagnostics are set correctly.	Check that the settings of the module parameters of the R60AD8-G for diagnostics are correct. For details, refer to the following.  Page 192 Module parameters for "R60AD8-G"
Check whether the RY40PT5B-AS is operating normally.	On the "Module Diagnostics" window, check the error code of the RY40PT5B-AS. Refer to the following and take the indicated actions.  Page 264 List of Error Codes
Check whether there is any problem with analog signal lines for modules and relay, such as looseness or disconnection.	Identify the faulty area by a visual check and continuity check for analog signal lines and relay of the channel where an error occurred.
Check whether there is any incorrect wiring or incorrect connection.	Identify the faulty area by a continuity check for analog signal lines of the channel where an error occurred.
Check whether a relay has any failure.	Identify the faulty area by a continuity check for the relay of the channel where an error occurred.
Check whether any measures have been taken to reduce noise.	To reduce noise, take measures such as the use of shielded cables for connection.
Check "Allowable range setting of analog output readback".	The allowable error range for D/A conversion circuit diagnostics is automatically set according to "Allowable range setting of analog output readback". If D/A conversion circuit diagnostic errors occur frequently, adjust the setting of "Allowable range setting of analog output readback" to allow the customer's system error range including the effect of noise. For details, refer to the following.  Page 223 D/A conversion circuit diagnostic function

Point 

If operation is not performed normally even after the actions described above are taken, the possible cause is a failure of a module in the module set. Please consult your local Mitsubishi representative.



When it takes time for the SIL2 analog output system to start up

Check item	Action
Check whether the start-up diagnostics is being executed.	<p>The start-up diagnostics is the function executed when a SIL2 analog output system starts up, and takes a maximum of SIL2 D/A conversion cycle (2000ms by default) × 40. To reduce the start-up diagnostic time, adjust "SIL2 D/A conversion cycle setting".</p> <p>To temporarily skip the start-up diagnostics when starting up the SIL2 analog output system, set the safety operation mode of the SIL2 Process CPU to TEST MODE.</p> <p>For details on the start-up diagnostics, refer to the following.</p> <p>☞ Page 223 D/A conversion circuit diagnostic function</p>

When the analog output value is OFF value (0V/0mA)

Check item	Action
Check whether the R60AD8-G for diagnostics is operating normally.	<p>On the "Module Diagnostics" window, check the error code of the R60AD8-G for diagnostics. Refer to the following manual and take actions described in the list of error codes.</p> <p>☞ MELSEC iQ-R Channel Isolated Analog-Digital Converter Module User's Manual (Application)</p>
Check whether the module parameters of the R60AD8-G for diagnostics are set correctly.	<p>Check that the settings of the module parameters of the R60AD8-G for diagnostics are correct. For details, refer to the following.</p> <p>☞ Page 192 Module parameters for "R60AD8-G"</p>
Check whether the RY40PT5B-AS is operating normally.	<p>On the "Module Diagnostics" window, check the error code of the RY40PT5B-AS. Refer to the following and take the indicated actions.</p> <p>☞ Page 264 List of Error Codes</p>
Check whether there is any problem with analog signal lines for modules and relay, such as looseness or disconnection.	<p>Identify the faulty area by a visual check and continuity check for analog signal lines and relay of the channel where an error occurred.</p>
Check whether there is any incorrect wiring or incorrect connection.	<p>Identify the faulty area by a continuity check for analog signal lines of the channel where an error occurred.</p>
Check whether a relay has any failure.	<p>Identify the faulty area by a continuity check for the relay of the channel where an error occurred.</p>
Check whether the PROGRAM RUN LED of the SIL2 Process CPU is on.	<p>If the PROGRAM RUN LED of the SIL2 Process CPU is not on, the SIL2 Process CPU may be in STOP state and the program may not be operating. Check the RUN/STOP/RESET switch for the SIL2 Process CPU and if it is set to STOP, change it to RUN.</p>
Check whether a digital value has been set to the safety device of the channel for which analog output is to be executed.	<p>If a digital value is set to a safety device different from the safety device assigned by the refresh device setting, analog output cannot be made correctly. Check the setting of the refresh device and correct the program so that the digital value is set to the safety device of the channel for which analog output is to be executed. (For the setting of the refresh device, refer to the user's manual of the CPU module used.)</p>
Check whether "D/A conversion enable/disable setting" of the channel for which analog output is to be executed is set to "D/A conversion disable".	<p>Set "D/A conversion enable/disable setting" of the channel to be used to "D/A conversion enable".</p>
Check whether Output enable request of the channel for which analog output is to be executed is set to OFF.	<p>Set the channel for analog output to ON (output is enabled) with <code>i_uOutputEnable</code> (output enable request) of SIL2 safety program FB.</p> <p>For details on SIL2 safety program FB, refer to the following.</p> <p>☞ Page 211 SIL2 diagnostic FB library</p>
Check whether the SIL2 diagnostic FB library in use is correct.	<p>Use a correct SIL2 diagnostic FB library. For details on the SIL2 diagnostic FB library used, refer to the following.</p> <p>☞ Page 211 SIL2 D/A Conversion Function</p>

When output cannot be performed to external output of the RY40PT5B-AS

Check item	Action
Check whether the S MODE LED is on.	Check that the S MODE LED is on. If the S MODE LED flashes or is not on, take the following actions.  Page 251 When the S MODE LED flashes or turns off
Check whether the corresponding output LED is on.	If the LED is on, there is a problem in the wiring between the external output terminal and the external output device. Check the wiring again for any disconnection or short-circuit.
Check whether the PROGRAM RUN LED of the SIL2 Process CPU is on.	If the PROGRAM RUN LED of the SIL2 Process CPU is not on, the SIL2 Process CPU may be in STOP state and the program may not be operating. Check the RUN/STOP/RESET switch for the SIL2 Process CPU and if it is set to STOP, change it to RUN.
Check whether the SIL2 diagnostic FB library in use is correct.	Use a correct SIL2 diagnostic FB library. For details on the SIL2 diagnostic FB library used, refer to the following.  Page 211 SIL2 D/A Conversion Function

When the R60DA8-G shuts down

Check item	Action
Check whether any measures have been taken to reduce noise.	To reduce noise, take measures such as the use of shielded cables for connection.

14

Point

If operation is not performed normally even after the actions described above are taken, the possible cause is a module failure. Please consult your local Mitsubishi representative.

14.4 Troubleshooting While Proceeding Procedures Before Operation

When the module parameter write to the remote head module fails

Refer to the following.

 MELSEC iQ-R CC-Link IE Field Network Remote Head Module User's Manual (Application)

Troubleshooting on the "Safety Communication Setting" window

When [Import Setting] cannot be performed to the project of the remote head module

Check item	Action
Check whether the module configuration of the remote head module project targeted for [Import Setting] operation is correct.	Review the module configuration of the remote head module project targeted for [Import Setting] operation.
Check whether the network number setting of the master/local module and the network number setting and station number setting of the remote head module are correct.	In the remote head module project for which [Import Setting] is executed, select "CPU Parameter" ⇒ "Network Required Setting" ⇒ "Network No." and set the same network number as the master/local module where [Import Setting] is executed.

Troubleshooting on the "Safety Module Operation" window

When the "Safety Module Operation" window cannot be opened

Check item	Action
Check whether "To Use or Not to Use the Safety Communication Setting" is set to "Use" in the project of the SIL2 Process CPU.	Check "To Use or Not to Use the Safety Communication Setting" in the project of the SIL2 Process CPU and if "Not Use" is set, change it to "Use". In addition, follow the steps below again starting from "Safety communication setting".  Page 170 Procedure on the remote head module side

When operation is performed when safety operation mode is other than TEST MODE

Check item	Action
Check whether the safety operation mode of the SIL2 Process CPU is SAFETY MODE.	When the safety operation mode of the SIL2 Process CPU is SAFETY MODE, the safety module enabling/disabling operation is not possible. The safety operation mode cannot be checked on the "Safety Module Operation" window. Select [Diagnostics] ⇒ [Module Diagnostics (CPU Diagnostics)] to check the safety operation mode. If the safety operation mode is set to SAFETY MODE, refer to the following and switch the safety operation mode of the SIL2 Process CPU to TEST MODE.  Page 200 Safety module operation

When "Verification Failed" is displayed for "Module Status"

Check the following items in order of No.

No.	Check item	Action
1	Check whether the project was written to the remote head module.	Follow the steps below again starting from "Writing to the remote head module". ☞ Page 170 Procedure on the remote head module side
2	Check whether the remote head module was reset after the write of the project to the remote head module.	The project is not valid unless the remote head module is reset after the write of the project to the remote head module. Follow the steps below again starting from "Resetting the remote head module". ☞ Page 170 Procedure on the remote head module side
3	Check whether [Import Setting] was performed to the project written to the remote head module, by using "Safety Communication Setting" of the SIL2 Process CPU project.	Save the project that was written to the remote head module. In addition, follow the steps below again starting from "Safety communication setting". ☞ Page 171 Procedure on the SIL2 Process CPU side
4	Check whether the module for which safety module is to be enabled is correct.	Press the [S MODE LED Start Flashing] button while selecting the module for which to enable the safety module on the "Safety Module Operation" window. Check that the S MODE LED for which safety module is to be enabled is flashing (400ms cycles).

Point

- The setting of module parameter of the R60DA8-G that was written to the project of the remote head module is not reflected unless the [Import Setting] operation targeted for the remote head module project is completed by using "Safety Communication Setting" of the SIL2 Process CPU project. Thus, if the safety module operation is performed after a module parameter of the R60DA8-G is changed in the project of the remote head module without subsequent operation of [Import Setting] again to the remote head module project, "Verification Failed" is displayed for "Module Status". When changing a module parameter of the R60DA8-G, perform the necessary operation again starting from the write of project to the remote head module.
- If operation is not performed normally even after the actions described above are taken, the possible cause is a module failure. Please consult your local Mitsubishi representative.

When "Timeout" is displayed for "Module Status"

Check the following items in order of No.

No.	Check item	Action
1	Check whether the LEDs of the R60DA8-G are in the following states. <ul style="list-style-type: none"> • The ERR LED is flashing. • The S MODE LED is flashing (1s cycles). 	A moderate error has occurred in the R60DA8-G. The safety module operation cannot be performed for the R60DA8-G with a moderate error. Check the error code in the "Module Diagnostics" window and take the action described in the list of error codes. ☞ Page 264 List of Error Codes
2	Check whether the safety module operation was performed with the personal computer connected to the SIL2 Process CPU in the standby system.	If the CPU redundant system with remote I/O modules is configured based on a redundant line, the safety module operation cannot be performed from the SIL2 Process CPU in the standby system. Perform the safety module operation again from the personal computer on which GX Works3 is open and to which the SIL2 Process CPU in the control system is connected.
3	Check whether the S MODE LED of the R60DA8-G is off.	The R60DA8-G is set to standard mode. Set the parameters for SIL2 mode by following the steps below again starting from "Setting parameters on the remote head module side". ☞ Page 170 Procedure on the remote head module side

Point

- If the safety module operation is performed while communications with the R60DA8-G are disabled, the time taken until "Timeout" is displayed for "Module Status" is set time in "Check at Communication Time" (second) × 3. (The default value for "Check at Communication Time" is 30 seconds.) For details on "Check at Communication Time", refer to the GX Works3 Operating Manual.
- If operation is not performed normally even after the actions described above are taken, the possible cause is a module failure. Please consult your local Mitsubishi representative.

When "Enabling Failed (Module Error)" is displayed for "Module Status"

Check item	Action
Perform the safety module operation again, and check whether "Enabling Failed (Module Error)" is still displayed for "Module Status".	If this phenomenon persists, the possible cause is a module failure. Please consult your local Mitsubishi representative.

Point

If operation is not performed normally even after the actions described above are taken, the possible cause is a module failure. Please consult your local Mitsubishi representative.

When "Enabling Failed (Data Error)" is displayed for "Module Status"

Check item	Action
Check whether measures have been properly taken against noise.	Since noise may be a factor, take measures to reduce noise. If measures to reduce noise do not eliminate this symptom, the possible cause is a module failure. Please consult your local Mitsubishi representative.

Point

If operation is not performed normally even after the actions described above are taken, the possible cause is a module failure. Please consult your local Mitsubishi representative.

When "—" is displayed for "Module Status"

Check the following items in order of No.

No.	Check item	Action
1	Check whether the R60DA8-G is mounted properly.	Visually check the "System Monitor" window of GX Works3 and the actual base unit and check whether the R60DA8-G is properly mounted.
2	Check whether there are no problems on connections from the personal computer where GX Works3 is installed to the remote head module.	Verify the connection path from the SIL2 Process CPU to the remote head module and remove any error factors if found.
3	Check whether there are no problems on the power supply of the remote head module.	Inspect again the power supply environment of the remote head module and remove any error factors if found.

Point



If operation is not performed normally even after the actions described above are taken, the possible cause is a module failure. Please consult your local Mitsubishi representative.

14.5 Troubleshooting SIL2 Diagnostic FB Library

When the SIL2 diagnostic FB library is not registered as a product option

Check item	Action
Check whether the SIL2 diagnostic FB library is registered to GX Works3.	Register the SIL2 diagnostic FB library to the library list of GX Works3. For the FB library, please consult your local Mitsubishi representative. For details on how to register FB libraries, refer to the GX Works3 Operating Manual.

When a program conversion error occurs in GX Works3

Check item	Action
Check whether the correct SIL2 safety program FB is used.	Check that the SIL2 safety program FB (M+SIL2DAG_DAConv_R) has been attached to the safety program. For details, refer to the following.  Page 198 Creating programs If it is not attached correctly, the SIL2 analog output system does not operate normally.
Check whether the correct SIL2 standard program FB is used.	Check that the SIL2 standard program FB (M+SIL2DAG-IEF_ReadADVal_R) has been attached to the standard program. For details, refer to the following.  Page 198 Creating programs If it is not attached correctly, the SIL2 analog output system does not operate normally.

When the execution status of the SIL2 diagnostic FB library is off

Check item	Action
Check whether the SIL2 Process CPU is in STOP state.	Change the state of the SIL2 Process CPU to the RUN state.
Check whether i_bEN (execution command) of the SIL2 safety program FB is turned on.	Turn on i_bEN (execution command) of the SIL2 safety program FB.
Check whether i_bEN (execution command) of the SIL2 standard program FB is turned on.	Turn on i_bEN (execution command) of the SIL2 standard program FB.

Checking by status code of the SIL2 safety program FB

For 0000H

Check item	Action
Check whether the SIL2 Process CPU is in STOP state.	Change the state of the SIL2 Process CPU to the RUN state.
Check whether i_bEN (execution command) of the SIL2 safety program FB is turned on.	Turn on i_bEN (execution command) of the SIL2 safety program FB.

For 8002H

Check item	Action
Check whether "D/A conversion enable/disable setting" of the R60DA8-G is set to "D/A conversion disable".	Set the "D/A conversion enable/disable setting" of the R60DA8-G to "D/A conversion enable".

For 8010H

Check item	Action
Check whether the channel for which analog output is to be executed has been set to OFF (output is disabled) with the i_uOutputEnable (output enable request) of SIL2 safety program FB.	In i_uOutputEnable (output enable request) of the SIL2 safety program FB, set ON (output is enabled) for channels where analog output is to be executed.

For C001H

Check item	Action
Check whether the setting values of standard/safety shared labels used in the SIL2 safety program FB and SIL2 standard program FB are correct.	Check that the standard/safety shared labels used in the SIL2 safety program FB and the SIL2 standard program FB match.
Check whether the module parameter "SIL2 D/A conversion cycle setting" of the R60DA8-G is correct.	Check that "SIL2 D/A conversion cycle setting" is within the setting range. Also check that the parameter satisfies the setting value calculation formula. For details, refer to the following.  Page 215 "SIL2 D/A conversion cycle setting"

Point

If an analog output read-back discrepancy detection error (error code: 1ED□H) occurs in the R60DA8-G, take actions described as follows.

 Page 252 When an analog output read-back discrepancy detection error occurs

For C002H

Check item	Action
Check whether the setting values of standard/safety shared labels used in the SIL2 safety program FB and SIL2 standard program FB are correct.	Check that the standard/safety shared labels used in the SIL2 safety program FB and the SIL2 standard program FB match.
Check whether the module parameter "SIL2 D/A conversion cycle setting" of the R60DA8-G is correct.	Check that "SIL2 D/A conversion cycle setting" is within the setting range. Also check that the parameter satisfies the setting value calculation formula. For details, refer to the following.  Page 215 "SIL2 D/A conversion cycle setting"
Check whether i_bEN (execution command) of the SIL2 standard program FB is turned on.	Turn on i_bEN (execution command) of the SIL2 standard program FB.

Point

If a D/A conversion circuit diagnostic error (error code: 1EF□H) occurs in the R60DA8-G, take actions described as follows.

 Page 253 When a D/A conversion circuit diagnostic error occurs



For C010H to C021H

Check item	Action
Check whether the module parameters of the R60DA8-G are correct.	Check that the module parameters of the R60DA8-G indicated by status code are set within the setting range and the setting values are correct.

For C030H

Check item	Action
Check whether the correct SIL2 safety program FB is used.	Check that the SIL2 safety program FB (M+SIL2DAG_DACnv_R) has been attached to the safety program. For details, refer to the following.  Page 198 Creating programs If it is not attached correctly, the SIL2 analog output system does not operate normally.

For C031H

Check item	Action
Check whether the setting values of i_u8DARcvTbl (safety communications receive area) and o_u8DASndTbl (safety communications send area) of SIL2 safety program FB are correct.	Check that the setting values of i_u8DARcvTbl (safety communications receive area) and o_u8DASndTbl (safety communications send area) of SIL2 safety program FB are the same as the values set in "Safety Communication Setting" of GX Works3.
Check whether the setting values of standard/safety shared labels used in the SIL2 safety program FB and SIL2 standard program FB are correct.	Check that the standard/safety shared labels used in the SIL2 safety program FB and the SIL2 standard program FB match.
Check whether the correct SIL2 safety program FB is used.	Check that the SIL2 safety program FB (M+SIL2DAG_DACnv_R) has been attached to the safety program. For details, refer to the following.  Page 198 Creating programs If it is not attached correctly, the SIL2 analog output system does not operate normally.
Check whether errors have occurred in any of the modules in the SIL2 analog output system.	Check for any errors in the modules in the SIL2 analog output system.
Check whether the network setting and safety communication setting of the master station, and the refresh setting of the master station and the remote station are correct.	Check that the network setting and safety communication setting of the master station, and the refresh setting of the master station and the remote station have been correctly set.
Check whether the R60DA8-G is in the safety module enabled state.	If the R60DA8-G is in the safety module disabled state, enable the safety module.
Check whether the module parameter "SIL2 D/A conversion cycle setting" of the R60DA8-G is correct.	Check that "SIL2 D/A conversion cycle setting" is within the setting range. Also check that the parameter satisfies the setting value calculation formula. For details, refer to the following.  Page 215 "SIL2 D/A conversion cycle setting"

For C040H to C043H

Check item	Action
Check whether the following input labels of the SIL2 standard program FB do not exceed the setting range. <ul style="list-style-type: none"> • i_uNetworkNo (target network number) • i_uChNo (own station channel) • i_uStationNo (target station number) • i_uloNo (target station start I/O number) 	Check that each input label of the SIL2 standard program FB has been set properly.

For C044H, C045H

Check item	Action
Check whether the target station specification for the following input labels of the SIL2 standard program FB are correct. <ul style="list-style-type: none"> • i_uNetworkNo (target network number) • i_uChNo (own station channel) • i_uStationNo (target station number) • i_uloNo (target station start I/O number) 	Check that each input label of the SIL2 standard program FB specifies the target station properly.
Check whether the R60AD8-G for diagnostics is operating normally.	Refer to the following manual and check that there is no errors in the R60AD8-G for diagnostics.  MELSEC iQ-R Channel Isolated Analog-Digital Converter Module User's Manual (Application)

For C046H

Check item	Action
Check whether the setting values of standard/safety shared labels used in the SIL2 safety program FB and SIL2 standard program FB are correct.	Check that the standard/safety shared labels used in the SIL2 safety program FB and the SIL2 standard program FB match.
Check whether i_bEN (execution command) of the SIL2 standard program FB is turned on.	Turn on i_bEN (execution command) of the SIL2 standard program FB.
Check whether the module parameter "SIL2 D/A conversion cycle setting" of the R60DA8-G is correct.	Check that "SIL2 D/A conversion cycle setting" is within the setting range. Also check that the parameter satisfies the setting value calculation formula. For details, refer to the following.  Page 215 "SIL2 D/A conversion cycle setting"
Check whether the target station specification for the following input labels of the SIL2 standard program FB are correct. <ul style="list-style-type: none">• i_uNetworkNo (target network number)• i_uChNo (own station channel)• i_uStationNo (target station number)• i_ulNo (target station start I/O number)	Check that each input label of the SIL2 standard program FB specifies the target station properly.

For *1**H

Check item	Action
Check whether i_bEN (execution command) of the SIL2 safety program FB is turned off.	Turn on i_bEN (execution command) of the SIL2 safety program FB.

Checking by error code of the SIL2 safety program FB

For 0201H

Check item	Action
Check whether the setting values of standard/safety shared labels used in the SIL2 safety program FB and SIL2 standard program FB are correct.	Check that the standard/safety shared labels used in the SIL2 safety program FB and the SIL2 standard program FB match.
Check whether the module parameters of the R60DA8-G are correct.	Check that the module parameters of the R60DA8-G are within the setting range and that the setting values are correct.
Check whether the connection with the external devices is correct.	In the SIL2 analog output system, check that each module is connected correctly. For details, refer to the following. ☞ Page 184 External Wiring
Check whether i_bEN (execution command) of the SIL2 standard program FB is turned on.	Turn on i_bEN (execution command) of the SIL2 standard program FB.

Checking by error code of the SIL2 standard program FB

For 0100H

Check item	Action
Check whether the following input labels of the SIL2 standard program FB do not exceed the setting range. <ul style="list-style-type: none"> • i_uNetworkNo (target network number) • i_uChNo (own station channel) • i_uStationNo (target station number) • i_uloNo (target station start I/O number) 	Check that each input label of the SIL2 standard program FB has been set properly.

For FFFFH

Check item	Action
Check whether the correct SIL2 safety program FB is used.	Check that the SIL2 safety program FB (M+SIL2DAG_DACnv_R) has been attached to the safety program. For details, refer to the following. ☞ Page 198 Creating programs If it is not attached correctly, the SIL2 analog output system does not operate normally.
Check whether the target station specification for the following input labels of the SIL2 standard program FB are correct. <ul style="list-style-type: none"> • i_uNetworkNo (target network number) • i_uChNo (own station channel) • i_uStationNo (target station number) • i_uloNo (target station start I/O number) 	Check that each input label of the SIL2 standard program FB specifies the target station properly.
Check whether the module parameter "SIL2 D/A conversion cycle setting" of the R60DA8-G is correct.	Check that "SIL2 D/A conversion cycle setting" is within the setting range. Also check that the parameter satisfies the setting value calculation formula. For details, refer to the following. ☞ Page 215 "SIL2 D/A conversion cycle setting"
Check whether the R60AD8-G for diagnostics is operating normally.	Refer to the following manual and check that there is no errors in the R60AD8-G for diagnostics. 📖 MELSEC iQ-R Channel Isolated Analog-Digital Converter Module User's Manual (Application)
Check whether the setting values of standard/safety shared labels used in the SIL2 safety program FB and SIL2 standard program FB are correct.	Check that the standard/safety shared labels used in the SIL2 safety program FB and the SIL2 standard program FB match.
Check whether i_bEN (execution command) of the SIL2 standard program FB is turned on.	Turn on i_bEN (execution command) of the SIL2 standard program FB.

14.6 List of Error Codes

R60DA8-G

If an error occurs while the R60DA8-G is running, the error code can be checked on the module diagnostics window of GX Works3.

Error codes of the R60DA8-G are classified in minor errors or moderate errors.

- Minor error: Error that occurs due to an incorrect parameter setting or SIL2 D/A conversion function (Number in the 1000s + H). Depending on the error type, a portion that stops operation differs.
- Moderate error: Hardware failure, self-diagnostics error, or error caused by module configuration error (Number in the 3000s + H). The analog output value of all the channels becomes the OFF value (equivalent to 0V/0mA), and the safety layer stops.

If an error occurs, review the connected devices, wiring, and voltage, and/or replace the connected external devices. If the error can be cleared after its cause has been eliminated, the error is cleared by turning on `i_bUnitErrClear` (module error clear) of SIL2 safety program FB. If a moderate error occurs, the module remains in safety stop state until the remote head module is reset or the power is turned off and on.

The following table lists error codes to be stored.

□ in error codes: This symbol indicates the number of the channel where an error has occurred. A numerical value of 0 to 7 is used to correspond to CH1 to CH8.

(CH1: 0, CH2: 1, CH3: 2, CH4: 3, CH5: 4, CH6: 5, CH7: 6, CH8: 7)

Error code	Error name	Error description and cause	Action
0000H	—	There is no error.	—
1081H	Number of safety module status switching exceeding limit error	The number of times of enabling/disabling the safety module has exceeded the guaranteed maximum number.	Any further executions of enabling/disabling the safety module may not be reflected correctly.
1100H	Transmission interval monitoring time range error	A value other than 30 to 3000 is set in "Transmission interval monitoring time".	Set "Transmission interval monitoring time" within the range from 30 to 3000. If this error occurs despite setting the value in the range of 30 to 3000, rewrite the module parameter. If the same error occurs again even after the parameter has been written again, the module may be in failure. Please consult your local Mitsubishi representative.
1110H	SIL2 D/A conversion cycle setting range error	A value other than 2000 to 20000 is set in "SIL2 D/A conversion cycle setting".	Set "SIL2 D/A conversion cycle setting" within the range from 2000 to 20000. If this error occurs despite setting the value in the range of 2000 to 20000, rewrite the module parameter. If the same error occurs again even after the parameter has been written again, the module may be in failure. Please consult your local Mitsubishi representative.
112□H	CH□ Analog output read-back error range setting range error	A value other than 8 to 80 is set in "CH□ Allowable range setting of analog output readback".	Set "CH□ Allowable range setting of analog output readback" within the range from 8 to 80. If this error occurs despite setting the value in the range of 8 to 80, rewrite the module parameter. If the same error occurs again even after the parameter has been written again, the module may be in failure. Please consult your local Mitsubishi representative.
1150H	D/A conversion circuit diagnostic cycle setting range error	A value other than 60 to 480 is set in "D/A converter circuit Diagnostic cycle setting".	Set "D/A converter circuit Diagnostic cycle setting" within the range from 60 to 480. If this error occurs despite setting the value in the range of 60 to 480, rewrite the module parameter. If the same error occurs again even after the parameter has been written again, the module may be in failure. Please consult your local Mitsubishi representative.
1500H	Safety I/O HOLD time exceeded error ¹	The duration of the safety I/O HOLD state exceeded the safety I/O HOLD time.	<ul style="list-style-type: none"> • Check that no error occurred on the switching of systems incorporating SIL2 Process CPUs. • Check whether an error occurred in communications with a SIL2 Process CPU.

Error code	Error name	Error description and cause	Action
190□H	Range setting range error	A value outside the range is set in CH□ Range setting.	A parameter error has occurred. If the same error occurs again even after the module parameter has been written again, the module may be in failure. Please consult your local Mitsubishi representative.
191□H	Digital value setting range error*1	A value outside the range is set for CH□ Digital value.	Set an appropriate value for CH□ Digital value.
1A0□H	Scaling enable/disable setting range error	A value other than 0 and 1 is set in CH□ Scaling enable/disable setting.	A parameter error has occurred. If the same error occurs again even after the module parameter has been written again, the module may be in failure. Please consult your local Mitsubishi representative.
1A1□H	Scaling setting range error	A value other than -32000 to 32000 is set in CH□ Scaling lower limit value or CH□ Scaling upper limit value.	A parameter error has occurred. If the same error occurs again even after the module parameter has been written again, the module may be in failure. Please consult your local Mitsubishi representative.
1A2□H	Scaling upper/lower limit value setting error	CH□ Scaling upper limit value and CH□ Scaling lower limit value are set as the scaling upper limit value = the scaling lower limit value.	Set CH□ Scaling upper limit value or CH□ Scaling lower limit value as the scaling upper limit value ≠ the scaling lower limit value.
1E51H	User range data invalid (CH identification disabled)	An invalid value is set in the offset/gain setting. The number of the channel in which this error occurs cannot be identified.	If this error occurs in the safety module enabled state, the safety module will be disabled. Perform the offset/gain setting again for all channels where the user range is set. If the error occurs again, the possible cause is a failure of the module. Please consult your local Mitsubishi representative.
1E6□H	User range data invalid (CH identification allowed)	An invalid value is set in CH□ Offset/gain setting.	If this error occurs on any channel in the safety module enabled state, the safety module will be disabled. Perform the offset/gain setting again for the channels where the error has occurred. If the error occurs again, the possible cause is a failure of the module. Please consult your local Mitsubishi representative.
1ED□H	Analog output read-back discrepancy detection error*1	The discrepancy between an analog output value and an analog output read-back value was detected.	Check on which channel the error occurred using the status code of the SIL2 diagnostic FB library, and review the connected devices and wiring. If the connected devices and wiring are correct, the error may have been caused by noise or module failure. If measures to reduce noise do not eliminate this error, the possible cause is module failure. Please consult your local Mitsubishi representative.
1EF□H	D/A conversion circuit diagnostic error	An error was detected with the D/A conversion circuit diagnostics.	This error may have been caused by noise or module failure. If measures to reduce noise do not eliminate this error, the possible cause is module failure. Please consult your local Mitsubishi representative.
3001H	Hardware failure	A hardware failure was detected in the module.	Turn off and on the power supply of the module. If the same error occurs again, the possible cause is module failure. Please consult your local Mitsubishi representative.
3010H	External power supply disconnection error	A disconnection of the external power supply was detected.	The external power supply 24VDC is not supplied, or blocked by the overcurrent protection circuit of the external power supply. In this state, normal operation of the SIL2 analog output system is not possible. Review and adjust connected devices, wiring, and voltage. If the same error occurs again after the review, the possible cause is module failure. Please consult your local Mitsubishi representative.

Error code	Error name	Error description and cause	Action
3020H	Safety mutual monitoring error	An error was detected in the counterpart device performing mutual monitoring.	A moderate error was detected in the counterpart device performing mutual monitoring. Check the error code on the counterpart device side, and take an action according to the error code. If a safety mutual monitoring error occurs in both modules, this indicates that either module is in failure but the failed module cannot be identified. Identify the module in failure by replacing each module one by one with a normally operating module, and consult your local Mitsubishi representative.
3050H	Safety parameter error	An error of safety parameter was detected at the startup of the system.	The possible cause is a failure of safety parameter write. Write the safety parameter to the module again with GX Works3. If the same error occurs again even after the parameter has been set again, the module may be in failure. Please consult your local Mitsubishi representative.
3060H	Module configuration error	An error was detected with the configuration check for operating the R60DA8-G in SIL2 mode.	Review the configuration so that it is suitable for operating the R60DA8-G in SIL2 mode. If the same error occurs again even after the module configuration review, the module may be in failure. Please consult your local Mitsubishi representative.

*1 The error can be cleared by i_bUnitErrClear (module error clear) of SIL2 safety program FB. If an error is displayed, change the module parameter and enable the safety module again.

RX40PT5B-AS

If an error occurs while the RX40PT5B-AS is running, the error code can be checked on the module diagnostics window of GX Works3.

Error codes of the RX40PT5B-AS are classified as moderate errors.

- Moderate error: Errors that occur due to a hardware failure, self-diagnostics error, and module configuration error (Number in the 2000s + H, 3000s + H). The entire module stops operation.

If an error occurs, review the connected devices, wiring, and voltage, and/or replace the connected external devices. If a moderate error occurs, the module remains in safety stop state until the remote head module is reset or the power is turned off and on.

The following table lists error codes to be stored.

Error code	Error name	Error description and cause	Action
0000H	—	There is no error.	—
2002H	Digital output read-back error	The discrepancy between a digital output read-back value and an output value was detected.	<ul style="list-style-type: none"> • Check for a terminal with the error using Digital output read-back error detection state (Un\G1536) of the RX40PT5B-AS, and review and adjust connected devices and wiring. (☞ Page 270 Digital output read-back error detection state). • If the same error occurs again, there may be an influence from noise or a hardware failure. Please consult your local Mitsubishi representative.
3001H	Hardware failure	A hardware failure was detected in the module.	Turn off and on the power supply of the module. If the same error occurs again, the possible cause is module failure. Please consult your local Mitsubishi representative.

Error code	Error name	Error description and cause	Action
3010H	External power supply disconnection error	A disconnection of the external power supply was detected.	The external power supply 24VDC is not supplied, or blocked by the overcurrent protection circuit of the external power supply. In this state, normal operation of the SIL2 analog output system is not possible. Review and adjust connected devices, wiring, and voltage. If the same error occurs again after the review, the possible cause is module failure. Please consult your local Mitsubishi representative.
3020H	Safety mutual monitoring error	An error was detected in the counterpart device performing mutual monitoring.	A moderate error was detected in the counterpart device performing mutual monitoring. Check the error code on the counterpart device side, and take an action according to the error code. If a safety mutual monitoring error occurs in both modules, this indicates that either module is in failure but the failed module cannot be identified. Identify the module in failure by replacing each module one by one with a normally operating module, and consult your local Mitsubishi representative.
3050H	Safety parameter error	An error of safety parameter was detected at the startup of the system.	The possible cause is a failure of safety parameter write. Write the safety parameter to the module again with GX Works3. If the same error occurs again even after the parameter has been set again, the module may be in failure. Please consult your local Mitsubishi representative.
3060H	Module configuration error	An error was detected with the configuration check for operating the R60DA8-G in SIL2 mode.	<ul style="list-style-type: none"> Review the configuration so that it is suitable for operating the R60DA8-G in SIL2 mode. The R60DA8-G not supporting SIL2 mode may have been mounted as a pair. Mount the R60DA8-G that supports SIL2 mode. If the same error occurs again even after the module configuration review, the module may be in failure. Please consult your local Mitsubishi representative.

APPENDICES (SIL2 MODE)

Appendix 9 I/O Signals

List of I/O signals (R60DA8-G)

The following tables list I/O signals for the R60DA8-G in SIL2 mode.

Point 

- The I/O signals (X/Y) described below show the case when the start I/O number of the R60DA8-G is set to "0".
- Do not use the "use prohibited" signals in the following tables since they are used by the system. If users use (turn on) the signals, the functions of the R60DA8-G cannot be guaranteed.

Input signal

Device number	Signal name
X0 to XF	Use prohibited

Output signal

Device number	Signal name
Y0 to YF	Use prohibited

List of I/O signals (RY40PT5B-AS)

The following tables list I/O signals for the RY40PT5B-AS.

Point 

- The I/O signals (X/Y) described below show the case when the start I/O number of the RY40PT5B-AS is set to "0".
- Do not use the "use prohibited" signals in the following tables since they are used by the system. If users use (turn on) the signals, the functions of the RY40PT5B-AS cannot be guaranteed.

Input signal

Device number	Signal name
X0 to X1F	Use prohibited

Output signal

Device number	Signal name
Y0 to Y1F	Use prohibited

Appendix 10 Buffer Memory

List of buffer memory areas (R60DA8-G)

The buffer memory list of the R60DA8-G is shown below. For details on the buffer memory area, refer to the following.

☞ Page 269 Details of buffer memory area (R60DA8-G)

The buffer memory areas of the R60DA8-G are intended only for monitor data (data used for referring to the status of the R60DA8-G). Reading data is only allowed. Writing data is not allowed.



Do not write data into buffer memory areas. Writing data into these areas can cause a module malfunction.

Address (decimal)	Address (hexadecimal)	Name	Default value
0 to 4202	0H to 106AH	System area	—
4203	106BH	Safety module validation status	0001H
4204 to 80999	106CH to 13C67H	System area	—

Details of buffer memory area (R60DA8-G)

This section describes the details of the buffer memory area of the R60DA8-G.

Safety module validation status

Whether the safety module function is enabled in SIL2 mode is stored. Whether the safety module function is enabled in the module set including the RY40PT5B-AS is stored in this area of the R60DA8-G.

Stored value	Description
0001H	Disabled state
0002H	Disabled state (reset waiting)
0003H	Enabled state
0004H	Enabled state (reset waiting)

For how to enable the safety module function, refer to the following.

☞ Page 200 Safety module operation

■ Buffer memory address

The following shows the buffer memory address of this area.

Buffer memory name	X/Y00 to X/Y0F
Safety module validation status	4203

List of buffer memory areas (RY40PT5B-AS)

The following table lists the buffer memory areas of the RY40PT5B-AS. For details on the buffer memory area, refer to the following.

☞ Page 270 Details of buffer memory area (RY40PT5B-AS)

The buffer memory areas of the RY40PT5B-AS are intended only for monitor data (data used for referring to the status of the RY40PT5B-AS). Reading data is only allowed. Writing data is not allowed.



Do not write data into buffer memory areas. Writing data into these areas can cause a module malfunction.

Address (decimal)	Address (hexadecimal)	Name	Default value
0 to 1535	0H to 5FFH	System area	—
1536	600H	Digital output read-back error detection state	0000H
1537 to 65535	601H to FFFFH	System area	—

Details of buffer memory area (RY40PT5B-AS)

This section describes the details of the buffer memory area of the RY40PT5B-AS.

Digital output read-back error detection state

A digital output read-back error detection state is stored in this area. This area turns on when a digital output read-back error occurs.

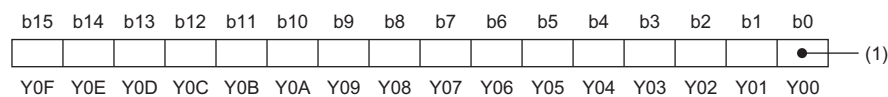

(1) 0: Normal, 1: Error

This area remains on until the power is turned off after a digital output read-back error occurred.

■ Buffer memory address

The following shows the buffer memory address of this area.

Buffer memory name	Y00 to Y0F
Digital output read-back error detection state	1536

Appendix 11 I/O Conversion Characteristics

I/O conversion characteristics of D/A conversion shows the slope of a line between the offset value and gain value when a digital value written from the CPU module is converted to an analog output value (voltage or current).

Offset value

An analog output value (voltage or current) when a digital value set from the CPU module is "0"

Gain value

An analog output value (voltage or current) when a digital value set from the CPU module is "32000"

Voltage output characteristics

The following are lists of analog output ranges for voltage output and graphs of each voltage output characteristics.

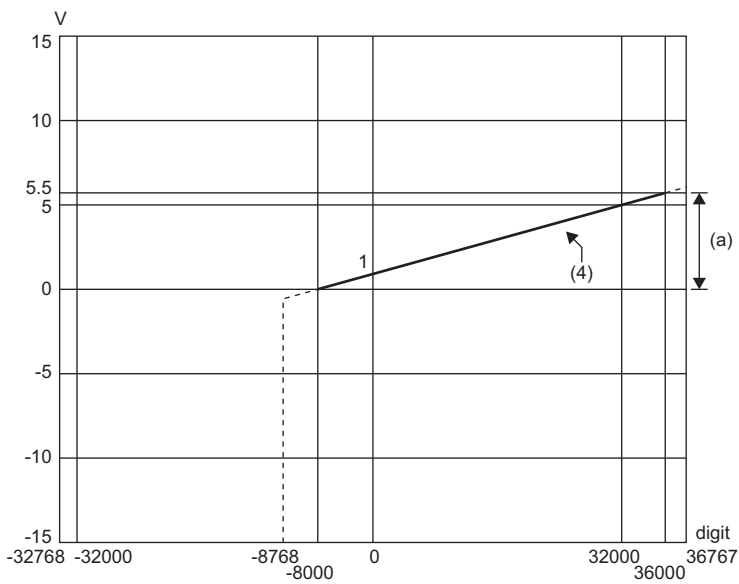
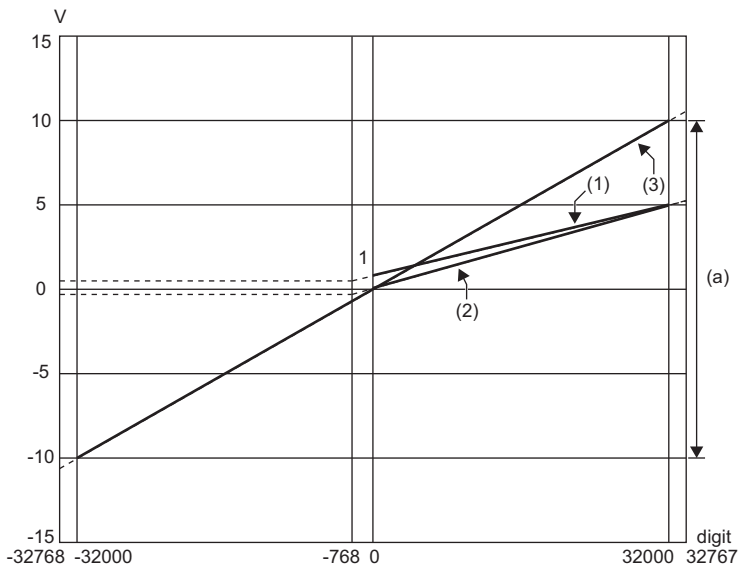

digit: Digital value

V: Analog output voltage (V)

(a): Practical analog output range

No.	Analog output range setting	Offset value	Gain value	Digital value ^{*4}	Resolution
(1)	1 to 5V	1V	5V	0 to 32000	125.0 μ V
(2)	0 to 5V	0V	5V		156.3 μ V
(3)	-10 to 10V	0V	10V	-32000 to 32000	312.5 μ V
(4)	1 to 5V (extended mode)	1V	5V	-8000 to 36000 ^{*1}	125.0 μ V
—	User range setting 3	^{*3}	^{*3}	-32000 to 32000	312.0 μ V ^{*2}

*1 Digital values can be set within the range of signed 16-bit range (-8768 to 32767). To output a voltage equivalent to a digital value at 32768 or larger, use the scaling function.

*2 A maximum resolution in the user range setting

*3 Set the user range setting 3 offset value and gain value in a range meeting the following conditions. If one of the following conditions is not met, D/A conversion may not be achieved correctly.

- Setting range of offset value and gain value: -10 to 10V
- $((\text{Gain value}) - (\text{Offset value})) \geq 4\text{V}$

*4 If the set data exceeds the range of digital value, the resulting output is an analog output value equivalent to the maximum or minimum of the digital value.

Analog output range setting	Digital value	
	Minimum	Maximum
1 to 5V	-768	32767
0 to 5V		
-10 to 10V	-32768	
1 to 5V (extended mode)	-8768	36767
User range setting 3	-32768	32767

Point 

- Use the output range within the practical digital input range and practical analog output range. If the value exceeds the ranges above, the resolution and accuracy may not meet the performance specifications. (Avoid using the range within the dotted lines on the voltage output characteristics graph.)

Current output characteristics

The following are lists of analog output ranges for current output and graphs of each current output characteristics.

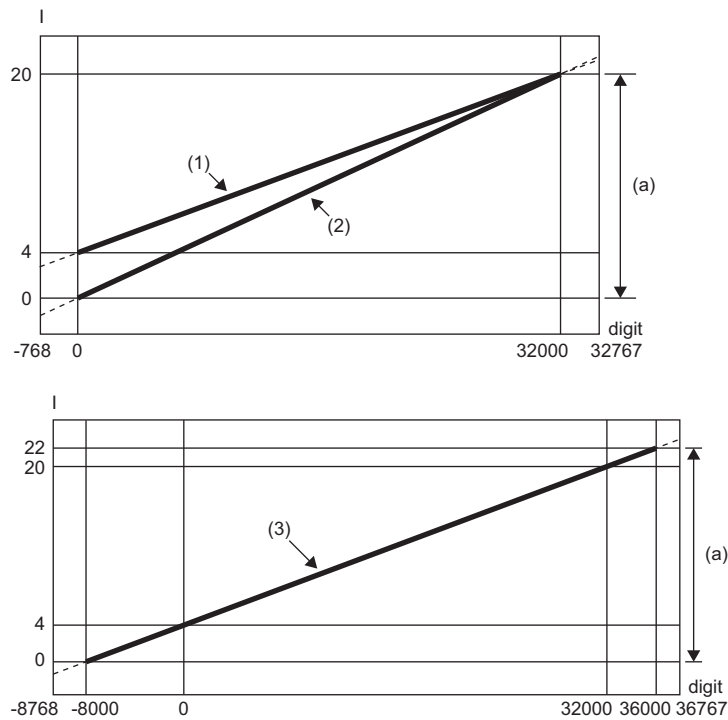

digit: Digital value

I: Analog output current (mA)

(a): Practical analog output range

No.	Analog output range setting	Offset value	Gain value	Digital value ^{*4}	Resolution
(1)	4 to 20mA	4mA	20mA	0 to 32000	500.0nA
(2)	0 to 20mA	0mA	20mA		625.0nA
(3)	4 to 20mA (extended mode)	4mA	20mA	-8000 to 36000 ^{*1}	500.0nA
—	User range setting 1	^{*2}	^{*2}	-32000 to 32000	360.1nA ^{*3}

*1 Digital values can be set within the range of signed 16-bit range (-8768 to 32767). To output a current equivalent to a digital value at 32768 or larger, use the scaling function.

*2 Set the user range setting 1 offset value and gain value in a range meeting the following conditions. If one of the following conditions is not met, D/A conversion may not be achieved correctly.

- Offset value ≥ 0 mA, Gain value ≤ 20 mA
- $((\text{Gain value}) - (\text{Offset value})) \geq 11.7$ mA

*3 A maximum resolution in the user range setting

*4 If the set data exceeds the range of digital value, the resulting output is an analog output value equivalent to the maximum or minimum of the digital value.

Analog output range setting	Digital value	
	Minimum	Maximum
4 to 20mA	-768	32767
0 to 20mA		
4 to 20mA (extended mode)	-8768	36767
User range setting 1	-32768	32767

Point

- Use the output range within the practical digital input range and practical analog output range. If the value exceeds the ranges above, the resolution and accuracy may not meet the performance specifications. (Avoid using the range within the dotted lines on the current output characteristics graph.)

Appendix 12 Accuracy

Accuracy of D/A conversion

The accuracy of D/A conversion is the accuracy of the maximum analog output value. The accuracy is calculated by the following calculation formula.

Accuracy = (Reference accuracy) + (Temperature coefficient) × (Change in temperature)

- Reference accuracy: Accuracy at ambient temperature during offset/gain setting ($\pm 0.1\%$ ($\pm 10\text{mV}$))
- Temperature coefficient: Accuracy per 1°C change in temperature ($0.005\%/^\circ\text{C}$)

Even if the output characteristics are changed by changing the offset/gain setting and the analog output range, the reference accuracy and temperature coefficient do not change and remain within the ranges stated in the performance specifications.

(However, this does not apply when the wiring is influenced by noise.)

Ex.

Accuracy when the temperature changes from 25°C to 30°C , thus a 5°C change
($\pm 0.1\%$) + ($\pm 0.005\%/^\circ\text{C} \times 5^\circ\text{C}$) = 0.125% ($\pm 12.5\text{mV}$)

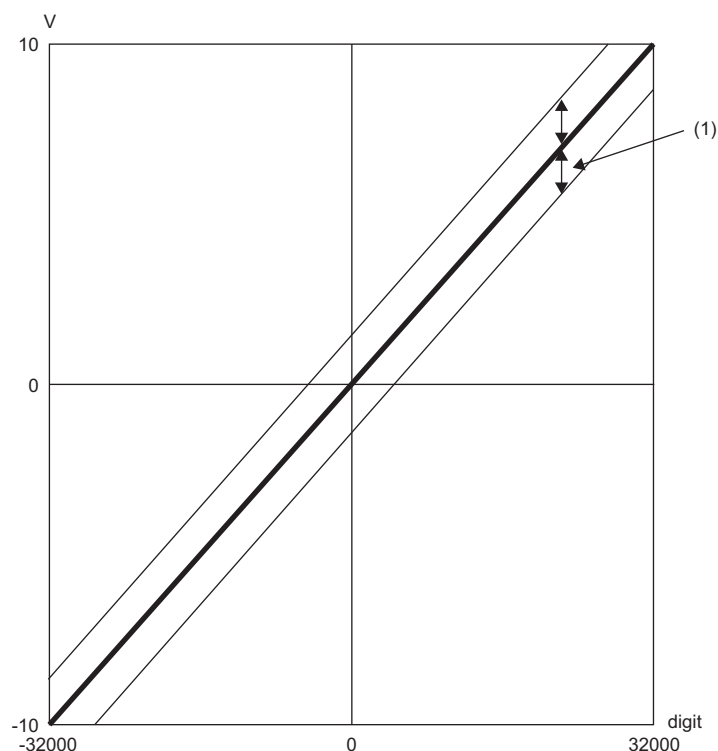

digit: Digital value

V: Analog output value (V)

(1): Fluctuation range

Accuracy in SIL2 analog output system

When using the R60DA8-G in SIL2 mode, create the system using the R60DA8-G in combination with the R60AD8-G for diagnostics. The analog output value of the D/A conversion by the R60DA8-G is input to the R60AD8-G for diagnostics, and the digital output value of the A/D conversion by the R60AD8-G for diagnostics is compared with the digital value input to the R60DA8-G and judgment is performed. The allowable error in this judgment is the accuracy in the SIL2 analog output system. An allowable error in judgment can be set in the range of 0.8 to 8% in "Allowable range setting of analog output readback" of "Application setting". (Page 221 Analog output read-back function)

Appendix 13 Calculation Method of Safety Response Time (Maximum Value)

The safety response time is the maximum time taken from when the safety input of the RX40NC6B set in SIL2 mode (intelligent device station (safety station)) turns off until the safety analog output of the R60DA8-G set in SIL2 mode (intelligent device station (safety station)) becomes a determined analog value. The time includes an error detection time.

This maximum time is calculated by the following formula.

Intelligent device station (safety station) on the input side → Master station (safety station) → Intelligent device station (safety station) on the output side

$$(S2cycda \times 43) + (SCmst \times 1) + (S2cycin \times 2) + RMin + RMholdin + (nin \times 2) + SRin$$

Symbol	Description
S2cycda	SIL2 D/A conversion cycle
SCmst	Safety cycle time of master station (safety station) ^{*1}
S2cycin	Control cycle time of the input side (RX40NC6B set in SIL2 mode) ^{*2}
RMin	Safety refresh monitoring time for the input connection of the master station (safety station) ^{*3}
RMholdin	Safety I/O HOLD time of the master station (safety station) ^{*5}
SRin	Safety input response time of the RX40NC6B set in SIL2 mode ^{*2}
nin	$RMin - (TMmstin \div 2) - TMrmtin + c$
c	$TMrmtin - d$ (This value is effective only if a station set to Passive is the RJ71GF11-T2, or if a station set to Passive is the RJ72GF15-T2 that is connected with the RX40NC6B in SIL2 mode and the R60DA8-G in SIL2 mode. In other cases, the value is 0.)
d	The calculation result of $TMrmtin \div 2$, which is rounded up to a multiple of the safety cycle time (control cycle time of the RX40NC6B set in SIL2 mode) ^{*4}
TMmstin	Transmission interval monitoring time for the input connection of the master station (safety station) ^{*3}
TMrmtin	Transmission interval monitoring time of the input side (RX40NC6B set in SIL2 mode) ^{*2}

*1 For Safety cycle time, refer to the following.

 MELSEC iQ-R CPU Module User's Manual (Application)

*2 For details, refer to the following.

 MELSEC iQ-R I/O Module (With Diagnostic Functions) User's Manual (Application)

*3 For details, refer to the following.

 MELSEC iQ-R CC-Link IE Field Network User's Manual (Application)

*4 Calculation example of d:

When Transmission interval monitoring time is 24ms and Safety cycle time is 10ms, the calculation formula is $24 \div 2 = 12$, and the result is rounded up to 20, a multiple of 10.

*5 For Safety I/O HOLD time, refer to the following.

 MELSEC iQ-R CPU Module User's Manual (Application)

Appendix 14 Added or Modified Function

This section describes the function added to or modified for the R60DA8-G.

Addition/modification	Firmware version	Reference
SIL2 mode	"03" or later	Page 158 OVERVIEW

Appendix 15 External Dimensions

R60DA8-G

The following figure shows the external dimensions of the R60DA8-G.

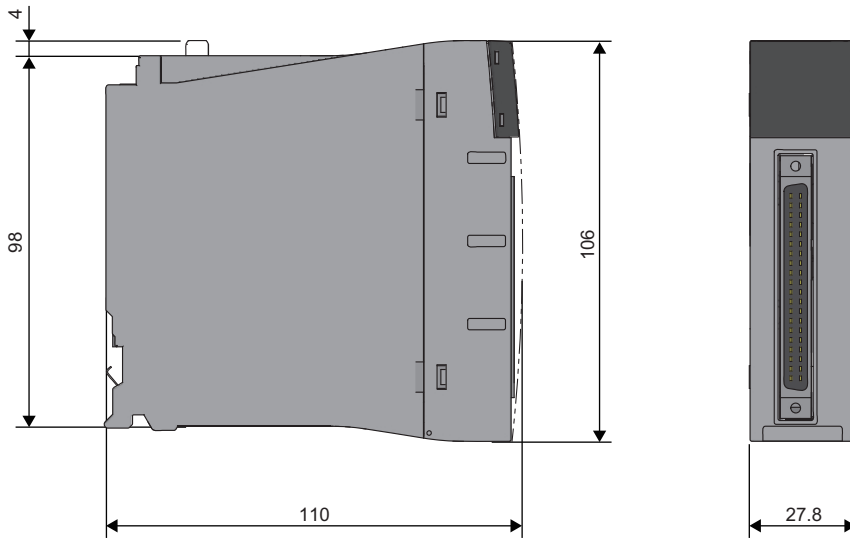

(Unit: mm)

RY40PT5B-AS

The following figure shows the external dimensions of the RY40PT5B-AS.

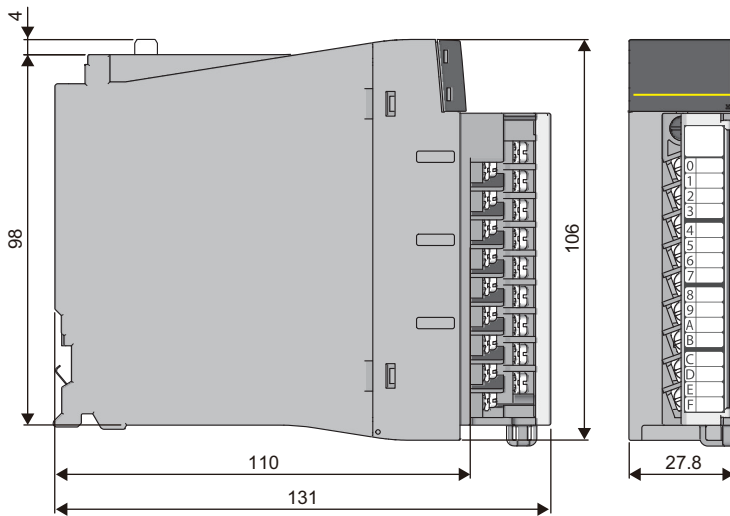

(Unit: mm)

MEMO

A

INDEX

A

Alarm history	133
Alert output clear request	88
Alert output function	32
Alert output lower limit flag	106
Alert output signal	84
Alert output upper limit flag	105
ALM LED	161,162
Analog output HOLD/CLEAR function	25
Analog output read-back function	221
Analog output test function when the CPU module is in STOP status	26
Analog switching module	181
Application setting	62
Application settings	237

B

Backing up, saving, and restoring offset/gain values	52
Basic setting	61
Basic settings	236

C

CH1 Alert output lower limit value	124
CH1 Alert output setting	121
CH1 Alert output upper limit value	123
CH1 D/A conversion enable/disable setting	116
CH1 Decrease digital limit value	126
CH1 Digital value	115
CH1 Disconnection detection (extended mode) enable/disable setting	128
CH1 Disconnection detection enable/disable setting	127
CH1 Factory default setting	135
CH1 HOLD/CLEAR function setting monitor	114
CH1 Increase digital limit value	125
CH1 Input value shift amount	116
CH1 Offset/gain setting mode	137
CH1 Offset/gain setting mode (range specification)	139
CH1 Output enable/disable flag	86
CH1 Range setting	131
CH1 Range setting monitor	113
CH1 Rate control enable/disable setting	122
CH1 Scaling enable/disable setting	118
CH1 Scaling lower limit value	120
CH1 Scaling upper limit value	119
CH1 Set value check code	112
CH1 User range setting	135
Channel change completed flag	83
Channel change request	87
Command area for module invalidation	141
Condition target channel setting	111
Condition target setting	110
Connector for external devices	161
Connector/terminal block converter module	181
Current output characteristics	274

D

D/A conversion circuit diagnostic function	223
D/A conversion enable/disable setting function	24,207
D/A output enable/disable setting function	24,207
Digital output read-back error detection state	270
Digital output read-back function	231
Disconnection detection flag	107
Disconnection detection function	38
Disconnection detection signal	84

E

ERR LED	161,162
Error clear request	88
Error flag	85
Error history	132
Error history function	48,233
Event history function	51,234
External power supply disconnection detection function	37
External power supply READY flag	80
External wiring	184

G

Gain value	271
----------------------	-----

I

Interrupt factor generation setting	109
Interrupt factor mask	108
Interrupt factor reset request	108
Interrupt function	45
Interrupt setting	63

L

Latest address of alarm history	105
Latest address of error history	104
Latest alarm code	104
Latest error code	104

M

Mode switching setting	112
Module label	75
Module power supply overcurrent protection	232
Module power supply overvoltage protection	232
Module READY	79
Module set	158

N

Normal mode	21
-----------------------	----

O

Offset value	271
Offset/gain adjustment value specification	136
Offset/gain setting mode status flag	82

Operating condition setting completed flag	81
Operating condition setting request	86
Output HOLD function	229
Output status indicator LED	162
Overheat protection	232
Overload protection	232

P

Parameter setting	61
Production information marking	161
Protection function	232

Q

Q Compatible mode function	60
--------------------------------------	----

R

Range reference table	58
Range switching function	23,206
Rate control function	34
Refresh setting	64
Refresh settings	238
Relay diagnostic function	228
RUN LED	161,162

S

S MODE LED	161,162
Safety module validation status	269
Save data type setting 1	134
Save data type setting 2	134
Scaling function	27,208
Self-diagnostic function	230
Set value change completed flag	83
Shift function	30
SIL2 analog output system	158
SIL2 D/A conversion function	211
SIL2 diagnostic FB library	159
Special cable	181

T

Terminal module	181
---------------------------	-----

U

User range write request	87
------------------------------------	----

V

Validation status area	141
Value change request	87
Voltage output characteristics	272



REVISIONS

*The manual number is given on the bottom left of the back cover.

Revision date	*Manual number	Description
January 2015	SH(NA)-081491ENG-A	First edition
May 2016	SH(NA)-081491ENG-B	■Added or modified parts TERMS, Chapter 1, Section 1.5, Section 1.6, Section 1.10, Section 2.2, Section 2.4, Section 3.3, Appendix 5
June 2018	SH(NA)-081491ENG-C	■Added or modified parts SAFETY PRECAUTIONS, INTRODUCTION, TERMS, Section 1.2, 1.16, 3.1, 3.3, 3.4, Appendix 3, 4, 6, 7, PART 2
December 2018	SH(NA)-081491ENG-D	■Added or modified parts PART 2
April 2019	SH(NA)-081491ENG-E	■Added or modified parts Section 1.12, 2.2, Appendix 2.2, 3.1, 3.2, 7
August 2020	SH(NA)-081491ENG-F	■Added or modified part Section 6.1
October 2020	SH(NA)-081491ENG-G	■Added or modified parts SAFETY PRECAUTIONS, CONDITIONS OF USE FOR THE PRODUCT, RELEVANT MANUALS, TERMS, GENERIC TERMS AND ABBREVIATIONS, Chapter 12, Appendix 7
November 2022	SH(NA)-081491ENG-H	■Added or modified parts CONDITIONS OF USE FOR THE PRODUCT, INTRODUCTION, Chapter 4, WARRANTY
June 2024	SH(NA)-081491ENG-I	■Added or modified parts SAFETY PRECAUTIONS, RELEVANT MANUALS, Chapter 9, Appendix 1, 3

Japanese manual number: SH-081490-I

This manual confers no industrial property rights or any rights of any other kind, nor does it confer any patent licenses. Mitsubishi Electric Corporation cannot be held responsible for any problems involving industrial property rights which may occur as a result of using the contents noted in this manual.

© 2015 MITSUBISHI ELECTRIC CORPORATION

WARRANTY

Please confirm the following product warranty details before using this product.

1. Gratis Warranty Term and Gratis Warranty Range

If any faults or defects (hereinafter "Failure") found to be the responsibility of Mitsubishi occurs during use of the product within the gratis warranty term, the product shall be repaired at no cost via the sales representative or Mitsubishi Service Company.

However, if repairs are required onsite at domestic or overseas location, expenses to send an engineer will be solely at the customer's discretion. Mitsubishi shall not be held responsible for any re-commissioning, maintenance, or testing on-site that involves replacement of the failed module.

[Gratis Warranty Term]

The gratis warranty term of the product shall be for one year after the date of purchase or delivery to a designated place. Note that after manufacture and shipment from Mitsubishi, the maximum distribution period shall be six (6) months, and the longest gratis warranty term after manufacturing shall be eighteen (18) months. The gratis warranty term of repair parts shall not exceed the gratis warranty term before repairs.

[Gratis Warranty Range]

- (1) The range shall be limited to normal use within the usage state, usage methods and usage environment, etc., which follow the conditions and precautions, etc., given in the instruction manual, user's manual and caution labels on the product.
- (2) Even within the gratis warranty term, repairs shall be charged for in the following cases.
 1. Failure occurring from inappropriate storage or handling, carelessness or negligence by the user. Failure caused by the user's hardware or software design.
 2. Failure caused by unapproved modifications, etc., to the product by the user.
 3. When the Mitsubishi product is assembled into a user's device, Failure that could have been avoided if functions or structures, judged as necessary in the legal safety measures the user's device is subject to or as necessary by industry standards, had been provided.
 4. Failure that could have been avoided if consumable parts (battery, backlight, fuse, etc.) designated in the instruction manual had been correctly serviced or replaced.
 5. Failure caused by external irresistible forces such as fires or abnormal voltages, and Failure caused by force majeure such as earthquakes, lightning, wind and water damage.
 6. Failure caused by reasons unpredictable by scientific technology standards at time of shipment from Mitsubishi.
 7. Any other failure found not to be the responsibility of Mitsubishi or that admitted not to be so by the user.

2. Onerous repair term after discontinuation of production

- (1) Mitsubishi shall accept onerous product repairs for seven (7) years after production of the product is discontinued. Discontinuation of production shall be notified with Mitsubishi Technical Bulletins, etc.
- (2) Product supply (including repair parts) is not available after production is discontinued.

3. Overseas service

Overseas, repairs shall be accepted by Mitsubishi's local overseas FA Center. Note that the repair conditions at each FA Center may differ.

4. Exclusion of loss in opportunity and secondary loss from warranty liability

Regardless of the gratis warranty term, Mitsubishi shall not be liable for compensation to:

- (1) Damages caused by any cause found not to be the responsibility of Mitsubishi.
- (2) Loss in opportunity, lost profits incurred to the user by Failures of Mitsubishi products.
- (3) Special damages and secondary damages whether foreseeable or not, compensation for accidents, and compensation for damages to products other than Mitsubishi products.
- (4) Replacement by the user, maintenance of on-site equipment, start-up test run and other tasks.

5. Changes in product specifications

The specifications given in the catalogs, manuals or technical documents are subject to change without prior notice.

· For the R60DA8-G (when SIL2 mode is set) and the RY40PT5B-AS

Please confirm the following product warranty details before using this product.

1. Limited Warranty and Product Support.

- a. Mitsubishi Electric Company ("MELCO") warrants that for a period of eighteen (18) months after date of delivery from the point of manufacture or one year from date of Customer's purchase, whichever is less, Mitsubishi programmable logic controllers (the "Products") will be free from defects in material and workmanship.
- b. At MELCO's option, for those Products MELCO determines are not as warranted, MELCO shall either repair or replace them or issue a credit or return the purchase price paid for them.
- c. For this warranty to apply:
 - (1) Customer shall give MELCO (i) notice of a warranty claim to MELCO and the authorized dealer or distributor from whom the Products were purchased, (ii) the notice shall describe in reasonable details the warranty problem, (iii) the notice shall be provided promptly and in no event later than thirty (30) days after the Customer knows or has reason to believe that Products are not as warranted, and (iv) in any event, the notice must be given within the warranty period;
 - (2) Customer shall cooperate with MELCO and MELCO's representatives in MELCO's investigation of the warranty claim, including preserving evidence of the claim and its causes, meaningfully responding to MELCO's questions and investigation of the problem, grant MELCO access to witnesses, personnel, documents, physical evidence and records concerning the warranty problem, and allow MELCO to examine and test the Products in question offsite or at the premises where they are installed or used; and
 - (3) If MELCO requests, Customer shall remove Products it claims are defective and ship them to MELCO or MELCO's authorized representative for examination and, if found defective, for repair or replacement. The costs of removal, shipment to and from MELCO's designated examination point, and reinstallation of repaired or replaced Products shall be at Customer's expense.
 - (4) If Customer requests and MELCO agrees to effect repairs onsite at any domestic or overseas location, the Customer will pay for the costs of sending repair personnel and shipping parts. MELCO is not responsible for any re-commissioning, maintenance, or testing on-site that involves repairs or replacing of the Products.
- d. Repairs of Products located outside of Japan are accepted by MELCO's local authorized service facility centers ("FA Centers"). Terms and conditions on which each FA Center offers repair services for Products that are out of warranty or not covered by MELCO's limited warranty may vary.
- e. Subject to availability of spare parts, MELCO will offer Product repair services for (7) years after each Product model or line is discontinued, at MELCO's or its FA Centers' rates and charges and standard terms in effect at the time of repair. MELCO usually produces and retains sufficient spare parts for repairs of its Products for a period of seven (7) years after production is discontinued.
- f. MELCO generally announces discontinuation of Products through MELCO's Technical Bulletins. Products discontinued and repair parts for them may not be available after their production is discontinued.

2. Limits of Warranties.

- a. MELCO does not warrant or guarantee the design, specify, manufacture, construction or installation of the materials, construction criteria, functionality, use, properties or other characteristics of the equipment, systems, or production lines into which the Products may be incorporated, including any safety, fail-safe and shut down systems using the Products.
- b. MELCO is not responsible for determining the suitability of the Products for their intended purpose and use, including determining if the Products provide appropriate safety margins and redundancies for the applications, equipment or systems into which they are incorporated.
- c. Customer acknowledges that qualified and experienced personnel are required to determine the suitability, application, design, construction and proper installation and integration of the Products. MELCO does not supply such personnel.
- d. MELCO is not responsible for designing and conducting tests to determine that the Product functions appropriately and meets application standards and requirements as installed or incorporated into the end-user's equipment, production lines or systems.
- e. MELCO does not warrant any Product:
 - (1) repaired or altered by persons other than MELCO or its authorized engineers or FA Centers;
 - (2) subjected to negligence, carelessness, accident, misuse, or damage;
 - (3) improperly stored, handled, installed or maintained;
 - (4) integrated or used in connection with improperly designed, incompatible or defective hardware or software;
 - (5) that fails because consumable parts such as batteries, backlights, or fuses were not tested, serviced or replaced;
 - (6) operated or used with equipment, production lines or systems that do not meet applicable and commensurate legal, safety and industry-accepted standards;
 - (7) operated or used in abnormal applications;
 - (8) installed, operated or used in contravention of instructions, precautions or warnings contained in MELCO's user, instruction and/or safety manuals, technical bulletins and guidelines for the Products;
 - (9) used with obsolete technologies or technologies not fully tested and widely accepted and in use at the time of the Product's manufacture;
 - (10) subjected to excessive heat or moisture, abnormal voltages, shock, excessive vibration, physical damage or other improper environment; or
 - (11) damaged or malfunctioning due to Acts of God, fires, acts of vandals, criminals or terrorists, communication or power failures, or any other cause or failure that results from circumstances beyond MELCO's control.
- f. All Product information and specifications contained on MELCO's website and in catalogs, manuals, or technical information materials provided by MELCO are subject to change without prior notice.

- g. The Product information and statements contained on MELCO's website and in catalogs, manuals, technical bulletins or other materials provided by MELCO are provided as a guide for Customer's use. They do not constitute warranties and are not incorporated in the contract of sale for the Products.
- h. These terms and conditions constitute the entire agreement between Customer and MELCO with respect to warranties, remedies and damages and supersede any other understandings, whether written or oral, between the parties. Customer expressly acknowledges that any representations or statements made by MELCO or others concerning the Products outside these terms are not part of the basis of the bargain between the parties and are not factored into the pricing of the Products.
- i. THE WARRANTIES AND REMEDIES SET FORTH IN THESE TERMS ARE THE EXCLUSIVE AND ONLY WARRANTIES AND REMEDIES THAT APPLY TO THE PRODUCTS.
- j. MELCO DISCLAIMS THE IMPLIED WARRANTIES OF MERCHANTABILITY AND FITNESS FOR A PARTICULAR PURPOSE.

3. Limits on Damages.

- a. MELCO'S MAXIMUM CUMULATIVE LIABILITY BASED ON ANY CLAIMS FOR BREACH OF WARRANTY OR CONTRACT, NEGLIGENCE, STRICT TORT LIABILITY OR OTHER THEORIES OF RECOVERY REGARDING THE SALE, REPAIR, REPLACEMENT, DELIVERY, PERFORMANCE, CONDITION, SUITABILITY, COMPLIANCE, OR OTHER ASPECTS OF THE PRODUCTS OR THEIR SALE, INSTALLATION OR USE SHALL BE LIMITED TO THE PRICE PAID FOR PRODUCTS NOT AS WARRANTED.
- b. Although MELCO has declared Product's compliance with the international safety standards IEC61508, IEC61511, this fact does not guarantee that Product will be free from any malfunction or failure. The user of this Product shall comply with any and all applicable safety standard, regulation or law and take appropriate safety measures for the system in which the Product is installed or used and shall take the second or third safety measures other than the Product. MELCO is not liable for damages that could have been prevented by compliance with any applicable safety standard, regulation or law.
- c. MELCO prohibits the use of Products with or in any application involving power plants, trains, railway systems, airplanes, airline operations, other transportation systems, amusement equipments, hospitals, medical care, dialysis and life support facilities or equipment, incineration and fuel devices, handling of nuclear or hazardous materials or chemicals, mining and drilling, and other applications where the level of risk to human life, health or property are elevated.
- d. MELCO SHALL NOT BE LIABLE FOR SPECIAL, INCIDENTAL, CONSEQUENTIAL, INDIRECT OR PUNITIVE DAMAGES, FOR LOSS OF PROFITS, SALES, OR REVENUE, FOR INCREASED LABOR OR OVERHEAD COSTS, FOR DOWNTIME OR LOSS OF PRODUCTION, FOR COST OVERRUNS, OR FOR ENVIRONMENTAL OR POLLUTION DAMAGES OR CLEAN-UP COSTS, WHETHER THE LOSS IS BASED ON CLAIMS FOR BREACH OF CONTRACT OR WARRANTY, VIOLATION OF STATUTE, NEGLIGENCE OR OTHER TORT, STRICT LIABILITY OR OTHERWISE.
- e. In the event that any damages which are asserted against MELCO arising out of or relating to the Products or defects in them, consist of personal injury, wrongful death and/or physical property damages as well as damages of a pecuniary nature, the disclaimers and limitations contained in these terms shall apply to all three types of damages to the fullest extent permitted by law. If, however, the personal injury, wrongful death and/or physical property damages cannot be disclaimed or limited by law or public policy to the extent provided by these terms, then in any such event the disclaimer of and limitations on pecuniary or economic consequential and incidental damages shall nevertheless be enforceable to the fullest extent allowed by law.
- f. In no event shall any cause of action arising out of breach of warranty or otherwise concerning the Products be brought by Customer more than one year after the cause of action accrues.
- g. Each of the limitations on remedies and damages set forth in these terms is separate and independently enforceable, notwithstanding the unenforceability or failure of essential purpose of any warranty, undertaking, damage limitation, other provision of these terms or other terms comprising the contract of sale between Customer and MELCO.

4. Delivery/Force Majeure.

- a. Any delivery date for the Products acknowledged by MELCO is an estimated and not a promised date. MELCO will make all reasonable efforts to meet the delivery schedule set forth in Customer's order or the purchase contract but shall not be liable for failure to do so.
- b. Products stored at the request of Customer or because Customer refuses or delays shipment shall be at the risk and expense of Customer.
- c. MELCO shall not be liable for any damage to or loss of the Products or any delay in or failure to deliver, service, repair or replace the Products arising from shortage of raw materials, failure of suppliers to make timely delivery, labor difficulties of any kind, earthquake, fire, windstorm, flood, theft, criminal or terrorist acts, war, embargoes, governmental acts or rulings, loss or damage or delays in carriage, acts of God, vandals or any other circumstances reasonably beyond MELCO's control.

5. Choice of Law/Jurisdiction.

These terms and any agreement or contract between Customer and MELCO shall be governed by the laws of the State of New York without regard to conflicts of laws. To the extent any action or dispute is not arbitrated, the parties consent to the exclusive jurisdiction and venue of the federal and state courts located in the Southern District of the State of New York. Any judgment there obtained may be enforced in any court of competent jurisdiction.

6. Arbitration.

Any controversy or claim arising out of, or relating to or in connection with the Products, their sale or use or these terms, shall be settled by arbitration conducted in accordance with the Center for Public Resources (CPR) Rules for Non-Administered Arbitration of International Disputes, by a sole arbitrator chosen from the CPR's panels of distinguished neutrals. Judgment upon the award rendered by the Arbitrator shall be final and binding and may be entered by any court having jurisdiction thereof. The place of the arbitration shall be New York City, New York. The language of the arbitration shall be English. The neutral organization designated to perform the functions specified in Rule 6 and Rules 7.7(b), 7.8 and 7.9 shall be the CPR.

TRADEMARKS

The company names, system names and product names mentioned in this manual are either registered trademarks or trademarks of their respective companies.

In some cases, trademark symbols such as [™] or [®] are not specified in this manual.

SH(NA)-081491ENG-I(2406)MEE

MODEL: R-DA-G-U-OU-E

MODEL CODE: 13JX32

MITSUBISHI ELECTRIC CORPORATION

HEAD OFFICE: TOKYO BLDG., 2-7-3, MARUNOUCHI, CHIYODA-KU, TOKYO 100-8310, JAPAN
NAGOYA WORKS: 1-14, YADA-MINAMI 5-CHOME, HIGASHI-KU, NAGOYA 461-8670, JAPAN

When exported from Japan, this manual does not require application to the
Ministry of Economy, Trade and Industry for service transaction permission.

Specifications subject to change without notice.