

Programmable Controller

MELSEC iQ-R
series

MELSEC iQ-R Ethernet User's Manual (Application)

-RJ71EN71 -R120SFCPU
-R00CPU
-R01CPU
-R02CPU
-R04CPU
-R04ENCPU
-R08CPU
-R08ENCPU
-R08PCPU
-R08PSFCPU
-R08SFCPU
-R16CPU
-R16ENCPU
-R16PCPU
-R16PSFCPU
-R16SFCPU
-R32CPU
-R32ENCPU
-R32PCPU
-R32PSFCPU
-R32SFCPU
-R120CPU
-R120ENCPU
-R120PCPU
-R120PSFCPU



SAFETY PRECAUTIONS

(Read these precautions before using this product.)

Before using this product, please read this manual and the relevant manuals carefully and pay full attention to safety to handle the product correctly.

The precautions given in this manual are concerned with this product only. For the safety precautions of the programmable controller system, refer to the MELSEC iQ-R Module Configuration Manual.

In this manual, the safety precautions are classified into two levels: "⚠️ WARNING" and "⚠️ CAUTION".

 WARNING	Indicates that incorrect handling may cause hazardous conditions, resulting in death or severe injury.
 CAUTION	Indicates that incorrect handling may cause hazardous conditions, resulting in minor or moderate injury or property damage.

Under some circumstances, failure to observe the precautions given under "⚠️ CAUTION" may lead to serious consequences.

Observe the precautions of both levels because they are important for personal and system safety.

Make sure that the end users read this manual and then keep the manual in a safe place for future reference.

[Design Precautions]

WARNING

- Configure safety circuits external to the programmable controller to ensure that the entire system operates safely even when a fault occurs in the external power supply or the programmable controller. Failure to do so may result in an accident due to an incorrect output or malfunction.
 - (1) Emergency stop circuits, protection circuits, and protective interlock circuits for conflicting operations (such as forward/reverse rotations or upper/lower limit positioning) must be configured external to the programmable controller.
 - (2) When the programmable controller detects an abnormal condition, it stops the operation and all outputs are:
 - Turned off if the overcurrent or overvoltage protection of the power supply module is activated.
 - Held or turned off according to the parameter setting if the self-diagnostic function of the CPU module detects an error such as a watchdog timer error.
 - (3) All outputs may be turned on if an error occurs in a part, such as an I/O control part, where the CPU module cannot detect any error. To ensure safety operation in such a case, provide a safety mechanism or a fail-safe circuit external to the programmable controller. For a fail-safe circuit example, refer to "General Safety Requirements" in the MELSEC iQ-R Module Configuration Manual.
 - (4) Outputs may remain on or off due to a failure of a component such as a relay and transistor in an output circuit. Configure an external circuit for monitoring output signals that could cause a serious accident.
 - In an output circuit, when a load current exceeding the rated current or an overcurrent caused by a load short-circuit flows for a long time, it may cause smoke and fire. To prevent this, configure an external safety circuit, such as a fuse.
 - Configure a circuit so that the programmable controller is turned on first and then the external power supply. If the external power supply is turned on first, an accident may occur due to an incorrect output or malfunction.
 - Configure a circuit so that the external power supply is turned off first and then the programmable controller. If the programmable controller is turned off first, an accident may occur due to an incorrect output or malfunction.
 - For the operating status of each station after a communication failure, refer to manuals for the network used. For the manuals, please consult your local Mitsubishi representative. Incorrect output or malfunction due to a communication failure may result in an accident.
-

[Design Precautions]

WARNING

- When connecting an external device with a CPU module or intelligent function module to modify data of a running programmable controller, configure an interlock circuit in the program to ensure that the entire system will always operate safely. For other forms of control (such as program modification, parameter change, forced output, or operating status change) of a running programmable controller, read the relevant manuals carefully and ensure that the operation is safe before proceeding. Improper operation may damage machines or cause accidents. When a Safety CPU is used, data cannot be modified while the Safety CPU is in SAFETY MODE.
 - Especially, when a remote programmable controller is controlled by an external device, immediate action cannot be taken if a problem occurs in the programmable controller due to a communication failure. To prevent this, configure an interlock circuit in the program, and determine corrective actions to be taken between the external device and CPU module in case of a communication failure.
 - Do not write any data to the "system area" and "write-protect area" of the buffer memory in the module. Also, do not use any "use prohibited" signals as an output signal from the CPU module to each module. Doing so may cause malfunction of the programmable controller system. For the "system area", "write-protect area", and the "use prohibited" signals, refer to the user's manual for the module used. For areas used for safety communications, they are protected from being written by users, and thus safety communications failure caused by data writing does not occur.
 - If a communication cable is disconnected, the network may be unstable, resulting in a communication failure of multiple stations. Configure an interlock circuit in the program to ensure that the entire system will always operate safely even if communications fail. Failure to do so may result in an accident due to an incorrect output or malfunction. When safety communications are used, an interlock by the safety station interlock function protects the system from an incorrect output or malfunction.
-

[Design Precautions]

CAUTION

- Do not install the control lines or communication cables together with the main circuit lines or power cables. Doing so may result in malfunction due to electromagnetic interference. Keep a distance of 100mm or more between those cables.
 - During control of an inductive load such as a lamp, heater, or solenoid valve, a large current (approximately ten times greater than normal) may flow when the output is turned from off to on. Therefore, use a module that has a sufficient current rating.
 - After the CPU module is powered on or is reset, the time taken to enter the RUN status varies depending on the system configuration, parameter settings, and/or program size. Design circuits so that the entire system will always operate safely, regardless of the time.
 - Do not power off the programmable controller or reset the CPU module while the settings are being written. Doing so will make the data in the flash ROM and SD memory card undefined. The values need to be set in the buffer memory and written to the flash ROM and SD memory card again. Doing so also may cause malfunction or failure of the module.
 - When changing the operating status of the CPU module from external devices (such as the remote RUN/STOP functions), select "Do Not Open by Program" for "Opening Method" of "Module Parameter". If "Open by Program" is selected, an execution of the remote STOP function causes the communication line to close. Consequently, the CPU module cannot reopen the line, and external devices cannot execute the remote RUN function.
-

[Security Precautions]

WARNING

- To maintain the security (confidentiality, integrity, and availability) of the programmable controller and the system against unauthorized access, denial-of-service (DoS) attacks, computer viruses, and other cyberattacks from external devices via the network, take appropriate measures such as firewalls, virtual private networks (VPNs), and antivirus solutions.
-

[Installation Precautions]

WARNING

- Shut off the external power supply (all phases) used in the system before mounting or removing the module. Failure to do so may result in electric shock or cause the module to fail or malfunction.
-

[Installation Precautions]

CAUTION

- Use the programmable controller in an environment that meets the general specifications in the Safety Guidelines (IB-0800525). Failure to do so may result in electric shock, fire, malfunction, or damage to or deterioration of the product.
 - To mount a module, place the concave part(s) located at the bottom onto the guide(s) of the base unit, and push in the module until the hook(s) located at the top snaps into place. Incorrect interconnection may cause malfunction, failure, or drop of the module.
 - To mount a module with no module fixing hook, place the concave part(s) located at the bottom onto the guide(s) of the base unit, push in the module, and fix it with screw(s). Incorrect interconnection may cause malfunction, failure, or drop of the module.
 - When using the programmable controller in an environment of frequent vibrations, fix the module with a screw.
 - Tighten the screws within the specified torque range. Undertightening can cause drop of the component or wire, short circuit, or malfunction. Overtightening can damage the screw and/or module, resulting in drop, short circuit, or malfunction.
 - When using an extension cable, connect it to the extension cable connector of the base unit securely. Check the connection for looseness. Poor contact may cause malfunction.
 - When using an SD memory card, fully insert it into the SD memory card slot. Check that it is inserted completely. Poor contact may cause malfunction.
 - Securely insert an extended SRAM cassette or a battery-less option cassette into the cassette connector of the CPU module. After insertion, close the cassette cover and check that the cassette is inserted completely. Poor contact may cause malfunction.
 - Beware that the module could be very hot while power is on and immediately after power-off.
 - Do not directly touch any conductive parts and electronic components of the module, SD memory card, extended SRAM cassette, battery-less option cassette, or connector. Doing so can cause malfunction or failure of the module.
-

[Wiring Precautions]

WARNING

- Shut off the external power supply (all phases) used in the system before installation and wiring. Failure to do so may result in electric shock or cause the module to fail or malfunction.
- After installation and wiring, attach a blank cover module (RG60) to each empty slot before powering on the system for operation. Also, attach an extension connector protective cover^{*1} to each unused extension cable connector as necessary. Directly touching any conductive parts of the connectors while power is on may result in electric shock.

*1 For details, please consult your local Mitsubishi Electric representative.

[Wiring Precautions]

CAUTION

- Individually ground the FG and LG terminals of the programmable controller with a ground resistance of 100 ohms or less. Failure to do so may result in electric shock or malfunction.
 - Use applicable solderless terminals and tighten them within the specified torque range. If any spade solderless terminal is used, it may be disconnected when the terminal screw comes loose, resulting in failure.
 - Check the rated voltage and signal layout before wiring to the module, and connect the cables correctly. Connecting a power supply with a different voltage rating or incorrect wiring may cause fire or failure.
 - Connectors for external devices must be crimped or pressed with the tool specified by the manufacturer, or must be correctly soldered. Incomplete connections may cause short circuit, fire, or malfunction.
 - Securely connect the connector to the module. Poor contact may cause malfunction.
 - Do not install the control lines or communication cables together with the main circuit lines or power cables. Doing so may result in malfunction due to noise. Keep a distance of 100mm or more between those cables.
 - Place the cables in a duct or clamp them. If not, dangling cables may swing or inadvertently be pulled, resulting in malfunction or damage to modules or cables.
In addition, the weight of the cables may put stress on modules in an environment of strong vibrations and shocks.
Do not clamp the extension cables with the jacket stripped. Doing so may change the characteristics of the cables, resulting in malfunction.
 - Check the interface type and correctly connect the cable. Incorrect wiring (connecting the cable to an incorrect interface) may cause failure of the module and external device.
 - Tighten the terminal screws or connector screws within the specified torque range. Undertightening can cause drop of the screw, short circuit, fire, or malfunction. Overtightening can damage the screw and/or module, resulting in drop, short circuit, fire, or malfunction.
 - When disconnecting the cable from the module, do not pull the cable by the cable part. For the cable with connector, hold the connector part of the cable. For the cable connected to the terminal block, loosen the terminal screw. Pulling the cable connected to the module may result in malfunction or damage to the module or cable.
 - Prevent foreign matter such as dust or wire chips from entering the module. Such foreign matter can cause a fire, failure, or malfunction.
 - When a protective film is attached to the top of the module, remove it before system operation. If not, inadequate heat dissipation of the module may cause a fire, failure, or malfunction.
 - Programmable controllers must be installed in control panels. Connect the main power supply to the power supply module in the control panel through a relay terminal block. Wiring and replacement of a power supply module must be performed by qualified maintenance personnel with knowledge of protection against electric shock. For wiring, refer to the MELSEC iQ-R Module Configuration Manual.
 - For Ethernet cables to be used in the system, select the ones that meet the specifications in the user's manual for the module used. If not, normal data transmission is not guaranteed.
-

[Startup and Maintenance Precautions]

WARNING

- Do not touch any terminal while power is on. Doing so will cause electric shock or malfunction.
 - Correctly connect the battery connector. Do not charge, disassemble, heat, short-circuit, solder, or throw the battery into the fire. Also, do not expose it to liquid or strong shock. Doing so will cause the battery to produce heat, explode, ignite, or leak, resulting in injury and fire.
 - Shut off the external power supply (all phases) used in the system before cleaning the module or retightening the terminal screws, connector screws, or module fixing screws. Failure to do so may result in electric shock.
-

[Startup and Maintenance Precautions]

CAUTION

- When connecting an external device with a CPU module or intelligent function module to modify data of a running programmable controller, configure an interlock circuit in the program to ensure that the entire system will always operate safely. For other forms of control (such as program modification, parameter change, forced output, or operating status change) of a running programmable controller, read the relevant manuals carefully and ensure that the operation is safe before proceeding. Improper operation may damage machines or cause accidents.
 - Especially, when a remote programmable controller is controlled by an external device, immediate action cannot be taken if a problem occurs in the programmable controller due to a communication failure. To prevent this, configure an interlock circuit in the program, and determine corrective actions to be taken between the external device and CPU module in case of a communication failure.
 - Do not disassemble or modify the modules. Doing so may cause failure, malfunction, injury, or a fire.
 - Use any radio communication device such as a cellular phone or PHS (Personal Handy-phone System) 25cm or more away in all directions from the programmable controller. Failure to do so may cause malfunction.
 - Shut off the external power supply (all phases) used in the system before mounting or removing the module. Failure to do so may cause the module to fail or malfunction.
 - Tighten the screws within the specified torque range. Undertightening can cause drop of the component or wire, short circuit, or malfunction. Overtightening can damage the screw and/or module, resulting in drop, short circuit, or malfunction.
 - After the first use of the product, do not perform each of the following operations more than 50 times (IEC 61131-2/JIS B 3502 compliant):
Exceeding the limit may cause malfunction.
 - Mounting/removing the module to/from the base unit
 - Inserting/removing the extended SRAM cassette or battery-less option cassette to/from the CPU module
 - Mounting/removing the terminal block to/from the module
 - Connecting/disconnecting the extension cable to/from the base unit
 - After the first use of the product, do not insert/remove the SD memory card to/from the CPU module more than 500 times. Exceeding the limit may cause malfunction.
 - Do not touch the metal terminals on the back side of the SD memory card. Doing so may cause malfunction or failure of the module.
 - Do not touch the integrated circuits on the circuit board of an extended SRAM cassette or a battery-less option cassette. Doing so may cause malfunction or failure of the module.
-

[Startup and Maintenance Precautions]

CAUTION

- Do not drop or apply shock to the battery to be installed in the module. Doing so may damage the battery, causing the battery fluid to leak inside the battery. If the battery is dropped or any shock is applied to it, dispose of it without using.
 - Startup and maintenance of a control panel must be performed by qualified maintenance personnel with knowledge of protection against electric shock. Lock the control panel so that only qualified maintenance personnel can operate it.
 - Before handling the module, touch a conducting object such as a grounded metal to discharge the static electricity from the human body. Wearing a grounded antistatic wrist strap is recommended. Failure to discharge the static electricity may cause the module to fail or malfunction.
 - After unpacking, eliminate static electricity from the module to prevent electrostatic discharge from affecting the module. If an electrostatically charged module comes in contact with a grounded metal object, a sudden electrostatic discharge of the module may cause failure.
For details on how to eliminate static electricity from the module, refer to the following. Antistatic Precautions Before Using MELSEC iQ-R Series Products (FA-A-0368)
 - Use a clean and dry cloth to wipe off dirt on the module.
-

[Operating Precautions]

CAUTION

- When changing data and operating status, and modifying program of the running programmable controller from an external device such as a personal computer connected to an intelligent function module, read relevant manuals carefully and ensure the safety before operation. Incorrect change or modification may cause system malfunction, damage to the machines, or accidents.
 - Do not power off the programmable controller or reset the CPU module while the setting values in the buffer memory are being written to the flash ROM in the module. Doing so will make the data in the flash ROM and SD memory card undefined. The values need to be set in the buffer memory and written to the flash ROM and SD memory card again. Doing so can cause malfunction or failure of the module.
-

[Disposal Precautions]

CAUTION

- When disposing of this product, treat it as industrial waste.
 - When disposing of batteries, separate them from other wastes according to the local regulations. For details on battery regulations in EU member states, refer to the MELSEC iQ-R Module Configuration Manual.
-

[Transportation Precautions]

CAUTION

- When transporting lithium batteries, follow the transportation regulations. For details on the regulated models, refer to the MELSEC iQ-R Module Configuration Manual.
 - The halogens (such as fluorine, chlorine, bromine, and iodine), which are contained in a fumigant used for disinfection and pest control of wood packaging materials, may cause failure of the product. Prevent the entry of fumigant residues into the product or consider other methods (such as heat treatment) instead of fumigation. The disinfection and pest control measures must be applied to unprocessed raw wood.
-

CONDITIONS OF USE FOR THE PRODUCT

- (1) MELSEC programmable controller ("the PRODUCT") shall be used in conditions;
- i) where any problem, fault or failure occurring in the PRODUCT, if any, shall not lead to any major or serious accident; and
 - ii) where the backup and fail-safe function are systematically or automatically provided outside of the PRODUCT for the case of any problem, fault or failure occurring in the PRODUCT.
- (2) The PRODUCT has been designed and manufactured for the purpose of being used in general industries. MITSUBISHI ELECTRIC SHALL HAVE NO RESPONSIBILITY OR LIABILITY (INCLUDING, BUT NOT LIMITED TO ANY AND ALL RESPONSIBILITY OR LIABILITY BASED ON CONTRACT, WARRANTY, TORT, PRODUCT LIABILITY) FOR ANY INJURY OR DEATH TO PERSONS OR LOSS OR DAMAGE TO PROPERTY CAUSED BY the PRODUCT THAT ARE OPERATED OR USED IN APPLICATION NOT INTENDED OR EXCLUDED BY INSTRUCTIONS, PRECAUTIONS, OR WARNING CONTAINED IN MITSUBISHI ELECTRIC USER'S, INSTRUCTION AND/OR SAFETY MANUALS, TECHNICAL BULLETINS AND GUIDELINES FOR the PRODUCT.
- ("Prohibited Application")
- Prohibited Applications include, but not limited to, the use of the PRODUCT in;
- Nuclear Power Plants and any other power plants operated by Power companies, and/or any other cases in which the public could be affected if any problem or fault occurs in the PRODUCT.
 - Railway companies or Public service purposes, and/or any other cases in which establishment of a special quality assurance system is required by the Purchaser or End User.
 - Aircraft or Aerospace, Medical applications, Train equipment, transport equipment such as Elevator and Escalator, Incineration and Fuel devices, Vehicles, Manned transportation, Equipment for Recreation and Amusement, and Safety devices, handling of Nuclear or Hazardous Materials or Chemicals, Mining and Drilling, and/or other applications where there is a significant risk of injury to the public or property.
- Notwithstanding the above restrictions, Mitsubishi Electric may in its sole discretion, authorize use of the PRODUCT in one or more of the Prohibited Applications, provided that the usage of the PRODUCT is limited only for the specific applications agreed to by Mitsubishi Electric and provided further that no special quality assurance or fail-safe, redundant or other safety features which exceed the general specifications of the PRODUCTS are required. For details, please contact the Mitsubishi Electric representative in your region.
- (3) Mitsubishi Electric shall have no responsibility or liability for any problems involving programmable controller trouble and system trouble caused by DoS attacks, unauthorized access, computer viruses, and other cyberattacks.

INTRODUCTION

Thank you for purchasing the Mitsubishi Electric MELSEC iQ-R series programmable controllers.

This manual describes the functions, programming, and troubleshooting of the relevant products listed below.

Before using this product, please read this manual and the relevant manuals carefully and develop familiarity with the functions and performance of the MELSEC iQ-R series programmable controller to handle the product correctly.

When applying the program examples provided in this manual to an actual system, ensure the applicability and confirm that it will not cause system control problems.

Please make sure that the end users read this manual.

Relevant products

RJ71EN71, CPU module

Point

Unless otherwise specified, the buffer memory addresses in this manual are for when the P1 connector of the RJ71EN71 or RnENCPU is used.

Check the corresponding buffer memory addresses in the list and use the correct addresses when using the following: ( Page 473 Buffer Memory)

- CPU module (built-in Ethernet port part)
 - P2 connector of the RJ71EN71
 - RJ71EN71 (network type: Q-compatible Ethernet)
-

CONTENTS

SAFETY PRECAUTIONS	1
CONDITIONS OF USE FOR THE PRODUCT	10
INTRODUCTION	11
RELEVANT MANUALS	17
TERMS	18
GENERIC TERMS AND ABBREVIATIONS	20
CHAPTER 1 FUNCTIONS	21
1.1 Connection with MELSOFT Product and GOT	21
Connection via a hub	22
Direct connection	28
1.2 SLMP Communications	31
Applications	31
Communication structure	32
Data communication procedures	32
List of valid commands	34
Dedicated instructions	35
1.3 Communications Using the Predefined Protocol	36
Applicable connections	36
Data communication procedures	37
Protocol communication type	45
Packet elements	46
Execution conditions of predefined protocol communications	53
Example of predefined protocol communications	55
1.4 Socket Communications	64
Setting procedure	64
Applicable dedicated instructions	65
Applicable connections	65
Communication structure	66
Communications using TCP/IP	67
Communications using UDP/IP	70
Broadcast communications	71
Precautions	72
1.5 Communications Using the Fixed Buffer	73
Differences between the "Procedure Exist" and "No Procedure" control methods	73
Setting procedure	73
Applicable dedicated instructions	74
Applicable connections	74
Communication structure	74
Send procedure	76
Receive procedure	78
Pairing open	82
Broadcast communications	83
Precautions	83
Data format	84
Example of communications using the fixed buffer	89
1.6 Communications Using the Random Access Buffer	99
Setting procedure	99

Communication structure	100
Procedure for reading from external device	100
Procedure for writing from external device	101
Physical address and logical address of random access buffer	102
Precautions	102
Data format	102
Example of communications with random access buffer	111
1.7 Communications Using MODBUS/TCP	112
MODBUS/TCP master function	112
MODBUS/TCP slave function	112
1.8 Link Dedicated Instruction Communication	120
Data communication procedures	120
1.9 File Transfer Function (FTP server)	121
Data communication procedures	122
Files that can be transferred with FTP	124
FTP command	125
Precautions	138
1.10 File Transfer Function (FTP Client)	141
Transferable files	142
Procedure for executing the file transfer function (FTP client)	143
Precautions	145
1.11 Time Setting Function (SNTP Client)	147
1.12 Web Server Function	149
JavaScript objects	150
CGI object	164
Error message	178
1.13 Security	180
IP filter	180
Remote password	181
1.14 Simple CPU Communication Function (RJ71EN71, RnENCPU (Network Part))	188
Setting procedure	190
Checking the simple CPU communication status	214
Communication example	217
Precautions	222
1.15 Simple CPU Communication Function (CPU Module (Built-in Ethernet Port Part))	226
Setting procedure	227
Checking the simple CPU communication status	242
Simple CPU communication in a redundant system	244
Precautions	249
1.16 Simple Device Communication Function	251
Setting procedure	251
Checking the simple device communication status	255
Communication example	256
Operation	261
Precautions	282
1.17 IP Address Change Function	286
IP address of the Ethernet-equipped module	287
Usage methods	289
Checking the IP address	292
Checking the operating status	292
Precautions	292

1.18	Redundant System Function	294
	System configuration	294
	System switching request	295
	System switching cause	296
	Redundant group setting	298
	Communication path bypass function	300
	Both systems identical IP address setting function	301
	Functions restricted in a redundant system	304
	Setting example	309
1.19	Discard Received Data at CPU STOP	316

CHAPTER 2 PARAMETER SETTINGS **317**

2.1	Setting Parameters	317
2.2	Basic Settings	317
	Own Node Settings	318
	External Device Configuration	320
	Transmission Port Settings	323
2.3	Application Settings	324
	Frame Settings	327
	Communication Speed	328
	FTP Server Settings	329
	FTP Client Settings	330
	DNS Settings	330
	MODBUS/TCP Settings	331
	Simple CPU communication setting (RJ71EN71, RnENCPU (network part))	333
	Simple CPU communication setting (CPU module (built-in Ethernet port part))	336
	Simple Device Communication Setting	338
	Time Setting	391
	Timer Settings for Data Communication	392
	Security	395
	Gateway Parameter Settings	395
	Network/Station No. <-> IP information setting	398
	Interrupt Settings	405
	IP Packet Transfer Setting	405
	Network Dynamic Routing	406
	Module Operation Mode	406
	Redundant System Settings	407
	iQ Sensor Solution Settings	410
	SLMPSND Instruction Settings	410

CHAPTER 3 TROUBLESHOOTING **411**

3.1	Checking with LED	411
3.2	Checking the Module Status	413
	Module communication test	415
3.3	Checking the Network Status	417
	Ethernet diagnostics	417
	Simple CPU communication diagnostics	425
	Error log area	427
3.4	Troubleshooting by Symptom	428
	Communications cannot be performed with the external device	428

A message sent from the external device cannot be received frequently.....	429
Direct connection to the engineering tool is not possible.	430
CPU module search on the network cannot be performed.....	430
Communications using the SLMP cannot be performed.	431
Communications using the predefined protocol cannot be performed.	432
Communications using the random access buffer cannot be performed.....	433
Socket communications/communications using the fixed buffer cannot be performed.	434
Communications using MODBUS/TCP cannot be performed.	435
A dedicated instruction is not completed.	436
Communications using a link dedicated instruction cannot be performed.....	436
Access using the file transfer function (FTP server) cannot be performed.....	436
Access using the file transfer function (FTP client) cannot be performed.	437
The time setting function (SNTP client) cannot be performed normally.	437
The access cannot be allowed/denied correctly by the IP filter.	437
Remote password does not work.....	437
Communications using the built-in Ethernet port are slow.	438
When the simple CPU communication function is used	438
When the simple device communication function is used	440
Data communications cannot be performed with the device supporting iQ Sensor Solution.....	440
When the redundant system function is used	441
3.5 List of Error Codes	443
3.6 List of Parameter Numbers.....	464
3.7 Event List.....	466
3.8 End Codes Returned to an External Device During Data Communications	468

APPENDICES	470
Appendix 1 Module Label	470
Appendix 2 I/O Signals	471
List of I/O signals.....	471
Appendix 3 Buffer Memory	473
List of buffer memory addresses	473
Details of buffer memory addresses (RJ71EN71, RnENCPU (network part)).....	492
Details of buffer memory addresses (CPU module (built-in Ethernet port part)).....	513
Appendix 4 Dedicated Instruction	521
Open/close processing instructions.....	521
Instruction for SLMP communications	521
Instructions for predefined protocol communications	522
Socket communications instructions	522
Instructions for communications using the fixed buffer	522
Link dedicated instructions	523
File transfer function instruction.....	523
Other dedicated instructions	524
Appendix 5 TCP/IP Communications, UDP/IP Communications.....	525
TCP/IP communications	525
UDP/IP communications	530
Appendix 6 Communications with Different Networks.....	532
Appendix 7 Processing Time	535
Performance list of simple CPU communication function	539
Appendix 8 Mounting the Module with a Remote Head Module	541
Restrictions on functions and specifications	541

Appendix 9 Using the Module in the Redundant System with Redundant Extension Base Unit	542
Restrictions on functions and specifications	542
Precautions	543
Example of communications using the fixed buffer	544
Appendix 10 Port Numbers Used by Ethernet-equipped Module	550
Appendix 11 Operation Image and Data Structure of Predefined Protocol	552
Operation image of each communication type of protocol	552
Verification operation of receive packet.	557
Example of packet element data	558
Appendix 12 Example of External Device Program	561
Appendix 13 How to Turn Off ERR LED	562
Appendix 14 Software Licenses and Copyrights	563
Appendix 15 Added and Enhanced Functions	564
RJ71EN71, RnENCPU (network part).	564
CPU module (built-in Ethernet port part).	565
INDEX	567
<hr/>	
REVISIONS	569
WARRANTY	571
TRADEMARKS	572

RELEVANT MANUALS

Manual name [manual number]	Description	Available form
MELSEC iQ-R Ethernet User's Manual (Application) [SH-081257ENG] (this manual)	Functions, parameter settings, programming, troubleshooting, I/O signals, and buffer memory of Ethernet	Print book e-Manual PDF
MELSEC iQ-R Module Configuration Manual [SH-081262ENG]	The combination of the MELSEC iQ-R series modules, common information on the installation/wiring in the system, and specifications of the power supply module, base unit, SD memory card, and battery	Print book e-Manual PDF
MELSEC iQ-R Ethernet/CC-Link IE User's Manual (Startup) [SH-081256ENG]	Specifications, procedures before operation, system configuration, wiring, and communication examples of Ethernet, CC-Link IE Controller Network, and CC-Link IE Field Network	Print book e-Manual PDF
MELSEC iQ-R CPU Module User's Manual (Startup) [SH-081263ENG]	Performance specifications, procedures before operation, and troubleshooting of the CPU module	Print book e-Manual PDF
MELSEC iQ-R CPU Module User's Manual (Application) [SH-081264ENG]	Memory, functions, devices, and parameters of the CPU module	Print book e-Manual PDF
MELSEC iQ-R Programmable Controller CPU Module User's Manual [SH-082488ENG]	Procedures before operation, specifications, devices, memory, functions, parameters, and troubleshooting of the programmable controller CPU	e-Manual PDF
MELSEC iQ-R Process CPU Module User's Manual [SH-082493ENG]	Procedures before operation, specifications, devices, memory, functions, parameters, and troubleshooting of the Process CPU	e-Manual PDF
MELSEC iQ-R Programming Manual (CPU Module Instructions, Standard Functions/Function Blocks) [SH-081266ENG]	Instructions for the CPU module and standard functions/function blocks	e-Manual PDF
MELSEC iQ-R Programming Manual (Module Dedicated Instructions) [SH-081976ENG]	Dedicated instructions for the intelligent function modules	e-Manual PDF
MELSEC iQ-R Ethernet, CC-Link IE, and MELSECNET/H Function Block Reference [BCN-P5999-0381]	Specifications of the following MELSEC iQ-R series module FBs: Ethernet-equipped module FBs, CC-Link IE TSN module FBs, CC-Link IE Controller Network module FBs, CC-Link IE Field Network module FBs, and MELSECNET/H network module FBs	e-Manual PDF
GX Works3 Operating Manual [SH-081215ENG]	System configuration, parameter settings, and online operations of GX Works3	e-Manual PDF
MELSEC iQ-R MODBUS and MODBUS/TCP Reference Manual [BCN-P5999-1060]	The protocol used for data reading or writing from an external device to the Ethernet-equipped module	e-Manual PDF
SLMP Reference Manual [SH-080956ENG]	The protocol used to access an SLMP-compatible device from an external device (such as a personal computer or HMI (Human Machine Interface)) or an SLMP-compatible module (such as the Ethernet-equipped module or modules on CC-Link IE TSN).	Print book e-Manual PDF
iQ Sensor Solution Reference Manual [SH-081133ENG]	Operation methods of the online functions for iQ Sensor Solution	Print book e-Manual PDF
MELSEC iQ-R Simple Device Communication Library Reference Manual [SH-082515ENG]	Simple device communication library	e-Manual PDF



e-Manual refers to the Mitsubishi Electric FA electronic book manuals that can be browsed using a dedicated tool.

e-Manual has the following features:

- Required information can be cross-searched in multiple manuals.
- Other manuals can be accessed from the links in the manual.
- The hardware specifications of each part can be found from the product figures.
- Pages that users often browse can be bookmarked.
- Sample programs can be copied to an engineering tool.

TERMS

Unless otherwise specified, this manual uses the following terms.

Term	Description
Buffer memory	Memory in an intelligent function module to store data such as setting values and monitor values. For CPU modules, it refers to memory to store data such as setting values and monitor values of the Ethernet function, or data used for data communication of the multiple CPU system function.
Control CPU	A CPU module that controls connected I/O modules and intelligent function modules. In a multiple CPU system, a control CPU can be set for each module.
Control system	A system that controls a redundant system and performs network communications in a redundant system
Control System IP Address	An IP address common to system A and system B in a redundant system. (☞ Page 301 Both systems identical IP address setting function)
CPU module (built-in Ethernet port part)	A built-in Ethernet port part of a CPU module (CPU part for an RnENCPU).
Device	A memory of a CPU module to store data. Devices such as X, Y, M, D, and others are provided depending on the intended use.
Engineering tool	A tool used for setting up programmable controllers, programming, debugging, and maintenance
Global label	A label that is valid for all the program data when multiple program data are created in the project. There are two types of global label: a module specific label (module label), which is generated automatically by GX Works3, and an optional label, which can be created for any specified device.
Intelligent function module	A module that has functions other than an input or output, such as an A/D converter module and D/A converter module
iQSS	iQ Sensor Solution. Cooperation of sensors, programmable controllers, HMI (Human Machine Interface), and engineering tool to facilitate the start-up or maintenance of sensors. (☞ iQ Sensor Solution Reference Manual)
MODBUS/TCP	A protocol for using MODBUS protocol messages on a TCP/IP network
Module label	A label that represents one of memory areas (I/O signals and buffer memory areas) specific to each module in a given character string. For the module used, GX Works3 automatically generates this label, which can be used as a global label.
New control system	A system that has switched to control system from standby system after system switching
OPS	An operation station using MELSOFT and EZSocket partner products.
Predefined protocol support function	A function of GX Works3. This function sets protocols appropriate to each external device and reads/writes protocol setting data.
Process CPU	A CPU module that performs process control and sequence control. Process control function blocks and the online module change function can be executed. This module is also used with a redundant function module as a pair and configures a redundant system. The Process CPU models include the R08PCPU, R16PCPU, R32PCPU, and R120PCPU.
Process CPU (redundant mode)	A Process CPU operating in redundant mode. A redundant system is configured with this CPU module. Process control function blocks and the online module change function can be used even in this mode.
Redundant function module	A module to configure a redundant system by using it in combination with a process CPU (redundant mode). The SIL2 function module model name is R6RFM.
Redundant system	A system consisting of two systems that have same configuration (CPU module, power supply module, network module, and other modules). Even after an error occurs in one of the two system, the other system takes over the control of the entire system.
Redundant system with redundant extension base unit	A redundant system that is configured using extension base unit(s)
Relay station	A station that relays data link to other station with mounting more than one network modules on one programmable controller.
RnENCPU (CPU part)	A module on the left-hand side of the RnENCPU (☞ MELSEC iQ-R Ethernet/CC-Link IE User's Manual (Startup))
RnENCPU (network part)	A module on the right-hand side of the RnENCPU (☞ MELSEC iQ-R Ethernet/CC-Link IE User's Manual (Startup))
Routing	A process of selecting paths for communication with other networks. There are two types of routing: dynamic routing that auto-selects the communication routes, and static routing where communication routes are arbitrarily set.
SIL2 Process CPU	This module is used with a SIL2 function module as a pair, and performs both standard control and safety control. This module is also used with a redundant function module as a pair and configures a redundant system. The SIL2 Process CPU models include the R08PSFCPU, R16PSFCPU, R32PSFCPU, and R120PSFCPU.
SLMP	A SeamLess Message Protocol. This protocol is used to access an SLMP-compatible device or a programmable controller connected to an SLMP-compatible device from an external device.
Standby system	A backup system in a redundant system

Term	Description
Subnet mask	<p>A number used to logically divide one network into multiple subnetworks and manage them easily. The following Ethernet network systems can be configured:</p> <ul style="list-style-type: none"> • A small-scale Ethernet network system in which multiple network devices are connected. • A medium- or large-scale network system in which multiple small-scale network systems are connected via routers or other network communication devices.
System A	<p>A system that is set as system A to distinguish two systems in a redundant system. It is used to distinguish connected two systems (system A and system B).</p>
System B	<p>A system that is set as system B to distinguish two systems in a redundant system. It is used to distinguish connected two systems (system A and system B).</p>
Transient transmission group number	<p>Number that is assigned for transient transmission to any given stations. By specifying a group of stations as transient transmission target, data can be sent to the stations of the same group number.</p>

GENERIC TERMS AND ABBREVIATIONS

Unless otherwise specified, this manual uses the following generic terms and abbreviations.

Generic term/abbreviation	Description
ARP	An abbreviation for Address Resolution Protocol. This protocol is used to obtain the MAC address of Ethernet from an IP address.
BUFRCV instruction	A generic term for the dedicated instructions GP.BUFRCV and ZP.BUFRCV
BUFRCVS instruction	A generic term for the dedicated instructions G.BUFRCVS and Z.BUFRCVS
BUFSND instruction	A generic term for the dedicated instructions GP.BUFSND and ZP.BUFSND
CLOSE instruction	A generic term for the dedicated instructions GP.CLOSE, ZP.CLOSE, GP.CONCLOSE, and SP.SOCRCLOSE
ECPRTCL instruction	A generic term for the dedicated instructions GP.ECPRTCL and SP.ECPRTCL
ERRCLEAR instruction	A generic term for the dedicated instructions GP.ERRCLEAR and ZP.ERRCLEAR
ERRRD instruction	A generic term for the dedicated instructions GP.ERRRD and ZP.ERRRD
Ethernet device	A generic term for the devices supporting IP communication (such as a personal computer, a vision sensor, and a bar code reader)
Ethernet-equipped module	A generic term for the following modules: <ul style="list-style-type: none"> • RJ71EN71 (when the Ethernet function is used) • CPU module (when the Ethernet function is used)
ICMP	An abbreviation for Internet Control Message Protocol. This protocol is used to exchange messages of errors in an IP network or other information related to an Ethernet network.
MELSECNET/10	An abbreviation for the MELSECNET/10 network system
MELSECNET/H	An abbreviation for the MELSECNET/H network system
Network module	A generic term for the following modules: <ul style="list-style-type: none"> • Ethernet interface module • A module on CC-Link IE TSN (the RJ71GN11-T2 and a module on a remote station) • CC-Link IE Controller Network module • A module on CC-Link IE Field Network (a master/local module, and a module on a remote I/O station, a remote device station, and an intelligent device station) • MELSECNET/H network module • MELSECNET/10 network module • RnENCPU (network part)
OPEN instruction	A generic term for the dedicated instructions GP.OPEN, ZP.OPEN, GP.CONOPEN, and SP.SOCOPEN
Programmable controller CPU	A generic term for the R00CPU, R01CPU, R02CPU, R04CPU, R04ENCPU, R08CPU, R08ENCPU, R16CPU, R16ENCPU, R32CPU, R32ENCPU, R120CPU, R120ENCPU
READ instruction	A generic term for the dedicated instructions JP.READ and GP.READ
RECV instruction	A generic term for the dedicated instructions JP.RECV and GP.RECV
RECVS instruction	A generic term for the dedicated instructions G.RECVS and Z.RECVS
Remote head module	An abbreviation for the RJ72GF15-T2 CC-Link IE Field Network remote head module
REQ instruction	A generic term for the dedicated instructions J.REQ, JP.REQ, G.REQ, and GP.REQ
RnENCPU	A generic term for the R04ENCPU, R08ENCPU, R16ENCPU, R32ENCPU, and R120ENCPU
SEND instruction	A generic term for the dedicated instructions JP.SEND and GP.SEND
SOCRCV instruction	A generic term for the dedicated instructions GP.SOCRCV and SP.SOCRCV
SOCRCVS instruction	A generic term for the dedicated instructions G.SOCRCV and S.SOCRCV
SOCSND instruction	A generic term for the dedicated instructions GP.SOCSND and SP.SOCSND
SREAD instruction	A generic term for the dedicated instructions JP.SREAD and GP.SREAD
SWRITE instruction	A generic term for the dedicated instructions JP.SWRITE and GP.SWRITE
UINI instruction	A generic term for the dedicated instructions G.UINI, GP.UINI, Z.UINI, and ZP.UINI
WRITE instruction	A generic term for the dedicated instructions JP.WRITE and GP.WRITE
ZNRD instruction	A generic term for the dedicated instructions J.ZNRD and JP.ZNRD
ZNWR instruction	A generic term for the dedicated instructions J.ZNWR and JP.ZNWR

1 FUNCTIONS

1.1 Connection with MELSOFT Product and GOT

Programming and monitoring of the programmable controller with the engineering tool, and monitoring and testing of the programmable controller from the GOT can be performed via Ethernet. This function enables remote operations using Ethernet's long-distance connection and high-speed communication.

The section describes the methods of connecting the Ethernet-equipped module, MELSOFT product (such as engineering tool and MX Component), and GOT.

○: Connection available, ×: Connection not available

Connection method	Purpose	Availability			
		MELSOFT products		GOT	
		RJ71EN71, RnENCPU (network part)	CPU module (built-in Ethernet port part)	RJ71EN71, RnENCPU (network part)	CPU module (built-in Ethernet port part)
Connection via a hub (Connection by specifying the IP address)	<ul style="list-style-type: none"> To connect to an Ethernet-equipped module that has no network number and station number To connect multiple MELSOFT products 	○	○	×	○
Connection via a hub (Connection by specifying the network number and station number)	<ul style="list-style-type: none"> To connect by using network number and station number To connect multiple MELSOFT products and GOTs 	○	○*2	○	○*2
Direct connection (Connection without specifying the IP address, network number, or station number)*1	<ul style="list-style-type: none"> To connect without hub using one Ethernet cable for one-on-one communication with the external device To connect to an Ethernet-equipped module whose IP address is unknown 	○	○	×	×

*1 This connection method is not available when the RJ71EN71 network type is set to "Q Compatible Ethernet".

*2 Before the connection, check the firmware version of the CPU module. (📖 Page 564 Added and Enhanced Functions)

Point

For the procedures to connect the Ethernet-equipped module and GOT, refer to the following.
 Manual for the GOT used

Restriction

If multiple RJ71EN71s with the same network number are installed to one base unit (main base unit or extension base unit), the Ethernet-equipped module cannot connect to a MELSOFT product or GOT via an RJ71EN71. When the RJ71EN71 with the same network number as a relay RJ71EN71 is set in a relay network or target network, the Ethernet-equipped module cannot connect to other stations and other networks.

Connection via a hub

Setting procedure

■ Setting in the Ethernet-equipped module side

1. Set the IP address of the Ethernet-equipped module in "Own Node Settings" under "Basic Settings".

Setting Item	Item	Setting
Own Node Settings	Parameter Setting Method	Parameter Editor
	IP Address	
	IP Address	192.168.1.3
	Subnet Mask	255.255.255.0
	Default Gateway	192.168.1.254

2. When connecting by specifying the network number and station number, set the network number and station number in "Own Node Settings" under "Basic Settings".
3. When using a TCP/IP connection, add as many MELSOFT connection modules as the number of devices to be connected in "External Device Configuration" under "Basic settings". When using a UDP/IP connection, up to the maximum number of connectable devices can be connected without setting "External Device Configuration".*¹

No.	Model Name	Communication Method	Protocol	Fixed Buffer Send/Receive Setting	PLC IP Address
	Host Station				192.168.1.3
1	MELSOFT Connection Module	MELSOFT Connection	TCP		192.168.1.3

*¹ Up to 16 CPU modules (built-in Ethernet port part) are supported. Up to 64 RJ71EN71 and RnENCPU (network part) are supported.

■ Settings on the engineering tool side

Set in the "Specify Connection Destination Connection" window.

 [Online] ⇄ [Current Connection Destination]

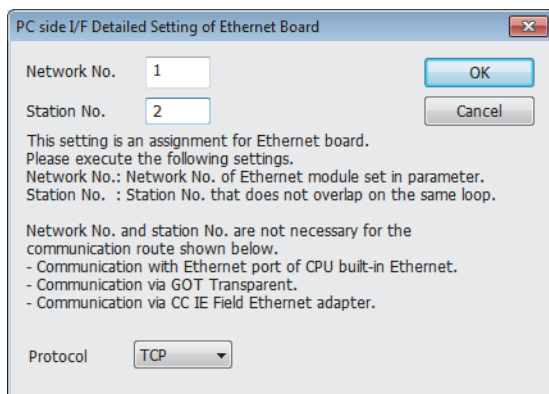
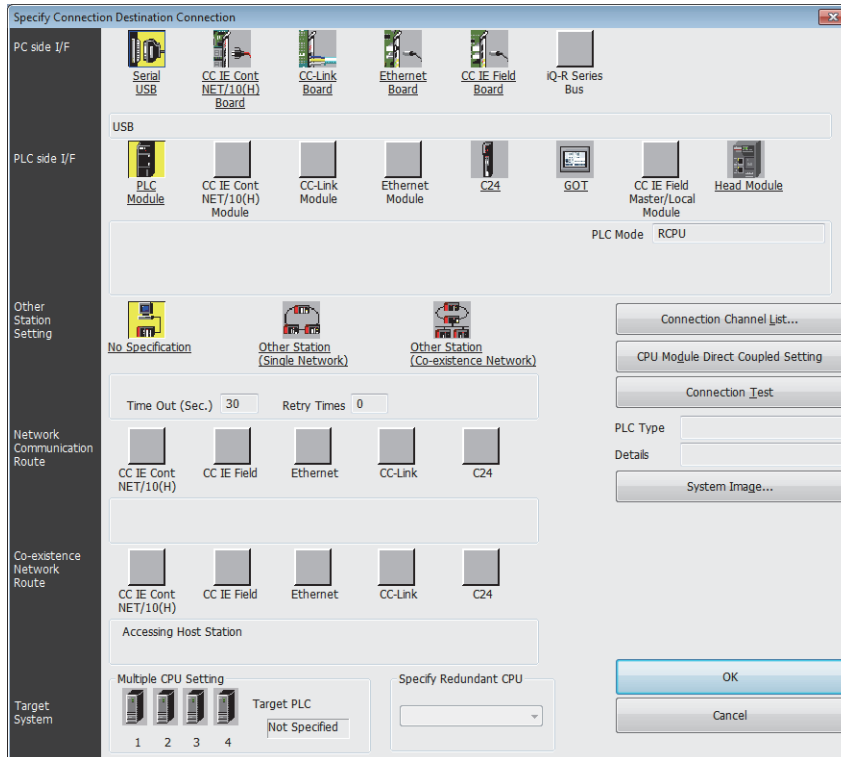

1. Set "PC side I/F" to "Ethernet Board".
2. Double-click "Ethernet Board", and open the "PC side I/F Detailed Setting of Ethernet Board" window.
3. Set the network number, station number, and protocol of the personal computer. (Set the network number and protocol according to the settings for the Ethernet-equipped module. Set the station number so that it is not the same as a station number assigned to other Ethernet devices.)*1
4. Set the "PLC side I/F" to the module to be connected.

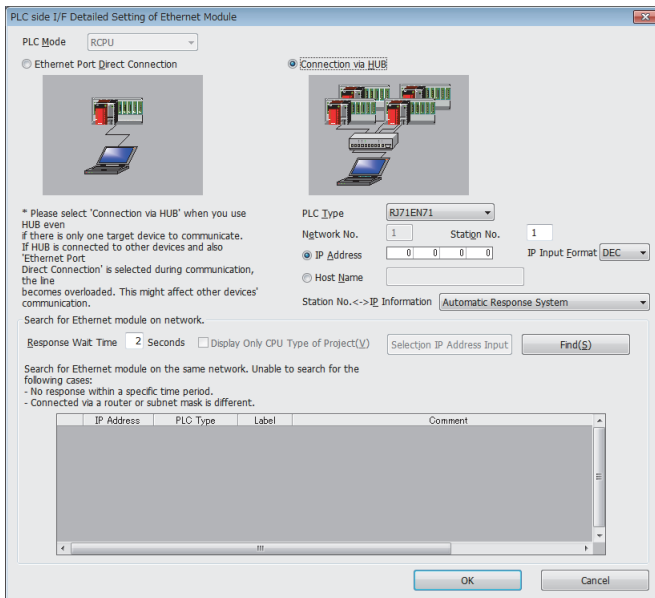

5. Double-click the icon set in step 4, and open the detailed setting window.
6. Select "Connection via HUB" for the connection method, and enter the station number and IP address or host name for the Ethernet-equipped module. Select "RJ71EN71" to connect the RnENCPU (network part).

7. Set "Other Station Setting" or "Network Communication Route" if necessary.

*1 The network number and station number do not need to be set when connecting with the CPU module (built-in Ethernet port part).

Searching modules on the network

When connecting with a hub, a list of modules that can be searched for will appear by clicking the [Find] button on the detailed setting window.

1

PLC side I/F Detailed Setting of Ethernet Module

PLC Mode: RCPU

Ethernet Port Direct Connection Connection via HUB

* Please select 'Connection via HUB' when you use HUB even if there is only one target device to communicate. If HUB is connected to other devices and also 'Ethernet Port Direct Connection' is selected during communication, the line becomes overloaded. This might affect other devices' communication.

Search for Ethernet module on network.

Response Wait Time: 2 Seconds Display Only CPU Type of Project(V) Selection IP Address Input Find(S)

Search for Ethernet module on the same network. Unable to search for the following cases:
- No response within a specific time period.
- Connected via a router or subnet mask is different.

	IP Address	PLC Type	Label	Comment
1	192.168.1.1	R04CPU		

OK Cancel

■ Search target modules

- The control CPU of the RJ71EN71 or the CPU module connected to the same hub as the engineering tool
- The control CPU of the RJ71EN71 or the CPU module connected to cascade-connected hub
- The remote head module that controls the RJ71EN71 connected to the same hub as the engineering tool
- The remote head module that controls the RJ71EN71 connected to a cascade-connected hub

Point

- By setting "Do Not Respond to CPU Module Search" in "Security" under "Application Settings" to "Do Not Respond", the modules will not be listed even if a search is performed.
- Only the MELSEC iQ-R Series Ethernet-equipped modules are searched.
- The RJ71EN71 in which the network type is set to "Q Compatible Ethernet" cannot be searched.

■When module does not appear after search

If a connected Ethernet-equipped module does not appear in the list after searching the modules on the network, check the following items.

- Search is not performed if it is disabled with the IP filter.
- Modules connected via a router cannot be searched.
- If the module is connected via a wireless LAN, packet loss can prevent the Ethernet communication from stabilizing, and may inhibit the module search.
- If there are modules with the same IP address in the list, review the IP address parameter settings for the Ethernet-equipped module.
- If the service processing load of the search-target CPU module is high, it may not be possible to search for the corresponding module. If the search cannot be performed, increase the response wait time in the search dialog, and perform the search again.

Precautions

■Remote operation

If remote STOP or remote PAUSE has been executed from the engineering tool to the CPU module on another station when the CPU module (built-in Ethernet port part) and engineering tool are connected with an Ethernet cable, perform the following before turning the power off or resetting the CPU module.

- Remote RUN
- Remote RESET

■Functions incompatible with connection via a hub

The following functions cannot be used for connection via a hub. To use the following functions, connect the CPU module (built-in Ethernet port part) directly or with a USB cable.

- Ethernet Diagnostics
- CC-Link IE Field Diagnostics
- CC-Link IE Control Diagnostics

■ Communications by network number/station number by using the CPU module (built-in Ethernet port part)

- The UDP/IP protocol is used for the connection and data is always exchanged as binary codes.
- When accessing another station, set the network number for the CPU module (built-in Ethernet port part) so that it is unique among the network numbers of the other network. Also, set the station number that is unique among the station numbers set for the other modules on the same network.
- When configuring the target station or relay station as a multiple CPU system, ensure that the CPU modules listed below have the firmware supporting the communications by network number/station number.
 - Target station
 - CPU modules working as the relay path
 - CPU module that controls the Ethernet module working as the relay path

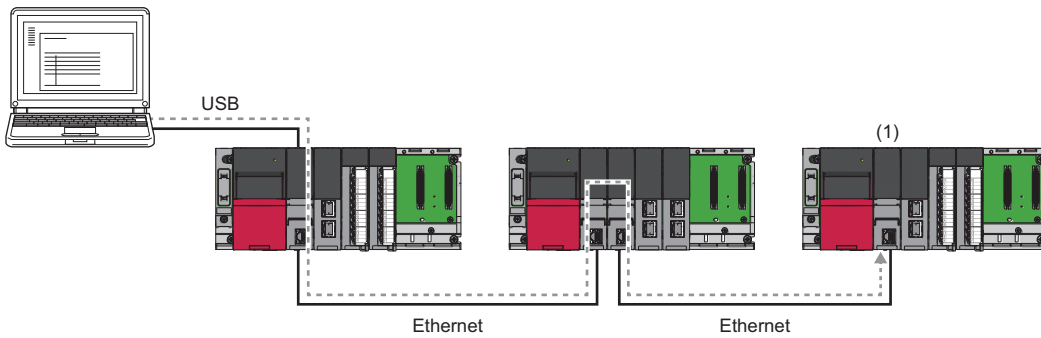

When communicating with CPU module shown as (1), ensure that all CPU modules have the firmware of the version supporting the communications by network number/station number. Also, set the network number and station number to all CPU modules.

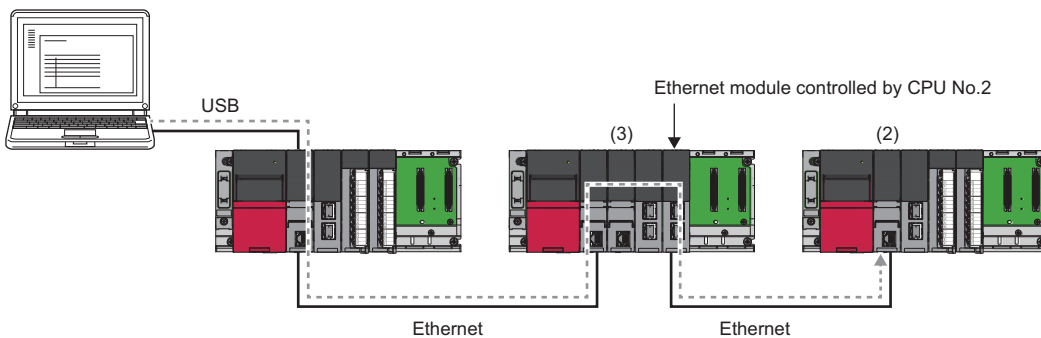

When communicating with CPU module shown as (2), ensure also that all CPU modules have the firmware of the version supporting the communications by network number/station number. Note, however, that the communication is possible even when the network number and station number are not set to CPU module shown as (3) of the CPU No.2.

Direct connection

The Ethernet-equipped module and engineering tool can be directly connected with one Ethernet cable without using a hub. When direct connection is made, communication is possible without setting the IP address or host name in the "Specify Connection Destination Connection" window. (Communicate using broadcast communications)

Point

- To prohibit direct connection with the Ethernet, set "Disable" for "Disable Direct Connection with MELSOFT" in "Security" under the "Application Settings".
- A direct connection is not possible when the RJ71EN71 network type is set to "Q Compatible Ethernet".

Set in the "Specify Connection Destination Connection" window.

 [Online] ⇔ [Current Connection Destination]

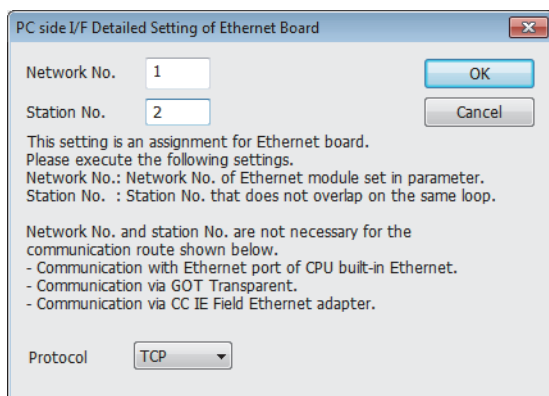
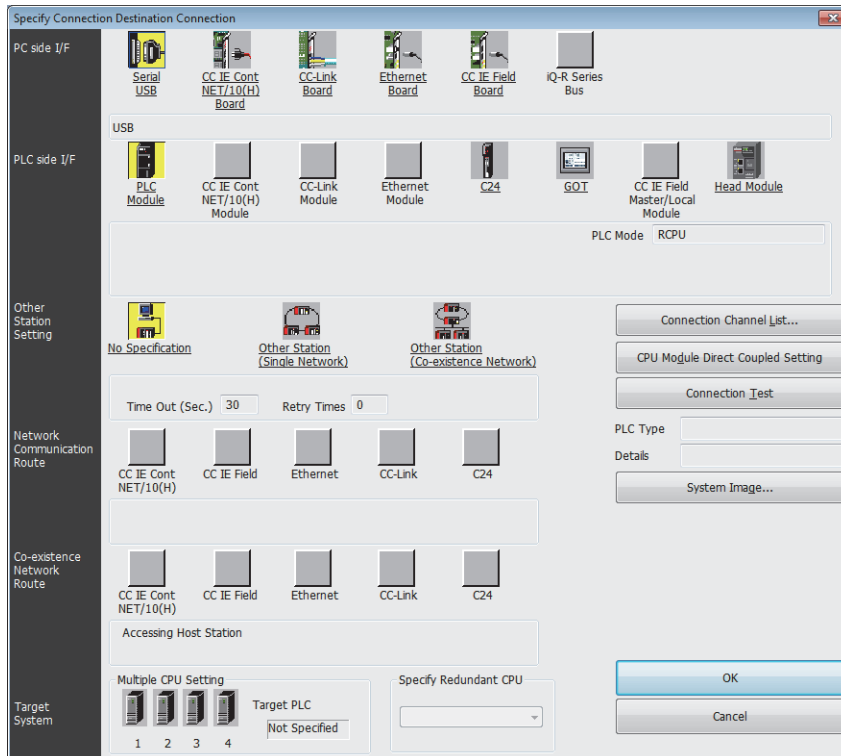

1. Set "PC side I/F" to "Ethernet Board".
2. Double-click "Ethernet Board", and open the "PC side I/F Detailed Setting of Ethernet Board" window.
3. Set the network number, station number, and protocol of the personal computer. (Set the network number and protocol according to the settings for the Ethernet-equipped module. Set the station number so that it is not the same as a station number assigned to other Ethernet devices.)
4. Set the "PLC side I/F" to the module to be connected.

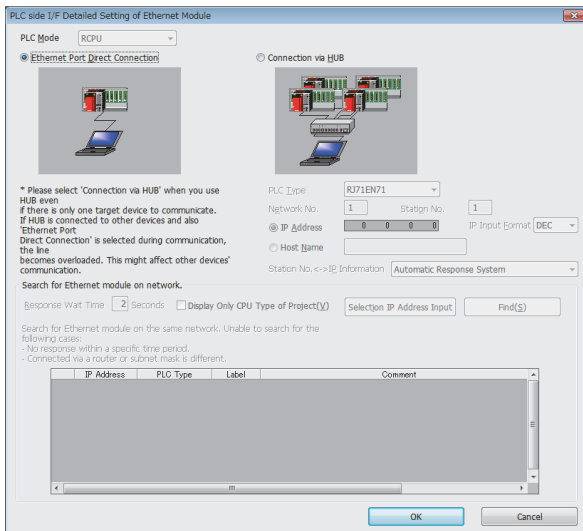

5. Double-click the icon set in step 4, and open the detailed setting window.
6. Select "Ethernet Port Direct Connection" for the connection method.



When connecting directly with the CPU module (built-in Ethernet port part), setting is also possible by clicking the [CPU Module Direct Coupled Setting] button of the "Specify Connection Destination Connection" window.

Precautions

■Connection with LAN line

Do not connect with a LAN line and set direct connection. Data will be sent to all external devices on the LAN line, so this setting will cause the line load to increase and will affect communication with other external devices.

■Connections that are not direct connections

- Do not use a configuration in which the Ethernet-equipped module and external device are connected with a hub. A direct connection is not established when the devices are connected with a hub.
- When creating a network connection on the personal computer side, communication with a direct connection is not possible if two or more Ethernet ports are set to "Enable". Review the personal computer settings so that only the Ethernet port for the direct connection is set to "Enable", and the other Ethernet ports are set to "Disable".

■Settings incompatible with direct connection

When using the RJ71EN71 or the RnENCPU (network part), a direct connection cannot be established if the following setting is made in the "Specify Connection Destination Connection" window of the engineering tool.

- When "Other Station (Co-existence Network)" is selected for "Other Station Setting"
- When "Other Station (Single Network)" is selected for "Other Station Setting", and "Other station in the same loop or access to multilevel system" is selected in the "Network Communication Route Detailed Setting of Ethernet" window

■Functions incompatible with direct connection

The following functions cannot be used when the RJ71EN71 or the RnENCPU (network part) is directly connected. To use the following functions, connect the CPU module (built-in Ethernet port part) directly or connect the CPU module with a USB cable.

- CC-Link IE Field Diagnostics
- CC-Link IE Control Diagnostics

■ Conditions that cannot communicate with direct connection

Communication with a direct connection may be disabled if the following conditions apply. If connection is not possible, review the settings for the Ethernet-equipped module and personal computer.

- When all bits of the IP address for the Ethernet-equipped module that correspond with the 0 section of the subnet mask for the personal computer are on or off

Ex.

IP address for the Ethernet-equipped module: 64.64.255.255

IP address for the personal computer: 64.64.1.1

Subnet mask for the personal computer: 255.255.0.0

- When all bits of the IP address for the Ethernet-equipped module that correspond with the host address of each class in the IP address for the personal computer are on or off

Ex.

IP address for the personal computer: 192.168.0.1 ← 192.x.x.x, class C and the host address is the fourth octet.

Subnet mask for the personal computer: 255.0.0.0

IP address for the Ethernet-equipped module: 64.64.255.255 ← each bit turns on because of the fourth octet is 255

Point

The IP address for each class are as follow.

- Class A: 0.x.x.x to 127.x.x.x
- Class B: 128.x.x.x to 191.x.x.x
- Class C: 192.x.x.x to 223.x.x.x

The host address for each class is the 0 section shown below.

- Class A: 255.0.0.0
 - Class B: 255.255.0.0
 - Class C: 255.255.255.0
-

1.2 SLMP Communications

SLMP communications are available among devices that can receive/send messages with the SLMP control procedure. The Ethernet-equipped module processes and transfers data following instructions (command) from the external device, so the programmable controller only needs the open/close processing and does not require a program for data communication. For SLMP communications, refer to the following.

 SLMP Reference Manual

Applications

This section describes the applications of SLMP communications.

Data read/write

Data read/write can be executed for the following data. With this, the external device can monitor the operation of the Ethernet-equipped module, analyze data, and control production.

- Device or global label of the CPU module connected with the RJ71EN71 (When the Ethernet function of the RJ71EN71 or the RnENCPU (network part) is used)
- Device or global label of the CPU module (When the Ethernet function of the CPU module (CPU part for the RnENCPU) is used)
- Buffer memory of the intelligent function module

File read/write

Files such as parameter files stored in a CPU module can be read/written. Files in a CPU module can be managed on an external device.

Remote control of a CPU module

A CPU module can be remotely controlled from the external device using remote operations.

Remote password lock/unlock

The remote password can be locked and unlocked from the external device.

Access to the programmable controller on another station via other network

In systems with CC-Link IE Controller Network, CC-Link IE Field Network, MELSECNET/H, MELSECNET/10 or Ethernet, the programmable controller on another station can be accessed from the external device via the network. However, when connecting the external device to the CPU module (built-in Ethernet port part), other stations cannot be accessed via network such as CC-Link IE Controller Network and CC-Link IE Field Network.

Point

Accessing to another station via the port 1 and port 2 of the RJ71EN71 is possible for the module with the firmware version of "18" or later.

Communication structure

When a message is sent from the external device to the Ethernet-equipped module using the SLMP message format, the Ethernet-equipped module executes a processing corresponding to the received message. During communication, the Ethernet-equipped module functions as a server and the external device (terminals such as a personal computer) functions as the client. The server (Ethernet-equipped module) automatically returns a response message suitable for the request message received from the client.

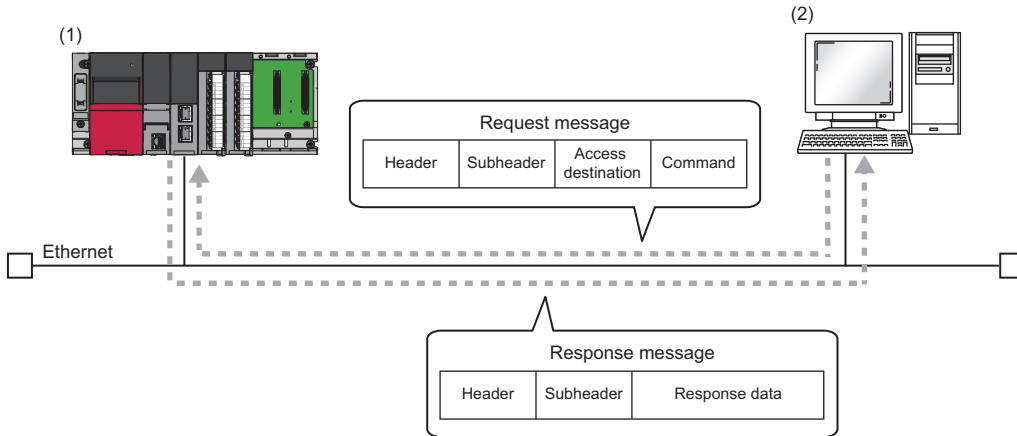

- (1) Server side: Ethernet-equipped module
- (2) Client side: External device

Point

- The simple CPU communication function enables reading from and writing to the external device that acts as the SLMP client.
 - ☞ Page 188 Simple CPU Communication Function (RJ71EN71, RnENCPU (Network Part))
 - ☞ Page 226 Simple CPU Communication Function (CPU Module (Built-in Ethernet Port Part))
- The Ethernet-equipped module can be used as the client by sending commands to the external device through the predefined protocol function.
 - ☞ Page 36 Communications Using the Predefined Protocol

Data communication procedures

This section describes the procedures for communicating with SLMP.

1. After the module parameters are set, the system checks that the initial processing of the Ethernet-equipped module has ended normally. ('Initial status' (Un\G1900024.0): On)
2. Perform the open processing to establish a connection between the Ethernet-equipped module and external device. (☞ Page 525 TCP/IP Communications, UDP/IP Communications)
3. After the connection is established, the SLMP messages are sent from the external device.
4. Close the connection when communication is finished.

Point

In the following case, the Ethernet-equipped module performs a remote password check when the external device is accessing the programmable controller. If communication is not possible, unlock the remote password. (☞ Page 183 Access permit processing (Unlock processing))

- When remote password is set for the CPU module.
- When connection for exchanging data with external device is set as a remote password check target.

Setting procedure

Set "External Device Configuration" under "Basic Settings". (📖 Page 320 External Device Configuration)

1. Select "SLMP Connection Module" in "Module List" and drag it to "List of devices" or "Device map area".
2. Set the other items to the connection if required.

Communications using an auto-open UDP port

The auto-open UDP port is used for communication with SLMP.

The auto-open UDP port is a UDP/IP port that automatically opens and closes at the following timing. When this port is used, communication is enabled when the initial processing is completed. Communication can be performed without a program regardless of the connection's open status.

■Open/close timing

After the Ethernet-equipped module initial processing completes, the port automatically opens according to the registered parameter settings. The port automatically closes when the power for the Ethernet-equipped module station turns off or is reset.

Point

- When the initial processing ends normally, the Ethernet-equipped module enables communications using an automatic open UDP port. The module waits for a communication request to the Ethernet-equipped module on the own station. (Automatic open)
- The Ethernet-equipped module accepts and processes requests from anywhere as long as they are addressed to the Ethernet-equipped module itself.
- If a communication request is received from an external device, the corresponding port number is occupied until that processing ends. Even if another communication request is accepted during this time, the communication processing will be waited.

List of valid commands

The following table lists the commands that can be executed from the external device to the Ethernet-equipped module.

"□" in the "Sub-command" field differs according to the specified device.

For details on each command, refer to the following.

 SLMP Reference Manual

Item		Command	Sub command	Description
Type	Operation			
Device	Read	0401	00□1	Reads value from the bit devices (consecutive device No.) in one-point units.
			00□0	<ul style="list-style-type: none"> Reads values from the bit device (consecutive device No.) in 16-point units. Reads value from the word devices (consecutive device No.) in one-word units.
			00□3	Reads value from the bit devices (consecutive device No.) in one-point units.
			00□2	<ul style="list-style-type: none"> Reads values from the bit device (consecutive device No.) in 16-point units. Reads value from the word devices (consecutive device No.) in one-word units.
	Write	1401	00□1	Writes value to the bit devices (consecutive device No.) in one-point units.
			00□0	<ul style="list-style-type: none"> Writes value to the bit devices (consecutive device No.) in 16-point units. Writes value to the word devices (consecutive device No.) in one-word units.
			00□3	Writes value to the bit devices (consecutive device No.) in one-point units.
			00□2	<ul style="list-style-type: none"> Writes value to the bit devices (consecutive device No.) in 16-point units. Writes value to the word devices (consecutive device No.) in one-word units.
	Read Random	0403	00□0	Specifies the device number and reads value from the word devices in one-word units or two-word units. This can be specified with inconsecutive device No.
			00□2	Specifies the device number and reads value from the word devices in one-word units or two-word units. This can be specified with inconsecutive device No.
	Write Random	1402	00□1	Specifies the device No. to bit device in one-point units and writes value. This can be specified with inconsecutive device No.
			00□0	<ul style="list-style-type: none"> Specifies the device No. to bit device in 16-point units and writes value. This can be specified with inconsecutive device No. Specifies the device No. to word device in one-word units or two-word units and writes value. This can be specified with inconsecutive device No.
			00□3	Specifies the device No. to bit device in one-point units and writes value. This can be specified with inconsecutive device No.
			00□2	<ul style="list-style-type: none"> Specifies the device No. to bit device in 16-point units and writes value. This can be specified with inconsecutive device No. Specifies the device No. to word device in one-word units or two-word units and writes value. This can be specified with inconsecutive device No.
	Entry Monitor Device	0801	00□0	Registers the device to be read by Execute Monitor (command: 0802).
			00□2	
	Execute Monitor	0802	0000	Reads the value of device registered by Entry Monitor Device (command: 0801).
	Read Block	0406	00□0	Reads data by treating n points of word devices or bit devices (one point is equivalent to 16 bits) as one block and specifying multiple blocks. This can be specified with inconsecutive device No.
			00□2	
	Write Block	1406	00□0	Writes data by treating n points of word devices or bit devices (one point is equivalent to 16 bits) as one block and specifying multiple blocks. This can be specified with inconsecutive device No.
00□2				
Label	Array Label Read	041A	0000	Reads data from array type labels or labels whose structure members are the array.
	Array Label Write	141A	0000	Writes data to array type labels or labels whose and structure members are the array.
	Read Random	041C	0000	Specifies labels and reads the data.
	Write Random	141B	0000	Specifies labels and writes data.
Memory	Read	0613	0000	Reads the buffer memory data of own station (SLMP-compatible device).
	Write	1613	0000	Writes the data in the buffer memory of own station (SLMP-compatible device).
Extend Unit	Read	0601	0000	Reads the data in the buffer memory of intelligent function module.
	Write	1601	0000	Writes the data in the buffer memory of intelligent function module.

Item		Command	Sub command	Description
Type	Operation			
Remote Control	Remote Run	1001	0000	Executes the remote RUN to the access destination module.
	Remote Stop	1002	0000	Executes the remote STOP to the access destination module.
	Remote Pause	1003	0000	Executes the remote PAUSE to the access destination module.
	Remote Latch Clear	1005	0000	Executes the Remote Latch Clear to the access destination module.
	Remote Reset	1006	0000	Executes the Remote RESET to the access destination module.
	Read Type Name	0101	0000	Reads the model name and model code of the access destination module.
Remote Password	Lock	1631	0000	Specifies the remote password to disable the communication with other devices. (The locked state is activated from the unlocked state.)
	Unlock	1630	0000	Specifies the remote password to enable communication with other devices. (The unlocked state is activated from the locked state.)
File	Read Directory/ File	1810	0040	Reads file list information.
	Search Directory/ File	1811	0040	Reads the presence of the specified file, file No., and file size.
	New File	1820	0040	Reserves storage area for the specified file.
	Delete File	1822	0040	Deletes a file.
	Copy File	1824	0040	Copies the specified file.
	Change File State	1825	0040	Changes file attributes.
	Change File Date	1826	0040	Changes the file creation date.
	Open File	1827	0040	Locks a file so that the content of the file is not changed by other devices.
	Read File	1828	0000	Reads the data of a file.
	Write File	1829	0000	Writes the contents in a file.
Close File	182A	0000	Cancels the file lock by open processing.	
Self Test		0619	0000	Tests whether the communication with external devices is normally executed or not.

Dedicated instructions

SLMP communications can be executed using the dedicated instructions. ( Page 521 Instruction for SLMP communications)

1.3 Communications Using the Predefined Protocol

Data can be exchanged between the external device (such as measuring instrument and bar code reader) and the CPU module following the protocol of the device.

Data that varies according to communication session can be handled by incorporating a device or buffer memory into the communication packet.

Sets the protocol required for communication with the external device using the engineering tool.

The protocol can be set by selecting from the predefined protocol library, or it can be created and edited.

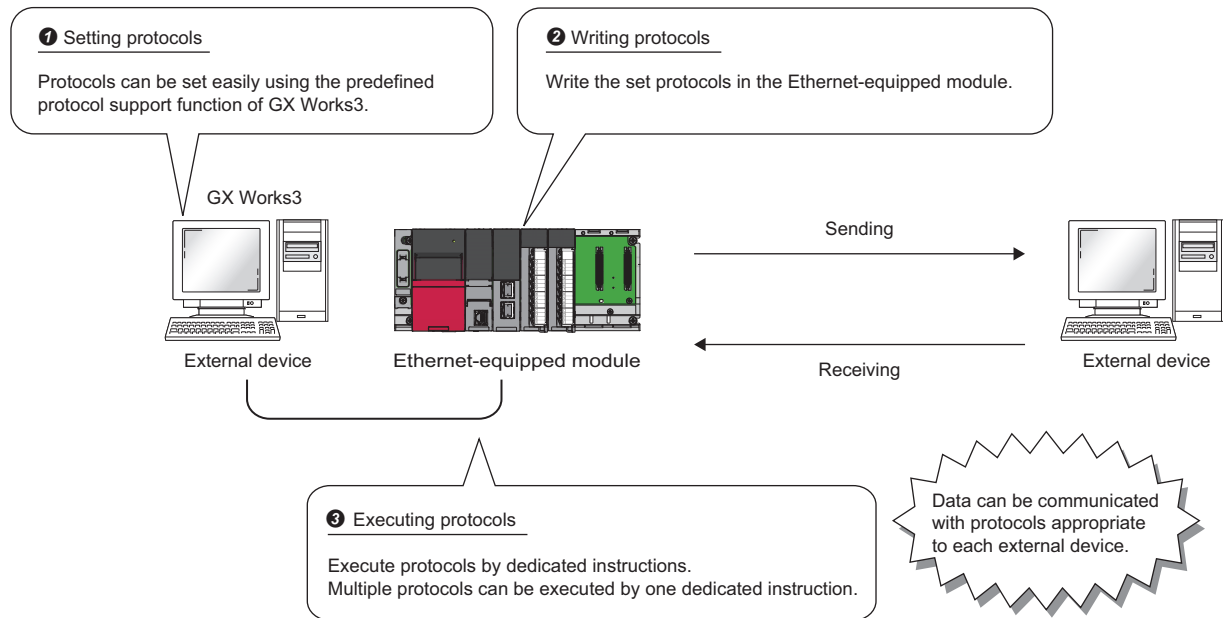

Point

The number of protocols and packets that can be registered is as follow.

- Protocols: 128 maximum
- Packets: 256 maximum
- Packet data area size: 12288 bytes maximum

When the number of packets reaches the upper limit, protocols cannot be added even if the number of protocols has not reached the upper limit. If the packet data area size reaches the upper limit, protocols and packets cannot be added even if the number of protocols and packets has not reached the upper limit.

Applicable connections

The connections No.1 to 16 of the P1 connector can be used for the communications using the predefined protocol.

Communications using the predefined protocol cannot be used with the P2 connector.

Point

- When two or more ECPRTCL instructions are executed at the same time for the same connection, the later instruction is ignored and not executed until the earlier instruction is completed.
- When, for a pairing-set connection, two or more ECPRTCL instructions are executed at the same time by specifying a pair of two different connections, the later instruction is completed with an error until the earlier instruction is completed.

Data communication procedures

When the predefined protocol support function is used, data can be exchanged with the external device using the following procedure.

1. Select, create or edit the protocol with the predefined protocol support function, and write the protocol setting data. (☞ Page 37 Creating the protocol setting data)
2. Set the module parameter. (☞ Page 44 Setting procedure)
3. Write the parameters to the CPU module, and check that initial processing of the Ethernet-equipped module completed successfully. ('Initial status' (Un\G1900024.0): On)
4. Perform the open processing to establish a connection between the Ethernet-equipped module and external device. (☞ Page 525 TCP/IP Communications, UDP/IP Communications)
5. Execute the protocol with the ECPRTCL instruction. (☞ Page 522 Instructions for predefined protocol communications)
6. Close the connection when communication is finished.

Point

The communication data code is binary code communication regardless of the selected settings.

Creating the protocol setting data

Use the predefined protocol support function to create the protocol setting data.

☞ [Tool] ⇒ [Predefined Protocol Support Function]

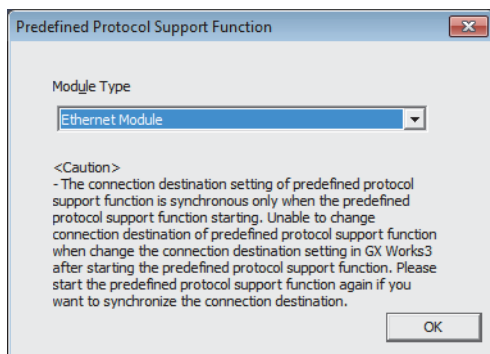

1. Select the module for which to create the protocol setting data. Select the following items when using the RnENCPU.
 - CPU part: "Built-in Ethernet CPU"
 - Network part: "Ethernet Module"

■ Newly creating the protocol setting data

Newly create the protocol setting data.

 [File] ⇨ [New]

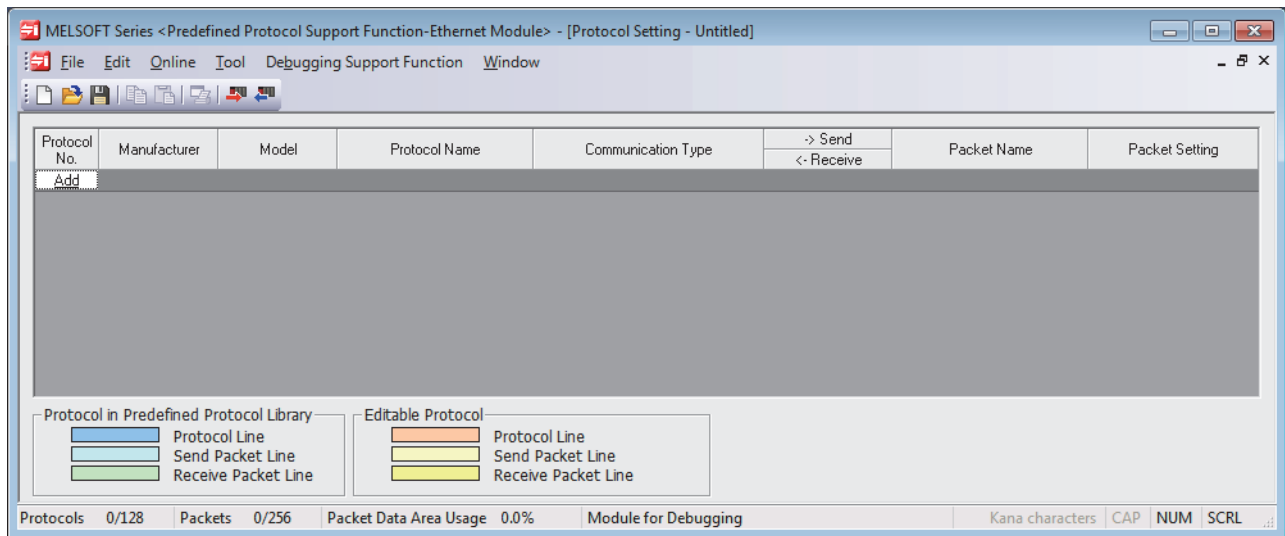

Item	Description
Protocol No.	Displays the protocol number used with the dedicated instruction in the program.
Manufacturer	Displays the name of the manufacturer of the device for which the protocol is being set.
Model	Displays the model of the protocol to be set.
Protocol Name	Displays the name of the protocol to be set.
Communication Type	Displays the communication type of the protocol to be set. Send Only: Sends one send packet once. Receive Only: If there is a matching packet up to 16 registered and received packets, it is received. Send & Receive: After sending one send packet, if there is a matching packet up to 16 registered and received packets, it is received.
→Send/←Receive	Displays the packet send direction. →: For send ←(1) to (16): For receive, the received packet number is displayed in parentheses.
Packet Name	Displays the packet name.
Packet Setting	Displays the validity of variables in the packet elements and the variable setting state. If the variable is not set, there are no elements, or there is an element error, the protocol is not written to the Ethernet-equipped module. No Variable: When there is no variable in the elements Variable Set: Only when all variables have been set Variable Unset: When there is even one unset variable Element Unset: When there are no elements in an editable protocol Element error: When elements do not satisfy requirements

■ Adding protocol

Add protocol.

 [Edit] ⇔ [Add Protocol]

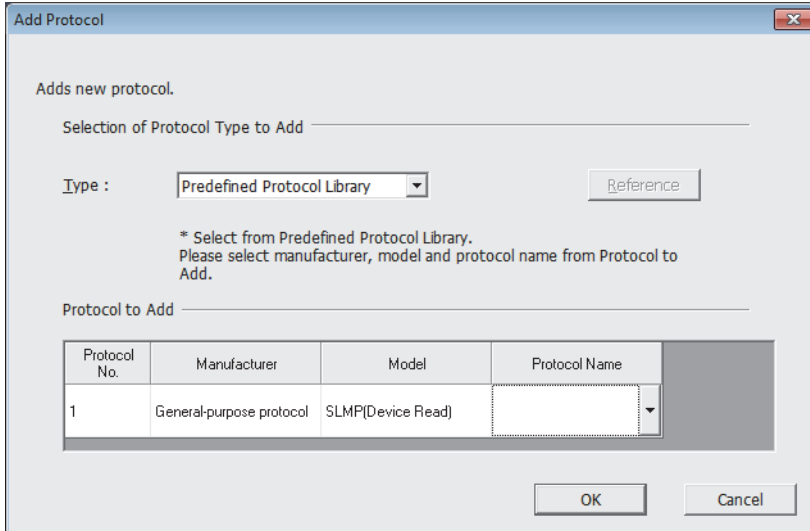

Item	Description	Setting range
Type	Select the type of protocol to be added.	<ul style="list-style-type: none"> • Predefined Protocol Library • User Protocol Library • Add New
Protocol No.	Select the protocol number to be added.	1 to 128
Manufacturer* ¹	Set the maker of the protocol to be added.	—
Model* ¹	Set the type of protocol to be added.	—
Protocol Name* ¹	Set the name of the protocol to be added.	—

*¹ The name can be set only when "Predefined Protocol Library" is selected for "Type".

■ Protocol Detailed Setting

Set the protocol send/receive parameters.

 "Protocol Setting" window ⇒ Select a protocol ⇒ [Edit] ⇒ [Protocol Detailed Setting]

Item	Description	
Connected Device Information ^{*1}	Manufacturer	Set the protocol maker name.
	Type	Set the protocol device type.
	Model	Set the protocol model.
	Version	Set the protocol device version.
	Explanation	Set a description of the protocol device.
Protocol Setting Information ^{*1}	Protocol No.	The protocol number for the selected protocol is displayed.
	Protocol Name	Set the protocol name.
	Communication Type	Set the protocol communication type.
Receive Setting	Receive Wait Time	Set the time for wait after the module enters the receive data wait state. If communication with the external device is disabled because of a disconnection and matching packet data is not received within the specified time, the module judges that an error has occurred and cancels the receive data wait state.
Send Setting	Standby Time	Set the time to wait from when the protocol set for the module enters the execution state to when the data is actually sent. The time for the external device to enter the receive enable state can be adjusted with this in respect to the module's send timing.

*1 The setting cannot be changed if the protocol was selected from the predefined protocol library.

Point

Send/receive parameters can be set for multiple protocols by clicking the [Communication Parameter Batch Setting] button and setting the range of the set protocol numbers, receive settings, and send settings.

■ Packet setting

Set the configuration of the send/receive packets on the "Packet Setting" window.

 "Protocol Setting" window ⇒ Packet to be set

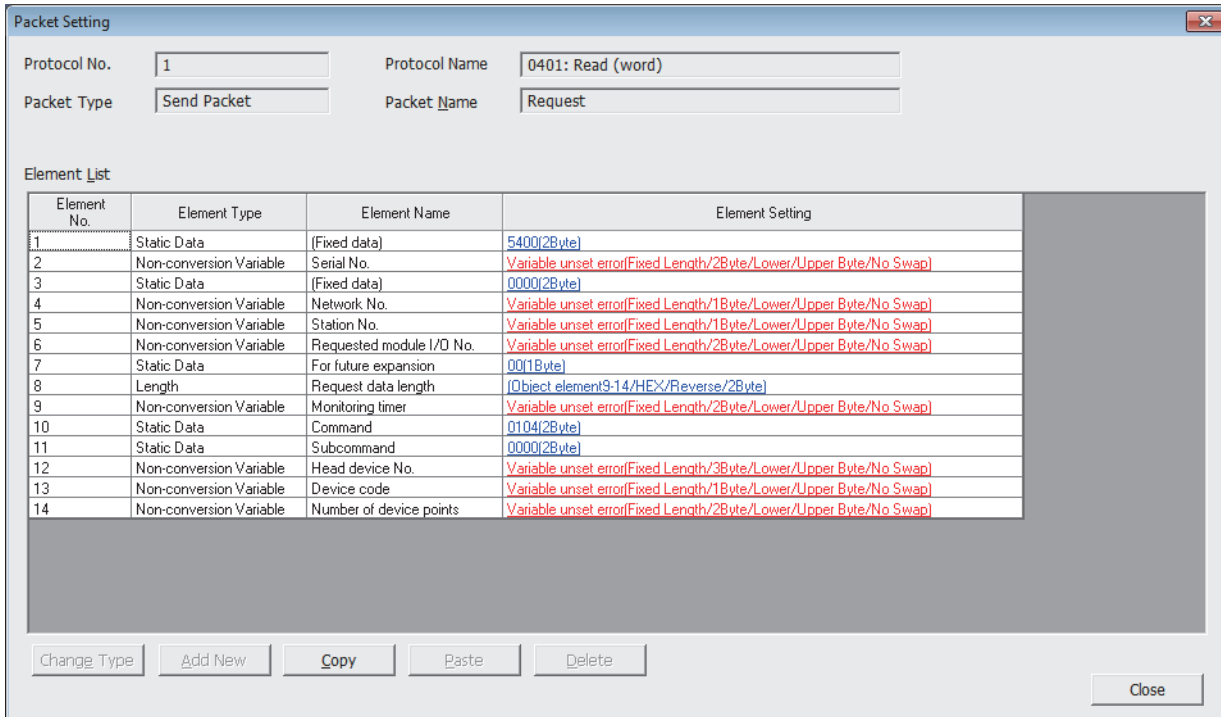

Element No.	Element Type	Element Name	Element Setting
1	Static Data	(Fixed data)	5400(2Byte)
2	Non-conversion Variable	Serial No.	Variable unset errorFixed Length/2Byte/Lower/Upper Byte/No Swap
3	Static Data	(Fixed data)	0000(2Byte)
4	Non-conversion Variable	Network No.	Variable unset errorFixed Length/1Byte/Lower/Upper Byte/No Swap
5	Non-conversion Variable	Station No.	Variable unset errorFixed Length/1Byte/Lower/Upper Byte/No Swap
6	Non-conversion Variable	Requested module I/O No.	Variable unset errorFixed Length/2Byte/Lower/Upper Byte/No Swap
7	Static Data	For future expansion	00(1Byte)
8	Length	Request data length	{Object element9-14/HEX/Reverse/2Byte}
9	Non-conversion Variable	Monitoring timer	Variable unset errorFixed Length/2Byte/Lower/Upper Byte/No Swap
10	Static Data	Command	0104(2Byte)
11	Static Data	Subcommand	0000(2Byte)
12	Non-conversion Variable	Head device No.	Variable unset errorFixed Length/3Byte/Lower/Upper Byte/No Swap
13	Non-conversion Variable	Device code	Variable unset errorFixed Length/1Byte/Lower/Upper Byte/No Swap
14	Non-conversion Variable	Number of device points	Variable unset errorFixed Length/2Byte/Lower/Upper Byte/No Swap

The above window opens when "Predefined Protocol Library" is selected on the "Add Protocol" window.

When "Add New" or "User Protocol Library" has been selected, configure the packets with the [Change Type] button and [Add New] button.

For details on the packet elements, refer to the following.

 Page 46 Packet elements

■ Writing the protocol setting data

Write the protocol setting data to the Ethernet-equipped module.

 [Online] ⇒ [Write to Module]

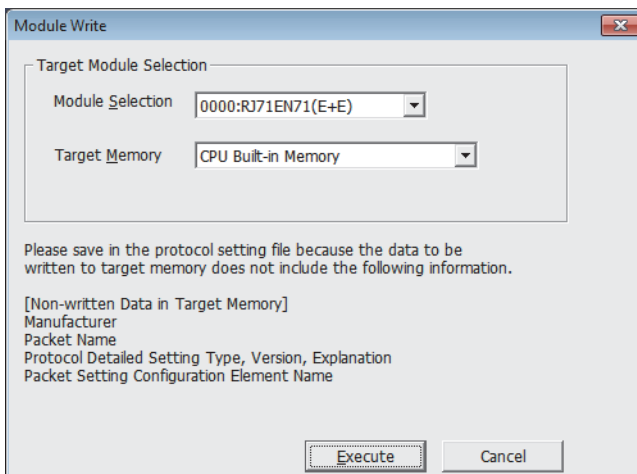

Target Module Selection

Module Selection: 0000:RJ71EN71(E+E)

Target Memory: CPU Built-in Memory

Please save in the protocol setting file because the data to be written to target memory does not include the following information.

[Non-written Data in Target Memory]
 Manufacturer
 Packet Name
 Protocol Detailed Setting Type, Version, Explanation
 Packet Setting Configuration Element Name

Execute Cancel

Select the module and memory into which the protocol data is to be written, and execute write.

When writing to a CPU module, the protocol setting data is written into the module extension parameters.

Point 

The following data is not written as the protocol setting data so it will not be displayed even when read. However, when the protocol is selected from the predefined protocol library, the following can be displayed.

- Manufacturer
 - Packet Name
 - Protocol Detailed Setting Type, Version, Explanation
 - Packet Setting Configuration Element Name
-

After writing the protocol setting data, the setting data are enabled at the following timing.

- When the system is powered off and on
- When the CPU module is reset
- When the status of the CPU module changed from STOP to RUN state

The predefined protocol settings written in the SD memory card can be transferred to the CPU module memory by using boot operation. For details on boot operation, refer to the following.

📖 MELSEC iQ-R Programmable Controller CPU Module User's Manual

📖 MELSEC iQ-R Process CPU Module User's Manual

■When the protocol setting data are written into multiple target memory

When the protocol setting data are written into multiple target memory, the following operation will take place.

○: The protocol setting data are written., ×: The predefined protocol data are not written.

Target memory			Operation
CPU module (built-in Ethernet port part)	SD memory card	RJ71EN71, RnENCPU (network part)	
○	○	×	Operation follows settings in "Module Extended Parameter" under "Setting of File/Data Use or Not in Memory Card" of the "Memory Card Parameter" window.
○	×	○	As soon as the protocol setting data are enabled, the predefined protocol settings of the RJ71EN71 or the RnENCPU (network part) are overwritten by the predefined protocol settings in the CPU module or SD memory card.
×	○	○	
○	○	○	Operation follows settings in "Module Extended Parameter" under "Setting of File/Data Use or Not in Memory Card" of the "Memory Card Parameter" window. As soon as the protocol setting data are enabled, the predefined protocol settings of the RJ71EN71 or the RnENCPU (network part) are overwritten by the predefined protocol settings in the CPU module or SD memory card.

Point 🔍

By writing the protocol setting data to the CPU built-in memory, the same setting can be used even after module change.

When capacity of the CPU built-in memory is insufficient, write data to an SD memory card.

Although the protocol setting data can also be written to the intelligent function module, the data must be written again when the module is changed.

Setting procedure

Set "External Device Configuration" under "Basic Settings". ( Page 320 External Device Configuration)

1. Select the external device to be connected in "Module List" and drag it to "List of devices" or "Device map area".

External device name	Description
UDP Connection Module	Select to communicate with the external device using UDP/IP.
Active Connection Module	Select to perform the open processing to the external device from the Ethernet-equipped module (Active open) and communicate using TCP/IP.
Unpassive Connection Module	Select to receive the open processing from an unspecified external device (Unpassive open) and communicate using TCP/IP.
Fullpassive Connection Module	Select to receive the open processing from the specified external device (Fullpassive open) and communicate using TCP/IP.

2. Set "Communication Method" for the external device to "Predefined Protocol".
3. Set the other parameters required for communication in the connection.

Protocol communication type

The packets sent to the external device when a processing is executed and the external device's receive packets are registered in the protocol.

The packet elements set with the predefined protocol support function are the data section of the packets that are actually sent and received.

This section describes an example of the packet configuration. For details on the packet elements, refer to the following.

☞ Page 552 Operation Image and Data Structure of Predefined Protocol

For TCP/IP

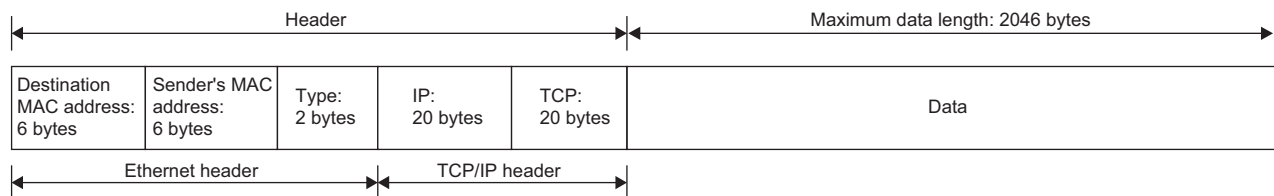

■Precautions for Passive open

- When the CPU module is connected to external device in Passive open state, the IP address of the connected external device or port number of the external device can be obtained with the SP.SOCCINF instruction. (☞ Page 522 Instructions for predefined protocol communications)

For UDP/IP

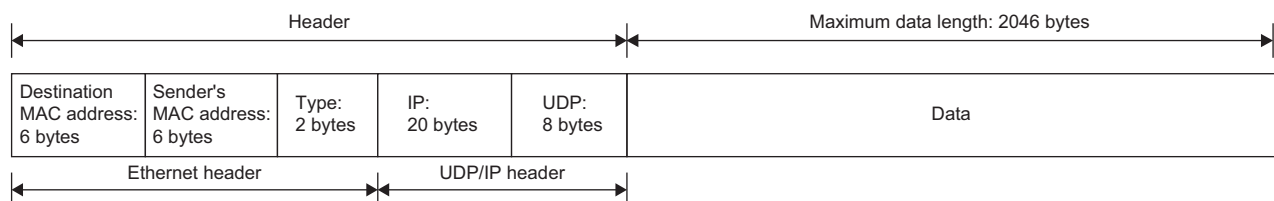

With the predefined protocol support function, data is exchanged with the external device with the procedures (communication type) shown below.

For details on the communication type operation, refer to the following.

☞ Page 552 Operation Image and Data Structure of Predefined Protocol

Communication type	Description
Send Only	The send packet is sent once.
Receive Only	If there is a packet that matches within the maximum of 16 registered receive packets, the packet is received.
Send & Receive	After sending the send packets, if there are packets that match the up to 16 registered receive packets, the packets are received.

■Precautions for UDP/IP communications

- Use the SP.SOCCSET instruction to change the external device by the CPU module. (☞ Page 522 Instructions for predefined protocol communications)

■Precautions for broadcast communications

- When the CPU module receives data by receiving the broadcast, the IP address of the external device which send data and port number of the external device can be obtained with the SP.SOCCINF instruction. (☞ Page 522 Instructions for predefined protocol communications)

Packet elements

The packet is created with a combination of packet elements.

Up to 32 elements can be set in one packet. One packet can have a maximum data length of 2046.

This section describes the details of the packet elements.

For examples of the packet element data, refer to the following.

☞ Page 552 Operation Image and Data Structure of Predefined Protocol

Static data

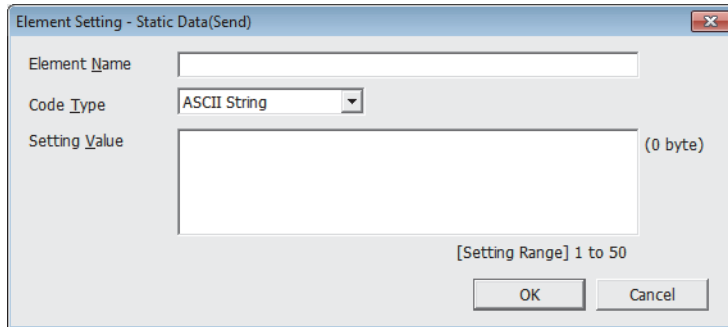

Use when there are specific codes and character strings, such as commands, in the packet.

- When sending: The specified code and character string are sent.
- When receiving: The received data is verified.

Multiple static data elements can be placed anywhere in the data part.

The following table lists the items.

Item	Description	Remarks
Element Name	Set the element name.	—
Code Type	Select a data type of the setting value. ASCII String/ASCII Control Code/HEX	—
Setting Value	Set data within 1 to 50 bytes. Code type and setting range are as follows: <ul style="list-style-type: none"> • ASCII String: 20H to 7EH • ASCII Control Code: Control code of 00H to 1FH and 7FH • HEX: Hexadecimal data of 00H to FFH 	Setting example ASCII string: "ABC" ASCII control code: STX HEX: FFFF

Length

The length code is used when there is an element that indicates the data length in the packet.

- When sending: Automatically calculates the data length in the specified range, and adds it to the packet.
- When receiving: From the received data, the data (value) corresponding to the length is verified as the specified range's data length.

Length elements can be placed anywhere in the data part.

Multiple length elements can be set placed in one packet.

The following table lists the items.

Item	Description	Remarks	
Element Name	Set the element name.	—	
Code Type	Select the data length type. ASCII Hexadecimal/HEX	—	
Data Length	Select the data length on the line. The range is 1 to 4 bytes.	—	
Data Flow	Forward Direction (Upper Byte → Lower Byte)	When sending: Sends the calculated length in order from the upper byte. When receiving: Receives the data in order from the upper byte.	This cannot be set if the data length is 1 byte.
	Reverse Direction (Lower Byte → Upper Byte)	When sending: Sends the calculated length in order from the low-order byte. When receiving: Receives the data in order from the low-order byte.	
	Byte Swap (by Word)*1	When sending: Interchanges the bytes in word units and sends the calculated length. When receiving: Interchanges the bytes in word units and receives the data.	
Calculating Range	Start	Select the start packet element number for the range to be calculated. The range is 1 to 32.	—
	End	Select the end packet element number for the range to be calculated. The range is 1 to 32.	

*1 This can be selected only when the data length is set to 4 bytes.

-
- If there are no elements other than length, an element error occurs. (When using length, one or more elements other than length are required.)
 - If the calculation result exceeds the number of digits set with "Data Length", the excessive digit value is discarded (invalidated). For example, if the data length is 2 bytes and the data size calculation results are "123" bytes, the data length will be "23".
 - If there is a non-conversion variable (variable length)/non-verified reception (character length variable) after the length, and that section is not included in the length calculating range, arrange the static data immediately after the non-conversion variable/non-verified reception.
 - When the code type setting is "ASCII Hexadecimal", a mismatch will occur if a character string other than "0" to "9", "A" to "F", and "a" to "f" is received.
 - Use "0" to "9" or "A" to "F" when converting to ASCII characters during send.
 - When arranging multiple length elements, none of the length calculating range may overlap.
 - When arranging multiple length elements, the previous length calculating range may not exceed the arranged length.
 - A length element cannot be arranged at the final position of the packet elements.
-

Non-conversion variable

Use this to send the CPU module device or buffer memory data as part of the send packet, or to store part of the received packet in the CPU module device or buffer memory.

Multiple non-conversion variable can be arranged in one packet.

The following table lists the items.

Item	Description	
Element Name	Set the element name.	
Fixed Length/Variable Length	Fixed Length	The data whose length is fixed is sent and received.
	Variable Length	When sending: The data length is specified at the time of the protocol execution and the data is sent. When receiving: The data whose length is variable is received.
Data Length/Maximum Data Length	Set the data length of the send/receive data. (For a variable length, set the maximum data length that can be specified for the data length storage area.) The range is 1 to 2046.	
Unit of Stored Data	Lower Byte + Upper Byte	When sending: Each one word (2 bytes) data in the data storage area is sent in the order of the lower byte to the upper byte. When receiving: The receive data is stored to the data storage area in the order of the lower byte to the upper byte.
	Lower Bytes Only	When sending: Each lower byte data in the data storage area is sent. The Ethernet-equipped module ignores the upper byte data. When receiving: The receive data is stored to each lower byte in the data storage area. The Ethernet-equipped module stores 00H in the upper byte.
Byte Swap	Disable (Lower → Upper)/Enable (Upper → Lower)	When sending: When "Enable (Upper → Lower)" is selected, data in the upper byte and lower byte are swapped by one word (2 bytes) and sent. When "Unit of Stored Data" is "Lower Byte + Upper Byte" and "Data Length" is an odd number of bytes, the upper byte is sent at transmission of the last byte. When "Unit of Stored Data" is "Lower Bytes Only" and "Data Length" is an odd number of bytes, data without any byte swap is sent at transmission of the last byte. When receiving: When "Enable (Upper → Lower)" is selected, data in the upper byte and lower byte are swapped by word and sent. When "Unit of Stored Data" is "Lower Byte + Upper Byte" and "Data Length" is an odd number of bytes, the last byte is stored to the upper byte. When "Unit of Stored Data" is "Lower Bytes Only" and "Data Length" is an odd number of bytes, the last byte is stored without any byte swap.

Item	Description
Data Storage Area Specification	Specify the start device for storing the variable value. The settable devices are listed below. Inner user ^{*1*2} <ul style="list-style-type: none"> • Input (X) • Output (Y) • Internal relay (M) • Latch relay (L) • Link relay (B) • Data register (D) • Link register (W) File register ^{*2} <ul style="list-style-type: none"> • File register (R, ZR) Buffer memory <ul style="list-style-type: none"> • G device (G) ('Send/receive area for predefined protocol support function' (Un\G1902000 to Un\G1904047))^{*3*4}

*1 Do not set local devices.

*2 Set within the device range specified with "Device/Label Memory Area Setting" in "Memory/Device Setting" of "CPU Parameter".

*3 This cannot be set if the target module is a CPU module.

*4 Un\G18432 to Un\G20479 if the RJ71EN71 network type is set to "Q Compatible Ethernet".

The following figures show the configuration of the data storage area.

■When "Fixed Length/Variable Length" is "Fixed Length"

The area after the device number specified on the "Element Setting" window becomes the data storage area.

The occupied data storage area differs according to the "Unit of Stored Data".

- When "Lower Byte + Upper Byte" is selected, the same size as the data length is occupied. (However, when the data length of a send packet is an odd number, the upper byte (lower byte for "Byte Swap") of the end device is not sent. When the data length of a receive packet is an odd number, the last data is stored with one byte of 00H.)
- When "Lower Bytes Only" is selected, a size double the data length is occupied.

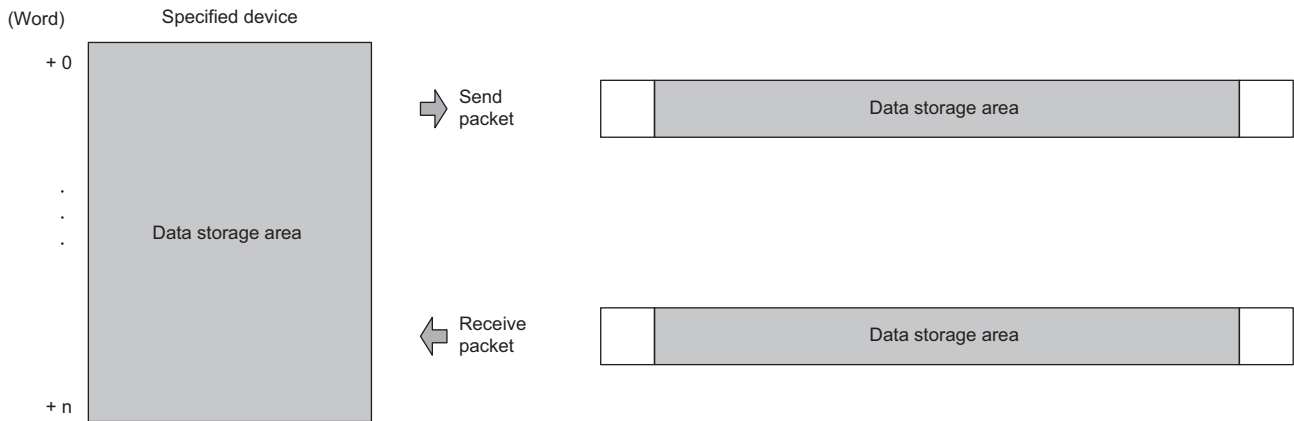

For send packet: Send data is stored by the program

For receive packet: Receive data is stored by the Ethernet-equipped module

■When "Fixed Length/Variable Length" is "Variable Length"

The area after the device number specified on the "Element Setting" window + 1 becomes the data storage area.

The occupied data storage area differs according to the "Unit of Stored Data".

- When "Lower Byte + Upper Byte" is selected, the same size as the data length + one word (length for the data length storage area) are occupied. (However, when the data length of a send packet is an odd number, the upper byte (lower byte for "Byte Swap") of the end device is not sent. When the data length of a receive packet is an odd number, the last data is stored with one byte of 00H.)
- When "Lower Bytes Only" is selected, a size double the data length + one word (for data length storage area) is occupied.

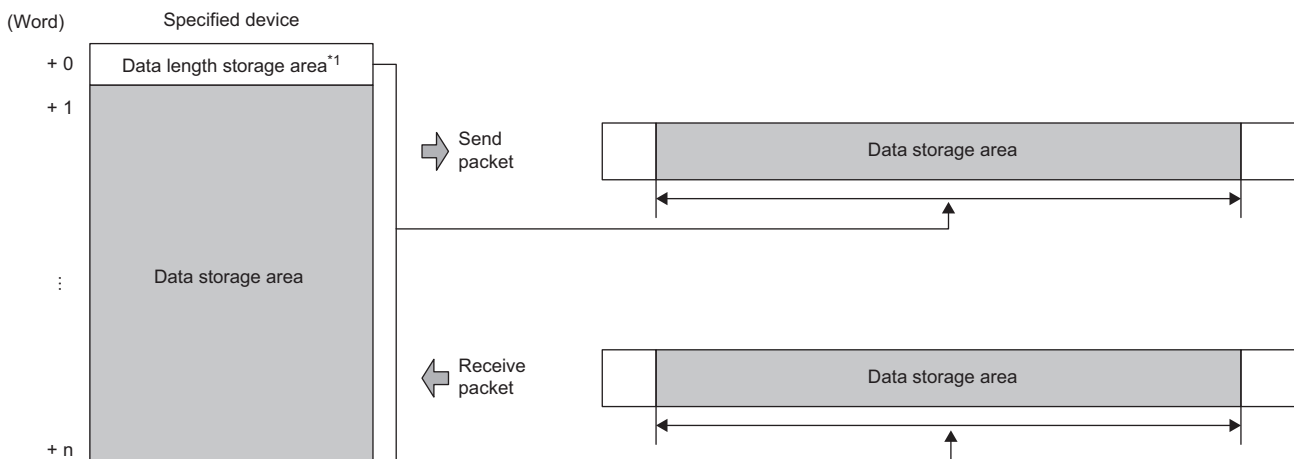

For send packet: Send data is stored by the program

For receive packet: Receive data is stored by the Ethernet-equipped module

*1 The data length unit is byte fixed

When "Fixed Length/Variable Length" is "Variable Length" and the configuration is set as follows, an error occurs:

- An element other than static data is placed behind a non-conversion variable element when non-conversion variable is out of the length calculating range or when there is no length element (except for when non-conversion variable is placed at the end of the packet elements).
- Multiple non-conversion variable elements are placed in the length calculating range, while a length element is not placed.
- A non-conversion variable element is placed before a length element in the length calculating range.

Non-verified reception

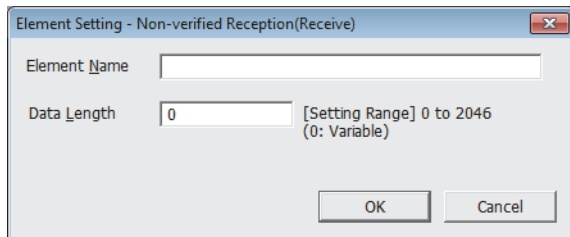

Use this when receive data include unnecessary data.

If the receive packet contains non-verified reception, Ethernet-equipped module skims over the specified number of characters.

Multiple non-verified reception elements can be set in one packet.

The following table lists the items.

Item	Description	Remarks
Element Name	Set the element name.	—
Data Length	0 (Number of characters variable)	Set when the number of characters that are not verified differs between each communication session.
	1 to 2046 (number of character specification)	Set the number of characters that are not verified.

When "Data Length" is set to 0, an error will occur if the following layout is used.

- An element other than static data is placed behind a non-verified reception element when non-verified reception is out of the length calculating range or when there is no length element (except for when non-verified reception is placed at the end of the packet elements).
- Multiple non-verified reception elements are placed in the length calculating range, while a length element is not placed.
- A non-verified reception element is placed before a length element in the length calculating range.

Execution conditions of predefined protocol communications

The predefined protocol communications can be executed when 'Predefined protocol ready' (Un\G1901002.0) is on. This section describes the operation of 'Predefined protocol ready' (Un\G1901002.0).

When the system is powered on or reset

If protocol setting data is written in, the Ethernet-equipped module checks the protocol setting data when the system is powered on or reset.

If the protocol setting data is normal, the Ethernet-equipped module turns on 'Predefined protocol ready' (Un\G1901002.0), and enables execution of the protocol.

'Predefined protocol ready' (Un\G1901002.0) is used as the interlock signal for executing the protocol.

If the protocol setting data is abnormal, 'Predefined protocol ready' (Un\G1901002.0) stays off, and the details of the error are stored in 'Predefined protocol setting data check area' (Un\G1901020 to Un\G1901047).

If protocol setting data is not written in, the protocol setting data is not checked, and 'Predefined protocol ready' (Un\G1901002.0) remains off.

Whether the protocol setting data is registered or not can be checked with 'Number of registered predefined protocols' (Un\G1901024) and 'Predefined protocol registration' (Un\G1901032 to Un\G1901047).

■When protocol setting data is normal

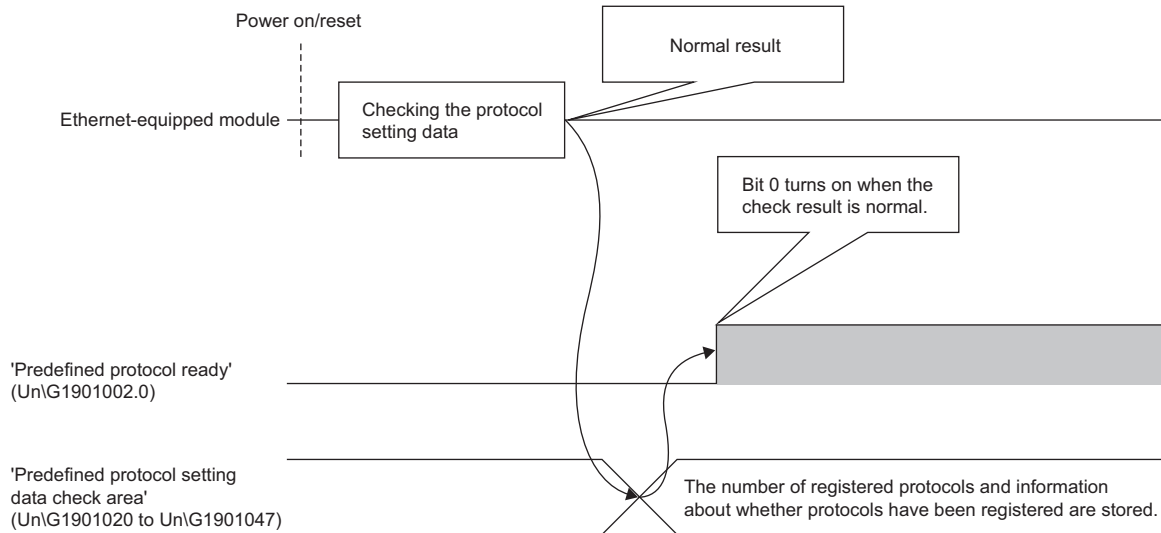

■When protocol setting data is abnormal

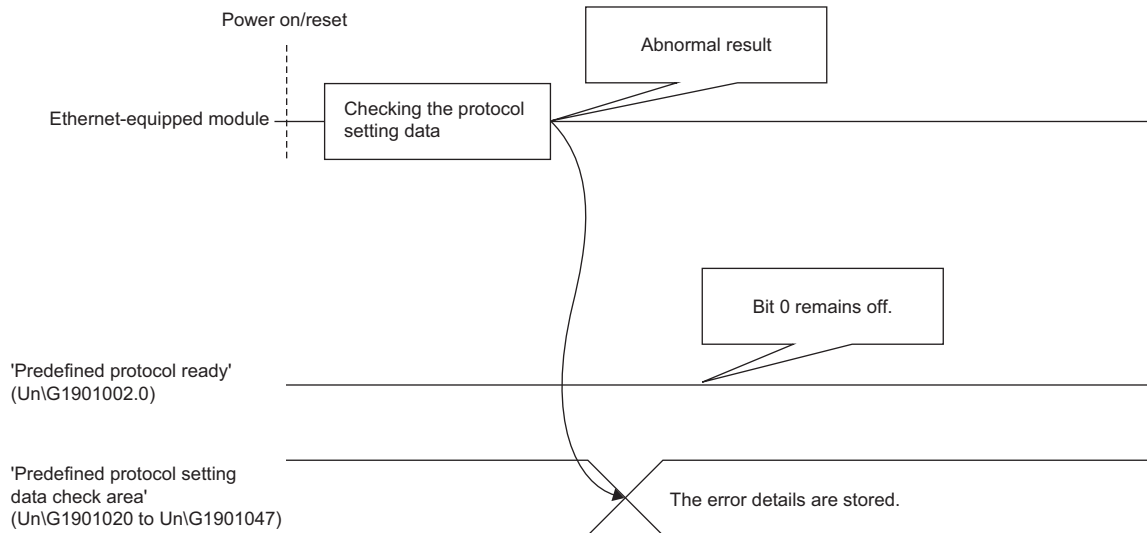

When executing UINI instruction

When the RJ71EN71 network type is set to "Q Compatible Ethernet" and the UINI instruction is executed, the protocol setting data will not be checked.

Predefined protocol ready maintains the state before the UINI instruction was executed.

Example of predefined protocol communications

This section describes an example of predefined protocol communications using UDP/IP.

System configuration

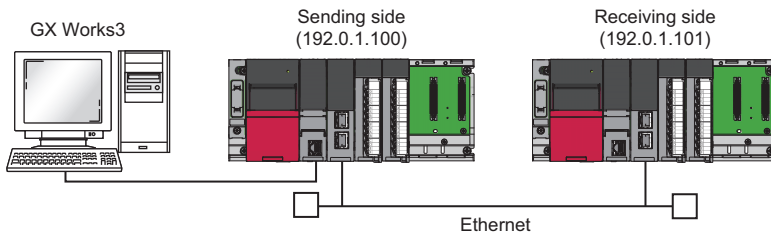

Parameter settings

Connect the engineering tool to the CPU module and set the parameters.

■ Sending side

1. Set the CPU module as follows.

[Project] ⇒ [New]

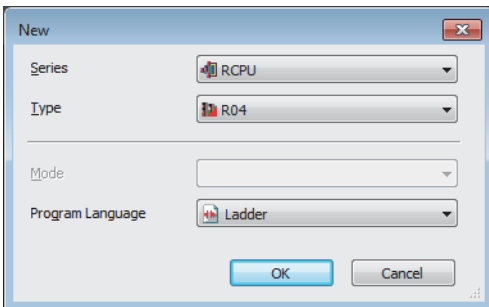

2. Click the [Setting Change] button in the following window and set the item to use module labels.

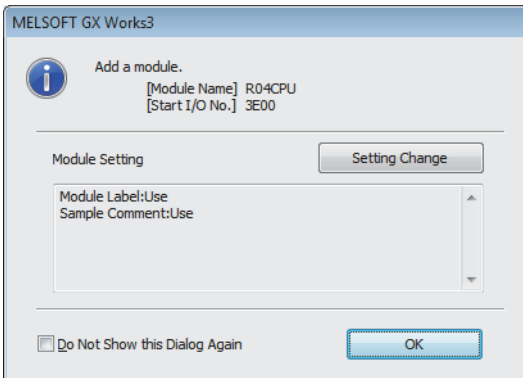

3. Click the [OK] button to add the module labels of the CPU module.

4. Set the RJ71EN71 as follows.

[Navigation window] ⇒ [Parameter] ⇒ [Module Information] ⇒ Right-click ⇒ [Add New Module]

5. Click the [OK] button to add the module labels of the RJ71EN71.

6. Set the items in "Basic Settings" as follows.

[Navigation window] ⇒ [Parameter] ⇒ [Module Information] ⇒ [RJ71EN71] ⇒ [Port 1 Module Parameter (Ethernet)] ⇒ [Basic Settings]

Item	Setting
Own Node Settings	
Parameter Setting Method	Parameter Editor
IP Address	
IP Address	192 . 0 . 1 . 100
Subnet Mask	. . .
Default Gateway	. . .
Communications by Network No./Station No.	Disable
Setting Method	Use IP Address
Network Number	----
Station No.	----
Transient Transmission Group No.	0
Enable/Disable Online Change	Disable All (SLMP)
Communication Data Code	Binary
Opening Method	Do Not Open by Program
External Device Configuration	
External Device Configuration	<Detailed Setting>

7. Set the network configuration as follows.

[Navigation window] ⇒ [Parameter] ⇒ [Module Information] ⇒ [RJ71EN71] ⇒ [Port 1 Module Parameter (Ethernet)] ⇒ [Basic Settings] ⇒ [External Device Configuration]

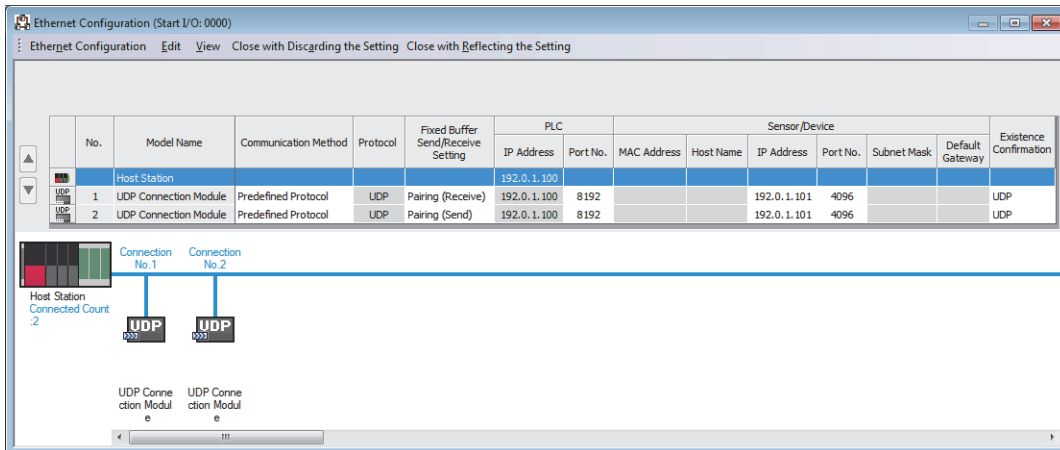

8. Start the predefined protocol support function.

[Tool] ⇒ [Predefined Protocol Support Function]

9. Select "Ethernet Module" for "Module Type" and click the [OK] button.

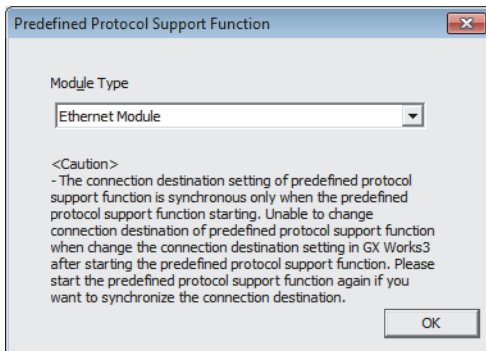

10. Newly create the protocol setting.

[File] ⇒ [New]

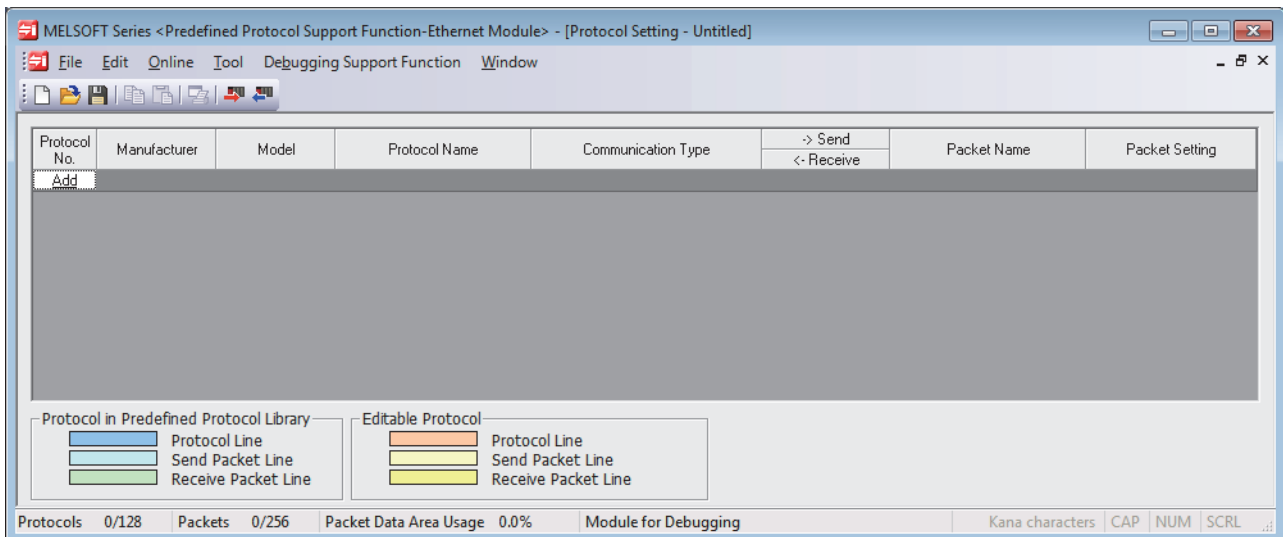

11. Set the protocol as follows.

 [Edit] ⇨ [Add Protocol]

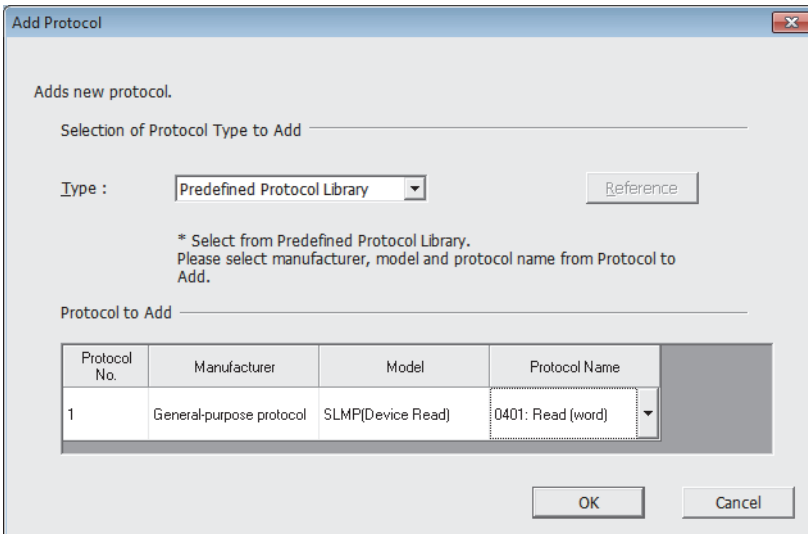

Adds new protocol.

Selection of Protocol Type to Add _____

Type :

* Select from Predefined Protocol Library.
Please select manufacturer, model and protocol name from Protocol to Add.

Protocol to Add _____

Protocol No.	Manufacturer	Model	Protocol Name
1	General-purpose protocol	SLMP(Device Read)	0401: Read (word)

12. Set each packet as follows.

 "Protocol Setting" window ⇨ Packet to be set

- Request

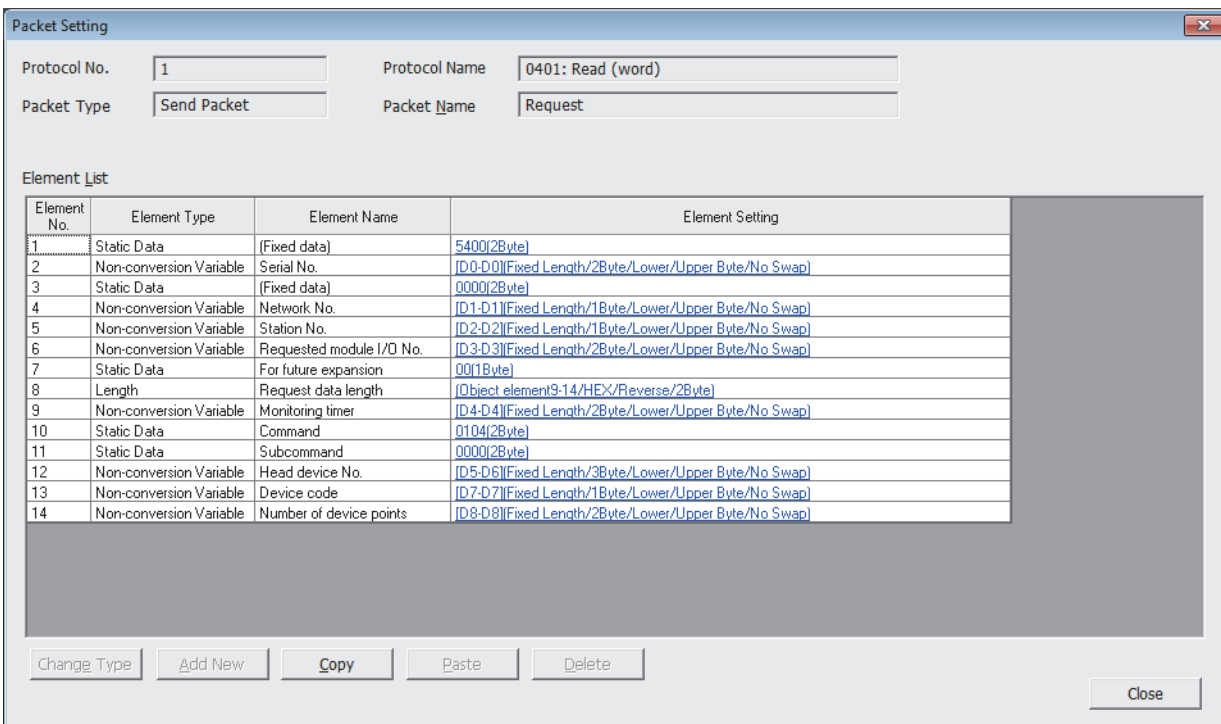

Protocol No. Protocol Name

Packet Type Packet Name

Element List

Element No.	Element Type	Element Name	Element Setting
1	Static Data	(Fixed data)	5400(2Byte)
2	Non-conversion Variable	Serial No.	[D0-D0]Fixed Length/2Byte/Lower/Upper Byte/No Swap
3	Static Data	(Fixed data)	0000(2Byte)
4	Non-conversion Variable	Network No.	[D1-D1]Fixed Length/1Byte/Lower/Upper Byte/No Swap
5	Non-conversion Variable	Station No.	[D2-D2]Fixed Length/1Byte/Lower/Upper Byte/No Swap
6	Non-conversion Variable	Requested module I/O No.	[D3-D3]Fixed Length/2Byte/Lower/Upper Byte/No Swap
7	Static Data	For future expansion	001(Byte)
8	Length	Request data length	[Object element9-14/HEX/Reverse/2Byte]
9	Non-conversion Variable	Monitoring timer	[D4-D4]Fixed Length/2Byte/Lower/Upper Byte/No Swap
10	Static Data	Command	0104(2Byte)
11	Static Data	Subcommand	0000(2Byte)
12	Non-conversion Variable	Head device No.	[D5-D5]Fixed Length/3Byte/Lower/Upper Byte/No Swap
13	Non-conversion Variable	Device code	[D7-D7]Fixed Length/1Byte/Lower/Upper Byte/No Swap
14	Non-conversion Variable	Number of device points	[D8-D8]Fixed Length/2Byte/Lower/Upper Byte/No Swap

- Normal response

Packet Setting

Protocol No. Protocol Name

Packet Type Packet Name

Packet No.

Element List

Element No.	Element Type	Element Name	Element Setting
1	Static Data	(Fixed data)	D400(2Byte)
2	Non-conversion Variable	Serial No.	[D9-D9](Fixed Length/2Byte/Lower/Upper Byte/No Swap)
3	Static Data	(Fixed data)	0000(2Byte)
4	Non-conversion Variable	Network No.	[D10-D10](Fixed Length/1Byte/Lower/Upper Byte/No Swap)
5	Non-conversion Variable	Station No.	[D11-D11](Fixed Length/1Byte/Lower/Upper Byte/No Swap)
6	Non-conversion Variable	Requested module I/O No.	[D12-D12](Fixed Length/2Byte/Lower/Upper Byte/No Swap)
7	Static Data	For future expansion	00(1Byte)
8	Length	Response data length	[Object element9-10/HEX/Reverse/2Byte]
9	Static Data	End code	0000(2Byte)
10	Non-conversion Variable	Response data	[D13](D14-D973)(Variable Length/1920Byte/Lower/Upper Byte/No Swap)

Change Type Add New Copy Paste Delete

Close

- Error response

Packet Setting

Protocol No. Protocol Name

Packet Type Packet Name

Packet No.

Element List

Element No.	Element Type	Element Name	Element Setting
1	Static Data	(Fixed data)	D400(2Byte)
2	Non-conversion Variable	Serial No.	[D974-D974](Fixed Length/2Byte/Lower/Upper Byte/No Swap)
3	Static Data	(Fixed data)	0000(2Byte)
4	Non-conversion Variable	Network No.	[D975-D975](Fixed Length/1Byte/Lower/Upper Byte/No Swap)
5	Non-conversion Variable	Station No.	[D976-D976](Fixed Length/1Byte/Lower/Upper Byte/No Swap)
6	Non-conversion Variable	Requested module I/O No.	[D977-D977](Fixed Length/2Byte/Lower/Upper Byte/No Swap)
7	Static Data	For future expansion	00(1Byte)
8	Length	Response data length	[Object element9-15/HEX/Reverse/2Byte]
9	Non-conversion Variable	End code	[D978-D978](Fixed Length/2Byte/Lower/Upper Byte/No Swap)
10	Non-conversion Variable	Network No.	[D979-D979](Fixed Length/1Byte/Lower/Upper Byte/No Swap)
11	Non-conversion Variable	Station No.	[D980-D980](Fixed Length/1Byte/Lower/Upper Byte/No Swap)
12	Non-conversion Variable	Requested module I/O No.	[D981-D981](Fixed Length/2Byte/Lower/Upper Byte/No Swap)
13	Static Data	For future expansion	00(1Byte)
14	Static Data	Command	0104(2Byte)
15	Static Data	Subcommand	0000(2Byte)

Change Type Add New Copy Paste Delete

Close

13. Write the protocol setting data to the CPU module.

 [Online] ⇒ [Write to Module]

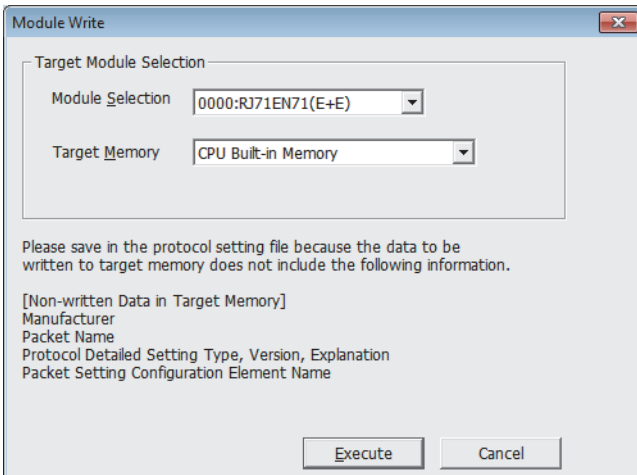



14. Write the set parameters to the CPU module. Then reset the CPU module or power off and on the system.

 [Online] ⇒ [Write to PLC]

Point 

In this example, default values were used for parameters that are not shown above. For the parameter setting, refer to the chapter explaining the parameters in this manual. ( Page 317 PARAMETER SETTINGS)

Receiving side

1. Set the CPU module and add the module labels of the CPU module. The setting method of the CPU module and addition method of the module label are the same as those of when setting the sending side. ( Page 55 Sending side)
2. Set the RJ71EN71 and add the module labels of the RJ71EN71. The setting method of the RJ71EN71 and addition method of the module label are the same as those of when setting the sending side. ( Page 55 Sending side)
3. Set the items in "Basic Settings" as follows.

 [Navigation window] ⇒ [Parameter] ⇒ [Module Information] ⇒ [RJ71EN71] ⇒ [Port 1 Module Parameter (Ethernet)] ⇒ [Basic Settings]

Item	Setting
Own Node Settings	
Parameter Setting Method	Parameter Editor
IP Address	
IP Address	192 . 0 . 1 . 101
Subnet Mask	. . .
Default Gateway	. . .
Communications by Network No./Station No.	Disable
Setting Method	Use IP Address
Network Number	-----
Station No.	-----
Transient Transmission Group No.	0
Enable/Disable Online Change	Disable All (SLMP)
Communication Data Code	Binary
Opening Method	Do Not Open by Program
External Device Configuration	
External Device Configuration	<Detailed Setting>

4. Set the network configuration as follows.

[Navigation window] ⇒ [Parameter] ⇒ [Module Information] ⇒ [RJ71EN71] ⇒ [Port 1 Module Parameter (Ethernet)] ⇒ [Basic Settings] ⇒ [External Device Configuration]

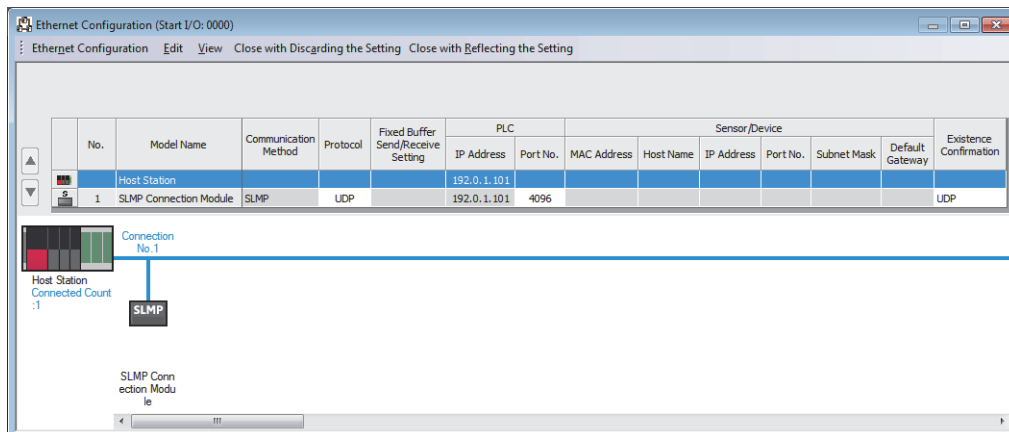

5. Write the set parameters to the CPU module. Then reset the CPU module or power off and on the system.

[Online] ⇒ [Write to PLC]

Point

In this example, default values were used for parameters that are not shown above. For the parameter setting, refer to the chapter explaining the parameters in this manual. (☞ Page 317 PARAMETER SETTINGS)

Program examples

Classification	Label name	Description	Device																												
Module label	EN71_EE_1.bnCompletion_ConnectionOpen_D[1]	Open completion signal (connection No.1)	U0\G1900000.0																												
	EN71_EE_1.uCompletion_EthernetInitialized_D.0	Initial status	U0\G1900024.0																												
	EN71_EE_1.bReady_PredefinedProtocol_D	Predefined protocol ready	U0\G1901002.0																												
Label to be defined	Define global labels as shown below:																														
	<table border="1"> <thead> <tr> <th>Label Name</th> <th>Data Type</th> <th>Class</th> <th>Assign (Device/Label)</th> </tr> </thead> <tbody> <tr> <td>bStart</td> <td>Bit</td> <td>VAR_GLOBAL</td> <td>M0</td> </tr> <tr> <td>bComp</td> <td>Bit(0..1)</td> <td>VAR_GLOBAL</td> <td>M1</td> </tr> <tr> <td>bComp_OK</td> <td>Bit</td> <td>VAR_GLOBAL</td> <td>M10</td> </tr> <tr> <td>bComp_NG</td> <td>Bit</td> <td>VAR_GLOBAL</td> <td>M11</td> </tr> <tr> <td>uControlData</td> <td>Word [Unsigned]/Bit String [16-bit](0..17)</td> <td>VAR_GLOBAL</td> <td>D1000</td> </tr> <tr> <td>wResult</td> <td>Word [Signed]</td> <td>VAR_GLOBAL</td> <td>D1100</td> </tr> </tbody> </table>	Label Name	Data Type	Class	Assign (Device/Label)	bStart	Bit	VAR_GLOBAL	M0	bComp	Bit(0..1)	VAR_GLOBAL	M1	bComp_OK	Bit	VAR_GLOBAL	M10	bComp_NG	Bit	VAR_GLOBAL	M11	uControlData	Word [Unsigned]/Bit String [16-bit](0..17)	VAR_GLOBAL	D1000	wResult	Word [Signed]	VAR_GLOBAL	D1100		
Label Name	Data Type	Class	Assign (Device/Label)																												
bStart	Bit	VAR_GLOBAL	M0																												
bComp	Bit(0..1)	VAR_GLOBAL	M1																												
bComp_OK	Bit	VAR_GLOBAL	M10																												
bComp_NG	Bit	VAR_GLOBAL	M11																												
uControlData	Word [Unsigned]/Bit String [16-bit](0..17)	VAR_GLOBAL	D1000																												
wResult	Word [Signed]	VAR_GLOBAL	D1100																												

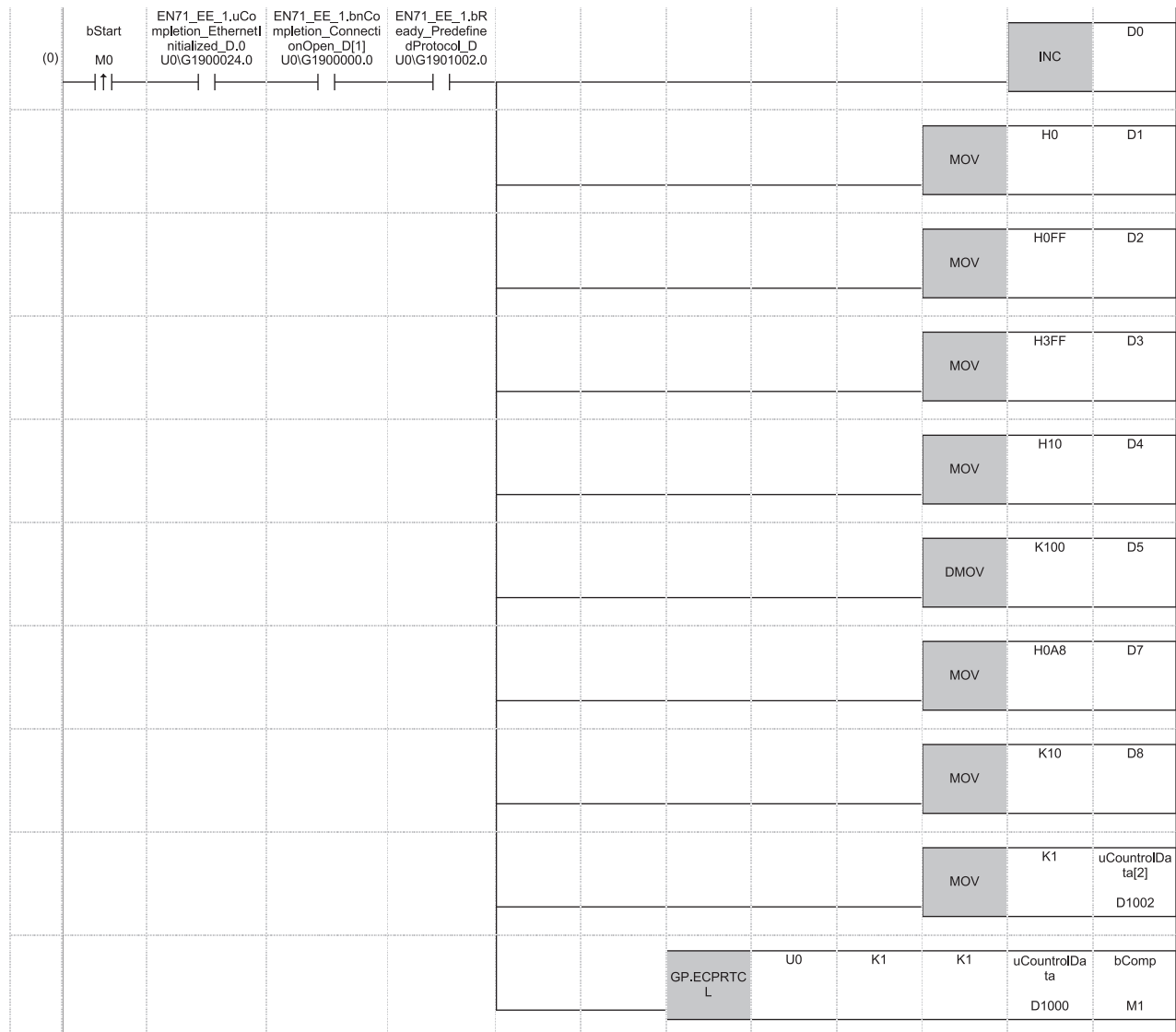

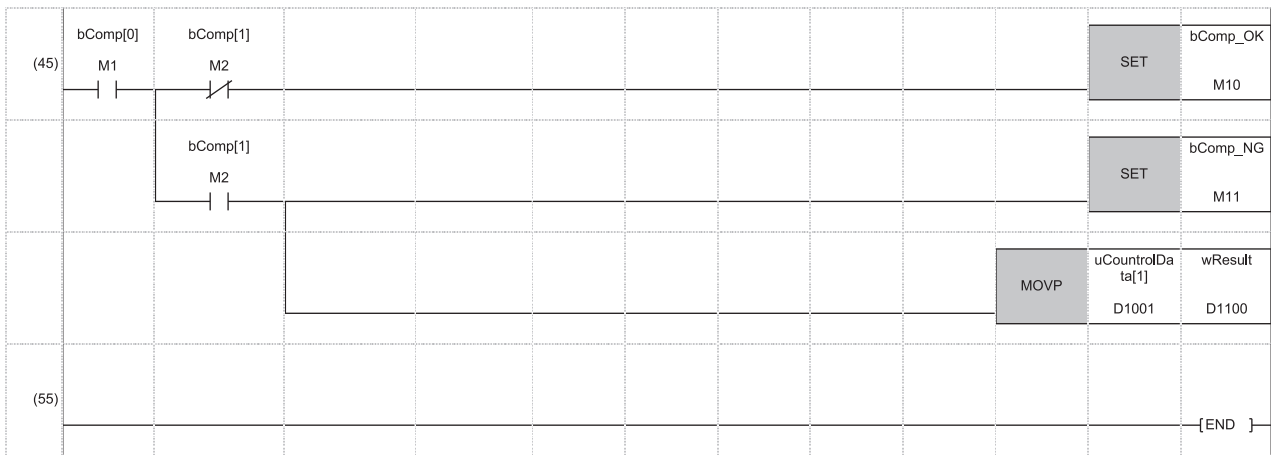

- (0) When 'bStart' (M0) is turned on, the protocol is executed by the dedicated instruction GPECPRTCL, and D100 to D109 of the receiving side CPU module is read and stored in D14 to D23 of the sending side CPU module. 'bComp_OK' (M10) is turned on when the protocol completed successfully.

D0 to D8 stores the following as a protocol setting data.

Device number	Element name	Setting value	Description
D0	Serial No.	—	The number increases one by one each time the 'bStart' (M0) is turned on.
D1	Network No.	0H	Because the access destination is the connected station (own station), 0H is stored as the request destination network number.
D2	Station No.	FFH	Because the access destination is the connected station (own station), FFH is stored as the request destination station number.
D3	Requested module I/O No.	3FFH	Because the access destination is the receiving side CPU module (control CPU of the receiving side RJ71EN71), 3FFH is stored.
D4	Monitoring timer	10H	The monitoring timer is set to 4 seconds. (Unit: 250ms)
D5 to D6	Head device No.	100	To read D100 to D109, start device number is set to 100.
D7	Device code	A8H	To read D100 to D109, device code is set to A8H.
D8	Number of device points	10	To read 10 points from D100 to D109, number of device points is set to 10.



In this program example, a receiving side program is not required.

1.4 Socket Communications

Using dedicated instructions, arbitrary data can be exchanged with an external device connected by Ethernet over TCP/IP or UDP/IP. (👉 Page 522 Socket communications instructions)

Use this for bidirectional communication one-on-one with an external device.

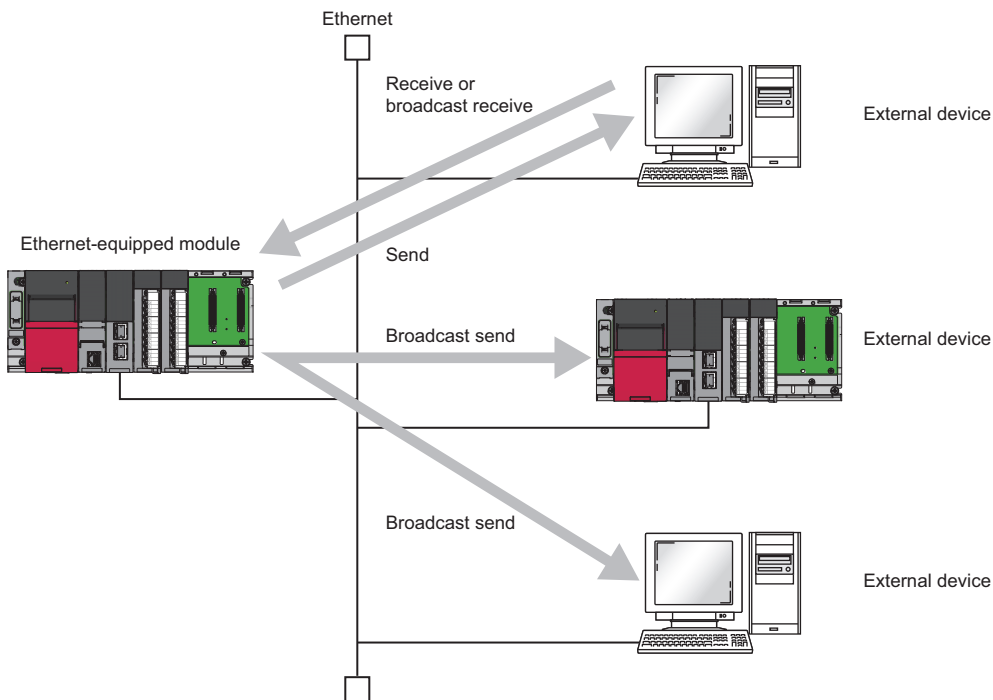

Point 🔍

For examples of socket communications, refer to the following.

📖 MELSEC iQ-R Ethernet/CC-Link IE User's Manual (Startup)

Precautions

Socket communications cannot be used when the RJ71EN71 network type is set to "Q Compatible Ethernet".

Setting procedure

Set "External Device Configuration" under "Basic Settings". (👉 Page 320 External Device Configuration)



1. Select the external device to be connected in "Module List" and drag it to "List of devices" or "Device map area".

External device name	Description
UDP Connection Module	Select to communicate with the external device using UDP/IP.
Active Connection Module	Select to perform the open processing to the external device from the Ethernet-equipped module (Active open) and communicate using TCP/IP.
Unpassive Connection Module	Select to receive the open processing from an unspecified external device (Unpassive open) and communicate using TCP/IP.
Fullpassive Connection Module	Select to receive the open processing from the specified external device (Fullpassive open) and communicate using TCP/IP.

2. Set "Communication Method" for the external device to "Socket Communication".
3. Set the other parameters required for communication in the connection.

Applicable dedicated instructions

For the dedicated instructions used for socket communications, refer to the following.

-  Page 521 Open/close processing instructions
-  Page 522 Socket communications instructions

Applicable connections

The following connections can be used for data exchange with socket communications.

Module		Usable connections
RJ71EN71	P1 connector	Connection No.17 to 64
	P2 connector	Connection No.1 to 64 ^{*1}
RnENCPU (network part)	P1 connector	Connection No.17 to 64
CPU module (built-in Ethernet port part)		Connection No.1 to 16

- ^{*1} Although the engineering tool shows connection No.1 to 64 as available for port 2 of the RJ71EN71, the internal processing of the RJ71EN71 treats the connections as connection No.65 to 128. To use connections for port 2 of the RJ71EN71 for dedicated instructions, buffer memory, or other purposes, specify connection No.65 to 128.

Communication structure

With socket communications, port numbers that identify the communication are used to enable multiple communication sessions with the external device. These are used for both TCP/IP and UDP/IP.

For send: Specify send source Ethernet-equipped module's port number and the send destination external device's port number.

For receive: Specify the Ethernet-equipped module's port number, and read the data sent to that port.

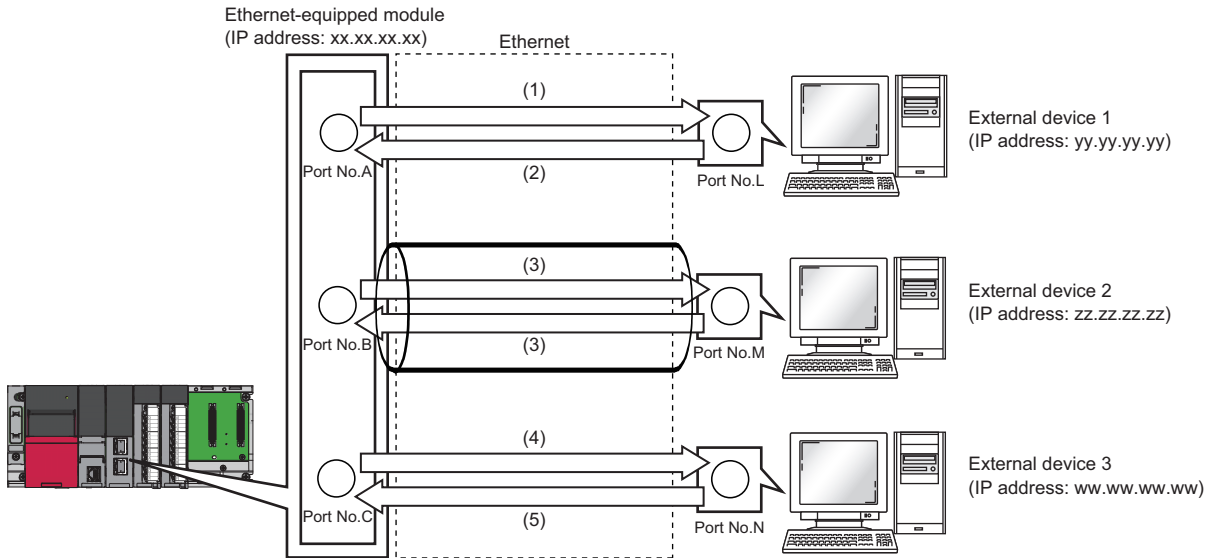

- (1) Sending UDP data from Ethernet-equipped module's port number A to external device 1's port number L
- (2) Sending UDP data from external device 1's port number L to Ethernet-equipped module's port number A
- (3) Sending data with TCP/IP connection
- (4) Sending UDP data from Ethernet-equipped module's port number C to external device 3's port number N
- (5) Sending UDP data from external device 3's port number N to Ethernet-equipped module's port number C

Communications using TCP/IP

TCP/IP protocol establishes a connection between the external device's port number for reliable data exchange.

Check the following items before performing socket communications using TCP/IP.

- IP addresses and port numbers on external device side
- IP addresses and port numbers on the Ethernet-equipped module side
- Which side, the external device side or Ethernet-equipped module side, will open a connection (Active open or Passive open)

TCP/IP connection operation

TCP/IP connection includes Active open and Passive open.

First, the side with the TCP/IP connection executes Passive open with the specified port number

The side with TCP/IP connection specifies the port number waiting in the Passive open side, and executes Active open.

This enables the TCP/IP connection, the connection is established, and data can be exchanged.

For details on Active open and Passive open, refer to the following.

( Page 525 TCP/IP communications)

Point

The Active open and Passive open expression may differ according to the external device.

- Active open: TCP/IP connection side, client side, connect side, and others
- Passive open: TCP/IP connection wait side, server side, listen side, and others

Active open

The following figure shows the flow of data exchange using Active open.

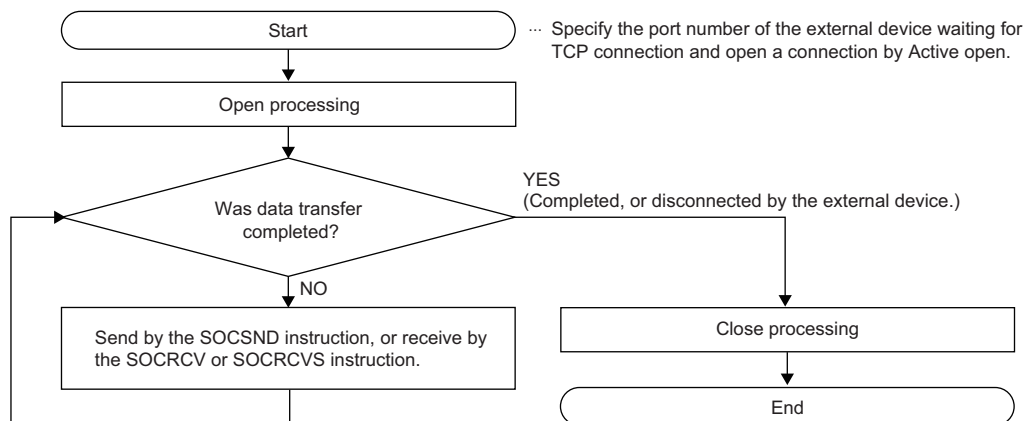

Passive open

The following figure shows the flow of data exchange using Passive open.

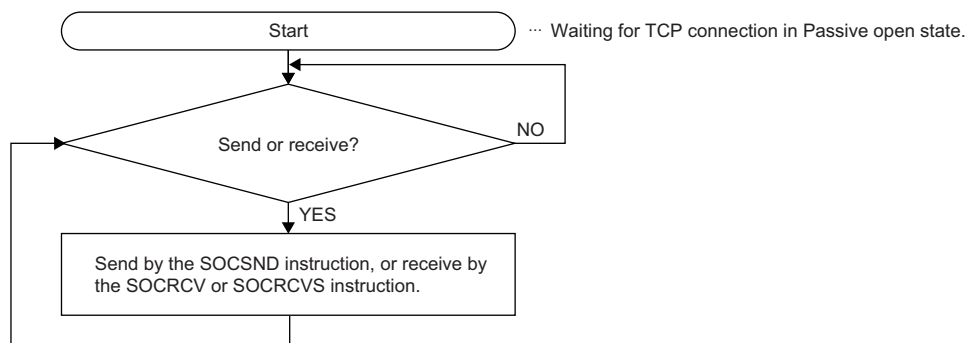

Precautions for TCP/IP communications

■Conditions for closing

In addition to when close is requested from the external device, the TCP/IP communications processing will be closed in the following cases if 'Open completion signal' (Un\G1900000 to Un\G1900007) turns off.

- When alive check function times out
- When forced close is received from external device

■TCP/IP connection elements

The TCP/IP connection is managed with the following four elements. Only one connection containing the same four elements can be created at one time. To use multiple TCP/IP connections simultaneously, ensure that one of the four elements is different.

- IP address of the Ethernet-equipped module side
- Port number of the Ethernet-equipped module side
- IP address of the external device side
- Port number of the external device side

Note that when "Unpassive Connection Module" or "Fullpassive Connection Module" is selected, the port number of the Ethernet-equipped module side has to be different. In addition, one of the other three element also has to be different.

■Reconnecting with same connection

After closing the connection during TCP/IP communications, wait at least 500ms before reconnecting to a connection with the same external device (IP address), own station port number, and external device port number.

If a wait interval cannot be provided before reconnecting, changing the own station port number on the Active open side and connecting is recommended.

■Connection close wait time setting

With the TCP/IP communications, if the external device sends the request for closing the connection immediately after sending data, the system may fail to read the receive data that is immediately before the close processing on the Ethernet-equipped module side. In this case, the close processing timing of the Ethernet-equipped module can be delayed using 'Connection close wait time setting area for socket communications (TCP/IP)' (Un\G760, Un\G761^{*1}) to read the receive data.

*1 The buffer memory address of the CPU module (built-in Ethernet port part)

For details on the connection close wait time setting, refer to the following.

 Page 518 Connection close wait time setting area for socket communications (TCP/IP)

Restriction

Before using the connection close wait time setting, check the version of the CPU module used. ( Page 564 Added and Enhanced Functions)

■Checking the receive data length

There is no concept of delimiting the communication data during communication with TCP/IP. Thus, the continuously sent data may be merged on the received side, or the data sent in a group may be split on the receive side. If necessary, the receiving side must check the receive data length and perform the processing.

If the data length is determined when receiving with the Ethernet-equipped module side, using the fixed-length mode is recommended.

When receiving on the external device side, check the receive data length and perform the processing as shown below.

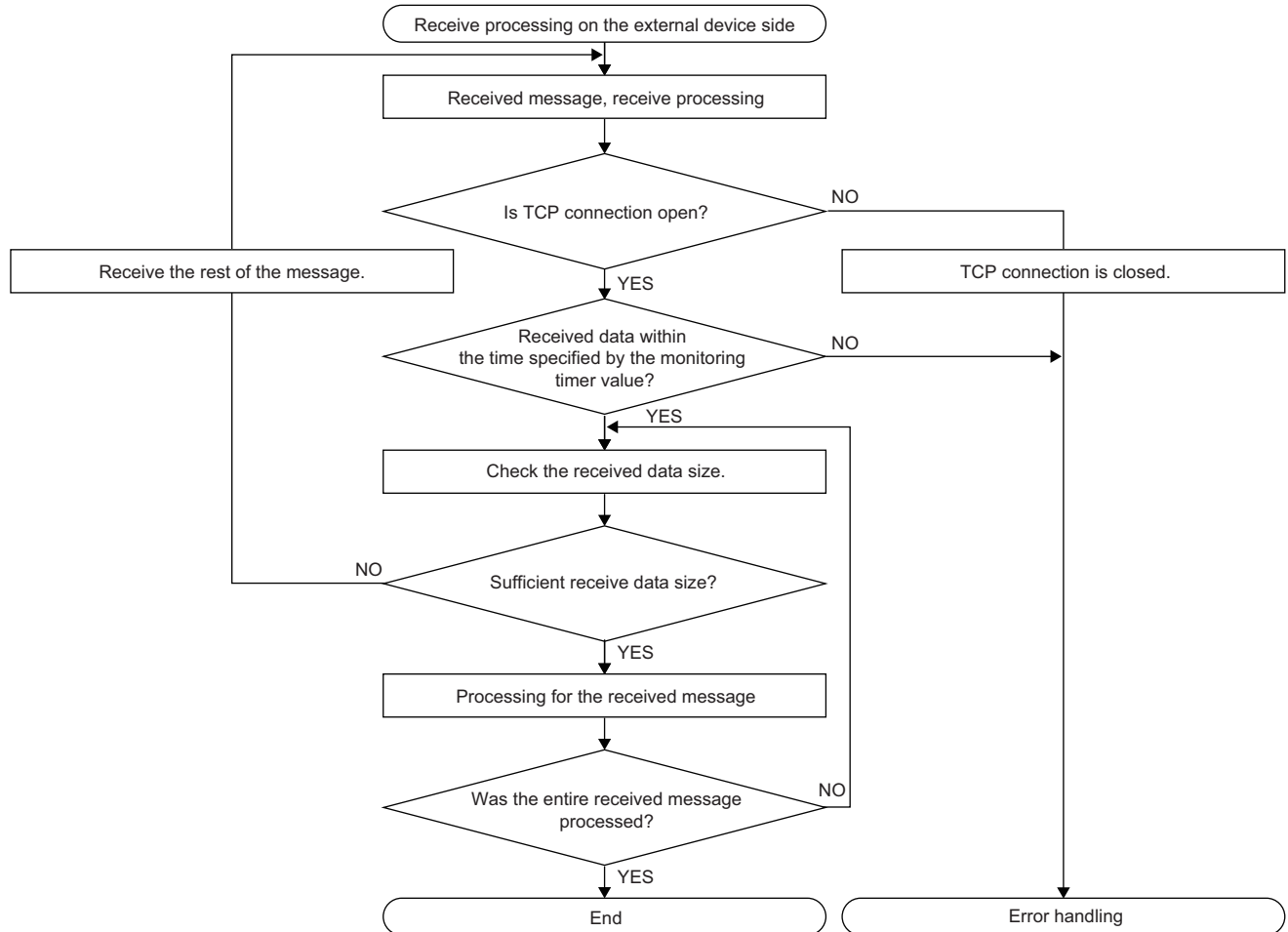

■Precautions for Active open

Use 'Open completion signal' (Un\G1900000 to Un\G1900007) and 'Open request signal' (Un\G1900008 to Un\G1900015) in the program to create an interlock circuit. The on/off timing for the open completion signal and open request signal is shown below.

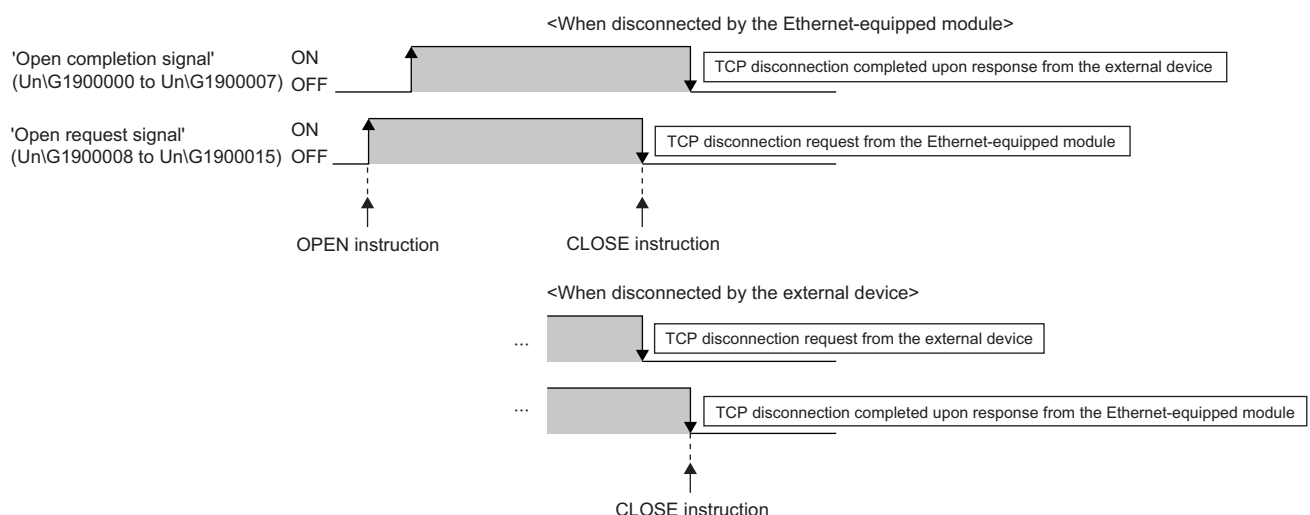

■Precautions for Passive open

- Use 'Open completion signal' (Un\G1900000 to Un\G1900007) and 'Open request signal' (Un\G1900008 to Un\G1900015) in the program to create an interlock circuit. The on/off timing for the open completion signal and open request signal is shown below.

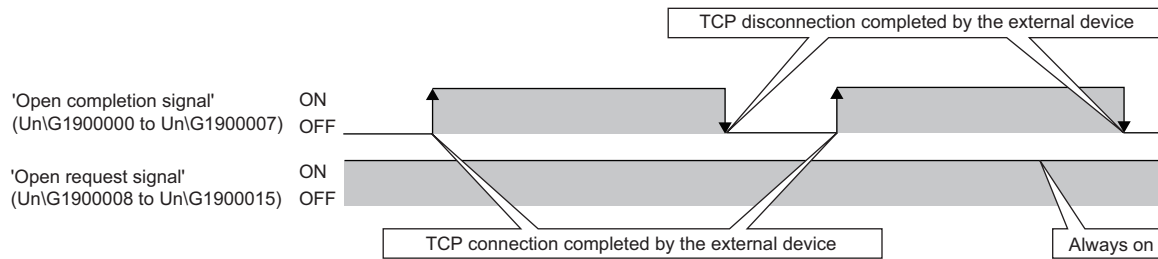

- When the CPU module is connected to the external device with Passive open, the connected external device's IP address or the external device's port number can be retrieved with the SP.SOCCINF instruction.
- Connect from the external device after the Ethernet-equipped module enters the open standby state. The TCP/IP connection request received from the external device between the time from CPU startup completion to open wait state causes an error, and force close connection is returned to the external device. In this case, wait for the Ethernet-equipped module to enter the open wait state and then retry from the external device.
- Do not execute the GP.CONCLOUSE instruction or SP.SOCCLOSE instruction in the program. If the GP.CONCLOUSE instruction or SP.SOCCLOSE instruction is executed, the open completion signal and open request signal for the corresponding connection will turn off. The close processing will be executed and send/receive will be disabled. To re-open a closed connection, execute the GP.CONOPEN instruction or SP.SOCOPEN instruction.

Communications using UDP/IP

Communication with UDP/IP uses a simple protocol without order control or re-send control.

Check the following items before performing socket communications using UDP/IP.

- IP addresses and port numbers on external device side
- IP addresses and port numbers on the Ethernet-equipped module side

Precautions for UDP/IP communications

- Loss of data, data arrival order interchange, and others could occur. Consider using TCP/IP if there are problems.
- Even if the communication line between the CPU module and external device is not connected because of a connected cable disconnection and others, the data send processing may end normally. Thus, providing a communication procedure and sending/receiving data is recommended.
- Use the SP.SOCCSET instruction to change the external device with the CPU module.
- 'Open completion signal' (Un\G1900000 to Un\G1900007) and 'Open request signal' (Un\G1900008 to Un\G1900015) for the connection set to UDP/IP is always on.
- Do not execute the GP.CONCLOUSE instruction or SP.SOCCLOSE instruction in the program. If the GP.CONCLOUSE instruction or SP.SOCCLOSE instruction is executed, the open completion signal and open request signal for the corresponding connection will turn off. The close processing will be executed and send/receive will be disabled. To re-open a closed connection, execute the GP.CONOPEN instruction or SP.SOCOPEN instruction.
- Even if 'Open completion signal' (Un\G1900000 to Un\G1900007) is turned on, data sending may fail. If data sending fails, send the data again.

Broadcast communications

Broadcast communications is a communication method that does not specify the external device. Data is exchanged between all Ethernet-equipped module stations and external devices on the same Ethernet to which the Ethernet-equipped modules are connected.

Item	Description
Broadcast sending	The same data is sent to all Ethernet devices on the same Ethernet.
Broadcast receiving	The data sent with broadcast send is received.

Setting procedure

Set "External Device Configuration" under "Basic Settings". (☞ Page 320 External Device Configuration)

1. Select "UDP Connection Module" in "Module List" and drag it to "List of devices" or "Device map area".
2. Set "Communication Method" for the external device to "Broadcast Send" or "Broadcast Receive".
3. Set the other parameters required for communication in the connection.

Precautions

- Decide the dedicated port number for broadcast communication in the system, and use that number.
- Access via a router is not permitted when using broadcast send.
- The external device connected on the same Ethernet must carry out a read/discard processing if the message received with broadcast receiving is not required.
- When the CPU module receives the data with broadcast receiving, the IP address of the sending external device and the external device's port number can be retried with the SP.SOCCINF instruction.

Precautions

This section describes the precautions for exchanging data with socket communications.

Port number

Port numbers 1 to 1023 are typically reserved port numbers (WELL KNOWN PORT NUMBERS) and 61440 to 65534 are used by other communication functions, so 1024 to 4999 or 5010 to 61439 should be used for the own station port numbers. In addition, if ports are used for other functions, do not use the ports for this function. (☞ Page 550 Port Numbers Used by Ethernet-equipped Module)

Reading received data

If 'Socket/fixed buffer reception status signal' (Un\G1900016 to Un\G1900023) is on, read the received data. The communication could be affected if large amounts of data are not read out for a while.

Accessing a file during communication

The CPU module prioritizes the file access processing over the Ethernet communication processing. Thus, if the file is accessed with FTP, the engineering tool, and so on, during socket communications, the socket communications processing could be delayed.

To access a file while monitoring the response time with the external device with socket communications, add the time required for accessing the file to the monitoring time.

Module FB and dedicated instruction

- When performing the open processing using the module FB or dedicated instruction, start sending and receiving data after the module FB or dedicated instruction is completed.
- Multiple module FBs or dedicated instructions to one connection cannot be simultaneously executed. When multiple module FBs or dedicated instructions are simultaneously executed, no operation is performed for the module FB or dedicated instruction executed later. Execute again after the module FB or dedicated instruction in execution is completed.

1.5 Communications Using the Fixed Buffer

Communications using the fixed buffer uses TCP/IP and UDP/IP to send and receive arbitrary data with the external device connected to the Ethernet with dedicated instructions in the same manner as exchanging data with socket communications. Exchanges arbitrary data between the CPU module and external device using the fixed buffer of the RJ71EN71 and the RnENCPU (network part).

The following table lists the differences with socket communications are given below.

Item	Differences	
	Socket communications	Communications using the fixed buffer
Connection send/receive	Send/receive is possible with one connection	Specify send or receive for one connection (Two connections are required for send and receive)

Precautions

The CPU module (CPU part for the RnENCPU) cannot exchange data with the fixed buffer.

Differences between the "Procedure Exist" and "No Procedure" control methods

"Procedure Exist" and "No Procedure" control methods can be used for fixed buffer communication. The following table lists the differences between "Procedure Exist" and "No Procedure".

Item	Differences	
	Procedure Exist	No Procedure
Message format	Data is sent and received with the predetermined data format.	Data is sent and received according to the external device's message format.
Response for received data	A response is sent for the received data.	No response is sent for the received data.
Data Code	Data can be exchanged with binary code or ASCII code.	Data is exchanged only with binary codes.
Data length specified with dedicated instructions	Specify with a number of words.	Specify with a number of bytes.
Amount of application data per data exchange session ^{*1}	Maximum 5113 words (binary code) Maximum 2556 words (ASCII code)	Maximum 10238 bytes

*1 The following value is used if the RJ71EN71 network type is set to "Q Compatible Ethernet".
 Procedure Exist: Maximum 1017 words (binary code), maximum 508 words (ASCII code)
 No Procedure: Maximum 2046 bytes

Setting procedure

Set "External Device Configuration" under "Basic Settings". (Page 320 External Device Configuration)



1. Select the external device to be connected in "Module List" and drag it to "List of devices" or "Device map area".

External device name	Description
UDP Connection Module	Select to communicate with the external device using UDP/IP.
Active Connection Module	Select to perform the open processing to the external device from the Ethernet-equipped module (Active open) and communicate using TCP/IP.
Unpassive Connection Module	Select to receive the open processing from an unspecified external device (Unpassive open) and communicate using TCP/IP.
Fullpassive Connection Module	Select to receive the open processing from the specified external device (Fullpassive open) and communicate using TCP/IP.

2. Set "Communication Method" for the external device to "Fixed Buffer (Procedure Exist)" or "Fixed Buffer (No Procedure)".
3. Set the "Fixed Buffer Send/Receive Setting".
4. Set the other parameters required for communication in the connection.

Applicable dedicated instructions

For the dedicated instructions used for communications using the fixed buffer, refer to the following.

-  Page 521 Open/close processing instructions
-  Page 522 Instructions for communications using the fixed buffer

GP.CONOPEN and GP.CONCLOSE of the open/close processing instructions are not available when "Q Compatible Ethernet" is set to network type.

Applicable connections

The connections No.1 to 16 of the P1 connector can be used for the communications using the fixed buffer.

Communications using the fixed buffer cannot be used with the P2 connector.

Communication structure

This section describes the mechanism of communication with fixed buffer communication.

Data flow

Dedicated instructions are used to send and receive data in fixed buffer communication ( Page 74 Applicable dedicated instructions)

With "Procedure Exist", the CPU module and external device exchange data one-on-one. A handshake is established with the external device when sending data from the CPU module and receiving data from the external device.

With "No Procedure", data is sent from the CPU module and received from the external device without a procedure.

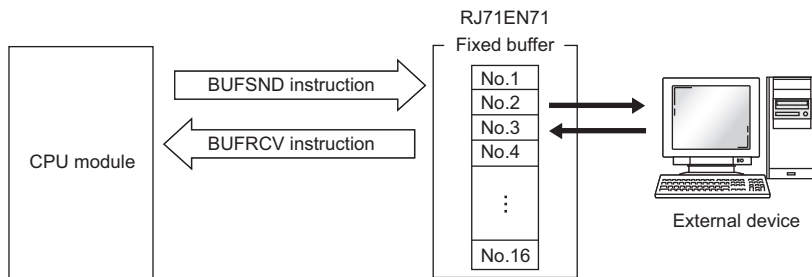

External devices capable of data exchange

Data can be exchanged with the following external devices.

- Devices in Ethernet to which the RJ71EN71 is connected
- Devices in Ethernet to which the RnENCPU (network part) is connected
- Device connected via router

As the following figure shows, the external device for communication and the working application (for send/receive and "Procedure Exist"/"No Procedure") are set in "External Device Configuration" under "Basic Settings" using each fixed buffer (No.1 to No.16) to fix the external device for each buffer.

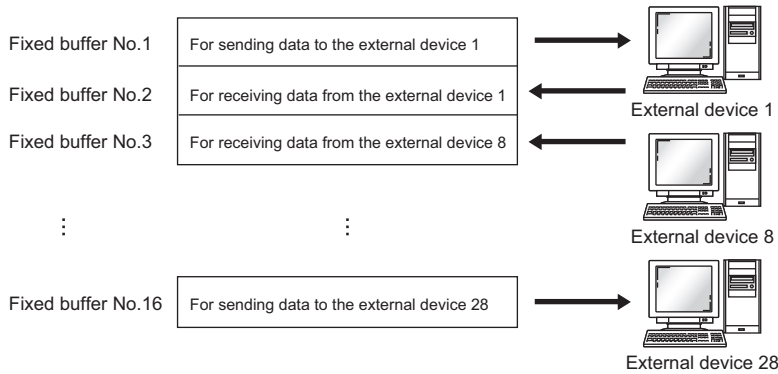

Pay attention to the following when changing the external device.

- During TCP/IP communications, the external device can be changed only when a connection is not established with the external device (when the open completion signal is off).
- During UDP/IP communications, the external device can be changed regardless of the connection status with the external device.
- When changing the external device, do not use the pairing open or alive check function.

Processing during data send/receive

■During data send

When the BUFSND instruction is executed, the RJ71EN71 and the RnENCPU (network part) send data from the corresponding fixed buffer to the external device set in the specified connection.

■During data reception

If the data is being received from an external device set in the specified connection, the RJ71EN71 and the RnENCPU (network part) process the reception.

If data is being received from an external device that is not set in the specified connection, the RJ71EN71 and the RnENCPU (network part) will ignore the received data.

Send procedure

The following figure shows the processing when sending data from the RJ71EN71 or the RnENCPU (network part) to the external device.

Procedure exists

The following figure shows the send processing for the fixed buffer No.1 area corresponding to the connection No.1.

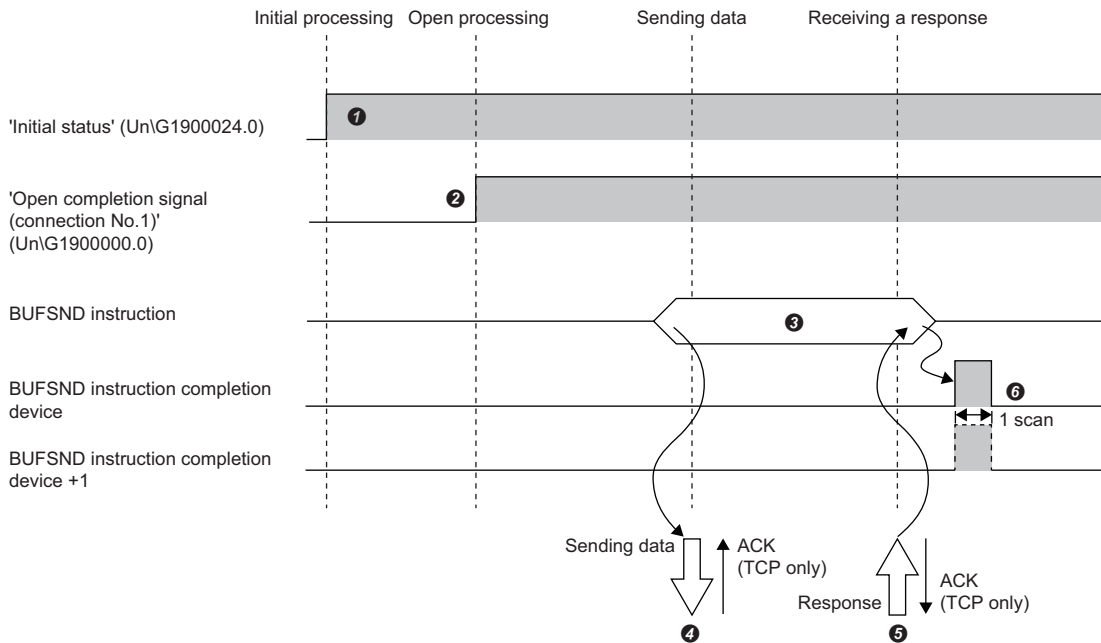

- ① Normal completion of the initial processing is checked. ('Initial status' (UnG1900024.0): On)
- ② A connection is established between the external device and the RJ71EN71 or the RnENCPU (network part), and normal completion of the connection No.1 open processing is checked. (☞ Page 525 TCP/IP Communications, UDP/IP Communications)
- ③ The BUFSND instruction is executed. (Sends data)
- ④ The data length amount of send data in the fixed buffer No.1 area is sent to the external device.
- ⑤ When the external device receives the data from the RJ71EN71 or the RnENCPU (network part), returns a response to the RJ71EN71 or the RnENCPU (network part).
- ⑥ When a response is received from the external device, the RJ71EN71 or the RnENCPU (network part) finishes data send. If the response is not returned within the response monitor timer value, a data send error occurs.*1 If the data send completes abnormally, execute the BUFSND instruction again and start the send processing.

*1 Adjust the monitor timer value with the parameters. (☞ Page 392 Timer Settings for Data Communication)

Point

- The details of the open setting are enabled at the rising edge of the RJ71EN71 and the RnENCPU (network part) open completion signal.
- Send the next data (command) after the data exchange has been completed for the previous data (command) send.
- When sending or receiving data to multiple external devices, the data can be sent sequentially. However, to avoid communication trouble, it is recommended to switch the external device and send/receive the data. When using a connection opened with UDP/IP, the setting value in the communication address setting area can be changed before sending or receiving to switch the external device.

No procedure

The following figure shows the send processing for the fixed buffer No.1 area corresponding to the connection No.1.

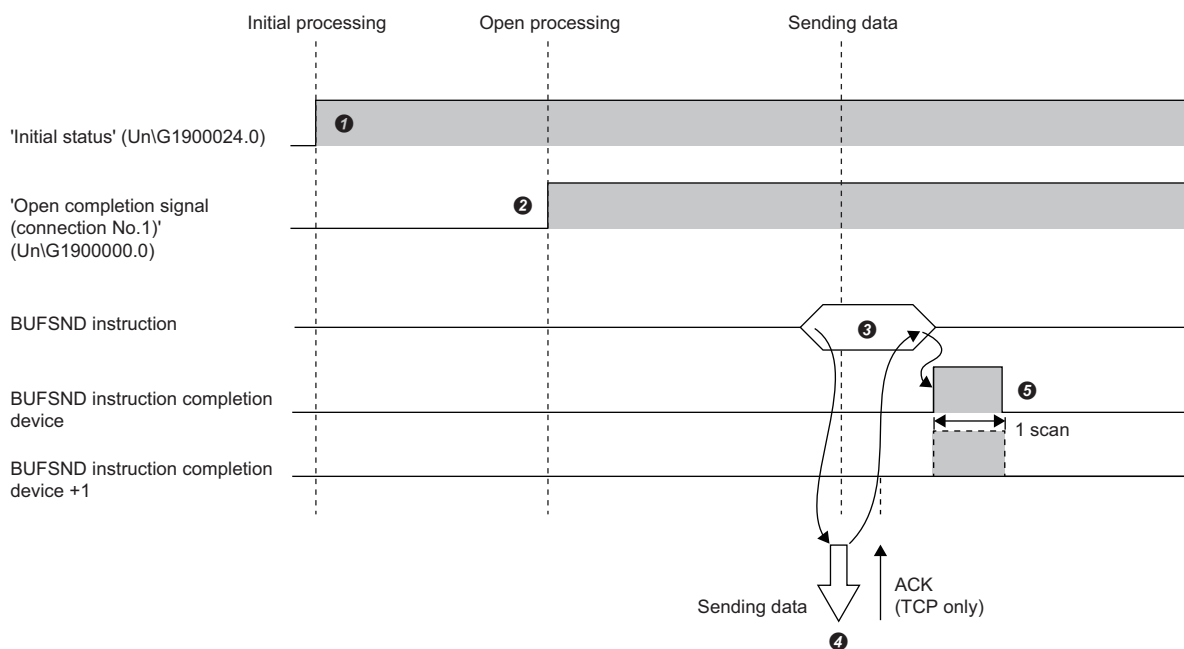

- ❶ Normal completion of the initial processing is checked. ('Initial status' (Un\G1900024.0): On)
- ❷ A connection is established between the external device and the RJ71EN71 or the RnENCPU (network part), and normal completion of the connection No.1 open processing is checked. (➡ Page 525 TCP/IP Communications, UDP/IP Communications)
- ❸ The BUFSND instruction is executed. (Sends data)
- ❹ The data length amount of send data in the fixed buffer No.1 area is sent to the external device.
- ❺ When a response is received from the external device, the RJ71EN71 or the RnENCPU (network part) finishes data send. If the data send completes abnormally, execute the BUFSND instruction again and start the send processing.

Point

During UDP/IP communications, if the internal processing of the RJ71EN71 and the RnENCPU (network part) completed normally, the data send processing may end normally even if the communication line between the CPU module and external device is disconnected because of a connection cable disconnection or other causes. Thus, providing a communication procedure and sending/receiving data is recommended.

Receive procedure

The following figure shows the processing for the RJ71EN71 or the RnENCPU (network part) to receive data from the external device. The following receive methods can be used.

- Receiving with main program (BUFRCV instruction)
- Receiving with interrupt program (BUFRCVS instruction)

Receiving with main program (procedure exists)

The following figure shows the receive processing for the fixed buffer No.1 area corresponding to the connection No.1.

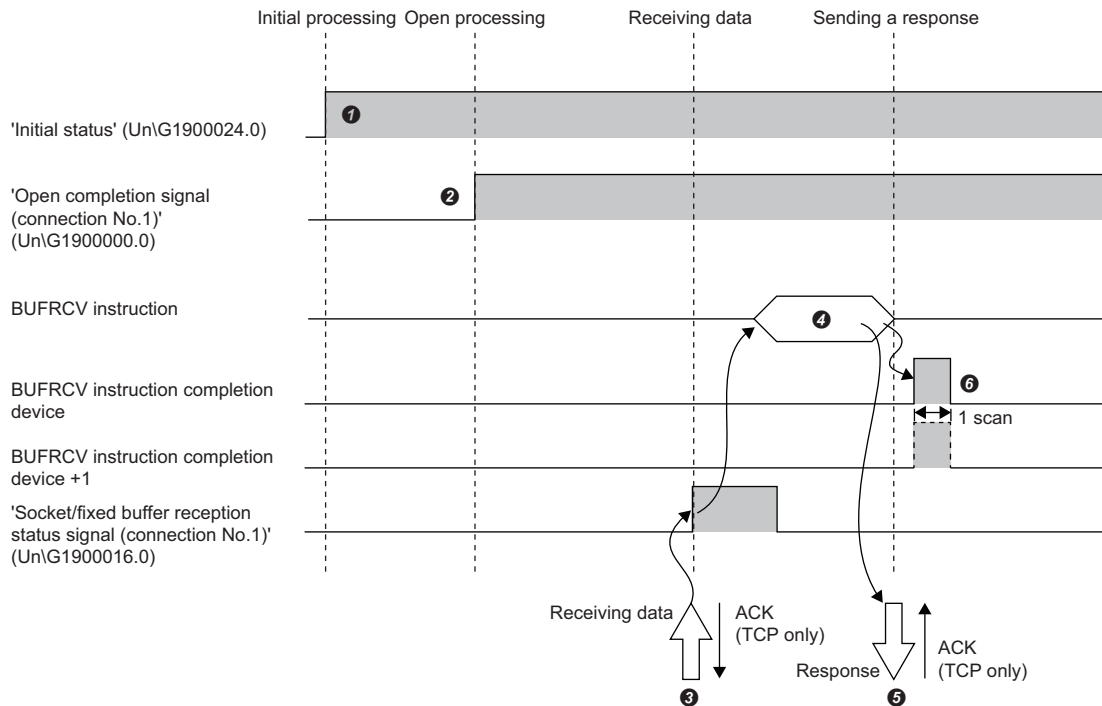

- 1 Normal completion of the initial processing is checked. ('Initial status' (UnG1900024.0): On)
- 2 A connection is established between the external device and the RJ71EN71 or the RnENCPU (network part), and normal completion of the connection No.1 open processing is checked. (☞ Page 525 TCP/IP Communications, UDP/IP Communications)
- 3 Data is received from the external device. ('Socket/fixed buffer reception status signal (connection No.1)' (UnG1900016.0): On)
- 4 The BUFRCV instruction is executed, and the receive data length and receive data are read from the fixed buffer No.1. ('Socket/fixed buffer reception status signal (connection No.1)' (UnG1900016.0): Off)
- 5 When reading of the receive data length and receive data is completed, a response is returned to the external device.
- 6 The receive processing ends. If the data reception completes abnormally, execute the BUFRCV instruction again and start the receive processing.

Point

- The details of the open setting are enabled at the rising edge of the RJ71EN71 and the RnENCPU (network part) open completion signal.
- Execute the BUFRCV instruction when the socket/fixed buffer reception status signal changes from off to on.
- The socket/fixed buffer reception status signal does not turn on when abnormal data is received. In addition, data is not stored in the fixed buffer No.1 area.

Receiving with main program (no procedure)

The following figure shows the receive processing for the fixed buffer No.1 area corresponding to the connection No.1.

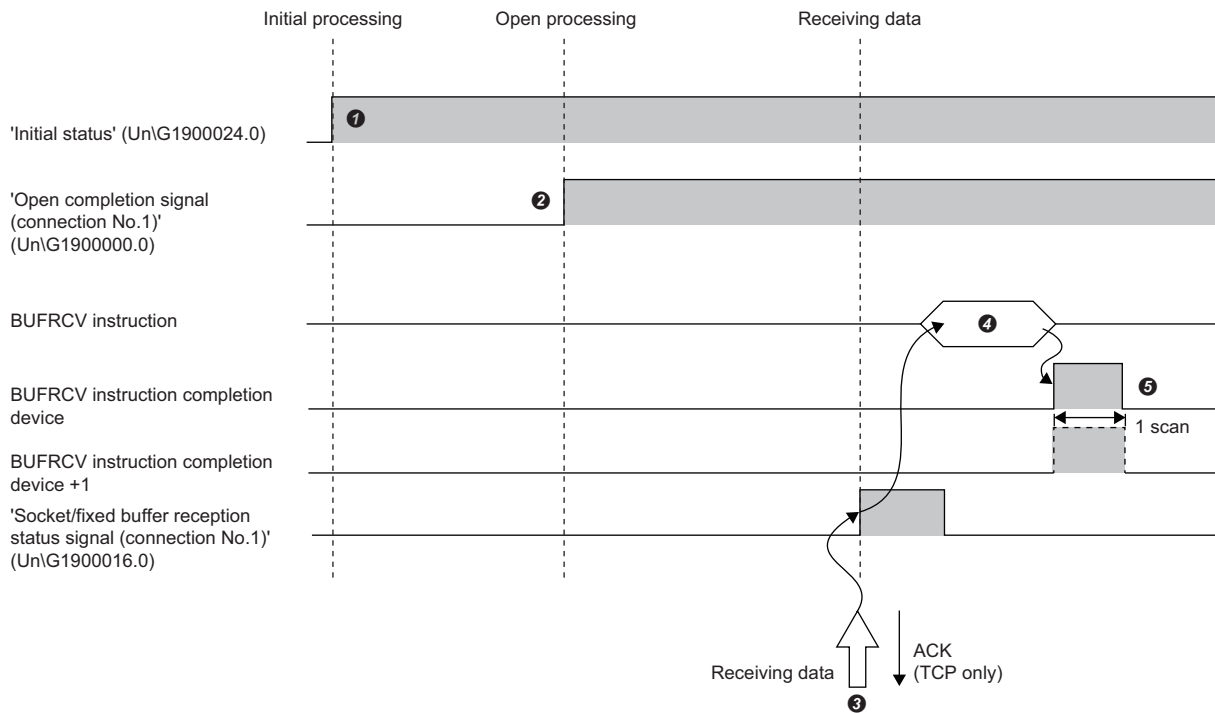

- ① Normal completion of the initial processing is checked. ('Initial status' (UnG1900024.0): On)
- ② A connection is established between the external device and the RJ71EN71 or the RnENCPU (network part), and normal completion of the connection No.1 open processing is checked. (☞ Page 525 TCP/IP Communications, UDP/IP Communications)
- ③ Data is received from the external device. ('Socket/fixed buffer reception status signal (connection No.1)' (UnG1900016.0): On)
- ④ The BUFRCV instruction is executed, and the receive data length and receive data are read from the fixed buffer No.1. ('Socket/fixed buffer reception status signal (connection No.1)' (UnG1900016.0): Off)
- ⑤ The receive processing ends. If the data reception completes abnormally, execute the BUFRCV instruction again and start the receive processing.

Point

- The details of the open setting are enabled at the rising edge of the RJ71EN71 and the RnENCPU (network part) open completion signal.
- Execute the BUFRCV instruction when the socket/fixed buffer reception status signal changes from off to on.
- The socket/fixed buffer reception status signal does not turn on when abnormal data is received. In addition, data is not stored in the fixed buffer No.1 area.

Reception with interrupt program (procedure exists)

Use the BUFRCVS instruction for receiving data with the interrupt program. The interrupt program is started when data is received from the external device. It enables the reading of receive data to the CPU module.

The interrupt settings are required to use the interrupt program. (☞ Page 405 Interrupt Settings)

The following figure shows the receive processing for the fixed buffer No.2 area corresponding to the connection No.2.

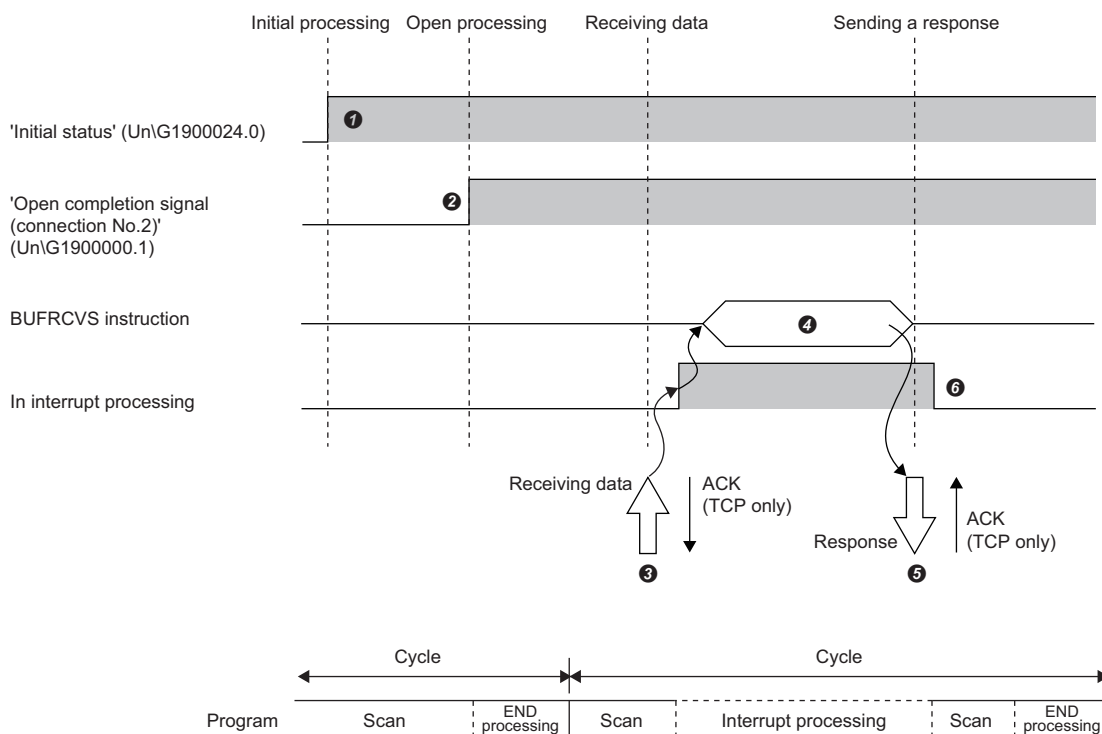

- ❶ Normal completion of the initial processing is checked. ('Initial status' (UnG1900024.0): On)
- ❷ A connection is established between the external device and the RJ71EN71 or the RnENCPU (network part), and normal completion of the connection No.2 open processing is checked. (☞ Page 525 TCP/IP Communications, UDP/IP Communications)
- ❸ The CPU module is requested to start the interrupt program, and data is received from the external device. ('Socket/fixed buffer reception status signal (connection No.2)' (UnG1900016.1): On)
- ❹ The interrupt program starts. The BUFRCVS instruction is executed, and the receive data length and receive data are read from the fixed buffer No.2. ('Socket/fixed buffer reception status signal (connection No.2)' (UnG1900016.1): Off)
- ❺ When reading of the receive data length and receive data is completed, a response is returned to the external device.*1
- ❻ Execution of the interrupt program ends, and execution of the main program resumes.

*1 A response is not returned when the execution completes abnormally.

Reception with interrupt program (no procedure)

Use the BUFRCVS instruction for receiving data with the interrupt program. The interrupt program is started when data is received from the external device. It enables the reading of receive data to the CPU module.

The interrupt settings are required to use the interrupt program. (☞ Page 405 Interrupt Settings)

The following figure shows the receive processing for the fixed buffer No.2 area corresponding to the connection No.2.

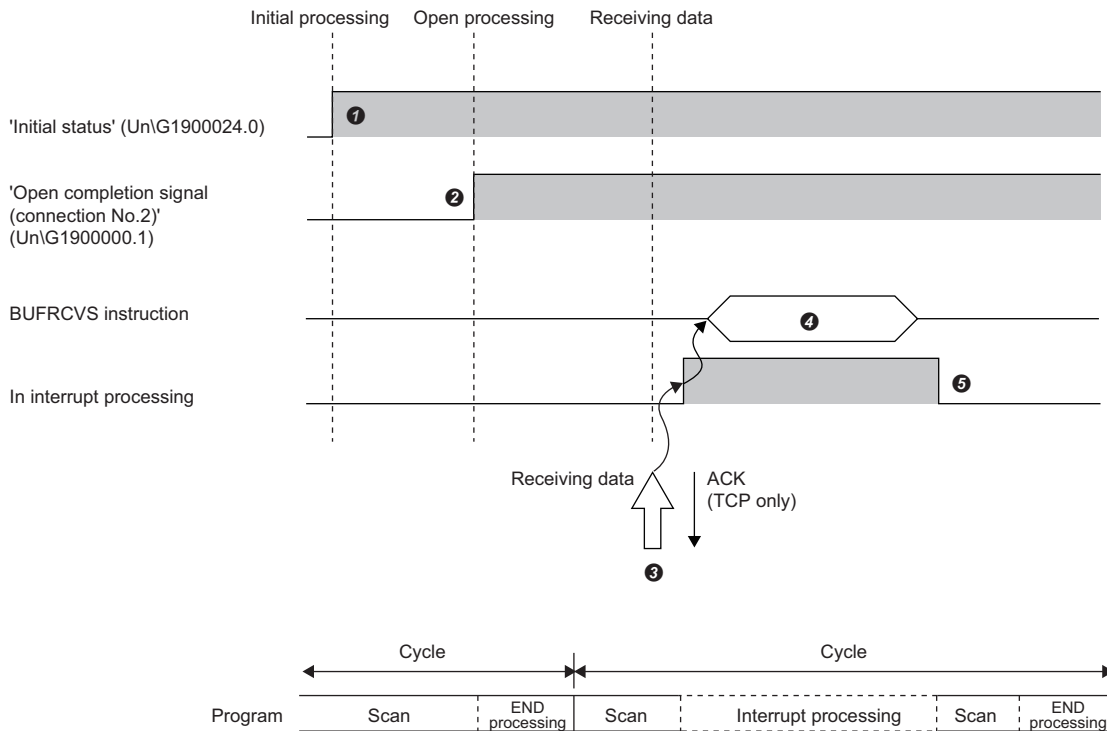

- 1 Normal completion of the initial processing is checked. ('Initial status' (UnG1900024.0): On)
- 2 A connection is established between the external device and the RJ71EN71 or the RnENCPU (network part), and normal completion of the connection No.2 open processing is checked. (☞ Page 525 TCP/IP Communications, UDP/IP Communications)
- 3 The CPU module is requested to start the interrupt program, and data is received from the external device. ('Socket/fixed buffer reception status signal (connection No.2)' (UnG1900016.1): On)
- 4 The interrupt program starts. The BUFRCVS instruction is executed, and the receive data length and receive data are read from the fixed buffer No.2. ('Socket/fixed buffer reception status signal (connection No.2)' (UnG1900016.1): Off)
- 5 Execution of the interrupt program ends, and execution of the main program resumes.

Pairing open

Pairing open is an opening method that pairs a fixed buffer communication reception connection and send connection, and establishes a connection using one port each from the own station and external device.

When pairing open is specified, data can be exchanged with two connections using an open processing for one port.

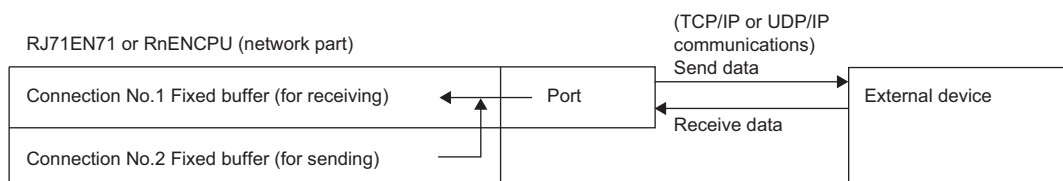

Setting procedure

Set "External Device Configuration" under "Basic Settings". (Page 320 External Device Configuration)

1. Select the external device to be connected in "Module List" and drag it to "List of devices" or "Device map area".
2. Set "Communication Method" for the external device.
3. Set the "Fixed Buffer Send/Receive Setting" with the external device to "Pairing (Receive)".*1
4. Set the other parameters required for communication in the connection.
5. Select the same external device as step 1 from the "Module List", and drag to the next connection number of the external device set in step 1.
6. Set "Communication Method" for the external device to the same as the external device set in step 1.
7. Set the "Fixed Buffer Send/Receive Setting" with the external device to "Pairing (Send)".
8. Set the other parameters to the same values as the external device set in step 1.

*1 Set "Pairing (Receive)" to connection No.1 to 7, or No.9 to 15.

Point

- Only the external devices in the Ethernet to which the RJ71EN71 or the RnENCPU (network part) is connected and devices connected via a router can communicate data with pairing open.
- The open/close processing for the next connection (send connection) is executed automatically using the open/close processing on the receive connection side set to pairing open.

Broadcast communications

Broadcast communications is a communication method that does not specify the external device. Data is exchanged between all Ethernet-equipped module stations and external devices on the same Ethernet to which the Ethernet-equipped modules are connected.

Item	Description
Broadcast sending	The same data is sent to all Ethernet devices on the same Ethernet.
Broadcast receiving	The data sent with broadcast send is received.

Setting procedure

Set "External Device Configuration" under "Basic Settings". (☞ Page 320 External Device Configuration)

1. Select "UDP Connection Module" in "Module List" and drag it to "List of devices" or "Device map area".
2. Set "Communication Method" for the external device to "Broadcast Send" or "Broadcast Receive".
3. Set the other parameters required for communication in the connection.

Precautions

- Decide the dedicated port number for broadcast communication in the system, and use that number.
- Access via a router is not permitted when using broadcast send.
- The external device connected on the same Ethernet must carry out a read/discard processing if the message received with broadcast receiving is not required.

Precautions

This section describes the precautions for communications using the fixed buffer.

Precautions for UDP/IP communications

Even if 'Open completion signal' (Un\G1900000 to Un\G1900007) is turned on, data sending may fail. If data sending fails, send the data again.

Module FB and dedicated instruction

- When performing the open processing using the module FB or dedicated instruction, start sending and receiving data after the module FB or dedicated instruction is completed.
- Multiple module FBs or dedicated instructions to one connection cannot be simultaneously executed. When multiple module FBs or dedicated instructions are simultaneously executed, no operation is performed for the module FB or dedicated instruction executed later. Execute again after the module FB or dedicated instruction in execution is completed.

Data format

This section describes the data format used during communications using the fixed buffer. The communication data is configured of the header and application data.

Header

The header is for TCP/IP or UDP/IP. The RJ71EN71 or the RnENCPU (network part) automatically adds and deletes the header, the setting is not required.

The contents of the header are shown below.

- TCP/IP

Ethernet (14 bytes)	IP (20 bytes)	TCP (20 bytes)
---------------------	---------------	----------------

- UDP/IP

Ethernet (14 bytes)	IP (20 bytes)	UDP (8 bytes)
---------------------	---------------	---------------

Application data

If the communication procedure is "Fixed Buffer (No Procedure)", the application data expresses the following data code with binary codes. Data is exchanged with binary codes regardless of the communication data code setting.

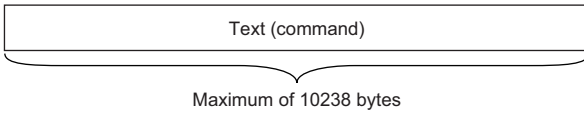

With nonprocedural, the subheader and data length added for procedural are not used, so the data is all handled as valid text. The RJ71EN71 and the RnENCPU (network part) turn on the fixed buffer reception status signal after storing the size of the received message (packet) in the receive data length storage area. Providing a check procedure including the data length, data type code, and so on, in the message's application data is recommended so that the application data's byte size and data type can be seen on the receiving side.

The following figure shows the configuration of the application data when the communication procedure is set to "Fixed Buffer (Procedure Exist)".

Format

- When exchanging data with binary codes

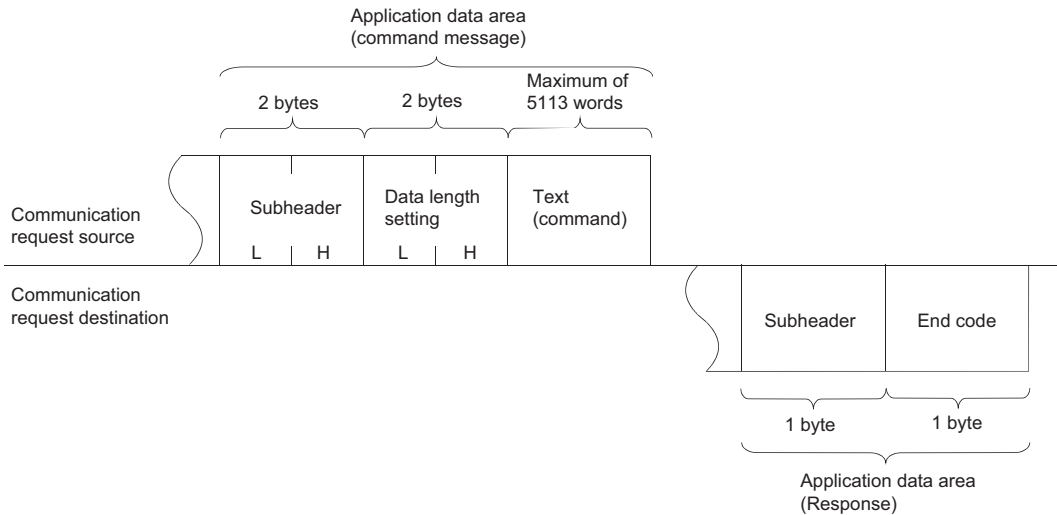

- When exchanging data with ASCII codes

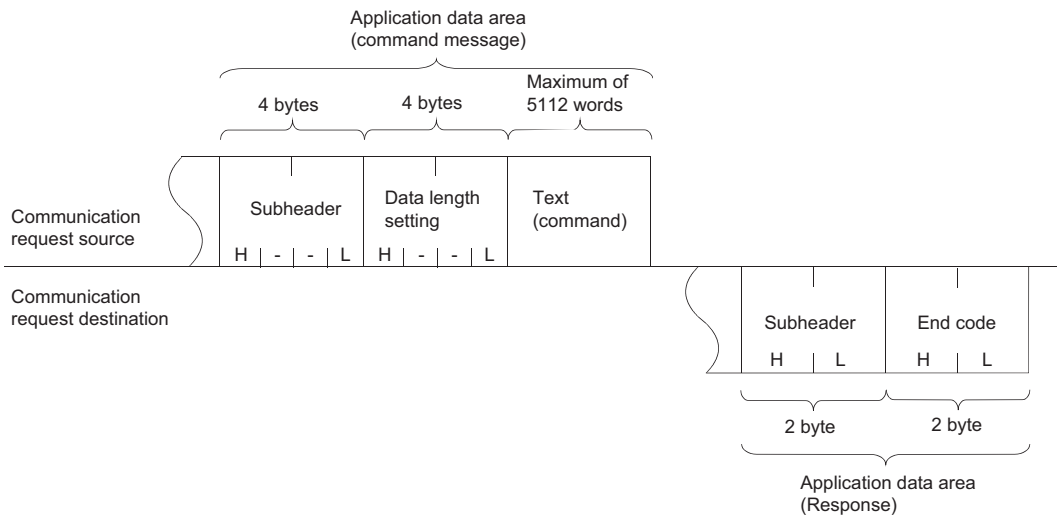

■ Subheader

The RJ71EN71 or the RnENCPU (network part) automatically adds and deletes the subheader, the setting is not required.

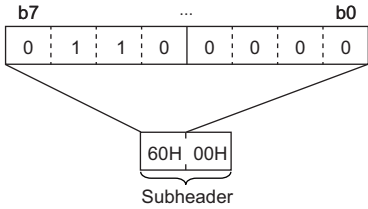
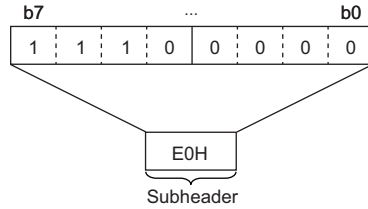
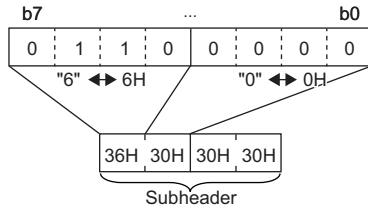
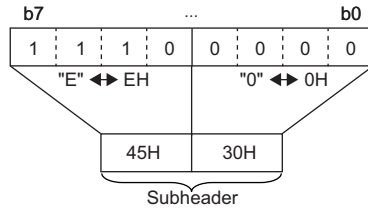
Data Format	Command (external device → RJ71EN71 or RnENCPU (network part))	Response (RJ71EN71 or RnENCPU (network part) → external device)
Binary code	 <p style="text-align: center;">Subheader</p>	 <p style="text-align: center;">Subheader</p>
ASCII code	 <p style="text-align: center;">Subheader</p>	 <p style="text-align: center;">Subheader</p>

■ Data length setting

Shows the amount of data in the text (command) section.

- When exchanging data with binary codes: Maximum 5113 words
- When exchanging data with ASCII codes Maximum 2556 words

Text (command)

Shows the format of the command/response.

- When exchanging data with binary codes

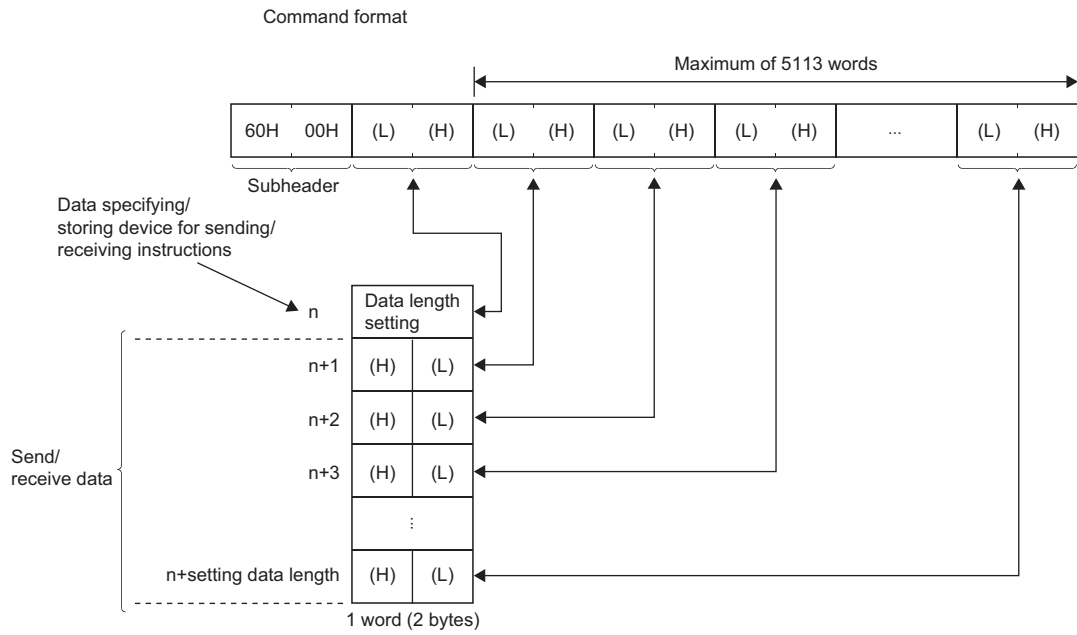

- When exchanging data with ASCII codes

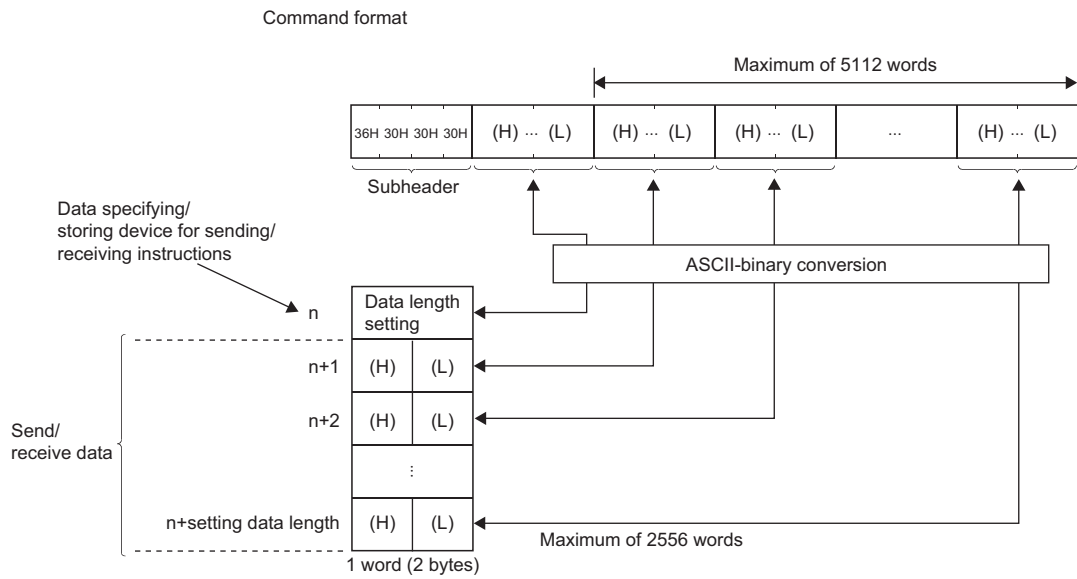

■End code

The error code is stored in the end command added to the response. (☞ Page 468 End Codes Returned to an External Device During Data Communications)

The end code is also stored in the BUFSND instruction and BUFRCV instruction completion status area (inside control data). The following cases may apply if an error code for communications using the SLMP or random access buffer is stored even when executing communications using the fixed buffer.

Description	Remedy method
The data length specified in the application data section of the message sent from the external device to the RJ71EN71 or the RnENCPU (network part) differs from the actual data size in the text section.	Specify the actual data size in the text section as the data length in the application data section. (Refer to the following descriptions.)
The subheader of the message sent from the external device to the RJ71EN71 or the RnENCPU (network part) is incorrect.	Review the subheader specified in the application data section.

The communication data may be split and exchanged due to buffer limitations to the own station or external station. The data that is split and received is restored (reassembled) by the RJ71EN71 or the RnENCPU (network part) and exchanged. (The received data is restored (reassembled) based on the data length in the communication data.) The RJ71EN71 and the RnENCPU (network part) processing that take place when the data in the communication data is incorrect are shown below.

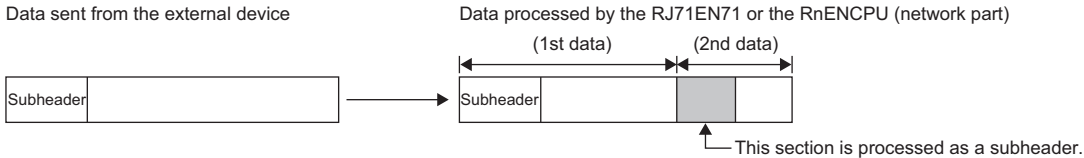
Communication Method	Description
Fixed Buffer (Procedure Exist), Random Access Buffer	<p>When data length specified immediately after subheader < text data volume</p> <ul style="list-style-type: none"> The data immediately after the text corresponding to the data length specified immediately after the subheader is handled as the second message. The start of each statement becomes the subheader, so the RJ71EN71 and the RnENCPU (network part) execute a processing corresponding to the subheader code. If the subheader is not a code supported by the RJ71EN71 and the RnENCPU (network part), an abnormal completion response is sent to the external device. <p>Data sent from the external device</p>  <p>Data processed by the RJ71EN71 or the RnENCPU (network part)</p> <p>In the above case, the code processed as the subheader with the uppermost bit set as 1 is returned as the response. For example, if the command's subheader section is 65H, the response's subheader is E5H.</p>
	<p>When data length specified immediately after subheader > text data volume</p> <p>The RJ71EN71 and the RnENCPU (network part) wait to receive the insufficient remaining data.</p> <p>If the remaining data is received within the response monitor timer value, the RJ71EN71 and the RnENCPU (network part) execute a processing corresponding to the subheader code.</p> <p>If the remaining data is not received within the response monitor timer value, the RJ71EN71 and the RnENCPU (network part) execute the following processing.</p> <ul style="list-style-type: none"> The ABORT(RST) instruction is sent to the external device, and the line is closed. The error code is stored in 'Connection status storage area' (Un\G100 to Un\G163).
Fixed Buffer (No Procedure)	<p>During nonprocedural, there is no message data length, so the received data is stored as is into the receive buffer area. Providing a check procedure including the data length, data type code, and so on, in the message's application data is recommended so that the application data's byte size and data type can be seen on the receiving side.</p>

Example of communications using the fixed buffer

This section describes the socket communications examples using Active open of TCP/IP communications.

System configuration

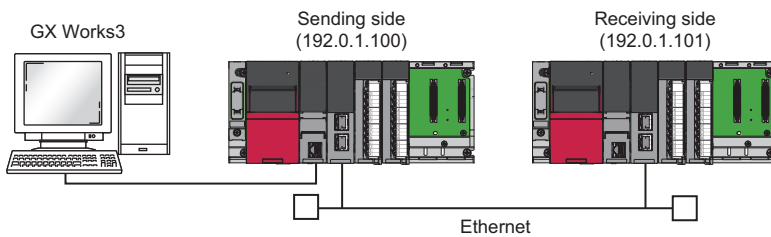

Parameter settings

Connect the engineering tool to the CPU module and set the parameters.

■ Sending side

1. Set the CPU module as follows.

 [Project] ⇒ [New]

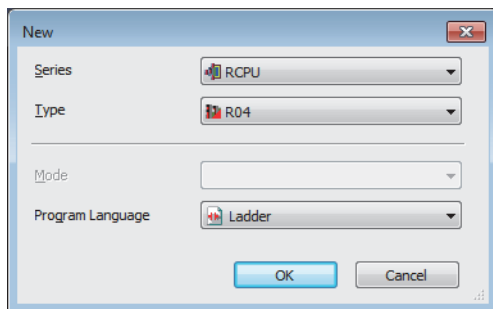

2. Click the [Setting Change] button in the following window and set the item to use module labels.

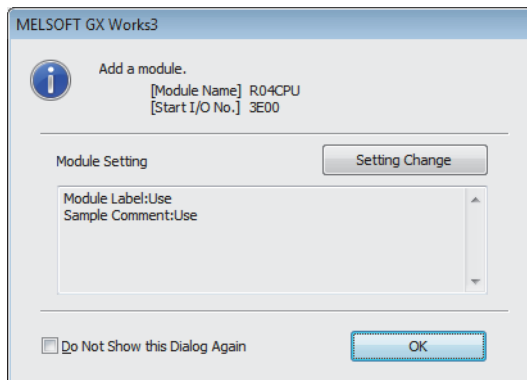

3. Click the [OK] button to add the module labels of the CPU module.

4. Set the RJ71EN71 as follows.

[Navigation window] ⇒ [Parameter] ⇒ [Module Information] ⇒ Right-click ⇒ [Add New Module]

5. Click the [OK] button to add the module labels of the RJ71EN71.

6. Set the items in "Basic Settings" as follows.

[Navigation window] ⇒ [Parameter] ⇒ [Module Information] ⇒ [RJ71EN71] ⇒ [Port 1 Module Parameter (Ethernet)] ⇒ [Basic Settings]

Item	Setting
Own Node Settings	
Parameter Setting Method	Parameter Editor
IP Address	
IP Address	192 . 0 . 1 . 100
Subnet Mask
Default Gateway
Communications by Network No./Station No.	Disable
Setting Method	Use IP Address
Network Number	----
Station No.	-----
Transient Transmission Group No.	0
Enable/Disable Online Change	Disable All (SLMP)
Communication Data Code	Binary
Opening Method	Open by Program
External Device Configuration	
External Device Configuration	<Detailed Setting>

7. Set the network configuration as follows.

[Navigation window] ⇒ [Parameter] ⇒ [Module Information] ⇒ [RJ71EN71] ⇒ [Port 1 Module Parameter (Ethernet)] ⇒ [Basic Settings] ⇒ [External Device Configuration]

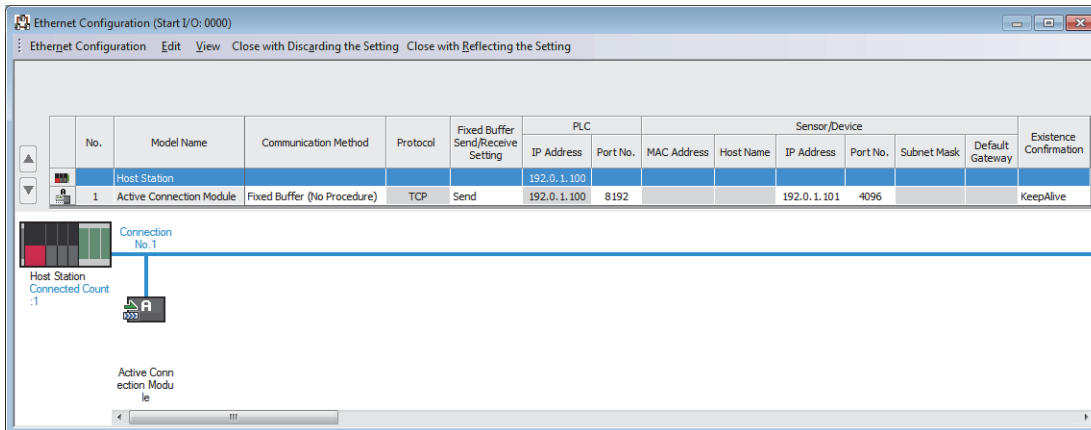

8. Write the set parameters to the CPU module. Then reset the CPU module or power off and on the system.

[Online] ⇒ [Write to PLC]

Point

In this example, default values were used for parameters that are not shown above. For the parameter setting, refer to the chapter explaining the parameters in this manual. (Page 317 PARAMETER SETTINGS)

Receiving side

- Set the CPU module and add the module labels of the CPU module. The setting method of the CPU module and addition method of the module label are the same as those of when setting the sending side. (Page 89 Sending side)
- Set the RJ71EN71 and add the module labels of the RJ71EN71. The setting method of the RJ71EN71 and addition method of the module label are the same as those of when setting the sending side. (Page 89 Sending side)
- Set the items in "Basic Settings" as follows.

[Navigation window] ⇒ [Parameter] ⇒ [Module Information] ⇒ [RJ71EN71] ⇒ [Port 1 Module Parameter (Ethernet)] ⇒ [Basic Settings]

Item	Setting
Own Node Settings	
Parameter Setting Method	Parameter Editor
IP Address	
IP Address	192.0.1.101
Subnet Mask	. . .
Default Gateway	. . .
Communications by Network No./Station No.	Disable
Setting Method	Use IP Address
Network Number	-----
Station No.	-----
Transient Transmission Group No.	0
Enable/Disable Online Change	Disable All (SLMP)
Communication Data Code	Binary
Opening Method	Do Not Open by Program
External Device Configuration	
External Device Configuration	<Detailed Setting>

4. Set the network configuration as follows.

[Navigation window] ⇒ [Parameter] ⇒ [Module Information] ⇒ [RJ71EN71] ⇒ [Port 1 Module Parameter (Ethernet)] ⇒ [Basic Settings] ⇒ [External Device Configuration]

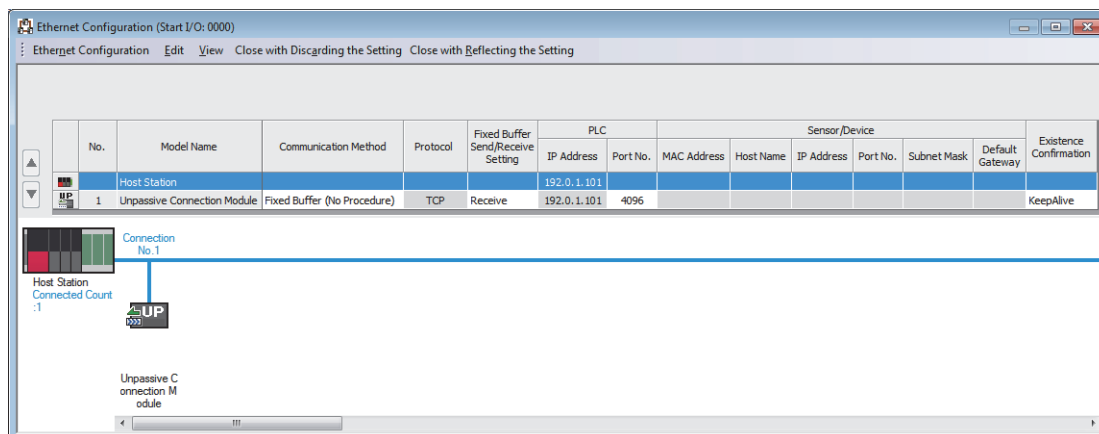

5. Write the set parameters to the CPU module. Then reset the CPU module or power off and on the system.

[Online] ⇒ [Write to PLC]



In this example, default values were used for parameters that are not shown above. For the parameter setting, refer to the chapter explaining the parameters in this manual. (Page 317 PARAMETER SETTINGS)

Program example (sending side)

Labels

Classification	Label name	Description	Device	
Module label	RCPU.stSM.bAlways_ON	Always on	SM400	
	EN71_EE_1.stPort1.uStatus_HUB_Connection_D.0	Connection status	U0\G5192.0	
	EN71_EE_1.bnCompletion_ConnectionOpen[1]	Open completion signal (connection No.1)	U0\G190000.0	
	EN71_EE_1.bnStatus_ConnectionOpenExecution[1]	Open request signal (connection No.1)	U0\G1900008.0	
	EN71_EE_1.uCompletion_EthernetInitialized.0	Initial status	U0\G1900024.0	
Label to be defined	Define global labels as shown below:			
	Label Name	Data Type	Class	Assign (Device/Label)
	bRunRefresh	Bit	VAR_GLOBAL	M0
	bStartOpen	Bit	VAR_GLOBAL	M1
	bRunOpen	Bit	VAR_GLOBAL	M2
	bOpen_OK	Bit	VAR_GLOBAL	M3
	bOpen_NG	Bit	VAR_GLOBAL	M4
	bStartSend	Bit	VAR_GLOBAL	M5
	bRunSend	Bit	VAR_GLOBAL	M6
	bSend_OK	Bit	VAR_GLOBAL	M7
	bSend_NG	Bit	VAR_GLOBAL	M8
	bStartClose	Bit	VAR_GLOBAL	M13
	bRunClose	Bit	VAR_GLOBAL	M14
	bClose_OK	Bit	VAR_GLOBAL	M15
	bClose_NG	Bit	VAR_GLOBAL	M16
	bStartOpenFB	Bit	VAR_GLOBAL	M20
	bStartCloseFB	Bit	VAR_GLOBAL	M21
	uOpenErrID	Word [Unsigned]/Bit String [16-bit]	VAR_GLOBAL	D0
	uSendErrID	Word [Unsigned]/Bit String [16-bit]	VAR_GLOBAL	D10
	uCloseErrID	Word [Unsigned]/Bit String [16-bit]	VAR_GLOBAL	D30
	uSendData	Word [Unsigned]/Bit String [16-bit](0..3)	VAR_GLOBAL	D1000

FBs

The following shows FBs to be used in the program example.

- M_RJ71EN71_EE_Refresh_Data
- M_RJ71EN71_EE_ConnectionOpen
- M_RJ71EN71_EE_Send_Socket
- M_RJ71EN71_EE_ConnectionClose

Program

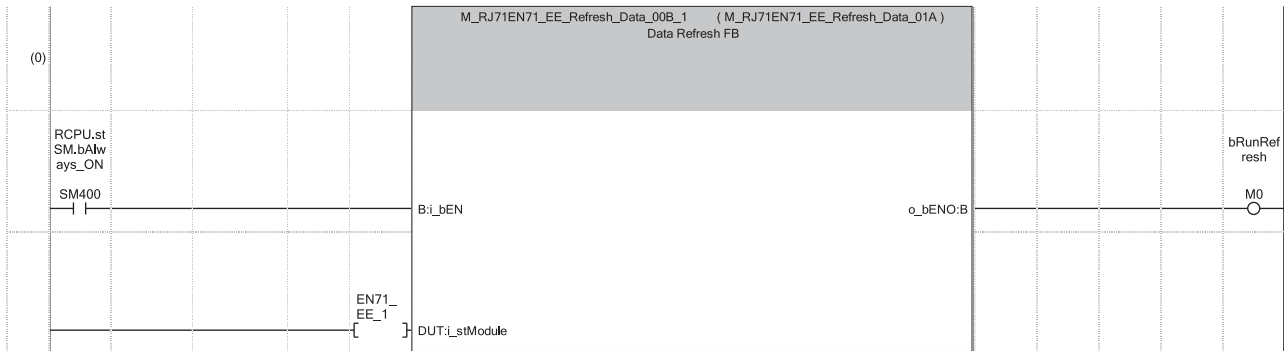

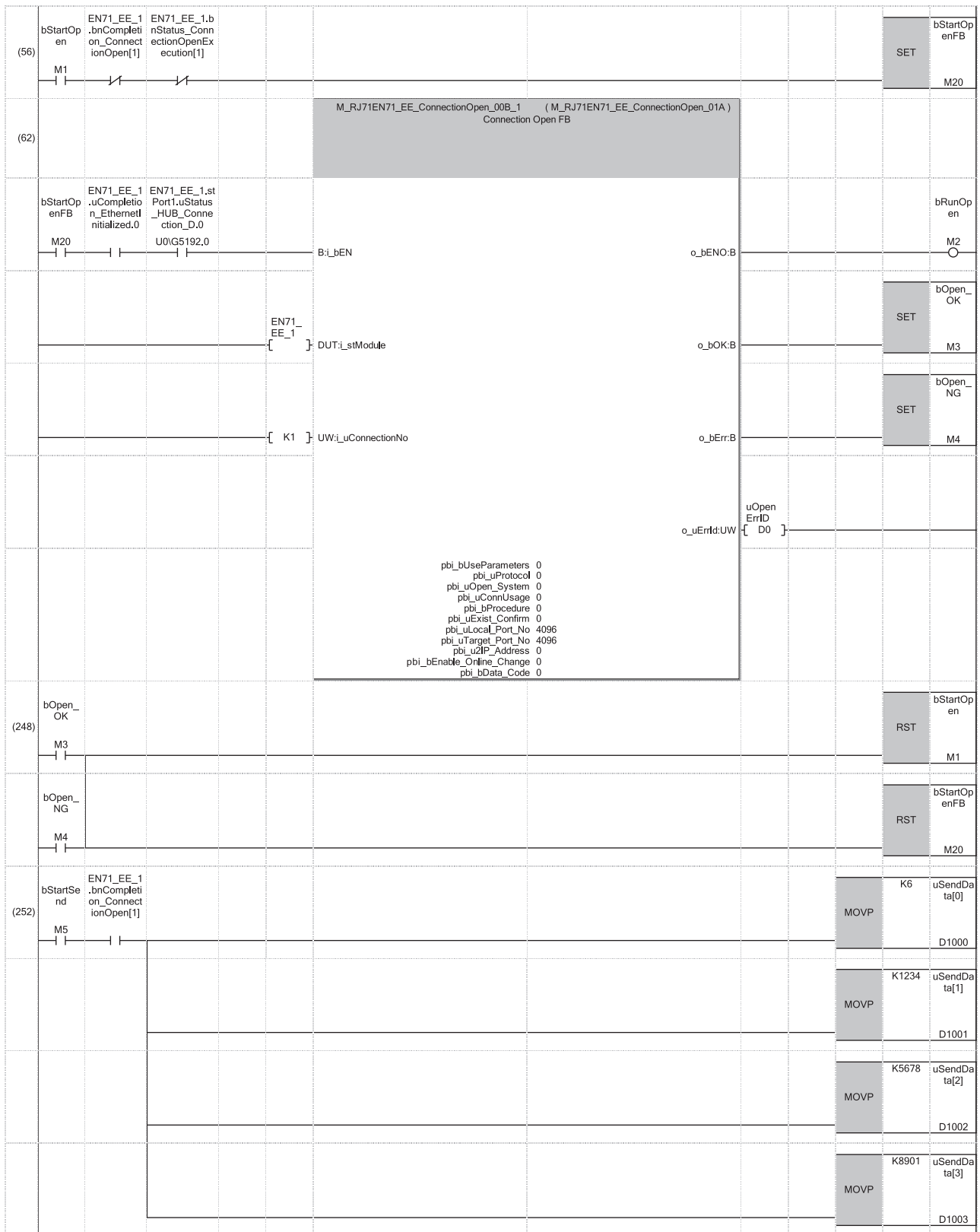

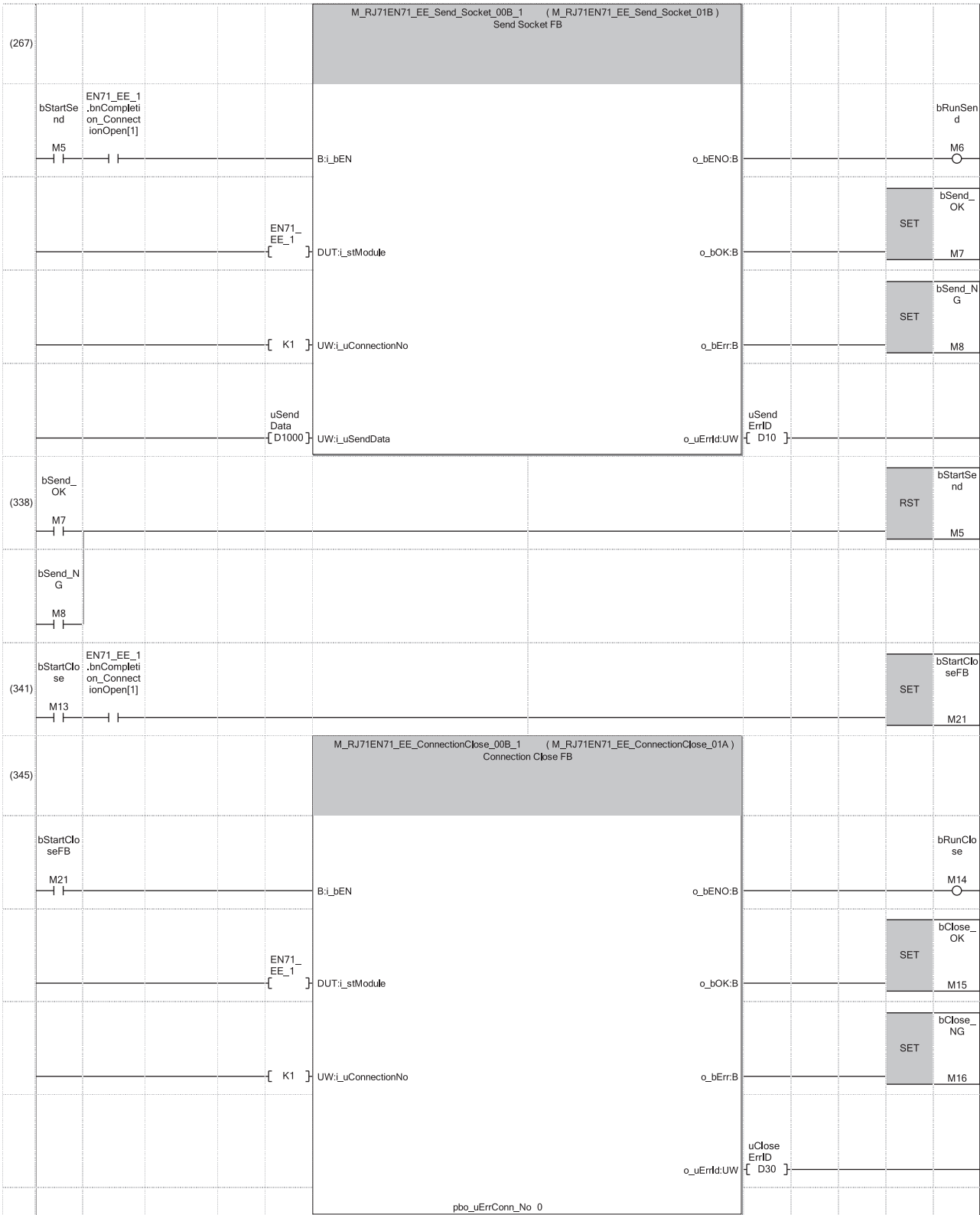

(436)	bClose_ OK											RST	bStartClose
	M15											M13	
(440)	bClose_ NG											RST	bStartCloseFB
	M16											M21	
													{END}

- (0) The refresh processing of the module label is performed. (The processing is required for when using the module function block.)
When the refresh processing is completed, 'bRunRefresh' (M0) is turned on.
- (56) When 'bStartOpen' (M1) is turned on, the open processing of connection No.1 is performed.
When the open processing is completed successfully, 'bOpen_OK' (M3) is turned on.
- (252) When 'bStartSend' (M5) is turned on, the send data is stored and sent to the receiving side.
When the data send is completed successfully, 'bSend_OK' (M7) is turned on.
- (341) When 'bStartClose' (M13) is turned on, the close processing of connection No.1 is performed.
When the close processing is completed successfully, 'bClose_OK' (M15) is turned on.

Program example (receiving side)

Labels

Classification	Label name	Description	Device	
Module label	RCPU.stSM.bAlways_ON	Always on	SM400	
	EN71_EE_1.bnCompletion_ConnectionOpen[1]	Open completion signal (connection No.1)	U0\G1900000.0	
	EN71_EE_1.bnCompletion_ReceiveSocket_FixedBuffer[1]	Socket/fixed buffer reception status signal (connection No.1)	U0\G1900016.0	
	EN71_EE_1.uCompletion_EthernetInitialized.0	Initial status	U0\G1900024.0	
Label to be defined	Define global labels as shown below:			
	Label Name	Data Type	Class	Assign (Device/Label)
	bRunRefresh	Bit	VAR_GLOBAL	M0
	bStartRecv	Bit	VAR_GLOBAL	M9
	bRunRecv	Bit	VAR_GLOBAL	M10
	bRecv_OK	Bit	VAR_GLOBAL	M11
	bRecv_NG	Bit	VAR_GLOBAL	M12
	bStartRecvFB	Bit	VAR_GLOBAL	M17
	uRecvErrID	Word [Unsigned]/Bit String [16-bit]	VAR_GLOBAL	D20
	uRecvData	Word [Unsigned]/Bit String [16-bit](0..5119)	VAR_GLOBAL	D2000

FBs

The following shows FBs to be used in the program example.

- M_RJ71EN71_EE_Refresh_Data
- M_RJ71EN71_EE_Recv_Socket

Program

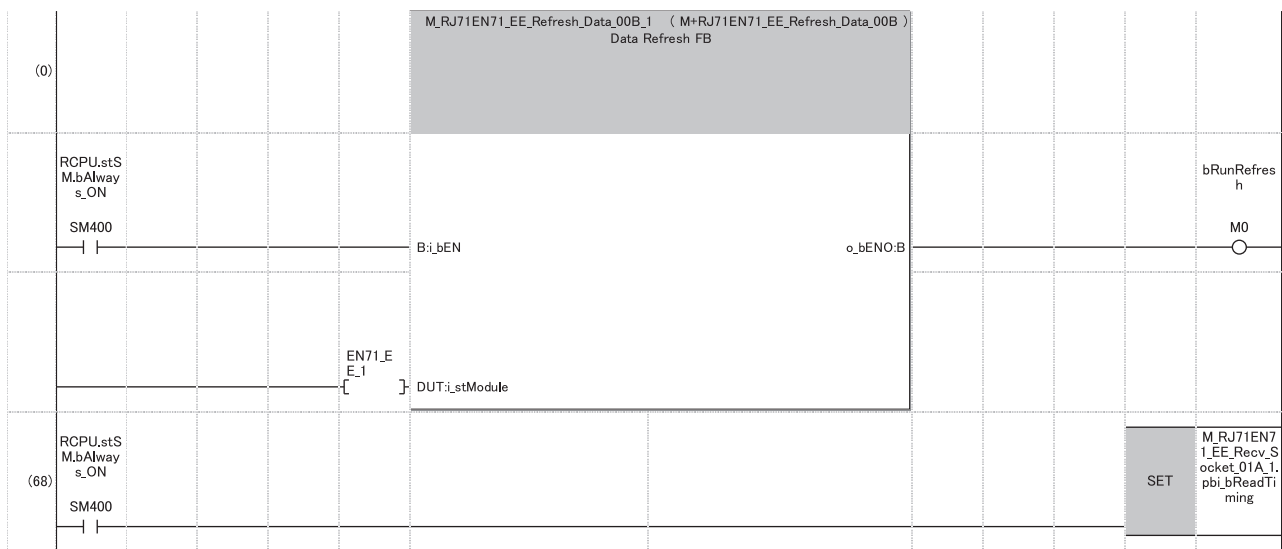

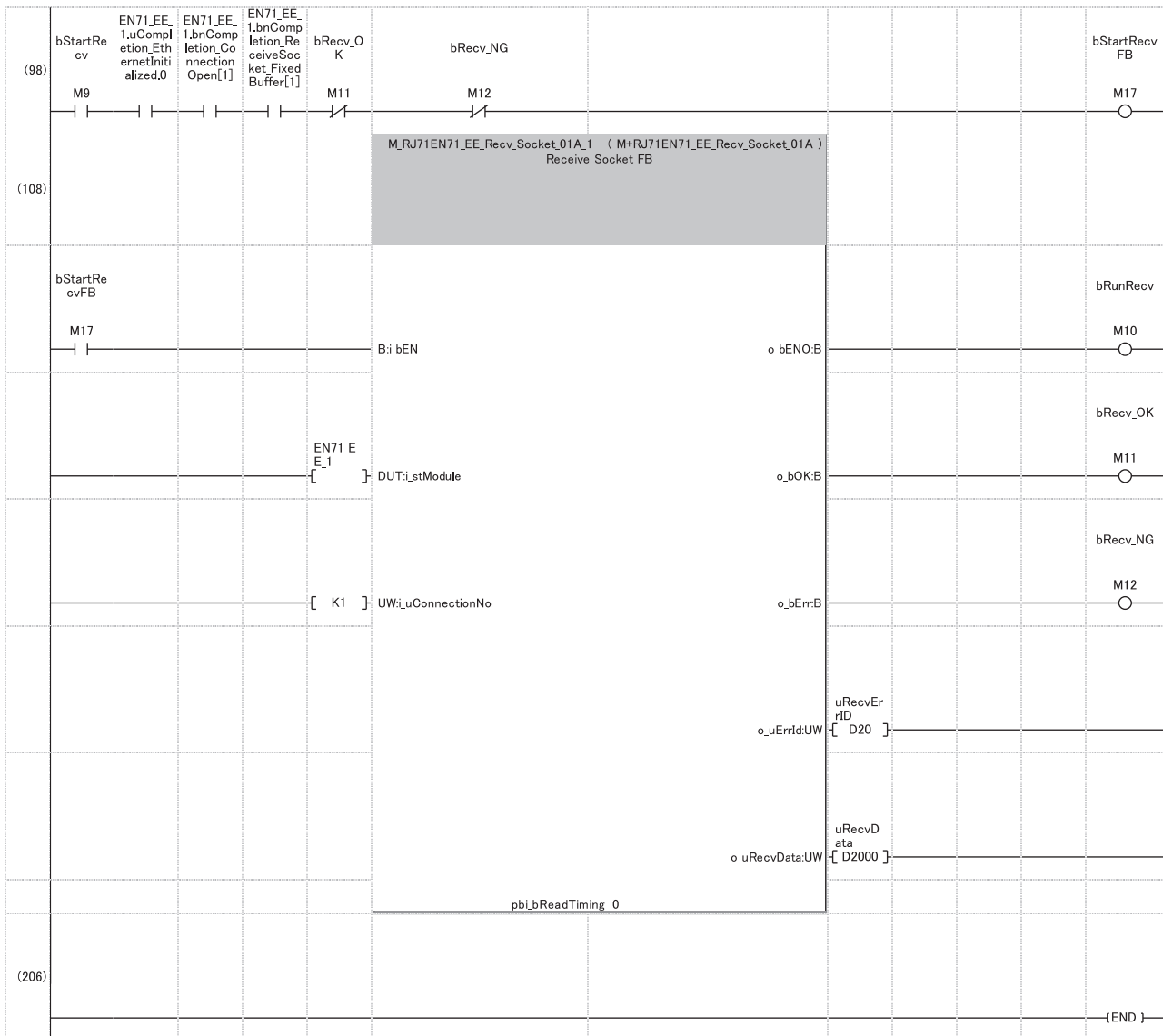

- (0) The refresh processing of the module label is performed. (The processing is required for when using the module function block.)
When the refresh processing is completed, 'bRunRefresh' (M0) is turned on.
- (98) When 'bStartRecv' (M9) is turned on, the data sent from the sending side is received and stored in 'uRecvData' (D2000).
(The device range in which data is stored varies depending on the data length of the received data.)
When the data receive is completed successfully, 'bRecv_OK' (M11) is turned on.

Point

- Secure sufficient device areas according to the maximum length of data sent from the send source to prevent the device areas used for other purposes from being overwritten by the receive data.
- When the data receive is consecutively executed, turn on pbi_bReadTiming (read timing) as shown in the above program.
- To receive data at shorter intervals than the scan time of the CPU module, add the normally closed contact of 'bRecv_OK' (M11) and 'bRecv_NG' (M12) to the execution conditions of FB for receiving as shown in the above program. When there is no normally closed contact of 'bRecv_OK' (M11) and 'bRecv_NG' (M12), 'bStartRecvFB' (M17) is not turned off and on and the FB for receiving may not be executed.

1.6 Communications Using the Random Access Buffer

With communications using the random access buffer, data can be freely read and written between any external device (excluding Ethernet-equipped module) and the RJ71EN71 or the RnENCPU (network part). The external device does not need to be fixed. The random access buffer is used as the common buffer area for external devices connected to the Ethernet.

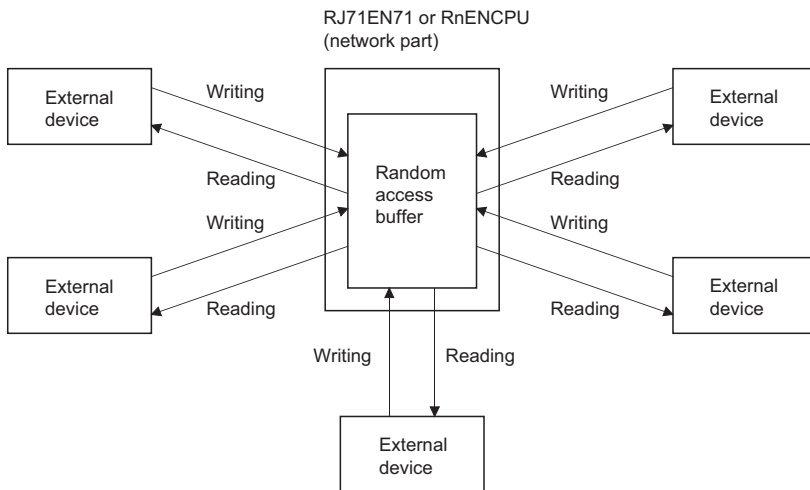

Precautions

The CPU module (CPU part for the RnENCPU) cannot exchange data with the random access buffer.

Setting procedure

Set "External Device Configuration" under "Basic Settings". (📖 Page 320 External Device Configuration)

1. Select the external device to be connected in "Module List" and drag it to "List of devices" or "Device map area".

External device name	Description
UDP Connection Module	Select to communicate with the external device using UDP/IP.
Active Connection Module	Select to perform the open processing to the external device from the Ethernet-equipped module (Active open) and communicate using TCP/IP.
Unpassive Connection Module	Select to receive the open processing from an unspecified external device (Unpassive open) and communicate using TCP/IP.
Fullpassive Connection Module	Select to receive the open processing from the specified external device (Fullpassive open) and communicate using TCP/IP.

2. Set "Communication Method" for external device to "Random Access Buffer".
3. Set the IP address of the external device.
4. Set the other parameters required for communication in the connection. (📖 Page 320 External Device Configuration)

Communication structure

This section describes the mechanism of communications using the random access buffer.

Data flow

The following figure shows the flow of data communications using the random access buffer.

A dedicated packet is used to exchange data between the external device and the RJ71EN71 or the RnENCPU (network part).

A program is used to access the random access buffer from the CPU module.

Point

The process is executed asynchronously with the program, so if synchronization is required, use socket communications or communications using the fixed buffer.

External devices capable of data exchange

Data can be exchanged with the following external devices.

- Devices in Ethernet to which the RJ71EN71 is connected
- Devices in Ethernet to which the RnENCPU (network part) is connected
- Device connected via router

Procedure for reading from external device

The following figure shows the processing when sending data from the RJ71EN71 or the RnENCPU (network part) in response to a read request from the external device.

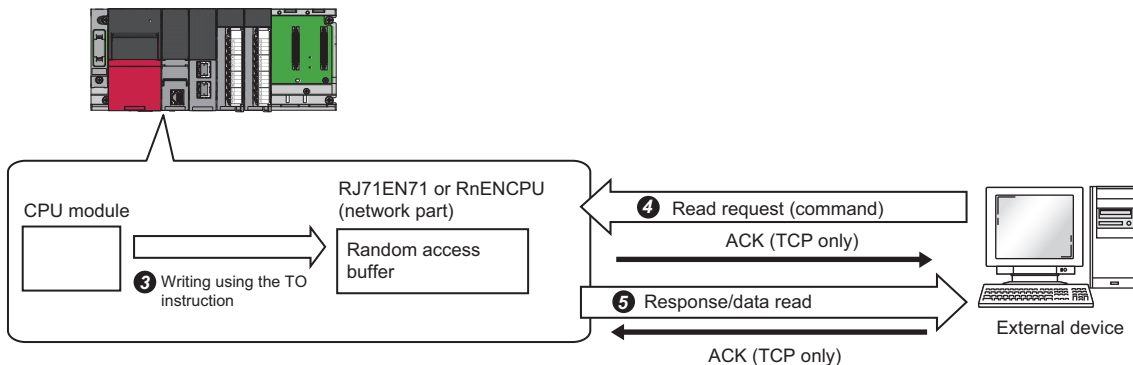

- 1 After the module parameters are set, check that the initial processing of the RJ71EN71 or the RnENCPU (network part) has completed normally. ('Initial status' (Un\G1900024.0): On)
- 2 The open processing is executed to establish a connection between the RJ71EN71 or the RnENCPU (network part) and external device. (Page 525 TCP/IP Communications, UDP/IP Communications)
- 3 The program writes the data into the random access buffer of the RJ71EN71 or the RnENCPU (network part).
- 4 The read request is sent from the external device to the RJ71EN71 or the RnENCPU (network part) asynchronously from the above processing. (RJ71EN71 or RnENCPU (network part) side: Receives command)
- 5 When the read request is received from the external device, the RJ71EN71 or the RnENCPU (network part) send the data written into the random access buffer to the external device. (RJ71EN71 or RnENCPU (network part) side: Sends response)
- 6 The connection is closed when communication is finished.

Procedure for writing from external device

The following shows the procedure when writing data from the external device to the random access buffer of the RJ71EN71 or the RnENCPU (network part).

- 1.** After the module parameters are set, check that the initial processing of the RJ71EN71 or the RnENCPU (network part) has completed normally. ('Initial status' (Un\G1900024.0): On)
- 2.** The open processing is executed to establish a connection between the RJ71EN71 or the RnENCPU (network part) and external device. (Page 525 TCP/IP Communications, UDP/IP Communications)
- 3.** Data is written from the external device to the random access buffer of the RJ71EN71 or the RnENCPU (network part). (RJ71EN71 or RnENCPU (network part) side: Receives command)
- 4.** The RJ71EN71 or the RnENCPU (network part) execute the write processing requested by the external device, and returns the write results to the external device that sent the write request. (RJ71EN71 or RnENCPU (network part) side: Sends response)
- 5.** The data written in the random access buffer is read asynchronously from the above the processing by the program.
- 6.** Close the connection when communication is finished.

Physical address and logical address of random access buffer

This section describes the start address of the random access buffer of the RJ71EN71 or the RnENCPU (network part) specified in the command.

The address specified for the random access buffer differs from the address specified by the external device and the address specified with the FROM/TO instruction.

- Physical address: Address specified with program's FROM/TO instruction
- Logical address: Address specified by external device in start address item of command

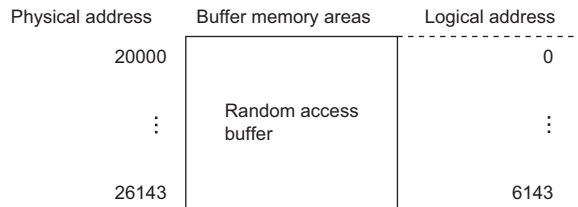

Precautions

The following section lists the precautions for communications using the random access buffer.

Precautions for programming

■Initial processing and open processing completion

The initial processing and connection open processing must be completed.

■Send request from CPU module

Send cannot be requested from the CPU module. Completion of sending to CPU module is not checked. If the data send/receive must be synchronized between the CPU module and external device, use fixed buffer communication.

■Random access buffer address

The address specified by the external device is different from the address specified with the FROM/TO instruction. For details, refer to the following.

(☞ Page 102 Physical address and logical address of random access buffer)

Data format

The communication data is configured of the header and application data.

Header

The header is for TCP/IP or UDP/IP. The RJ71EN71 or the RnENCPU (network part) automatically adds and deletes the header, the setting is not required.

■Details of header section size

The details of the header section data format and size are shown below.

- TCP/IP

Ethernet (14 bytes)	IP (20 bytes)	TCP (20 bytes)
---------------------	---------------	----------------

- UDP/IP

Ethernet (14 bytes)	IP (20 bytes)	UDP (8 bytes)
---------------------	---------------	---------------

Application data

The application data expresses the following data code as binary code or ASCII code. Switch between the binary code and ASCII code with "Own Node Settings" under "Basic Settings". (Page 318 Own Node Settings)

Format

- When exchanging data with binary codes

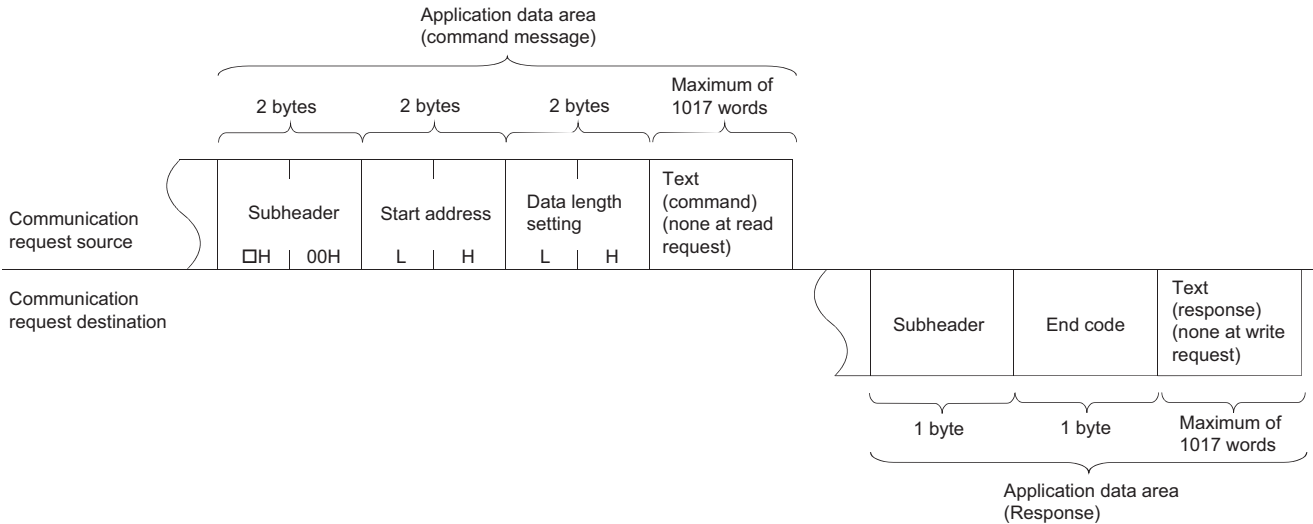

- When exchanging data with ASCII codes

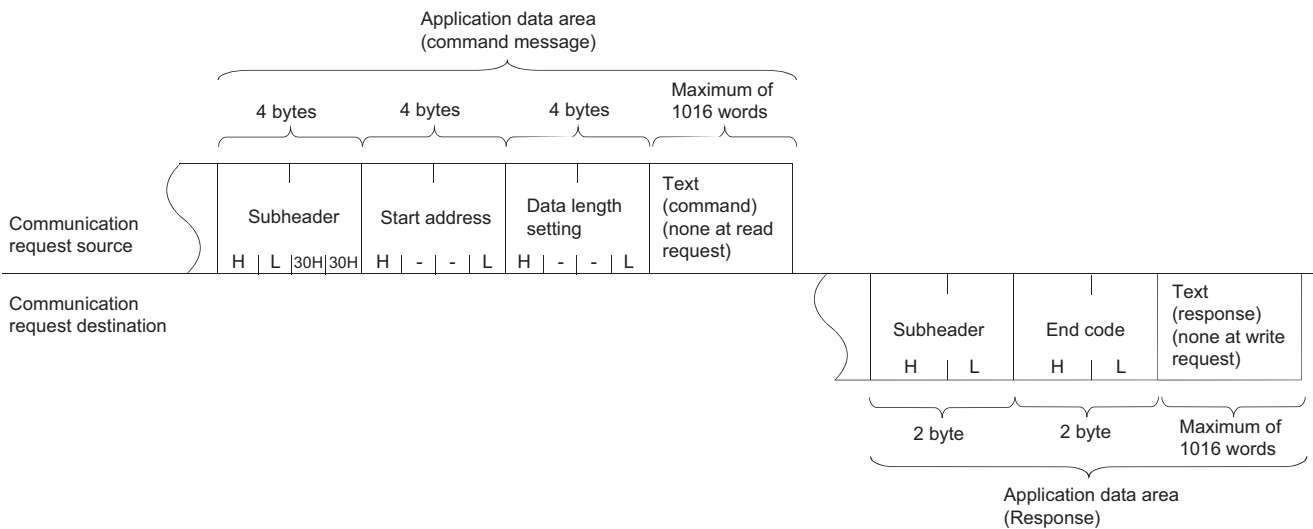

Subheader

The RJ71EN71 or the RnENCPU (network part) automatically adds and deletes the subheader, the setting is not required.

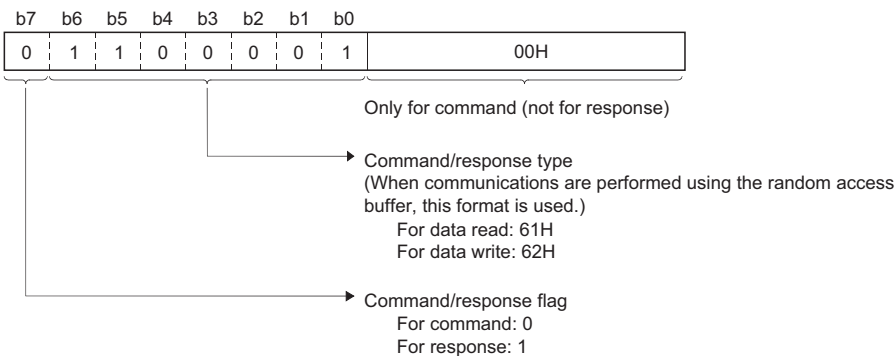

- During read

Data format	Command (external device → RJ71EN71 or RnENCPU (network part))	Response (RJ71EN71 or RnENCPU (network part) → external device)
Binary code	<p>Diagram showing binary code for Command: b7 0, 1, 1, 0, 0, 0, 0, b0 1. A bracket under the last four bits (0, 0, 0, 1) is labeled "61H 00H" and "Subheader".</p>	<p>Diagram showing binary code for Response: b7 1, 1, 1, 0, 0, 0, 0, b0 1. A bracket under the last four bits (0, 0, 0, 1) is labeled "E1H" and "Subheader".</p>
ASCII code	<p>Diagram showing ASCII code for Command: b7 0, 1, 1, 0, 0, 0, 0, b0 1. "6" ↔ 6H and "1" ↔ 1H. A bracket under 36H, 31H, 30H, 30H is labeled "Subheader".</p>	<p>Diagram showing ASCII code for Response: b7 1, 1, 1, 0, 0, 0, 0, b0 1. "E" ↔ EH and "1" ↔ 1H. A bracket under 45H, 31H is labeled "Subheader".</p>

■Start Address

The start address of the random access buffer range where data read/write is executed is expressed as a logical address.

(☞ Page 102 Physical address and logical address of random access buffer)

- When exchanging data with binary codes

Specify the head address with a binary value.

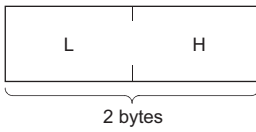

- When exchanging data with ASCII codes

Specify the ASCII code for expressing the start address as a hexadecimal.

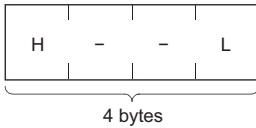

■Data length setting

Express the number of read/write data words with the random access buffer range.

- When exchanging data with binary codes

Specify the number of words as a binary value. (Maximum 1017 words)

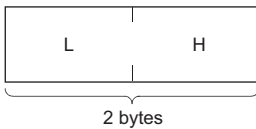

- When exchanging data with ASCII codes

Specify the ASCII code when expressing the number of words as a hexadecimal. (Maximum 508 words)

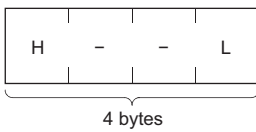

Text

- When exchanging data with binary codes

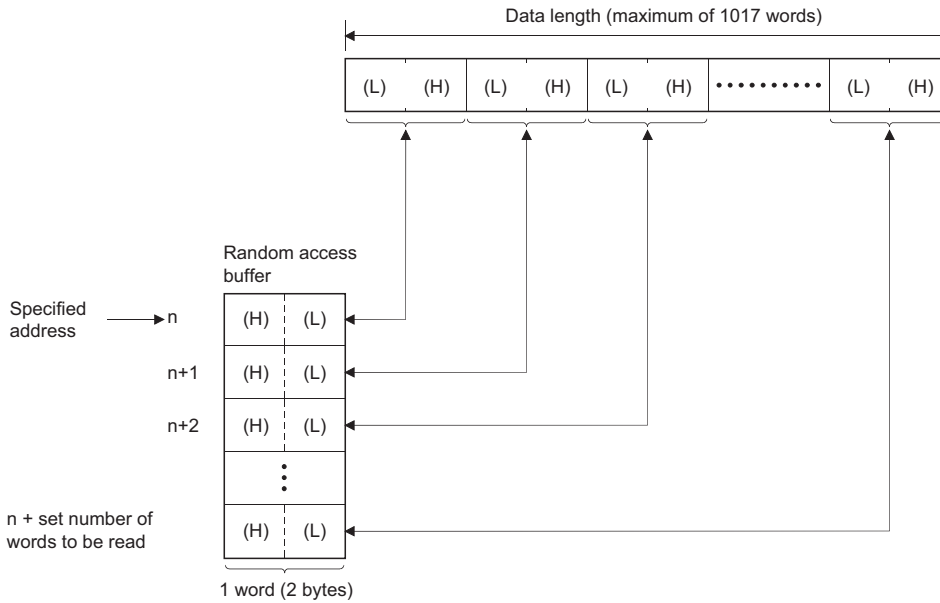

- When exchanging data with ASCII codes

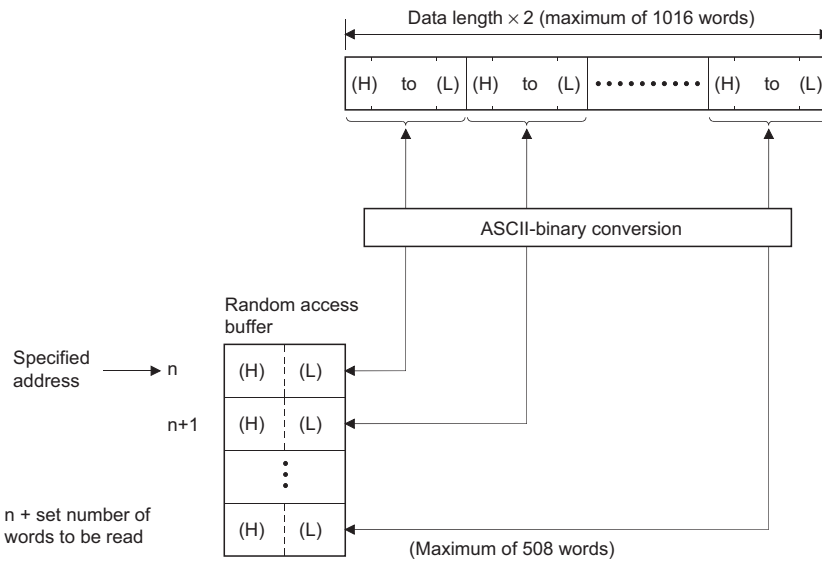

Ex.

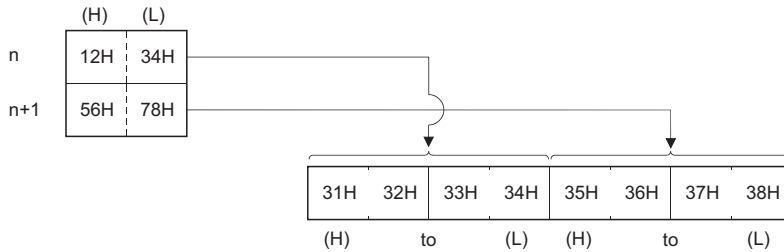

End code

The error code is stored in the end command added to the response. (Page 468 End Codes Returned to an External Device During Data Communications)

Example of command/response format

The following section shows an example of the command and response format.

■ Writing to buffer with write request from external device

- When exchanging data with binary codes

Command format (external device → RJ71EN71)

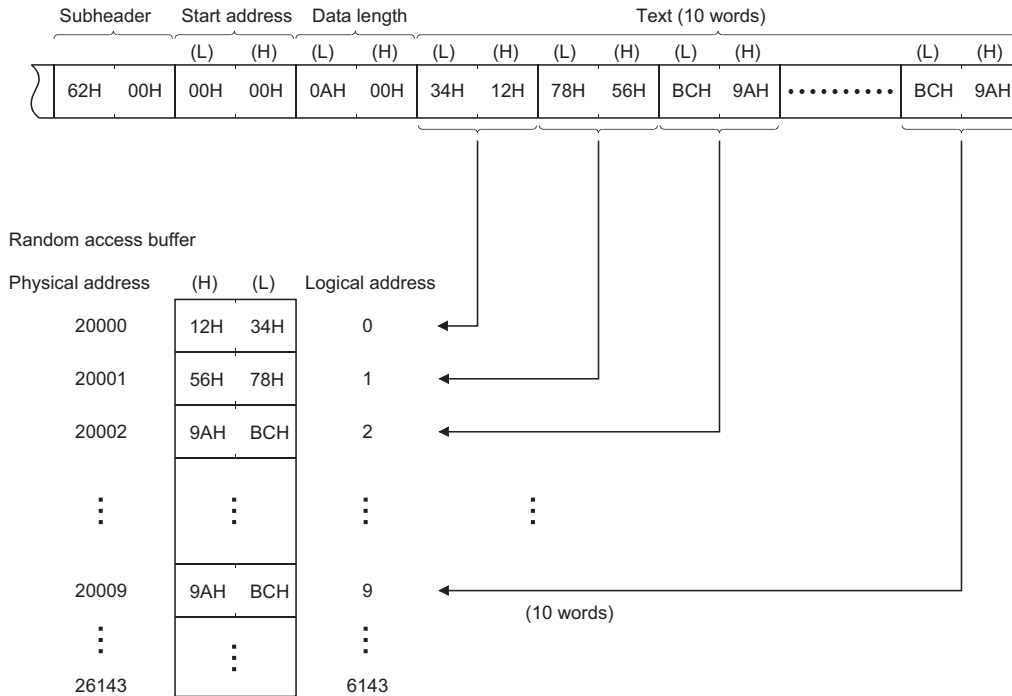

Response format (RJ71EN71 → external device)

Subheader	End code
E2H	00H

- When exchanging data with ASCII codes

Command format (external device → RJ71EN71)

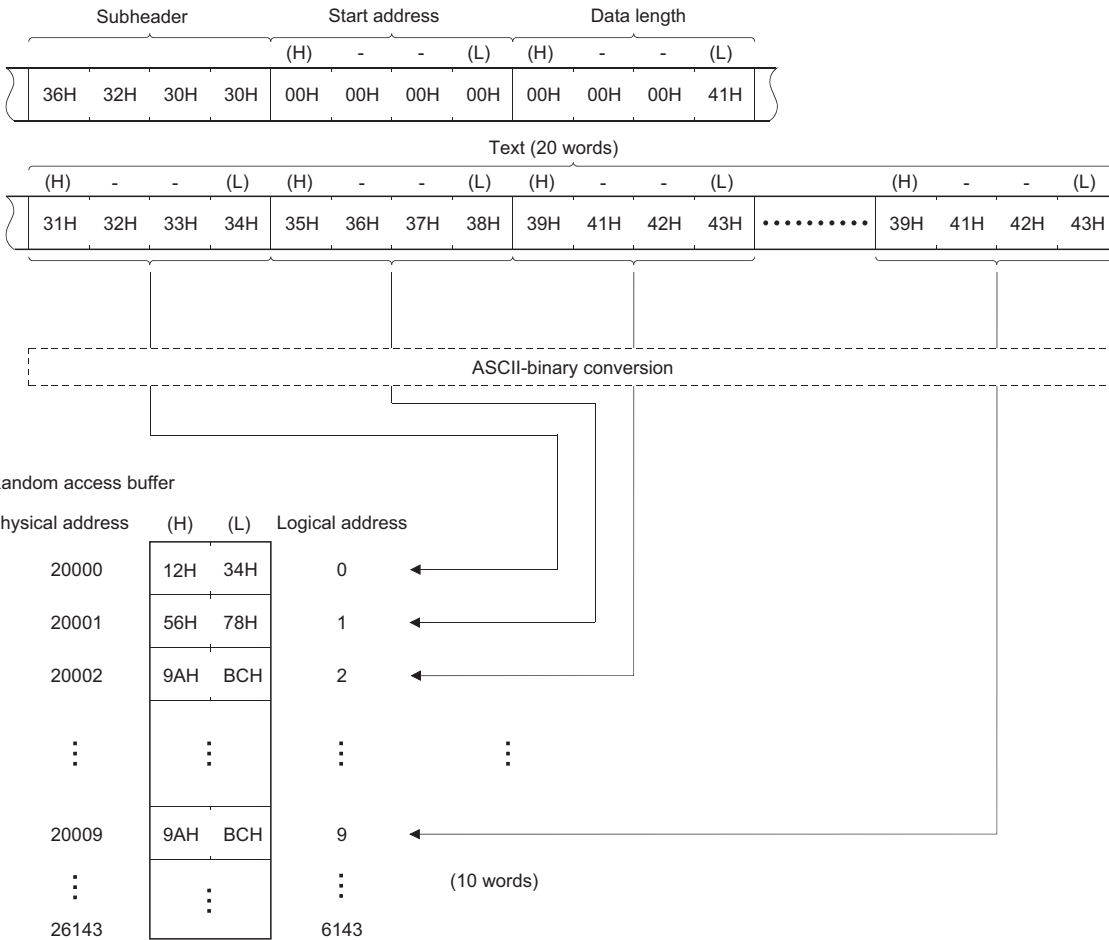

Response format (RJ71EN71 → external device)

Subheader	End code
45H 32H	30H 30H

Reading from buffer with read request from external device

- When exchanging data with binary codes

Command format (external device → RJ71EN71)

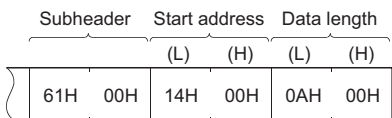

Response format (RJ71EN71 → external device)

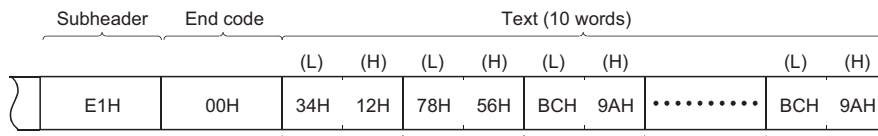

Random access buffer

Physical address	(H)	(L)	Logical address
20000			0
⋮	⋮	⋮	⋮
20020	12H	34H	20
20021	56H	78H	21
20022	9AH	BCH	22
⋮	⋮	⋮	⋮
20029	9AH	BCH	29
⋮	⋮	⋮	⋮
26143			6143

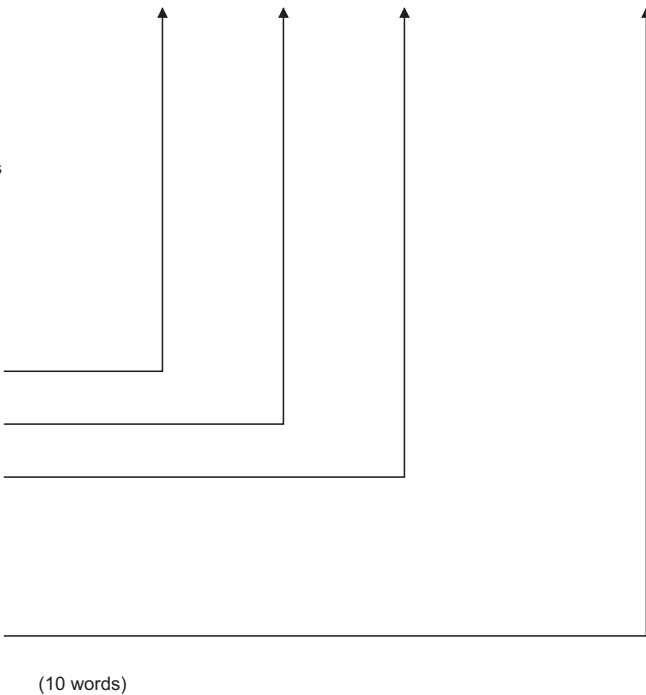

(10 words)

- When exchanging data with ASCII codes

Command format (external device → RJ71EN71)

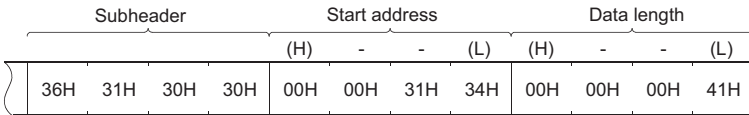

Response format (RJ71EN71 → external device)

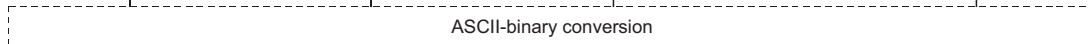
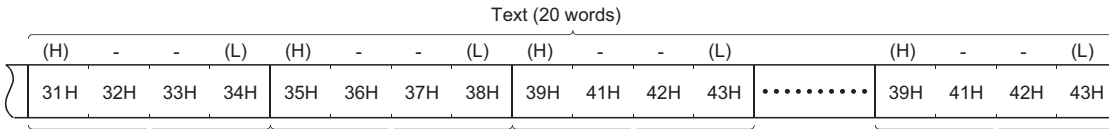
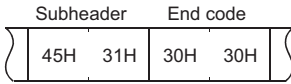

Random access buffer

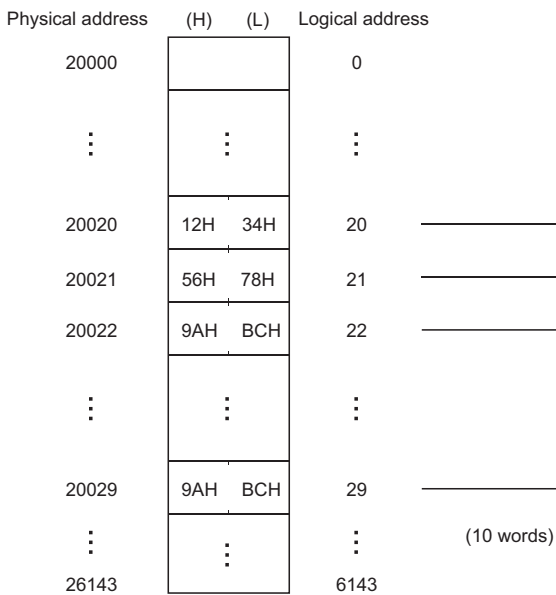

Example of communications with random access buffer

The following figure shows an example of the write operation from the external device.

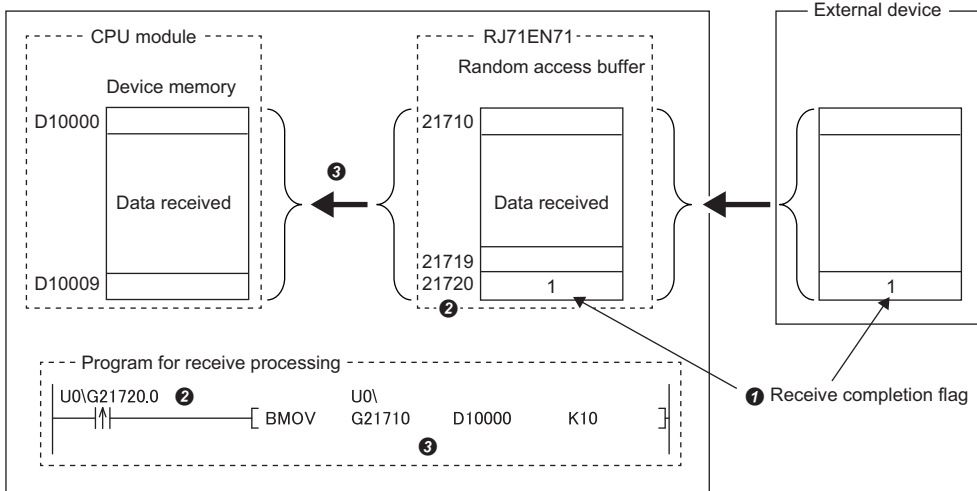

- ① The receive completion flag is set at the end of the received data.
- ② The receive completion flag is monitored.
- ③ When the receive completion flag turns on, the data is transferred from the random access buffer to the CPU module.

1.7 Communications Using MODBUS/TCP

MODBUS protocol messages are sent/received via the TCP/IP network.

For communications using MODBUS/TCP, refer to the following.

📖 MELSEC iQ-R MODBUS and MODBUS/TCP Reference Manual

MODBUS/TCP master function

A module communicates with a MODBUS/TCP slave device as a master station using one of the following functions.

Function	Description	Available module	Reference source
Communications using the predefined protocol	Executes the protocol using the dedicated instructions when a MODBUS/TCP is selected from the predefined protocol library.	<ul style="list-style-type: none"> CPU module (built-in Ethernet port part) RJ71EN71, RnENCPU (network part) 	Page 36 Communications Using the Predefined Protocol 📖 Ethernet Predefined Protocol Library (Standard Equipped Protocol) Reference Manual (for MODBUS/TCP) [EPM-M002]
Simple CPU communication function	Issues a request message for reading/writing to a MODBUS/TCP slave device automatically.	RJ71EN71, RnENCPU (network part)	Page 188 Simple CPU Communication Function (RJ71EN71, RnENCPU (Network Part))
Simple device communication function	Executes the protocol when a MODBUS/TCP is selected from the simple device communication library.	RJ71EN71, RnENCPU (network part)	Page 251 Simple Device Communication Function 📖 MELSEC iQ-R Simple Device Communication Library Reference Manual

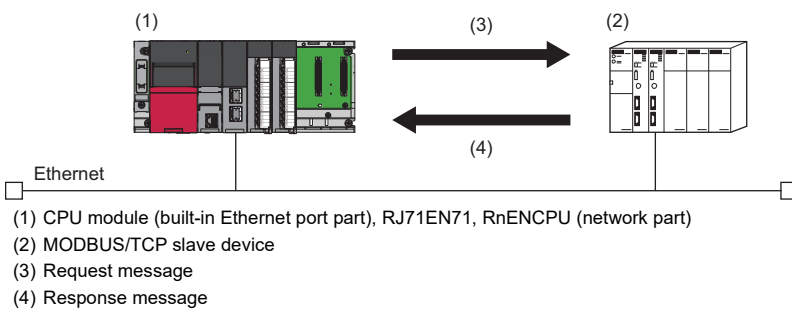

MODBUS/TCP slave function

A module communicates with a MODBUS/TCP master device as a slave station using the automatic operations described in the following pages.

- 📖 Page 113 Automatic response to MODBUS/TCP master device
- 📖 Page 114 Automatic conversion from MODBUS device

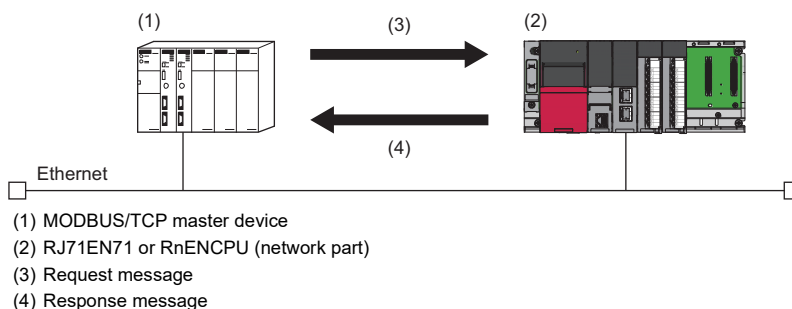

Restriction

- Before using this function, check the firmware version of the module. (📖 Page 564 Added and Enhanced Functions)
- This function is not available when the network type is set to "Q Compatible Ethernet" for the RJ71EN71.

Automatic response to MODBUS/TCP master device

When receiving a request message from the MODBUS/TCP master device, the RJ71EN71 or RnENCPU (network part) automatically executes a necessary processing depending on the function code and sends a response message to the MODBUS/TCP master device.

No program is required because the function of automatic conversion from MODBUS device is used. (☞ Page 114 Automatic conversion from MODBUS device)

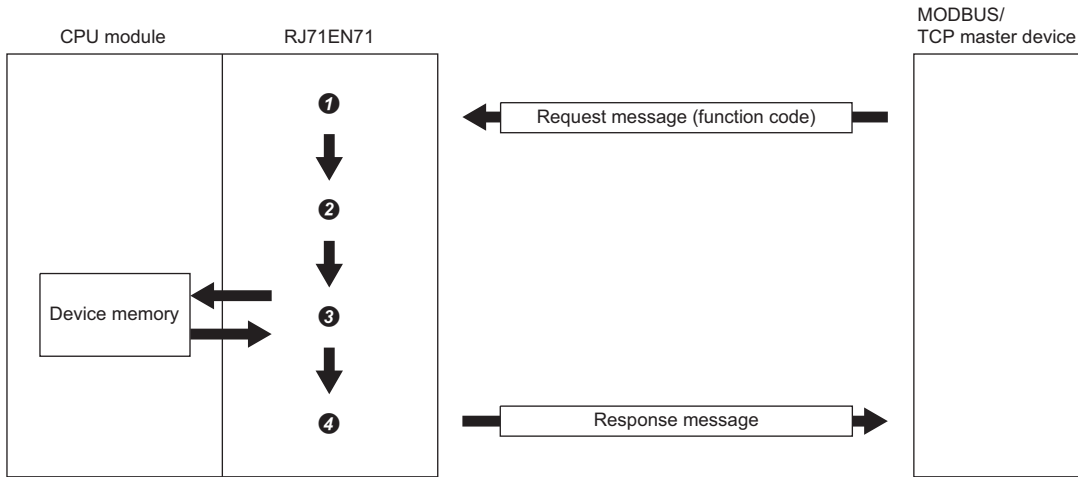

- ❶ A request message is received.
- ❷ The function code is checked.
- ❸ The requested processing is executed.
- ❹ The response message is sent.

This section lists the function codes (MODBUS standard functions) that can be executed from the MODBUS/TCP master device to the RJ71EN71 and RnENCPU (network part). (📖 MELSEC iQ-R MODBUS and MODBUS/TCP Reference Manual)

Function code (FC)	Sub-code (SC)	Function name
01H	—	Read coil
02H	—	Read input
03H	—	Read holding register
04H	—	Read input register
05H	—	Write single coil
06H	—	Write single register
0FH	—	Write multiple coils
10H	—	Write multiple register
14H	06H	Read extended file register
15H	06H	Write extended file register
16H	—	Mask-write holding register
17H	—	Read/write multiple register

■Setting procedure

Set the automatic response function in "External Device Configuration" under "Basic Settings". (☞ Page 320 External Device Configuration)

1. Select "MODBUS/TCP Connection Module" in "Module List", and drag it to "List of devices" or "Device map area".
2. Set "Port No." and "Existence Confirmation".

When multiple devices are set in "MODBUS/TCP Connection Module", set the same value to "Port No." of all devices.

3. Select [Close with Reflecting the Setting] to finish the external device configuration settings.

■Open/close timing

After the initial processing of the RJ71EN71 and RnENCPU (network part) completes, the port automatically opens according to the parameter settings. The port automatically closes when the station on which the RJ71EN71 and RnENCPU (network part) are mounted is turned off or reset.

■Precautions

When a dedicated instruction and the automatic communication function are simultaneously used with the QJ71MT91 set as the MODBUS/TCP master device, set two devices to "MODBUS/TCP Connection Module" in "External Device Configuration". For dedicated instructions and the automatic communication function of the QJ71MT91, refer to the following.

📖 MODBUS/TCP Interface Module User's Manual

Automatic conversion from MODBUS device

This function automatically converts the access to the MODBUS devices of the RJ71EN71 and RnENCPU (network part) into the access to the devices of the CPU module.

Use the MODBUS device assignment parameters to create the association between the MODBUS devices and the device memory areas of the CPU module.

This allows the RJ71EN71 and RnENCPU (network part) to convert the access to the MODBUS device specified in the request message from the MODBUS/TCP master device into the access to the corresponding device of the CPU module.

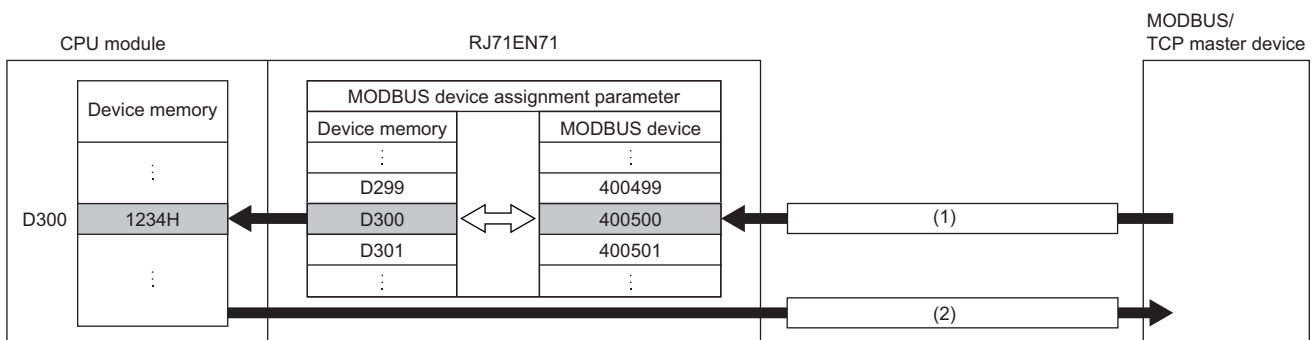

(1) Request message (request for reading the value in holding register 400500)

(2) Response message (response with the value in holding register 400500 (1234H))

■Setting procedure

Set the assignment to the MODBUS devices in "MODBUS/TCP Settings" under "Application Settings". (📖 Page 331 MODBUS/TCP Settings)

MODBUS device assignment parameters

The parameters are used to associate the MODBUS devices with the device memory areas of the CPU module. Using the parameters enables direct access from a MODBUS/TCP master device to the device memory areas of the CPU module.

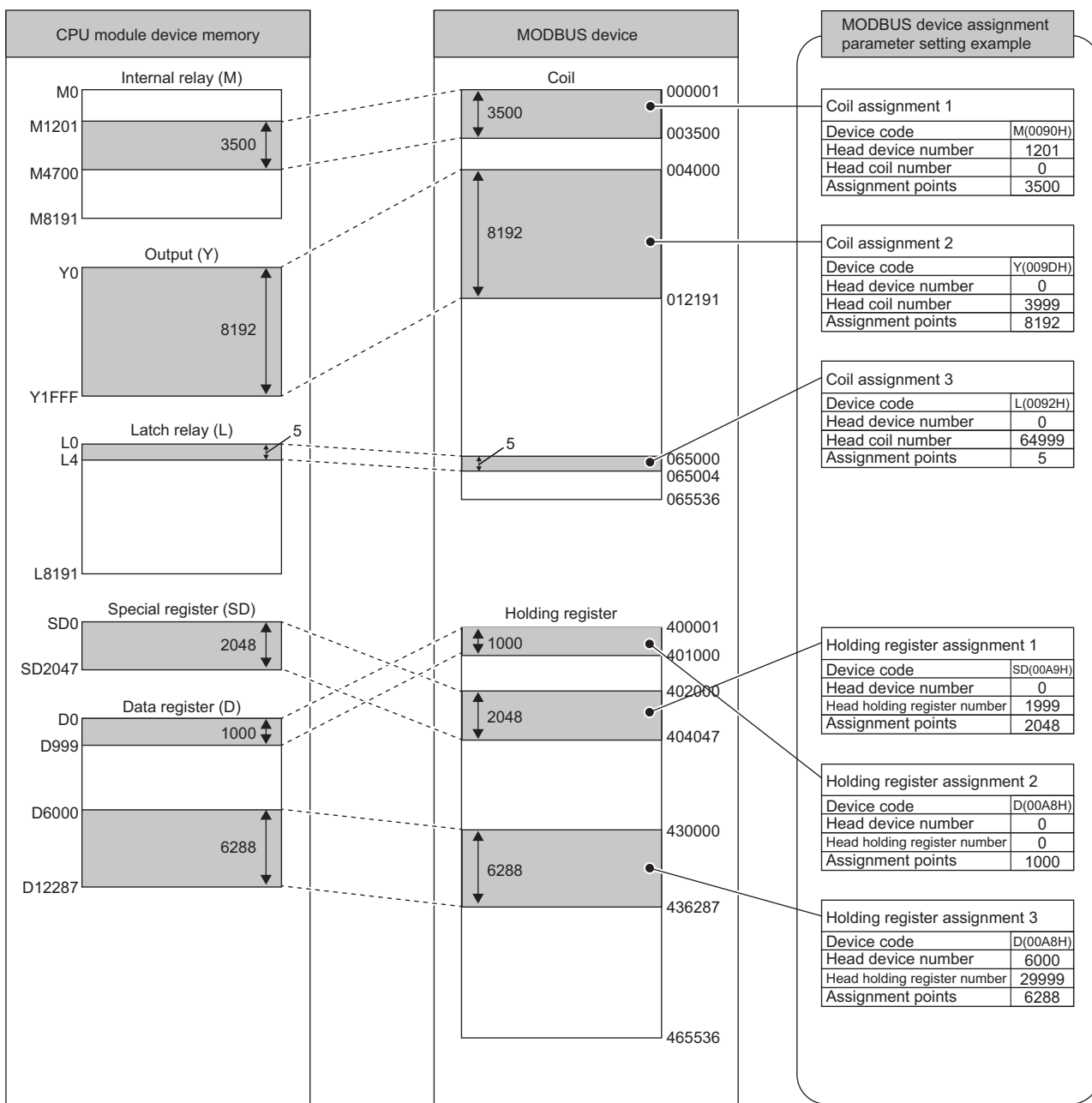

■MODBUS devices

The following table lists the MODBUS devices supported by the RJ71EN71 and RnENCPU (network part).

MODBUS device type	Unit	Read/write	Number of access points	MODBUS device No.
Coil	Bit	Read/write	65536 points	1 to 65536
Input	Bit	Read	65536 points	100001 to 165536
Input register	Word	Read	65536 points	300001 to 365536
Holding register	Word	Read/write	65536 points	400001 to 465536
Extended file register	Word	Read/write ^{*1}	10027008 points	File number: 0 to 1002 ^{*2,3} Device number: 600000 to 609999

*1 For the CPU module, read-only memory cannot be set in the file register.

*2 The maximum values of the number of access points and the file number for the extended file register depend on the size of the file register (ZR) set in the CPU module. (☞ Page 116 MODBUS extended file register assignment)

*3 The number of access points for the extended file register is the maximum size that can be set in the CPU module (when the R120CPU + NZ2MC-16MBS are mounted).

■MODBUS extended file register assignment

The assignment of the MODBUS extended file register to the CPU module is fixed to the file register (ZR).

The following shows the assignment to the file register of the CPU module. (The number of points for the file register shows the maximum size that can be set in the CPU module (when the R120CPU + NZ2MC-16MBS are mounted)).

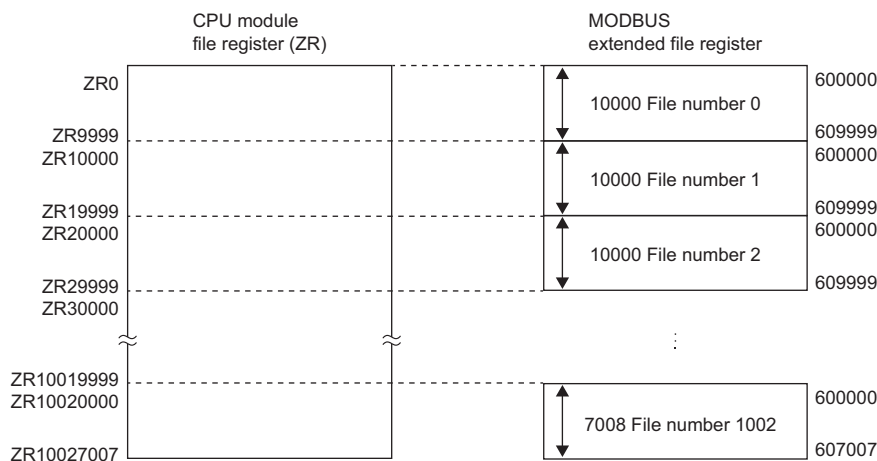

The size of the MODBUS extended file register depends on the size of the file register (ZR) set in the CPU module.

For details, refer to the following.

☞ MELSEC iQ-R CPU Module User's Manual (Application)

■Applicable devices

The following table lists the devices of the CPU module that can be set in the MODBUS devices.

Device name	Symbol	MODBUS device (○: Can be assigned, ×: Cannot be assigned)				
		Coil	Input	Input register	Holding register	Extended file register
Special relay	SM	○	○	○*1	○*1	×
Special register	SD	×	×	○	○	×
Input	X	○	○	○*1	○*1	×
Output	Y	○	○	○*1	○*1	×
Internal relay	M	○	○	○*1	○*1	×
Latch relay	L	○	○	○*1	○*1	×
Annunciator	F	○	○	○*1	○*1	×
Edge relay	V	○	○	○*1	○*1	×
Link relay	B	○	○	○*1	○*1	×
Data register	D	×	×	○	○	×
Link register	W	×	×	○	○	×
Timer (contact)	TS	○	○	○*1	○*1	×
Timer (coil)	TC	○	○	○*1	○*1	×
Timer (current value)	TN	×	×	○	○	×
Long timer (current value)	LTN	×	×	○*4	○*4	×
Retentive timer (contact)	STS	○	○	○*1	○*1	×
Retentive timer (coil)	STC	○	○	○*1	○*1	×
Retentive timer (current value)	STN	×	×	○	○	×
Long retentive timer (current value)	LSTN	×	×	○*4	○*4	×
Counter (contact)	CS	○	○	○*1	○*1	×
Counter (coil)	CC	○	○	○*1	○*1	×
Counter (current value)	CN	×	×	○	○	×
Long counter (contact)	LCS	○	○	○*1	○*1	×
Long counter (coil)	LCC	○	○	○*1	○*1	×
Long counter (current value)	LCN	×	×	○*2	○*2	×
Link special relay	SB	○	○	○*1	○*1	×
Link special register	SW	×	×	○	○	×
Step relay*5	S	○	○	○*1	○*1	×
Direct input	DX	○	○	○*1	○*1	×
Direct output	DY	○	○	○*1	○*1	×
Index register	Z	×	×	○	○	×
Long index register	LZ	×	×	○*2	○*2	×
File register	R	×	×	○	○	×
	ZR	×	×	×	×	○*3
Refresh data register	RD	×	×	○	○	×
Buffer memory	H*6	×	×	○	○	×

*1 When setting a bit type device to the input register or output register, set it so that the number of assigned points will be a multiple of 16. Otherwise, an error occurs in the engineering tool.

*2 The long counter (current value) and the long index register use two points of MODBUS devices.

*3 The assignment of the extended file register is fixed to the file register (ZR).

*4 The long timer (current value) and long retentive timer (current value) use four points of MODBUS devices. (☞ Page 118 Long timer and long retentive timer)

*5 The step relay is read-only. An attempt of writing will cause an error.

*6 When the buffer memory is used, use H (hexadecimal constant) as the device symbol and set the address in hexadecimal notation. The setting range is 1D5000H to 1D6FFFH. (☞ Page 512 User setting area for MODBUS/TCP function (Un\G1921024 to Un\G1929215))

■ Long timer and long retentive timer

Note that the following items cannot be set for reading the long timer and long retentive timer.

- Long timer (contact)
- Long timer (coil)
- Long retentive timer (contact)
- Long retentive timer (coil)

When, however, the current value of the long timer or long retentive timer is set in units of four words, the contact and coil will be read simultaneously.

Response data	Description
1st word	The current value is stored.
2nd word	
3rd word	<ul style="list-style-type: none">• b0: The value of the coil is stored.• b1: The value of the contact is stored.• b2 to b15: Used by the system.
4th word	Used by the system.

As shown above, the long timer and long retentive timer use the data configuration of four words per device. Consequently, specify the number of device points for a request data in units of four points.

Note that the write of long timer and long retentive timer cannot be set.

■ Default assignment parameters

The MODBUS device assignment parameters include default assignment parameters as initial values.

The following diagram shows the MODBUS device assignment using the default assignment parameters.

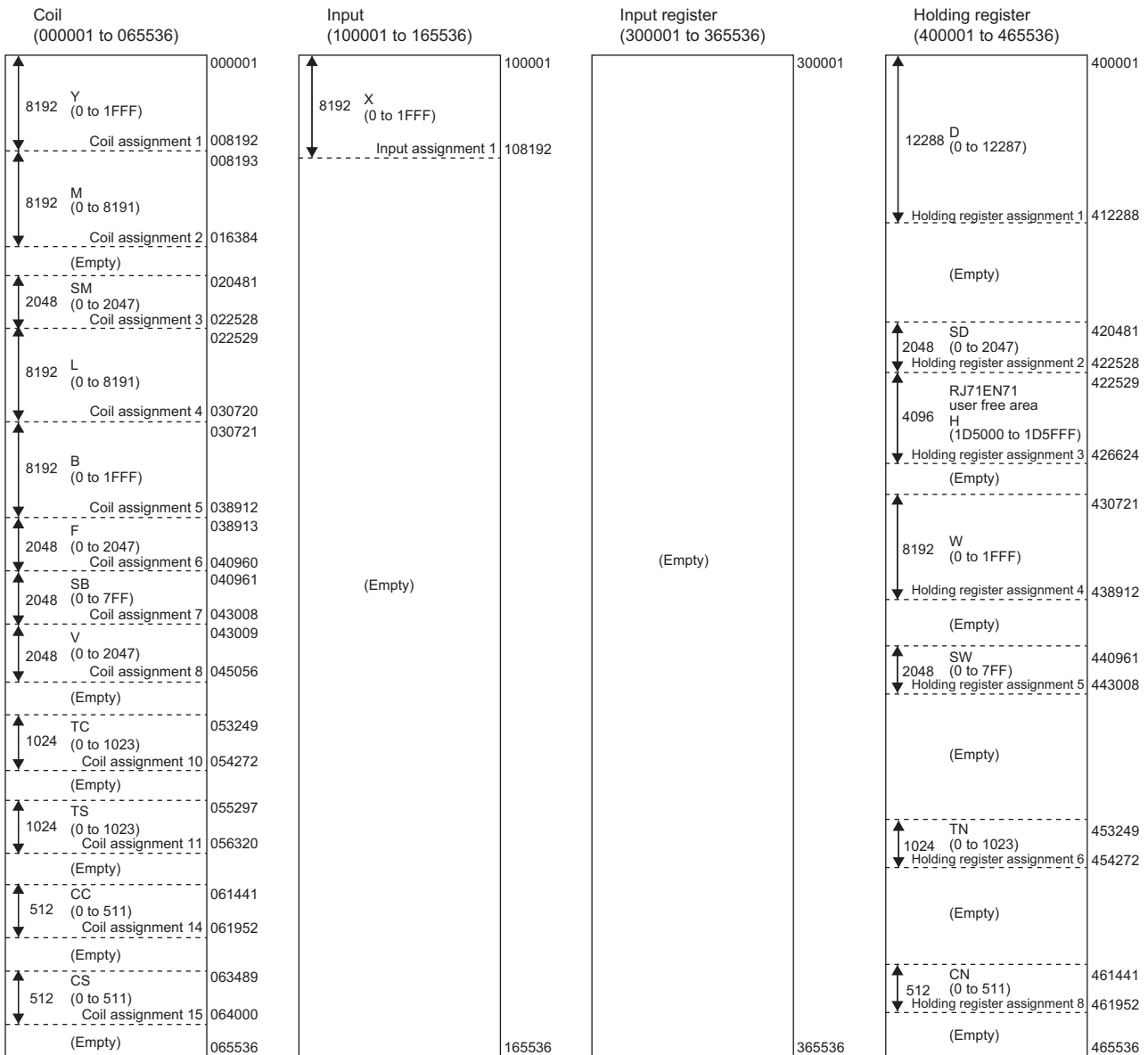

Point

- In the MODBUS device assignment parameters, start MODBUS device number is last five digits of the setting target MODBUS device number - 1.
- The default values set for the MODBUS device assignment parameters cannot be used for creating a project for the engineering tool using the remote head module. Clear the values first before starting the setting.

1.8 Link Dedicated Instruction Communication

The RJ71EN71 or the RnENCPU (network part) execute the transient transmission to the programmable controller of the other station on the same Ethernet using the link dedicated instructions. (☞ Page 523 Link dedicated instructions)
A station on a network other than Ethernet can be accessed. (☞ Page 532 Communications with Different Networks)

Precautions

The CPU module (CPU part for the RnENCPU) cannot exchange data with the link dedicated instruction.

Data communication procedures

This section describes the procedure for communication with link-dedicated instructions.

1. After setting the module parameters, check that the initial processing of the own station, relay stations, and the RJ71EN71 and RnENCPU (network part) of access stations have completed successfully. ('Initial status' (Un\G1900024.0): On)
2. Data is exchanged with link dedicated instructions. (☞ Page 523 Link dedicated instructions)

Point

Communication with the link dedicated instructions uses the MELSOFT transmission port (UDP/IP), so the open/close processing is not required.

Setting procedure

1. Set the network number and station number in "Own Node Settings" under "Basic Settings". (☞ Page 319 Details of items)
2. Set the send destination station information in "Network/Station number <-> IP Related information setting" under "Application Settings". (☞ Page 398 Network/Station No. <-> IP information setting)*1

*1 This setting is not required when the target station is specified with an IP address using control data of the control data of READ instruction, SREAD instruction, WRITE instruction, or SWRITE instruction.

1.9 File Transfer Function (FTP server)

The server function of FTP (File Transfer Protocol) used to transfer files with the external device is supported. The external device with FTP client function can easily and directly access files in the CPU module.

The following operations can be executed on the CPU module files from the external device with FTP client function.

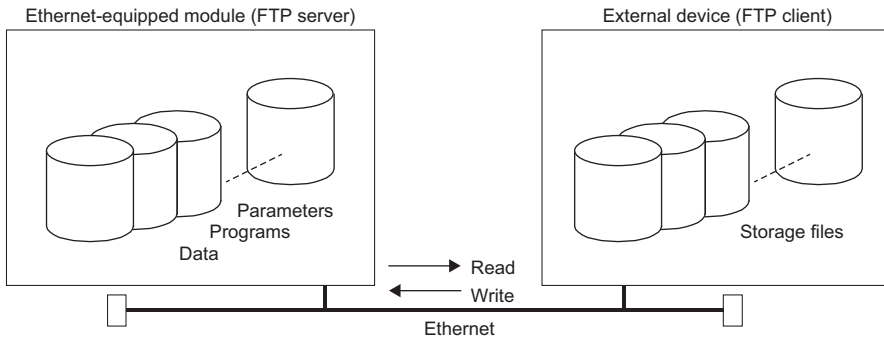

- Reading of file from CPU module (download)
- Writing of file to CPU module (upload)
- Browsing of file names in CPU module

Point

When using the file transfer function (FTP server) with multi-CPU system configuration, the following CPU module is accessed immediately after logging in. To change the access destination CPU module, execute the cpuchg command.

- Control CPU (when the RJ71EN71 is connected)
- CPU module connected with Ethernet cable (when CPU module is connected)

Data communication procedures

The following section describes the settings for FTP communication.

Setting in the Ethernet-equipped module side

To use the file transfer function (FTP server), set "Use" for "FTP Server" in "FTP Server Settings" under "Application Settings". For details on other setting items, refer to the following.

 Page 329 FTP Server Settings

Operations on external device (FTP client) side

This section describes the procedures and required processes on the external device side for using the Ethernet-equipped module's file transfer function (FTP server). The FTP commands and input format used for the operation are shown in the explanation. ("" means to input CR, Enter or the Return key.)

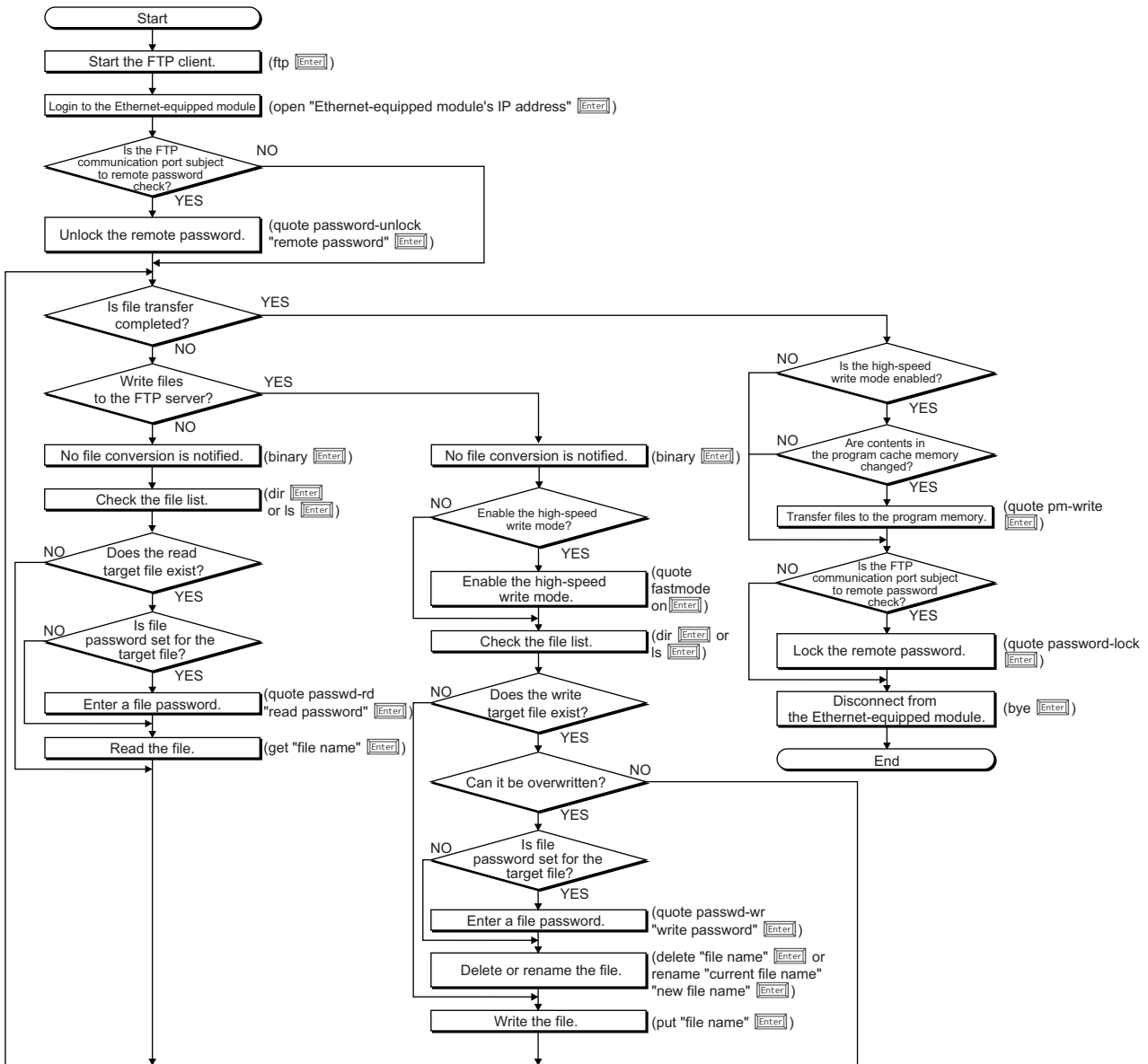

Logging into Ethernet-equipped module

This section describes the steps from starting FTP and logging into the Ethernet-equipped module.

Ex.

Start FTP from the Microsoft® Windows® command prompt.

```
Microsoft Windows [Version 6.1.7601]
Copyright (c) 2009 Microsoft Corporation. All rights reserved.

C:\Windows>ftp
ftp> open 192.168.1.1
Connected to 192.168.1.1.
220 iQ-R FTP server ready.
User (192.168.1.1:(none)): RJ71EN71
331 Password required.
Password:
230 User logged in.
ftp>
```

- 1 FTP start (FTP)
- 2 Connect with FTP server (open Ethernet-equipped module IP address)
- 3 Specify login name (login name)
- 4 Specify password (password)

Use the login name and password that are set in "FTP Server Settings" under "Application Settings". When the Ethernet-equipped module (FTP server) receives the login name and password from the external device (FTP client), it checks that the login name and password are correct.

If the login name and password are correct, transfer of the files to the Ethernet-equipped module is permitted. If incorrect, file transfer is not permitted.

Locking and unlocking the remote password

If the FTP communication port is specified as a remote password check target with the remote password setting, unlock the remote password with the following command. (quote password-unlock remote password) When finished, lock the remote password with the following command. (quote password-lock)

Point

If the FTP communication port is specified as a remote password check target, some commands cannot be used until the remote password is unlocked.

For details on the commands that can be used in the locked state, and those that can only be used in the unlock state, refer to the following.

(Page 125 FTP command list)

Inputting the file password

If a file password is set for the target file, the file password must be input with the following command before the file can be accessed.

- Write password (quote passwd-wr write password)
- Read password (quote passwd-rd read password)

Files that can be transferred with FTP

For the files that can be transferred (read, write, deleted) with the file transfer function (FTP server), refer to the file operation available which is described in the following manual.

- MELSEC iQ-R Programmable Controller CPU Module User's Manual
- MELSEC iQ-R Process CPU Module User's Manual

FTP command

FTP command list

The FTP client side commands supported by the Ethernet-equipped module are shown below.

○: Executable^{*1}, ×: Not executable^{*2}

Command	Function	CPU module status			Remote password	
		STOP	RUN		Unlocked ^{*4}	Locked ^{*4}
			Enable ^{*3}	Disable ^{*3}		
binary ^{*5}	Notifies that the file will be transferred without conversion.	○	○	○	○	×
bye	Closes and ends the connection with the FTP server.	○	○	○	○	○
close	Closes the connection with the FTP server.	○	○	○	○	○
delete	Deletes the CPU module file.	○	○ ^{*6}	×	○	×
dir	Displays the CPU module file information.	○	○	○	○	×
get	Reads a file from the CPU module.	○	○	○	○	×
ls	Displays the CPU module file name.	○	○	○	○	×
mdelete	Deletes the CPU module file.	○	○ ^{*6}	×	○	×
mdir	Stores the CPU module file information in the file.	○	○	○	○	×
mget	Reads a file from the CPU module.	○	○	○	○	×
mls	Reads a file from the CPU module.	○	○	○	○	×
mput	Writes the file to the CPU module.	○	○	×	○	×
open	Connects to the FTP server.	○	○	○	○	○
put	Writes the file to the CPU module.	○	○	×	○	×
pwd	Displays the current directory of the CPU module.	○	○	○	○	×
quit	Closes and ends the connection with the FTP server.	○	○	○	○	○
quote	Sends the FTP server's subcommand. ^{*7}	○	○	○	○	○
rename	Changes the CPU module file name.	○	○	×	○	×
user	Inputs the user name and password for the Ethernet-equipped module.	○	○	○	○	○

*1 The command may not be executed depending on the file type. (☞ Page 124 Files that can be transferred with FTP)

*2 If executed, the process completes abnormally.

*3 Shows the "Allow Online Change" setting in "FTP Server Settings" under "Application Settings". If an illegal command is executed while write is prohibited during RUN, the process completes abnormally.

*4 Shows whether the command can be executed when the FTP communication port is specified as a remote password check target port with the Ethernet-equipped module mounted station's remote password setting. For details on the remote password, refer to the following.

(☞ Page 181 Remote password)

*5 The Ethernet-equipped module is set to transfer the file automatically without conversion. (Binary code fixed)

Therefore, the file is transferred with binary code regardless of the "Communication Data Code" setting in "Own Node Settings" under "Basic Settings".

*6 The parameter file and program file cannot be deleted when the CPU module is in the RUN state.

*7 Only the subcommands dedicated for the Ethernet-equipped module can be used. For the subcommands can be used, refer to the following.

(☞ Page 126 Subcommands usable with quote command)

■ Subcommands usable with quote command

This section describes the Ethernet-equipped module dedicated commands added to the quote command and used. When executing this command from the FTP client, input the subcommand after the quote command.

("Enter" means to input CR, Enter or the Return key.)

Ex.

Executing the STOP command

Input the following at the command prompt.

quote stop Enter

The following table lists the subcommands can be used.

○: Executable, ×: Not executable^{*1}

Command	Function	CPU module status			Remote password	
		STOP	RUN		Unlocked	Locked
			Write enable	Write prohibit		
change	Shows or changes the CPU module file attributes.	○	○	×	○	×
cpuchg ^{*2}	Specifies the access destination CPU module when using a multi-CPU system configuration.	○	○	○	○	×
fastmode ^{*5}	Enables or disables the high-speed write mode for the CPU module, or displays its status.	○	○	○	○	×
passwd-rd	Sets, shows or clears the file password (read password).	○	○	○	○	×
passwd-wr	Sets, shows, or clears the file password (write password).	○	○	○	○	×
password-lock	Changes the remote password from the unlock state to the lock state.	○	○	○	○	× ^{*4}
password-unlock	Changes the remote password from the lock state to the unlock state.	○	○	○	○	○
path-delimiter ^{*5}	Changes the directory delimiter of the file path of the CPU module from "\" to "/" ^{*6}	○	○	○	○	×
path-delimiter off ^{*5}	Turn off file setting changing for the file path name when a file is specified by the path-delimiter. ^{*6}	○	○	○	○	×
path-delimiter status ^{*5}	Displays the setting status of the file path name when a file is specified. ^{*6}	○	○	○	○	×
status	Displays the CPU module operation information.	○	○	○	○	×
run	Sets the CPU module to the RUN state.	○ ^{*3}	○	○	○	×
stop	Sets the CPU module to the STOP state.	○	○	○	○	×
pm-write	Writes the program memory.	○	×	×	○	×

*1 If executed, the process completes abnormally.

*2 This subcommand cannot be used when the connection destination is a CPU module.

*3 This subcommand is invalid when the RUN/STOP/RESET switch of the CPU module is set to STOP.

*4 Even if the subcommand is executed, the remote password remains locked with no error occurred.

*5 This subcommand can be used only when the connection destination is a programmable controller CPU. Before using this subcommand, check the versions of the CPU module used. (Page 564 Added and Enhanced Functions)

*6 For function details, refer to the following.

Page 128 FTP server function file path name switching

Specifying an FTP command

This section describes the method of specifying the files specified with the FTP command on the FTP client (external device side) supported by the Ethernet-equipped module.

With the CPU module, the drive name and file name are distinguished when specifying the file.

When specifying a file with FTP, specify the target file with the following arrangement.*1

Item	Description
Specification format	[Drive name:\]Folder name*2\File name.Extension
Example	3:\MAINSEQ1.QDR (other than drive 2) 2:\LOGGING\LOG01\00000001\LOG01_00000001.CSV (drive 2)
Specification details	Refer to the following.  Page 127 Drive name (drive No.),Page 127 Folder name, file name, and extension

*1 The default directory delimiter is "\". To change the directory delimiter to "/", refer to the following.

 Page 128 FTP server function file path name switching

*2 The file name can be specified only when specifying a file stored in drive 2.





The section enclosed in square brackets [] in the specification format can be omitted.

■Drive name (drive No.)



Specify the drive name of the target memory for transferring the file.

For the correspondence of the target memory and drive names, refer to the following.

-  MELSEC iQ-R Programmable Controller CPU Module User's Manual
-  MELSEC iQ-R Process CPU Module User's Manual

Omitting the drive name is the same as specifying the program memory (drive 4). If, however, FTP server function file path name switching is enabled, the setting is valid. ( Page 128 FTP server function file path name switching)

■Folder name, file name, and extension

- Specify the folder name and file name according to the rules provided in the following.
-  MELSEC iQ-R Programmable Controller CPU Module User's Manual
-  MELSEC iQ-R Process CPU Module User's Manual
- The name determined for the CPU module is assigned for the extension.
- When using an FTP command that can be used for multiple files, specify the file name and extension with the wild card "*" or "?". (Depending on the FTP client, there may be additional restrictions to the characters that can be used for the file name.)

: All files with the arbitrary character string (including none) are targeted from the position specified with "".

?: All files with the arbitrary character string (excluding none) are targeted from the position specified with "?". ("?" can be used multiple times.)

FTP server function file path name switching

The directory delimiter of the file path specified using the FTP command is changed from "\" to "/" in the CPU module (built-in Ethernet port part).

In addition, the omission of the drive number in the file path name can be set.

Change procedure	Description
Using the special relay/special register	Changing the special relay SM1512 (FTP server function file path name switching setting enable flag) changes the directory delimiter. This method is used when FTP clients use only Linux OS and "/" is to be set for the directory delimiter.
Using the FTP command	Specifying the subcommand (path-delimiter) for the quote command changes the directory delimiter of the file path name of the CPU module. This method is used when FTP clients use Windows OS or Linux OS and the directory delimiter is to be changed every time the server is accessed by the client.

The following table lists how to specify CPU module files after changing the directory delimiter to "/".

Item	Description
Specification format	[Drive name:]File name.Extension
Example	3:/MAINSEQ1.QDR

- After the directory delimiter is changed to "/", directory delimiter commands including "\" can be received by the CPU module. However, the directory delimiter that is sent from the CPU module is "/".
- When changing the directory delimiter again, the contents set later are valid.
- When executing the FTP command to specify a file path name using an FTP client with Linux OS, the same folder configuration must be used for the CPU module and the personal computer.

Restriction

Only the programmable controller CPU can be used for the function. Before using this function, check the version of the CPU module used.  Page 564 Added and Enhanced Functions

■ Using the special relay/special register

- Turning on the SM1512 (FTP server function file path name switching setting enable flag) changes the directory delimiter of the CPU module file path name to "/". Storing the setting value in the SD1512 (FTP server function file path name switching setting) enables omission of the drive number in the file path name.
- While the SM1512 is on, the directory delimiter change is valid. Turning off the SM1512 clears the change and returns the directory delimiter from "/" to "\".
- When an improper value is set, the SM1513 (FTP server function file path name switching setting error) is turned on and the error cause is stored in the SD1513 (FTP server function file path name switching setting error cause). When there is no error in the setting value, the SM1513 is turned off.
- The current setting status is stored in the SD1514 (FTP server function file path name switching setting status) When the SM1512 is off, 0 is stored in the SD1514.

Special relay	Name
SM1512	FTP server function file path name switching setting enable flag
SM1513	FTP server function file path name switching setting error

Special register	Name
SD1512	FTP server function file path name switching setting
SD1513	FTP server function file path name switching setting error cause
SD1514	FTP server function file path name switching setting status

For details on the special relay/register, refer to the following.

- Programmable controller CPU:  MELSEC iQ-R Programmable Controller CPU Module User's Manual
- Process CPU:  MELSEC iQ-R Process CPU Module User's Manual

Restriction

Do not turn the SM1512 off and on or on and off while the FTP command is executing. Doing so may cause malfunction.

■ Using the FTP command

- When executing the quote command with a subcommand of the path-delimiter [mode], the directory delimiter of the CPU module file path name is changed from "\" to "/". Inputting the setting value to [mode] enables omission of the drive number in the file path.
- Executing the path-delimiter off command clears the setting.
- Executing the path-delimiter status command enables the current settings to be checked.

FTP command (Sub command of the quote command)	Function
path-delimiter	Changes the setting of the file path name when a file is specified. (After executing the command, the SM1512 is turned on and the current setting value is stored in the SD1514.)
path-delimiter off	Turns off file setting changing for the file path name when a file is specified.
path-delimiter status	Displays the setting status of the file path name when a file is specified.

For details on the quote command, refer to the following.

 Page 133 Ethernet-equipped module dedicated subcommand

Point

The current settings can also be checked using the SM1512 (FTP server function file path name switching setting enable flag) and the SD1514 (FTP server function file path name switching setting status).

Details of FTP command

This section describes the FTP commands on the FTP client side supported by the Ethernet-equipped module, and the methods of using those commands.

Point

- Note that depending on the client side FTP application, some of the FTP commands may not operate as described in this manual. Refer to the manual for the FTP client, and check the functions, operation methods, and so on.
- The specification format and result of the command may differ depending on the FTP client used.
- The section enclosed in square brackets [] in the specification format can be omitted.

■FTP server support command

Command name	Description	
binary	Function	Notifies the FTP server that the file will be transferred without conversion. The return code and kanji codes are also not converted. These settings are automatically applied to the Ethernet-equipped module.
	Specification format	binary (abbreviated: bin)
bye	Function	Closes the connection with the FTP and quits the FTP.
	Specification format	bye
	Same function	quit
close	Function	Closes the connection with the FTP server.
	Specification format	close
delete	Function	Deletes files stored in the CPU module.
	Specification format	delete "file path name"
	Example	When deleting files stored in the SD memory card delete 2:\MAINSEQ1.PRG
	Similar command	mdelete
dir	Function	Displays the file name, date of creation and volume of files stored in the CPU module.
	Specification format	dir [drive name:\]
	Example	When displaying the detailed information of files stored in the data memory dir 4:\
	Similar command	ls
get	Function	Reads a file from the CPU module.
	Specification format	get "source file path name" [destination file path name]
	Example 1	When reading files stored in the SD memory card and store with same file name get 2:\MAINSEQ1.PRG
	Example 2	When reading files stored in the SD memory card and store with different file name get 2:\SEQ1BAK.PRG SEQ\SEQ10LD.PRG
	Caution	<ul style="list-style-type: none"> • If the destination file path name (FTP client side) is not specified, the file is stored in the FTP client side with the same file name as the source file name (CPU module side). • The transfer destination is in the currently connected directly when FTP is started and connected. • When the command is executed in an FTP client with Linux OS, the drive number in the source file path name must be omitted. Set the drive number in the file path name to be omitted in advance using the FTP server function file path name switching, and specify as follows. (Page 128 FTP server function file path name switching) Example: "get /SEQ10LD.PRG"
ls	Function	Displays the names of files stored in the CPU module.
	Specification format	ls [drive name:\]
	Example	When displaying the detailed information of files stored in the data memory ls 4:\
	Similar command	dir
	Caution	When the command is executed in an FTP client with Linux OS, the results are the same as the dir command. (The mls command corresponds to the ls command for an FTP client with Windows OS.)

Command name	Description	
mdelete	Function	Deletes files stored in the CPU module. When deleting multiple files, specify the file name and extension in the file path name with wild cards (*, ?).
	Specification format	mdelete "file path name" (abbreviated: mdel)
	Example	When deleting all files with "CSV" extension from files stored in SD memory card mdelete 2:*.CSV
	Caution	When the command is executed in an FTP client with Linux OS, omit the drive number in the file path name and add "/" to the beginning of the file path name. Set the drive number in the file path name to be omitted in advance using the FTP server function file path name switching, and specify as follows. (☞ Page 128 FTP server function file path name switching) Example: "mdelete /*.csv"
	Similar command	delete
mdir	Function	Stores the detailed information (file name, date of creation, volume) of the file stored in the CPU module in the FTP client side file as log data.
	Specification format	mdir "source drive name":\destination file path name"
	Example	When storing the detailed information of file stored in data memory into 20120702.LOG file mdir 4:\20120702.LOG
	Caution	<ul style="list-style-type: none"> • Always specify "\" immediately after the source drive name. • Always specify the source drive name when specifying the destination file path name (FTP client side). • If the destination file path name is not specified, the file is stored with the file name determined by the FTP client's FTP application. • The transfer destination is in the currently connected directly when FTP is started and connected.
	Similar command	mls
mget	Function	Reads a file from the CPU module. When reading multiple files, specify the file name and extension in the file path name with wild cards (*, ?). When reading multiple files, receive is confirmed before transferring each file.
	Specification format	mget "file path name"
	Example	When reading all files with "CSV" extension from files stored in SD memory card mget 2:*.CSV
	Caution	<ul style="list-style-type: none"> • The read file is stored with the same file name in the FTP client side. The storage destination is in the current connection directory when the FTP is started and connected. • When the command is executed in an FTP client with Linux OS, omit the drive number in the file path name and add "/" to the first of the file path name. Set the drive number in the file path name to be omitted in advance using the FTP server function file path name switching, and specify as follows. (☞ Page 128 FTP server function file path name switching) Example: "mget /*.csv"
	Similar command	mls
mls	Function	Stores the file name of the file stored in the CPU module in the FTP client side file as log data.
	Specification format	mls "source drive name":\destination file path name"
	Example	When storing the file name of file stored in SD memory card into 20120702.LOG file mls 2:\20120702.LOG
	Caution	<ul style="list-style-type: none"> • Always specify "\" immediately after the source drive name. • Always specify the source drive name when specifying the destination file path name (FTP client side). • If the destination file path name is not specified, the file is stored with the file name determined by the FTP client's FTP application. • The transfer destination is in the currently connected directly when FTP is started and connected.
	Similar command	mdir
mput	Function	Writes the file to the CPU module. When writing multiple files, specify the file name and extension in the file path name with wild cards (*, ?). When writing multiple files, send is confirmed before transferring each file.
	Specification format	mput "source file path name"
	Example	When writing all files with "PRG" extension mput*.PRG
	Caution	<ul style="list-style-type: none"> • The storage destination file name is the same as the FTP client side. • The transmission destination is the data memory (drive 4 "4:\"). When the file path name is changed using the FTP server function file path name switching, the setting is valid. (☞ Page 128 FTP server function file path name switching)

Command name	Description	
open	Function	Specifies the host name or IP address and port number on the FTP server side, and connects with the FTP server.
	Specification format	open "host name" [port number] open "IP address" [port number] <ul style="list-style-type: none"> • Host name: Host name set with Microsoft® Windows® hosts file • IP address: IP address of the Ethernet-equipped module side • Port number: Port number to be used (If omitted, port number 21 is used for operation)
	Example 1	When specifying the host name and connecting to the FTP server open HOST
	Example 2	When specifying the IP address and connecting to the FTP server open 192.0.1.254
	Caution	The IP address can be specified to create a connection when starting the FTP.
put	Function	Writes the file to the CPU module.
	Specification format	put "source file path name" [destination file path name]
	Example 1	When writing the param.PRM file to the SD memory card with the same file name put param.PRM 2:\param.PRM
	Example 2	When writing the param.PRM file to the SD memory card with a different file name put param.PRM 2:\param1.PRM
	Caution	<ul style="list-style-type: none"> • If the directory is not specified with the source file path name (FTP client side), the file in the current connection directory when the FTP server is started and connected is written. • If the destination file path name (FTP server side) is not specified, the file is transferred to the data memory (drive 4 "4:\").
pwd	Function	Displays current directory name of the CPU module.
	Specification format	pwd
	Caution	"\" is displayed as the pwd command execution results.
quit	Function	Closes the connection with the FTP and quits the FTP.
	Specification format	quit
	Similar command	bye
quote	Function	Sends the FTP server's subcommand (Ethernet-equipped module dedicated subcommand).
	Specification format	quote
	Example	quote password-lock
	Caution	Only the Ethernet-equipped module dedicated subcommand can be specified. Refer to the following. (☞ Page 133 Ethernet-equipped module dedicated subcommand)
rename	Function	Changes the CPU module file name.
	Specification format	rename "old file path name" "new file path name" (abbreviated: ren)
	Example	When changing the name of a file stored in the SD memory card rename 2:\param.PRM 2:\param1.PRM
	Caution	The following response code appears when the file is successfully renamed. 350 Need more info. 250 Rename successful.
user	Function	Inputs the user name and password for the connected FTP server.
	Specification format	user "user name" [FTP password] <ul style="list-style-type: none"> • User name: Login name set with Ethernet-equipped module parameters • FTP password: FTP password set with Ethernet-equipped module parameters
	Example 1	When specifying the user name user RJ71EN71
	Example 2	When specifying the user name and password user RJ71EN71 RJ71EN71

■ Ethernet-equipped module dedicated subcommand

This section describes the Ethernet-equipped module dedicated subcommands that are added to the FTP command's quote command and sent.

Command name	Description	
change	Function	Shows or changes the attributes of files stored in the CPU module.
	Specification format 1	When displaying the file attributes quote change file path name One of the following is displayed as the execution results when the process ends normally. <ul style="list-style-type: none"> • When specified file is read-only: ----R • When specified file is writable and readable: ----W
	Specification format 2	When changing the file attributes quote change "file path name" "attribute" Specify the attributes with one of the following methods. <ul style="list-style-type: none"> • When changing to a read-only file: r • When changing to a writable and readable file: w
	Example 1	When displaying the attributes of files stored in the SD memory card quote change 2:\PRG1.PRG
	Example 2	When changing the attributes of files stored in the SD memory card quote change 2:\PRG1.PRG r
cpuchg	Function	Specifies the access destination CPU module when using a multi-CPU system configuration. This may also display the current access destination CPU module.
	Specification format	quote cpuchg [access destination CPU module] Access destination CPU module: Specify the CPU module from which files are to be accessed. Shows the method for specifying the access destination CPU module. <ul style="list-style-type: none"> • No input: Checks the current access destination CPU module. • controlPLC: Specifies the control CPU as the access destination CPU module. • no1: Specifies the CPU No.1 as the access destination CPU module. • no2: Specifies the CPU No.2 as the access destination CPU module. • no3: Specifies the CPU No.3 as the access destination CPU module. • no4: Specifies the CPU No.4 as the access destination CPU module. The execution results when the access is completed normally are shown in the following manner. <ul style="list-style-type: none"> • When setting access destination CPU module: 200 Command Okey • When displaying access destination CPU module: 200 Target cpu is "access destination CPU module". The following appears if the specified access destination CPU module is not found. <ul style="list-style-type: none"> • 557 Cpu not found
	Example 1	When specifying control CPU as access destination CPU module quote cpuchg controlPLC
	Example 2	When displaying the currently set access destination CPU module quote cpuchg
	Caution	The access destination CPU module after logging into the RJ71EN71 with the open/user command is the RJ71EN71 control CPU.

Command name	Description	
fastmode	Function	<p>Enables the high-speed write mode.</p> <p>Since both of the following processing are not performed in high-speed write mode, the program (.PRG) and FB file (.PFB) can be transferred to the "\$MELPRJ\$" folder at high speed.</p> <ul style="list-style-type: none"> • To create a temporary file (FTP_****_#.TMP) • To automatically transfer files that have been written in the program cache memory to the program memory.
	Specification format	<p>quote fastmode [mode]</p> <p>Mode: Specify whether to enable or disable the high-speed write mode.</p> <ul style="list-style-type: none"> • on: Enabled • off: Disabled <p>One of the following is displayed as the execution results when the process ends normally.</p> <ul style="list-style-type: none"> • When the status of high-speed write mode is switched to on (enabled): 200 Command successful • When the status of high-speed write mode is switched to off (disabled): 200 Command successful • If status is displayed when high-speed write mode is enabled: 200 Fastmode is ON • If status is displayed when high-speed write mode is disabled: 200 Fastmode is OFF
	Example 1	<p>When enabling the high-speed write mode</p> <pre>quote fastmode on</pre>
	Example 2	<p>When disabling the high-speed write mode</p> <pre>quote fastmode off</pre>
	Example 3	<p>When displaying status of the high-speed write mode</p> <pre>quote fastmode</pre>
	Caution	<ul style="list-style-type: none"> • The high-speed write mode is disabled when logging into the CPU module. • In high-speed write mode, files are not automatically transferred when contents in the program cache memory are changed with the file write command (put, mput), file delete command (delete, mdelete), or file rename command (rename). Therefore, execute the file transfer command (to program memory) (quote pm-write) after changing the contents. If the CPU module is reset without executing the file transfer command (to program memory) after the changing, incorrect program files remain in the program memory. In this case, delete the incorrect program files with the file delete command (delete, mdelete) and transfer files again.
	Example 4	<p>When displaying the status of the high-speed write mode</p> <pre>quote fastmode</pre>
passwd-rd	Function	<p>Sets the read password (file password) registered as the file transfer target file to the Ethernet-equipped module.</p> <p>Shows/clears the read password set in FTP.</p> <p>Use this command only when a read password is registered for the file transfer target file. The CPU module checks the password when accessing the specified file.</p>
	Specification format	<p>quote passwd-rd [read password]</p> <p>The following appears as the execution results when the command ends normally.</p> <ul style="list-style-type: none"> • When setting a read password: 200 Command successful • When displaying the read password: 200 Read-password is "read password" • When clearing the read password: 200 Command successful • When displaying the state with a read password not set: 200 Read-password is not set.
	Example 1	<p>When specifying the read password (ABCD1234@efgh)</p> <pre>quote passwd-rd ABCD1234@efgh</pre>
	Example 2	<p>When displaying the read password currently set in FTP</p> <pre>quote passwd-rd</pre>
	Example 3	<p>When clearing the read password currently set in FTP</p> <pre>quote passwd-rd c, or quote passwd-rd C</pre>
	Caution	<ul style="list-style-type: none"> • One read password can be set for the FTP of the Ethernet-equipped module. When the file transfer target file changes and when a read password is registered for the change destination file, reset the read password for the target file. • The read password is initialized (cleared) when logging into the Ethernet-equipped module.
	Example 4	<p>When displaying the state with a read password not set</p> <pre>quote passwd-rd</pre>

Command name	Description	
passwd-wr	Function	Sets the write password (file password) registered in the file transfer target file to the Ethernet-equipped module. Shows/clears the write password set in FTP. Use this command only when a write password is registered for the file transfer target file. The CPU module checks the password when accessing the specified file.
	Specification format	quote passwd-wr [write password] The following appears as the execution results when the command ends normally. <ul style="list-style-type: none"> When setting the write password: 200 Command successful When displaying the write password: 200 Write-password is "Write password" When clearing the write password: 200 Command successful When displaying the state with the write password not set: 200 Write-password is not set.
	Example 1	When specifying the write password (ABCD1234@efgh) quote passwd-wr ABCD1234@efgh
	Example 2	When displaying the write password currently set in the FTP quote passwd-wr
	Example 3	When clearing the write password currently set in the FTP quote passwd-wr c, or quote passwd-wr C
	Caution	<ul style="list-style-type: none"> One write password can be set for the FTP of the Ethernet-equipped module. When the file transfer target file changes and when a write password is registered for the change destination file, reset the write password for the target file. The write password is initialized (cleared) when logging into the Ethernet-equipped module.
password-unlock	Function	Specifies the remote password set for the CPU module and unlocks the password. This command is used when FTP communication port is specified as a remote password check target port.
	Specification format	quote password-unlock [remote password] <ul style="list-style-type: none"> Remote password: Specifies the remote password set in the CPU module parameters. The following appears as the execution results when the command ends normally. 200 Command Okey The following appears when the remote password does not match. 556 Password Error The following appears if another command is requested before the remote password is unlocked. 555 Password Locked
	Example	When specifying a remote password (123456) quote password-unlock 123456
	Caution	<ul style="list-style-type: none"> If the FTP communication port is specified as a remote password check target port when logging in, the password will be locked. The CPU module files can be accessed by executing this command and unlocking before starting the various FTP operation. If the FTP communication port is not specified as a remote password check target port, the processing will complete normally when the remote password is unlocked.
password-lock	Function	Locks the remote password function set for the CPU module. This command is executed when the FTP communication port is specified as a remote password check target port.
	Specification format	quote password-lock The following appears as the execution results when the command ends normally. 200 Command Okey
	Example	When locking the remote password quote password-lock

Command name	Description					
path-delimiter	Function	Changes the directory delimiter of the file path name when a file is specified. Also, the drive number can be omitted depending on the mode specification.				
	Specification format	quote path-delimiter [mode] Mode: Specify one of the following 4 digit hexadecimal number. <table border="1" style="margin: 10px auto;"> <tr> <td style="text-align: center;">0</td> <td style="text-align: center;">0</td> <td style="text-align: center;">0/2/3/4</td> <td style="text-align: center;">0/2</td> </tr> </table> 0000 or blank:"/" is set for the directory delimiter of the file path name. (When the FTP clients use Linux OS and other OS) 0022: When "/" is set for the directory delimiter of the file path name and the file path is specified from the FTP client, the drive number can be omitted. When the drive number is omitted, Drive 2 (SD memory card) is used. 0032: When "/" is set for the directory delimiter of the file path name and the file path is specified from the FTP client, the drive number can be omitted. When the drive number is omitted, Drive 3 (device/label memory) is used. 0042: When "/" is set for the directory delimiter of the file path name and the file path is specified from the FTP client, the drive number can be omitted. When the drive number is omitted, Drive 4 (data memory) is used. When drive number omission is set and the CPU module receives the command with the specified drive number, the specified drive number in the received command is prioritized. The following appears as the execution results when the command ends normally. 200 path-delimiter is ON [mode] The following appears when the mode setting value is out of range. 504 Parameter not accepted, not implemented. To clear the setting, use the path-delimiter off command.	0	0	0/2/3/4	0/2
	0	0	0/2/3/4	0/2		
	Example 1	When "/" is set for the directory delimiter quote path-delimiter 0000				
	Example 2	When "/" is set for the directory delimiter and the drive number in the file path name is omitted quote path-delimiter 0022: Drive 2 quote path-delimiter 0032: Drive 3 quote path-delimiter 0042: Drive 4				
Caution	The 4 digit hexadecimal number is displayed as the setting value for "ON (mode)" when ON is set.					
path-delimiter off	Function	Clears the setting change of the file path name by the path-delimiter.				
	Specification format	quote path-delimiter off The following appears. 200 path-delimiter is OFF				
path-delimiter status	Function	Displays the setting status of the file path name when a file is specified.				
	Specification format	quote path-delimiter status The following appears as the execution results when the command ends normally. <ul style="list-style-type: none"> • When ON is set: 200 path-delimiter is ON (mode) • When OFF is set: 200 path-delimiter is OFF 				
	Caution	The 4 digit hexadecimal number is displayed as the setting value for "ON (mode)" when ON is set.				
run	Function	Sets the CPU module to the RUN state (remote RUN). Clearing of the device memory can be specified when entering the RUN state.				
	Specification format	quote run [mode [clear mode]] Mode: Specify whether to forcibly execute remote RUN <ul style="list-style-type: none"> • 0: Normal RUN (default) • 1: Forced RUN Clear mode: Specify to clear (initialize) CPU module device memory at start of operation during remote RUN <ul style="list-style-type: none"> • 0: Do not clear device (default) • 1: Clear other than latch area • 2: Clear all including latch range The following message appears as the execution results when the process ends normally. 200 Command successful				
	Example 1	When executing the remote RUN with normal RUN and do not clear device memory specified quote run				
	Example 2	When executing the remote RUN with forced RUN and do not clear device memory specified quote run 1				
	Example 3	When executing the remote RUN with forced RUN and clear other than latch area memory specified quote run 11				
Caution	<ul style="list-style-type: none"> • Forced RUN is used only when remote RUN of the CPU module is not possible due to trouble in the device that remote STOPPED the CPU module, and the CPU needs to be forcibly remote RUN with another device. With normal RUN, a module that is in the STOP/PAUSE state executed by another device cannot be set to the RUN state. • Specify clearing of the device memory by the clear mode at the start of operation according to the system specifications. After the specified clear is executed, the CPU module will RUN according to the device's default settings. 					

Command name	Description	
status	Function	Displays the CPU module operation information. This command is used to check the operation information when transferring files.
	Specification format	quote status One of the following is displayed as the execution results when the process ends normally. When CPU module is in RUN state: "RUN" When CPU module is in STOP state: "STOP" When CPU module is in PAUSE state: "PAUSE"
stop	Function	Set the CPU module to the STOP state (remote STOP).
	Specification format	quote stop The following message appears as the execution results when the process ends normally. 200 Command successful
	Caution	Write to the program memory after setting the CPU module to the STOP state with this command.
pm-write	Function	Transfers the files written in the program cache memory to the program memory so that the files are held even at power-off.
	Specification format	quote pm-write The following message appears as the execution results when the process ends normally. 200 Command successful
	Caution	<ul style="list-style-type: none"> The MELSEC iQ-R series CPU module automatically transfers the files to program memory after writing them in the program cache memory. Therefore, the files are held at power-off without using this command. If this command is used in the FTP client program, the program does not need be modified when replacing the MELSEC-Q series. Set the CPU module to the STOP state before writing.

Precautions

Precautions for designing system

Design the system (such as configuration of interlock circuits in the program) so that the entire system always functions properly during file transfer to the operating system and during status control of the programmable controller.

FTP client

- The FTP command specifications may differ from this manual depending on the FTP client. In this case, refer to the manual for the FTP client and check the functions and operation methods.
- FTP operations are not possible from Microsoft® Internet Explorer®. If attempted, Internet Explorer® will issue an error.
- Specify the IP address for the FTP command without zero fill. (Do not set "1" as "001".)



Processing on CPU module side

- Only the drive of the CPU module on the own station can access files.
- Do not power off or reset it, or insert/eject the SD memory card during file access. The file could be damaged if these are attempted.
- Do not manipulate the files from a peripheral, such as an engineering tool, while accessing the files. (This also applies to online operations such as writing during RUN as the files are manipulated.) If the file is manipulated from another device during the file transfer function (FTP server) operation, the peripheral may issue an error. If the processing has been halted due to an error, re-execute the processing before quitting the FTP function.

Communication processing

- If a timeout error occurs during file transfer, the TCP/IP connection will be closed. Log into the Ethernet-equipped module with the FTP client again before resuming file transfer.
- The existence of the external device is checked with the FTP connection.
- The file transfer processing time will differ according to the following factors: the load rate (line congestion status) of the Ethernet line, the number of connections used simultaneously (communication processing of other connections), and the system configuration (distance between the FTP server and FTP client, and how to access the CPU module).
- Only one external device (FTP client) can log into the Ethernet-equipped module at one time. If a connection is attempted from another FTP client in the login state, an error will occur without establishing the connection.
- If another communication function (MELSOFT connection or SLMP) is simultaneously executed with UDP/IP during file transfer with FTP, an error such as timeout may occur. Either communicate after the file is transferred, or communicate with TCP/IP.

Writing files

- An existing file cannot be overwritten. Delete or rename an existing file with the file delete command (delete, mdelete) or the file rename command (rename) before writing files.
- A read-only file or a file locked by the function except for FTP cannot be written. If attempted, a write error occurs.
- A file cannot be transferred when the SD memory card used is protected. If attempted, a write error occurs.
- A temporary file (FTP_I***_#.TMP) is automatically created at a file writing. (***) is first three digits of start I/O number, and # is the hardware port number to which FTP client is connected.) The file is renamed the write target file name when a writing is completed, however, the temporary file may remain if the system is powered off or the CPU module is reset during a file writing. In this case, delete the temporary file with the file delete command (delete, mdelete).
- In high-speed write mode, a temporary file is not created at a file writing. Therefore, if the system is powered off or the CPU module is reset during a file writing, a file in the middle of the writing remains. In this case, delete this file with the file delete command (delete, mdelete) and write a file again.
- When the file register is set as a refresh device, do not perform any writing or deletion to the corresponding drive.
- When writing a large file to the SD memory card, set the CPU module to STOP. If writing is performed in the RUN state, a communication error may occur.
- The number of files that can be written into the specified drive is maximum [maximum number of files that can be written] - 1 file. For details on the maximum number of files that can be written to the CPU module, refer to the following.
- Programmable controller CPU:  MELSEC iQ-R Programmable Controller CPU Module User's Manual
- Process CPU:  MELSEC iQ-R Process CPU Module User's Manual

Deleting files

- Decide the timing for deleting the files for the entire system including the CPU module and engineering tool.
- Files with read-only attributes and files that are locked by a function other than FTP cannot be deleted. An error will occur if attempted.
- The file cannot be deleted if the SD memory card is protected. An error will occur if attempted.

FTP password

The FTP password can be reset with the following procedure when it is lost.

- 1.** Read the parameters from the CPU module with the engineering tool.
- 2.** Click the [Restore the Default Settings] button in "Application Settings" to return all "Application Settings" to the default values.
- 3.** Set the "FTP Server Settings" and "Application Settings" again.
- 4.** Write the set parameters to the CPU module.
- 5.** Enable the parameters by powering off and on or resetting the CPU module.

Point

When the FTP password is lost, all items set in "Application Settings" must be reset in addition to the "FTP Server Settings".

Setting a firewall on the FTP client side

If the FTP communication is blocked by a firewall on the FTP client side, data cannot be exchanged from the FTP server. Check the firewall settings, enable FTP communication and then access the FTP server.

Monitoring timer

When operation of files such as program (.PRG) and FB file (.PFB) is performed in a CPU module with a large program capacity, a timeout may occur due to long processing time on the CPU module. If a timeout occurs, increase the response monitoring timer value. (📖 Page 330 Response Monitoring Timer)

Execution of the file transfer function (FTP server) during execution of another function

For some file transfer functions (FTP server), there are some functions that cannot be simultaneously executed. Check that the function that cannot be simultaneously executed is not being executed and then execute the file transfer function (FTP server).

File transfer function (FTP server)		Functions that cannot be simultaneously executed
File transfer function (FTP server) of the RJ71EN71 and RnENCPU (network part)	<ul style="list-style-type: none">• Writing a file (put, mput, pm-write)• Deleting a file (delete, mdelete)• Changing a file name (rename)• Changing a file attribute (change)	<ul style="list-style-type: none">• CPU module data backup/restoration function• iQ Sensor Solution data backup/restoration function
File transfer function (FTP server) of the CPU module (built-in Ethernet port part)		

1.10 File Transfer Function (FTP Client)

The CPU module becomes an FTP client and can execute file transfer with the FTP server connected to Ethernet using the file transfer function instruction.*1

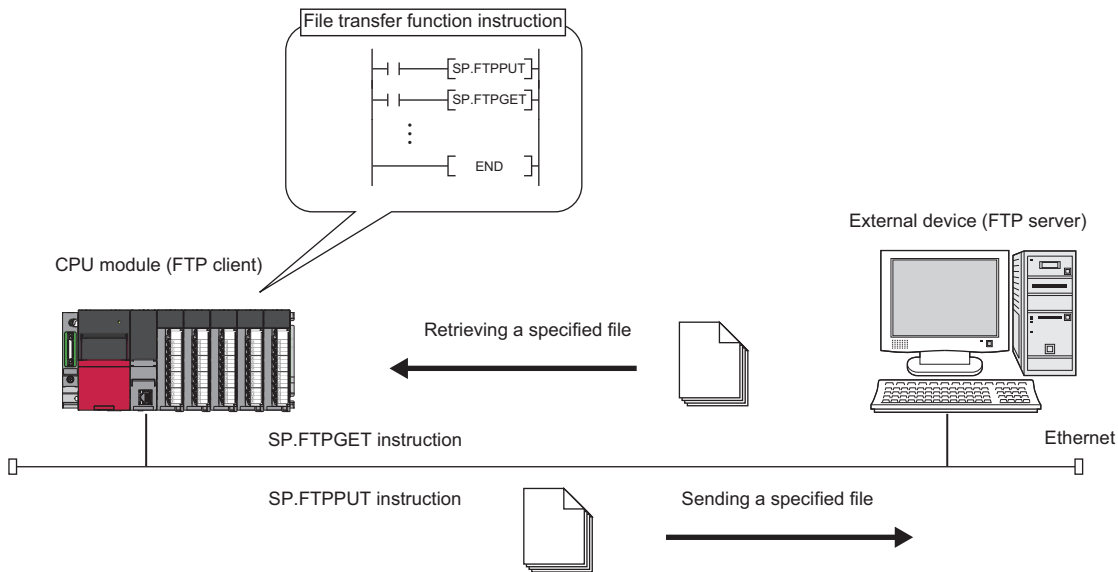

*1 To execute this function, an FTP server is required. For details on an FTP server, refer to the manual for the server used.

Point

When the data logging function is used, a data logging file can be transferred to the FTP server by using the data logging file transfer function. (📖 MELSEC iQ-R CPU Module User's Manual (Application))

Restriction

Before using the file transfer function (FTP client), check the version of the CPU module used. (👉 Page 564 Added and Enhanced Functions)

File transfer specifications

The following table summarizes the file transfer specifications of the file transfer function (FTP client).

Item	Description
FTP server whose operation has been checked by Mitsubishi	Microsoft® Internet Information Services(IIS) Target OS: • Microsoft® Windows® 10 • Microsoft® Windows® 8.1 • Microsoft® Windows® 8 • Microsoft® Windows® 7
Number of connectable FTP servers	1
FTP transfer mode	Binary mode

Transferable files

The following table lists the files that can be transferred using the file transfer function (FTP client).

○: Transferable, ×: Not transferable

File type		CPU built-in memory			SD memory card	File name and extension
		Program memory	Device/label memory	Data memory		
		Drive 0	Drive 3	Drive 4	Drive 2	
Program		×	×	×	○	ANY_STRING.PRG
FB file		×	×	×	○	ANY_STRING.PFB
CPU parameter		×	×	×	○	CPU.PRM
System parameter		×	×	×	○	SYSTEM.PRM
Module parameter		×	×	×	○	UNIT.PRM
Module extension parameter		×	×	×	○	• UEXmmmnn.PRM • UEXmmm00.PPR
Module-specific backup parameter		×	×	×	○	UBPmmnn.BPR
Memory card parameter		×	×	×	×	MEMCARD.PRM
Device comment		×	×	×	○	ANY_STRING.DCM
Device initial value		×	×	×	○	ANY_STRING.DID
Global label setting file		×	×	×	○	GLBLINF.IFG
Initial label value file	Initial global label value file	×	×	×	○	GLBLINF.LID
	Initial local label value file	×	×	×	○	PROGRAM_NAME.LID
File register		×	○ ^{*1} *2	×	○	ANY_STRING.QDR
Event history		×	×	×	×	• EVENT.LOG • EVEN2.LOG
Device data storage file		×	×	○ ^{*2}	○	DEVSTORE.QST
General-purpose data		×	×	○ ^{*3}	○ ^{*3}	ANY_STRING.ANY_STRING
Data logging setting file	Common setting file	×	×	×	×	LOGCOM.LCS
	Individual setting file	×	×	×	×	LOGnn.LIS
Memory dump setting file		×	×	×	○	MEMDUMP.DPS
Remote password		×	×	×	○	00000001.SYP
Abnormal database check file		×	×	×	○	ErrorDB.txt
System file for backing up CPU module data		×	×	×	○	\$BKUP_CPU_INF.BSC
Backup data file for backing up CPU module data		×	×	×	○	BKUP_CPU.BKD
Device/label data file for backing up CPU module data		×	×	×	○	BKUP_CPU_DEVLAB.BKD
System file for the backup/restoration function for the iQ Sensor Solution		×	×	×	○	\$BKUP_UNIT_INF.BSI
Backup data file for the backup/restoration function for the iQ Sensor Solution		×	×	×	○	Depends on a connected device.QBR
ODBC server setting file		×	×	○	×	netserver.cfg
Database path file		×	×	×	○	dbmaintainpath.txt
Recording setting file		×	×	×	○	RECCFGn.RSI

*1 The file can be transferred only from the FTP client to the FTP server. (Only the SP.FTPPUT instruction can be executed.)

*2 When the SP.FTPPUT instruction is executed with bit 2 (Transfer completion file delete setting) of (s1)+0 set to 1 (Delete), the file cannot be transferred.

*3 The file that has more than one period cannot be transferred. The file that has one period or no period (only file name) can be transferred.

Procedure for executing the file transfer function (FTP client)

To execute the file transfer function (FTP client), set an FTP client and an FTP server in parameters, and execute a file transfer function instruction.

Follow the procedures described below.

Setting an FTP server

1. Set the login name, password, and home directory for the FTP client to the FTP server. In addition, give users a right to access (read/write) files. (📖 Manual for the server used)

Setting an FTP client

1. Set the IP address of the CPU module (built-in Ethernet port part) to be used as an FTP client. (📖 Page 318 Own Node Settings)

🔗 [Navigation window] ⇒ [Parameter] ⇒ Target module ⇒ [Module Parameter] ⇒ [Basic Settings] ⇒ [Own Node Settings] ⇒ [IP Address]

For the Process CPU (redundant mode), set the IP addresses of system A/system B because communications are performed using the IP addresses. Set the IP address of system B by the following procedure. (📖 Page 407 Redundant System Settings)

🔗 [Navigation window] ⇒ [Parameter] ⇒ Target module ⇒ [Module Parameter] ⇒ [Application Settings] ⇒ [Redundant System Settings] ⇒ [System B IP Address]

2. Set "Use" for "To Use or Not to Use FTP Client Settings" in "FTP Client Settings" under "Application Settings".

For details on other setting items in "FTP Client Settings", refer to the following.

📖 Page 330 FTP Client Settings

3. Set "Use" for "To Use or Not to Use DNS Server Settings" in "DNS Settings" under "Application Settings" as needed.

For details on other setting items in "DNS Settings", refer to the following.

📖 Page 330 DNS Settings

4. Set a timer for the file transfer function (FTP client) in "Timer Settings for Data Communication" under "Application Settings" as needed. (📖 Page 392 Timer Settings for Data Communication)

Item	Setting
Timeout period	<ul style="list-style-type: none"> • TCP Resend Timer • TCP ULP Timer
Alive check interval and count	<ul style="list-style-type: none"> • Destination Alive Check Start Interval Timer • Destination Alive Check Interval Timer • Destination Alive Check Resend Count

Executing a file transfer function instruction

Use the dedicated instructions to execute the file transfer function (FTP client). (📖 Page 523 File transfer function instruction)

■Precautions

- To retrieve the file register file from the FTP server, execute the put command of the FTP server function while the CPU module is in a STOP state.
- To send/retrieve files stored in the CPU built-in memory, such as a sequence program file, to/from the FTP server, execute the CPU module data backup/restoration function together with the instruction. (📖 MELSEC iQ-R CPU Module User's Manual (Application))

File transfer function	Procedure
Sending files to the FTP server	(1) Back up transfer target files stored in memory areas to the SD memory card. (2) Execute the SP.FTPPUT instruction.
Retrieving files from the FTP server	(1) Execute the SP.FTPGET instruction. (2) Restore the retrieved files from the SD memory card to memory areas.

Checking the file transfer function (FTP client) status

The status of the function can be checked with "Status of Each Connection" on the "Ethernet Diagnostics" window. (📖 Page 419 Status of Each Connection)

The screenshot shows the 'Ethernet Diagnostics' window with the 'Status of Each Connection' tab selected. The window has a title bar and standard window controls. Below the title bar, there are configuration options for 'Target Module Specification' (Module No., Board No. 1 (Port 1), I/O Address: 0000, CPU(M), PLC No. 1), 'Change IP Address Display' (DEC, HEX), and 'Change Port No. Display' (DEC, HEX). There are 'Monitoring' and 'Stop Monitoring' buttons. The main area contains a table with the following columns: Connection No./Function, Host Station Port No., Communication Destination Communication Method, Communication Destination IP Address, Communication Destination Port No., Latest Error Code, Protocol, Open System, TCP Status, and Remote Password Status. The table lists connections 1 through 16, all with '----' in most fields. The last three rows are: FTP Server (TCP Status: Disconnected, Remote Password Status: Invalid Or Cancel), FTP Client (TCP Status: Disconnected, Remote Password Status: Invalid Or Cancel), and MELSOFT Direct Connection (Remote Password Status: Invalid Or Cancel). At the bottom, there are 'PING Test', 'Communication Status Test', 'Clear Latest Error Code', and 'Close' buttons.

Connection No./Function	Host Station Port No.	Communication Destination Communication Method	Communication Destination IP Address	Communication Destination Port No.	Latest Error Code	Protocol	Open System	TCP Status	Remote Password Status
1	----	----	----	----	----	----	----	----	----
2	----	----	----	----	----	----	----	----	----
3	----	----	----	----	----	----	----	----	----
4	----	----	----	----	----	----	----	----	----
5	----	----	----	----	----	----	----	----	----
6	----	----	----	----	----	----	----	----	----
7	----	----	----	----	----	----	----	----	----
8	----	----	----	----	----	----	----	----	----
9	----	----	----	----	----	----	----	----	----
10	----	----	----	----	----	----	----	----	----
11	----	----	----	----	----	----	----	----	----
12	----	----	----	----	----	----	----	----	----
13	----	----	----	----	----	----	----	----	----
14	----	----	----	----	----	----	----	----	----
15	----	----	----	----	----	----	----	----	----
16	----	----	----	----	----	----	----	----	----
FTP Server	----	----	----	----	----	----	----	Disconnected	Invalid Or Cancel
FTP Client	----	----	----	----	----	----	----	Disconnected	Invalid Or Cancel
MELSOFT Direct Connection	----	----	----	----	----	----	----	----	Invalid Or Cancel

Precautions

Connection with the FTP server

If a response to an alive check request is not returned from the FTP server, the CPU module (FTP client) determines that the FTP server is not alive and disconnects the connection.

The connection may also be disconnected if the FTP server does not support the TCP KeepAlive function (response to a KeepAlive ACK message).

Communication error when retrieving transfer files

If a large capacity file is retrieved by execution of the SP.FTPGET instruction, a communication error may occur due to an increase of the transfer processing load. When transferring a large capacity file, extend a connection time (timeout period) in parameters for the FTP server so that no communication error occurs.

Execution of the SD memory card forced disable function

If the SD memory card forced disable function is executed, use of the SD memory card is disabled in the middle of the transfer processing, causing an immediate stop of the processing. Check that the transfer processing has been completed, and execute the function.

Execution of a file transfer function instruction during execution of another function

A file transfer function instruction cannot be executed during execution of the following functions. Check that the following function is not being executed, and then execute the instruction.

- CPU module data backup/restoration function
- iQ Sensor Solution data backup/restoration function

File operation from the external device during file transfer

Do not manipulate the files from an external device, such as an engineering tool, while transferring the files.

If the file is manipulated from another device while transferring the files, the external device may issue an error. If the processing has been halted due to an error, re-execute the processing after the file transfer operation.

Communication processing

If another communication function (MELSOFT connection or SLMP) is simultaneously executed with UDP/IP during file transfer with FTP, an error such as timeout may occur. Either communicate after the file is transferred, or communicate with TCP/IP.

Deleting unnecessary files

If a cable is disconnected, system is powered off, or the CPU module is reset during the file transfer, delete unnecessary files (such as a temporary file and undefined files) in the FTP server. Then, transfer files again.

When the process CPU (redundant mode) is used

■System switching during the file transfer

- When the system switching occurs during the file transfer by an engineering tool, the system switching instructions, or the system switching request from the network module, the system will be switched after completed the processing.
- When the system switching occurs because of power-off, reset, hardware failure, or stop error during the file transfer, the connections between the FTP server and old control system cannot be disconnected properly. In this case, communications may not be performed with the new control system until disconnection of the old control system is recognized due to FTP server timeout. To reconnect with the FTP server, keep an attempt to execute until the connection with the FTP server becomes open. In addition, delete unnecessary files on the FTP server when the files are generated. The files are not remain in the FTP server since the FTP connection are not connected even when the system switching is executed other than during the file transfer.

■SP.FTPPUT instruction immediately after system switching

When the SP.FTPPUT instruction is executed immediately after the system switching, execute the instruction with transfer files existing (such as generated files) in the new control system.

1.11 Time Setting Function (SNTP Client)

Time information is collected from the time information server (SNTP server) connected on the LAN at the specified timing, and the CPU module's time is automatically set.

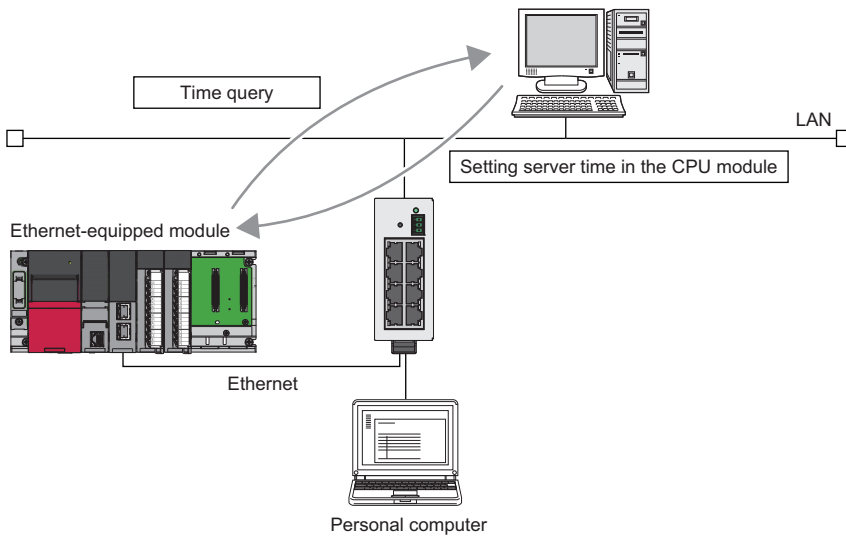

Restriction

This setting is not available when the RJ71EN71 network type is set to "Q Compatible Ethernet".

Point

An SNTP server (time information server) must be provided on the LAN line to use this function.

Time setting execution timing

Time setting is executed in the following timing.

- At powering off and on resetting the CPU module
- At each set time (execution at set cycle interval)
- At set time (execution at set time)
- At programmed arbitrary timing^{*1}

^{*1} The time is set when 'Time setting function (SNTP client) execution' (Un\G11009.0 for the RJ71EN71 and RnENCPU (network part), Un\G299.0 for the CPU module (built-in Ethernet port part)) is turned on.

Point

When setting the time at the CPU module power on or reset, check the hub or external device connection before setting.

Setting procedure

Set with "Time Setting (SNTP client)" under "Application Settings". (☞ Page 391 Time Setting)

Confirming the execution results

The time setting execution results can be checked with the following module label.

■For the RJ71EN71 and RnENCPU (network part)

- 'Operation result' (Un\G11000)
- 'Execution time' (Un\G11001 to Un\G11007)
- 'Required response time' (Un\G11008)

■For the CPU module (built-in Ethernet port part)

- 'Operation result' (Un\G290)
- 'Execution time' (Un\G291 to Un\G297)
- 'Required response time' (Un\G298)

Precautions

■Time to be set

The time to be set in the CPU module is the time which is obtained by adjusting the time information (UTC) retrieved from the SNTP server (time information server) based on the time zone set in "Clock Related Setting" under "Operation Related Setting" of "CPU Parameter".

■Communication timeout

If a response is not received from the SNTP server (time information sever) 20 seconds after the time setting is executed, the communication times out. An error does not occur when the communication times out. Instead, the timeout occurrence appears in the event history.

■Delay by communication time

The time set in the CPU module may be delayed by the time required to communicate with the SNTP server's personal computer. To reduce this delay, specify an SNTP server personal computer on the network that is as close to the Ethernet-equipped module as possible.

■When using multi-CPU system configuration

Execute the time setting only for the CPU No.1. Even if the time is set for a CPU module other than the CPU No.1, the clock data for the CPU No.1 is set automatically.

■Setting the execution time

The execution time can be set in the range of 1980 to 2079.

■Daylight saving time function

This function is supported by the RJ71EN71 Ver.68 or later.

1.12 Web Server Function

The Web server function can read/write device data from/to the CPU module by using a Web browser. The device data can be read/written from/to the CPU module by using a general-purpose Web browser of an Ethernet-connected personal computer and also by using a general-purpose Web browser of a tablet or smartphone via Ethernet. An original Web page can be created by users and displayed as well.

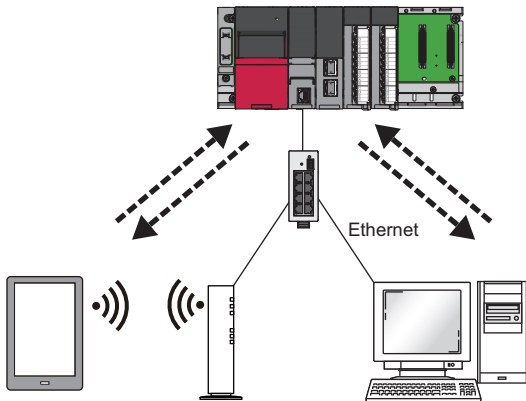

For the specifications, parameter settings, procedures before operation, system configuration, functions, and troubleshooting of the Web server function, refer to the following.

📖 MELSEC iQ-R/MELSEC iQ-F Web Server Function Guide Book

This manual describes the JavaScript objects and CGI objects that can be used in the user Web page.

Point

Incorporate measures other than this function if the programmable controller system's safety must be maintained against illegal access from an external device. Mitsubishi shall not be held liable for any system problems that may occur from illegal access. The user authentication of the Web server function is one method of preventing illegal access (such as program or data destruction) from an external device. It does not completely prevent illegal access.

Examples of measures for illegal access are given below.

- Install a firewall
- Install a personal computer as a relay station, and control the relay of send/receive data with an application program
- Install an external device for which the access rights can be controlled as a relay station (Contact the network provider or equipment dealer for details on the external devices for which access rights can be controlled.)

JavaScript objects

JavaScript objects in the library of user Web pages enable device data to be read or written easily on the user Web page. The following table lists the objects in the JavaScript object library for the user Web page (RUserWebLib.js).

Object name (function name)	Description	Reference
Data block (WSDatblk)	Displays the specified device data in a table format.	Page 153 Data block (WSDatblk)
Level display (WSLevel)	Displays what percentage the device value accounts for of the whole (the range between the upper and lower limit values).	Page 155 Level display (WSLevel)
Figure display (WSFigure)	Displays the specified figure when the device value reaches the set value.	Page 157 Figure display (WSFigure)
Image display (WSPicture)	Displays the specified image file when the device value reaches the set value.	Page 159 Image display (WSPicture)
Historical graph (WSHstgrp)	Displays the device data in a time-series line graph.	Page 160 Historical graph display (WSHstgrp)
Write button (WSWtrBtn)	Writes the specified value to the specified device.	Page 162 Write button (WSWtrBtn)
Logoff button (WSLogoutBtn)	Performs the logoff operation.	Page 163 Logoff button (WSLogoutBtn)

Common information on JavaScript objects

■ Style sheet

Descriptions for the styles such as character size, color, line color, the background color of the user Web page can be omitted. If descriptions are omitted or incorrect, the following default display according to the style sheet (UserWebStyle.css) is applied.

Item	Default
Character color	Black
Background color	White
Line color	Black
Fill color of level display	Blue
Graph line color	Blue
Character size	20
Button character color	According to the setting of the Web browser
Button background color	According to the setting of the Web browser
Button line color	According to the setting of the Web browser

The character font differs depending on the terminal used to display the user Web page.

Restriction

When editing the style sheet in the library of the user Web page, do not change the class names in the style sheet. In addition, do not define the style classes with the same name.

Parameter settings of JavaScript objects

- When an optional parameter setting is omitted, the object will be displayed as default. Also, when the optional parameter setting is abnormal, the object will be displayed as default.
- Set parameters using the specified data formats. A parameter error occurs if a parameter is set in the data format other than the specified one (for example, when a character string such as '1' is set in the parameter that should be a numeric value).
- If the X- and Y- coordinates are omitted, the object will be placed at the upper left end (coordinates 0, 0).
- For an RGB value specified for parameters or HTML specifications such as a color name, the range check is not performed. The operation for an abnormal setting differs depending on the browser.
- When specifying a device name which includes \, such as Un\G and Jn\X, repeat \ as Un\\G and Jn\\X. (\ is an escape sequence.)
- The following table lists formats and positional notations available for the devices which can be set for JavaScript objects.

○: Can be set, ×: Cannot be set

Classification	Type	Device name	16-bit signed 16-bit unsigned	32-bit signed 32-bit unsigned	Single-precision real number Double-precision real number	Bit	
User device	Bit	Input (X)	×	×	×	○	
		Output (Y)	×	×	×	○	
		Internal relay (M)	×	×	×	○	
		Latch relay (L)	×	×	×	○	
		Link relay (B)	×	×	×	○	
		Annunciator (F)	×	×	×	○	
		Link special relay (SB)	×	×	×	○	
		Edge relay (V)	×	×	×	○	
		Step relay (S)	×	×	×	○	
	Bit/word	Timer (T)	○: Unsigned decimal/ hexadecimal	×	×	×	×
		Retentive timer (ST)	○: Unsigned decimal/ hexadecimal	×	×	×	×
	Bit/double word	Long timer (LT)	×	○: Unsigned decimal/ hexadecimal	×	×	×
		Long retentive timer (LST)	×	○: Unsigned decimal/ hexadecimal	×	×	×
	Bit/word	Counter (C)	○: Unsigned decimal/ hexadecimal	×	×	×	×
	Bit/double word	Long counter (LC)	×	○: Unsigned decimal/ hexadecimal	×	×	×
	Word	Data register (D)	○: Decimal/hexadecimal	○: Decimal/hexadecimal	○: Decimal	×	×
		Link register (W)	○: Decimal/hexadecimal	○: Decimal/hexadecimal	○: Decimal	×	×
		Link special register (SW)	○: Decimal/hexadecimal	○: Decimal/hexadecimal	○: Decimal	×	×
	Bit	Direct access input (DX)	×	×	×	○	○
Direct access output (DY)		×	×	×	○	○	
System device	Bit	Special relay (SM)	×	×	×	○	
	Word	Special register (SD)	○: Decimal/hexadecimal	○: Decimal/hexadecimal	○: Decimal	×	
Link direct device	Bit	Link input (Jn\X)	×	×	×	○	
	Bit	Link output (Jn\Y)	×	×	×	○	
	Bit	Link relay (Jn\B)	×	×	×	○	
	Bit	Link special relay (Jn\SB)	×	×	×	○	
	Word	Link register (Jn\W)	○: Decimal/hexadecimal	○: Decimal/hexadecimal	○: Decimal	×	
	Word	Link special register (Jn\SW)	○: Decimal/hexadecimal	○: Decimal/hexadecimal	○: Decimal	×	

Classification	Type	Device name	16-bit signed 16-bit unsigned	32-bit signed 32-bit unsigned	Single-precision real number Double-precision real number	Bit
Module access device	Word	Module access device (Un\G)	○: Decimal/hexadecimal	○: Decimal/hexadecimal	○: Decimal	×
CPU buffer memory access device	Word	CPU buffer memory access device (U3En\G, U3En\HG)	○: Decimal/hexadecimal	○: Decimal/hexadecimal	○: Decimal	×
Index register	Word	Index register (Z)	○: Decimal/hexadecimal	○: Decimal/hexadecimal	○: Decimal	×
	Double word	Long index register (LZ)	×	○: Decimal/hexadecimal	○: Decimal for single-precision real number	×
File register	Word	File register (R)	○: Decimal/hexadecimal	○: Decimal/hexadecimal	○: Decimal	×
		File register (ZR)	○: Decimal/hexadecimal	○: Decimal/hexadecimal	○: Decimal	×
Refresh data register	Word	Refresh data register (RD)	○: Decimal/hexadecimal	○: Decimal/hexadecimal	○: Decimal	×
Other devices	—	SFC block device (BL)	×	×	×	○
	—	SFC step device (BLn\S)	×	×	×	○

■Refreshing cycle

Set the refreshing cycle of the user Web page to the variable `updateInterval` in HTML. This refreshing cycle applies to all the objects in the user Web page. When the variable `updateInterval` is not described in HTML or it is out of range between 1 and 120^{*1}, 5-second interval (default) applies to the operation.

*1 The setting range depends on the firmware version of the CPU module. For details, refer to the following.

 MELSEC iQ-R/MELSEC iQ-F Web Server Function Guide Book

Ex.

When refreshing the user Web page in 10-second interval

```
<script>
  var updateInterval = 10;
</script>
```

■Message display language

Set the message display language to the variable `dspLanguage` in HTML. The following table lists the settings of the variable `dspLanguage` and message display languages.

dspLanguage	Message display language
No description	English
ja-JP	Japanese
en-US	English
zh-CN	Chinese (Simplified)
Other than the above (out of range)	English

■Available files

The following files are available in the user Web page.

File	Extension	MIME type
HTML	.html	text/html
	.htm	text/htm
JavaScript	.js	text/javascript
CSS	.css	text/css
GIF image	.gif	image/gif
PNG image	.png	image/png
JPG/JPEG image	.jpg(.jpeg)	image/jpeg

Data block (WSDatblk)

This object displays the specified device data in a table format. The current values of the devices are displayed as center aligned and updated in the fixed interval.

- direction = 0 (Vertical)

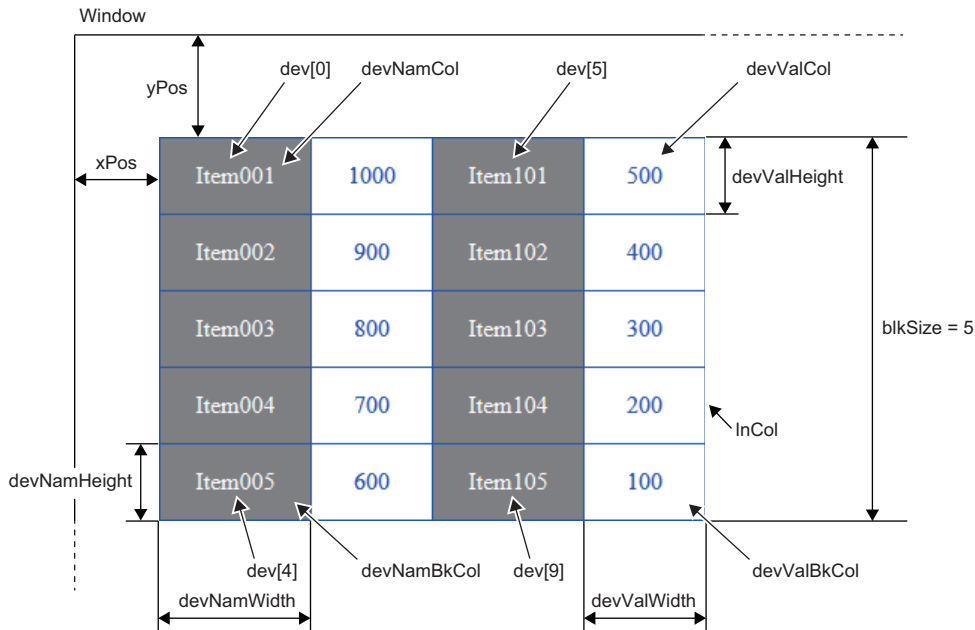

- direction = 1 (Horizontal)

Item001	Item002	Item003	Item004	Item005
1000	900	800	700	600
Item101	Item102	Item103	Item104	Item105
500	400	300	200	100

blkSize = 5

Set dev[n] for the devices to be displayed. (n: 0 to 31)

○: Required, —: Optional

Parameter	Item	Description	Requirement
dev[0].dsp	Device display name 1	A name to be displayed with the data block	○*1
dev[0].name	Device name 1	Device type + device number	○
dev[0].base	The positional notation of the device 1	K: Decimal H: Hexadecimal B: Binary	○
dev[0].format	The data format of the device 1	0: 16-bit signed 1: 16-bit unsigned 2: 32-bit signed 3: 32-bit unsigned 4: Single-precision real number 5: Double-precision real number 6: Bit	○
⋮			
dev[31].dsp	Device display name 32	A name to be displayed with the data block	—
dev[31].name	Device name 32	Device type + device number	—
dev[31].base	The positional notation of the device 32	K: Decimal H: Hexadecimal B: Binary	—

Parameter	Item	Description	Requirement
dev[31].format	The data format of the device 32	0: 16-bit signed 1: 16-bit unsigned 2: 32-bit signed 3: 32-bit unsigned 4: Single-precision real number 5: Double-precision real number 6: Bit	—
direction	Display direction	0: Vertical 1: Horizontal	— (If omitted, it is 0.)
blkSize	Block size	1 to 32 (The number of lines is displayed when the display direction is set to vertical, and the number of columns is displayed when the display direction is set to horizontal.)	○
devNamDisp	Device name display	0: Not display 1: Display	— (If omitted, it is 1.)
devNamCol	Character color of device name	The RGB value or color name Example: #FF0000 (RGB value) or red (color name)	—
devNamBkCol	Background color of device name		
devNamWidth	Cell width of device name	Positive real numbers (unit: px) (For the horizontal display direction, the setting value of the cell width of device value takes priority, and for the vertical display direction, the setting value of the cell height of device value does.)	○*1
devNamHeight	Cell height of device name		
devValCol	Character color of device value	The RGB value or color name	—
devValBkCol	Background color of device value		
devValWidth	Cell width of device value	Positive real numbers (unit: px)	○
devValHeight	Cell height of device value		
InCol	Line color	The RGB value or color name	—
xPos	X-coordinate	The horizontal coordinate of the data block at the upper left end (unit: px)	—
yPos	Y-coordinate	The vertical coordinate of the data block at the upper left end (unit: px)	—

*1 When the device name is not displayed (devNamDisp = 0), no error occurs without this setting.

■Precautions

- Write all the necessary parameters. If the necessary parameters are not written or the setting value is out of range, an error occurs.
- If the data format is the single-precision real number or double-precision real number, the positional notation will be the decimal.

Level display (WSLevel)

This object displays the current value of the specified device as a level for the range between the upper and lower limit values. The displayed color can be changed when the current value is above or below the specified value. The current values of the devices are updated in the fixed interval.

- direction = 0 (Vertical)

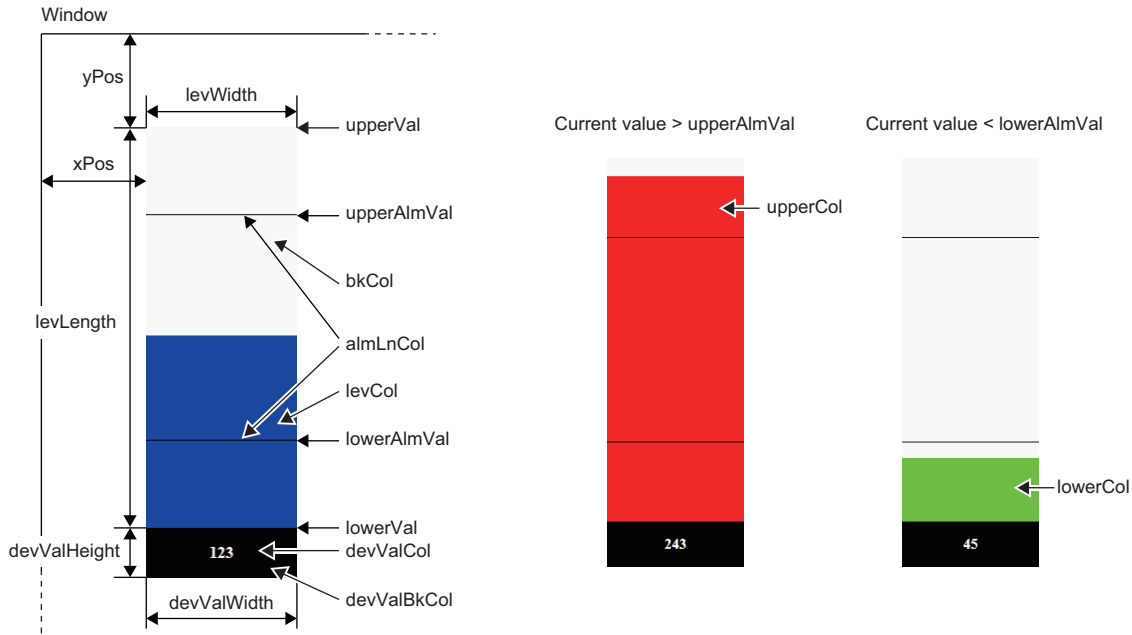

- direction = 1 (Horizontal)

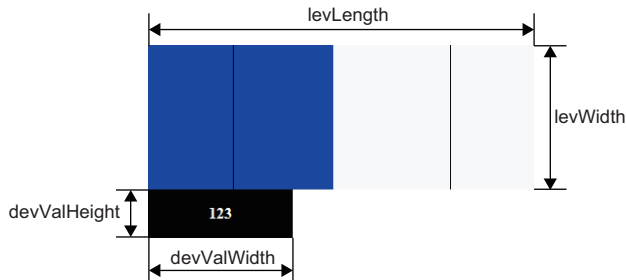

○: Required, —: Optional

Parameter	Item	Description	Requirement
<code>devName</code>	Device name	Device type + device number	○
<code>direction</code>	Level direction	0: Vertical 1: Horizontal	— (If omitted, it is 0.)
<code>upperVal</code>	Upper limit value	A numeric value (decimal) within the range of the specified data format.	○
<code>lowerVal</code>	Lower limit value		
<code>upperAlmVal</code>	Upper limit of alarm value		
<code>lowerAlmVal</code>	Lower limit of alarm value		
<code>dspAlmLn</code>	Display of alarm value line	0: Not display 1: Display	— (If omitted, it is 1.)
<code>dspVal</code>	Display of current value		
<code>valFormat</code>	Data format	0: 16-bit signed 1: 16-bit unsigned 2: 32-bit signed 3: 32-bit unsigned 4: Single-precision real number 5: Double-precision real number	— (If omitted, it is 0.)
<code>levCol</code>	Level display color	The RGB value or color name	—

Parameter	Item	Description	Requirement
upperCol	Display color when the current value is above the upper limit of alarm value.	The RGB value or color name	— (If omitted, it is the same as the level display color.)
lowerCol	Display color when the current value is below the lower limit of alarm value.		
bkCol	Background color	The RGB value or color name	—
almLnCol	Line color of alarm value		—
levLength	Level length	Positive real numbers (unit: px)	○
levWidth	Level width		
xPos	X-coordinate	The horizontal coordinate of the level display at the upper left end (unit: px)	—
yPos	Y-coordinate	The vertical coordinate of the level display at the upper left end (unit: px)	—
devValWidth	Cell width of current value	Positive real numbers (unit: px)	○
devValHeight	Cell height of current value		
devValCol	Character color of current value	The RGB value or color name	—
devValBkCol	Background color of current value		

■Precautions

Write all the necessary parameters. If the necessary parameters are not written or the setting value is out of range, an error occurs.

Figure display (WSFigure)

When the device value is within the specified range, a figure is displayed in the specified color. The device value is monitored in the fixed interval.

- figType = 'Oval' (oval)

Window

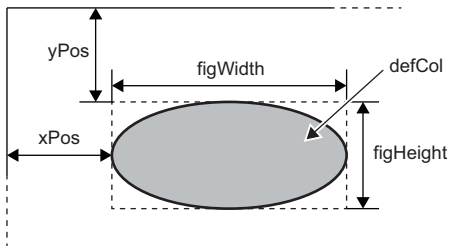

$\text{range}[n].\text{high} \geq \text{Current value} \geq \text{range}[n].\text{low}$

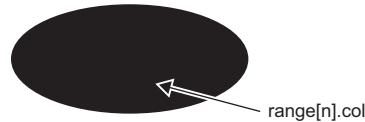

- figType = 'Rect' (rectangle)

Window

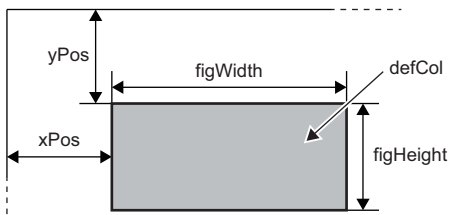

- figType = 'Tri' (triangle)

When a negative value is set for the figure height (figHeight), the downward triangle is displayed.

Window

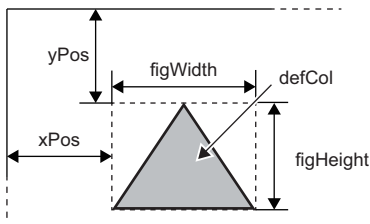

Set range[n] for the range of the display color to be displayed. (n: 0 to 4)

○: Required, —: Optional

Parameter	Item	Description	Requirement
devName	Device name	Device type + device number	○
devFormat	The data format of the device	0: 16-bit signed 1: 16-bit unsigned 2: 32-bit signed 3: 32-bit unsigned 4: Single-precision real number 5: Double-precision real number 6: Bit	○
figType	Figure type	Oval: Oval (When specifying a circle, set the figure height = width.) Rect: Rectangle (When specifying a square, set the figure height = width.) Tri: Triangle	○
figHeight	Figure height	Real numbers (unit: px)	○
figWidth	Figure width	When a negative value is set, the value is treated as an absolute value.	○
defCol	Default display color	The RGB value or color name (This item is displayed when the device value is out of the setting range.)	○
rangeNum	Number of setting ranges	1 to 5	○
range[0].low	Lower limit of setting range 1	A numeric value (decimal) within the range of the specified data format.	○
range[0].high	Upper limit of setting range 1		

Parameter	Item	Description	Requirement
range[0].col	Display color when device value is within setting range 1	The RGB value or color name	○
range[1].low	Lower limit of setting range 2	A numeric value (decimal) within the range of the specified data format.	—
range[1].high	Upper limit of setting range 2		
range[1].col	Display color when device value is within setting range 2	The RGB value or color name	—
⋮			
range[4].low	Lower limit of setting range 5	A numeric value (decimal) within the range of the specified data format.	—
range[4].high	Upper limit of setting range 5		
range[4].col	Display color when device value is within setting range 5	The RGB value or color name	—
xPos	X-coordinate	The horizontal coordinate of the figure display at the upper left end (unit: px)	—
yPos	Y-coordinate	The vertical coordinate of the figure display at the upper left end (unit: px)	

■Precautions

- Write all the necessary parameters. If the necessary parameters are not written or the setting value is out of range, an error occurs.
- If the setting ranges overlap, the figure with the lower number of the setting range is displayed. For example, when the device value is in both of the setting range 1 and 2, the figure of the setting range 1 is displayed.

Image display (WSPicture)

When the device value is within the specified range, the specified image file can be displayed. The device value is monitored in the fixed interval.

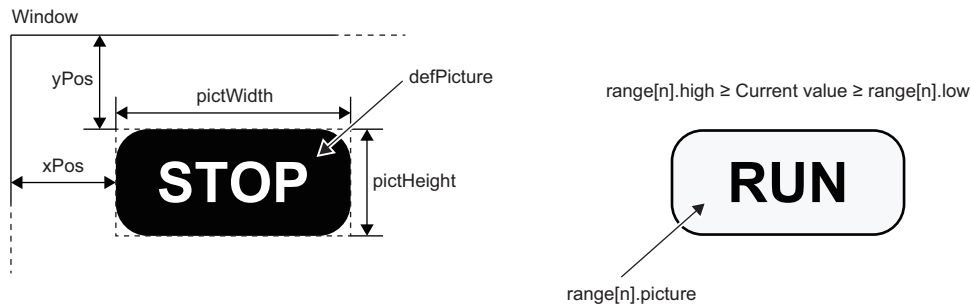

Set range[n] for the range in which the image is to be displayed. (n: 0 to 4)

○: Required, —: Optional

Parameter	Item	Description	Requirement
devName	Device name	Device type + device number	○
devFormat	The data format of the device	0: 16-bit signed 1: 16-bit unsigned 2: 32-bit signed 3: 32-bit unsigned 4: Single-precision real number 5: Double-precision real number 6: Bit	○
pictHeight	Display range height of image file	Real numbers (unit: px)	○
pictWidth	Display range width of image file	When a negative value is set, the value is treated as an absolute value.	○
defPicture	Name of image file to be displayed as default	Extension: .jpg, .jpeg, .gif, .png (This item is displayed when the device value is out of the setting range.)	○
rangeNum	Number of setting ranges	1 to 5	○
range[0].low	Lower limit of setting range 1	A numeric value (decimal) within the range of the specified data format.	○
range[0].high	Upper limit of setting range 1		○
range[0].picture	Name of image file displayed when device value is within setting range 1	Extension: .jpg, .jpeg, .gif, .png	○
range[1].low	Lower limit of setting range 2	A numeric value (decimal) within the range of the specified data format.	—
range[1].high	Upper limit of setting range 2		—
range[1].picture	Name of image file displayed when device value is within setting range 2	Extension: .jpg, .jpeg, .gif, .png	—
⋮			
range[4].low	Lower limit of setting range 5	A numeric value (decimal) within the range of the specified data format.	—
range[4].high	Upper limit of setting range 5		—
range[4].picture	Name of image file displayed when device value is within setting range 5	Extension: .jpg, .jpeg, .gif, .png	—
xPos	X-coordinate	The horizontal coordinate of the figure display range at the upper left end (unit: px)	—
yPos	Y-coordinate	The vertical coordinate of the figure display range at the upper left end (unit: px)	—

■Precautions

- Write all the necessary parameters. If the necessary parameters are not written or the setting value is out of range, an error occurs.
- The total size of the image file on one screen should be 100K bytes or smaller.
- If the setting ranges overlap, the image with the lower number of the setting range is displayed. For example, when the device value is in both of the setting range 1 and 2, the figure of the setting range 1 is displayed.

Historical graph display (WSHstgrp)

This object displays the device value in a time-series line graph. The device value is read in every refreshing cycle. After the number of records is reached, the display shifts to left and old records are deleted.

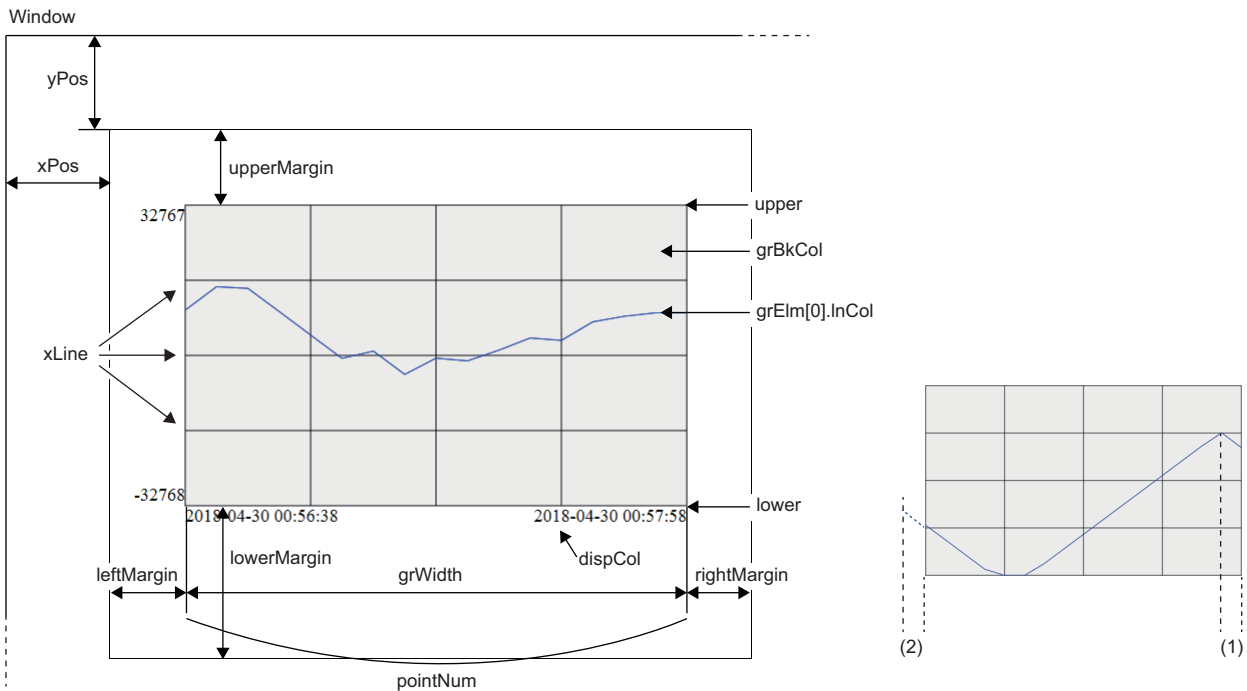

(1) Refreshing cycle

(2) Data in a refreshing cycle is out of the display range.

Set `grElm[n]` for the devices to be displayed. (n: 0 to 31)

○: Required, —: Optional

Parameter	Item	Description	Requirement
<code>grElmNum</code>	Number of graph elements	1 to 32	○
<code>devFormat</code>	The data format of the device	0: 16-bit signed 1: 16-bit unsigned 2: 32-bit signed 3: 32-bit unsigned 4: Single-precision real number 5: Double-precision real number 6: Bit	○
<code>grElm[0].devName</code>	Device name	Device type + device number	○
<code>grElm[0].InCol</code>	Graph line color	The RGB value or color name Example: #FF0000 (RGB value) or red (color name)	—
<code>grElm[1].devName</code>	Device name	Device type + device number	—
<code>grElm[1].InCol</code>	Graph line color	The RGB value or color name	—
⋮			
<code>grElm[31].devName</code>	Device name	Device type + device number	—
<code>grElm[31].InCol</code>	Graph line color	The RGB value or color name	—
<code>grBkCol</code>	Graph background color	The RGB value or color name	—
<code>dspCol</code>	Character color		
<code>pointNum</code>	Number of records	5 to 100	○
<code>upper</code>	Upper limit value	A numeric value (decimal) within the range of the specified data format.	○
<code>lower</code>	Lower limit value		
<code>yLine</code>	Vertical axis interval (record)	0 to 99	○
<code>xLine</code>	Number of horizontal axes		
<code>grHeight</code>	Graph height	Positive real numbers (unit: px)	○
<code>grWidth</code>	Graph width		

Parameter	Item	Description	Requirement
xPos	X-coordinate	The horizontal coordinate of the historical graph display at the upper left end (unit: px)	—
yPos	Y-coordinate	The vertical coordinate of the historical graph display at the upper left end (unit: px)	
rightMargin	Right margin	Positive real numbers (unit: px)	— (If omitted, it is 0.)
leftMargin	Left margin		
upperMargin	Upper margin		
lowerMargin	Lower margin		

■Precautions

- Write all the necessary parameters. If the necessary parameters are not written or the setting value is out of range, an error occurs.
- The numerical value used in the historical graph is fixed to decimal.
- If the communication load is high for a while, the device value may be lost.

Write button (WSWtrBtn)

This object writes the specified value to the specified device.

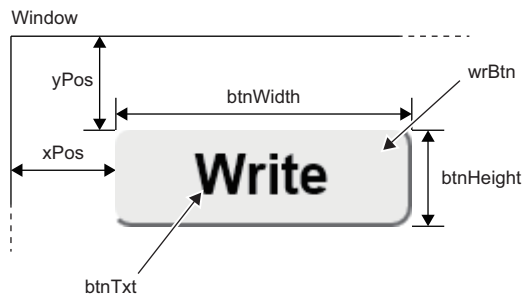

○: Required, —: Optional

Parameter	Item	Description	Requirement
devName	Device name	Device type + device number	○
devBase	Positional notation of device	K: Decimal H: Hexadecimal B: Binary	○
devFormat	The data format of the device	0: 16-bit signed 1: 16-bit unsigned 2: 32-bit signed 3: 32-bit unsigned 4: Single-precision real number 5: Double-precision real number 6: Bit	○
wrVal	Write value	The setting range depends on the positional notation and data format of the device. Specify a string for the input value. Example: wrVal: '1'	○
wrBtn	Write button	Class element name It is used for the selector of the style sheet.	—
btnTxt	Text displayed on the button	Optional	— (If omitted, it is empty.)
btnWidth	Button width	Positive real numbers (unit: px)	○
btnHeight	Button height		
wrConfirm	Write confirmation message	0: Not display 1: Display	— (If omitted, it is 0.)
language	Message language	0: Japanese 1: English 2: Chinese (Simplified)	— (If omitted, it is 1.)
xPos	X-coordinate	The horizontal coordinate of the write button at the upper left end (unit: px)	—
yPos	Y-coordinate	The vertical coordinate of the write button at the upper left end (unit: px)	—

■Precautions

- Write all the necessary parameters. If the necessary parameters are not written or the setting value is out of range, an error occurs.
- If no parameter is specified for the write button, the default style specified in UserWebStyle.css is applied.

Logoff button (WSLogoutBtn)

This object places the button to log off. When the logoff button is clicked, the user login page (Log-in_User.html) is displayed.

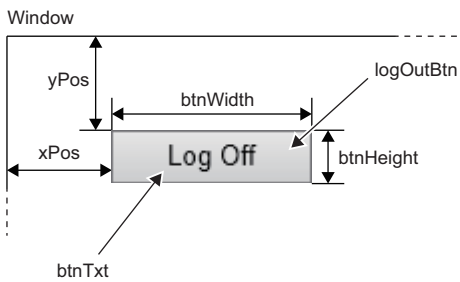

○: Required, —: Optional

Parameter	Item	Description	Requirement
logOutBtn	Logoff button	Class element name of button object (It is used for the selector of the style sheet.)	—
btnTxt	Text displayed on the button	Optional	— (If omitted, it is empty.)
btnWidth	Button width	Positive real numbers (unit: px)	○
btnHeight	Button height		
xPos	X-coordinate	The horizontal coordinate of the logoff button at the upper left end (unit: px)	—
yPos	Y-coordinate	The vertical coordinate of the logoff button at the upper left end (unit: px)	—

■Precautions

- Write all the necessary parameters. If the necessary parameters are not written or the setting value is out of range, an error occurs.
- When using the logoff button, always store the user login page (Log-in_User.html) in the SD memory card.
- If no parameter is specified for the logoff button, the default style specified in UserWebStyle.css is applied.

CGI object

By using the CGI object, a simple and small file size user Web page can be created.

For an overview of CGI, refer to reference books on the market.

For the user Web page, the following CGI objects dedicated to read/write data from/to devices can be used.

File name	Item	Description	Reference
RdDevRnd.cgi	Device read CGI	Reads the current value of the specified device.	Page 166 Device read CGI
WrDevRnd.cgi	Device write CGI	Writes the specified value to the specified device.	Page 172 Device write CGI

The data acquisition from the Web server or the operation to the Web server is executed by passing it as the CGI request from the client and returning the execution result as a response to the client.

Data specified for CGI object

The data used in the CGI object are listed below.

■Device name

The following table lists the devices that can be accessed with the device read CGI and device write CGI.

Type	Device
Bit device	X, Y, M, L, B, F, SB, V, DX, DY, SM, Jn\X, Jn\Y, Jn\B, Jn\SB, BL, BLn\S
Word device	T (Current value), ST (Current value), C (Current value), D, W, SW, SD, Jn\W, Jn\SW, Un\G, U3En\G, U3En\HG, Z, R, ZR, RD
Double-word device	LT (Current value), LST (Current value), LC (Current value), LZ

When specifying a device name which includes \, such as Un\G and Jn\X, repeat \ as Un\\G and Jn\\X. (\ is an escape sequence.)

■ Device size

Applicable device size differs depending on the device.

For the notation of the device number, specify decimal or hexadecimal depending on the device.

○: Available in both device read CGI and device write CGI, ×: Not available

Device	Notation	Device size			
		B: Bit	W: Word	D: Double word	Q: Quad word
X	Hexadecimal	○	×	×	×
Y	Hexadecimal	○	×	×	×
M	Decimal	○	×	×	×
L	Decimal	○	×	×	×
B	Hexadecimal	○	×	×	×
F	Decimal	○	×	×	×
SB	Hexadecimal	○	×	×	×
V	Decimal	○	×	×	×
DX	Hexadecimal	○	×	×	×
DY	Hexadecimal	○	×	×	×
SM	Decimal	○	×	×	×
Jn\X	Hexadecimal	○	×	×	×
Jn\Y	Hexadecimal	○	×	×	×
Jn\B	Hexadecimal	○	×	×	×
Jn\SB	Hexadecimal	○	×	×	×
BL	Decimal	○	×	×	×
BLn\S	Decimal	○	×	×	×
T (current value)	Decimal	×	○	○	○
ST (current value)	Decimal	×	○	○	○
C (current value)	Decimal	×	○	○	○
D	Decimal	×	○	○	○
W	Hexadecimal	×	○	○	○
SW	Hexadecimal	×	○	○	○
SD	Decimal	×	○	○	○
Jn\W	Hexadecimal	×	○	○	○
Jn\SW	Hexadecimal	×	○	○	○
Un\G	Decimal	×	○	○	○
U3En\G	Decimal	×	○	○	○
U3En\HG	Decimal	×	○	○	○
Z	Decimal	×	○	○	○
R	Decimal	×	○	○	○
ZR	Decimal	×	○	○	○
RD	Decimal	×	○	○	○
LT (current value)	Decimal	×	×	○	○
LST (current value)	Decimal	×	×	○	○
LC (current value)	Decimal	×	×	○	○
LZ	Decimal	×	×	○	Device read CGI only

■ Device value

The notation of the device value used in the CGI object should be as follows:

- The CGI object treats device values as a string type in the hexadecimal notation. When using the decimal number or real number in the Web page, convert hexadecimal ↔ decimal or real number by using JavaScript.
- Do not start with 0x. Do not perform the 0 interpolation. For example, when reading/writing the value 0x012F, set the string 12F as the device value.
- The case of the hexadecimal alphanumeric character is ignored. For example, the device value can be expressed either as 12F or 12f to read/write the value 0x012F.

Device read CGI



Reads the current value of the specified device.

■ Access method and access information

Item	Description
Access method	POST
Access destination information (URL)	/cgi/RdDevRnd.cgi

■ Request specifications

The following table lists the parameters used for the request.

Parameter name	Data type	Description	Setting range
NUM	string	Hexadecimal string of the number of read device points (n: 1 to 20)	Set this parameter so that the total number of device points specified to read/write in one Web page is within 32 points.
DEV1	string	Device name of the first point	Up to 16 alphanumeric characters (This parameter is not case-sensitive. The indirect specification, bit specification, digit specification, or index modification cannot be performed.)  Page 164 Device name
TYP1	string	Device size of the first point	B: Bit W: Word D: Double word Q: Quad word  Page 165 Device size
:			
DEV(n)	string	Device name of the nth point (n: 1 to 32)	Up to 16 alphanumeric characters (This parameter is not case-sensitive. The indirect specification, bit specification, digit specification, or index modification cannot be performed.)
TYP(n)	string	Device size of the nth point	B: Bit W: Word D: Double word Q: Quad word

The format of the request data is the query string. Specify DEV(n) and TYP(n) with the serial number. Otherwise, an error occurs.

Ex.

When reading 10 points of device from D0, M100, ..., SD0

NUM=A&DEV1=D0&TYP1=D&DEV2=M100& ... &DEV10=SD0&TYP10=W

Response specifications

The following table lists the parameters used for the response.

Parameter name	Data type	Description
RET	string	Execution result (hexadecimal string) 0000: Normal 0001: Not logged on 0005: Incorrect request source (Referer) 4***: Refer to the following. <ul style="list-style-type: none"> Programmable controller CPU: MELSEC iQ-R Programmable Controller CPU Module User's Manual Process CPU: MELSEC iQ-R Process CPU Module User's Manual
DATA	string	Reading value (array) Hexadecimal string

The format of the response data is JSON.

Ex.

Response data of the device read CGI

```
{
  "RET" : "0",
  "DATA" : [
    "100",
    :
    "FABC"
  ]
}
```

The above response is transferred in the following format on a message.

```
{"RET":"0","DATA":["100", ... ,"FABC"]}
```

When the execution result is abnormal, only RET is transferred.

```
{"RET":"4031"}
```

Point

To display the device value in the real number format on the Web page, specify D: Double word for the device size and execute a request (1). Convert the read data to the real number format by using JavaScript (2).

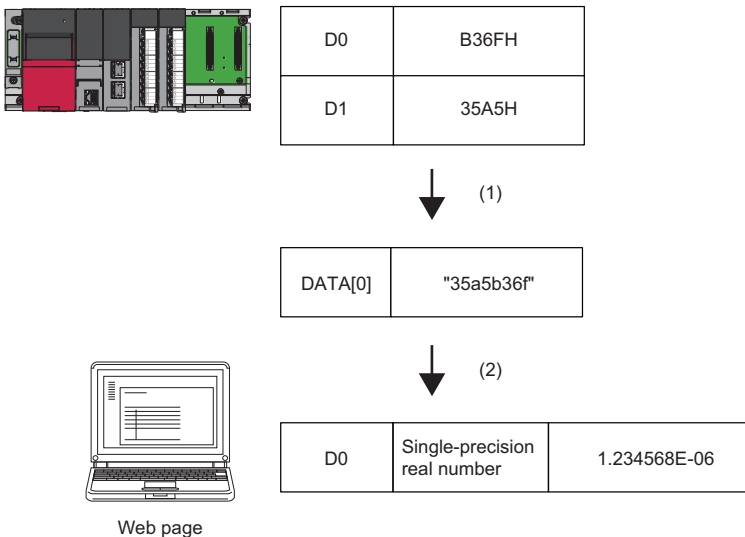

Application example

An example for reading values by using the device read CGI is shown below.

- Display of HTML

Device Name	Data Type	Value
D10	32-bit Integer	
SD0	16-bit Integer	
M0	Bit	

Read

(4) (1) (2) (3)

- (1) Set DEV1.
- (2) Set TYP1.
- (3) Set VAL1.
- (4) Click to call the ReadDeviceRandomTbl function of JavaScript. (Set the table ID for the argument.)

HTML example

```
<form id="devform" name="readdev" method="post">
  <table id="devtbl" class="devtbl" border="1">
    <tr>
      <th>Device Name</th><th>Data Type</th><th>Value</th>
    </tr>
    <tbody>
      <tr>
        <td><input type="text" id="DEV1" name=" DEV1" class="input" value='D10' /></td>
        <td><input type="text" id="TYP1" name=" TYP1" class="input" value='32-bit Integer' /></td>
        <td><input type="text" id="VAL1" name=" VAL1" class="read-input"/></td>
      </tr>
      <tr>
        <td><input type="text" id="DEV2" name="DEV2" class="input" value='SD0' /></td>
        <td><input type="text" id="TYP2" name="TPY2" class="input" value='16-bit Integer' /></td>
        <td><input type="text" id="VAL2" name="VAL2" class="read-input"/></td>
      </tr>
      <tr>
        <td><input type="text" id="DEV3" name="DEV3" class="input" value='M0' /></td>
        <td><input type="text" id="TYP3" name="TYP3" class="input" value='Bit' /></td>
        <td><input type="text" id="VAL3" name="VAL3" class="read-input"/></td>
      </tr>
    </tbody>
  </table>
  <input type="button" value="Read" class="input" onclick=" ReadDeviceRandomTbl(devtbl)"/>
</form>
```

- JavaScript example

```

<!DOCTYPE html>
<html xmlns="http://www.w3.org/1999/xhtml">
  <head>
    <!-- charset setting*Set UTF-8 which is set in the Web server setting -->
    <meta charset="UTF-8">
    <meta http-equiv="X-UA-Compatible" content="IE=edge"/>
    <!-- Set the title name -->
    <title>Sample</title>
    <link href="/css/UserWebStyle.css" rel="stylesheet" media="all" />
    <!-- Library JavaScript reading (change the path depending on the storage position) -->
    <script src="/RUserWebLib.js"></script>
    <!-- Write the original JavaScript hereinafter -->
    <!-- Write the JavaScript of the user here -->
    <script>
      // The function for a CGI request
      function ReadDeviceRandomTbl(devtblid) {
        var devtblitem = document.getElementById(devtblid);
        var i, devitem, typitem;
        var tblrows = devtblitem.rows.length;
        var param;

        // Number of device points setting
        param = "NUM=" + (tblrows - 1) + '&';
        for (i = 1; i < tblrows; i++) {
          // Parameter setting of the device name
          devitem = document.getElementById(devtblitem.rows[i].cells[0].childNodes[0].id);
          param += devitem.name + "=" + devitem.value + '&';

          // Parameter setting of the device size
          typitem = document.getElementById(devtblitem.rows[i].cells[1].childNodes[0].id);
          if ("Bit" == typitem.value) {
            param += typitem.name + "=" + 'B';
          }
          else if ("16-bit Integer" == typitem.value) {
            param += typitem.name + "=" + 'W';
          }
          else if ("32-bit Integer" == typitem.value) {
            param += typitem.name + "=" + 'D';
          }
          else {
            param += typitem.name + "=" + 'Q';
          }
          if (i < (tblrows - 1)) param += '&';
        }

        // Request to the CGI
        xhr = new XMLHttpRequest();
        xhr.open("POST", "/cgi/RdDevRnd.cgi", true);
        xhr.setRequestHeader('Content-Type', 'application/x-www-form-urlencoded');
        var FUNC = function() { ReadDeviceRandomTbl_Response(xhr, devtblid); }; // Response analysis function setting
        xhr.onreadystatechange = FUNC;
        xhr.send(param);
      }
    </script>
  </head>
</html>

```

```

// The function for analyzing a response
function ReadDeviceRandomTbl_Response(xhr, devtblid) {
  // XMLHttpRequest Client status check
  // 0:UNSENT 1:OPENED 2:HEADERS_RECEIVED 3:LOADING 4:DONE
  if( 4 != xhr.readyState ) {
    // End the processing if the status 4 is other than DONE (operation complete).
    return;
  }

  // HTTP Response code check
  if ( 200 != xhr.status ) {
    // Display the error dialog box if the response code is other than "200 OK".
    alert("HTTP STATUS ERROR=" + xhr.status );
    return;
  }

  var i, dataitem;
  var devtblitem = document.getElementById(devtblid);
  var tblrows = devtblitem.rows.length; // Obtain the number of the table lines (including the header).
  var res = JSON.parse( xhr.response ); // Analysis processing of JSON string

  // Judgment from the CGI
  if( res.RET != "0000" ) {
    // Display the error dialog box if the result is abnormal.
    alert("ERROR=" + res.RET);
  }
  else {
    // Reflect the obtained value to the table if the result is normal.
    for ( i = 1, m = 0; i < tblrows; i++, m++) {
      dataitem = document.getElementById(devtblitem.rows[i].cells[2].childNodes[0].id);
      // Set the read result to the value of the table (convert the hexadecimal string to numerical value).
      dataitem.value = parseInt(res.DATA[m],16);
    }
    alert("read complete");
  }
}
</script>
</head>

```



```

<body>
<form>
  <table id="devtbl" class="devtbl" border="1">
    <tr>
      <th>Device Name</th>
      <th>Data Type</th>
      <th>Value</th>
    </tr>
    <tbody>
      <tr>
        <td><input type="text" id="DEV1" name="DEV1" class="input" value="D10"/></td>
        <td><input type="text" id="TYP1" name="TYP1" class="input" value="16-bit Integer"/></td>
        <td><input type="text" id="DATA1" name="DATA1" class="read-input" /></td>
      </tr>
      <tr>
        <td><input type="text" id="DEV2" name="DEV2" class="input" value="D11"/></td>
        <td><input type="text" id="TYP2" name="TYP2" class="input" value="32-bit Integer"/></td>
        <td><input type="text" id="DATA2" name="DATA2" class="read-input" /></td>
      </tr>
      <tr>
        <td><input type="text" id="DEV3" name="DEV3" class="input" value="M0"/></td>
        <td><input type="text" id="TYP3" name="TYP3" class="input" value="Bit"/></td>
        <td><input type="text" id="DATA3" name="DATA3" class="read-input" /></td>
      </tr>
    </tbody>
  </table>
  <input type="button" value="Read" class="input" onclick="ReadDeviceRandomTbl('devtbl')"/>
</form>
</body>
</html>

```

Device Name	Data Type	Value
D10	16-bit Integer	
D11	32-bit Integer	
M0	Bit	

Read

(5) ←

(5) Display the read result.

Point

In the above example, the request parameter is as follows:

NUM=3&DEV1=D10&TYP1=D&DEV2=SD0&TPY2=W&DEV3=M0&TYP3=B

Device write CGI

Writes the specified value to the specified device.

Access method and access information

Item	Description
Access method	POST
Access destination information (URL)	/cgi/WrDev.cgi

Request specifications

The following table lists the parameters used for the request.

Parameter name	Data type	Description	Setting range
NUM	string	Number of write device points (1)	Set 1. (Set this parameter so that the total number of device points specified to read/write per Web page is within 32 points.)
DEV1	string	Device name	Up to 16 alphanumeric characters (This parameter is not case-sensitive. The indirect specification, bit specification, digit specification, or index modification cannot be performed.) ☞ Page 164 Device name
TYP1	string	Device size	B: Bit W: Word D: Double word Q: Quad word ☞ Page 165 Device size
DATA1	string	Write value	Hexadecimal string

The format of the request data is the query string.

Ex.

Writing FFFFH to D0

NUM=1&DEV1=D0&TYP1=W&DATA1=FFFF

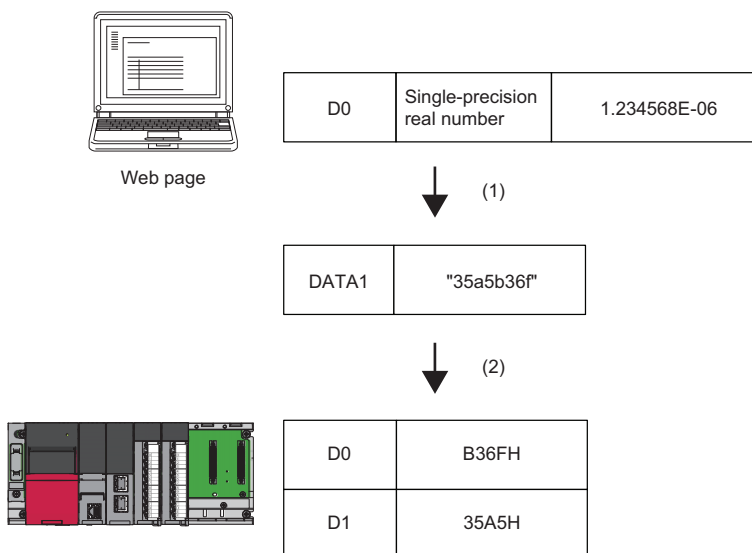

Point

When writing the device value which is input to the Web page in the real number format, the input data needs to be converted to the hexadecimal format by using JavaScript (1). For the device size, D: Double word needs to be specified and performing a request (2) are required as well.



■Response specifications

The following table lists the parameters used for the response.

Parameter name	Data type	Description
RET	string	Execution result (hexadecimal string) 0000: Normal 0001: Not logged on 0002: No permission (A user without device write permission executed the CGI.) 0005: Incorrect request source (Referer) 4***: Refer to the following. <ul style="list-style-type: none"> • Programmable controller CPU:  MELSEC iQ-R Programmable Controller CPU Module User's Manual • Process CPU:  MELSEC iQ-R Process CPU Module User's Manual
DATA	string	The read value of the target device (array) Hexadecimal string

The format of the response data is JSON.

Ex.

Response data of the device write CGI

```
{
  "RET" : "0",
  "DATA" : [
    "100"
  ]
}
```

The above response is transferred in the following format on a message.

```
{"RET":"0","DATA":["100"]}
```

When the execution result is abnormal, data is not written and only the RET is transferred.

```
{"RET":"4031"}
```

■Application example

An example for writing a value by using the device write CGI is shown below.

- Display of HTML

Device Name	Data Type	Value
D10	32-bit Integer	3

Write

(4) (1) (2) (3)

(1) Set DEV1.

(2) Set TYP1.

(3) Set VAL1.

(4) Click it to call the WriteDeviceBlockTbl function of JavaScript. (Set the table ID, the line number where the write starts, and the number of write points 1 for the arguments.)

- HTML example

```
<form id="devform" name="readdev" method="post">
```

```
<table id="devtbl" class="devtbl" border="1">
```

```
<tr>
```

```
<th>Device Name</th><th>Data Type</th><th>Value</th>
```

```
</tr>
```

```
<tbody>
```

```
<tr>
```

```
<td><input type="text" id="DEV1" name=" DEV1" class="input" value='D10/' ></td>
```

```
<td><input type="text" id="TYP1" name=" TYP1" class="input" value='32-bit Integer/' ></td>
```

```
<td><input type="text" id="DATA1" name=" DATA1" class="input" value='3/'></td>
```

```
</tbody>
```

```
</table>
```

```
<input type="button" value="Write" class="input" onclick=" WriteDeviceBlockTbl(devtbl,1,1)"/>
```

```
</form>
```

- JavaScript example

```

<!DOCTYPE html>
<html xmlns="http://www.w3.org/1999/xhtml">
  <head>
    <!-- charset setting*Set UTF-8 which is set in the Web server setting -->
    <meta charset="UTF-8">
    <meta http-equiv="X-UA-Compatible" content="IE=edge"/>
    <!-- Set the title name -->
    <title>Device write CGI sample</title>
    <link href="/css/UserWebStyle.css" rel="stylesheet" media="all" />
    <!-- Library JavaScript reading (change the path depending on the storage position) -->
    <script src="/RUserWebLib.js"></script>
    <!-- Write the original JavaScript hereinafter -->
    <!-- Write the JavaScript of the user here -->
    <script>
      function WriteDeviceBlockTbl(devtblid, row) {
        var dataitem;
        var xhr;
        var devtblitem = document.getElementById(devtblid);
        // Number of device points setting (fixed to one point)
        var param = 'NUM=1&';
        // Parameter setting of the device name
        var devitem = document.getElementById(devtblitem.rows[row].cells[0].childNodes[0].id);
        param += 'DEV1=' + devitem.value + '&';

        // Parameter setting of the device size
        var typitem = document.getElementById(devtblitem.rows[row].cells[1].childNodes[0].id);
        if( 'Bit' == typitem.value){
          param += 'TYP1=' + 'B';
        }
        else if( '16-bit Integer' == typitem.value) {
          param += 'TYP1=' + 'W';
        }
        else if( '32-bit Integer' == typitem.value) {
          param += 'TYP1=' + 'D';
        }
        else {
          param += 'TYP1=' + 'Q';
        }
        param += '&';

        // Parameter setting of the data
        var dataitem = document.getElementById(devtblitem.rows[row].cells[2].childNodes[0].id);
        param += 'DATA1=' + parseInt(dataitem.value).toString(16)

        // Request to the CGI
        xhr = new XMLHttpRequest();
        xhr.open('POST', "/cgi/WrDev.cgi", true);
        xhr.setRequestHeader('Content-Type', 'application/x-www-form-urlencoded');
        var FUNC = function() { WriteDeviceBlockTbl_Response(xhr, typitem, dataitem); }; // Response analysis function setting
        xhr.onreadystatechange = FUNC;
        xhr.send(param);
      }
    </script>
  </head>
  <body>
  </body>
</html>

```

```

// The function for analyzing a response
function WriteDeviceBlockTbl_Response(xhr, typitem, dataitem) {
  // XMLHttpRequest Client status check
  // 0:UNSENT 1:OPENED 2:HEADERS_RECEIVED 3:LOADING 4:DONE
  if( 4 != xhr.readyState ) {
    // End the processing if the status 4 is other than DONE (operation complete).
    return;
  }
  // HTTP Response code check
  if ( 200 != xhr.status ) {
    // Display the error dialog box if the response code is other than "200 OK".
    alert("HTTP STATUS ERROR=" + xhr.status );
    return;
  }

  var value;
  var res = JSON.parse( xhr.response ); // Analysis processing of JSON string
  // Judgment from the CGI
  if( res.RET != "0000" ) {
    // Display the error dialog box if the result is abnormal.
    alert("ERROR=" + res.RET);
  }
  else {
    // Reflect the write result value if the result is normal.
    dataitem.value = parseInt(res.DATA[0],16);
    alert("write complete");
  }
}
}
</script>
</head>

```

```

<body>
<form>
  <table id="devtbl" class="devtbl" border="1">
    <tr>
      <th>Device Name</th>
      <th>Data Type</th>
      <th>Value</th>
    </tr>
    <tbody>
      <tr>
        <td><input type="text" id="DEV1" name="DEV1" class="input" value="D10"/></td>
        <td><input type="text" id="TYP1" name="TYP1" class="input" value="16-bit Integer"/></td>
        <td><input type="text" id="DATA1" name="DATA1" class="input" value="3"/></td>
        <td><input type="button" value=" Write" class="input" onclick="WriteDeviceBlockTbl('devtbl,1')"/></td>
      </tr>
      <tr>
        <td><input type="text" id="DEV2" name="DEV2" class="input" value="D11"/></td>
        <td><input type="text" id="TYP2" name="TYP2" class="input" value="32-bit Integer"/></td>
        <td><input type="text" id="DATA2" name="DATA2" class="input" value="10"/></td>
        <td><input type="button" value=" Write" class="input" onclick="WriteDeviceBlockTbl('devtbl,2')"/></td>
      </tr>
      <tr>
        <td><input type="text" id="DEV3" name="DEV3" class="input" value="M0"/></td>
        <td><input type="text" id="TYP3" name="TYP3" class="input" value="Bit"/></td>
        <td><input type="text" id="DATA3" name="DATA3" class="input" value="1"/></td>
        <td><input type="button" value=" Write" class="input" onclick="WriteDeviceBlockTbl('devtbl,3')"/></td>
      </tr>
    </tbody>
  </table>
</form>
</body>
</html>

```

Point

In the above example, the request parameter is as follows:

```
NUM=1&DEV1=D10&TYP1=D&DATA1=3
```

Error message

Display example of error messages

If an object of the user Web page is used incorrectly, a button to notify the user of an error is displayed at the upper left of the object when the user Web page is displayed. The error message related to the common processing which is not limited to the object is displayed at the upper left of the window.

```
!
en_MSG_0005
en_MSG_0005
en_MSG_0005
en_MSG_0005
en_MSG_0005
en_MSG_0005
en_MSG_0005
en_MSG_0005
en_MSG_0005
en_MSG_0005
en_MSG_0005
en_MSG_0005
en_MSG_0005
en_MSG_0005
en_MSG_0005
en_MSG_0005
en_MSG_0005
en_MSG_0005
The parameter "dev" setting is incorrect.
```

!							
Y0	Y1	Y2	Y3	Y4	Y5	Y6	Y7



Click the button to display the detailed information of the error.

■List of error messages of the user Web page

The following table lists error messages, causes, and action of the user Web page.

Description	Cause	Action
A required parameter "XXX" has not been set.	A required parameter has not been set.	Check the contents of the HTML file.
The setting of the parameter "XXX" is incorrect.	Parameters are out of the setting range.	
	Set values of parameters that should be numeric values are specified with other than numeric values.	
The data format of the device "XXX" is incorrect.	Positional notation of the device, data format, device name	
The receive data contains errors.	The receive data contains errors.	Check that the CPU module and the client terminal are properly connected and update the Web page.
You were logged off. Log on and try again.	The user has been logged off. (Communications are disconnected.)	Check that the CPU module and the terminal are properly connected and log on again.
Specified devices are invalid. The following are the possible causes. <ul style="list-style-type: none"> • A device such as pointer and constant • Unsupported device 	Device names are incorrect.	Check parameters of each object to see if any device name is specified incorrectly.
Specified device No. is invalid. The following are the possible causes. <ul style="list-style-type: none"> • A device over the settable device range of CPU parameter 	Device numbers and buffer memory addresses are out of range or not numeric values. The device range is incorrect.	Check parameters of each object to see if any device number and buffer memory address are specified incorrectly.
Specified modules do not exist. Check the modules.	The module numbers are incorrect. An error has occurred in communications with intelligent function modules.	Check parameters of each object to see if any module number is specified incorrectly. Check that there are no power-offs or errors in extension units.

For details on the other errors, refer to the following.

-  MELSEC iQ-R/MELSEC iQ-F Web Server Function Guide Book
-  MELSEC iQ-R Programmable Controller CPU Module User's Manual
-  MELSEC iQ-R Process CPU Module User's Manual

1.13 Security

Security depending on the network environment can be structured by restricting access by each communication path to the CPU module.

For the restriction methods for access, refer to the following.

- Page 180 IP filter
- Page 181 Remote password

IP filter

Identifies the IP address of the access source, and prevents access from an illegal IP address.

The IP address of the external device to be allowed or denied is set in the parameters, and access from external devices is restricted.

Use of this function is recommended when using in an environment connected to a LAN line.

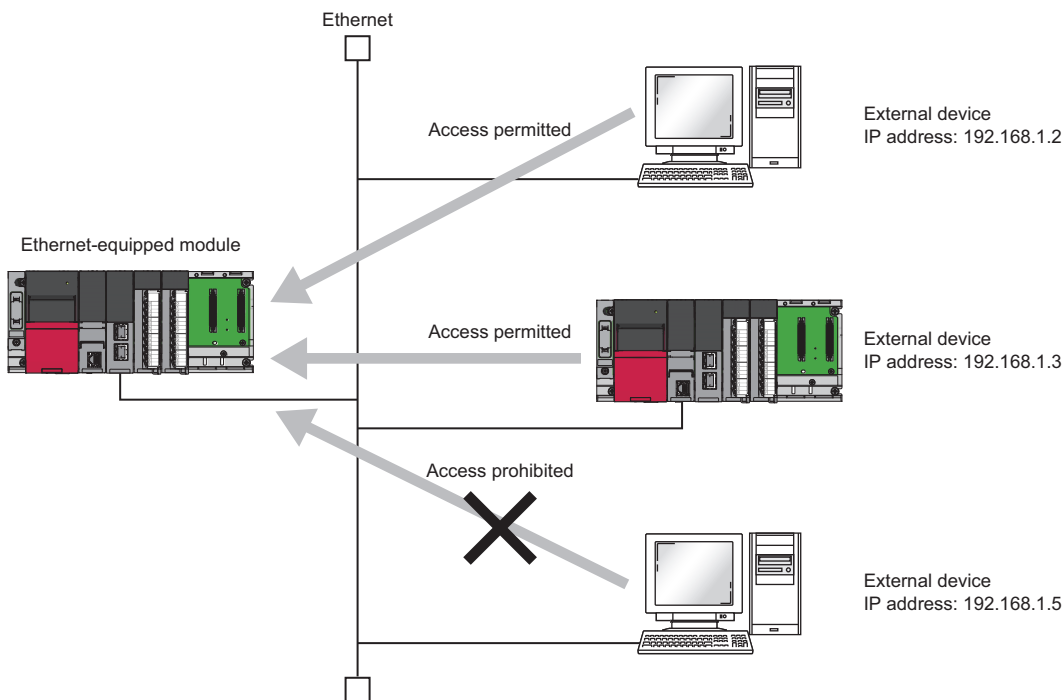

Restriction

- This setting is not available when the RJ71EN71 network type is set to "Q Compatible Ethernet".
- Access cannot be restricted when the network other than Ethernet is set as the communication path.

Point

The IP filter is one method of preventing illegal access (such as program or data destruction) from an external device. It does not completely prevent illegal access. Incorporate measures other than this function if the programmable controller system's safety must be maintained against illegal access from an external device. Mitsubishi shall not be held liable for any system problems that may occur from illegal access.

Examples of measures for illegal access are given below.

- Install a firewall
- Install a personal computer as a relay station, and control the relay of send/receive data with an application program
- Install an external device for which the access rights can be controlled as a relay station (Contact the network provider or equipment dealer for details on the external devices for which access rights can be controlled.)

Setting procedure

1. Set the IP address to be allowed or denied in "IP Filter Settings" of "Security" under "Application Settings". (Page 395 IP Filter Settings)
2. Write the module parameters to the CPU module.
3. The IP filter is enabled when the CPU module power is turned off and on or reset.

Point

Even if the connection is established as set with the Ethernet-equipped module's "External Device Configuration" under "Basic Settings" or the program, access from the external device is either allowed or denied following "IP Filter Settings" of "Security" under "Application Settings". Therefore, if the IP address set in the Ethernet-equipped module's "External Device Configuration" under "Basic Settings" is set to be denied with "IP Filter Settings" of "Security" under "Application Settings", the IP filter is enabled and communication with the external device is denied.

Precautions

If there is a proxy server in the LAN line, deny the IP address for the proxy server. If the IP address is allowed, it will not be possible to prevent access from personal computers that access the proxy server.

Remote password

Permits or prohibits access from the external device to the CPU module via the Ethernet-equipped module. This function can prevent illegal access of the CPU module from a remote location.

Point

The remote password is one method of preventing illegal access (such as program or data destruction) from an external device. It does not completely prevent illegal access. Incorporate measures other than this function if the programmable controller system's safety must be maintained against illegal access from an external device. Mitsubishi shall not be held liable for any system problems that may occur from illegal access. Examples of measures for illegal access are given below.

- Install a firewall
- Install a personal computer as a relay station, and control the relay of send/receive data with an application program
- Install an external device for which the access rights can be controlled as a relay station (Contact the network provider or equipment dealer for details on the external devices for which access rights can be controlled.)

Number of settable modules

Up to eight modules can be set for remote passwords.

When using the multiple CPU system configuration, up to eight modules can be set for each CPU module.

Setting procedure

Set the remote password as follows.

[Navigation window] ⇒ [Parameter] ⇒ [Remote Password]

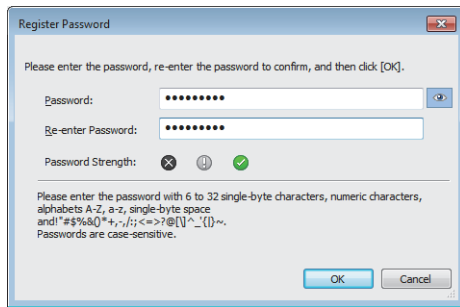

Register Password

Please enter the password, re-enter the password to confirm, and then click [OK].

Password:

Re-enter Password:

Password Strength:

Please enter the password with 6 to 32 single-byte characters, numeric characters, alphabets A-Z, a-z, single-byte space and! "#%&'()*+,-./:;<=>?@[^_`{|}~.-. Passwords are case-sensitive.

OK Cancel

1. Register the remote password on the "Register Password" window.

[Password] button

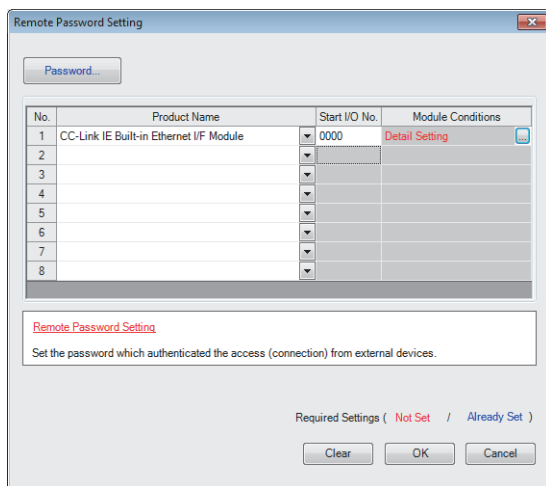

Remote Password Setting

Password...

No.	Product Name	Start I/O No.	Module Conditions
1	CC-Link IE Built-in Ethernet I/F Module	0000	Detail Setting
2			
3			
4			
5			
6			
7			
8			

Remote Password Setting

Set the password which authenticated the access (connection) from external devices.

Required Settings (Not Set / Already Set)

Clear OK Cancel

2. Select the module for which the remote password is to be applied, and set the start I/O number. Select the following items when using the RnENCPU.

- CPU part: "CPU Module (Built-in Ethernet Function)"
- Network part: "CC-Link IE Built-in Ethernet I/F Module"

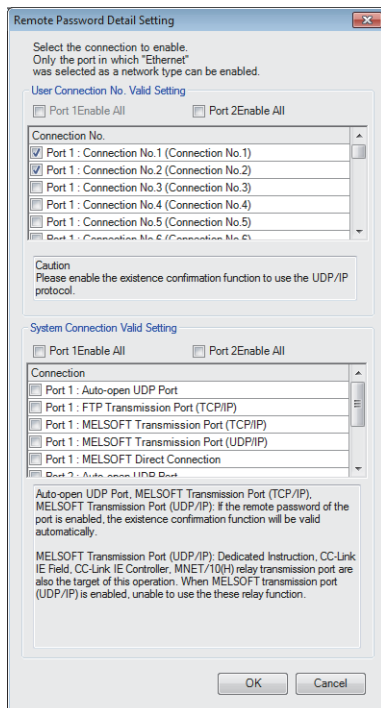

Remote Password Detail Setting

Select the connection to enable.
Only the port in which "Ethernet" was selected as a network type can be enabled.

User Connection No. Valid Setting

Port 1 Enable All Port 2 Enable All

Connection No.

Port 1 : Connection No.1 (Connection No.1)

Port 1 : Connection No.2 (Connection No.2)

Port 1 : Connection No.3 (Connection No.3)

Port 1 : Connection No.4 (Connection No.4)

Port 1 : Connection No.5 (Connection No.5)

Port 1 : Connection No.6 (Connection No.6)

Caution
Please enable the existence confirmation function to use the UDP/IP protocol.

System Connection Valid Setting

Port 1 Enable All Port 2 Enable All

Connection

Port 1 : Auto-open UDP Port

Port 1 : FTP Transmission Port (TCP/IP)

Port 1 : MELSOFT Transmission Port (TCP/IP)

Port 1 : MELSOFT Transmission Port (UDP/IP)

Port 1 : MELSOFT Direct Connection

Port 2 : Auto-open UDP Port

Auto-open UDP Port, MELSOFT Transmission Port (TCP/IP), MELSOFT Transmission Port (UDP/IP): If the remote password of the port is enabled, the existence confirmation function will be valid automatically.

MELSOFT Transmission Port (UDP/IP): Dedicated Instruction, CC-Link IE Field, CC-Link IE Controller, MNET/10(H) relay transmission port are also the target of this operation. When MELSOFT transmission port (UDP/IP) is enabled, unable to use these relay function.

OK Cancel

3. Set the target connection on the "Remote Password Detail Setting" window.

"Detail Setting" for the target module.

4. Write the remote password to the CPU module.
5. The remote password is enabled when the CPU module is powered off and on or reset.

Access permit/prohibit processing operation

This section describes the processing for permitting or prohibiting access of the CPU module with remote password by the external device.

■Access permit processing (Unlock processing)

The external device trying to communicate unlocks the remote password set for the connected Ethernet-equipped module. If the password is not unlocked, the Ethernet-equipped module to which the external device is connected prohibits access, so an error occurs in the external device.

The unlocking method is shown below.

- SLMP dedicated command (Remote Password Unlock)
- Dedicated command (password-unlock) for file transfer function (FTP server)
- Input password from engineering tool

If unlock processing (password authentication) fails a certain number of times, the lockout function provided will deny password authentication for a certain period of time. The lockout time corresponding to the number of password input times is shown below.

Number of password input errors ^{*1}	Lockout time ^{*2}
1st to 5th time	0 minutes
6th time	1 minute
7th time	5 minutes
8th time	15 minutes
9th time or more	60 minutes

*1 The number of password input errors is reset when the correct password is input.

*2 During lockout, the number of password input errors are not counted. Therefore, even if the 7th password input error occurs within one minute of the 6th password input error, the lockout time will not be extended by one minute.

■Access processing

Access to the specified station is possible when the remote password is correctly unlocked. Execute the arbitrary access.

■Access prohibit processing (Lock processing)

When access to the specified station ends, lock the remote password from the external device to disable subsequent access.

The locking method is shown below.

- SLMP dedicated command (Remote Password Lock)
- Dedicated command (password-lock) for file transfer function (FTP server)
- Lock with engineering tool (executed automatically)

Remote password check operation

■Communication that is checked

The Ethernet-equipped module checks the remote password for a communication request made to the own station or other station received from the external device.

When checking a remote password for modules with multiple connections, the connection for which the remote password is set.

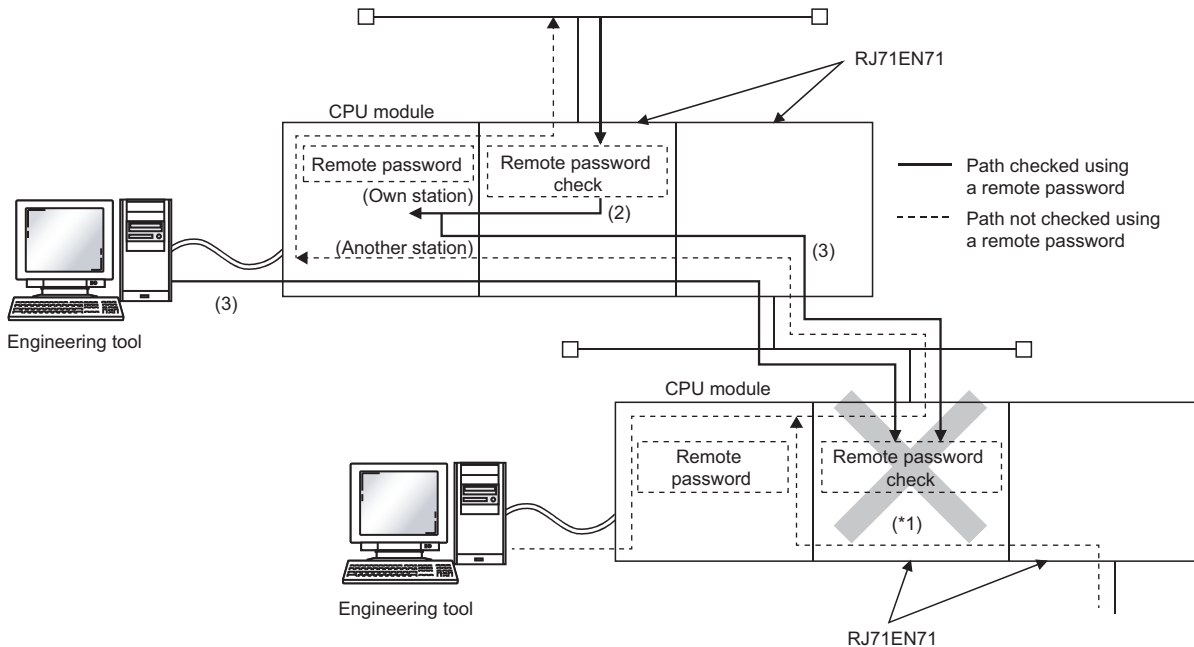

*1 The remote password check is set, so the communication request from the external device is not accepted. If the remote password check is not set, the communication request can be accepted and data can be exchanged from the external device.

■ Accessible station

The station accessible from the external device when a remote password is set for the CPU module and the station that can unlock/lock the remote password are limited to those in the same network number.

The following figure shows an example of when the remote password is set for multiple stations in the system.

Ex.

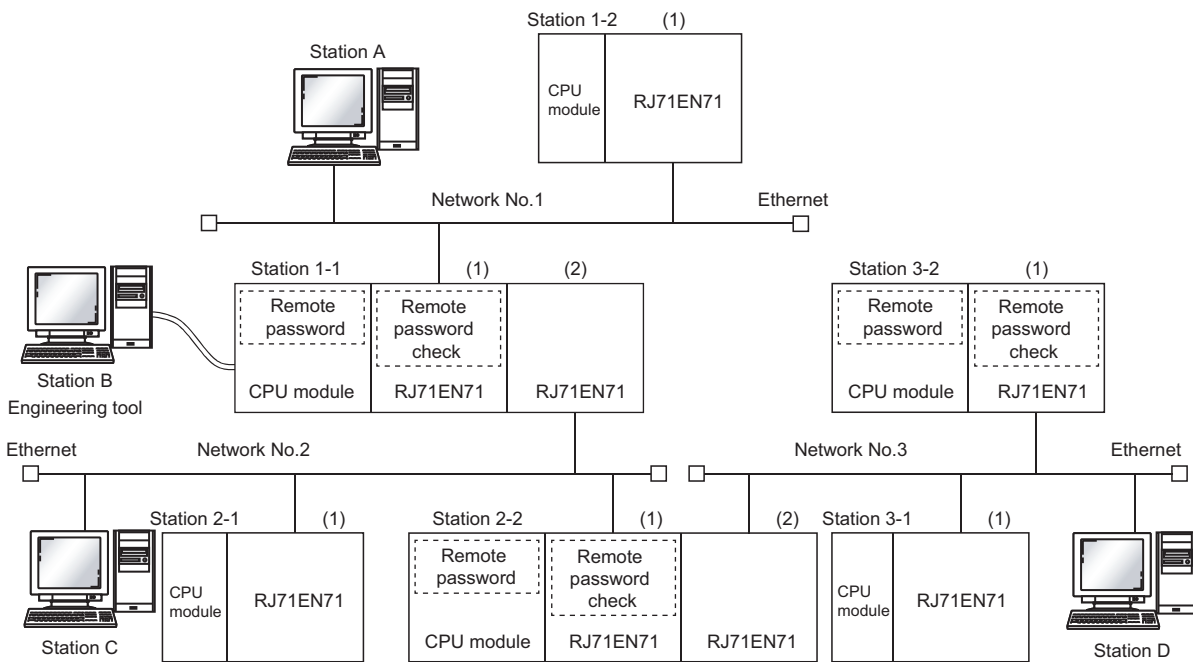

*1 The password can be unlocked and locked by the following external devices.

1-1 station (1): A station only

2-2 station (1): C station only

3-2 station (1): D station only

○: Station accessible from external device after remote password is unlocked

△: Station accessible from external device even if remote password is not unlocked

×: Station that cannot be accessed from external device

External device*2 (Request source)	Target programmable controller (request source)					
	1-1 station CPU	1-2 station CPU	2-1 station CPU	2-2 station CPU	3-1 station CPU	3-2 station CPU
A station	○	△	○	×	×	×
B station	△	△	△	×	×	×
C station	△	△	△	○	○	×
D station	△	△	△	△	△	○

*2 The A station accesses the ○ station after the remote password for 1-1 station (1) is unlocked and access the △ station if the communication line is open.

The B station accesses the △ station if the communication line is open.

The C station accesses the ○ station after the remote password for 2-2 station (1) is unlocked and access the △ station if the communication line is open.

The D station accesses the ○ station after the remote password for 3-2 station (1) is unlocked and access the △ station if the communication line is open.

Precautions

The following section lists the precautions for using remote password.

■Set connection

Set the remote password for the connection used to exchange data with an external device that can execute the unlock/lock processing.

■When remote password is set for UDP/IP connection

- Determine the external device to communicate with and exchange the data. (With UDP/IP, after the remote password is unlocked data can be exchanged with devices other than the unlocked external device too. Determine the communication device before starting use.)
- Always lock the remote password after data communication is finished. (If the remote password is not locked, the unlocked state is held until timeout occurs.)
- Set "UDP" for "Existence Confirmation" of the target connection in "External Device Configuration" under "Basic Settings". Set as small a value as possible for the "Destination Alive Check Start Interval Timer" and "Destination Alive Check Interval Timer" in "Timer Settings for Data Communication" under "Application Settings".

■TCP/IP close processing

If the TCP/IP is closed before the TCP/IP is locked, the CPU module will automatically start the lock processing.

■Remote password valid range

The remote password is valid only for access from the Ethernet-equipped module for which the parameters are set. When using multiple CPU modules in a multi-CPU system, set a remote password for each CPU module for requiring a remote password.

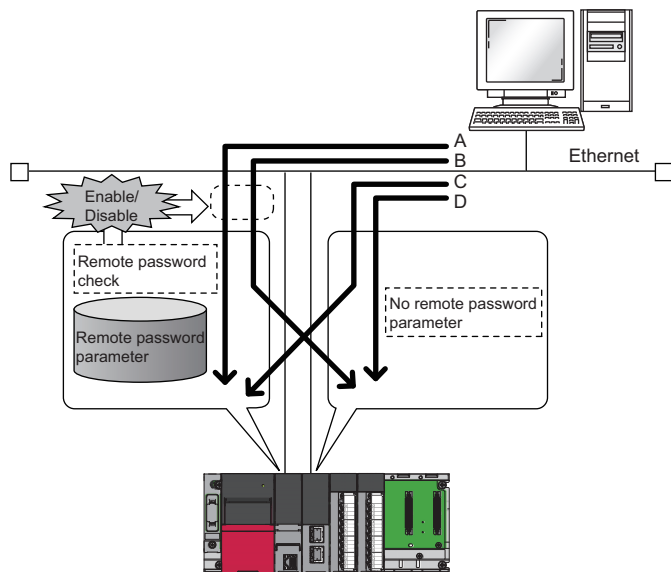

The remote password is checked when accessing with path A or B.

The remote password is not checked when accessing with path C or D.

■Connection for nonprocedural fixed buffer communication

The remote password is not checked during communication for nonprocedural fixed buffer communication, so do not set the remote password check.

■Accessing another station's programmable controller

When the external device is accessing another station's programmable controller via the Ethernet-equipped module, it may not be possible to access the programmable controller if a remote password is set for the CPU module at the relay station or access station.

■When the CPU module is used as a relay station for the connection between the MELSOFT product and GOT

A remote password is enabled when the following items are set in "System Connection" in "Remote Password Detail Setting".

"PLC side I/F Detailed Setting of PLC Module" of "Current Connection Destination"	"System Connection" of "Remote Password Detail Setting"
Ethernet port direct connection	MELSOFT direct connection
Connection via a hub	MELSOFT transmission port (UDP/IP)

The following figure shows the availability of the access when a remote password is set for a relay station (CPU module).

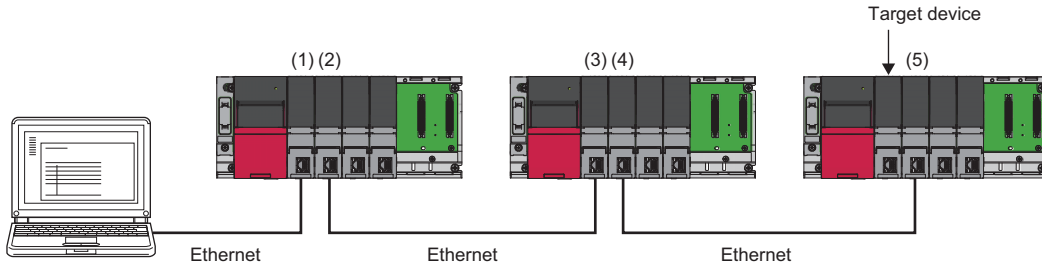

When a remote password is set for (1), the target device becomes accessible after the remote password is unlocked.

When remote passwords are set for (2) to (5), the target device is accessible even when the remote passwords are not unlocked.

1.14 Simple CPU Communication Function (RJ71EN71, RnENCPU (Network Part))

This function allows data communications between specified devices at the specified timing just by making simple settings of the RJ71EN71 and RnENCPU (network part) from an engineering tool. Send/receive is performed with a specified communication destination on a one-to-one basis.

Use this function for communicating device data with programmable controllers.

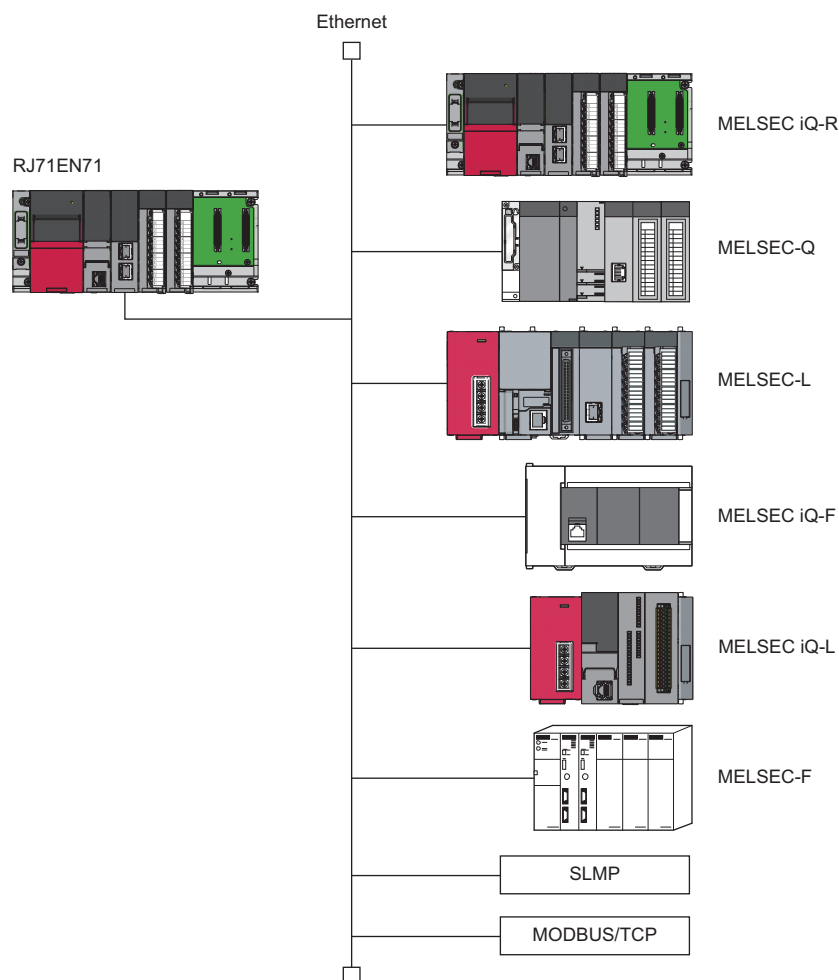

Communication destination	Type	Description
MELSEC iQ-R series	CPU module, Ethernet module	☞ Page 191 Module type
MELSEC-Q series	CPU module, Ethernet module	
MELSEC-L series	CPU module, Ethernet module	
MELSEC iQ-F series	CPU module	
MELSEC iQ-L series	CPU module	
MELSEC-A/AnS series	Ethernet module	
MELSEC-F series	Ethernet block/adaptor	
Programmable controllers of other companies		
SLMP-compatible device	QnA-compatible 3E frame	
MODBUS/TCP slave device		

Point 



Access via routers is also available. For the access, set the subnet mask and default gateway. ( Page 318 Own Node Settings)

Restriction 

Before using the simple CPU communication function, check the versions of the module and engineering tool used. ( Page 224 Restrictions applicable depending on versions)



Setting procedure

The following section describes the settings for using this function.

1. Set "Enable" for "To Use or Not to Use Simple CPU Communication Setting" in "Simple CPU Communication Setting" under "Application Settings".
 [Navigation window] ⇒ [Parameter] ⇒ [Module Information] ⇒ [RJ71EN71] ⇒ [Port 1 Module Parameter (Ethernet)] ⇒ [Application Settings] ⇒ [Simple CPU Communication Setting]
2. Double-click "<Detailed Setting>" of the "Simple CPU Communication Setting" to display the following window. ( Page 333 Simple CPU communication setting (RJ71EN71, RnENCPU (network part)))

Setting Item																							
Latency Time		Latency Time <input type="text" value="0"/> s (0s to 255s)																					
Setting No.	Communication Pattern	Communication Setting: Execution Interval(ms)	Communication Destination (IP Address)			Target PLC No.	Bit Device						Word Device						Communication Time-out Period(ms)	Communication Retry Count	Monitoring Time At Error(s)	Comment	
			Source	->	Destination		Points	Source		Destination		Source		Destination									
1				->																			
2				->																			
3				->																			
4				->																			
5				->																			
6				->																			
7				->																			
8				->																			
9				->																			
10				->																			

3. After setting the items, write the module parameters to the CPU module of the own station, and reset or power off and on the CPU module to start the simple CPU communication.

Point  When "On Request" is set to the communication setting, refer to the following.
 Page 210 Operations when the communication setting is "On Request"

Communication Pattern



Select the communication pattern from the following items.

Setting item	Description
Read	Read the data of the specified destination device (transmission source) to the specified device of the own station (transmission destination).
Write	Write the data of the specified device of the own station (transmission source) to the specified destination device (transmission destination).

Communication Setting: Execution Interval

Select the communication timing from the following items.

Setting item	Description	Setting range
Fixed Interval	—	Data are communicated between the devices at a specified execution interval.
	Execution Interval (ms)	Execution interval is set.
On Request	Data are communicated between the devices upon request only.	—

Point  Actual time of execution interval may be longer than the value of the setting because the time is affected by the specified communication destinations or Ethernet line congestion. For the preventive measures, refer to the following.
 Page 438 When the simple CPU communication function is used

- If latency time is set, data communication is started after the latency time has passed. ( Page 213 Latency Time)

Communication Destination (IP Address)

Click "Destination" to open the "Communication Destination Setting" window and specify the communication destination. Up to 64 communication destinations can be registered.

Point

In the engineering tool, up to 512 communication destinations can be set. Note that the settable number is different.

Devices having different settings in any of the items below are counted as different communication destination. (SIEMENS S7 series and SIEMENS S7 series (extension) are counted as same module type.)

- Module type
- IP address
- UDP/TCP
- Port No.
- Own station port number

Module type

Select the module type of the communication destination.

Module type	Communication destination	Communication specification
MELSEC iQ-R (Built-in Ethernet)	RnCPU, RnENCPU* ¹ , RnPCPU, RnSFCPU, RnPSFCPU	MELSOFT connection (protocol: UDP)
MELSEC-Q (Built-in Ethernet)	Built-in Ethernet port QCPU	
MELSEC-L (Built-in Ethernet)	Built-in Ethernet port LCPU	
MELSEC iQ-F (Built-in Ethernet)	MELSEC iQ-F series CPU module* ⁴	MELSOFT connection (protocol: TCP)
MELSEC iQ-L (Built-in Ethernet)	LnHCPU	MELSOFT connection (protocol: UDP)
MELSEC iQ-R (Ethernet Module)	RnENCPU* ² , RJ71EN71	
MELSEC-Q (Ethernet Module)	QJ71E71-100	
MELSEC-L (Ethernet Module)	LJ71E71-100	
MELSEC-A/AnS (Ethernet Module)	AJ71E71N3-T, AJ71QE71N3-T, A1SJ71E71N3-T, A1SJ71QE71N3-T	MC protocol (A-compatible 1E frame)
MELSEC-FX3 (Ethernet Block/Adapter)	FX3U-ENET-ADP, FX3U-ENET-L	
SLMP Corresponding Device (QnA Compatible 3E Frame)	<ul style="list-style-type: none"> • SLMP-compatible device (No serial number) • MC protocol 3E frame-compatible device 	SLMP (MC protocol QnA-compatible 3E frame) <ul style="list-style-type: none"> • Read (0401H) • Write (1401H)
OMRON (CS/CJ series)	Supported model for SYSMAC CS/CJ series	FINS
KEYENCE (KV series)	Supported model for KV series	SLMP (MC protocol QnA-compatible 3E frame)
Panasonic (FP2SH series)	Supported model for FP2 series	MEWTOCOL
Panasonic (FP7 series)	Supported model for FP7 series	MEWTOCOL7
YASKAWA MP3000 series	Supported model for MP3000 series	Extended MEMOBUS
YASKAWA MP2000 series	Supported model for MP2000 series	
Yokogawa FA-M3 series	Supported model for FA-M3 series	Personal computer link
MODBUS/TCP-compatible device	MODBUS/TCP slave device	MODBUS/TCP
SIEMENS S7 series* ³	Supported model for S7 series	S7 Communication
SIEMENS S7 series (extension)	Supported model for S7 series	S7 Communication
Fuji Electric MICREX-SX series	<ul style="list-style-type: none"> • Supported model for MICREX-SX (CPU module) series • Supported model for MICREX-SX (Ethernet module) series 	Loader command
JTEKT TOYOPUC series	<ul style="list-style-type: none"> • Supported model for TOYOPUC PC10 (CPU module) series • Supported model for TOYOPUC Plus (CPU module) series • Supported model for TOYOPUC Plus (Ethernet module) series 	Computer link

*1 When the RnENCPU is used for the connection to the Ethernet port of the CPU part

*2 When the RnENCPU is used for the connection to the Ethernet port of the network part

*3 This module type is provided because it can be used for the setting of Communication Destination (IP Address) in the engineering tool with the Ver.1.085P or earlier.

And thus, when newly setting this item, set SIEMENS S7 series (extension) as the module type.

*4 For the FX5U CPU module and FX5UC CPU module, the module with the firmware version of "1.110" or later can be used.

■IP address, UDP/TCP, port number

Set the IP address of the communication destination, communication protocol, port number, and own port number.

Module type	Setting range				
	IP address	UDP/TCP	Port No.	Own station port number	
MELSEC iQ-R (Built-in Ethernet)	0.0.0.1 to 223.255.255.254	UDP	Cannot be set.	1 to 4999, 5010 to 65534	
MELSEC-Q (Built-in Ethernet)		UDP			
MELSEC-L (Built-in Ethernet)		UDP			
MELSEC iQ-F (Built-in Ethernet)		TCP			
MELSEC iQ-L (Built-in Ethernet)		UDP			
MELSEC iQ-R (Ethernet Module)		UDP			
MELSEC-Q (Ethernet Module)		UDP			
MELSEC-L (Ethernet Module)		UDP			
MELSEC-A/AnS (Ethernet Module)		UDP, TCP			256 to 65534
MELSEC-FX3 (Ethernet Block/Adapter)		UDP, TCP			1025 to 5548, 5552 to 65534
SLMP Corresponding Device (QnA Compatible 3E Frame)	UDP, TCP	1 to 65534			
OMRON (CS/CJ series)	UDP				
KEYENCE (KV series)	UDP, TCP				
Panasonic (FP2SH series)	UDP, TCP				
Panasonic (FP7 series)	UDP, TCP				
YASKAWA MP3000 series	UDP, TCP				
YASKAWA MP2000 series	UDP, TCP				
Yokogawa FA-M3 series	UDP, TCP				
MODBUS/TCP-compatible device	TCP				
SIEMENS S7 series	TCP		102		
SIEMENS S7 series (extension)	TCP				
Fuji Electric MICREX-SX series	TCP	251 to 65531			
JTEKT TOYOPUC series	TCP	1025 to 65535			



- When a multiple CPU system is configured, specify the IP address of the CPU module to which the Ethernet cable is connected.
- Port numbers 1 to 1023 are typically reserved port numbers (WELL KNOWN PORT NUMBERS) and 61440 to 65534 are used by other communication functions, so it is recommended to use 1024 to 4999 or 5010 to 61439 for the own station port numbers.
- If the communication destination is Mitsubishi Electric programmable controllers (except MELSEC-A/AnS and MELSEC-FX3), the number between 61696 and 65534 is dynamically used for the own station port number. Consequently, do not specify the number between 61696 and 65534 for the own station port number in the OPEN instruction and the GP.CONOPEN instruction. Otherwise, the instruction may not be completed properly.
- When the same communication destination is specified in multiple settings, it is recommended to set a different value for each own station port number. If the number of the connections in the external device has exceeded the upper limit, reduce the number of connections by setting the own station port numbers to same values.

■Option (hexadecimal)

Set the option setting value of the communication destination.

Module type	Setting range
MELSEC iQ-R (Built-in Ethernet)	Cannot be set.
MELSEC-Q (Built-in Ethernet)	
MELSEC-L (Built-in Ethernet)	
MELSEC iQ-F (Built-in Ethernet)	
MELSEC iQ-L (Built-in Ethernet)	
MELSEC iQ-R (Ethernet Module)	
MELSEC-Q (Ethernet Module)	
MELSEC-L (Ethernet Module)	
MELSEC-A/AnS (Ethernet Module)	
MELSEC-FX3 (Ethernet Block/Adapter)	
SLMP Corresponding Device (QnA Compatible 3E Frame)	
OMRON (CS/CJ series)	
KEYENCE (KV series)	
Panasonic (FP2SH series)	
Panasonic (FP7 series)	
YASKAWA MP3000 series	
YASKAWA MP2000 series	
Yokogawa FA-M3 series	
MODBUS/TCP-compatible device	Set the setting value for the module ID of the MODBUS application header. ■When communicating with a MODBUS/TCP-compatible device 00H or FFH ■When communicating with a MODBUS RTU/ASCII-compatible device via a gateway device • 00H (broadcast) • 01H to F7H (station number of a MODBUS RTU/ASCII-compatible device)
SIEMENS S7 series	Cannot be set.
SIEMENS S7 series (extension)	
Fuji Electric MICREX-SX series	
JTEKT TOYOPUC series	

Precautions

The following are the precautions when 00H (broadcast) is set for communication with a MODBUS RTU/ASCII-compatible device via a gateway device.

- Since the slave station does not response, a timeout error (CFB0H) occurs. Do not specify the read.
- Do not specify both a bit device and a word device in one setting value. Specify only one of them.
- When setting multiple devices, set a different own station port number.

For the communication time-out period, communication retry count, and monitoring time at error, set as follows. When setting the following values, the second communication is executed after Communication Time-out Period, and the communication of a third or later is executed at the cycle of Communication Time-out Period × 2.

- Communication Retry Count = 0
- Communication Time-out Period = Monitoring Time At Error

Setting for communication destination

The settings differ depending on the communication destination.

Specify the protocol and own station port number for each setting to be the same as those set in the simple CPU communication settings.

Communication destination	Necessary setting
MELSEC iQ-R (Built-in Ethernet) ^{*1}	Since the MELSOFT connection is used for communications, no setting is required.
MELSEC-Q (Built-in Ethernet)	Set the following items (for the number of devices) in the "Open Setting" window. <ul style="list-style-type: none"> • Protocol: "UDP" • Open System: "MELSOFT Connection"
MELSEC-L (Built-in Ethernet)	
MELSEC iQ-F (Built-in Ethernet) ^{*2}	Since the MELSOFT connection is used for communications, no setting is required.
MELSEC iQ-L (Built-in Ethernet)	
MELSEC iQ-R (Ethernet Module) ^{*1}	
MELSEC-Q (Ethernet Module)	Set the network number and station number.
MELSEC-L (Ethernet Module)	
MELSEC-A/AnS (Ethernet Module)	<p>■Programming tool</p> <p>Create an initial processing program, and set the following items.</p> <ul style="list-style-type: none"> • IP address and port number • Communication method (UDP/TCP) • Bit 15 and Bits 0 to 7 of Area for communication instruction during stop (Un/G496) (Turn on the bits corresponding to the connection numbers to be used.)^{*3} <p>■DIP switch on the front of the module</p> <p>Set the following items.</p> <ul style="list-style-type: none"> • SW2 (data code setting): Off • SW7 (CPU communication timing setting): On^{*4}
MELSEC-FX3 (Ethernet Block/Adapter)	<p>Set "Communication Data Code" of "Ethernet Port" to "Binary Code".</p> <p>Set the following items (for the number of devices) in the "Open Setting" window.</p> <ul style="list-style-type: none"> • Protocol: "UDP or "TCP" • Open system: "MC protocol" • IP address, port number: Settings made for the own station (RJ71EN71 or RnENCPU)
SLMP Corresponding Device (QnA Compatible 3E Frame)	<p>Configure the settings so that the SLMP (QnA-compatible 3E frame of the MC protocol) can be used on the SLMP-compatible device side. (Manual for the device used)</p> <p>Set the communication data code to binary.</p>
OMRON (CS/CJ series)	Refer to the manual for the programmable controller of other manufacturer to be used.
KEYENCE (KV series)	
Panasonic (FP2SH series)	
Panasonic (FP7 series)	
YASKAWA MP3000 series	
YASKAWA MP2000 series	
Yokogawa FA-M3 series	
MODBUS/TCP-compatible device	Set the MODBUS/TCP as a slave station. (Manual for the device used)
SIEMENS S7 series	Refer to the manual for the programmable controller of other manufacturer to be used.
SIEMENS S7 series (extension)	
Fuji Electric MICREX-SX series	
JTEKT TOYOPUC series	

*1 Up to 64 devices can be connected to each port of the CPU module (built-in Ethernet port part) or the Ethernet module.



*2 Up to nine devices can be connected.

*3 Set this item to execute this function while the communication destination CPU module is in the STOP state or stop error state.

*4 Turn on this switch to execute this function while the communication destination CPU module is in the RUN state.

Target PLC No.

When the communication destination is one of the following modules and a multiple CPU system is used, specify the "Target PLC No." of the communication destination.

Communication destination	Target PLC No.
MELSEC iQ-R (built-in Ethernet): RnCPU, RnENCPU, RnPCPU, RnSFCPU	PLC No.1 to 4
MELSEC-Q (built-in Ethernet): QnUDE(H)CPU, QnUDVCPU, QnUDPVCPU ( QCPU User's Manual (Multiple CPU System))	PLC No.1 to 4
MELSEC iQ-R (Ethernet Module): RJ71EN71, RnENCPU	PLC No.1 to 4
MELSEC-Q (Ethernet): QJ71E71-100, QJ71E71 ( QCPU User's Manual (Multiple CPU System))	PLC No.1 to 4
Yokogawa FA-M3 series ^{*1}	PLC No.1 to 4
Fuji Electric MICREX-SX series	PLC No.1 to 8

*1 When the communication destination is Yokogawa FA-M3 series and "Not Specified" is set to "Target PLC No.", the CPU No.1 is automatically regarded as the target. (When the firmware version of the RJ71EN71 and the RnENCPU (network part) is "42" or later)

Devices that can be specified

The devices that can be specified as transmission source and transmission destination vary depending on the communication destination. Bit device and word device can be set together for each setting number.

For devices that can be specified, the size of a device is specified in units of 16 points for a bit device and one point for a word device. Use 0 or multiples of 16 to specify the device number of a bit device.

Point

- The maximum number of points per setting is 1024 words (bit device 8192 points maximum, word device 512 points maximum).
- Set the devices within the device range specified with the parameter of the CPU module.

■Devices that can be specified on the own station

The maximum number of points when the NZ2MC-16MBS is connected to the R120CPU. The number of points differs depending on the CPU module used, whether to use or not an extended SRAM cassette, or the type of the extended SRAM cassette.

Type	Applicable device		
	Symbol	Range	Remarks
Bit device	X	0H to 2FFFH	—
	Y	0H to 2FFFH	—
	M	0 to 161882111	A local device cannot be specified.
	L	0 to 32767	—
	F	0 to 32767	—
	B	0H to 9A61FFFH	—
	TS	0 to 8993439	This device can be specified only when "Write" is set to "Communication Pattern".
	TC	0 to 8993439	This device can be specified only when "Write" is set to "Communication Pattern".
	STS	0 to 8993439	This device can be specified only when "Write" is set to "Communication Pattern".
	STC	0 to 8993439	This device can be specified only when "Write" is set to "Communication Pattern".
	CS	0 to 8993439	This device can be specified only when "Write" is set to "Communication Pattern".
	CC	0 to 8993439	This device can be specified only when "Write" is set to "Communication Pattern".
	SB	0H to 9A61FFFH	—
	SM	0 to 4095	—
Word device	D	0 to 10117631	A local device cannot be specified.
	W	0H to 9A61FFFH	—
	TN	0 to 8993439	—
	STN	0 to 8993439	—
	CN	0 to 8993439	—
	SW	0H to 9A61FFFH	—
	SD	0 to 4095	—
	R	0 to 32767	Data is read or written following the file register settings of the communication destination.
	ZR	0 to 10027007	Data is read or written following the file register settings of the communication destination.
	RD	0 to 1048575	—
	G	PORT1: 722500 to 1246787 PORT2: 2722500 to 3246787	Buffer memory for the RJ71EN71 and RnENCPU (network part). A G device is expressed as Un\G. The search for the device requires the search string to be prefixed by Un\G. When the search for a G device is attempted while the RJ71EN71 and RnENCPU (network part) are not mounted, U0\G is prefixed for the search. (An error for unmounted module is not detected.)

■When the communication destination is the MELSEC iQ-R (built-in Ethernet) or MELSEC iQ-R (Ethernet module)

The maximum number of points when the NZ2MC-16MBS is connected to the R120CPU. The number of points differs depending on the CPU module used, whether to use or not an extended SRAM cassette, or the type of the extended SRAM cassette.

Type	Applicable device		
	Symbol	Range	Remarks
Bit device	X	0H to 2FFFH	—
	Y	0H to 2FFFH	—
	M	0 to 161882111	A local device cannot be specified.
	L	0 to 32767	—
	F	0 to 32767	—
	B	0H to 9A61FFFH	—
	TS	0 to 8993439	This device can be specified only when "Read" is set to "Communication Pattern".
	TC	0 to 8993439	This device can be specified only when "Read" is set to "Communication Pattern".
	STS	0 to 8993439	This device can be specified only when "Read" is set to "Communication Pattern".
	STC	0 to 8993439	This device can be specified only when "Read" is set to "Communication Pattern".
	CS	0 to 8993439	This device can be specified only when "Read" is set to "Communication Pattern".
	CC	0 to 8993439	This device can be specified only when "Read" is set to "Communication Pattern".
	SB	0H to 9A61FFFH	—
	SM	0 to 4095	—
Word device	D	0 to 10117631	A local device cannot be specified.
	W	0H to 9A61FFFH	—
	TN	0 to 8993439	—
	STN	0 to 8993439	—
	CN	0 to 8993439	—
	SW	0H to 9A61FFFH	—
	SD	0 to 4095	—
	R	0 to 32767	Data is read or written following the file register settings of the communication destination.
	ZR	0 to 10027007	Data is read or written following the file register settings of the communication destination.
	RD	0 to 1048575	—

■When the communication destination is the MELSEC-Q (built-in Ethernet) or MELSEC-Q (Ethernet module)

The maximum number of points when the Q4MCA-8MBS is connected to the Q26UDVCP. The number of points differs depending on the CPU module used, whether to use or not an extended SRAM cassette, or the type of the extended SRAM cassette.

Type	Applicable device		
	Symbol	Range	Remarks
Bit device	X	0H to 1FFFH	—
	Y	0H to 1FFFH	—
	M	0 to 61439	—
	L	0 to 32767	—
	F	0 to 32767	—
	B	0H to EFFFH	—
	TS	0 to 32767	This device can be specified only when "Read" is set to "Communication Pattern".
	TC	0 to 32767	This device can be specified only when "Read" is set to "Communication Pattern".
	STS	0 to 32767	This device can be specified only when "Read" is set to "Communication Pattern".
	STC	0 to 32767	This device can be specified only when "Read" is set to "Communication Pattern".
	CS	0 to 32767	This device can be specified only when "Read" is set to "Communication Pattern".
	CC	0 to 32767	This device can be specified only when "Read" is set to "Communication Pattern".
	SB	0H to 7FFFH	—
	SM	0 to 2047	—
Word device	D	0 to 4910079	The maximum number of points when D (extended data register) or W (extended link register) is set.
	W	0H to 4AEBFFH	The maximum number of points when D (extended data register) or W (extended link register) is set.
	TN	0 to 32767	—
	STN	0 to 32767	—
	CN	0 to 32767	—
	SW	0H to 7FFFH	—
	SD	0 to 2047	—
	R	0 to 32767	Data is read or written following the file register settings of the communication destination.
ZR	0 to 4849663	Data is read or written following the file register settings of the communication destination.	

■When the communication destination is the MELSEC-L (built-in Ethernet) or MELSEC-L (Ethernet module)

The following table lists the maximum number of points for the L26CPU. The number of points varies depending on the CPU module used.

Type	Applicable device		
	Symbol	Range	Remarks
Bit device	X	0H to 1FFFFH	—
	Y	0H to 1FFFFH	—
	M	0 to 61439	—
	L	0 to 32767	—
	F	0 to 32767	—
	B	0H to EFFFFH	—
	TS	0 to 25471	This device can be specified only when "Read" is set to "Communication Pattern".
	TC	0 to 25471	This device can be specified only when "Read" is set to "Communication Pattern".
	STS	0 to 25471	This device can be specified only when "Read" is set to "Communication Pattern".
	STC	0 to 25471	This device can be specified only when "Read" is set to "Communication Pattern".
	CS	0 to 25471	This device can be specified only when "Read" is set to "Communication Pattern".
	CC	0 to 25471	This device can be specified only when "Read" is set to "Communication Pattern".
	SB	0H to 7FFFFH	—
	SM	0 to 2047	—
Word device	D	0 to 421887	The maximum number of points when D (extended data register) or W (extended link register) is set.
	W	0H to 6FFFFH	The maximum number of points when D (extended data register) or W (extended link register) is set.
	TN	0 to 25471	—
	STN	0 to 25471	—
	CN	0 to 25471	—
	SW	0H to 6FFFFH	—
	SD	0 to 2047	—
	R	0 to 32767	Data is read or written following the file register settings of the communication destination.
ZR	0 to 393215	Data is read or written following the file register settings of the communication destination.	

■When the communication destination is the MELSEC iQ-F (built-in Ethernet)

Type	Applicable device		
	Symbol	Range	Remarks
Bit device	X	0 to 1777	Octal notation is used.
	Y	0 to 1777	Octal notation is used.
	M	0 to 32767	A local device cannot be specified.
	L	0 to 32767	—
	F	0 to 32767	—
	B	0H to 7FFFH	—
	TS	0 to 1023	This device can be specified only when "Read" is set to "Communication Pattern".
	TC	0 to 1023	This device can be specified only when "Read" is set to "Communication Pattern".
	STS	0 to 1023	This device can be specified only when "Read" is set to "Communication Pattern".
	STC	0 to 1023	This device can be specified only when "Read" is set to "Communication Pattern".
	CS	0 to 1023	This device can be specified only when "Read" is set to "Communication Pattern".
	CC	0 to 1023	This device can be specified only when "Read" is set to "Communication Pattern".
	SB	0H to 7FFFH	—
	SM	0 to 9999	—
Word device	D	0 to 7999	A local device cannot be specified.
	W	0H to 7FFFH	—
	TN	0 to 1023	—
	STN	0 to 1023	—
	CN	0 to 1023	—
	SW	0H to 7FFFH	—
	SD	0 to 11999	—
	R	0 to 32767	Data is read or written following the file register settings of the communication destination.

■When the communication destination is the MELSEC iQ-L (built-in Ethernet)

The maximum number of points when the L16HCPU is connected. The number of points varies depending on the CPU module used.

Type	Applicable device		
	Symbol	Range	Remarks
Bit device	X	0H to 2FFFH	—
	Y	0H to 2FFFH	—
	M	0 to 14065663	A local device cannot be specified.
	L	0 to 32767	—
	F	0 to 32767	—
	B	0H to D69FFFH	—
	TS	0 to 781407	This device can be specified only when "Read" is set to "Communication Pattern".
	TC	0 to 781407	This device can be specified only when "Read" is set to "Communication Pattern".
	STS	0 to 781407	This device can be specified only when "Read" is set to "Communication Pattern".
	STC	0 to 781407	This device can be specified only when "Read" is set to "Communication Pattern".
	CS	0 to 781407	This device can be specified only when "Read" is set to "Communication Pattern".
	CC	0 to 781407	This device can be specified only when "Read" is set to "Communication Pattern".
	SB	0H to D69FFFH	—
	SM	0 to 4095	—
Word device	D	0 to 879103	A local device cannot be specified.
	W	0H to D69FFFH	—
	TN	0 to 781407	—
	STN	0 to 781407	—
	CN	0 to 781407	—
	SW	0H to D69FFFH	—
	SD	0 to 4095	—
	R	0 to 32767	Data is read or written following the file register settings of the communication destination.
	ZR	0 to 819199	Data is read or written following the file register settings of the communication destination.
	RD	0 to 1048575	—

■When the communication destination is the MELSEC A/AnS (Ethernet module)

The maximum number of points for the A4UCPU. The number of points varies depending on the CPU module used. (📖 MELSEC Communication Protocol Reference Manual)

Type	Applicable device		
	Symbol	Range	Remarks
Bit device	X	0H to 7FFH	—
	Y	0H to 7FFH	—
	M	0 to 8191, 9000 to 9255	To specify 9000 to 9255 with "Communication Pattern" set to "Write", refer to the manual of the CPU module used. To specify 9000 to 9255, use 9000 + a multiple of 16.
	F	0 to 2047	—
	B	0H to FFFH	—
	TS	0 to 2047	—
	TC	0 to 2047	—
	CS	0 to 1023	—
	CC	0 to 1023	—
Word device	D	0 to 6143, 9000 to 9255	To specify 9000 to 9255 with "Communication Pattern" set to "Write", refer to the manual of the CPU module used.
	W	0H to FFFH	—
	TN	0 to 2047	—
	CN	0 to 1023	—
	R	0 to 8191	—
	Rn	10000 to 488191	Upper two digits are 1 to 48 (block No.), and lower four digits are 0 to 8191. The range of 8192 to 9999 must not be specified. The usable range varies depending on the CPU module used and parameter settings. (📖 User's manual of the CPU module used)

■When the communication destination is the MELSEC-FX3 (Ethernet block/adapter)

Type	Applicable device		
	Symbol	Range	Remarks
Bit device	X	0 to 377	Octal notation is used.
	Y	0 to 377	Octal notation is used.
	M	0 to 7679, 8000 to 8511	To specify 8000 to 8511 with "Communication Pattern" set to "Write", refer to the manual of the CPU module used.
	S	0 to 4095	The ranges where write is limited with an allowable number of times and the ranges where write is automatically limited are included. (📖 FX3S/FX3G/FX3GC/FX3U/FX3UC SERIES PROGRAMMING MANUAL - Basic & Applied Instructions Edition)
	TS	0 to 511	—
	CS	0 to 191	—
Word device	D	0 to 8511	<ul style="list-style-type: none"> To specify 8000 to 8511 with "Communication Pattern" set to "Write", refer to the manual of the CPU module used. The ranges where write is limited with an allowable number of times are included. (📖 FX3S/FX3G/FX3GC/FX3U/FX3UC SERIES PROGRAMMING MANUAL - Basic & Applied Instructions Edition)
	TN	0 to 511	The ranges where write is limited with an allowable number of times are included. (📖 FX3S/FX3G/FX3GC/FX3U/FX3UC SERIES PROGRAMMING MANUAL - Basic & Applied Instructions Edition)
	CN	0 to 199	The ranges where write is limited with an allowable number of times are included. (📖 FX3S/FX3G/FX3GC/FX3U/FX3UC SERIES PROGRAMMING MANUAL - Basic & Applied Instructions Edition)
	R	0 to 32767	—

■When the communication destination is an SLMP-compatible device (QnA-compatible 3E frame)

Applicable devices differ depending on the device. For applicable devices, refer to the manual for the device used.

The device types that can be set are X, Y, M, L, F, B, TS^{*1}, TC^{*1}, STS^{*1}, STC^{*1}, CS^{*1}, CC^{*1}, SB, SM, D, W, TN, STN, CN, SW, SD, R, and ZR. The accessible device range of the communication destination is the range which can be specified with the subcommand (0000) of the SLMP (QnA-compatible 3E frame of the MC protocol).

*1 This device can be specified only when "Read" is set to "Communication Pattern".

Point

The following SLMP commands are sent to the external device.

- When "Read" is set to "Communication Pattern"

Subheader	Request destination network No.	Request destination station No.	Request destination module I/O No.	Request destination multidrop station No.	Request data length	Monitoring timer	Command	Subcommand	Device code	Start device No.	Number of device points
50H 00H	00H	FFH	FFH 03H	00H	0CH 00H	00H 00H	01H 04H	00H 00H			

- When "Write" is set to "Communication Pattern"

Subheader	Request destination network No.	Request destination station No.	Request destination module I/O No.	Request destination multidrop station No.	Request data length	Monitoring timer	Command	Subcommand	Device code	Start device No.	Number of device points	Write data
50H 00H	00H	FFH	FFH 03H	00H		00H 00H	01H 14H	00H 00H				

■When the communication destination is OMRON (CS/CJ series)

Type	Applicable device		
	Symbol	Range	Remarks
Bit device (The device is displayed in units of words. One point corresponds to one word.)	..	0 to 6143	Channel I/O
	AR	0 to 447	The setting is available only when "Read" is set to "Communication Pattern".
	AR	448 to 959	—
	HR	0 to 511	—
	WR	0 to 511	—
Word device	DM	0 to 32767	—
	TIM	0 to 4095	—
	CNT	0 to 4095	—
	DR	0 to 15	—
	TK	0 to 31	The setting is available only when "Read" is set to "Communication Pattern".
	EM	0 to 32767	—
	EMn_	0 to 32767	"n" represents 0H to FH or 10H to 18H. (25 devices in total)

Point

- In the address table on the communication destination side, set the IP address and node address to be assigned to the RJ71EN71 or RnENCPU (network part). (Specify "1" for the node address.)
- When using the RJ71EN71 in a redundant system, set the control system IP address to the "Redundant System Settings" under "Application Settings" on the own station and the communication destination.

■When the communication destination is KEYENCE (KV series)

The format of devices other than B device consists of the last two digits of bit specification and the upper digits of word specification.

Type	Applicable device		
	Symbol	Range	Remarks
Bit device (The device is displayed in units of bits. One point corresponds to one bit.)	R	0 to 199915	Specify 00 in the last two digits for the start.
	B	0H to 7FFFH	Specify 0 or a multiple of 16 for the start.
	MR	0 to 399915	Specify 00 in the last two digits for the start.
	LR	0 to 99915	Specify 00 in the last two digits for the start.
	CR	0 to 7915	Specify 00 in the last two digits for the start.
	T	0 to 3999	—
	C	0 to 3999	—
Word device	CM	0 to 5999	—
	DM	0 to 65534	—
	EM	0 to 65534	—
	FM	0 to 32767	—
	ZF	0 to 524287	—
	W	0H to 7FFFH	—
	T	0 to 3999	—
	C	0 to 3999	—

■When the communication destination is Panasonic (FP2SH series)

Type	Applicable device		
	Symbol	Range	Remarks
Bit device (The device is displayed in units of words. One point corresponds to one word.)	WX	0 to 511	The setting is available only when "Read" is set to "Communication Pattern".
	WY	0 to 511	—
	WR	0 to 886	—
	WL	0 to 639	—
Word device	LD	0 to 8447	—
	DT	0 to 10239	—
	FL	0 to 32764	—



Setting item of communication destination: Set the MEWTOCOL station number. At this time, set 1 to the external device side (FP2) and 2 to the own station side.

■When the communication destination is Panasonic (FP7 series)

Type	Applicable device		
	Symbol	Range	Remarks
Bit device (The device is displayed in units of words. One point corresponds to one word.)	WX	0 to 511	—
	WY	0 to 511	—
	WR	0 to 2047	—
	WL	0 to 1023	—
	_WX	001000000 to 468000511	The upper three digits of the device number show the program block number, and the lower six digits show the device number.
	_WY	001000000 to 468000511	The upper three digits of the device number show the program block number, and the lower six digits show the device number.
	_WR	001000000 to 468002047	The upper three digits of the device number show the program block number, and the lower six digits show the device number.
	_WL	001000000 to 468001023	The upper three digits of the device number show the program block number, and the lower six digits show the device number.
Word device	LD	0 to 16383	—
	DT	0 to 999423	—
	_LD	001000000 to 468016383	The upper three digits of the device number show the program block number, and the lower six digits show the device number.
	_DT	001000000 to 468065534	The upper three digits of the device number show the program block number, and the lower six digits show the device number.

■When the communication destination is YASKAWA MP3000 series

Type	Applicable device		
	Symbol	Range	Remarks
Bit device (The device is displayed in units of words. One point corresponds to one word.)	IB	0H to 21FFFH	The setting is available only when "Read" is set to "Communication Pattern".
	OB	0H to 21FFFH	—
	MB	0 to 1048575	—
	GB	0 to 2097151	—
	SB	0 to 65534	—
Word device	IW	0H to 21FFFH	The setting is available only when "Read" is set to "Communication Pattern".
	OW	0H to 21FFFH	—
	MW	0 to 1048575	—
	GW	0 to 2097151	—
	SW	0 to 65534	—

■When the communication destination is YASKAWA MP2000 series

Type	Applicable device		
	Symbol	Range	Remarks
Bit device (The device is displayed in units of words. One point corresponds to one word.)	IB	0H to 7FFFH	The setting is available only when "Read" is set to "Communication Pattern".
	MB	0 to 65534	—
Word device	IW	0H to 7FFFH	The setting is available only when "Read" is set to "Communication Pattern".
	MW	0 to 65534	—

■When the communication destination is Yokogawa FA-M3 series

Type	Applicable device		
	Symbol	Range	Remarks
Bit device (The device is displayed in units of words. One point corresponds to one word.)	X	201 to 71664	The setting is available only when "Read" is set to "Communication Pattern". The setting range of the last two digits is 01 to 64. (Only 01, 17, 33, or 49 can be set as the start device. Only 16, 32, 48, or 64 can be set as the end device.)
	Y	201 to 71664	The setting range of the last two digits is 01 to 64. (Only 01, 17, 33, or 49 can be set as the start device. Only 16, 32, 48, or 64 can be set as the end device.)
	I	1 to 165535	Use 1 or a multiple of 16 +1 to set the start device.
	E	1 to 4096	
	L	1 to 78192	
	M	1 to 9984	
Word device	D	1 to 65535	—
	R	1 to 4096	—
	V	1 to 256	—
	B	1 to 262144	—
	W	1 to 78192	—
	Z	1 to 1024	—
	TP	1 to 3072	—
	CP	1 to 3072	—
	TS	1 to 3072	—
	CS	1 to 3072	—
	TI	1 to 3072	—
	CI	1 to 3072	—

■When the communication destination is a MODBUS/TCP-compatible device

Applicable devices and the number of writable/readable points differ depending on the device. For applicable devices and the number of writable/readable points, refer to the manual for the device used.

The device types that can be set are Coil, Input, Input Register, and Holding Register.

Type	Applicable device		
	Maximum number of write points	Maximum number of read points	Remarks
Coil	1968	2000	—
Input	—	2000	Setting is possible only when the "Communication Pattern" is "Read".
Input Register	—	125	Setting is possible only when the "Communication Pattern" is "Read".
Holding Register	123	125	—



Specify the value obtained by subtracting 1 from the MODBUS device number.

■When the communication destination is SIEMENS S7 series

Type	Applicable device		
	Symbol	Range	Remarks
Bit device (The device is displayed in units of words. One point corresponds to 8 points.)	I	0 to 255	Start digit: An even number must be specified. Last digit: An odd number must be specified.
	Q	0 to 255	
	M	0 to 255	
Word device	DB	001000 to 255511	Upper 3 digits: Block No., Lower 3 digits: Address range An even number must be specified to the start of the lower 3 digits and an odd number must be specified to the last of the lower 3 digits. (The size for 1 point is 1 byte. Two points are required to set for word device.)



Access is executed in units of words. The upper byte and lower byte of reading/writing value may be interchanged depending on the setting in the communication destination.

■When the communication destination is SIEMENS S7 series (extension)

The accessible devices of SIEMENS S7 series (extension) are the same as those of SIEMENS S7 series. Moreover, the accessible ranges of the devices are widened when the communication destination is SIEMENS S7 series (extension).

Type	Applicable device		
	Symbol	Range	Remarks
Bit device (The device is displayed in units of words. One point corresponds to 8 points.)	I	0 to 65535	Start digit: An even number must be specified. Last digit: An odd number must be specified.
	Q	0 to 65535	
	M	0 to 65535	
Word device	DB	1.0 to 65535.65535	Specify the range in the following format: <block No.>.<address range>. (Separate block No. from address range by placing a dot (.) between them.) For the start of address range, specify an even number. For the last of address range, specify an odd number. (Because the size for 1 point is 1 byte, two points must be set for word device.) Match the first and last block numbers.

■Fuji Electric MICREX-SX series

Type	Applicable device		
	Symbol	Range	Remarks
Bit device (The device is displayed in units of words. One point corresponds to 16 points.)	MX1	0000000 to 1703935	—
	MX3	000000 to 262143	—
	MX10	0000 to 1023	—
Word device	MW1	0000000 to 1703935	—
	MW3	000000 to 262143	—
	MW10	0000 to 1023	—

■JTEKT TOYOPUC series

Type	Applicable device		
	Symbol	Range	Remarks
Bit device (The device is displayed in units of words. One point corresponds to 16 points.)	X	10000H to 3007FH	Upper 1 digit: Program No., Lower 4 digits: Address range The following lists the communicable address range of lower 4 digits. • M (internal relay): 0000 to 007FH, 0100 to 017FH • L (link relay): 0000 to 007FH, 0100 to 02FFH • V (special relay): 0000 to 000FH, 0100 to 017FH
	Y	10000H to 3007FH	
	M	10000H to 3017FH	
	K	10000H to 3002FH	
	L	10000H to 302FFH	
	V	10000H to 3017FH	
	EX	00000H to 0007FH	—
	EY	00000H to 0007FH	—
	EM	00000H to 001FFH	—
	EK	00000H to 000FFH	—
	EL	00000H to 001FFH	—
	EV	00000H to 000FFH	—
	GX	00000H to 00FFFH	—
	GY	00000H to 00FFFH	—
GM	00000H to 00FFFH	—	
Word device	D	10000H to 32FFFH	Upper 1 digit: Program No., Lower 4 digits: Address range The following lists the communicable address range of lower 4 digits. • S (special register): 0000 to 03FFFH, 1000 to 13FFFH • N (present value register): 0000 to 01FFFH, 1000 to 17FFFH
	R	10000H to 307FFH	
	S	10000H to 313FFH	
	N	10000H to 317FFH	
	U	10000H to 1FFFFH	—
	ES	00000H to 007FFH	—
	EN	00000H to 007FFH	—
	H	00000H to 007FFH	—
	EB	00000H to 3FFFFH	—
FR	00000H to 1FFFFH	—	

Operation during the simple CPU communication

■Operation of the own station

Since the own station operates without depending on the operating status of the CPU module, the simple CPU communication is performed even when the CPU module is in the STOP state because of stop error. When an initial communication error occurs, communications of the corresponding setting numbers are stopped and ones of the setting numbers, where no error occurs will operate.

If the communication destination sends a response, data is transferred to the system area for the simple CPU communication. Data inconsistency will not occur in one setting since processing is executed for each setting.

■Operation of the communication destination

The operation differs depending on the communication destination.

Communication destination	Data operation in one setting
MELSEC iQ-R (Built-in Ethernet)	The data specified with a bit device or a word device in one setting is communicated at the same timing. However, if both a bit device and a word device are set for the same setting number, the data of each device may be communicated at different timing. For the following cases, the data is received at different timing. <ul style="list-style-type: none"> • The total of bit device points and word device points exceeds 960 words. • TS, TC, STS, STC, CS, or CC is specified as a bit device.
MELSEC-Q (Built-in Ethernet)	
MELSEC-L (Built-in Ethernet)	
MELSEC iQ-F (Built-in Ethernet)	The data specified with a bit device or a word device in one setting is communicated at the same timing. However, if both a bit device and a word device are set for the same setting number, the data of each device may be communicated at different timing.
MELSEC iQ-L (Built-in Ethernet)	The data specified with a bit device or a word device in one setting is communicated at the same timing. However, if both a bit device and a word device are set for the same setting number, the data of each device may be communicated at different timing. For the following cases, the data is received at different timing. <ul style="list-style-type: none"> • The total of bit device points and word device points exceeds 960 words. • TS, TC, STS, STC, CS, or CC is specified as a bit device.
MELSEC iQ-R (Ethernet Module)	
MELSEC-Q (Ethernet Module)	The data specified with a bit device or a word device in one setting is communicated at the same timing. However, if both a bit device and a word device are set for the same setting number, the data of each device may be communicated at different timing.
MELSEC-L (Ethernet Module)	
MELSEC-A/AnS (Ethernet Module)	When the data size in one setting is as follows, data inconsistency will not occur. <ul style="list-style-type: none"> • Read: Bit device 2048 points or less, word device 256 points or less • Write: Bit device 640 points or less, word device 256 points or less
MELSEC-FX3 (Ethernet Block/Adapter)	When the data size in one setting is as follows, data inconsistency will not occur. <ul style="list-style-type: none"> • Read: Bit device 512 points or less, word device 64 points or less • Write: Bit device 160 points or less, word device 64 points or less
SLMP Corresponding Device (QnA Compatible 3E Frame)	Depends on the communication destination.
OMRON (CS/CJ series)	
KEYENCE (KV series)	
Panasonic (FP2SH series)	
Panasonic (FP7 series)	
YASKAWA MP3000 series	
YASKAWA MP2000 series	
Yokogawa FA-M3 series	
MODBUS/TCP-compatible device	
SIEMENS S7 series	
SIEMENS S7 series (extension)	
Fuji Electric MICREX-SX series	
JTEKT TOYOPUC series	

Operations when the communication setting is "On Request"

■How to start communications

Power off and on the system or reset the CPU module first. Turn off and on the buffer memory area of Request to start communication at request, and communications start.

Point

Once the CPU module is reset, the system starts the preparation processing. The preparation processing checks the parameter settings (own station port numbers). If an error occurs, data will not be communicated. In this case, the buffer memory area of Simple CPU communication status stores AH (Communications impossible).

■Each status after communications start

The following table lists the buffer memory areas that stores each status of communications from its start to completion.

Status	Item	Address	Buffer memory status
During the latency time ^{*1}	Simple CPU communication status for each setting number	Un\G721936 to Un\G721999 Un\G1247460 to Un\G1247907	1H: Preparing
After a lapse of the latency time	Preparation completion for each setting number	Un\G721912 to Un\G721915 Un\G1247412 to Un\G1247439	On: Ready
	Simple CPU communication status for each setting number	Un\G721936 to Un\G721999 Un\G1247460 to Un\G1247907	2H: Waiting for the request
Request to start communication at request issued	Simple CPU communication status for each setting number	Un\G721936 to Un\G721999 Un\G1247460 to Un\G1247907	3H: Communicating
	Execution status flag for each setting number	Un\G721908 to Un\G721911 Un\G1247384 to Un\G1247411	On: Communicating
Data communication completed ^{*2}	Execution status flag for each setting number	Un\G721908 to Un\G721911 Un\G1247384 to Un\G1247411	Off: Communication stop

*1 During the latency time, another start request (turning off and on the buffer memory area of Request to start communication at request) is ignored.

*2 After the data communications has been completed, 2H (Waiting for the request) is stored in the buffer memory area of Simple CPU communication status by turning on and off the buffer memory area of Request to start communication at request, and one session completes.

Point

Once a start request of On Request communications is detected, another start request (turning off and on the buffer memory area of Request to start communication at request) from a program is ignored until the buffer memory area of Execution status flag turns off (Communication stop). (This symptom is not treated as an error.)

■Behavior on errors

After data is sent to the communication destination, if no response is received from the communication destination or an error occurs (or an error response is received), the system makes retries until the timeout time.

During retries, the buffer memory area of Simple CPU communication status stores 5H (Retry being executed).

The system retries the operation for the number of times specified in the parameter plus one additional time.

■Behavior when an abnormal state is detected

If an error response is received after the retries, an abnormal state is detected and the buffer memory area of Simple CPU communication error code stores error codes.

In an abnormal state, the buffer memory area of Execution status flag turns off (Communication stop). By programmatically turning on and off the buffer memory area of Request to start communication at request, 2H (Waiting for the request) is stored in the buffer memory area of Simple CPU communication status.

-
- While the communications of one setting number is in an abnormal state, the value in the buffer memory areas of Simple CPU communication status for other setting numbers, in which the same communication destination is set, remains unchanged (2H (Waiting for the request)).
 - If no response is received from the communication destination, the buffer memory area of Simple CPU communication error code stores error codes.
 - If an error response is received from the communication destination, the buffer memory area of Simple CPU communication error code stores error codes and the buffer memory area of Abnormal response code stores abnormal response codes. (The abnormal response code here indicates any codes received from the destination device.)
-

■ Timing chart

• Operation of on-request communications of setting No.65 (Normal)

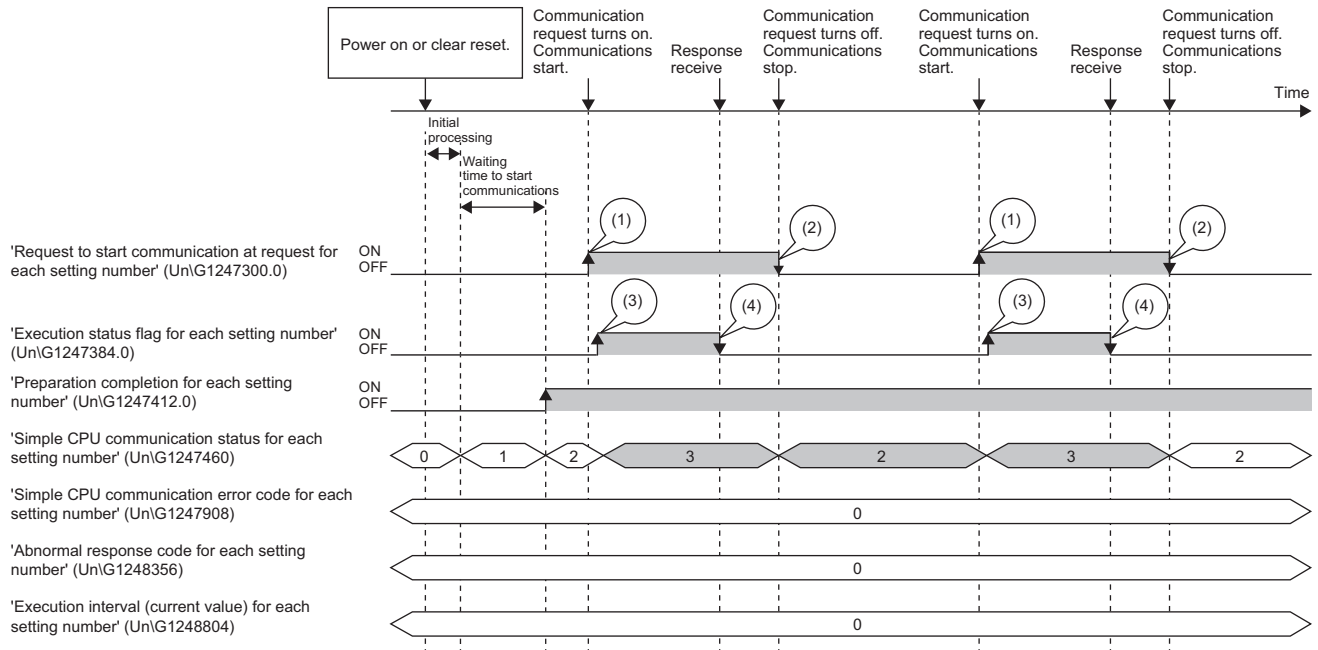

- (1) The buffer memory area is turned on by the program.
- (2) The buffer memory area is turned off by the program.
- (3) The buffer memory area is turned on by the system.
- (4) The buffer memory area is turned off by the system.

• Operation of on-request communications of setting No.65 (Abnormal state)

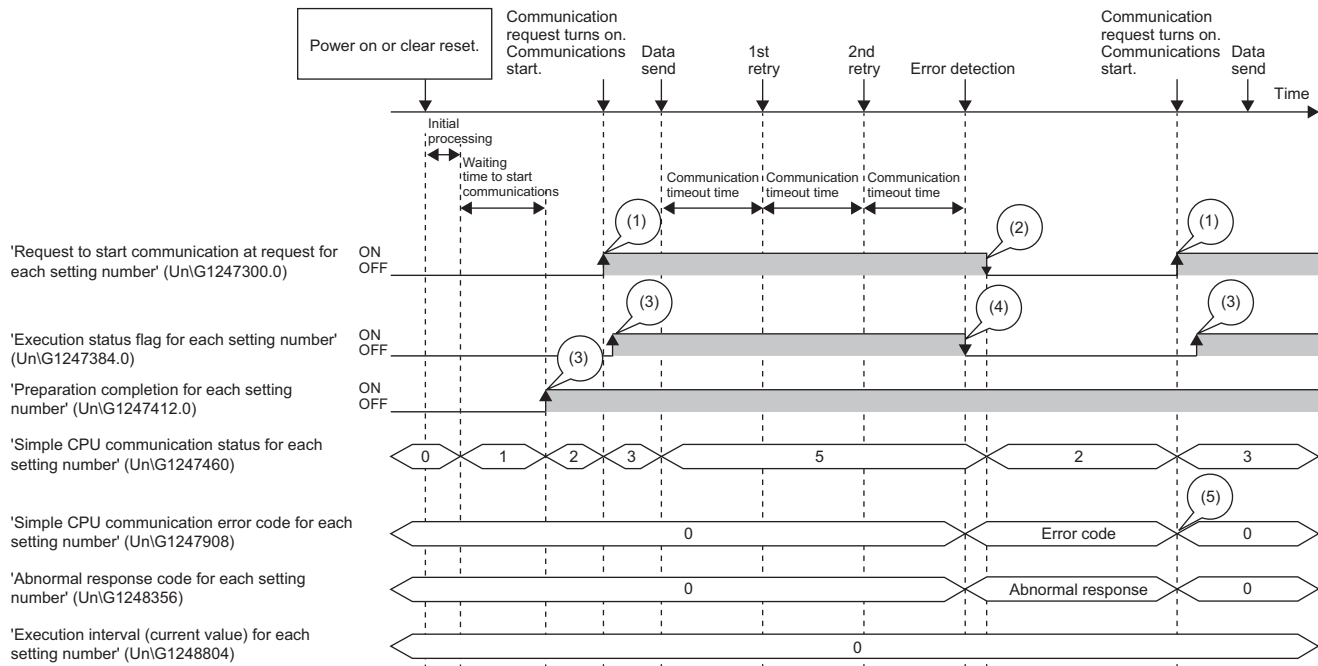

- (1) The buffer memory area is turned on by the program.
- (2) The buffer memory area is turned off by the program.
- (3) The buffer memory area is turned on by the system.
- (4) The buffer memory area is turned off by the system.
- (5) The value is cleared to 0 with a clear request from the engineering tool.

Communication Time-out Period/Communication Retry Count/Monitoring Time At Error

When the communication destination does not respond or returns an error response, the communication will be retried (resent) after the time-out period has passed.

At this time, after communications are performed for the communication retry count + 1 times, the fixed interval communication is performed during the monitoring time at error. If the communication destination responds after these communications, the communications at the execution interval specified with the parameters are restarted.

Ex.

Error detection timing when 2 is set for the communication retry count

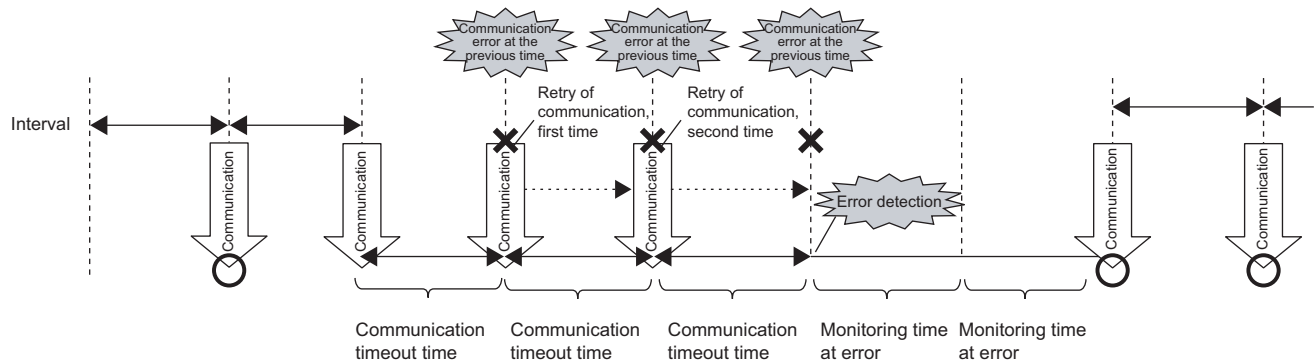

Point

The error is detected if the communication destination does not respond or communications fail by when the following time has passed: $(\text{communication retry count} + 1) \times \text{communication time-out period}$

Latency Time

By setting the latency time, the start timing in the communications can be switched in the following cases.

- To prevent an error due to the overlap of the start timing in the communications
- To start communications after the communication destination is ready for the communications

During the latency time, "Preparing" is indicated in the communication status.

Point

Communications at a specified execution interval (when "Fixed Interval" is set for the communication setting) is ignored during the latency time.

Checking the simple CPU communication status

The simple CPU communication status can be checked with the buffer memory or diagnostic functions.

Checking with the buffer memory

The simple CPU communication status can be checked with the storage status of the corresponding setting number in the following buffer memory areas.

Item	Address	Remarks									
Request to start communication at request	Un\G721896 to Un\G721899 Un\G1247300 to Un\G1247327	<ul style="list-style-type: none"> • Setting No.1: Un\G721896.0 ⋮ • Setting No.64: Un\G721899.F • Setting No.65: Un\G1247300.0 ⋮ • Setting No.512: Un\G1247327.F 									
Request to stop fixed interval communication	Un\G721900 to Un\G721903 Un\G1247328 to Un\G1247355	<ul style="list-style-type: none"> • Setting No.1: Un\G721900.0 ⋮ • Setting No.64: Un\G721903.F • Setting No.65: Un\G1247328.0 ⋮ • Setting No.512: Un\G1247355.F 									
Request to restart fixed interval communication	Un\G721904 to Un\G721907 Un\G1247356 to Un\G1247383	<ul style="list-style-type: none"> • Setting No.1: Un\G721904.0 ⋮ • Setting No.64: Un\G721907.F • Setting No.65: Un\G1247356.0 ⋮ • Setting No.512: Un\G1247383.F 									
Execution status flag	Un\G721908 to Un\G721911 Un\G1247384 to Un\G1247411	<ul style="list-style-type: none"> • Setting No.1: Un\G721908.0 ⋮ • Setting No.64: Un\G721911.F • Setting No.65: Un\G1247384.0 ⋮ • Setting No.512: Un\G1247411.F 									
Ready	Un\G721912 to Un\G721915 Un\G1247412 to Un\G1247439	<ul style="list-style-type: none"> • Setting No.1: Un\G721912.0 ⋮ • Setting No.64: Un\G721915.F • Setting No.65: Un\G1247412.0 ⋮ • Setting No.512: Un\G1247439.F 									
Simple CPU communication status	<table border="1" style="width: 100%; border-collapse: collapse;"> <tr> <td style="width: 20%;">0H: Unset</td> <td rowspan="8">Un\G721936 to Un\G721999 Un\G1247460 to Un\G1247907</td> </tr> <tr> <td>1H: Preparing</td> </tr> <tr> <td>2H: Waiting for the request</td> </tr> <tr> <td>3H: Communicating</td> </tr> <tr> <td>4H: Communication stop</td> </tr> <tr> <td>5H: Retry being executed</td> </tr> <tr> <td>6H: Monitoring at error</td> </tr> <tr> <td>AH: Communications impossible</td> </tr> </table>	0H: Unset	Un\G721936 to Un\G721999 Un\G1247460 to Un\G1247907	1H: Preparing	2H: Waiting for the request	3H: Communicating	4H: Communication stop	5H: Retry being executed	6H: Monitoring at error	AH: Communications impossible	<ul style="list-style-type: none"> • Setting No.1: Un\G721936 ⋮ • Setting No.64: Un\G721999 • Setting No.65: Un\G1247460 ⋮ • Setting No.512: Un\G1247907
0H: Unset	Un\G721936 to Un\G721999 Un\G1247460 to Un\G1247907										
1H: Preparing											
2H: Waiting for the request											
3H: Communicating											
4H: Communication stop											
5H: Retry being executed											
6H: Monitoring at error											
AH: Communications impossible											
Simple CPU communication error code	Un\G722000 to Un\G722063 Un\G1247908 to Un\G1248355	<ul style="list-style-type: none"> • Setting No.1: Un\G722000 ⋮ • Setting No.64: Un\G722063 • Setting No.65: Un\G1247908 ⋮ • Setting No.512: Un\G1248355 									
Abnormal response code	Un\G722064 to Un\G722127 Un\G1248356 to Un\G1248803	<ul style="list-style-type: none"> • Setting No.1: Un\G722064 ⋮ • Setting No.64: Un\G722127 • Setting No.65: Un\G1248356 ⋮ • Setting No.512: Un\G1248803 									

Item	Address	Remarks
Execution interval (current value)	Un\G722128 to Un\G722191 Un\G1248804 to Un\G1249251	<ul style="list-style-type: none"> • Setting No.1: Un\G722128 ⋮ • Setting No.64: Un\G722191 • Setting No.65: Un\G1248804 ⋮ • Setting No.512: Un\G1249251

For details on the values to be stored in the buffer memory, refer to the following.

 Page 503 Simple CPU communication area

■Communication stop/restart request

When 'Simple CPU communication status for each setting number' (Un\G721936 to Un\G721999, Un\G1247460 to Un\G1247907) stores any of the following values, communications can be stopped by turning off and on 'Request to stop fixed interval communication for each setting number' (Un\G721900 to Un\G721903, Un\G1247328 to Un\G1247355). (If the value is other than the following, the stop request is invalid.)

- 3H: Communicating
- 5H: Retry being executed
- 6H: Monitoring

Point

When 'Request to stop fixed interval communication for each setting number' (Un\G721900 to Un\G721903, Un\G1247328 to Un\G1247355) is turned off and on, the communications will stop at the timing of sending data in the next execution interval.

Therefore, if the communication destination does not respond with the stop request accepted, the communications will stop after the communication time-out period has passed. When the retry is being executed, the communications will stop after the communication time-out period has passed without depending on the retry count.

When 'Simple CPU communication status for each setting number' (Un\G721936 to Un\G721999, Un\G1247460 to Un\G1247907) is in the "4H: Communication stop" state, communications can be restarted by turning off and on 'Request to restart fixed interval communication for each setting number' (Un\G721904 to Un\G721907, Un\G1247356 to Un\G1247383). (If the status is other than "4H: Communication stop", the restart request is invalid.)

When the communication setting is "On Request" or no setting is configured, no operation is performed by turning off and on 'Request to restart fixed interval communication for each setting number' (Un\G721904 to Un\G721907, Un\G1247356 to Un\G1247383) and 'Request to stop fixed interval communication for each setting number' (Un\G721900 to Un\G721903, Un\G1247328 to Un\G1247355). Therefore, the buffer memory areas will remain on without being turned on and off by the system.

Ex.

The operation at communication stop/restart request for the setting No.1

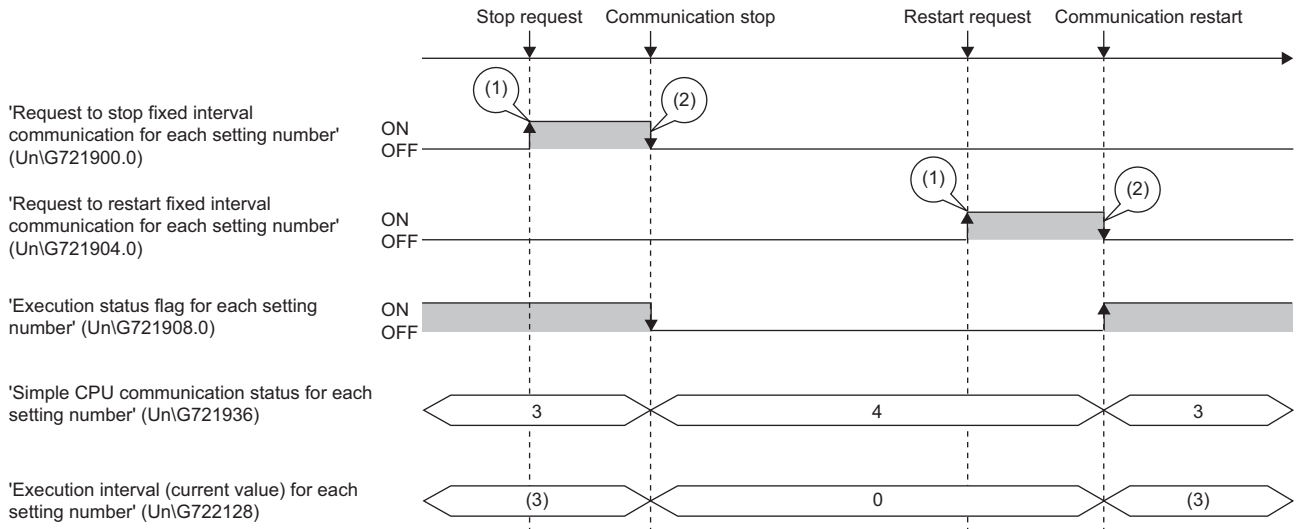

- (1) The buffer memory area is turned on by the program.
- (2) The buffer memory area is turned off by the system.
- (3) The current value is stored.

Checking with "simple CPU communication diagnostics"

The communication status of the simple CPU communication function can be checked with "Simple CPU Communication Diagnostics".

For details, refer to the following.

📖 Page 425 Simple CPU communication diagnostics

Communication example

In this example, B0 to B1FFF of own station are transferred to M0 to M8191 of the communication destination using the simple CPU communication function. Also, W0 to W1FF of own station are transferred to D0 to D511 of the communication destination.

System configuration

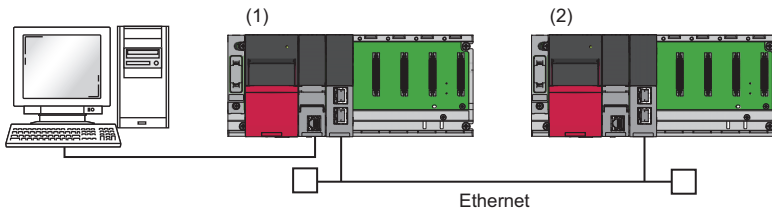

(1) Own station (transfer source): RJ71EN71 (IP address: 192.168.3.40)

(2) Communication destination (transfer destination): RJ71EN71 (IP address: 192.168.3.50)

Device assignment

The following figure shows the assignment of devices that communicates data in the simple CPU communication.

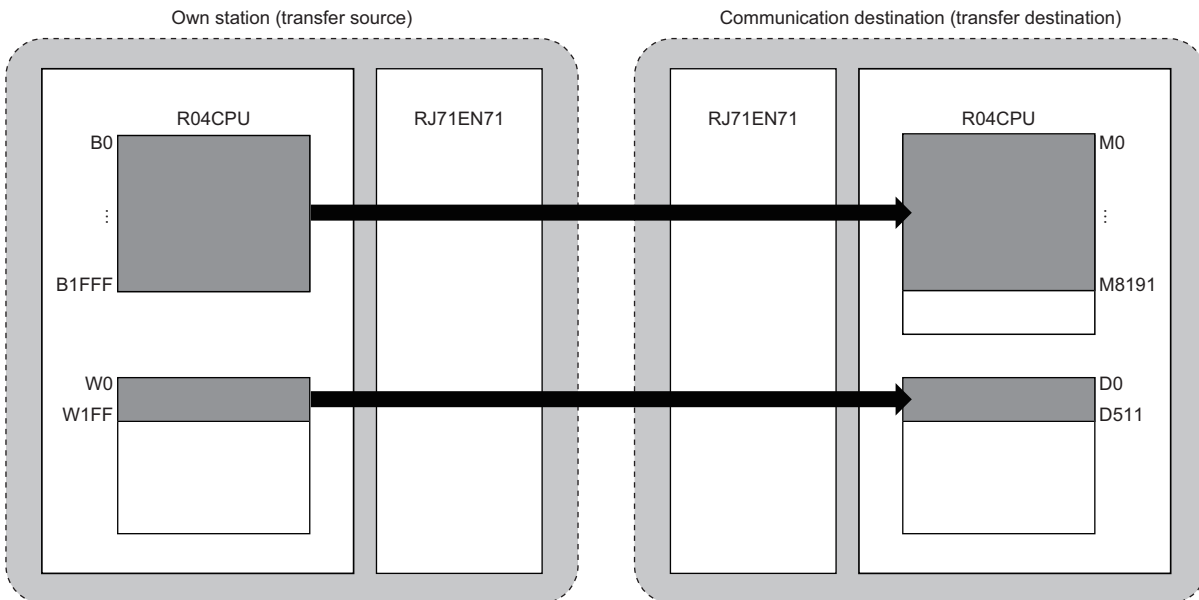

Parameter settings

Connect the engineering tool to the CPU module and set the parameters.

■ Settings for the transfer source

1. Set the CPU module as follows.

[Project] ⇒ [New]

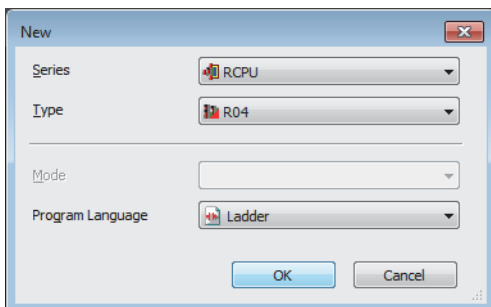

2. Click the [Setting Change] button and set to use module labels.
3. Click the [OK] button to add the module labels of the CPU module.

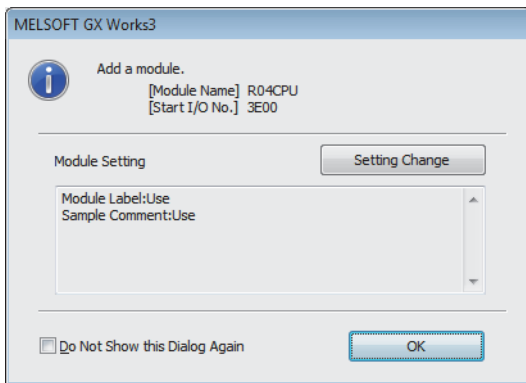

4. Set the RJ71EN71 as follows.

Navigation window ⇒ [Parameter] ⇒ [Module Information] ⇒ Right-click ⇒ [Add New Module]

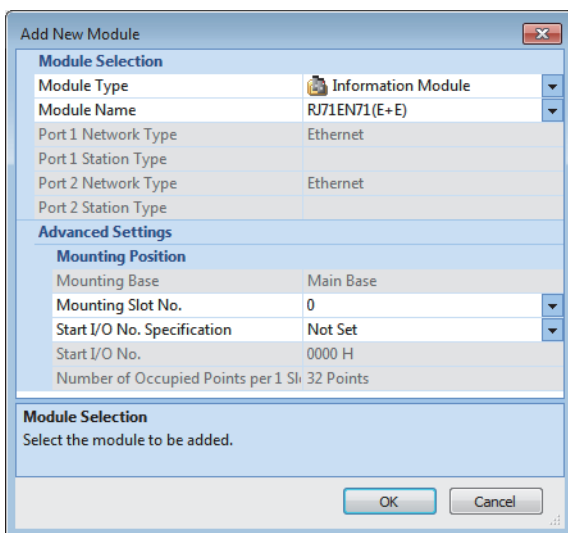

5. Click the [OK] button to add the module labels of the RJ71EN71.

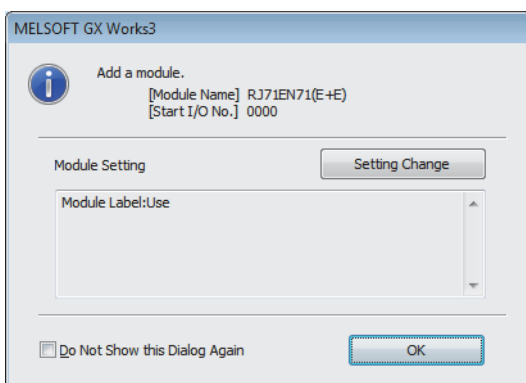

6. Set the items in "Basic Settings" as follows.

[Navigation window] ⇒ [Parameter] ⇒ [Module Information] ⇒ [RJ71EN71(E+E)] ⇒ [Port 1 Module Parameter (Ethernet)] ⇒ [Basic Settings] ⇒ [Own Node Settings]

Item	Setting
Own Node Settings	
Parameter Setting Method	Parameter Editor
IP Address	192 . 168 . 3 . 40
Subnet Mask	. . .
Default Gateway	. . .
Communications by Network No./Station No.	Disable
Setting Method	Use IP Address
Network No.	-----
Station No.	-----
Transient Transmission Group No.	0
Enable/Disable Online Change	Disable All (SLMP)
Communication Data Code	Binary
Opening Method	Do Not Open by Program
External Device Configuration	
External Device Configuration	<Detailed Setting>

7. Set the items in "Application Settings" as follows.

[Navigation window] ⇒ [Parameter] ⇒ [Module Information] ⇒ [RJ71EN71(E+E)] ⇒ [Port 1 Module Parameter (Ethernet)] ⇒ [Application Settings] ⇒ [Simple CPU Communication Setting]

Item	Setting
Simple CPU Communication Setting	
To Use or Not to Use Simple CPU Communication	Use
CPU Response Monitoring Timer	5
Unit	s
Simple CPU Communication Setting	<Detailed Setting>
Simple Device Communication Setting	
To Use or Not to Use Simple Device Communication	Not to Use
Resource Setting	Normal
Instruction Initial Value to Start/Stop Function	Start
CPU Response Monitoring Timer	5
Unit	s
Communication Destination Setting	<Detailed Setting>
Device List	<Confirmation>

8. Set the items in "Simple CPU Communication Setting" as follows.

[Navigation window] ⇒ [Parameter] ⇒ [Module Information] ⇒ [RJ71EN71(E+E)] ⇒ [Port 1 Module Parameter (Ethernet)] ⇒ [Application Settings] ⇒ [Simple CPU Communication Setting] ⇒ [Detailed Setting]

Setting No.	Communication Pattern	Communication Setting: Execution Interval(ms)	Communication Destination (IP Address)			Target PLC No.
			Source	->	Destination	
1	Write	On Request	Host Station(192 . 168 . 3 . 40)	->	MELSEC iQ-R(Ether)(192 . 168 . 3 . 50)	Not Specified
2				->		
3				->		

Bit Device						Word Device						Communication Time-out Period(ms)	Communication Retry Count	Monitoring Time At Error(s)	Comment	
Points	Type	Start	End	->	Destination	Points	Type	Start	End	->	Destination					
8192	B	00000	01FFF	->	M 0	8191	512	W	00000	001FF	->	D 0	511	1000	3	
				->							->					
				->							->					

9. Write the set parameters to the CPU module. Then reset the CPU module or power off and on the system.

[Online] ⇒ [Write to PLC]

Point

In this example, default values were used for parameters that are not shown above. For the parameter setting, refer to the chapter explaining the parameters in this manual. (Page 317 PARAMETER SETTINGS)

■ Settings for the transfer destination

1. Set the CPU module and the RJ71EN71. Steps to take are similar to those for the transfer source, except no setting for module labels is required. (☞ Page 217 Settings for the transfer source)
2. Set the items in "Basic Settings" as follows.

☞ [Navigation window] ⇒ [Parameter] ⇒ [Module Information] ⇒ [RJ71EN71(E+E)] ⇒ [Port 1 Module Parameter (Ethernet)] ⇒ [Basic Settings] ⇒ [Own Node Settings]

Setting Item	Item	Setting
	Own Node Settings	
	Parameter Setting Method	Parameter Editor
	IP Address	
	IP Address	192 . 168 . 3 . 50
	Subnet Mask
	Default Gateway
	Communications by Network No./Station No.	Disable
	Setting Method	Use IP Address
	Network No.	-----
	Station No.	-----
	Transient Transmission Group No.	0
	Enable/Disable Online Change	Disable All (SLMP)
	Communication Data Code	Binary
	Opening Method	Do Not Open by Program
	External Device Configuration	
	External Device Configuration	<Detailed Setting>

3. Write the set parameters to the CPU module. Then reset the CPU module or power off and on the system.

☞ [Online] ⇒ [Write to PLC]

Point

In this example, default values were used for parameters that are not shown above. For the parameter setting, refer to the chapter explaining the parameters in this manual. (☞ Page 317 PARAMETER SETTINGS)

Program examples

Write the following program to the transfer source CPU module.

In this example, ABCDH is stored in a bit device and 5555H is stored in a word device, and transfer them.

Classification	Label name	Description	Device
Module label	EN71_EE_1.stPort1.bnSts_Start_Request_D[1]	Request to start communication at request of Simple CPU communication setting No.1	Un\G721896.0
	EN71_EE_1.stPort1.bnSts_Status_Flag_D[1]	Execution flag of Simple CPU communication setting No.1	Un\G721908.0
	EN71_EE_1.stPort1.bnReady_D[1]	Preparation completion flag of Simple CPU communication setting No.1	Un\G721912.0
	EN71_EE_1.stPort1.wnStatus_SimplePLC_D[1]	Communication status storage location of Simple CPU communication setting No.1	Un\G721936
	EN71_EE_1.stPort1.wnErrorCode_SimplePLC_D[1]	Error code storage location of Simple CPU communication setting No.1	Un\G722000

Label Name	Data Type	Class	Assign (Device/Label)
bStartRequest	Bit	VAR_GLOBAL	M0
bSendData	Word [Signed]	VAR_GLOBAL	K4B0
wSendData	Word [Signed]	VAR_GLOBAL	W0
cSuccessCount	Counter	VAR_GLOBAL	C0
uErrorCode	Word [Unsigned]/Bit String [16-bit]	VAR_GLOBAL	D1000

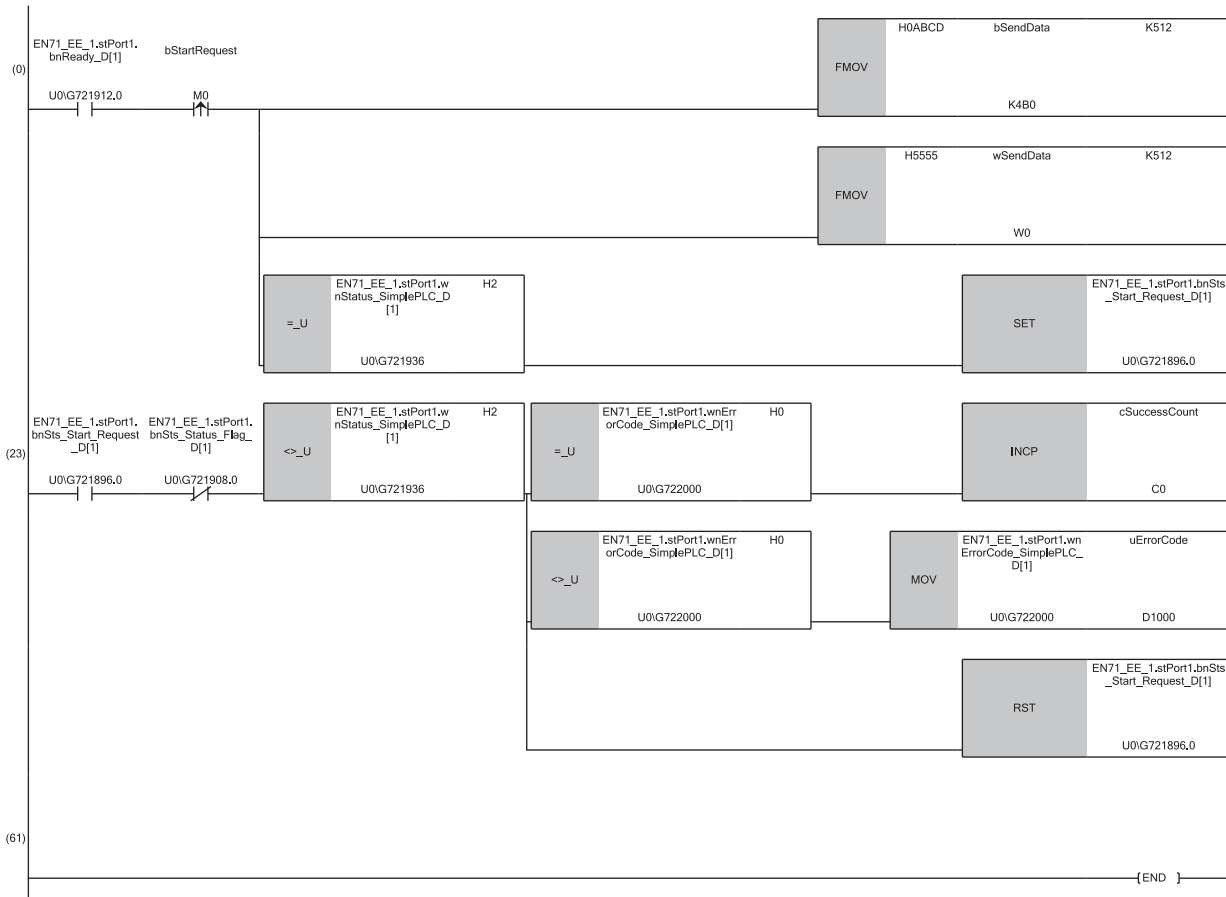

- (0) Turn on 'Request execution device of the simple CPU communication setting No.1' (M0) and store the transfer data ABCDH to 512 points of data from bSendData (K4B0), and the transfer data (5555H) to 512 points of data from wSendData (W0).
Turn on 'Request to start communication at request of Simple CPU communication setting No.1' (Un\G721896.0) when 'Communication status storage location of Simple CPU communication setting No.1' (Un\G721936) is 2H.
- (23) Start counting 'Number of successful communications' (C0) when communications start successfully.
Store an error code in 'Simple CPU communication setting No.1 error code' (D1000) when the abnormal state is detected.

Precautions

This section provides precautions for the simple CPU communication function.

Incomplete data reception and timeout

Because the load of Ethernet communication becomes heavy during execution of the simple CPU communication, if another communication function (such as MELSOFT connection, SLMP communication, socket communication function, and simple device communication function) is simultaneously performed by using UDP, the data reception of UDP may not be completed, resulting in a timeout error or other errors. Therefore, to perform other communications during the simple CPU communication, the communication using TCP is recommended.

Execution interval setting

The execution interval of the simple CPU communication function and time required for completing the communications will differ according to the load rate of the Ethernet line, operating status of other communication functions (such as MELSOFT connection, SLMP communication, socket communication function, and simple device communication function), scan time of the communication destination, and system configuration. Thus, the set execution interval or time required for completing the communications may be increased.

■Cause of increased execution interval of the simple CPU communication

- The scan time of the control CPU module of the RJ71EN71 where the simple CPU communication function is set is long.
- The RJ71EN71 where the simple CPU communication function is set is communicating by using a function other than the simple CPU communication function, and the processing of the communication by using a function other than the simple CPU communication function takes time.
- The load on the Ethernet line is high.
- The number of settings in "Simple CPU Communication Setting" under "Application Settings" is large.
- Response from the communication destination is delayed.
- More than one RJ71EN71 where the simple CPU communication function is set is mounted on a base unit (main base unit or extension base unit).

To perform communications at the set execution interval, set a sufficient execution interval. If checking the execution interval is required, perform actual communications and check it with the "Simple CPU Communication Diagnostics" window.

Duplication of own station port numbers

The simple CPU communication cannot be performed in the following cases.

- The own station port number set in the simple CPU communication and the own station port number of the CPU module set in the external device configuration are the same.
- The own station port number set in the simple CPU communication and the one set in another function such as the socket communication are the same. ('Simple CPU communication status for each setting number' (Un\G721936 to Un\G721999) is "AH: Communications impossible".)

Set a unique own station port number. For the setting numbers other than the one in which a communication error occurs, communications are performed after the preparation processing is completed normally.

IP address and module type of communication destination

Check the IP address and module type of the communication destination before setting the parameters. The simple CPU communication is not performed when the communication destination does not exist (an incorrect IP address is specified) or when the preparation processing is not completed. ('Simple CPU communication status for each setting number' (Un\G721936 to Un\G721999) is AH: Communications impossible.)

Communication destination device

Check the type and range of the device to be read or written in the communication destination.

Especially, when "Write" is set to "Communication Pattern", the control data of the communication destination may be overwritten, resulting in malfunction.

Security

The simple CPU communication is not performed when a remote password is set for the communication destination. Clear the remote password.

If the IP filter has been set in the communication destination, check the setting and correct it if necessary.

If any security function specific to the communication destination (programmable controller products manufactured by other companies), clear the function.

When using the file register (R, ZR)

When using the file register (R, ZR) for the device on the own station, always assign the device within the setting range. If the devices are not assigned, an error occurs (error code: 4031), and the simple CPU communication of the setting number which exceeds the setting range cannot be performed.

Setting of the network and station numbers

When the communication destination is the MELSEC iQ-R (Ethernet module), MELSEC-Q (Ethernet module), or MELSEC-L (Ethernet module), the network number and station number should be set in the own node settings of the Ethernet parameters.

Usable connections

Up to 64 connections can be used in the simple CPU communication settings. If, however, connection has been used for other functions, the maximum number of connections is the difference calculated by subtracting the number of connections used for other function from 64.

Measures against errors occurring during communications

When an error occurs during writing communications, data writing may not be completed properly. Check the error details, take appropriate measures, and restart communications.

Restrictions when certain devices are used

When using the following devices, use modules with the firmware version of "62" or later.

- F, T (TS, TC, TN)
- ST (STS, STC, STN)
- C (CS, CC, CN)

Restrictions applicable depending on versions

The simple CPU communication function is available for the RJ71EN71 or RnENCPU (network part) whose firmware version is "35" or later and that uses the engineering tool of software version of 1.050C or later.

The terms of "Fixed Interval" and "On Request" in the list are used for the communication setting in "Simple CPU Communication Setting" under "Application Settings".

Engineering tool		RJ71EN71 or RnENCPU (network part)				
		Firmware version of "35" to "38"	Firmware version of "39" to "41"	Firmware version of "42" to "46"	Firmware version of "47" to "61"	Firmware version of "62" or later
Software version of 1.050C		<ul style="list-style-type: none"> • Number of settable modules: 1 to 64 • Communication setting: "Fixed Interval" only • Communication destination: MELSEC iQ-R (built-in Ethernet), MELSEC-Q (built-in Ethernet), MELSEC-L (built-in Ethernet), MELSEC iQ-F (built-in Ethernet), MELSEC iQ-R (Ethernet module), MELSEC-Q (Ethernet module), MELSEC-L (Ethernet module), SLMP-compatible device (QnA-compatible 3E frame), OMRON (CS/CJ series), KEYENCE (KV series), Panasonic (FP2SH series), Panasonic (FP7 series), YASKAWA MP3000 series, YASKAWA MP2000 series, Yokogawa FA-M3 series, MODBUS/TCP-compatible device • Option setting: Cannot be set (The setting value is regarded as 0.)⁴ 				
Software version of 1.052E or later	Setting No. 1 to 64	Same as the engineering tool of software version of 1.050C ^{1,2}	<ul style="list-style-type: none"> • Number of settable modules: 1 to 512 • Communication setting: "Fixed Interval" or "On Request" • Communication destination: MELSEC-A/AnS (Ethernet module) and MELSEC-FX3 (Ethernet block/adapter) are added to the communication destination that uses the engineering tool of software version of 1.050C. • Option setting: Cannot be set (The setting value is regarded as 0.)⁴ 			
	Setting No. 65 to 512	— (Simple CPU communication impossible) ³				
Software version of 1.060N or later	Setting No. 1 to 64	Same as the engineering tool of software version of 1.050C ^{1,2}	Same as the engineering tool of software version of 1.052E or later	<ul style="list-style-type: none"> • Communication destination: MELSEC iQ-L (built-in Ethernet), SIEMENS S7 series, Fuji Electric MICREX-SX series, and JTEKT TOYOPUC series are added to the communication destination that uses the engineering tool of software version of 1.052E. • Redundant system • Option setting: Cannot be set (The setting value is regarded as 0.)⁴ 		
	Setting No. 65 to 512	— (Simple CPU communication impossible) ³				
Software version of 1.065T or later	Setting No. 1 to 64	<ul style="list-style-type: none"> • Same as the engineering tool of software version of 1.050C^{1,2} • The setting value is not reflected even if an option is set. The setting value is regarded as 0. 	<ul style="list-style-type: none"> • Same as the engineering tool of software version of 1.052E or later • The setting value is not reflected even if an option is set. The setting value is regarded as 0. 	<ul style="list-style-type: none"> • Communication destination: MELSEC iQ-L (built-in Ethernet), SIEMENS S7 series, Fuji Electric MICREX-SX series, and JTEKT TOYOPUC series are added to the communication destination that uses the engineering tool of software version of 1.052E. • Redundant system • The setting value is not reflected even if an option is set. The setting value is regarded as 0. 	The option setting is available for a MODBUS/TCP-compatible device.	
	Setting No. 65 to 512	— (Simple CPU communication impossible) ³				

Engineering tool		RJ71EN71 or RnENCPU (network part)				
		Firmware version of "35" to "38"	Firmware version of "39" to "41"	Firmware version of "42" to "46"	Firmware version of "47" to "61"	Firmware version of "62" or later
Software version of 1.085P or later	Setting No. 1 to 64	<ul style="list-style-type: none"> • Same as the engineering tool of software version of 1.050C^{*1*} • The setting value is not reflected even if an option is set. The setting value is regarded as 0. 	<ul style="list-style-type: none"> • Same as the engineering tool of software version of 1.052E or later • The setting value is not reflected even if an option is set. The setting value is regarded as 0. 	<ul style="list-style-type: none"> • Communication destination: MELSEC iQ-L (built-in Ethernet), SIEMENS S7 series, Fuji Electric MICREX-SX series, and JTEKT TOYOPUC series are added to the communication destination that uses the engineering tool of software version of 1.052E. • Redundant system • The setting value is not reflected even if an option is set. The setting value is regarded as 0. 	The option setting is available for a MODBUS/TCP-compatible device.	<ul style="list-style-type: none"> • Devices that can use F, T, ST, and C: own station, MELSEC iQ-R (built-in Ethernet, Ethernet module), MELSEC-Q (built-in Ethernet, Ethernet module), MELSEC-L (built-in Ethernet, Ethernet module), MELSEC iQ-F (built-in Ethernet), MELSEC iQ-L (built-in Ethernet), SLMP-compatible device (QnA-compatible 3E frame) • Devices that can use F, T, and C: MELSEC-A/AnS (Ethernet module) • Devices that can use S, T, and C: MELSEC-FX3 (Ethernet block/adapter) • Communication destination: SIEMENS S7 series (extension) are added.
	Setting No. 65 to 512	— (Simple CPU communication impossible) ^{*3}				

- *1 The simple CPU communication of the setting number with "On Request" set to the communication setting is not executed and a simple CPU communication error (error code: CFBFH) occurs.
- *2 When a duplicate port number is set to the own stations, a duplication error of own port number (error code: CFB2H) occurs. The simple CPU communication of the setting number with an unsupported communication destination is not executed, and a simple CPU communication error (CFB0H or CFBFH) occurs.
- *3 Setting No.65 to 512 are prohibited to use. Using the numbers can cause malfunction of the module. To use setting No.65 to 512, use RJ71EN71 or RnENCPU (network part) with the firmware version of "39" or later.
- *4 Firmware version of "47" or later only

Point 

When setting No.65 to 512 is used on the RJ71EN71 or RnENCPU (network part) with the firmware version of "35" to "38", data of G device (buffer memory area) may be overwritten. To use setting No.65 to 512, use RJ71EN71 or RnENCPU (network part) with the firmware version of "39" or later.

1.15 Simple CPU Communication Function (CPU Module (Built-in Ethernet Port Part))

This function allows data communications between specified devices at the specified timing just by making simple settings of the CPU module (built-in Ethernet port part) from an engineering tool. Send/receive is performed with a specified communication destination on a one-to-one basis.

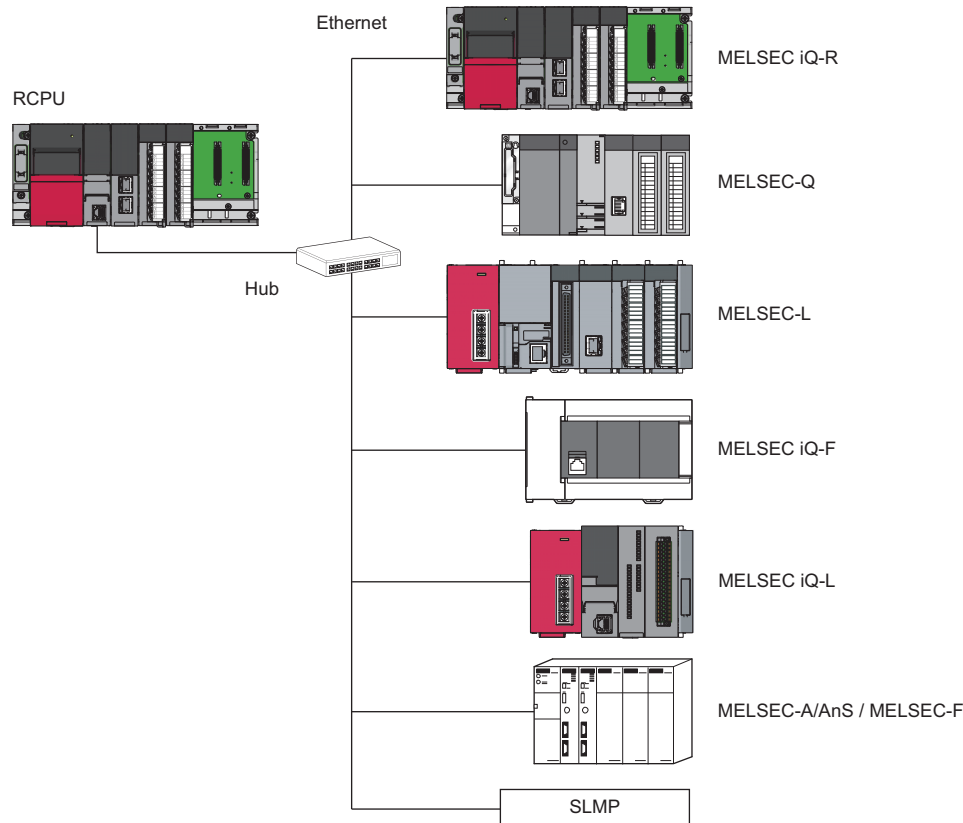

Communication destination	Type	Description
MELSEC iQ-R series	CPU module (built-in Ethernet)	☞ Page 228 Module type
MELSEC-Q series	CPU module (built-in Ethernet), Ethernet module ^{*1}	
MELSEC-L series	CPU module (built-in Ethernet), Ethernet module ^{*1}	
MELSEC iQ-F series ^{*1}	CPU module (built-in Ethernet)	
MELSEC iQ-L series ^{*1}	CPU module (built-in Ethernet)	
MELSEC-A/AnS series ^{*1}	Ethernet module	
MELSEC-F series ^{*1}	Ethernet block/adaptor	
SLMP-compatible device	QnA-compatible 3E frame	

*1 For the communication destinations and types that can be set, check the versions of the CPU module and engineering tool. (☞ Page 564 Added and Enhanced Functions)

Point

Access via routers is also available. For the access, set the subnet mask and default gateway. (☞ Page 318 Own Node Settings)

Restriction

Before using the simple CPU communication function, check the versions of the CPU module used. (☞ Page 564 Added and Enhanced Functions)

Setting procedure

The following section describes the settings for using this function.

1. Set "Enable" for "To Use or Not to Use Simple CPU Communication Setting" in "Simple CPU Communication Setting" under "Application Settings".

 [Navigation window] ⇒ [Parameter] ⇒ Target module ⇒ [Module Parameter] ⇒ [Application Settings] ⇒ [Simple CPU Communication Setting]

2. Double-click "<Detailed Setting>" of the "Simple CPU Communication Setting" to display the following window. ( Page 336 Simple CPU communication setting (CPU module (built-in Ethernet port part)))

Setting No.		Communication Pattern	Communication Setting Execution Interval(ms)	Communication Destination (IP Address)		Target PLC No.	Bit Device				Word Device				Communication Time-out Period(ms)	Communication Retry Count	Monitoring Time At Error(s)	Comment				
				Source	→	Destination	Points	Type	Start	End	→	Type	Start	End	→	Type	Start	End				
1					→						→				→							
2					→						→				→							
3					→						→				→							
4					→						→				→							
5					→						→				→							
6					→						→				→							
7					→						→				→							
8					→						→				→							
9					→						→				→							
10					→						→				→							

3. After setting the items, write the module parameters to the CPU module on the own station, and reset or power off and on the CPU module to start the simple CPU communication.

Communication Pattern

Select the communication pattern from the following items.

Setting item	Description
Read	Read the data of the specified destination device (transmission source) to the specified device of the own station (transmission destination).
Write	Write the data of the specified device of the own station (transmission source) to the specified destination device (transmission destination).



Communication Setting: Execution Interval

Select the communication timing from the following items.

Setting item	Description	Setting range
Fixed Interval	—	Data are communicated between the devices at a specified execution interval.
	Execution Interval (ms)	Execution interval is set.
On Request* ¹	—	Data are sent and received only upon request.

*1 To set "On Request", check the versions of the CPU module and engineering tool. ( Page 564 Added and Enhanced Functions)

Point

- Actual time of execution interval may be longer than the value of the setting because the time is affected by the specified communication destinations or Ethernet line congestion. For the preventive measures, refer to the following.
 -  Page 438 When the simple CPU communication function is used
 - If latency time is set, data communication is started after the latency time has passed. ( Page 237 Latency Time)

Communication Destination (IP Address)

Click "Destination" to open the "Communication Destination Setting" window and specify the communication destination. Up to 64 communication destinations can be registered.

■Module type

Select the module type of the communication destination from the following list.

Module type	Communication destination	Communication specification
MELSEC iQ-R (Built-in Ethernet)	MELSEC iQ-R series CPU module* ¹	MELSOFT connection (protocol: UDP)
MELSEC-Q (Built-in Ethernet)	Built-in Ethernet port QCPU	
MELSEC-L (Built-in Ethernet)	Built-in Ethernet port LCPU	
MELSEC iQ-F (Built-in Ethernet)	MELSEC iQ-F series CPU module* ²	
MELSEC iQ-L (Built-in Ethernet)	MELSEC iQ-L series CPU module	
MELSEC-Q (Ethernet Module)* ⁵	QCPU* ³ with which an Ethernet interface module can be mounted	
MELSEC-L (Ethernet Module)* ⁵	LCPU* ³ with which an Ethernet interface module can be mounted	
MELSEC-A/AnS (Ethernet Module)	ACPU* ⁴ with which an Ethernet interface module can be mounted	MC protocol (A-compatible 1E frame)
MELSEC-FX3 (Ethernet Block/Adapter)	<ul style="list-style-type: none"> FX3U and FX3UC CPUs with which an Ethernet Block can be mounted FX3S, FX3G, FX3GC, FX3U, and FX3UC CPUs with which an Ethernet Adapter can be mounted 	
SLMP Corresponding Device (QnA Compatible 3E Frame)	<ul style="list-style-type: none"> SLMP-compatible device (No serial number) MC protocol 3E frame-compatible device 	SLMP (MC protocol QnA-compatible 3E frame) Read (0401H) Write (1401H)

*1 The RnENCPU can communicate when the Ethernet port of its CPU part is connected.

*2 For the FX5U CPU module and FX5UC CPU module, the module with the firmware version of "1.110" or later can be used.

*3 The CPU module that controls the Ethernet interface module is the communication destination.

*4 The AnCPU, AnSCPU, and QCPU (A mode) are included.

*5 For the CPU modules and their available versions, refer to the following.

 Page 564 Added and Enhanced Functions

■IP address, TCP/UDP, port number, and own station port number



Set the IP address of the communication destination, communication protocol, port number, and own port number.

Module type	Setting range			
	IP address	TCP/UDP	Port No.	Own station port number
MELSEC iQ-R (Built-in Ethernet)	0.0.0.1 to 223.255.255.254	UDP	Cannot be set.	Cannot be set.
MELSEC iQ-L (Built-in Ethernet)				
MELSEC iQ-F (Built-in Ethernet)				
MELSEC-Q (Built-in Ethernet)				
MELSEC-L (Built-in Ethernet)				
MELSEC-Q (Ethernet Module)				
MELSEC-L (Ethernet Module)				
MELSEC-A/AnS (Ethernet Module)			256 to 65534	1 to 4999, 5010 to 65534
MELSEC-FX3 (Ethernet Block/Adapter)	1025 to 5548, 5552 to 65534			
SLMP Corresponding Device (QnA Compatible 3E Frame)	1 to 4999, 5010 to 65534			

-
- When a multiple CPU system is configured, specify the IP address of the CPU module to which the Ethernet cable is connected.
 - In communications where the communication destination other than MELSEC-A/AnS, MELSEC-FX3, and SLMP Corresponding Device is set, port numbers 61696 to 65534 are dynamically used for the own station port numbers. Therefore, when using the simple CPU communication function, do not set 61696 to 65534 to the own station port numbers for establishing a connection instruction (SP.SOCOPEN) of the socket communication function. If set, the instruction may not be completed properly.
 - Port numbers 1 to 1023 are typically reserved port numbers (WELL KNOWN PORT NUMBERS) and 61440 to 65534 are used by other communication functions, so 1024 to 4999 or 5010 to 61439 should be used for the own station port numbers.
 - When specifying the same communication destination in multiple settings, set different own station port numbers.
-

Setting for communication destination

The settings differ depending on the communication destination.

Communication destination	Necessary setting
MELSEC iQ-R (Built-in Ethernet)	Communication uses the auto-open UDP port, so the setting is not required.
MELSEC-Q (Built-in Ethernet)	Set the following items (for the number of devices) in the "Open Setting" window. <ul style="list-style-type: none"> • Protocol: "UDP" • Open System: "MELSOFT Connection"
MELSEC-L (Built-in Ethernet)	
MELSEC iQ-F (Built-in Ethernet)	Communication uses the auto-open UDP port, so the setting is not required.
MELSEC iQ-L (Built-in Ethernet)	
MELSEC-Q (Ethernet Module)	Set the network number and station number.
MELSEC-L (Ethernet Module)	
MELSEC-A/AnS (Ethernet Module)	<p>■ Programming tool</p> <p>Create an initial processing program, and set the following items.</p> <ul style="list-style-type: none"> • IP address and port number • Communication method: "UDP" • Bit 15 and Bits 0 to 7 of Area for communication instruction during stop (Un/G496) (Turn on the bits corresponding to the connection numbers to be used.)*¹ <p>For the initial processing program, refer to the following.</p> <p> For A Ethernet Interface Module User's Manual</p> <p>■ DIP switch on the front of the module</p> <p>Set the following items.</p> <ul style="list-style-type: none"> • SW2 (data code setting): Off • SW7 (CPU communication timing setting): On*²
MELSEC-FX3 (Ethernet Block/Adapter)	<p>Set "Communication Data Code" of "Ethernet Port" to "Binary Code".</p> <p>Set the following items (for the number of devices) in the "Open Setting" window.</p> <ul style="list-style-type: none"> • IP address and port number • Protocol: "UDP" • Open system: "MC protocol"
SLMP Corresponding Device (QnA Compatible 3E Frame)	<p>Configure the settings so that the SLMP (QnA-compatible 3E frame of the MC protocol) can be used on the SLMP-compatible device side. ( Manual for the device used)</p> <p>Set the communication data code to binary.</p> <p>Set the protocol to UDP.</p>

*1 Set this item to execute this function while the communication destination CPU module is in the STOP state or stop error state.

*2 Turn on this switch to execute this function while the communication destination CPU module is in the RUN state.

Target PLC No.

When the communication destination is one of the following modules and a multiple CPU system is used, specify the "Target PLC No." of the communication destination.

- MELSEC iQ-R (built-in Ethernet): RnCPU, RnENCPU, RnPCCPU, RnSFCCPU
- MELSEC-Q (built-in Ethernet): QnUDE(H)CPU, QnUDVCCPU, QnUDPVCPU ( QCPU User's Manual (Multiple CPU System))

Devices that can be specified

The devices that can be specified as transmission source and transmission destination vary depending on the communication destination. Bit device and word device can be set together for each setting number.

For devices that can be specified, the size of a device is specified in units of 16 points for a bit device and one point for a word device. Use 0 or multiples of 16 to specify the device number of a bit device.

Point

- Set the number of device points to the total number of setting No.1 to 64 (8192 words maximum).
- The maximum number of points per setting is 512 words (bit device 8192 points maximum, word device 512 points maximum).

Restriction

A safety device cannot be specified.

■Devices that can be specified on the own station

The maximum number of points when the NZ2MC-16MBS is connected to the R120CPU. The number of points differs depending on the CPU module used, whether to use or not an extended SRAM cassette, or the type of the extended SRAM cassette.

Type	Applicable device		
	Symbol	Range	Remarks
Bit device	X	0H to 2FFFH	—
	Y	0H to 2FFFH	—
	M	0 to 161882111	A local device cannot be specified.
	L	0 to 32767	—
	F ^{*1}	0 to 32767	—
	B	0H to 9A61FFFH	—
	TS/TC ^{*1}	0 to 8993439	This device can be specified only when "Write" is set for "Communication Pattern".
	STS/STC ^{*1}	0 to 8993439	This device can be specified only when "Write" is set for "Communication Pattern".
	CS/CC ^{*1}	0 to 8993439	This device can be specified only when "Write" is set for "Communication Pattern".
	SB	0H to 9A61FFFH	—
Word device	SM	0 to 4095	—
	D	0 to 10117631	A local device cannot be specified.
	W	0H to 9A61FFFH	—
	TN ^{*1}	0 to 8993439	—
	STN ^{*1}	0 to 8993439	—
	CN ^{*1}	0 to 8993439	—
	SW	0H to 9A61FFFH	—
	SD	0 to 4095	—
	R	0 to 32767	Data is read or written following the file register settings of the communication destination.
	ZR	0 to 10027007	Data is read or written following the file register settings of the communication destination.
RD	0 to 1048575	—	

*1 To set this value, check the versions of the CPU module and engineering tool. ( Page 564 Added and Enhanced Functions)

■When the communication destination is the MELSEC iQ-R (built-in Ethernet)

The maximum number of points when the NZ2MC-16MBS is connected to the R120CPU. The number of points differs depending on the CPU module used, whether to use or not an extended SRAM cassette, or the type of the extended SRAM cassette.

Type	Applicable device		
	Symbol	Range	Remarks
Bit device	X	0H to 2FFFH	—
	Y	0H to 2FFFH	—
	M	0 to 161882111	A local device cannot be specified.
	L	0 to 32767	—
	F ^{*1}	0 to 32767	—
	B	0H to 9A61FFFH	—
	TS/TC ^{*1}	0 to 8993439	This device can be specified only when "Read" is set for "Communication Pattern".
	STS/STC ^{*1}	0 to 8993439	This device can be specified only when "Read" is set for "Communication Pattern".
	CS/CC ^{*1}	0 to 8993439	This device can be specified only when "Read" is set for "Communication Pattern".
	SB	0H to 9A61FFFH	—
	SM	0 to 4095	—
Word device	D	0 to 10117631	A local device cannot be specified.
	W	0H to 9A61FFFH	—
	TN ^{*1}	0 to 8993439	—
	STN ^{*1}	0 to 8993439	—
	CN ^{*1}	0 to 8993439	—
	SW	0H to 9A61FFFH	—
	SD	0 to 4095	—
	R	0 to 32767	Data is read or written following the file register settings of the communication destination.
	ZR	0 to 10027007	Data is read or written following the file register settings of the communication destination.
	RD	0 to 1048575	—

*1 To set this value, check the versions of the CPU module and engineering tool. (Page 564 Added and Enhanced Functions)

■When the communication destination is the MELSEC-Q (built-in Ethernet) or MELSEC-Q (Ethernet module)

The maximum number of points when the Q4MCA-8MBS is connected to the Q26UDVCP. The number of points differs depending on the CPU module used, whether to use or not an extended SRAM cassette, or the type of the extended SRAM cassette.

Type	Applicable device		
	Symbol	Range	Remarks
Bit device	X	0H to 1FFFH	—
	Y	0H to 1FFFH	—
	M	0 to 61439	—
	L	0 to 32767	—
	F ^{*1}	0 to 32767	—
	B	0H to EFFFH	—
	TS/TC ^{*1}	0 to 32767	This device can be specified only when "Read" is set for "Communication Pattern".
	STS/STC ^{*1}	0 to 32767	This device can be specified only when "Read" is set for "Communication Pattern".
	CS/CC ^{*1}	0 to 32767	This device can be specified only when "Read" is set for "Communication Pattern".
	SB	0H to 7FFFH	—
SM	0 to 2047	—	
Word device	D	0 to 4910079	The maximum number of points when D (extended data register) or W (extended link register) is set.
	W	0H to 4AEBFFH	The maximum number of points when D (extended data register) or W (extended link register) is set.
	TN ^{*1}	0 to 32767	—
	STN ^{*1}	0 to 32767	—
	CN ^{*1}	0 to 32767	—
	SW	0H to 7FFFH	—
	SD	0 to 2047	—
	R	0 to 32767	Data is read or written following the file register settings of the communication destination.
ZR	0 to 4849663	Data is read or written following the file register settings of the communication destination.	

*1 To set this value, check the versions of the CPU module and engineering tool. (Page 564 Added and Enhanced Functions)

■When the communication destination is the MELSEC-L (built-in Ethernet) or MELSEC-L (Ethernet module)

The following table lists the maximum number of points for the L26CPU. The number of points varies depending on the CPU module used.

Type	Applicable device		
	Symbol	Range	Remarks
Bit device	X	0H to 1FFFFH	—
	Y	0H to 1FFFFH	—
	M	0 to 61439	—
	L	0 to 32767	—
	F ^{*1}	0 to 32767	—
	B	0H to EFFFFH	—
	TS/TC ^{*1}	0 to 25471	This device can be specified only when "Read" is set for "Communication Pattern".
	STS/STC ^{*1}	0 to 25471	This device can be specified only when "Read" is set for "Communication Pattern".
	CS/CC ^{*1}	0 to 25471	This device can be specified only when "Read" is set for "Communication Pattern".
	SB	0H to 7FFFFH	—
	SM	0 to 2047	—
Word device	D	0 to 421887	The maximum number of points when D (extended data register) or W (extended link register) is set.
	W	0H to 6FFFFH	The maximum number of points when D (extended data register) or W (extended link register) is set.
	TN ^{*1}	0 to 25471	—
	STN ^{*1}	0 to 25471	—
	CN ^{*1}	0 to 25471	—
	SW	0H to 6FFFFH	—
	SD	0 to 2047	—
	R	0 to 32767	Data is read or written following the file register settings of the communication destination.
	ZR	0 to 393215	Data is read or written following the file register settings of the communication destination.

*1 To set this value, check the versions of the CPU module and engineering tool. (☞ Page 564 Added and Enhanced Functions)

■When the communication destination is the MELSEC iQ-F (built-in Ethernet)

Type	Applicable device		
	Symbol	Range	Remarks
Bit device	X	0 to 1777	Octal notation is used.
	Y	0 to 1777	Octal notation is used.
	M	0 to 32767	A local device cannot be specified.
	L	0 to 32767	—
	F ^{*1}	0 to 32767	—
	B	0H to 7FFFH	—
	TS/TC ^{*1}	0 to 1023	This device can be specified only when "Read" is set for "Communication Pattern".
	STS/STC ^{*1}	0 to 1023	This device can be specified only when "Read" is set for "Communication Pattern".
	CS/CC ^{*1}	0 to 1023	This device can be specified only when "Read" is set for "Communication Pattern".
	SB	0H to 7FFFH	—
SM	0 to 9999	—	
Word device	D	0 to 7999	A local device cannot be specified.
	W	0H to 7FFFH	—
	TN ^{*1}	0 to 1023	—
	STN ^{*1}	0 to 1023	—
	CN ^{*1}	0 to 1023	—
	SW	0H to 7FFFH	—
	SD	0 to 11999	—
	R	0 to 32767	Data is read or written following the file register settings of the communication destination.

*1 To set this value, check the versions of the CPU module and engineering tool. (☞ Page 564 Added and Enhanced Functions)

■When the communication destination is the MELSEC iQ-L (built-in Ethernet)

The maximum number of points when the L16HCPU is connected. The number of points varies depending on the CPU module used.

Type	Applicable device		
	Symbol	Range	Remarks
Bit device	X	0H to 2FFFFH	—
	Y	0H to 2FFFFH	—
	M	0 to 14065663	A local device cannot be specified.
	L	0 to 32767	—
	F ^{*1}	0 to 32767	—
	B	0H to D69FFFH	—
	TS/TC ^{*1}	0 to 781407	This device can be specified only when "Read" is set for "Communication Pattern".
	STS/STC ^{*1}	0 to 781407	This device can be specified only when "Read" is set for "Communication Pattern".
	CS/CC ^{*1}	0 to 781407	This device can be specified only when "Read" is set for "Communication Pattern".
	SB	0H to D69FFFH	—
SM	0 to 4095	—	
Word device	D	0 to 879103	A local device cannot be specified.
	W	0H to D69FFFH	—
	SW	0H to D69FFFH	—
	TN ^{*1}	0 to 781407	—
	STN ^{*1}	0 to 781407	—
	CN ^{*1}	0 to 781407	—
	SD	0 to 4095	—
	R	0 to 32767	Data is read or written following the file register settings of the communication destination.
	ZR	0 to 819199	Data is read or written following the file register settings of the communication destination.
RD	0 to 1048575	—	

*1 To set this value, check the versions of the CPU module and engineering tool. (☞ Page 564 Added and Enhanced Functions)

■When the communication destination is the MELSEC A/AnS (Ethernet module)

The maximum number of points for the A4UCPU. The number of points varies depending on the CPU module used. (📖 MELSEC Communication Protocol Reference Manual)

Type	Applicable device		
	Symbol	Range	Remarks
Bit device	X	0 to 7FFh	—
	Y	0 to 7FFh	—
	M	0 to 8191, 9000 to 9255	To specify 9000 to 9255 with "Communication Pattern" set to "Write", refer to the manual of the CPU module used. To specify 9000 to 9255, use 9000 + a multiple of 16.
	B	0 to FFFh	—
Word device	D	0 to 6143, 9000 to 9255	To specify 9000 to 9255 with "Communication Pattern" set to "Write", refer to the manual of the CPU module used.
	W	0 to FFFh	—
	R	0 to 8191	—

■When the communication destination is the MELSEC-FX3 (Ethernet block/adaptor)

Type	Applicable device		
	Symbol	Range	Remarks
Bit device	X	0 to 377	Octal notation is used.
	Y	0 to 377	Octal notation is used.
	M	0 to 7679, 8000 to 8511	To specify 8000 to 8511 with "Communication Pattern" set to "Write", refer to the manual of the CPU module used.
Word device	D	0 to 8511	To specify 8000 to 8511 with "Communication Pattern" set to "Write", refer to the manual of the CPU module used.
	R	0 to 32767	—

■When the communication destination is an SLMP-compatible device (QnA-compatible 3E frame)

Applicable devices differ depending on the device. For applicable devices, refer to the manual for the device used.

The device types that can be set are X, Y, M, L, F^{*1}, B, T (TS^{*1*2}, TC^{*1*2}, TN^{*1}), ST (STS^{*1*2}, STC^{*1*2}, STN^{*1}), C (CS^{*1*2}, CC^{*1*2}, CN^{*1}), SB, SM, D, W, SW, SD, R, and ZR. The accessible device range of the communication destination is the range which can be specified with the subcommands 00□1 and 00□0 of the SLMP (QnA-compatible 3E frame of the MC protocol).

*1 To set this value, check the versions of the CPU module and engineering tool. (📖 Page 564 Added and Enhanced Functions)

*2 This device can be specified only when "Read" is set for "Communication Pattern".

Communication Time-out Period/Communication Retry Count/Monitoring Time At Error

When the communication destination does not respond or returns an error response, the communication will be retried (resent) after the time-out period has passed.

When Communication Setting is "Fixed Interval", an error is detected after communications are performed for the communication retry count + 1 times, then the fixed interval communication is performed during the monitoring time at error. If the communication destination responds after these communications, the communications at the execution interval specified with the parameters are restarted.

When Communication Setting is "On Request", an error is detected after communications are performed for the communication retry count + 1 times, then simple CPU communication status becomes "2H: waiting for the request".

Ex.

Error detection timing when 2 is set for the communication retry count

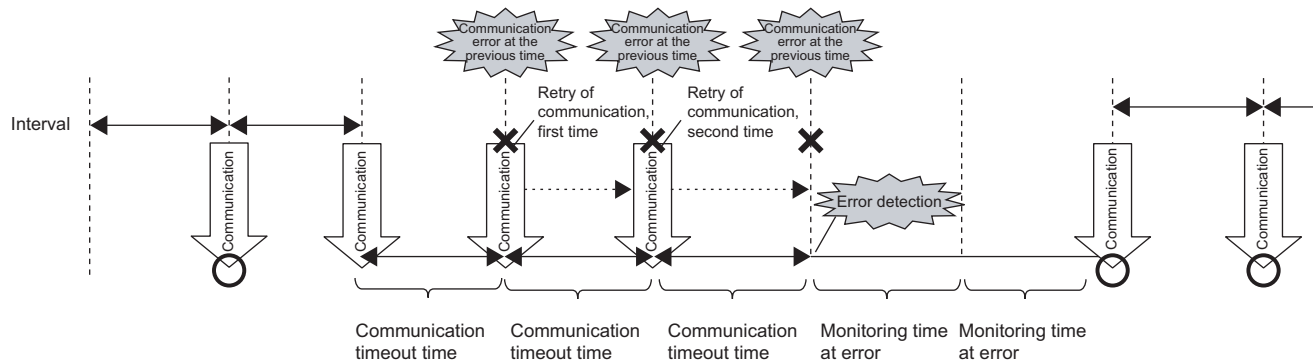

Point

The error is detected if the communication destination does not respond or communications fail by when the following time has passed: $(\text{communication retry count} + 1) \times \text{communication time-out period}$

Latency Time

By setting the latency time, the start timing in the communications can be switched in the following cases.

- To prevent an error due to the overlap of the start timing in the communications
- To start communications after the communication destination is ready for the communications

During the latency time, "Preparing" is indicated in the communication status.

Point

When the latency time is set, the communications of the setting numbers where Communication Setting is set to "Fixed Interval" will not be performed during the latency time, and the communications will start after the latency time has elapsed. For the setting numbers where "Communication Setting" is set to "On Request", if Request to start communication at request is turned on during the latency time, the communications will start after the latency time has elapsed.

Initial Communication Setting

The operation can be set when the communication destination does not respond (including that the communication destination has the different IP address or is not started) at the initial communication.

By using this setting, communications can be started at the timing when the external device is connected or powered on after starting simple CPU communications even if the external device is not connected or powered off at starting the simple CPU communications.

Point 

This setting is disabled when the communication setting is set to "On Request".

This setting is also disabled when the communication setting is set to "Fixed Interval" if Simple CPU communication status is other than the following:

- 3H: Communicating
 - 5H: Retry being executed
 - 6H: Monitoring
-

Restriction 

Before using the initial communication setting, check the versions of the CPU module used. ( Page 564 Added and Enhanced Functions)



Operations when the communication setting is "Fixed Interval"

■ Operation

After the system is powered off and on or the CPU module is reset, communications start.

After data is sent to the communication destination, if no response is received from the communication destination or an error occurs (or an error response is received), the system makes retries when the timeout time has elapsed. ( Page 237 Communication Time-out Period/Communication Retry Count/Monitoring Time At Error)

Point 

- After the system is powered off and on or the CPU module is reset, the system starts the preparation processing. If an error occurs in the preparation processing, data will not be sent or received. In this case, the CPU buffer memory area of Simple CPU communication status stores AH (Communications impossible).
 - When the latency time is set, the communications will start after the latency time has elapsed. ( Page 237 Latency Time)
 - The operations in the initial communication vary depending on the setting details of the initial communication setting. When the initial communication setting is not set and no response is received from the communication destination, an error occurs and data are not sent or received. (The fixed interval communication is not performed during the monitoring time at error.) In addition, the initial communication setting cannot be selected for the RnPCPU. (Communications start once the communication destination device is connected (powered on).) ( Page 237 Initial Communication Setting)
 - If multiple setting numbers are set for the same communication destination, the operations are as follows: When Communication Setting is set to "Fixed Interval" and retries occur in the processing of one setting number, communications on the other setting numbers set for the same communication destination will not be performed at the execution interval. When Communication Setting is set to "On Request", communications cannot be performed while the CPU buffer memory area of Simple CPU communication status is 6H (monitoring).
-

Operations when the communication setting is "On Request"

■Operation

After the system is powered off and on or the CPU module is reset, communications start when the CPU buffer memory area of Request to start communication at request is turned on. After the data are sent and received, the system automatically turns off the CPU buffer memory area of Request to start communication at request, and changes Simple CPU communication status to 2H (waiting for the request).

After data is sent to the communication destination, if no response is received from the communication destination or an error occurs (or an error response is received), the system makes retries when the timeout time has elapsed. (📄 Page 237 Communication Time-out Period/Communication Retry Count/Monitoring Time At Error)

Point

- After the system is powered off and on or the CPU module is reset, the system starts the preparation processing. If an error occurs in the preparation processing, data will not be sent or received. In this case, the CPU buffer memory area of Simple CPU communication status stores AH (Communications impossible).
- When the latency time is set, the communications will start after the latency time has elapsed. During the latency time, the CPU buffer memory area of Request to start at request is ignored even when it is turned on. (📄 Page 237 Latency Time)
- During the initial execution of communications^{*1}, the processing time is longer because it includes the preparation processing, such as checking the availability of the communication destination.
- After Request to start communication at request is turned on, another request will be ignored even when the CPU buffer memory area of Request to start communication at request is turned off and on by a program.
- The updates for the following operations do not occur simultaneously: when the execution status flag is turned on, when Request to start communication at request is turned on, and when Simple CPU communication status becomes 3H (communicating). The updates for the following operations may not occur simultaneously if the scan time is long: when the execution status flag is turned off, when Request to start communication at request is turned off, and when Simple CPU communication status becomes 2H (waiting for the request).
- If the scan time is long, the on and off of the execution status flag are updated simultaneously, which may disable the program to detect the flags.
- When multiple setting numbers are set for the same communication destination, if an error is detected in one of the settings, the error will also occur in the other setting numbers set for the same communication destination. In addition, when "Communication Setting" of the same communication destination is set to "Fixed Interval", communications cannot be performed while the CPU buffer memory area of Simple CPU communication status is 6H (monitoring).

*1 This refers to any initial executions with the communication setting "On Request" where the same communication destination is set, or the execution immediately following one that completed with an error. In addition, this also refers to the execution under the following conditions: Another setting number set for the same communication destination with its communication setting "Fixed Interval" exists, and all the "Fixed Interval" settings are in the stop status. (This does not apply when the communication setting "Fixed Interval" is 3H (communicating).)

Ex.

Operation of Request to start communication at request of setting No.1

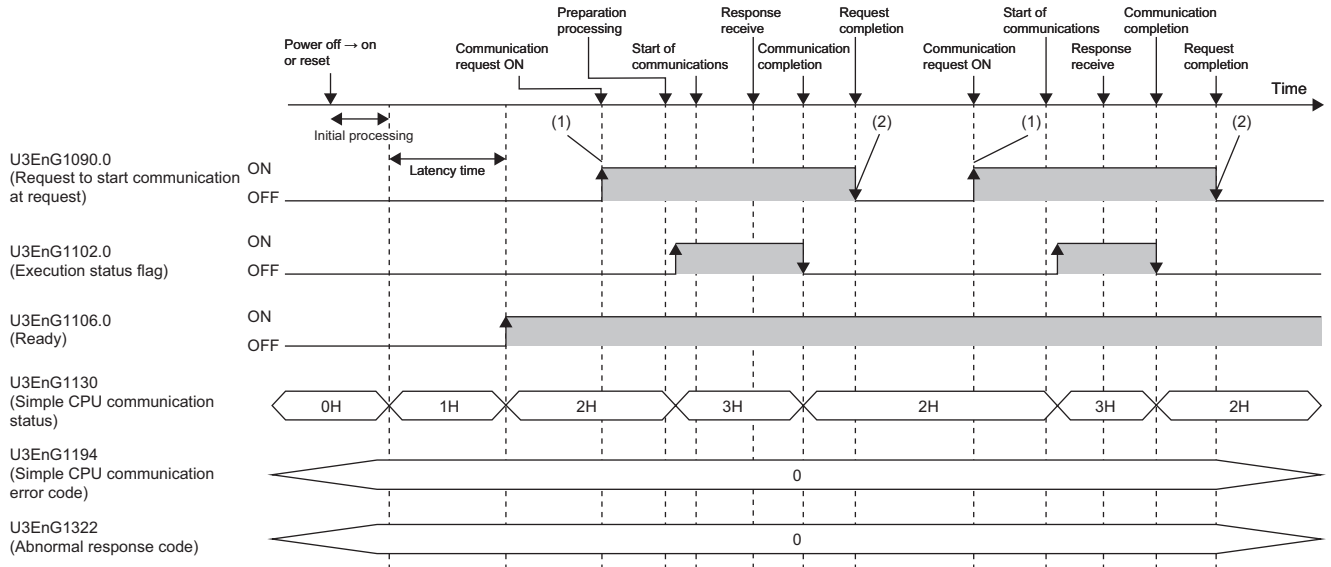

- (1) The buffer memory area is turned on by the program.
- (2) The buffer memory area is turned off by the system.

Operation during the simple CPU communication

■ Operation of the own station

Since the own station operates without depending on the operating status of the CPU module, the simple CPU communication is performed even when the CPU module is in the STOP state because of stop error. When an initial communication error occurs, communications of the corresponding setting numbers are stopped and ones of the setting numbers, where no error occurs will operate.

If the communication destination responds at the timing of the END processing of the CPU module, data is transferred to the system area for the simple CPU communication.

■ Operation of the communication destination

The operation differs depending on the communication destination.

Communication destination	Data operation in one setting
MELSEC iQ-R (Built-in Ethernet)	The data in one setting is sent simultaneously, except under the following conditions: <ul style="list-style-type: none"> • A bit device (TS, TC, STS, STC, CS, and CC) and a word device are specified simultaneously.*1 (In this case, the data are sent at different timing.)
MELSEC-Q (Built-in Ethernet)	
MELSEC-L (Built-in Ethernet)	
MELSEC iQ-F (Built-in Ethernet)	
MELSEC iQ-L (Built-in Ethernet)	
MELSEC-Q (Ethernet Module)	The data specified with a bit device or a word device in one setting are sent simultaneously. However, if both a bit device and a word device are set for the same setting number, the bit device and word device are sent at different timing.
MELSEC-L (Ethernet Module)	
MELSEC-A/AnS (Ethernet Module)	The data are sent simultaneously when the data size in one setting is as follows*1: <ul style="list-style-type: none"> • When "Write" is set to "Communication Pattern": Bit device of 640 points or less, word device of 256 points or less • When "Read" is set to "Communication Pattern": Bit device of 2048 points or less, word device of 256 points or less
MELSEC-FX3 (Ethernet Block/Adapter)	The data are sent simultaneously when the data size in one setting is as follows*1: <ul style="list-style-type: none"> • When "Write" is set to "Communication Pattern": Bit device of 160 points or less, word device of 64 points or less • When "Read" is set to "Communication Pattern": Bit device of 512 points or less, word device of 64 points or less
SLMP Corresponding Device (QnA Compatible 3E Frame)	The data specified with a bit device or a word device in one setting are sent simultaneously. However, if both a bit device and a word device are set for the same setting number, the data of each device is communicated at different timing.*1

*1 The order of a word device and a bit device for read/write is as follows:

- When "Communication Pattern" is set to "Read": Word device → Bit device
- When "Communication Pattern" is set to "Write": Bit device → Word device

Checking the simple CPU communication status

The simple CPU communication status can be checked with the buffer memory or diagnostic functions.

Checking with the buffer memory

The simple CPU communication status can be checked with the storage status of the corresponding setting number in the following CPU buffer memory areas.

Item	Address	Remarks
Request to start communication at request	U3En\G1090 to 1093	1090.0: Setting No.1 to 1093.F: Setting No.64
Request to stop fixed interval communication	U3En\G1094 to 1097	1094.0: Setting No.1 to 1097.F: Setting No.64
Request to restart fixed interval communication	U3En\G1098 to 1101	1098.0: Setting No.1 to 1101.F: Setting No.64
Execution status flag	U3En\G1102 to 1105	1102.0: Setting No.1 to 1105.F: Setting No.64
Ready	U3En\G1106 to 1109	1106.0: Setting No.1 to 1109.F: Setting No.64
Simple CPU communication status	0H: Unset	U3En\G1130 to 1193 1130: Setting No.1 to 1193: Setting No.64
	1H: Preparing	
	2H: Waiting for the request	
	3H: Communicating	
	4H: Communication stop	
	5H: Retry being executed	
	6H: Monitoring	
	AH: Communications impossible	
Simple CPU communication error code	U3En\G1194 to 1257	1194: Setting No.1 to 1257: Setting No.64
Execution interval (current value)	U3En\G1258 to 1321	1258: Setting No.1 to 1321: Setting No.64
Abnormal response code	U3En\G1322 to 1385	1322: Setting No.1 to 1385: Setting No.64

For details on the values to be stored in the CPU buffer memory, refer to the following.

 Page 483 CPU module (built-in Ethernet port part)

Point

When the "MELSEC-A/AnS (Ethernet Module)" or "MELSEC-FX3 (Ethernet Block/Adapter)" is set to the communication destination, if an error response is received from the communication destination, the buffer memory area of Simple CPU communication error code stores the error code, CFB4H, and the buffer memory area of Abnormal response code stores the codes returned from the external device.

Request to stop fixed interval communication/Request to restart fixed interval communication

When the simple CPU communication status of the corresponding setting number in the CPU buffer memory is either of the following, communications can be stopped by turning off and on the stop request of the corresponding setting number.

- 3H: Communicating
- 5H: Retry being executed
- 6H: Monitoring

Point

- This setting is disabled when the communication setting is set to "On Request". This setting is also disabled if Simple CPU communication status is other than the above when the communication setting is set to "Fixed Interval".
- When the stop request is turned off and on, the communications will stop at the timing of sending data in the next execution interval. Therefore, if the communication destination does not respond with the stop request accepted, the communications will stop after the communication time-out period has passed. When the retry is being executed, the communications will stop after the communication time-out period has passed without depending on the retry count.
- When an error occurs during stop in another setting numbers set for the same communication destination, the value will not be stored in the simple CPU communication error code of the setting number itself.

When the simple CPU communication status of the corresponding setting number in the CPU buffer memory is "4H: Communication stop", communications can be restarted by turning off and on the restart request for the corresponding setting number. (If the status is other than "4H: Communication stop", the restart request is invalid.)

Point

While another setting number that is set for the same communication destination has an error, the communication cannot be restarted.

Ex.

The operation at communication stop/restart request for the setting No.1

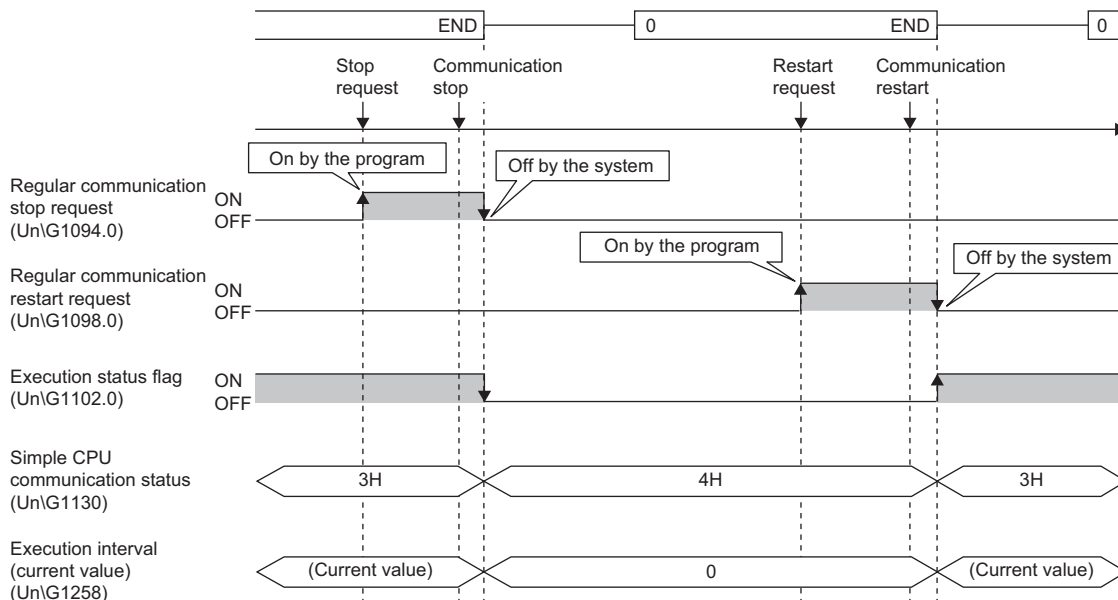

Checking with "simple CPU communication diagnostics"

The communication status of the simple CPU communication function can be checked with "Simple CPU Communication Diagnostics".

For details, refer to the following.

☞ Page 425 Simple CPU communication diagnostics

Simple CPU communication in a redundant system

For the Process CPU (redundant mode), the control system CPU communicates with a communication destination on a 1:1 (one-to-one) basis to send/receive device data. (The standby system does not communicate with external devices.)

For system switching, communication by the old control system is interrupted, and the new control system connects to the communication destination to continue communication.

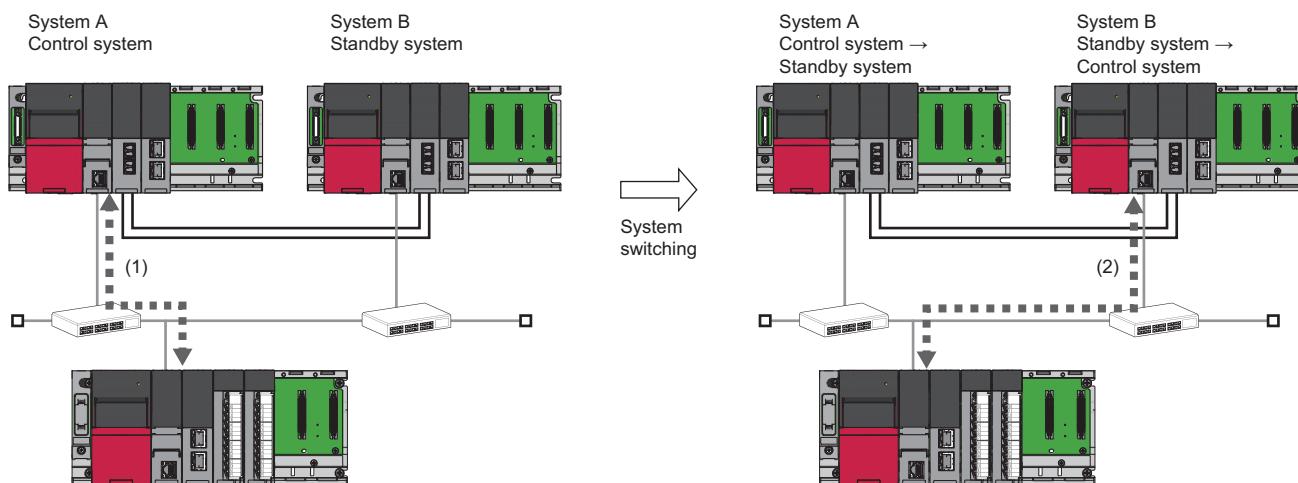

- (1) "IP Address" (system A) of "Own Node Settings" is used to communicate.
- (2) "System B IP Address" of "Redundant System Settings" is used to communicate.

Point

The CPU module (built-in Ethernet port part) cannot issue a system switching request.

To execute system switching when a communication error is detected, the communication error should be detected by a program that will execute the system switching instruction. For details on sample programs, refer to the following.

📖 MELSEC iQ-R Process CPU Module User's Manual

Setting method

■Own station Ethernet setting

For the Process CPU (redundant mode), set "IP Address" (system A) of "Own Node Settings" in "Basic Settings" and "System B IP Address" of "Redundant System Settings" in "Application Settings".

📖 Page 318 Own Node Settings

📖 Page 407 Redundant System Settings

■External device Ethernet setting

To set a redundant system IP address using the external device Ethernet settings (such as the SLMP setting and security setting), set both the system A IP address and system B IP address.

■Simple CPU communication setting

Refer to the following for this setting.

📖 Page 227 Setting procedure

📖 Page 336 Simple CPU communication setting (CPU module (built-in Ethernet port part))

■When the communication destination is the MELSEC-FX3 (Ethernet block/adaptor) or MELSEC-A/AnS (Ethernet module)

For the MELSEC-FX3 (Ethernet block/adaptor) or MELSEC-A/AnS (Ethernet module), the same port number cannot be set for different IP addresses. Therefore, for the communication settings, set a different port number to each IP address.

Ex.

Communication destination communication setting

	Protocol	Open System	Host Station Port No.	Destination IP Address	Destination Port No.	
For the system A →	1	UDP	MC Protocol	3001	192.168.3.39	2001
For the system B →	2	UDP	MC Protocol	3002	192.168.3.41	2002
	3					
	4					

Set communication separately for system A and system B, according to the communication settings of the external device.

Ex.

Process CPU (redundant mode) simple CPU communication setting

Setting No.	Communication Pattern	Communication Setting: Execution Interval(ms)	Communication Destination (IP Address)	
			Source	Destination
1	Read	Fixed	100	MELSEC-FX3 (Ether)(192.168.3.50) → Host Station(192.168.3.39)
2	Read	Fixed	100	MELSEC-FX3 (Ether)(192.168.3.50) → Host Station(192.168.3.39)
3				

Setting No.1 (setting for the system A)

Item	Setting
IP Address Input Format	DEC
Device Type	MELSEC-FX3 (Ethernet Block/Adapter)
IP Address	192.168.3.50
TCP/UDP	UDP
Port No.	3001
Host Station Port No.	2001
<i>Options(Hexadecimal)</i>	

Setting No.2 (setting for the system B)

Item	Setting
IP Address Input Format	DEC
Device Type	MELSEC-FX3 (Ethernet Block/Adapter)
IP Address	192.168.3.50
TCP/UDP	UDP
Port No.	3002
Host Station Port No.	2002
<i>Options(Hexadecimal)</i>	

(1) When specifying the same communication destination, set different own station port numbers.

After the above setting operation, communication is performed using setting No.1 when system A is the control system, and setting No.2 when system B is the control system.

Operation

For the Process CPU (redundant mode) simple CPU communication, communication with external devices is performed by the control system only, regardless of the operation mode.

- Communication is not performed if the system is not yet assigned or by the standby system.
- Communication stops temporarily during system switching. After system switching is completed, the new control system restarts communicating with the external device.
- Communication is performed by connecting to the external device using the system A IP address and system B IP address.

Point

For a program that was executed in both systems, to write the operation results of execution in the standby system of the Process CPU (redundant mode) to the communication destination, write the operation results to the control system device by executing the CONTWR(P) instruction with the program executed in both systems on the standby system, and then write the results to the communication destination device from the control system by using the simple CPU communication function.

■Operation at power-on (system not yet assigned)

At power-on, after the Ethernet port is initialized according to the simple CPU communication setting parameters, the state of preparing (waiting for a system to be assigned) arises and continues until a system is assigned, and simple CPU communication does not start for that duration. Measurement of the latency time does not start until a system is assigned.

■Operation after a system is assigned

After a system is assigned, the control system starts measuring the latency time, and after the latency time elapses, it starts the simple CPU communication.

Ex.

Operation of the control system (for setting No.1)

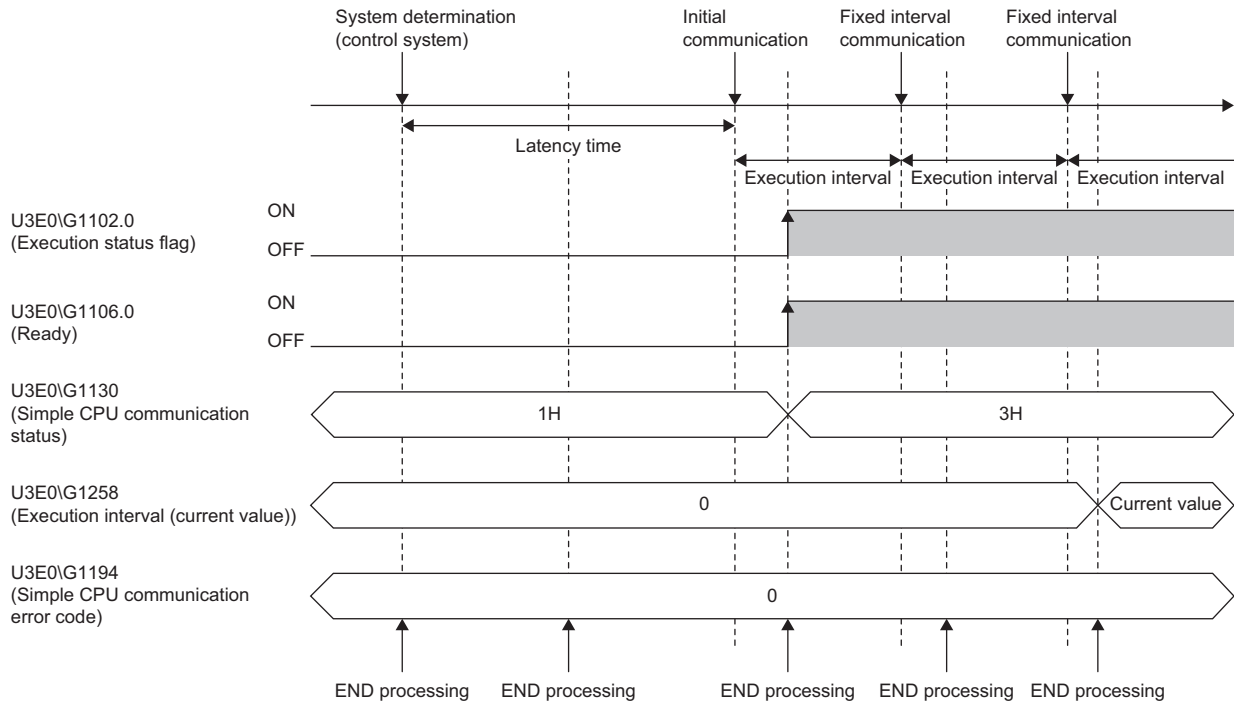

The standby system does not start simple CPU communication, even after the latency time elapses, and stands by until it becomes the control system due to system switching.

■ Operation during system switching

When system switching occurs, the simple CPU communication of the old control system is interrupted, and simple CPU communication of the new control system is started, to continue communication with the external device. (However, if system switching fails, the simple CPU communication of the control system is not interrupted.)

In addition, even if the simple CPU communication status is AH (communications impossible), as long as communications are possible when the standby system switches to the control system, the simple CPU communication restarts.

Ex.

When the system switches from the control system to the standby system (for setting No.1)

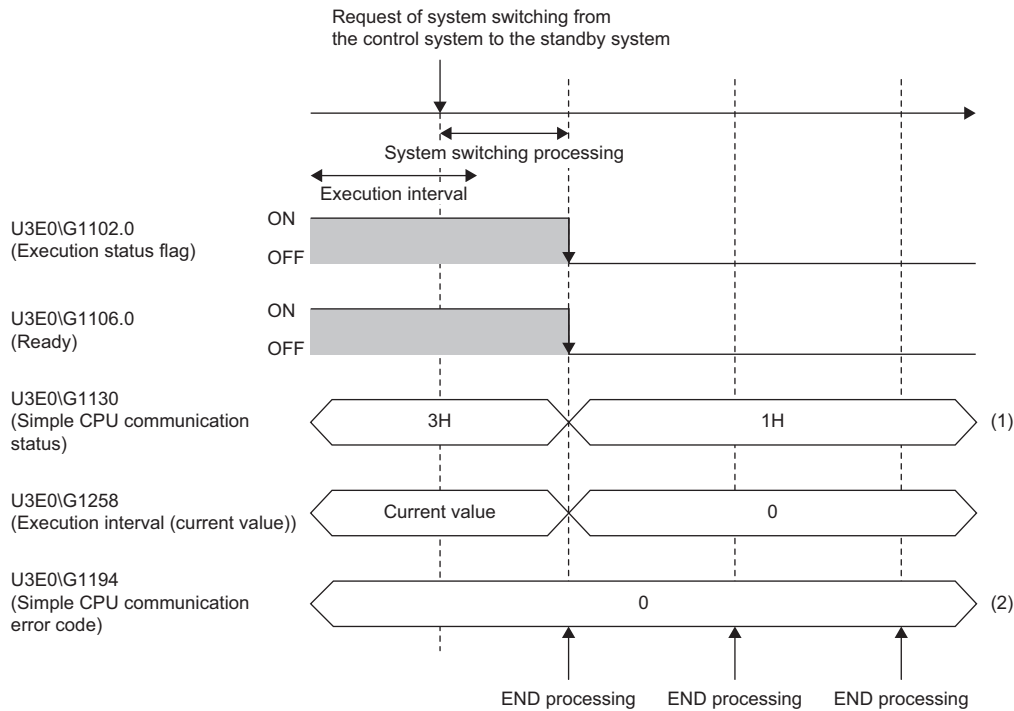

(1) When the status before system switching is 0H (unset), 1H (preparing), or AH (communications impossible), the status is not updated. Otherwise, the status becomes 1H (preparing) at the time of system switching.

(2) Diagnostic information before system switching is held.

Ex.

When the system switches from the standby system to the control system (for setting No.1)

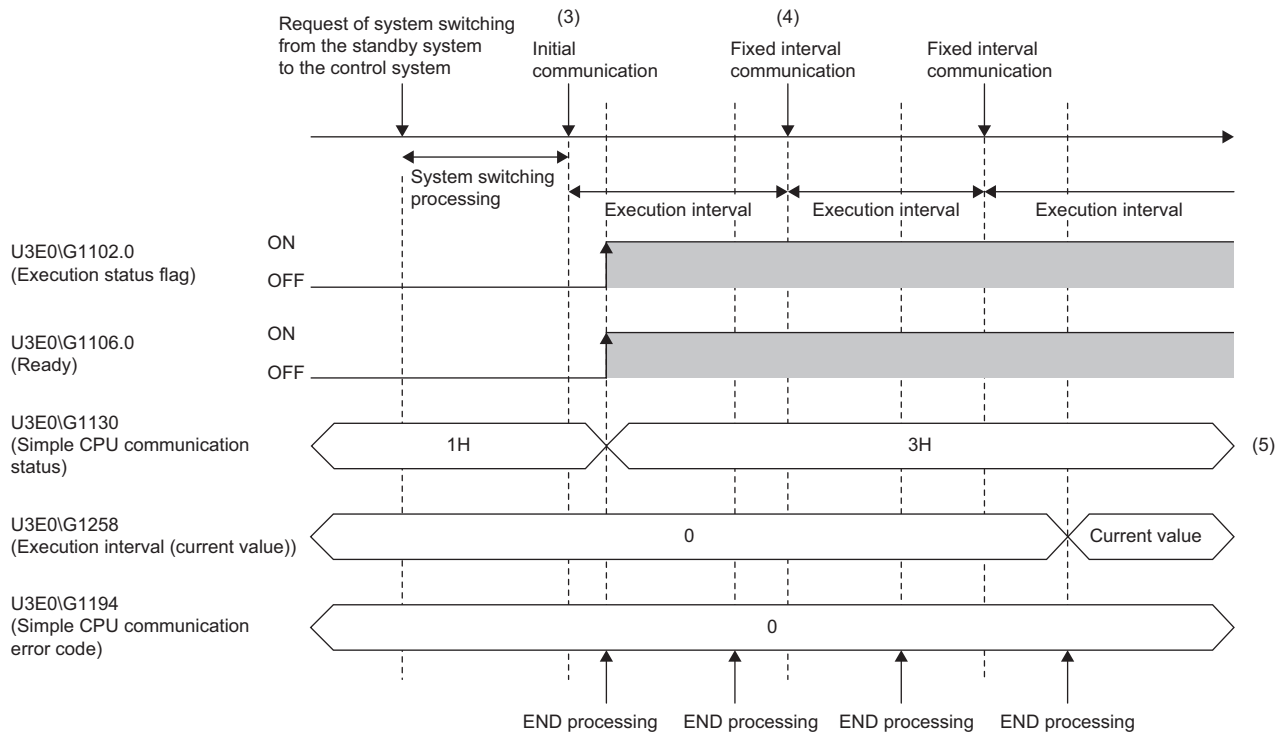

- (3) When the standby system becomes the control system while waiting for communications to start, measurement of the latency time continues, and when the latency time elapses, the simple CPU communication starts.
- (4) Measurement of the execution interval for fixed interval communication starts from point 0 after system switching is completed. For that reason, the first fixed interval communication is performed after both system switching and after the set execution interval elapses.
- (5) The status is updated according to the communication status of the first communication. However, when communication was stopped in the old control system, the status becomes 4H (communication stop).

Communication stop and restart request

For the Process CPU (redundant mode), only the control system can stop communication and make a restart request. When communication is stopped or a restart request is made by the standby system or while the system is not yet assigned, the request is ignored, and the stop request/restart request for the corresponding setting No. in the CPU buffer memory is turned off automatically. If system switching occurs while communication is stopped, the stop status of the old control system is transferred to the new control system.

Precautions

This section provides precautions for the simple CPU communication function.

Incomplete data reception and timeout

Because the load of Ethernet communication becomes heavy during the simple CPU communication, if the other communication (MELSOFT connection or SLMP) is simultaneously performed by using UDP, the data reception of UDP may not be completed, resulting in a timeout error. Therefore, to perform other communications during the simple CPU communication, the communication using TCP is recommended.

Execution interval setting

The execution interval (Communication Setting: "Fixed Interval") and the time until communication completion (Communication Setting: "On Request") in the simple CPU communication function will differ according to the load rate of the Ethernet line, operating status of other communication functions (such as MELSOFT connection, SLMP communication, socket communication function, CC-Link IE Field Network Basic), scan time of the communication destination, and system configuration. Thus, the set execution interval or time required for completing the communications may be increased. To perform communications at the set execution interval, set a sufficient execution interval. If checking the execution interval is required, perform actual communications and check it with the "Simple CPU Communication Diagnostics" window.

Duplication of own station port numbers

The simple CPU communication cannot be performed in the following cases.

- The own station port number set in the simple CPU communication and the own station port number of the CPU module set in the external device configuration are the same.
- The own station port number set in the simple CPU communication and the one set in another function such as the socket communication are the same.

Set different own station port numbers. For the setting numbers other than the one in which a communication error occurs, communications are performed after the preparation processing is completed normally.

Module type and IP address of communication destination

Check the module type and IP address of the communication destination before setting the parameters. The simple CPU communication is not performed when the preparation processing is not completed because the communication destination does not exist or an incorrect module type or IP address is specified.

Communication destination device

Check the type and range of the device to be read or written in the communication destination.

Especially, when "Write" is set to "Communication Pattern", the control data of the communication destination may be overwritten, resulting in malfunction.

Remote password

The simple CPU communication is not performed when a remote password is set for the communication destination. Clear the remote password.

Same communication destination setting

If multiple setting numbers are set for the same communication destination and an error occurs in one of the settings, the error also occurs in other setting numbers set for the same communication destination, resulting in the disabling of communications.

If an error occurs in a module set to "Fixed Interval" during communications and "6H: monitoring" in Simple CPU communication status of the setting number while both "Fixed Interval" and "On Request" are set in the "Communication Setting", the communication will not start even when Request to start communication at request of the error setting number is turned on.

However, Simple CPU communication status of the setting number, where "Communication Setting" is set to "Fixed Interval", is either "4H: communication stop" or "AH: communications impossible", the communication will start by turning on Request to start communication at request of the setting number where "Communication Setting" set to "On Request".

In addition, when the RnPCPU (in redundant mode) is used, an individual IP address is set for each Ethernet port of the system A and B, where the MELSEC-FX3 (Ethernet block/adaptor) or MELSEC-A/AnS (Ethernet module) is set as the same communication destination. Therefore, an error will not be detected between such communication settings.

File register (R, ZR)

When using the file register (R, ZR) for the device on the own station, always assign the device within the setting range. The simple CPU communication of the setting number which exceeds the setting range due to a stop error of the own station cannot be performed.

When a stop error occurs, communications continue for the setting numbers that do not exceed the setting range and those with a different communication destination.

Special relay (SM) and special register (SD)

Do not write any data to the special relay (SM) and the special register (SD) that are set on the system side. Doing so may cause a system failure or communication failure.

When the communication destination in a redundant system

In this case, use "Control System IP Address" of "Redundant System Settings" for the Process CPU (redundant mode) side, and set the control IP address on the "Communication Destination Setting" window in the simple CPU communication.

Redundant system latency time

For the Process CPU (redundant mode), each system measures the latency time separately. For that reason, when the control system is started up first, then if the standby system is started and system switching occurs before the latency time elapses, regardless of the elapsed latency time for the old control system, the new control system waits before starting communications. The waiting time for communications to start may become twice the latency time at the maximum.

Redundant system restrictions

- If system switching occurs due to an operation error in the control system program, before system switching is completed, the operation result (device value) immediately after the occurrence of the operation error may be written to the external device.
- For the built-in Ethernet of a CPU module, even if a communication error is detected, system switching by the system is not executed. To execute system switching when a communication error is detected, the communication error should be detected by a program that will execute the system switching instruction. For details on sample programs, refer to the following.

 MELSEC iQ-R Process CPU Module User's Manual

1.16 Simple Device Communication Function

This function allows data communications following the protocol of the Ethernet-connected communication destination only by making simple settings of the RJ71EN71 and RnENCPU (network part) from an engineering tool.

Use this function for communicating device-specific information (memory areas) with an external device (such as an industrial robot).

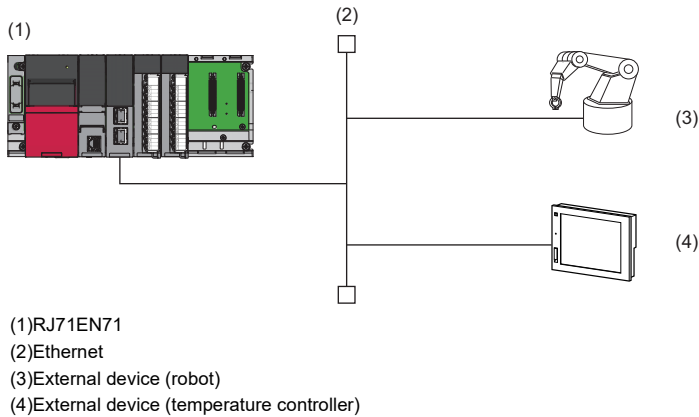

Restriction

Before using the simple device communication function, check the versions of the module and engineering tool used. (☞ Page 285 Restrictions applicable depending on versions)

Setting procedure

The following section describes the settings for using this function.

1. Register a simple device communication library file into the simple device communication library, if such a file is obtained. (☞ Page 252 Registration into simple device communication library)
2. Set the simple device communication setting. (☞ Page 253 Simple device communication setting)
3. After completing the settings, write the module parameters to the CPU module of the own station, and reset or power off and on the CPU module to start the simple device communication.

Point

For the simple device communication library file, please consult your local Mitsubishi representative.

Registration into simple device communication library

1. From the menus of the engineering tool, perform registration into the simple device communication library.
 [Tool] ⇒ [Register Simple Device Communication Library]
2. Select a simple device communication library file (*.sdcl) of the external device that should be newly added or whose protocol information should be updated, and then click the [Open] button.

Point

- When a file to be newly added is selected, a selectable external device (manufacturer, device type, and model) is added.
- When a file whose protocol information should be updated (file of the same model as the file that has been already registered) is selected, the existing registration is overwritten with new registration and the protocol is added.
- For details on the protocol for each manufacturer, refer to the following.

 MELSEC iQ-R Simple Device Communication Library Reference Manual

Simple device communication setting

1. Set "Use" for "To Use or Not Use Simple Device Communication" in "Simple Device Communication Setting" under "Application Settings".

[Navigation window] ⇒ [Parameter] ⇒ [Module Information] ⇒ [RJ71EN71] ⇒ [Port 1 Module Parameter (Ethernet)] ⇒ [Application Settings] ⇒ [Simple Device Communication Setting]

2. Set "Resource Setting", "Instruction Initial Value to Start/Stop Function", and "CPU Response Monitoring Timer" if necessary.

If "Resource Setting" is set to "Extension 1", set "To Use or Not Use Simple Device Communication" of the other ports to "Not Use".

3. From the window that can be displayed by the following operation, set "Communication Destination Setting". (☞ Page 340 "Communication Destination Setting" window)

[Navigation window] ⇒ [Parameter] ⇒ [Module Information] ⇒ [RJ71EN71] ⇒ [Port 1 Module Parameter (Ethernet)] ⇒ [Application Settings] ⇒ [Simple Device Communication Setting] ⇒ [Communication Destination Setting] ⇒ [Detailed Setting]

Setting Item

Latency Time

Latency Time s (0s to 255s)

Import/Export of Settings

Enable	Setting No.	Setting Method	Manufacturer	Device Type	Model	IP Address	Port No.		TCP/UDP	Protocol Setting	Comment
							Host Station	Communication Destination			
<input type="checkbox"/>	1										
<input type="checkbox"/>	2										
<input type="checkbox"/>	3										
<input type="checkbox"/>	4										
<input type="checkbox"/>	5										
<input type="checkbox"/>	6										
<input type="checkbox"/>	7										
<input type="checkbox"/>	8										
<input type="checkbox"/>	9										

Explanation

Show the settable number of communication destinations.
 Able to set communication destination to any No.
 (Able to set random No.)

Check

Restore the Default Settings

Apply

4. From the window that can be displayed by the following operation, check "Device List". (☞ Page 390 "Device List" window)

[Navigation window] ⇒ [Parameter] ⇒ [Module Information] ⇒ [RJ71EN71] ⇒ [Port 1 Module Parameter (Ethernet)] ⇒ [Application Settings] ⇒ [Simple Device Communication Setting] ⇒ [Device List] ⇒ [Confirmation]

The screenshot shows a software window titled "Setting Item" with a blue header. Below the header, there is a "Device Text Color" section with two buttons: "Black" and "Magenta". To the right of these buttons are two radio button options: "Device Duplication Found" and "No Device Duplication". A "Create List" button is located to the right of the "No Device Duplication" option. Below this section is a table with the following columns: Device, Category, Port, Setting No., Protocol No., Protocol Name, Packet No., Packet Name, Element No., and Element Name. The table body is currently empty. Below the table is an "Explanation" section with a blue header and the text "Show the list of devices used for simple device communication." At the bottom of the window, there are three buttons: "Check", "Restore the Default Settings", and "Apply".

Devices that can be specified

For devices that can be specified, the size of a device is specified in units of 16 points for a bit device and one point for a word device. Use 0 or multiples of 16 to specify the device number of a bit device.

The following table lists the maximum number of points when the NZ2MC-16MBS is connected to the R120CPU. The number of points differs depending on the CPU module used, whether to use or not an extended SRAM cassette, or the type of the extended SRAM cassette.

Type	Applicable device		
	Symbol	Range	Remarks
Bit device	X	0H to 2FFFH	—
	Y	0H to 2FFFH	—
	M	0 to 161882111	A local device cannot be specified.
	L	0 to 32767	—
	B	0H to 9A61FFFH	—
	SB	0H to 9A61FFFH	—
	SM	0 to 4095	—
Word device	D	0 to 10117631	A local device cannot be specified.
	W	0H to 9A61FFFH	—
	SW	0H to 9A61FFFH	—
	SD	0 to 4095	—
	R	0 to 32767	Data is read or written following the file register settings of the communication destination.
	ZR	0 to 10027007	Data is read or written following the file register settings of the communication destination.
	RD	0 to 1048575	—
	G	<ul style="list-style-type: none"> • P1: 722500 to 1246787 • P2: 2722500 to 3246787 	Buffer memory for the RJ71EN71 or RnENCPU (network part). A G device is expressed as Un\Gn device. To search for a device, specify the Un\Gn device. When the search for a G device is attempted while the RJ71EN71 or RnENCPU is not mounted, the device will be searched for with U0\Gn. No error message appears for indicating that the RJ71EN71 or RnENCPU is not mounted.

Checking the simple device communication status

The simple device communication status can be checked with the buffer memory areas.

 Page 506 Simple device communication area

Communication example

Use the simple device communication function and execute the protocol of RD: Read CPU operating status for the CR800-R to read the operating status of the CPU module.

System configuration

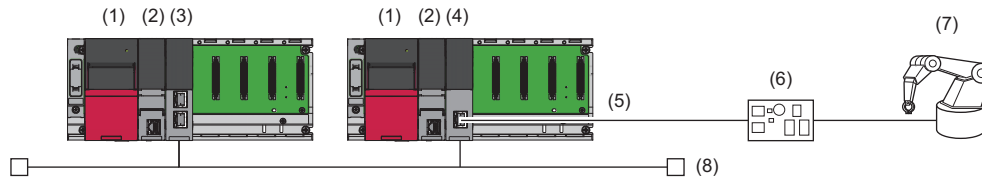

- (1) Power supply module (R61P)
- (2) CPU module (R04CPU)
- (3) RJ71EN71 (IP address: 192.168.0.10)
- (4) R16RTCPU (IP address: 192.168.0.20)
- (5) SSCNET III/H
- (6) Robot controller
- (7) Robot
- (8) Ethernet

Parameter settings

Settings for request source

- Set the CPU module in the following window.

[Project] ⇒ [New]

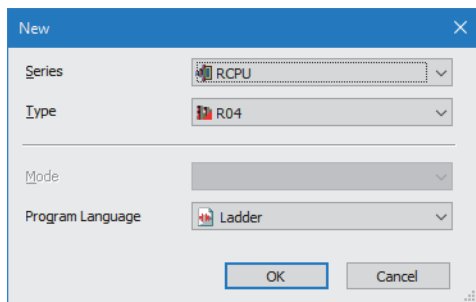

- Click the [Setting Change] button and set to use module labels.
- Click the [OK] button to add the module labels of the CPU module.

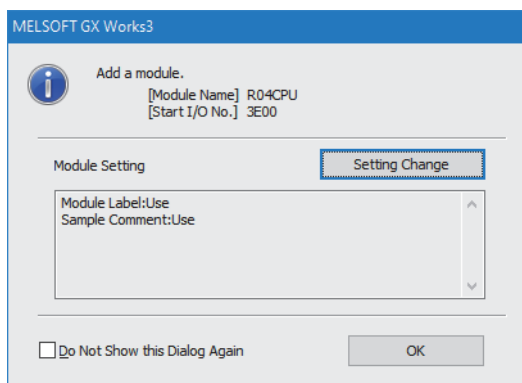

4. Set the RJ71EN71 as follows.

[Navigation window] ⇒ [Parameter] ⇒ [Module Information] ⇒ Right-click ⇒ [Add New Module]

5. Click the [OK] button to add the module labels of the RJ71EN71.

6. Set the items in "Basic Settings" as follows.

[Navigation window] ⇒ [Parameter] ⇒ [Module Information] ⇒ [RJ71EN71(E+E)] ⇒ [Port 1 Module Parameter (Ethernet)] ⇒ [Basic Settings] ⇒ [Own Node Settings]

Item	Setting
Own Node Settings	
Parameter Setting Method	Parameter Editor
IP Address	
IP Address	192 . 168 . 0 . 10
Subnet Mask
Default Gateway
Communications by Network No./Station No.	Disable
Setting Method	Use IP Address
Network No.	-----
Station No.	-----
Transient Transmission Group No.	0
Enable/Disable Online Change	Disable All (SLMP)
Communication Data Code	Binary
Opening Method	Do Not Open by Program

7. Set the items in "Application Settings" as follows.

[Navigation window] ⇒ [Parameter] ⇒ [Module Information] ⇒ [RJ71EN71(E+E)] ⇒ [Port 1 Module Parameter (Ethernet)] ⇒ [Application Settings] ⇒ [Simple Device Communication Setting]

Setting Item	Item	Setting
Simple Device Communication Setting		
	To Use or Not to Use Simple Device Communication Setting	Use
	Resource Setting	Normal
	Instruction Initial Value to Start/Stop Function	Start
	CPU Response Monitoring Timer	5
	Unit	s
	Communication Destination Setting	<Detailed Setting>
	Device List	<Confirmation>

8. Set the items in "Communication Destination Setting" in the following window.

[Navigation window] ⇒ [Parameter] ⇒ [Module Information] ⇒ [RJ71EN71(E+E)] ⇒ [Port 1 Module Parameter (Ethernet)] ⇒ [Application Settings] ⇒ [Simple Device Communication Setting] ⇒ [Communication Destination Setting] ⇒ [Detailed Setting]

Setting Item											
Latency Time		Import/Export of Settings									
Latency Time		0 s (0s to 255s)		Import		Export					
Enable	Setting No.	Setting Method	Manufacturer	Device Type	Model	IP Address	Port No.		TCP/UDP	Protocol Setting	Comment
							Host Station	Communication Destination			
<input checked="" type="checkbox"/>	1	Select from library	MITSUBISHI	Industrial robot	CR800	192.168.0.20	2000	45237	UDP	<Detailed Setting>	
<input type="checkbox"/>	2										

9. Click "Detailed Setting" on "Protocol Setting" to open the "Protocol Setting" window.

10. Delete protocols other than the protocol of RD: CPU Operating Status Read, and change "Comm Set" to "Request".

Protocol Setting												
Tree Display <<		Add Protocol		Total Number of Registered Protocols 5/256		Total Number of Registered Packets 15/768		Total Usage of Packet Data Area 0.9%				
Protocol No.	Protocol Name	Comm Set	Execution Interval (ms)	Communication Type	Received Data Verification Result	Send/Receive Parameter Setting	->Send <-Receive	Packet Name	Element No.	Element Type	Element Name	Element Setting
1	RD: DDEVVL* R	Request		Send&Receive		<Detailed Setting>	->	Request	1	Fixed Data	Subheader	(2B)/5000
									2	Fixed Data	Request Destinat.	(1B)/00
									3	Fixed Data	Request Destinat.	(1B)/FF
									4	Fixed Data	Request Destinat.	(2B)/FF03
									5	Fixed Data	Request Destinat.	(1B)/00
									6	Length	Data Length	(7-12)/HEX/Reverse/2B
									7	Fixed Data	Monitoring Timer	(2B)/0000
									8	Fixed Data	Command	(2B)/0104
									9	Fixed Data	Subcommand	(2B)/0000
									10	Fixed Data	Head D Device ...	(3B)/001000
									11	Fixed Data	Device Code (D)	(1B)/A8
									12	Fixed Data	Read Size (1)	(2B)/0100
							<(1)	Normal response	1	Fixed Data	Subheader	(2B)/0000
									2	Fixed Data	Request Destinat.	(1B)/00
									3	Fixed Data	Request Destinat.	(1B)/FF
									4	Fixed Data	Request Destinat.	(2B)/FF03
									5	Fixed Data	Request Destinat.	(1B)/00
									6	Length	Data Length	(7-8)/HEX/Reverse/2B
									7	Fixed Data	End Code	(2B)/0000
							<(2)	Error response	1	Fixed Data	Subheader	(2B)/0000
									2	Fixed Data	Request Destinat.	(1B)/00
									3	Fixed Data	Request Destinat.	(1B)/FF
									4	Fixed Data	Request Destinat.	(2B)/FF03
									5	Fixed Data	Request Destinat.	(1B)/00
									6	Length	Data Length	(7-10)/HEX/Reverse/2B

11. Click the [Device Batch Setting] button to open the "Device Batch Setting" window.

12. Set the items in "Device Batch Setting" in the following window.

13. Write the set parameters to the CPU module. Then reset the CPU module or power off and on the system.

[Online] ⇌ [Write to PLC]

Point

In this example, default values were used for parameters that are not shown above. For the parameter setting, refer to the chapter explaining the parameters in this manual. (Page 317 PARAMETER SETTINGS)

■ Settings for request destination

Set the parameters listed below for the communication destination.

Parameter name	Description	Setting value
NETIP	IP address	192.168.0.20
NETMSK	Subnet mask	255.255.255.0
NETGW	Default gateway	192.168.0.254
SLMPPORT	SLMP server communication port number	45237
SLMPCP	SLMP server communication port protocol • 0: TCP • 1: UDP	1
SLMPNWNO	SLMP network number	1
SLMPNDID	SLMP station number	1

Point

For steps to set the parameters, refer to the following.

CR800 series controller, CR750/CR751 series controller Ethernet Function Instruction Manual (BFP-A3379)

Program examples

Write the following program to the request source CPU module.

Classification	Label name	Description	Device																																																		
Module label	EN71_EE_1.stPort1.stConnectDevice[1].bReady_SimpleDevice_D	Setting No.1 ready	Un\G1249308.0																																																		
	EN71_EE_1.stPort1.stConnectDevice[1].uStatus_Connection_SimpleDevice_D	Setting No.1 connection status	Un\G1249309																																																		
	EN71_EE_1.stPort1.stConnectDevice[1].uErrorCode_SimpleDevice_D	Simple device communication error code for setting No.1	Un\G1249306																																																		
Label to be defined	Define global labels as shown below:																																																				
	<table border="1"> <thead> <tr> <th></th> <th>Label Name</th> <th>Data Type</th> <th>Class</th> <th>Assign</th> </tr> </thead> <tbody> <tr> <td>1</td> <td>uCR800_RespData</td> <td>Word [Unsigned]/Bit String [16-bit]</td> <td>VAR_GLOBAL</td> <td>D0</td> </tr> <tr> <td>2</td> <td>uCR800_ErrorResp</td> <td>Word [Unsigned]/Bit String [16-bit]</td> <td>VAR_GLOBAL</td> <td>D1</td> </tr> <tr> <td>3</td> <td>uRespCollationResult</td> <td>Word [Unsigned]/Bit String [16-bit]</td> <td>VAR_GLOBAL</td> <td>D100</td> </tr> <tr> <td>4</td> <td>bStartRequest</td> <td>Bit</td> <td>VAR_GLOBAL</td> <td>U0\G1249348.4</td> </tr> <tr> <td>5</td> <td>bComplete</td> <td>Bit</td> <td>VAR_GLOBAL</td> <td>U0\G1249380.4</td> </tr> <tr> <td>6</td> <td>bError</td> <td>Bit</td> <td>VAR_GLOBAL</td> <td>U0\G1249412.4</td> </tr> <tr> <td>7</td> <td>bSimpleDeviceStart</td> <td>Bit</td> <td>VAR_GLOBAL</td> <td>M0</td> </tr> <tr> <td>8</td> <td>uCPUStatus</td> <td>Word [Unsigned]/Bit String [16-bit]</td> <td>VAR_GLOBAL</td> <td>D10</td> </tr> <tr> <td>9</td> <td>uErrorCode</td> <td>Word [Unsigned]/Bit String [16-bit]</td> <td>VAR_GLOBAL</td> <td>D1000</td> </tr> </tbody> </table>		Label Name	Data Type	Class	Assign	1	uCR800_RespData	Word [Unsigned]/Bit String [16-bit]	VAR_GLOBAL	D0	2	uCR800_ErrorResp	Word [Unsigned]/Bit String [16-bit]	VAR_GLOBAL	D1	3	uRespCollationResult	Word [Unsigned]/Bit String [16-bit]	VAR_GLOBAL	D100	4	bStartRequest	Bit	VAR_GLOBAL	U0\G1249348.4	5	bComplete	Bit	VAR_GLOBAL	U0\G1249380.4	6	bError	Bit	VAR_GLOBAL	U0\G1249412.4	7	bSimpleDeviceStart	Bit	VAR_GLOBAL	M0	8	uCPUStatus	Word [Unsigned]/Bit String [16-bit]	VAR_GLOBAL	D10	9	uErrorCode	Word [Unsigned]/Bit String [16-bit]	VAR_GLOBAL	D1000		
	Label Name	Data Type	Class	Assign																																																	
1	uCR800_RespData	Word [Unsigned]/Bit String [16-bit]	VAR_GLOBAL	D0																																																	
2	uCR800_ErrorResp	Word [Unsigned]/Bit String [16-bit]	VAR_GLOBAL	D1																																																	
3	uRespCollationResult	Word [Unsigned]/Bit String [16-bit]	VAR_GLOBAL	D100																																																	
4	bStartRequest	Bit	VAR_GLOBAL	U0\G1249348.4																																																	
5	bComplete	Bit	VAR_GLOBAL	U0\G1249380.4																																																	
6	bError	Bit	VAR_GLOBAL	U0\G1249412.4																																																	
7	bSimpleDeviceStart	Bit	VAR_GLOBAL	M0																																																	
8	uCPUStatus	Word [Unsigned]/Bit String [16-bit]	VAR_GLOBAL	D10																																																	
9	uErrorCode	Word [Unsigned]/Bit String [16-bit]	VAR_GLOBAL	D1000																																																	

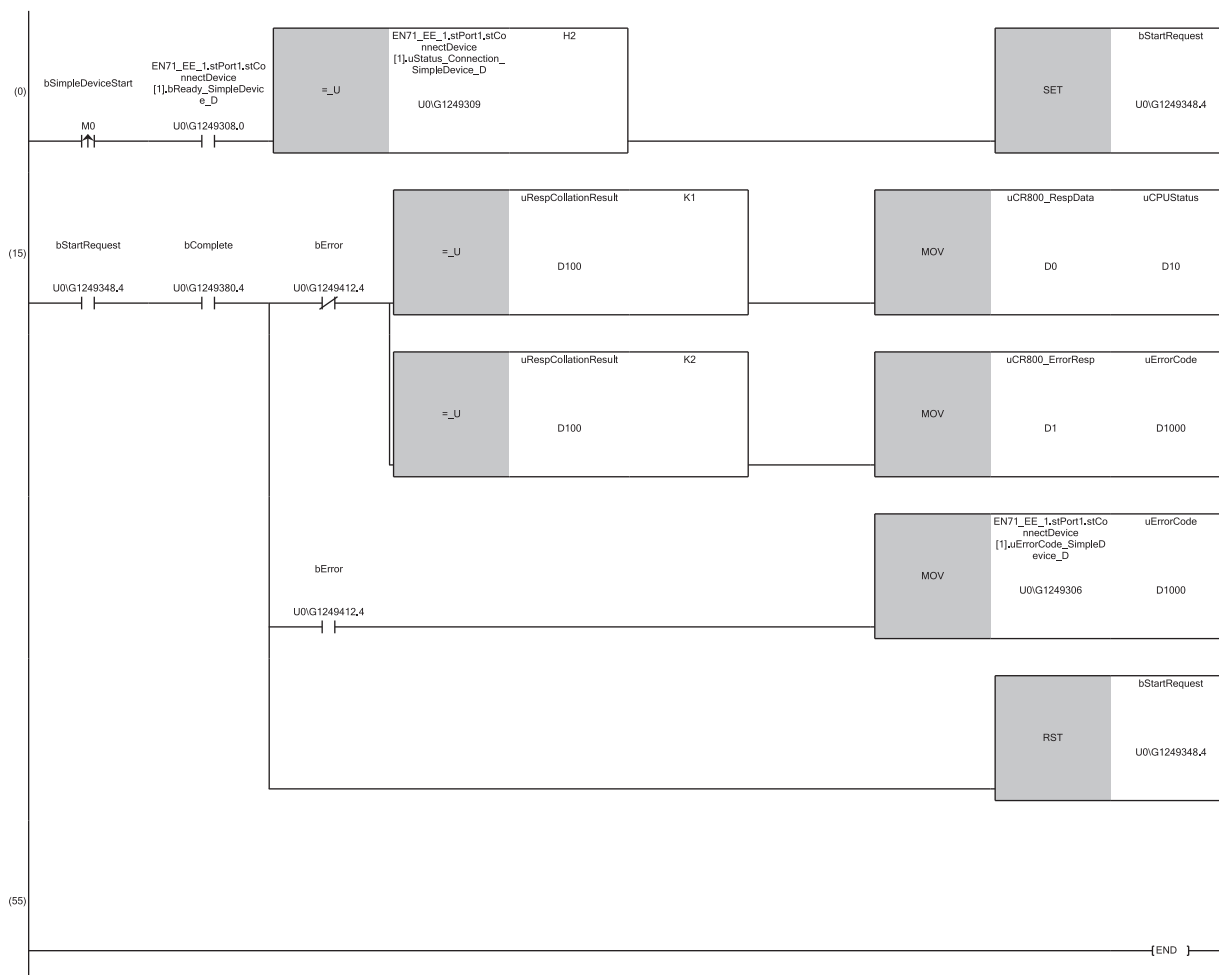

- (0) When 'Ready' (Un\G1249308.0) is on and also 'Status of connection' (Un\G1249309) is 2H (waiting for the request) for setting No.1, turning on the start instruction for the simple device communication (M0) turns on 'Start request for each protocol' (Un\G1249348.4) of the protocol number 5.
- (15) The existence of a response from the communication destination is judged from whether or not 'Execution completion for each protocol' (Un\G1249380.4) is turned on and also 'Error for each protocol' (Un\G1249412.4) is turned off for the protocol number 5. At this time, the response is judged as normal if the received data verification result (D100) for the protocol number 5 is 1H, and judged as error if the result is 2H. On the other hand, if 'Error for each protocol' (Un\G1249412.4) of the protocol number 5 is also turned on, the status is judged as that an error has occurred in the simple device communication function.

Operation

This function supports the communication methods listed below in combination of "Comm Set" and "Communication Type".

Comm Set	Communication Type	Communication method
Fixed Intrvl	Send & Receive	The RJ71EN71 or RnENCPU (network part) becomes a client and communicates data with the communication destination (server) at the fixed interval.
Fixed Intrvl	Send Only	The RJ71EN71 or RnENCPU (network part) sends data to the communication destination at the fixed interval.
Fixed Intrvl	Receive Only	The RJ71EN71 or RnENCPU (network part) constantly receives send data from the communication destination.
Request	Send & Receive	The RJ71EN71 or RnENCPU (network part) becomes a client and communicates data with the communication destination (server) only once on a request.
Request	Send Only	The RJ71EN71 or RnENCPU (network part) sends data to the communication destination only once on a request.
Request	Receive Only	The RJ71EN71 or RnENCPU (network part) receives send data from the communication destination only once on a request.

Unless otherwise specified, each timing chart is described using an example of the protocol number 1 of setting No.1 that is connected to P1.

Also, the timing charts whose "Communication Type" is not "Send Only" are described using an example of the case where the CPU module device is set only for "Device" of receive packets in the protocol setting.

Operation of own station before communication starts

■Normal operation (when "Instruction Initial Value to Start/Stop Function" is set to "Start")

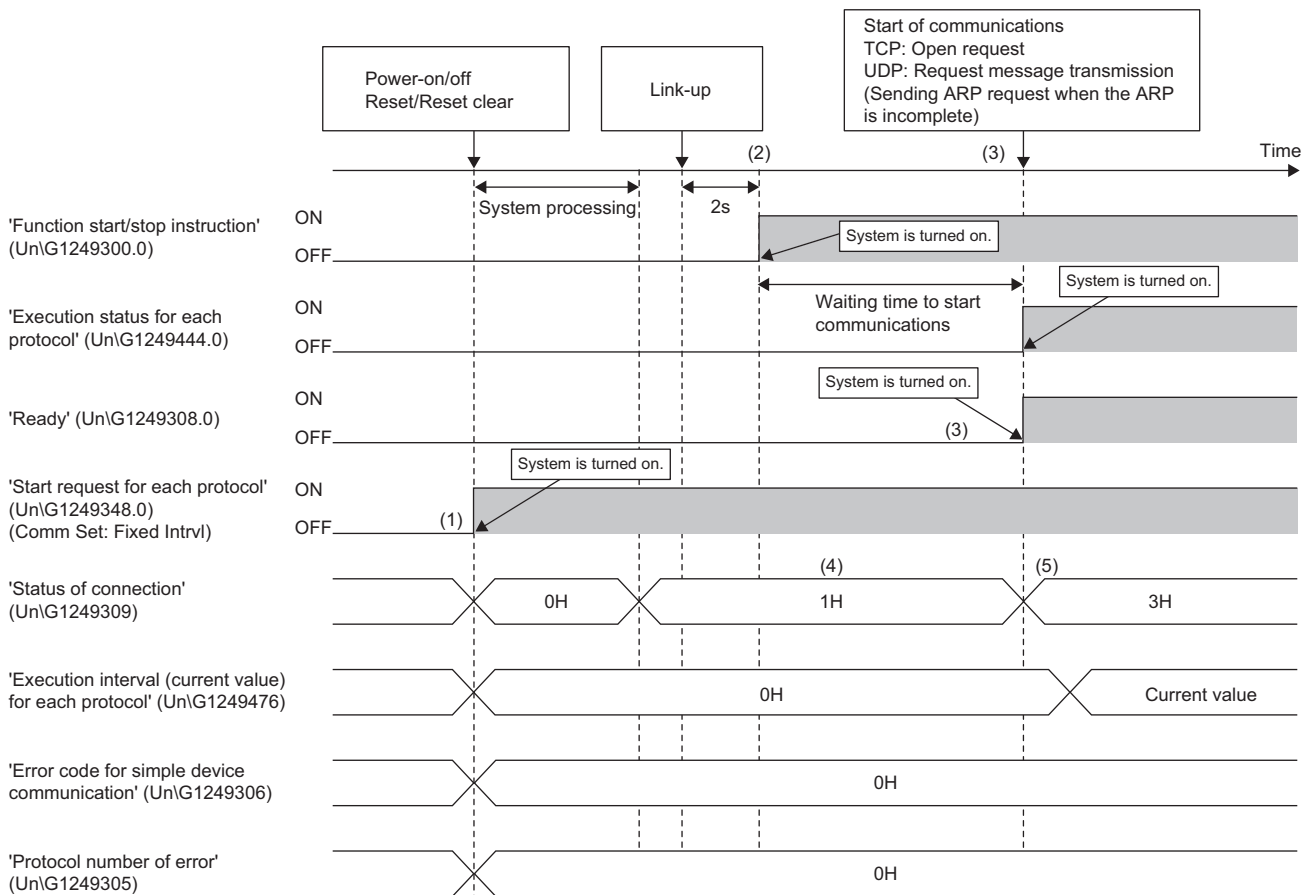

- (1) The own station performs the system processing (preparation processing) to be performed after the system is powered off and on or after the system is reset and the reset state is cleared. In this case, the default value of 'Start request for each protocol' (UnG1249348.0) is on (start) if the communication setting for each protocol is the fixed interval.
- (2) When the system processing is completed, the link-up is detected. Two seconds later, the measurement of the latency time starts. When "Instruction Initial Value to Start/Stop Function" is set to "Start", 'Function start/stop instruction' (UnG1249300.0) is turned on (enable).
- (3) After the latency time has elapsed, 'Ready' (UnG1249308.0) is turned on (ready), executing the data communication.
- (4) When the system processing is completed, 'Status of connection' (UnG1249309) becomes 1H (preparing).
- (5) When the latency time has elapsed, 'Status of connection' (UnG1249309) becomes 3H (communicating). The connection is opened at the time when 'Status of connection' (UnG1249309) becomes 3H (communicating).

■Normal operation (when "Instruction Initial Value to Start/Stop Function" is set to "Stop")

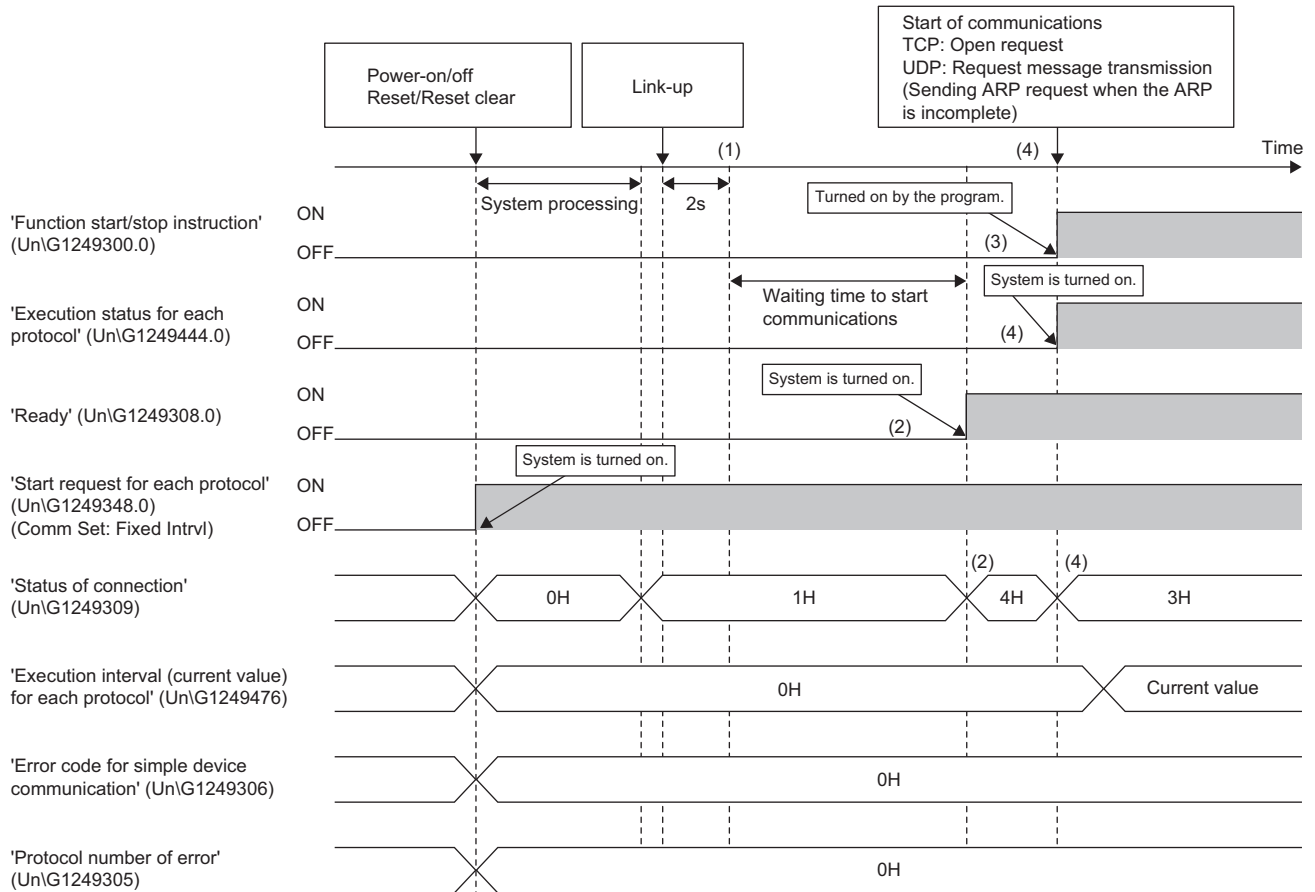

(1)When the system processing to be performed after the system is powered off and on or after the system is reset and the reset state is cleared is completed, the link-up is detected. Two seconds later, the measurement of the latency time starts.

(2)After the latency time has elapsed, 'Ready' (UnG1249308.0) is turned on (ready) and 'Status of connection' (UnG1249309) becomes 4H (function being stopped).

(3)At a desired timing, 'Function start/stop instruction' (UnG1249300.0) is turned on (enable).

(4)'Execution status for each protocol' (UnG1249444.0) is turned on (being executed) and 'Status of connection' (UnG1249309) becomes 3H (communicating), starting the communication with the communication destination. The connection is opened at the time when 'Status of connection' (UnG1249309) becomes 3H (communicating).

■Operation in error (Parameter error)

If a parameter error occurs when the module starts, the buffer memory area for simple device communications becomes 0 or is turned off.

When "Comm Set" is "Fixed Intrvl" and "Communication Type" is "Send & Receive"

■ Normal operation

- When read command is used

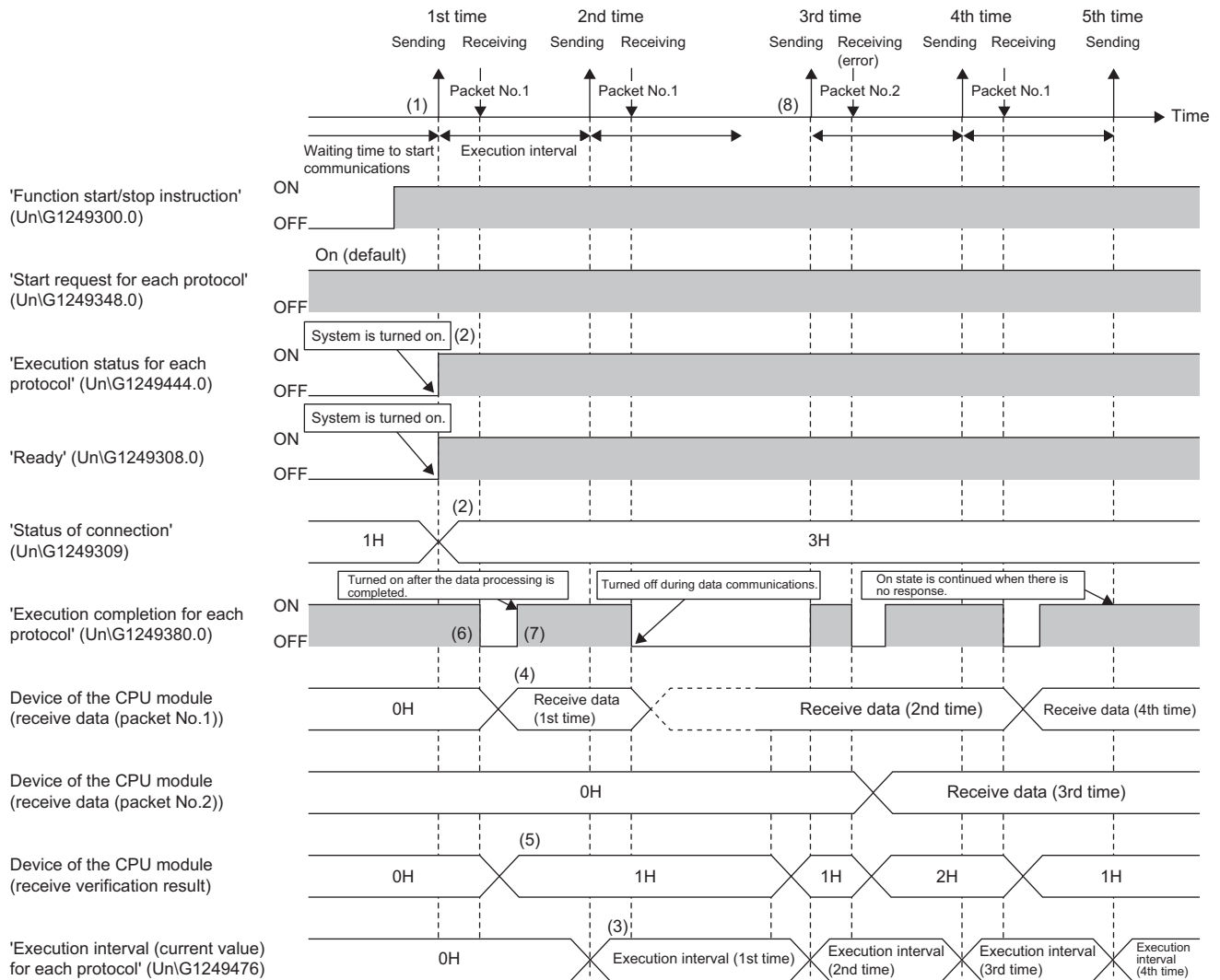

- (1) When the latency time has elapsed and if 'Function start/stop instruction' (Un\G1249300.0) is turned on (enable) and 'Start request for each protocol' (Un\G1249348.0) is turned on (start), the data communication is started.
- (2) When the data communication is started, 'Execution status for each protocol' (Un\G1249444.0) is turned on (being executed) and 'Status of connection' (Un\G1249309) becomes 3H (communicating).
- (3) When the request is sent to the communication destination and "Execution Interval (ms)" has elapsed, and if the response data is received from the communication destination, the actual execution interval is stored in 'Execution interval (current value) for each protocol' (Un\G1249476) and the data is sent.
- (4) For the read command (when the CPU module device is assigned in the response packet), the response data from the communication destination is received by the simple device communication processing of the own station and the CPU module device in the response packets that match the received response data is updated by the END processing.
- (5) At the same time, the packet number for which the verification matches is registered in the CPU module device that is set in "Received Data Verification Result". (If the verification mismatches, 0 is registered.)
- (6) 'Execution completion for each protocol' (Un\G1249380.0) is turned on (completed) after completion of the initial processing and turned off (not completed) during the update of the CPU module device.
- (7) After completion of the update, 'Execution completion for each protocol' (Un\G1249380.0) is turned on (completed). (If the CPU module device is assigned for each protocol, refer to the CPU module device using the on (completed) of 'Execution completion for each protocol' (Un\G1249380.0) as the interlock to prevent the receive data from being inconsistent.)
- (8) If the processing until the completion of general data update takes time more than the execution interval that is set, the next sending is immediately executed.

- When write command is used

For the write command (when the CPU module device is assigned in the request packet), the END processing is performed to send (transfer) the CPU module device of the own station to the system area for simple device communications. Then, the simple device communication processing is performed to send data of the system area to the communication destination at every execution interval.

While the write data is obtained from the CPU module device, 'Execution completion for each protocol' (Un\G1249380.0) is turned off (not completed). In this case, changing the value of the CPU module device may cause inconsistency in the write data. Update the CPU module device when 'Execution completion for each protocol' (Un\G1249380.0) is on (completed).

Point 

Since the simple device communication function cannot distinguish between normal responses and error responses, it continues to operate normally even if an error response is received.

■ Operation in error (TCP)

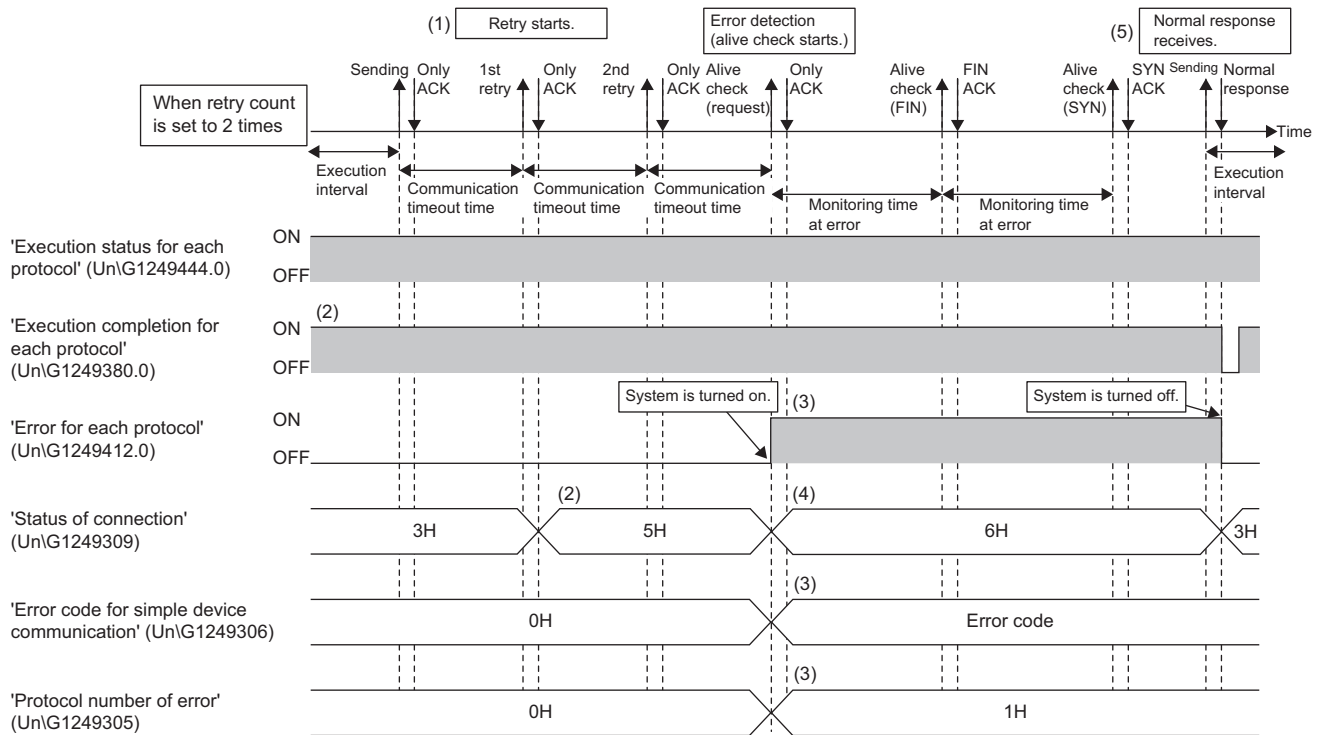

- (1) After data is sent to the communication destination, if only ACK is received without receiving any response data, the system makes retries (resends) when "Timeout Time" has elapsed.
- (2) During the retry, 'Status of connection' (UnG1249309) becomes 5H (retry being executed). In this case, 'Execution interval (current value) for each protocol' (UnG1249476) will not be updated. In addition, 'Execution completion for each protocol' (UnG1249380.0) will remain on (completed). (Communications stop also for other protocols of the same communication destination, but communications with the other communication destinations continue.)
- (3) Then, when the normal response cannot be received even if the data is sent for the number of "Timeout Retry Count Setting", "Timeout Time" elapses and then an error code is stored in 'Error code for simple device communication' (UnG1249306) and the protocol number of error is stored in 'Protocol number of error' (UnG1249305). Also, after 'Error for each protocol' (UnG1249412.0) is turned on (error), the fixed interval communication is performed during the monitoring time at error. (The system shifts to the alive check mode to send close requests/open requests at the fixed interval during "Monitoring Time At Error" (low speed cycle).)
- (4) During monitoring at error, 'Status of connection' (UnG1249309) becomes 6H (monitoring at error).
- (5) If any normal response from the communication destination is received during the monitoring at error (after the data is sent at the fixed interval in the low speed cycle), the system returns to the normal state (performs communications at "Execution Interval (ms)"). After the system returned to the normal state, 'Status of connection' (UnG1249309) becomes 3H (communicating).

■ Operation in error (UDP)

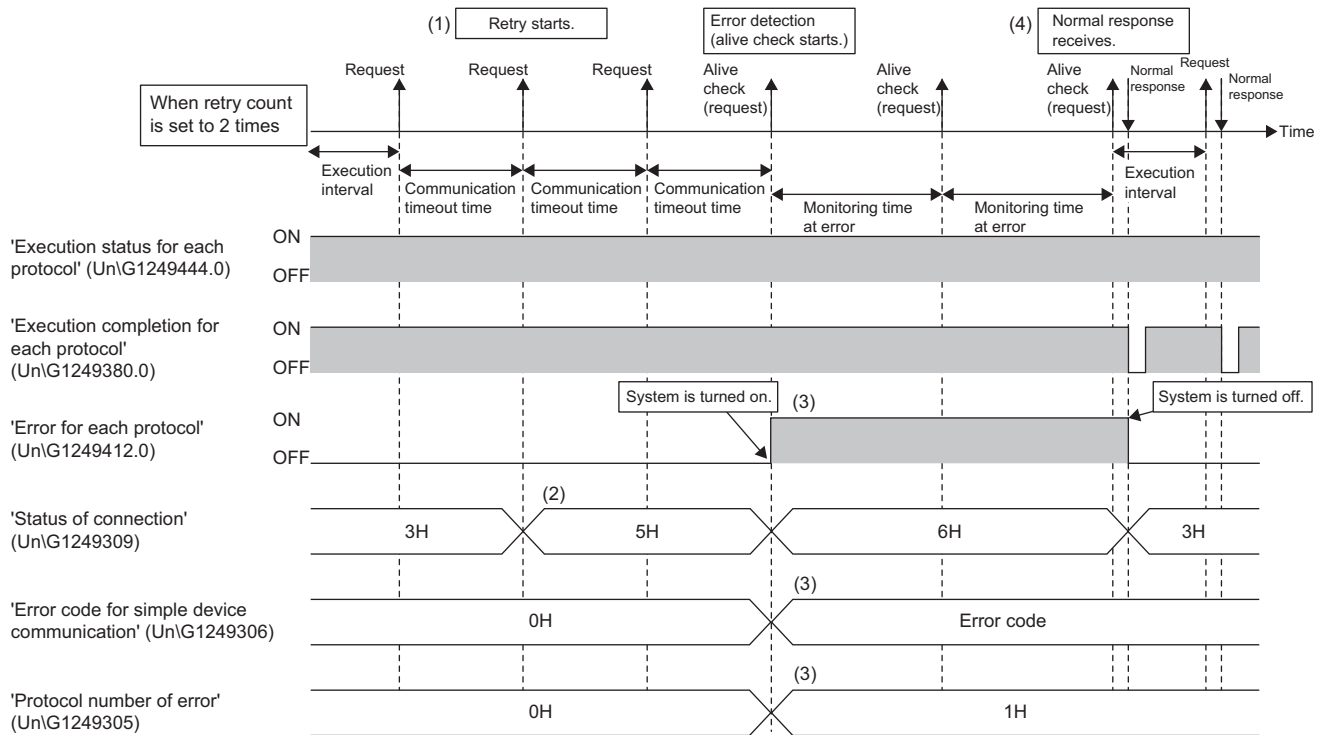

(1) After data is sent to the communication destination, if no response data is received, the system makes retries (resends) when "Timeout Time" has elapsed.

(2) During the retry, 'Status of connection' (Un\G1249309) becomes 5H (retry being executed). In this case, 'Execution interval (current value) for each protocol' (Un\G1249476) will not be updated. In addition, 'Execution completion for each protocol' (Un\G1249348.0) will remain on (completed). (Communications stop also for other protocols of the same communication destination, but communications with the other communication destinations continue.)

(3) Then, when the normal response cannot be received even if the data is sent for the number of "Timeout Retry Count Setting", "Timeout Time" elapses and then an error code is stored in 'Error code for simple device communication' (Un\G1249306) and the protocol number of error is stored in 'Protocol number of error' (Un\G1249305). Also, after 'Error for each protocol' (Un\G1249412.0) is turned on (error), the fixed interval communication is performed during the monitoring time at error.

(4) If any normal response from the communication destination is received during the monitoring at error (after the data is sent at the fixed interval in the low speed cycle), the system returns to the normal state (performs communications at "Execution Interval (ms)"). After the system returned to the normal state, 'Status of connection' (Un\G1249309) becomes 3H (communicating).

When "Comm Set" is "Fixed Intrvl" and "Communication Type" is "Send Only"

For the "Send Only" communication type, only the request packet can be set, and thus the operation for obtaining the value of the CPU module device before sending is shown.

Normal operation

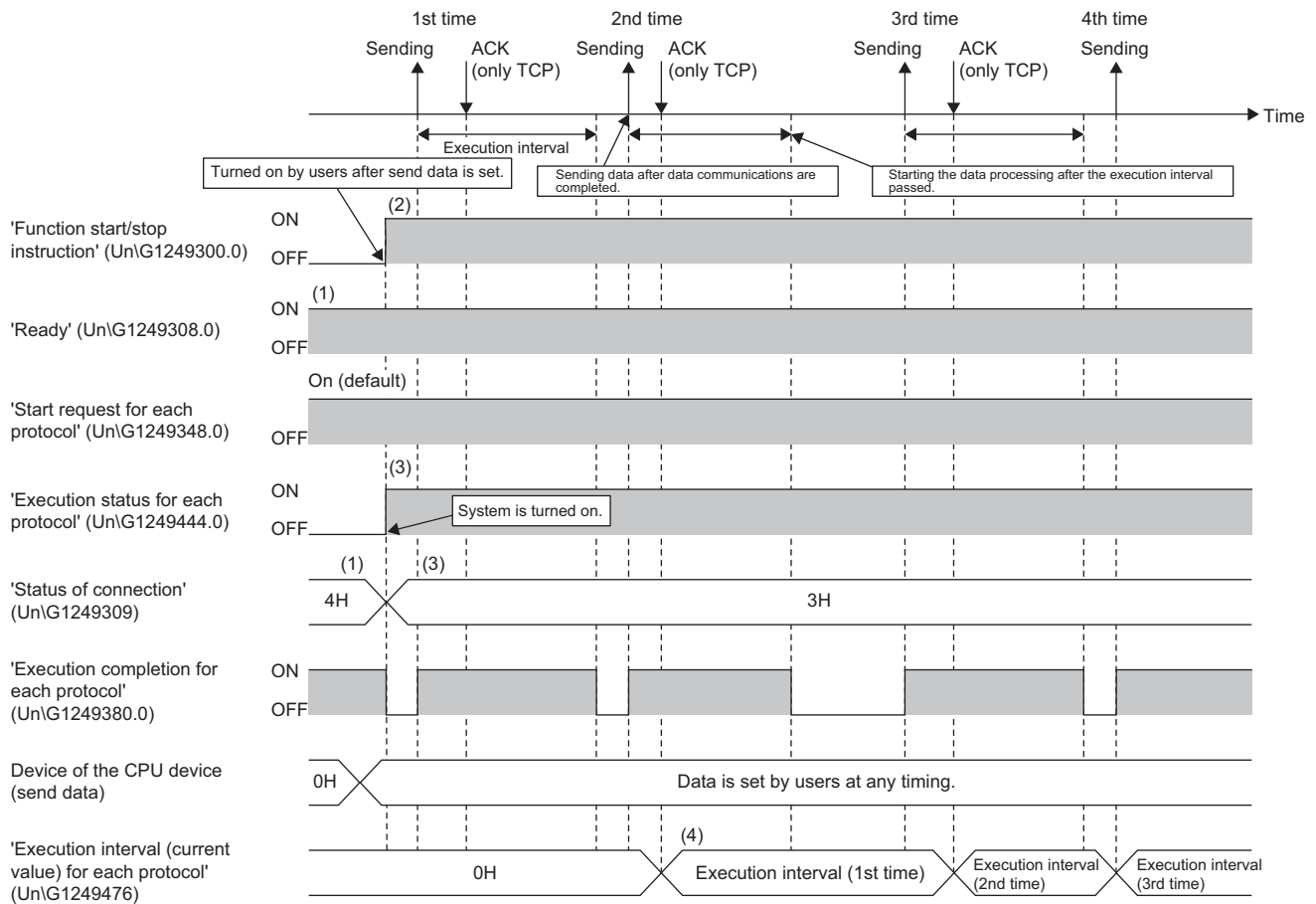

(1) When the system is powered off and on or the system is reset and the reset state is cleared and then the latency time has elapsed, 'Ready' (UnG1249308.0) is turned on (ready) and 'Status of connection' (UnG1249309) becomes 4H (function being stopped).

(2) Set data to be sent to the CPU module device to turn on (enable) 'Function start/stop instruction' (UnG1249300.0).

(3) When all 'Function start/stop instruction' (UnG1249300.0), 'Ready' (UnG1249308.0), and 'Start request for each protocol' (UnG1249348.0) are turned on, 'Execution status for each protocol' (UnG1249444.0) is turned on (being executed) and 'Status of connection' (UnG1249309) becomes 3H (communicating). When the data is sent successfully (for TCP, ACK is received), the first communication is completed.

(4) After "Execution Interval (ms)" has elapsed, the CPU module device is obtained and the data is sent. When the data is successfully sent, the actual execution interval is stored in 'Execution interval (current value) for each protocol' (UnG1249476).

While the write data is obtained from the CPU module device, 'Execution completion for each protocol' (UnG1249380.0) is turned off (not completed).

In this case, changing the value of the CPU module device may cause inconsistency in the write data.

Update the CPU module device when 'Execution completion for each protocol' (UnG1249380.0) is on (completed).

Operation in error (TCP)

The operation is the same as the case where "Comm Set" is "Fixed Intrvl" and "Communication Type" is "Send & Receive".

☞ Page 265 Operation in error (TCP)

When "Comm Set" is "Fixed Intrvl" and "Communication Type" is "Receive Only"

For the "Receive Only" communication type, only the response packet can be set, and thus the operation for updating the value of the CPU module device before receiving is shown.

Normal operation

'Execution interval (current value) for each protocol' (Un\G1249476) in the following figure indicates the receiving cycle. The maximum value to be stored is 65535ms. When the value exceeds the limit, "65535ms" is stored.

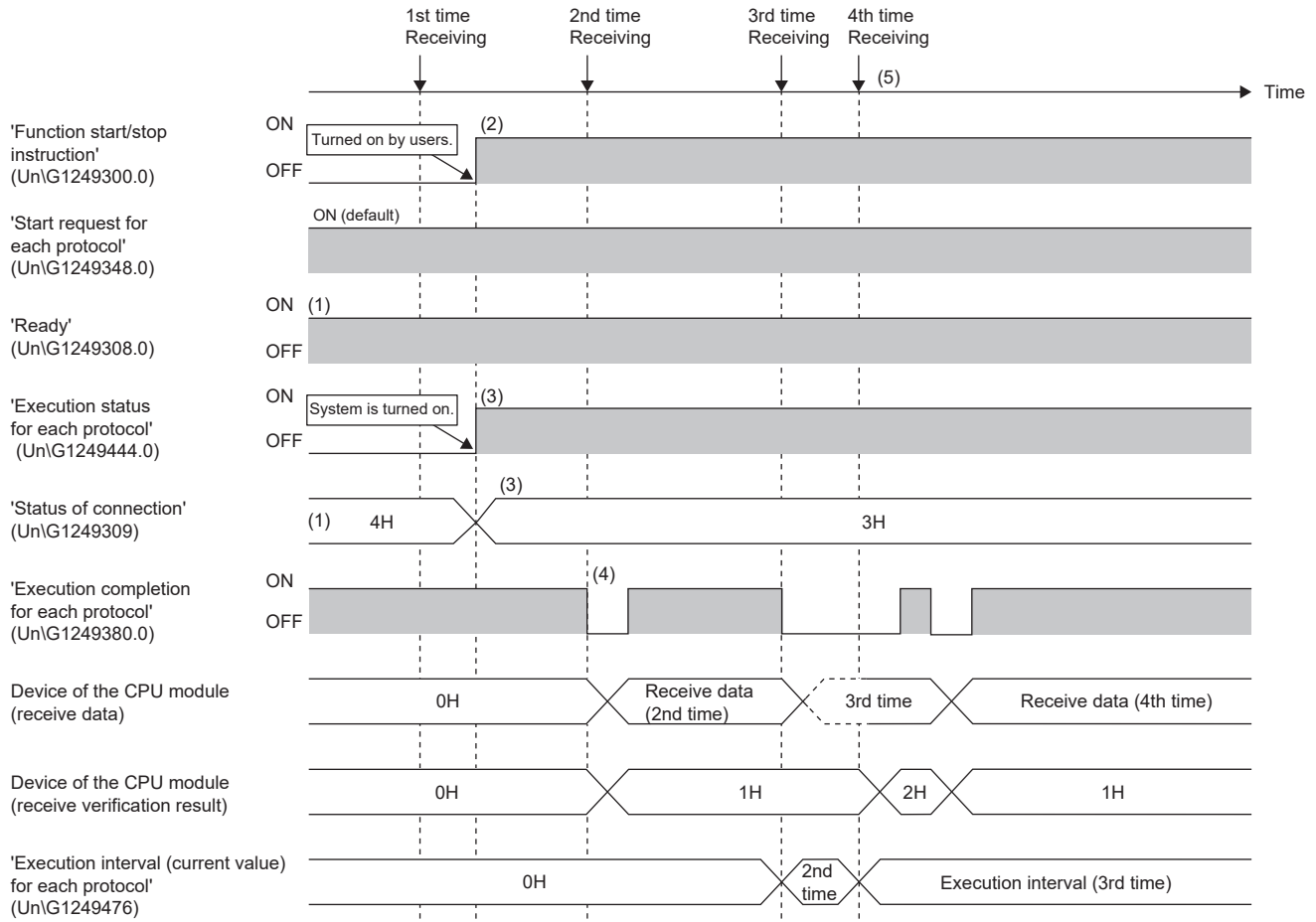

(1)When the system is powered off and on or the system is reset and the reset state is cleared and then the latency time has elapsed, 'Ready' (Un\G1249308.0) is turned on (ready) and 'Status of connection' (Un\G1249309) becomes 4H (function being stopped).

(2)After receiving has become ready, turn on (enable) 'Function start/stop instruction' (Un\G1249300.0).

(3)When all 'Function start/stop instruction' (Un\G1249300.0), 'Execution completion for each protocol' (Un\G1249348.0), and 'Ready' (Un\ G1249348.0) are turned on, 'Execution status for each protocol' (Un\G1249444.0) is turned on (being executed). At this point, 'Status of connection' (Un\G1249309) becomes 3H (communicating), then the module enters the receive data wait state. (The data that is received from the external device while 'Execution status for each protocol' (Un\G1249444.0) is off (communication stop) is discarded.)

(4)When data is received from the external device during the receive data wait state, 'Execution completion for each protocol' (Un\G1249380.0) is turned off (not completed), and the CPU module device is updated. After the update is completed, 'Execution completion for each protocol' (Un\G1249380.0) is turned on (completed), and the module enters the receive data wait state again. (By making a reference to the CPU module device using 'Execution completion for each protocol' (Un\G1249380.0) as the interlock, inconsistency in the received data can be prevented.)

(5)The data that is received while 'Execution status for each protocol' (Un\G1249444.0) is on (communicating) and also 'Execution completion for each protocol' (Un\G1249380.0) is off (not completed) is stored in the internal receive buffer. Then, the data is processed immediately after 'Execution completion for each protocol' (Un\G1249380.0) is turned on (completed).

Precautions

The receive data wait continues even when "Timeout Time" has elapsed without receiving data from the external device. In addition, if a close is detected during receive data wait in TCP, alive check will be executed at the interval of the monitoring time at error × 2 after the number of times in "Timeout Time" multiplied by "Timeout Retry Count Setting" has elapsed. (This symptom is not treated as an error.)

When "Comm Set" is "Request" and "Communication Type" is "Send & Receive"

Normal operation

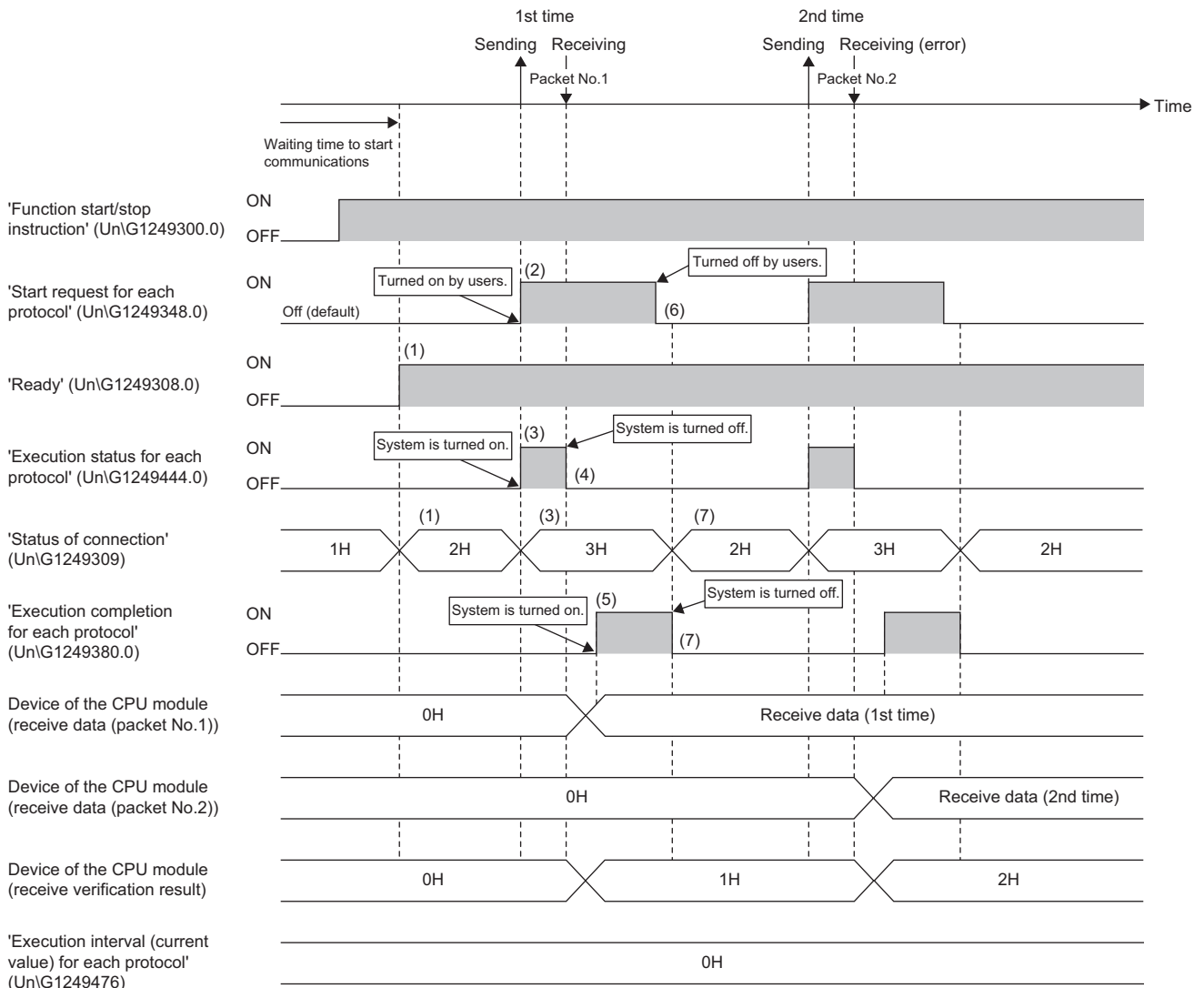

- (1) When the system is powered off and on or the system is reset and the reset state is cleared and then the latency time has elapsed, 'Ready' (Un\G1249308.0) is turned on (ready) and 'Status of connection' (Un\G1249309) becomes 2H (waiting for the request). Also, the default of 'Start request for each protocol' (Un\G1249348.0) will be off (stop).
- (2) Turn on (start) 'Start request for each protocol' (Un\G1249348.0) to start communications.
- (3) 'Execution status for each protocol' (Un\G1249444.0) is turned on (being executed) and 'Status of connection' (Un\G1249309) becomes 3H (communicating).
- (4) When any response data is received from the communication destination, 'Execution status for each protocol' (Un\G1249444.0) is turned off (communication stop).
- (5) When the update of the CPU module device is completed, 'Execution completion for each protocol' (Un\G1249380.0) is turned on (completed).
- (6) On (completed) of 'Execution completion for each protocol' (Un\G1249380.0) acts as a trigger for obtaining the value of the CPU module device and turning off (stop) 'Start request for each protocol' (Un\G1249348.0).
- (7) When 'Start request for each protocol' (Un\G1249348.0) is turned off (stop), 'Execution completion for each protocol' (Un\G1249380.0) is turned off (not completed) and 'Status of connection' (Un\G1249309) becomes 2H (waiting for the request). Also, 'Execution interval (current value) for each protocol' (Un\G1249476) is fixed to 0.

Precautions

If the system turns off and on 'Start request for each protocol' (Un\G1249348.0) before turning on (completed) 'Execution completion for each protocol' (Un\G1249380.0), the request will be ignored. (This symptom is not treated as an error.)

■ Operation in error (TCP)

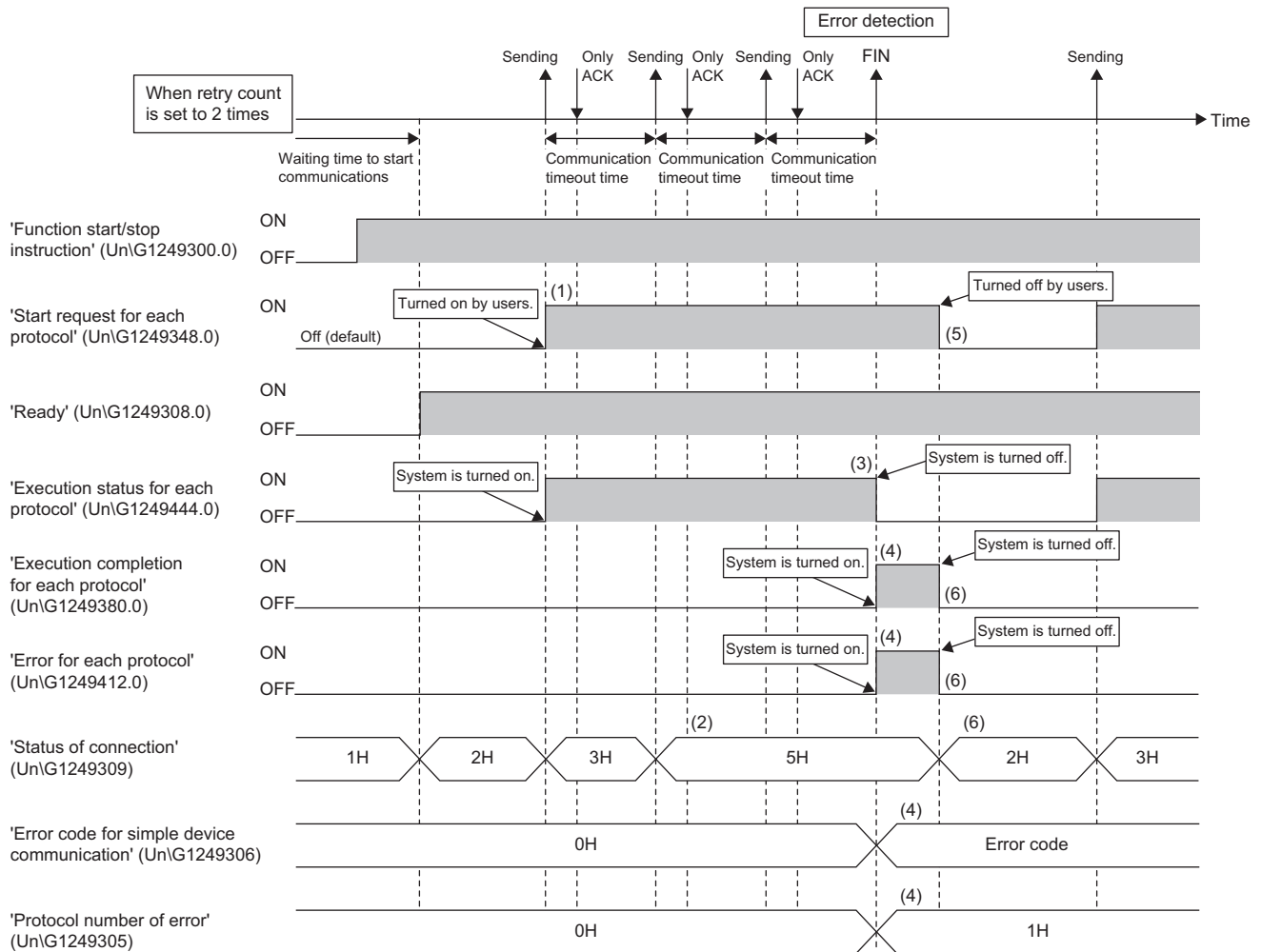

(1) Turn on (start) 'Start request for each protocol' (Un\G1249348.0).

(2) If no response is received even when "Timeout Time" has elapsed, 'Status of connection' (Un\G1249309) becomes 5H (retry being executed).

(3) Then, when the normal response cannot be received even if the data is sent for the number of "Timeout Retry Count Setting", 'Execution status for each protocol' (Un\G1249444.0) is turned off (communication stop).

(4) An error code is stored in 'Error code for simple device communication' (Un\G1249306) and the protocol number of error is stored in 'Protocol number of error' (Un\G1249305). Also, after 'Execution completion for each protocol' (Un\G1249380.0) and 'Error for each protocol' (Un\G1249412.0) are turned on, the connection will be closed.

(5) On (completed) of 'Execution completion for each protocol' (Un\G1249380.0) is confirmed and then 'Start request for each protocol' (Un\G1249348.0) is turned off (stop).

(6) Execution completion for each protocol' (Un\G1249380.0) and 'Error for each protocol' (Un\G1249412.0) are turned off, and then 'Status of connection' (Un\G1249309) becomes 2H (waiting for the request).

Precautions

If the system turns off 'Start request for each protocol' (Un\G1249348.0) before turning on (completed) 'Execution completion for each protocol' (Un\G1249380.0), the program may fail to detect on of 'Execution completion for each protocol' (Un\G1249380.0) and 'Error for each protocol' (Un\G1249412.0).

■ Operation in error (UDP)

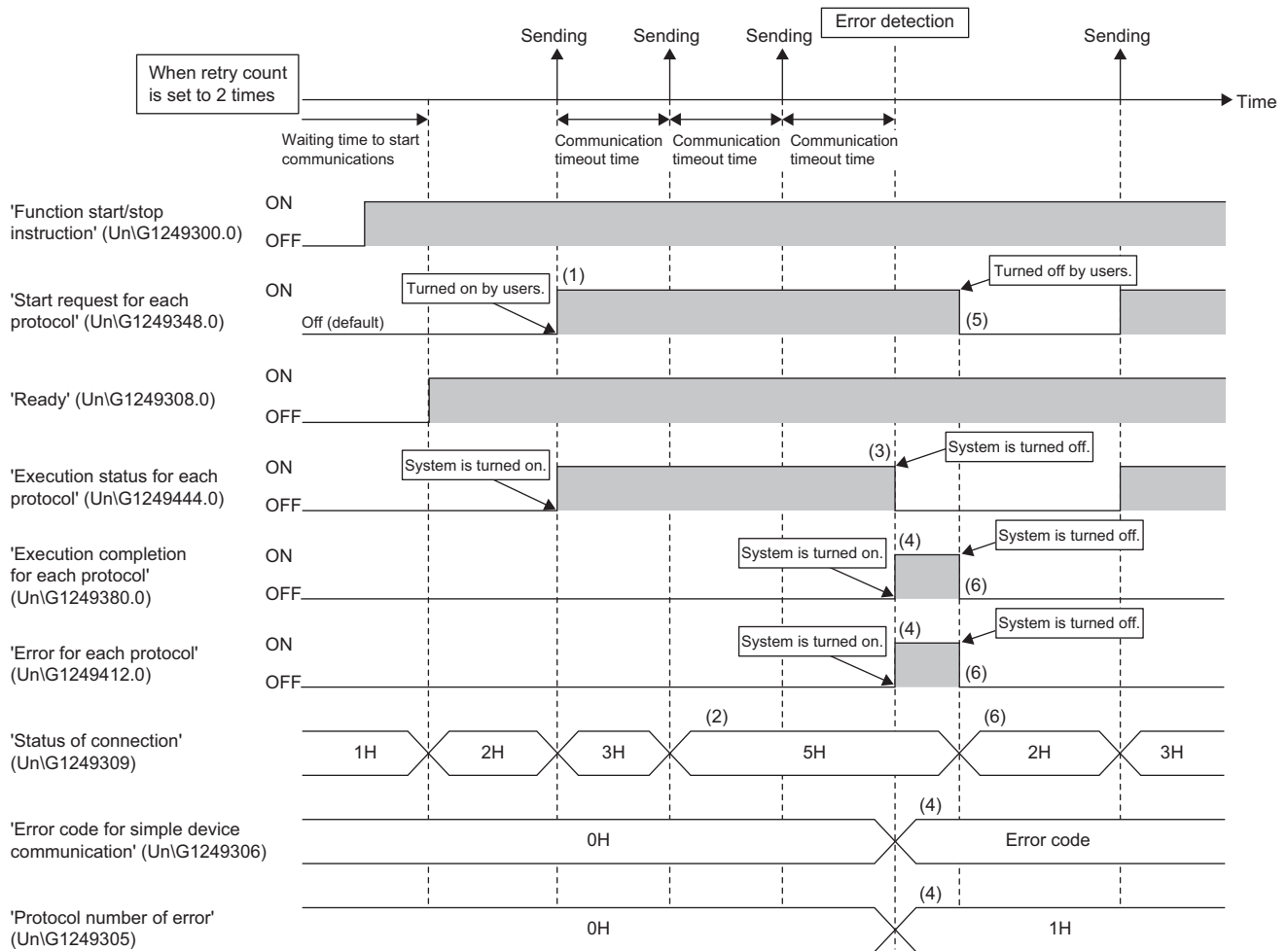

(1) Turn on (start) 'Start request for each protocol' (Un\G1249348.0).

(2) If no response is received even when "Timeout Time" has elapsed, 'Status of connection' (Un\G1249309) becomes 5H (retry being executed).

(3) Then, when the normal response cannot be received even if the data is sent for the number of "Timeout Retry Count Setting", 'Execution status for each protocol' (Un\G1249444.0) is turned off (communication stop).

(4) An error code is stored in 'Error code for simple device communication' (Un\G1249306) and the protocol number of error is stored in 'Protocol number of error' (Un\G1249305). Also, 'Execution completion for each protocol' (Un\G1249380.0) and 'Error for each protocol' (Un\G1249412.0) are turned on.

(5) On (completed) of 'Execution completion for each protocol' (Un\G1249380.0) is confirmed and then 'Start request for each protocol' (Un\G1249348.0) is turned off (stop).

(6) Execution completion for each protocol (Un\G1249380.0) and 'Error for each protocol' (Un\G1249412.0) are turned off, and then 'Status of connection' (Un\G1249309) becomes 2H (waiting for the request).

Precautions

If the system turns off 'Start request for each protocol' (Un\G1249348.0) before turning on (completed) 'Execution completion for each protocol' (Un\G1249380.0), the program may fail to detect on of 'Execution completion for each protocol' (Un\G1249380.0) and 'Error for each protocol' (Un\G1249412.0).

When "Comm Set" is "Request" and "Communication Type" is "Send Only"

For the "Send Only" communication type, only the request packet can be set, and thus the operation for obtaining the value of the CPU module device before sending is shown.

Normal operation

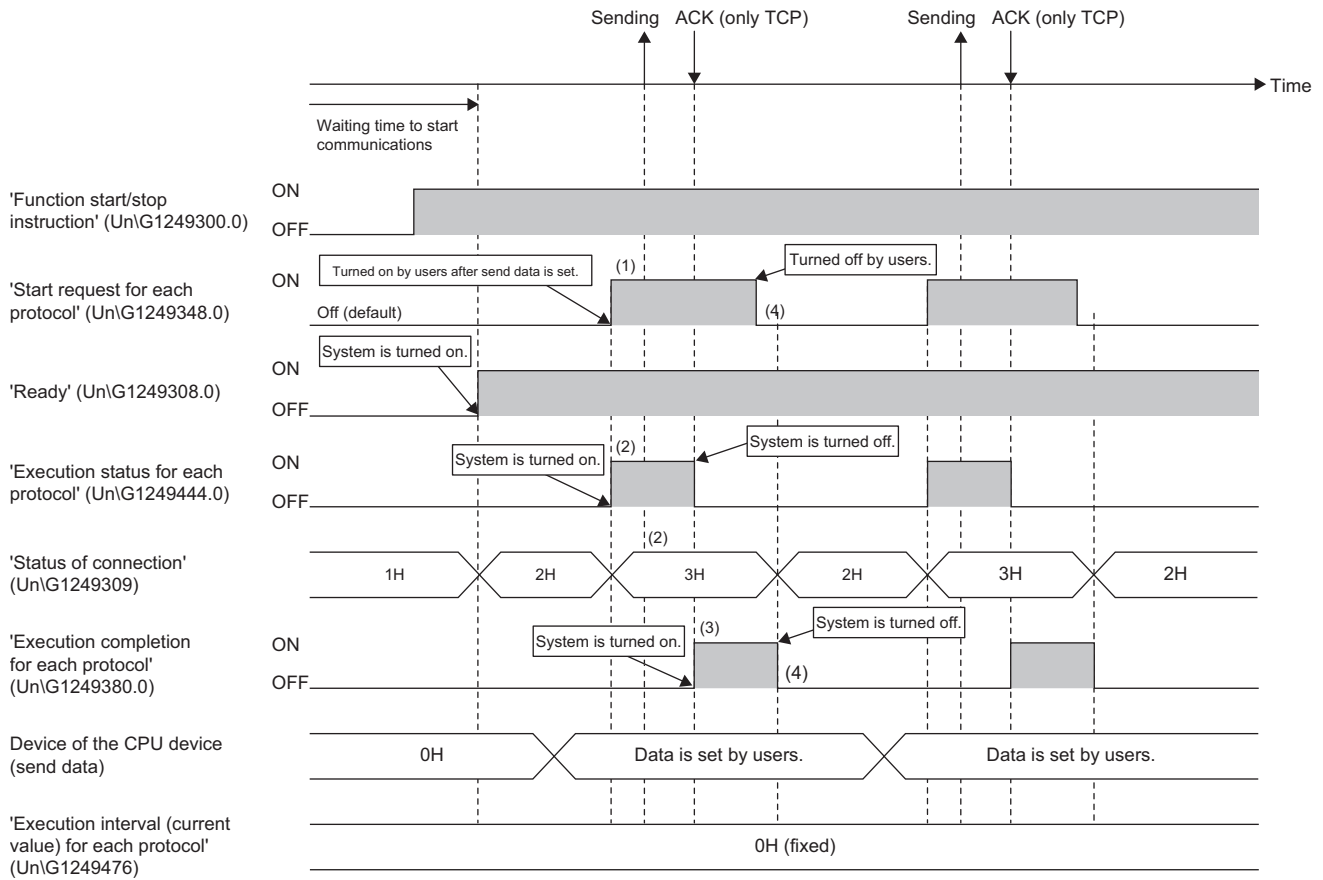

(1) Set data to be sent to the CPU module device and turn on (start) 'Start request for each protocol' (UnG1249348.0).

(2) When 'Start request for each protocol' (UnG1249348.0) is turned on (start), 'Execution status for each protocol' (UnG1249444.0) is turned on (being executed) and 'Status of connection' (UnG1249309) becomes 3H (communicating).

(3) When the data is sent successfully (for TCP, ACK is received), 'Execution completion for each protocol' (UnG1249380.0) is turned on (completed).

(4) When the on (completed) of 'Execution completion for each protocol' (UnG1249380.0) is confirmed and then 'Start request for each protocol' (UnG1249348.0) is turned off (stop), 'Execution completion for each protocol' (UnG1249380.0) is turned off (not completed) and the communication ends.

Precautions

If the system turns off and on 'Start request for each protocol' (UnG1249348.0) again before turning on (completed) 'Execution completion for each protocol' (UnG1249380.0), the request will be ignored. (This symptom is not treated as an error.)

Operation in error (TCP)

The operation is the same as the case where "Comm Set" is "Fixed Intrvl" and "Communication Type" is "Send & Receive".

☞ Page 265 Operation in error (TCP)

When "Comm Set" is "Request" and "Communication Type" is "Receive Only"

For the "Receive Only" communication type, only the response packet can be set, and thus the operation for updating the value of the CPU module device before receiving is shown.

Normal operation

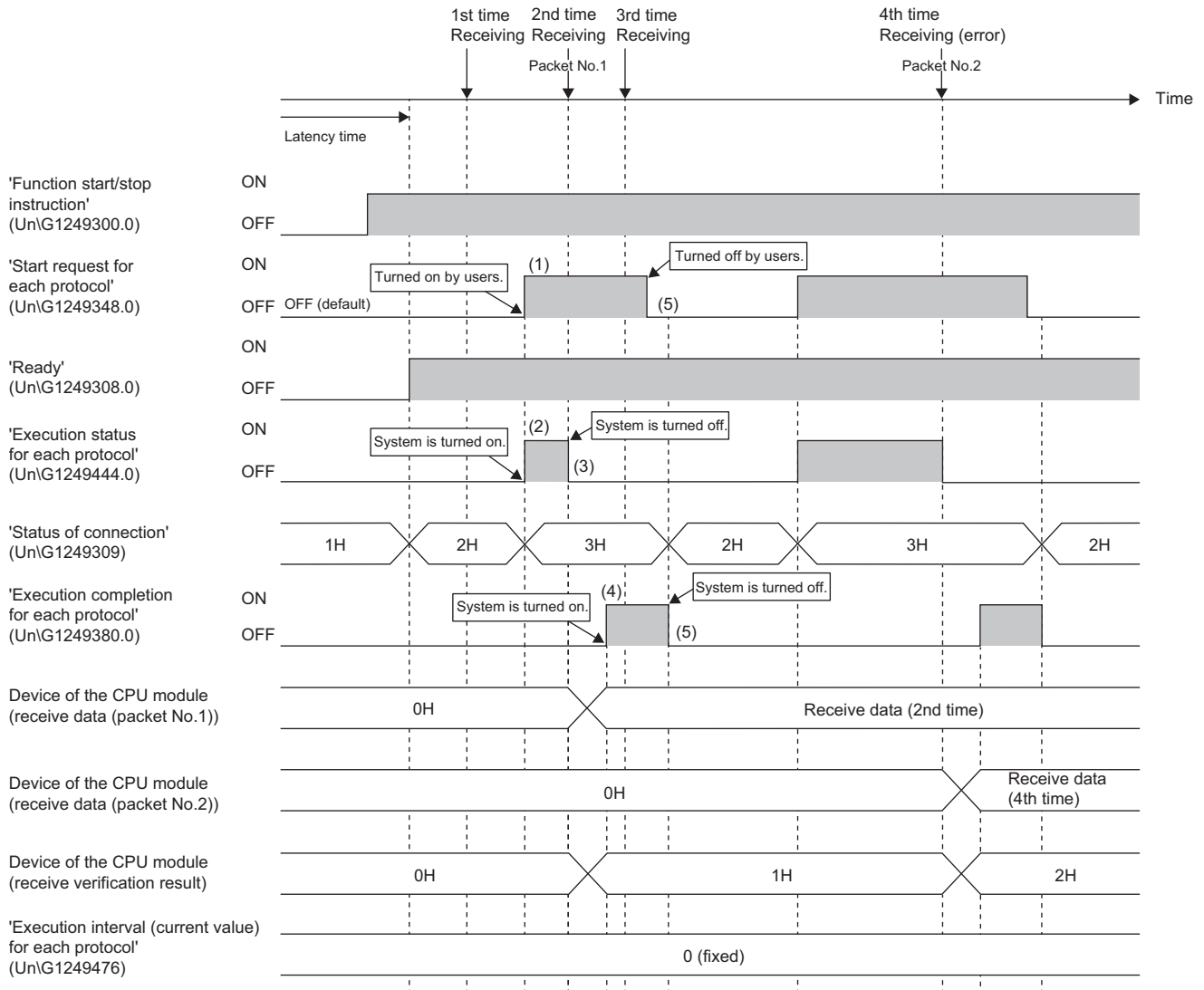

- (1) After receiving has become ready, turn on (start) 'Start request for each protocol' (UnG1249348.0).
- (2) When 'Start request for each protocol' (UnG1249348.0) is turned on (start), 'Execution status for each protocol' (UnG1249444.0) is turned on (being executed).
- (3) When data is received from the external device, 'Execution status for each protocol' (UnG1249444.0) is turned off (communication stop).
- (4) When the update of the CPU module device is completed, 'Execution completion for each protocol' (UnG1249380.0) is turned on (completed).
- (5) Execution completion for each protocol (UnG1249380.0) is turned on (completed) and the value of the CPU module device is obtained. Then, when 'Start request for each protocol' (UnG1249348.0) is turned off (stop), 'Execution completion for each protocol' (UnG1249380.0) is turned off (not completed) and the communication ends.

Any of the data that is received from the external device while 'Execution status for each protocol' (UnG1249444.0) is off (communication stop) is discarded.

■ Operation in error (without data receiving)

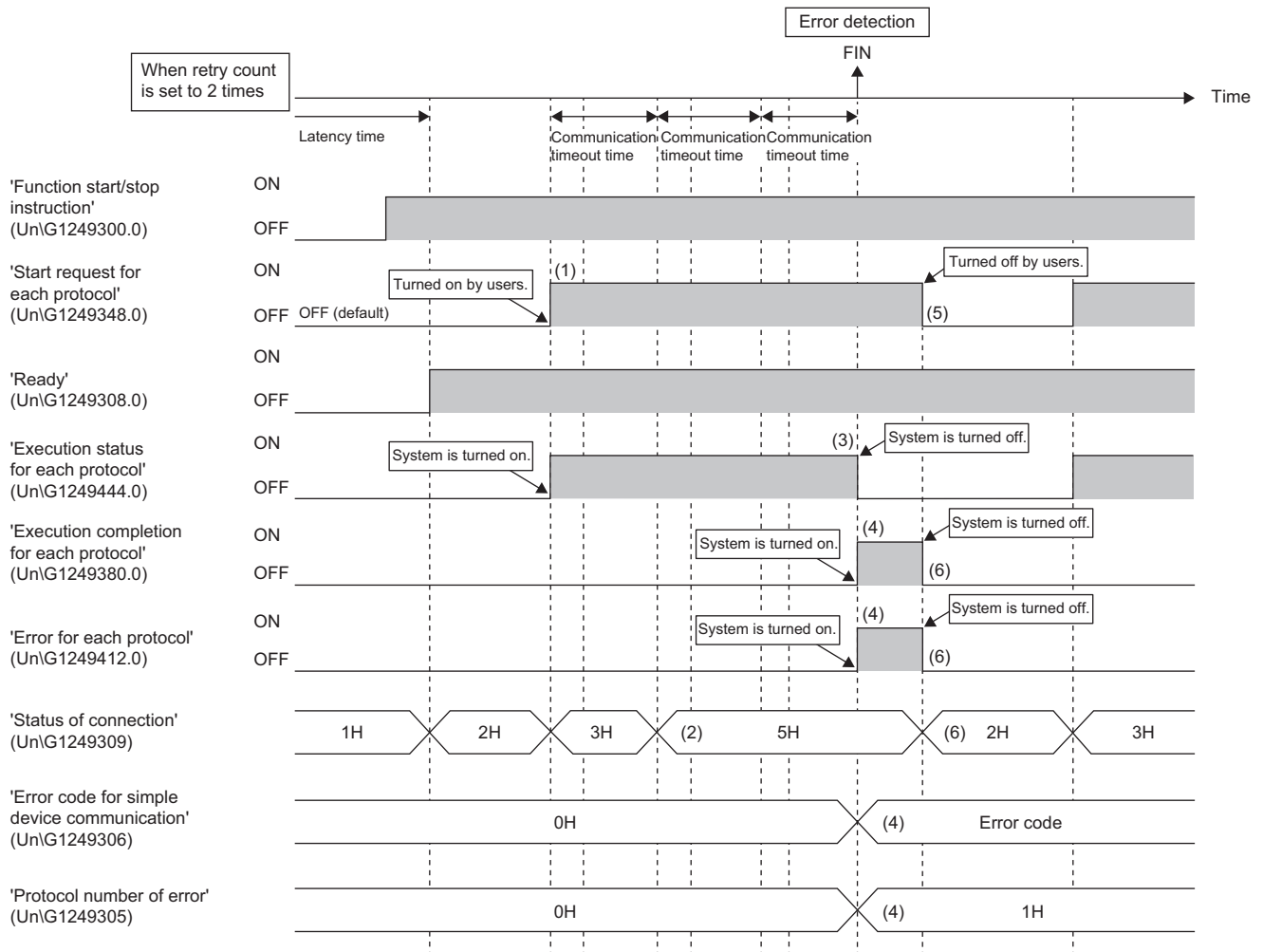

(1) Turn on (start) 'Start request for each protocol' (Un\G1249348.0).

(2) If no data is received from the external device even when "Timeout Time" has elapsed, 'Status of connection' (Un\G1249309) becomes 5H (retry being executed).

(3) If no data is received from the external device even when the number of times in "Timeout Time" multiplied by "Retry Count Setting" has elapsed, 'Execution status for each protocol' (Un\G1249444.0) is turned off (communication stop).

(4) An error code is stored in 'Error code for simple device communication' (Un\G1249306) and the protocol number of error is stored in 'Protocol number of error' (Un\G1249305). Also, 'Execution completion for each protocol' (Un\G1249380.0) and 'Error for each protocol' (Un\G1249412.0) are turned on, and the connection will be closed.

(5) Check that 'Execution completion for each protocol' (Un\G1249380.0) is on (completed), then turn off (stop) 'Start request for each protocol' (Un\G1249348.0).

(6) Execution completion for each protocol' (Un\G1249380.0) and 'Error for each protocol' (Un\G1249412.0) are turned off, and then 'Status of connection' (Un\G1249309) becomes 2H (waiting for the request).

Precautions

If the system turns off 'Start request for each protocol' (Un\G1249348.0) before turning on (completed) 'Execution completion for each protocol' (Un\G1249380.0), the program may fail to detect on of 'Execution completion for each protocol' (Un\G1249380.0) and 'Error for each protocol' (Un\G1249412.0).

For verification mismatch

When a packet for which the verification mismatches is received (the response data sent from the communication destination does not match the receive packet format), 0H*¹ is stored in the CPU module device (received data verification result), the protocol number of the verification mismatch in 'Verification mismatch protocol number' (Un\G1249317), and the mismatch information in 'Verification mismatch information' (Un\G1249318 to Un\G1249333).

Also, the following receive data will be abandoned.

- For TCP: Receive data that results in verification mismatch
- For UDP: UDP packet that results in verification mismatch

*1 The verification mismatch occurs also when the receive data is insufficient in TCP. However in such a case, 0H will not be stored and the previous value will be maintained.

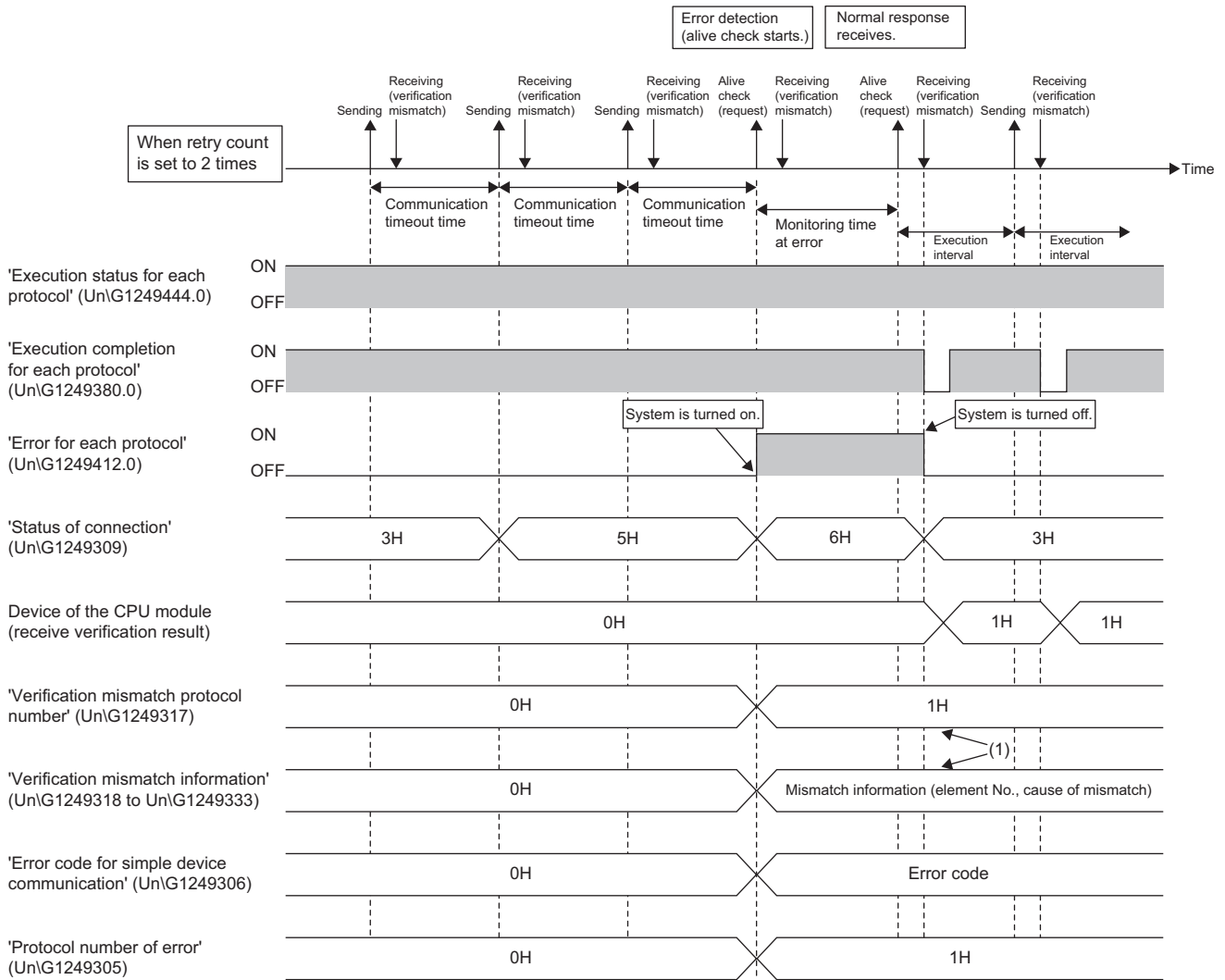

(1)The error will not be cleared even when the verification mismatch has been resolved. To clear the error, use 'Error clear request' (Un\G1249307).

Operations for stopping and restarting communications

Communications can be stopped and restarted by operating the buffer memory areas in the following conditions:

- "Comm Set" is "Fixed Intrl"
- "Comm Set" is "Request", "Communication Type" is "Receive Only", and "Timeout Time" is 0 (infinite wait)

If the communication destination does not respond with the stop request accepted, the communications will stop when "Timeout Time" has elapsed. Communications stop at the time when a stop request is accepted in either of the following conditions: "Comm Set" is "Fixed Intrl" and "Communication Type" is "Receive Only"; or "Comm Set" is "Request" and "Timeout Time" is 0 (infinite wait).

When the retry is being executed, the communications will stop after "Timeout Time" has elapsed without depending on "Timeout Retry Count Setting". When "Timeout Time" is 0 (infinite wait), communications stop after 1000ms, which is the default value of "Timeout Time", has passed.

■ Stop and restart for each Ethernet port

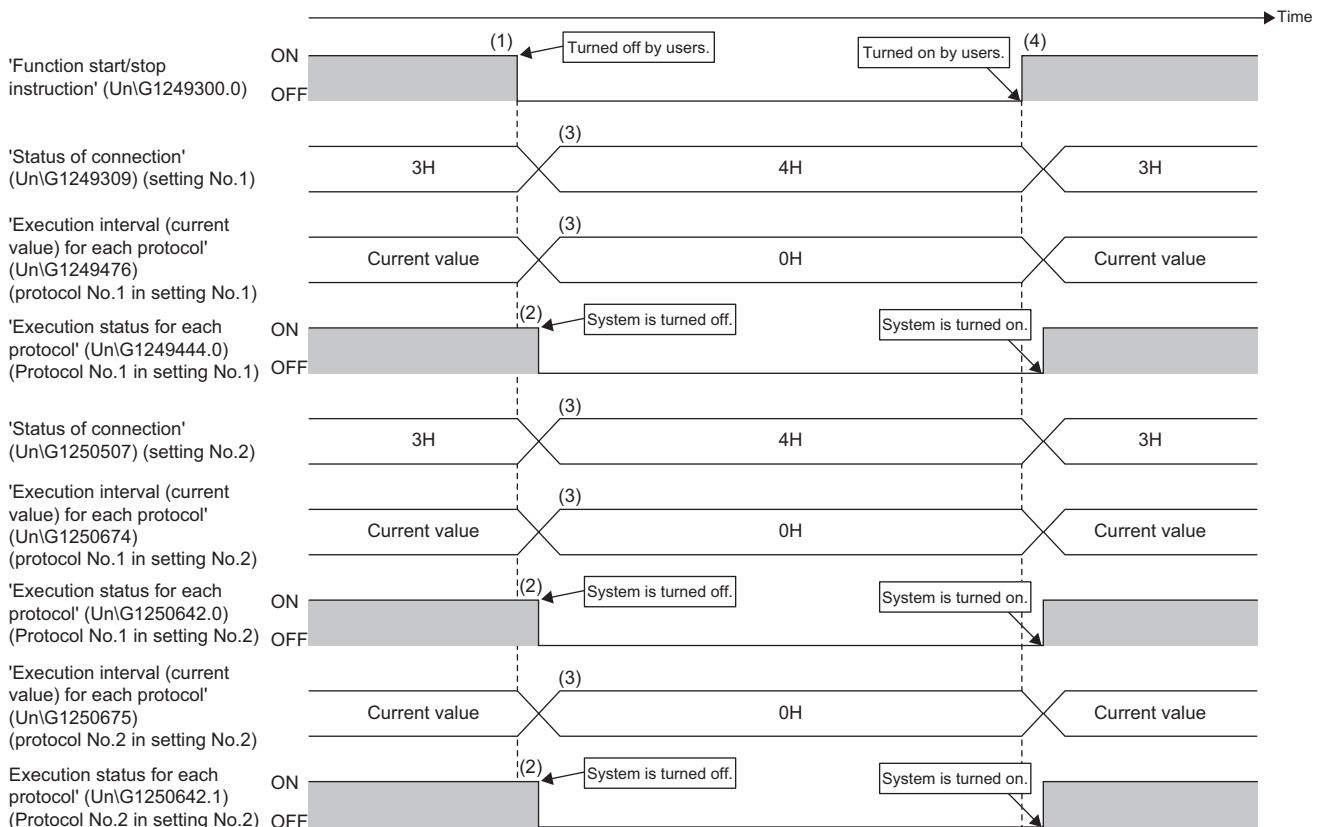

(1) Turn off (stop) 'Function start/stop instruction' (UnG1249300.0) to stop communications with all the devices through the relevant Ethernet port.

(2) When the stop request is accepted, 'Execution status for each protocol' (UnG1249444.0) (protocol No.1 in setting No.1), 'Execution status for each protocol' (UnG1250642.0) (protocol No.1 in setting No.2), and 'Execution status for each protocol' (UnG1250642.1) (protocol No.2 in setting No.2) are turned off (execution stop).

(3) 'Status of connection' (UnG1249309) becomes 4H (function being stopped). When "Comm Set" is "Fixed Intrl", 0 is stored in the following: 'Execution interval (current value) for each protocol' (UnG1249476) (protocol No.1 in setting No.1), 'Execution interval (current value) for each protocol' (UnG1250674) (protocol No.1 in setting No.2), and 'Execution interval (current value) for each protocol' (UnG1250675) (protocol No.2 in setting No.2).

(4) Turn on (enable) 'Function start/stop instruction' (UnG1249300.0) to restart all the communications that are stopped. However, the protocols with 'Start request for each protocol' (UnG1249348 to UnG1249379) turned off (stop) will not restart the communications. When "Comm Set" is "Request", the communications restart under the following conditions: 'Start request for each protocol' (UnG1249348 to UnG1249379) is on (start) before 'Function start/stop instruction' (UnG1249300.0) is turned off (stop). Then, 'Start request for each protocol' (UnG1249348 to UnG1249379) is turned off (stop) once and turned on (start) again.

The operations after the communications restart differ depending on 'Status of connection' (Un\G1249309) before the communications are stopped.

- For 1H (preparing): When the latency time has elapsed during the stop, 'Status of connection' (Un\G1249309) becomes 3H (communicating) and the communication starts. If the latency time has not elapsed, the status remains as 1H (preparing) and time measurement continues.
- For 2H (waiting for the request), 3H (communicating), 5H (retry being executed), and 6H (monitoring at error): The operation will restart at the time when 'Function start/stop instruction' (Un\G1249300.0) is turned on (enable), and 3H (communicating) is stored in 'Status of connection' (Un\G1249309) and on (being executed) is stored in 'Execution status for each protocol' (Un\G1249444.0). When "Comm Set" is "Fixed Intrvl", a value is stored in 'Execution interval (current value) for each protocol' (Un\G1249476).

■ Stop and restart for each protocol

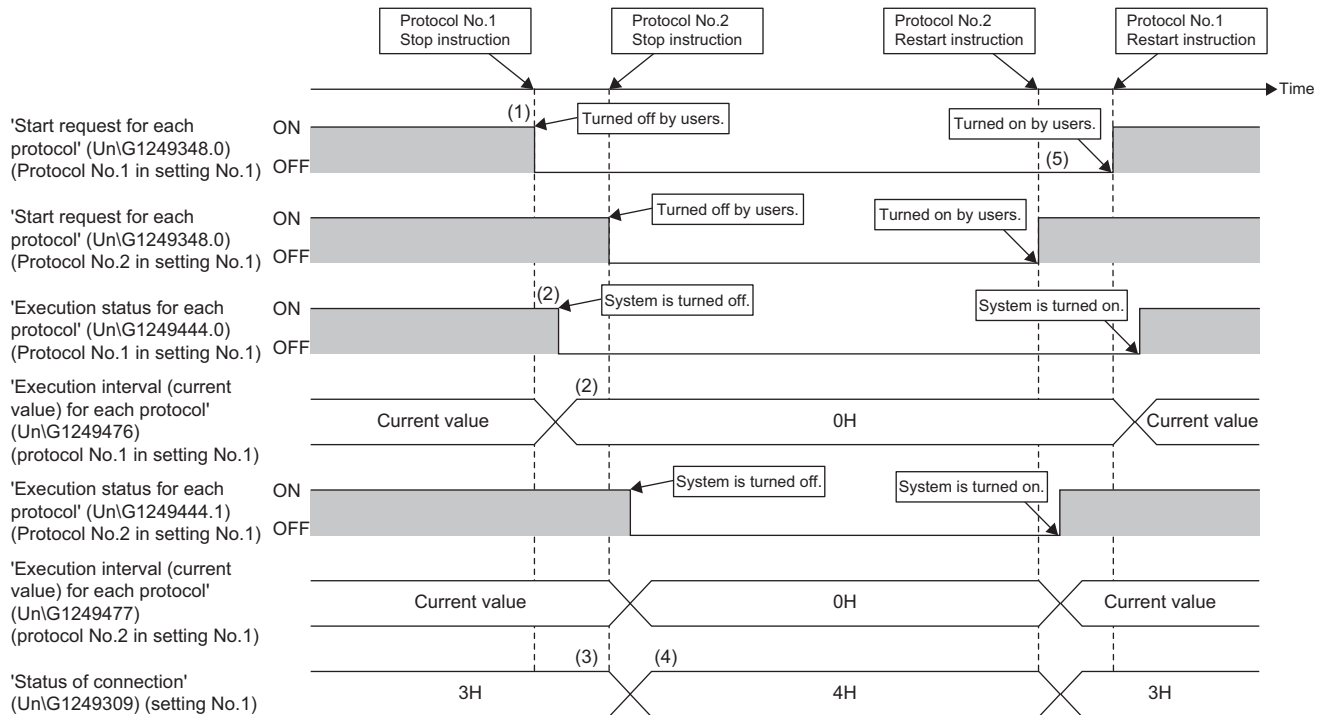

(1) Turn off (stop) 'Start request for each protocol' (Un\G1249348.0) of the protocol number 1 and 'Start request for each protocol' (Un\G1249348.1) of the protocol number 2 to stop the communications of the relevant protocols.

(2) When stop request is accepted, 'Execution status for each protocol' (Un\G1249444.0) is turned off (stop). When "Comm Set" is "Fixed Intrvl", 0 is stored in the following: 'Execution interval (current value) for each protocol' (Un\G1249476) of the protocol number 1 and in 'Execution interval (current value) for each protocol' (Un\G1249477) of the protocol number 2.

(3) When another protocol is being executed with the same communication destination, 'Status of connection' (Un\G1249309) maintains the present state.

(4) When all the protocols that communicate with the same communication destination are stopped, 'Status of connection' (Un\G1249309) becomes 4H (function being stopped).

(5) Turn on (start) 'Start request for each protocol' (Un\G1249348.0) of the protocol number 1 and 'Start request for each protocol' (Un\G1249348.1) of the protocol number 2 to restart the communications that are stopped.

If all the protocols of the communication destination are stopped, the operation at the restart will be the same as the operation of the Ethernet port. (Page 276 Stop and restart for each Ethernet port)

However, the communications will not restart if 'Function start/stop instruction' (Un\G1249300.0) is off (stop). After the restart instruction, the communications will be executed at the communication timing of the relevant protocol.

Stored value for connection status

The following shows values to be stored in 'Status of connection' (Un\G1249309) in the following cases with the same setting number.

- When both "Fixed Intrvl" and "Request" are used for "Comm Set"
- When multiple protocols set to "Request" are used
- When a protocol with "Comm Set" set to "Fixed Intrvl" and "Communication Type" set to "Receive Only" is used with another protocol
- When multiple protocols, whose "Comm Set" are set to "Fixed Intrvl" and "Communication Type" to "Receive Only", are used

■When both "Fixed Intrvl" and "Request" are used for "Comm Set"

- While the protocol set to "Fixed Intrvl" is normally communicating, 'Status of connection' (Un\G1249309) becomes 3H (communicating) even if the protocol set to "Request" is waiting for the request.
- While any of the protocols set to "Fixed Intrvl" or "Request" becomes 5H (retry being executed) or 6H (monitoring at error), the value is stored in 'Status of connection' (Un\G1249309).
- When 'Start request for each protocol' (Un\G1249348.0) of the protocol set to "Fixed Intrvl" is off (stop), the value of the protocol set to "Request" is stored in 'Status of connection' (Un\G1249309).^{*1}
- When 'Function start/stop instruction' (Un\G1249300.0) is off (stop), 'Status of connection' (Un\G1249309) becomes 4H (function being stopped).

*1 The following specification also applies if multiple protocols are set to "Request".

 Page 279 When multiple protocols set to "Request" are used

■When multiple protocols set to "Request" are used

- While all the protocols are waiting for the request, 'Status of connection' (Un\G1249309) becomes 2H (waiting for the request).
- While any one of the protocols is 3H (communicating), 5H (retry being executed), or 6H (monitoring at error), the value is stored in 'Status of connection' (Un\G1249309).
- When 'Start request for each protocol' (Un\G1249348.0) of one protocol is off (stop), 'Status of connection' (Un\G1249309) is determined with the remaining protocols.
- When 'Function start/stop instruction' (Un\G1249300.0) is off (stop), 'Status of connection' (Un\G1249309) becomes 4H (function being stopped).

■When a protocol, whose "Comm Set" is set to "Fixed Intrvl" and "Communication Type" to "Receive Only", is used with another protocol

- While any one of the protocols, other than those whose "Comm Set" are set to "Fixed Intrvl" and "Communication Type" to "Receive Only", is 3H (communicating), 5H (retry being executed), or 6H (monitoring at error), the values are stored in 'Status of connection' (Un\G1249309).
- While all the protocols, other than those whose "Comm Set" are set to "Fixed Intrvl" and "Communication Type" to "Receive Only", are either 2H (waiting for the request) or 4H (function being stopped), the processing is as follows: Among the protocols whose "Comm Set" are set to "Fixed Intrvl" and "Communication Type" to "Receive Only", except for the protocols which are 4H (function being stopped), the status of the smallest protocol number is stored in 'Status of connection' (Un\G1249309).
- When 'Function start/stop instruction' (Un\G1249300.0) is off (stop), 'Status of connection' (Un\G1249309) becomes 4H (function being stopped).

■When multiple protocols, whose "Comm Set" are set to "Fixed Intrvl" and "Communication Type" to "Receive Only", are used

- When all the protocols are 4H (function being stopped), 'Status of connection' (Un\G1249309) becomes 4H (function being stopped).
- When any one of the protocols is 3H (communicating), 5H (retry being executed), or 6H (monitoring at error), the status of the smallest protocol number is stored in 'Status of connection' (Un\G1249309), except for the protocol of 4H (function being stopped).
- When 'Function start/stop instruction' (Un\G1249300.0) is off (stop), 'Status of connection' (Un\G1249309) becomes 4H (function being stopped).

When using multiple protocols together

The following describes the operation when a protocol, whose "Comm Set" is set to "Fixed Intrvl" and "Communication Type" to "Receive Only", is used in conjunction with another protocol that has the same setting number.

- A protocol whose "Comm Set" is set to "Fixed Intrvl" and "Communication Type" to "Receive Only" can be executed with another protocol concurrently.
- Receive data is verified first for a protocol with "Communication Type" set to "Send & Receive" or a protocol with "Comm Set" set to "Request" and "Communication Type" to "Receive Only" if the protocol and a protocol with "Communication Type" to "Receive Only" are in the receive data wait status.
- The receive data is verified in ascending order of the protocol number while multiple protocols, whose "Comm Set" are set to "Fixed Intrvl" and "Communication Type" to "Receive Only", are in the receive data wait state.
- Verification of the receive data finishes once a data match is verified.

Ex.

The following table shows the example verification order of when data are received after executing the following protocols: a protocol with "Comm Set" set to "Fixed Intrvl" and "Communication Type" to "Send & Receive", and multiple protocols with "Comm Set" set to "Fixed Intrvl" and "Communication Type" to "Receive Only".

The same verification order applies when the protocol with "Comm Set" set to "Fixed Intrvl" and "Communication Type" to "Send & Receive" is changed to a protocol with "Comm Set" set to "Request" and "Communication Type" to "Send & Receive" or "Receive Only".

Verification order	Protocol number	Communication setting	Communication Type	Receive packet number	Verification result
1	3	Fixed Intrvl	Send & Receive	1	Mismatch
2				2	Mismatch
3	1	Fixed Intrvl	Receive Only	1	Mismatch
4				2	Mismatch
5	2	Fixed Intrvl	Receive Only	1	Mismatch
6				2	Match
7				3	Not to be verified
8	4	Fixed Intrvl	Receive Only	1	Not to be verified

- While multiple protocols are in the receive data wait state, if all protocols are verified as mismatched, the following will be updated: 'Verification mismatch protocol number' (Un\G1249317), 'Verification mismatch information' (Un\G1249318 to Un\G1249333), and 'Number of error completion' (Un\G1249312 to Un\G1249313). At this time, each buffer memory area will store the latest verified protocol information.
- If the data received in TCP is insufficient, verification will be suspended. Once the next data is received, verification will resume from the protocol that had insufficient received data.
- Refer to Page 279 Stored value for connection status for the value to be stored in 'Status of connection' (Un\G1249309) under either of the following conditions: When a protocol, whose "Comm Set" is set to "Fixed Intrvl" and "Communication Type" to "Receive Only", is used in conjunction with another protocol; or when multiple protocols, whose "Comm Set" are set to "Fixed Intrvl" and "Communication Type" to "Receive Only", are used.
- When a protocol, whose "Comm Set" is set to "Fixed Intrvl" and "Communication Type" to "Receive Only", is being executed with another protocol, the latter protocol number will be stored in 'Protocol number currently executing' (Un\G1249316). Also, when multiple protocols with "Comm Set" set to "Fixed Intrvl" and "Communication Type" to "Receive Only" are being executed and the other protocols are not being executed, the smallest protocol number of the protocols being executed will be stored in 'Protocol number currently executing' (Un\G1249316).
- If a lot of protocols with "Comm Set" set to "Fixed Intrvl" and "Communication Type" set to "Receive Only" are executed, it takes longer to process the receive data. Turn off (stop) 'Start request for each protocol' (Un\G1249348.0) for unnecessary protocols.

Protocol execution order

■When "Comm Set" is "Fixed Intrvl" and "Communication Type" is "Receive Only"

For details on the protocol execution order, refer to the following.

☞ Page 280 When using multiple protocols together

■Settings other than when "Comm Set" is "Fixed Intrvl" and "Communication Type" is "Receive Only"

The protocol execution order is as follows:

- Each protocol is executed independently for each setting number.
- When 'Start request for each protocol' (Un\G1249348.0) of multiple protocols are turned on (start) simultaneously, the protocols may not be executed in ascending order of the protocol number. For how to execute multiple protocols in a desired order when "Comm Set" is "Request", refer to Page 284 When executing multiple protocols in desired order with "Comm Set" set to "Request".
- When data communications start simultaneously, protocols are executed in ascending order based on the protocol number.
- When the communication setting of a protocol is "Fixed Intrvl" and the communication restarts after it is stopped, the relevant protocol is executed after the execution of the last protocol among protocols being executed or to be executed at the timing when 'Start request for each protocol' (Un\G1249348.0) turns on (start).
- When the communication setting of a protocol is "Request", the relevant protocol is executed after the execution of the last protocol among protocols being executed or to be executed at the timing when 'Start request for each protocol' (Un\G1249348.0) turns on (start).

Precautions

This section provides precautions for the simple CPU communication function.

Incomplete data reception and timeout

Because the load of Ethernet communication becomes heavy during the simple device communication, if another communication function (such as MELSOFT connection, SLMP communication, socket communication function, and simple CPU communication function) is simultaneously performed by using UDP, the data reception of UDP may not be completed, resulting in a timeout error or other errors. Therefore, to perform other communications during the simple CPU communication, the communication using TCP is recommended.

Execution interval setting

The execution interval of the simple device communication function and time required for completing the communications will differ according to the load rate of the Ethernet line, operating status of other communication functions (such as MELSOFT connection, SLMP communication, socket communication function, and simple CPU communication function), scan time of the communication destination, and system configuration. Thus, the set execution interval or time required for completing the communications may be increased.

■Cause of increased execution interval of the simple device communication function

- The scan time is long for the control CPU module of the RJ71EN71 and RnENCPU (network part) where the simple device communication function is set.
- When the RJ71EN71 and RnENCPU (network part) where the simple device communication function is set are communicating by using a function other than the simple device communication function, the communication processing using a function other than the simple device communication function takes time.
- The load on the Ethernet line is high.
- The number of communication destinations or protocols set in "Simple Device Communication Setting" under "Application Settings" is large.
- Response from the communication destination is delayed.
- More than one RJ71EN71 where the simple CPU communication function or simple device communication function is set are mounted on a single base unit (main base unit or extension base unit).

To perform communications at the set execution interval, set a sufficient execution interval. If the execution interval needs to be checked, actually perform communications to check the interval with 'Execution interval (current value) for each protocol' (Un\G1249476) and 'Execution interval (maximum value) for each protocol' (Un\G1249988).

Stored value for 'Execution interval (current value) for each protocol' (Un\G1249476)

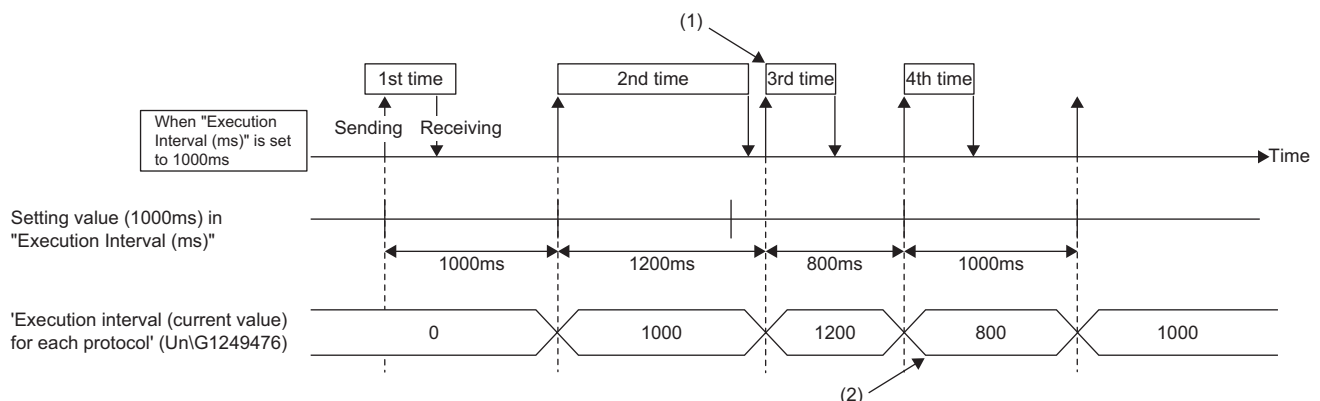

- (1) If a response from the communication destination takes time more than "Execution Interval (ms)" that is set, the next sending is immediately executed.
(2) If the response time from the communication destination exceeds "Execution Interval (ms)" in the previous communication, the value to be stored in 'Execution interval (current value) for each protocol' (Un\G1249476) in the next communication will be smaller than the value set for "Execution Interval (ms)".

Duplication of own station port numbers

The simple device communication cannot be performed in the following cases.

- When the own station port number set in the simple device communication and the own station port number of the programmable controller set in the external device configuration are the same
- When the own station port number set in the simple device communication and the one set in another function such as the socket communication are the same

IP address and model of communication destination

Check the IP address and model of the communication destination before setting the parameters.

The simple device communication cannot be performed when no communication destination exists (an incorrect IP address is specified) or when an incorrect model is selected.

- When "Comm Set" is "Fixed Intrvl", the connection status of each setting number changes from 5H (retry being executed) to 6H (monitoring at error).
- When "Comm Set" is "Request", the connection status of each setting number becomes 5H (retry being executed).

When the file register (R, ZR) is used

When using the file register (R, ZR) for the device on the own station, always assign the device within the setting range. If the devices are not assigned, an error occurs (error code: 4031), and the simple device communication of the "Setting No." which exceeds the range cannot be performed.

Number of applicable settings

- Up to 16 settings are applicable per port when "Normal" is set for "Resource Setting" under "Application Settings". If, however, 49 or more connections have been used for other functions, the maximum number of applicable settings is the difference calculated by subtracting the number of connections used for other function from 64 connections.
- Up to 32 settings are applicable per port when "Extension 1" is set for "Resource Setting" under "Application Settings". If, however, 33 or more connections have been used for other functions, the maximum number of applicable settings is the difference calculated by subtracting the number of connections used for other function from 64 connections.
- Up to 64 settings are applicable per port when "Extension 2" is set for "Resource Setting" under "Application Settings". If, however, 1 or more connections have been used for other functions, the maximum number of applicable settings is the difference calculated by subtracting the number of connections used for other function from 64 connections.

Measures against errors occurring during protocol execution

When an error occurs during protocol execution, the protocol execution may not be completed properly. Check the error details, take appropriate measures, and execute the protocol again.

When using a protocol with "Communication Type" set to "Receive Only"

The precautions for when using a protocol with "Communication Type" set to "Receive Only" are as follows:

- If data is received during receive processing in a protocol with "Communication Type" set to "Receive Only", the received data may be discarded.
- With TCP and "Communication Type" set to "Receive Only", the connection is closed by turning off 'Function start/stop instruction' (Un\G1249300.0) or 'Start request for each protocol' (Un\G1249348.0) at the time when 'Status of connection' (Un\G1249309) makes the transition from values other than 4H (function being stopped) and 2H (waiting for the request) to 4H (function being stopped) or 2H (waiting for the request).
- When only a protocol with "Communication Type" set to "Receive Only" is used in TCP, the system cannot detect a communication disconnection with the external device, which disables reconnection. Therefore, it is recommended to use protocols in conjunction with the one whose "Communication Type" is set to "Send & Receive" or "Send Only". When attempting to reconnect using only a protocol with "Communication Type" set to "Receive Only", close the connection once before reconnecting through the method described above.
- If the protocol with TCP and "Communication Type" set to "Receive Only" has not opened a connection even after "Timeout Time" (calculated by "Retry Count Setting" + 1) has elapsed, a communication error will be detected and an error (error code: CF81H) will occur. When "Timeout Time" is set to 0 (infinite wait), "Timeout Time" is treated as the default value (1000ms).
- If a protocol with TCP and "Comm Set" set to "Fixed Intrvl" and "Communication Type" to "Receive Only" is used, the connection may close when 'Status of connection' (Un\G1249309) becomes 6H (monitoring at error).

When executing multiple protocols in desired order with "Comm Set" set to "Request"

Ensure that 'Execution completion for each protocol' (Un\G1249380.0) for the preceding protocol has been turned on (complete), then turn on (start) 'Start request for each protocol' (Un\G1249348.0).

Data received outside of protocol execution timing

- Data are not received unless the connection is open.
- When only protocols whose "Communication Type" are set to "Send & Receive" or "Send Only" are set, the data received outside of the receive data wait timing of the protocol will be held in the receive data area. The setting of "Clear Receive System Area" in "Send/Receive Parameter Setting" determines how the data held in the receive data area are to be treated.

Setting in "Clear Receive System Area"	How data held in receive data area to be treated
Yes (default)	Discarded and not used for receive processing
No	Used for receive processing

- When a protocol whose "Communication Type" is "Receive Only" is set, data will be discarded if received at the time when no protocols are in the receive data wait status.

Restrictions applicable depending on versions

■ Firmware version

The simple device communication function is available for the RJ71EN71 or RnENCPU (network part) whose firmware version is "56" or later and that uses the engineering tool of software version of 1.075D or later.

Engineering tool	RJ71EN71 or RnENCPU (network part)				
	Firmware version of "56" or later	Firmware version of "59" or later	Firmware version of "71" or later	Firmware version of "75" or later	Firmware version of "77" or later
Software version of 1.075D or later	<ul style="list-style-type: none"> • Number of settings per port: 16 ("Normal"), 32 ("Extension 1") • Number of protocols per port: 256 ("Normal"), 512 ("Extension 1") • Communication setting: "Fixed Intrvl" and "Request" • Communication types: Send Only, Send & Receive 				
Software version of 1.080J or later	Same as the engineering tool of software version of 1.075D or later	Protocol setting editing function added			
Software version of 1.095Z or later	Same as the engineering tool of software version of 1.075D or later	Same as the engineering tool of software version of 1.080J or later	Following settings added <ul style="list-style-type: none"> • Element "Error check code" • Enable (Upper → Lower, two-word units), Enable (Upper → Lower, four-word units) for byte swap for non-conversion variables 		
Software version of 1.100E or later	Same as the engineering tool of software version of 1.075D or later	Same as the engineering tool of software version of 1.080J or later	Same as the engineering tool of software version of 1.095Z or later	Following settings added <ul style="list-style-type: none"> • Element "Conversion Variable" • "Data Unit" for the length 	
Software version of 1.105K or later	Same as the engineering tool of software version of 1.075D or later	Same as the engineering tool of software version of 1.080J or later	Same as the engineering tool of software version of 1.095Z or later	Same as the engineering tool of software version of 1.100E or later	Following settings added <p>Communication type: Receive Only</p> <p>Resource setting:</p> <p>Extension 2^{*1}</p> <ul style="list-style-type: none"> • Number of communication destinations: 64 • Number of protocols: 2048 • Number of packets: 6144 • Packet data area size: 491520 bytes • Number of elements: 1 to 128 • Packet length: 1 to 10238 bytes

*1 Supported by the modules that have production information where third and fourth digits from the left are as follows:

Model	The third and fourth digits from the left of the production information
RJ71EN71	"25" or later
R04ENCPU	"56" or later
R08ENCPU	"54" or later
R16ENCPU	"51" or later
R32ENCPU	"52" or later
R120ENCPU	"44" or later

1.17 IP Address Change Function

This function can change the IP address of the Ethernet-equipped module or other item without changing the parameter settings.

Ex.

Case of the CPU module (built-in Ethernet port part)

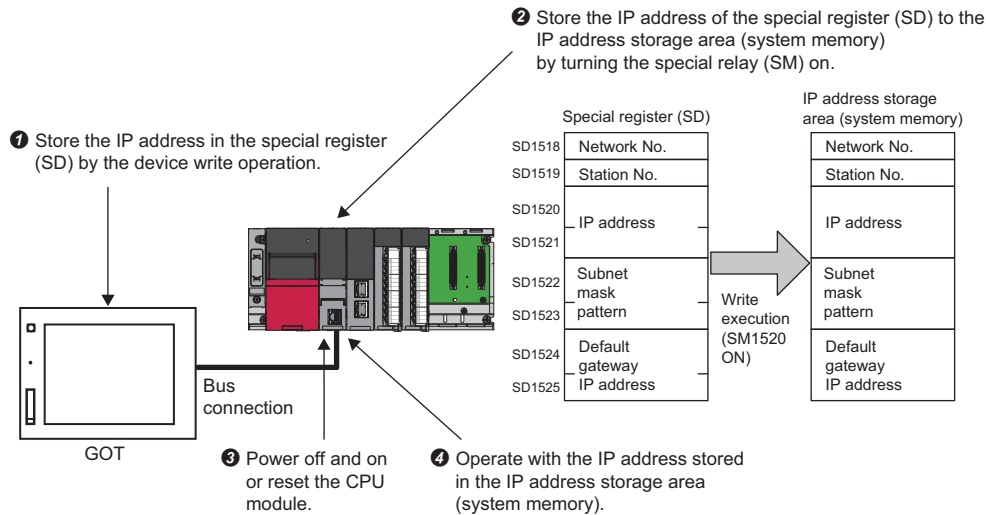

Point

- When this function is used in the CPU module (built-in Ethernet port part), it can be used also by manipulating the special relay and special register values from the GOT. Refer to the list of special relay and special register in the following manual for details on the special relay and special register.
 MELSEC iQ-R CPU Module User's Manual (Application)
- When this function is used in the RJ71EN71 or RnENCPU (network part), it can be used also by manipulating the buffer memory values from the GOT. (Page 473 Buffer Memory)

Restriction

- When this function is used in the RJ71EN71 or RnENCPU (network part), check the firmware version of the module. The network number and station number of the CPU module (built-in Ethernet port part) can be changed in the CPU module with the firmware version supporting communications by network number/station number. (Page 564 Added and Enhanced Functions)
- The IP address change function is not available when "Q Compatible Ethernet" is selected for the network type in the RJ71EN71.

IP address of the Ethernet-equipped module

The value set with the module parameters during initial processing is set as the IP address of the Ethernet-equipped module. When this function is used, the IP address set during initial processing is the value stored in the IP address storage area instead of the value set in the parameters.

Ex.

Case of the CPU module (built-in Ethernet port part)

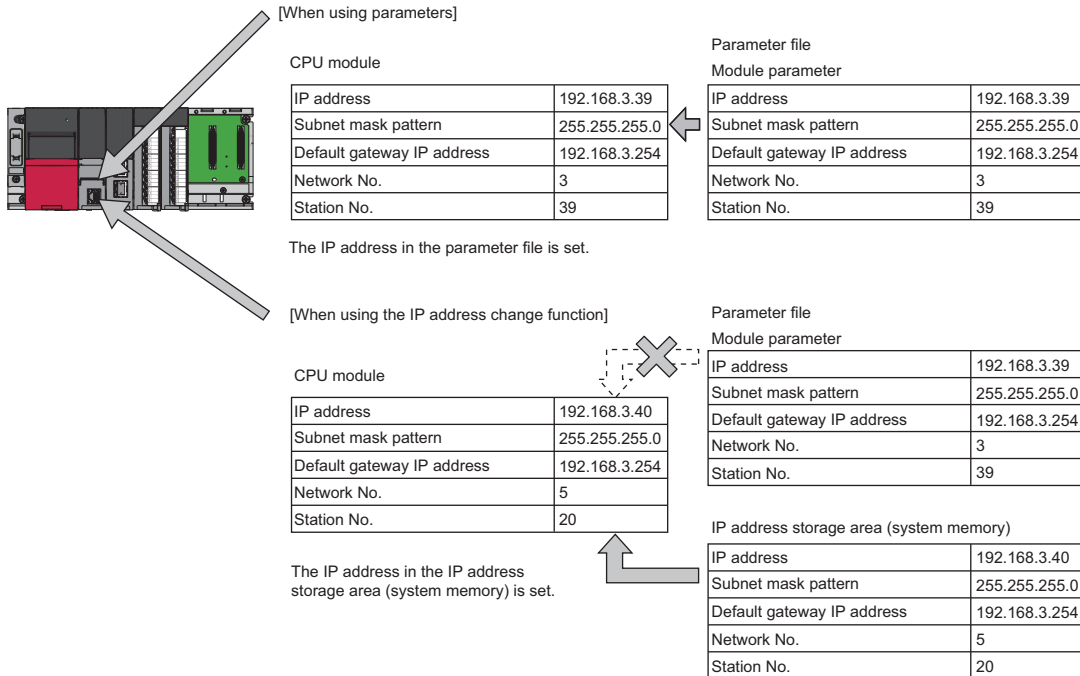

Writing and clearing the IP address

■Case of the CPU module (built-in Ethernet port part)

The IP address value is written into the IP address storage area (system memory). The write and clear operations are performed with the special relay and special register.

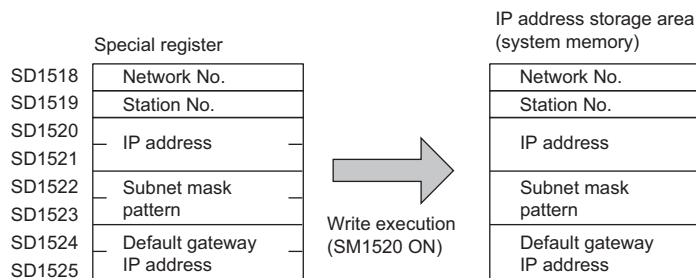

■Case of the RJ71EN71 or RnENCPU (network part)

The IP address value is written into the IP address storage area (flash ROM). The write and clear operations are performed with the buffer memory.

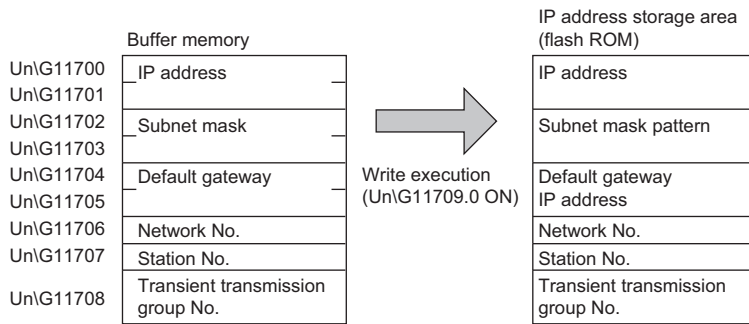

Write operation

■Case of the CPU module (built-in Ethernet port part)

Follow the steps below.

1. Store the value to be changed in 'IP address setting' (SD1518 to SD1525).
2. Turn off and on 'IP address storage area write request' (SM1520).
3. Check the write results with the following special relay and special register.

Device	At normal completion	At abnormal completion
'IP address storage area write request' (SM1520)	Off	Off
'IP address storage area write error' (SM1521)	Off	On
'IP address storage area writing error cause' (SD1526)	—	Stores the cause of the error

4. Power off and on or set the CPU module.
5. If the IP address stored in the IP address storage area (system memory) is a valid value, the stored IP address is set as the IP address of the CPU module (built-in Ethernet port part). (If the value is invalid or not set, the value set in the module parameters is set as the IP address of the CPU module (built-in Ethernet port part).)
6. Check the IP address with the buffer memory. (☞ Page 483 CPU module (built-in Ethernet port part))

■Case of the RJ71EN71 or RnENCPU (network part)

Follow the steps below.

1. Store the values to be changed in 'IP address setting' (Un\G11700 to Un\G11705) and 'Communications by Network No./ Station No.' (Un\G11706 to Un\G11708).
2. Turn off and on 'IP address storage area write request' (Un\G11709.0).
3. Check the write results with the following buffer memory areas.

Buffer memory	At normal completion	At abnormal completion
'IP address storage area write request' (Un\G11709.0)	Off	Off
'IP address storage area write error' (Un\G11710.0)	Off	On
'IP address storage area writing error cause' (Un\G11711)	—	Stores the cause of the error

4. Power off and on or set the CPU module.
5. If the IP address stored in the IP address storage area (flash ROM) is a valid value, the stored IP address is set as the IP address of the RJ71EN71 or the RnENCPU (network part). (If the value is invalid or not set, the value set in the module parameters is set as the IP address of the RJ71EN71 or the RnENCPU (network part).)
6. Check the IP address with the buffer memory. (☞ Page 473 RJ71EN71, RnENCPU (network part))

■ Operation of the special relay and special register, or of the buffer memory

The following section shows the operation of the special relay and special register or of the buffer memory when writing to the IP address storage area.

- Operation at normal completion

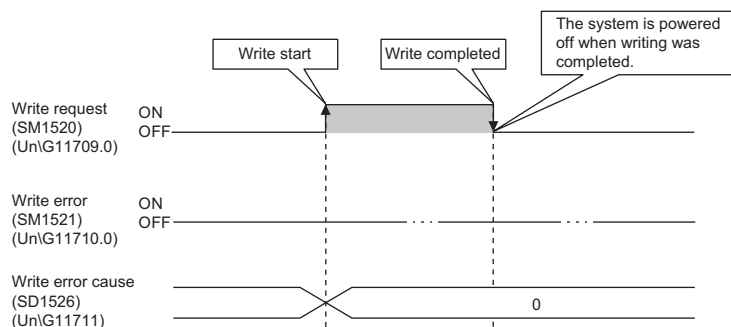

- Operation at abnormal completion

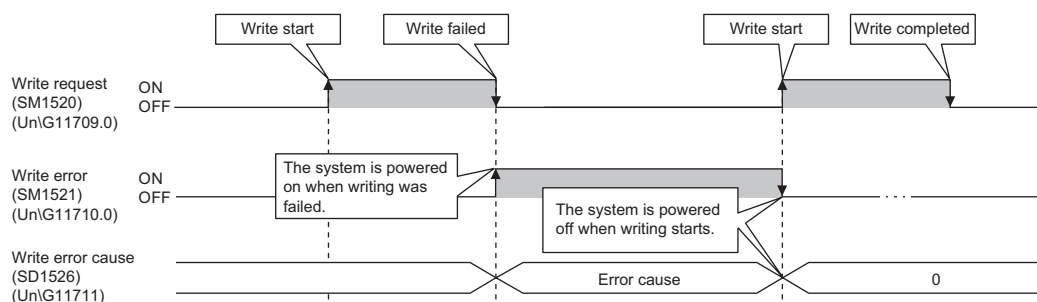

■ Cause of error at abnormal completion

- If the data is not written correctly into the IP address storage area (system memory) in the CPU module (built-in Ethernet port part), the cause of the error is stored in 'IP address storage area writing error cause' (SD1526).

Stored value	Cause of error
100H	The value for 'IP address setting' (SD1518 to SD1525) exceeds the setting range.
200H	An error occurred during write.
300H	Writing cannot be performed since the following functions are being executed. <ul style="list-style-type: none"> • CPU module data backup/restoration function
400H	Writing was started during the clear processing.

- If the data is not written correctly into the IP address storage area (flash ROM) in the RJ71EN71 or the RnENCPU (network part), the cause of the error is stored in 'IP address storage area writing error cause' (Un\G11711).

Stored value	Cause of error
100H	The value for 'IP address' (Un\G11700 to Un\G11701) exceeds the setting range.
101H	The value for 'Default gateway' (Un\G11704 to Un\G11705) exceeds the setting range.
102H	The network address of 'Default gateway' (Un\G11704 to Un\G11705) or of the gateway IP address is different from that of the IP address of the own node.
103H	The value for 'Network number' (Un\G11706) exceeds the setting range.
104H	The value for 'Station number' (Un\G11707) exceeds the setting range.
105H	The value for 'Transient transmission group number' (Un\G11708) exceeds the setting range.
106H	The port 1 and port 2 IP addresses written in the IP address storage area are the same.
107H	The port 1 and port 2 network numbers or station numbers written in the IP address storage area are the same.
200H	An error occurred during write.
400H	Writing was started during the clear processing.

Clearing operation

■Case of the CPU module (built-in Ethernet port part)

Execute clearing by turning off and on 'IP address storage area clear request' (SM1522).

1. Turn on 'IP address storage area clear request' (SM1522).
2. Check the write results with the following special relay and special register.

Device	At normal completion	At abnormal completion
'IP address storage area clear request' (SM1522)	Off	Off
'IP address storage area clear error' (SM1523)	Off	On
'IP address storage area clear error cause' (SD1527)	—	Stores the cause of the error

3. Power off and on or set the CPU module.
4. Check the IP address with the buffer memory. (☞ Page 483 CPU module (built-in Ethernet port part))

■Case of the RJ71EN71 or RnENCPU (network part)

Execute clearing by turning off and on 'IP address storage area clear request' (Un\G11712.0).

1. Turn on 'IP address storage area clear request' (Un\G11712.0).
2. Check the write results with the following buffer memory areas.

Buffer memory	At normal completion	At abnormal completion
'IP address storage area clear request' (Un\G11712.0)	Off	Off
'IP address storage area clear error' (Un\G11713.0)	Off	On
'IP address storage area clear error cause' (Un\G11714)	—	Stores the cause of the error

3. Power off and on or set the CPU module.
4. Check the IP address with the buffer memory. (☞ Page 473 RJ71EN71, RnENCPU (network part))

■Operation of the special relay and special register, or of the buffer memory

The following section shows the operation of the special relay and special register or of the buffer memory when clearing the IP address storage area.

- Operation at normal completion

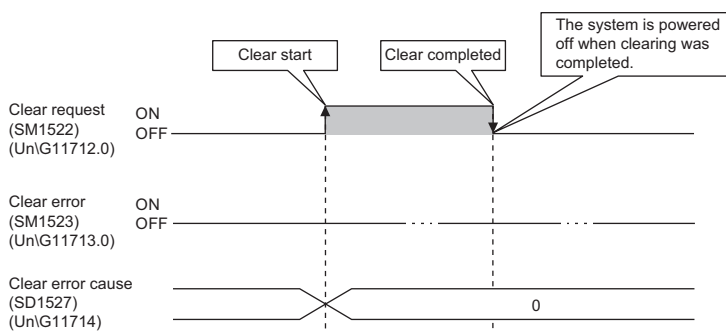

- Operation at abnormal completion

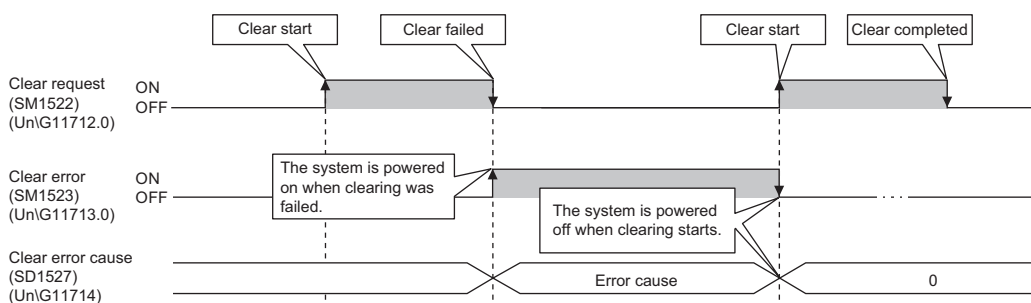

■Cause of error at abnormal completion

If the IP address storage area is not cleared correctly, the cause of the error is stored as follows:

Module	Storage location	Stored value	Cause of error
CPU module (built-in Ethernet port part)	'IP address storage area clear error cause' (SD1527)	200H	Error occurred during clearing.
		400H	Clearing was started during the write processing.
RJ71EN71, RnENCPU (network part)	'IP address storage area clear error cause' (Un\G11714)	200H	Error occurred during clearing.
		400H	Clearing was started during the write processing.

Checking the IP address

Checking with the buffer memory

Check with the following buffer memory areas.

Item	CPU module (built-in Ethernet port part)	RJ71EN71, RnENCPU (network part)
Own node IP address	Un\G50 to Un\G51	Un\G4 to Un\G5
Subnet mask	Un\G60 to Un\G61	Un\G14 to Un\G15
Default gateway IP address	Un\G64 to Un\G65	Un\G18 to Un\G19
Own node network number	Un\G77	Un\G31
Station number	Un\G78	Un\G32
Transient transmission group number	—	Un\G33

Checking with module diagnostics

Check by using the [Module Information List] tab of the "Module Diagnostics" window. ( Page 414 Module Information List)

Checking the operating status

For the RJ71EN71 or the RnENCPU (network part), when operation is performed based on the IP address of the IP address storage area, 'IP address change function operating status' (Un\G11715.0) turns on.

Precautions

The following section lists the precautions for using the IP address.

Power off and reset operation

Do not power off or reset when writing to or clearing the IP address storage area. The values may not be applied onto the IP address storage area. Power off or reset after checking the falling edge of the IP address storage area write request or IP address storage area clear request.

Parameter IP address

For the IP address of the Ethernet-equipped module, the value in the IP address storage area has precedence over the parameter value. When using the IP address specified with the parameters, clear the IP address storage area.

Write processing and clear processing execution timing

- Executing the write or clear processing to the IP address storage area may not be possible if an operation that turns off and on, or on and off an IP address storage area write request or IP address storage area clear request in a short time is performed.
- If the IP address storage area write request is turned off and on again while writing to the IP address storage area, the write processing that was executed first will complete normally, and the following write operation will be ignored. (This also applies to the clear operation.)
- If the IP address storage area clear request is turned off and on while writing to the IP address storage area, the clear operation will not be completed. (This applies to the write operation if writing is executed during the clear processing.)
- If both an IP address storage area write request and IP address storage area clear request are turned off and on, the write operation will be executed as top priority, and the clear operation will not be completed.
- If the write operation and clear operation are performed on the IP address storage area in the RJ71EN71 or the RnENCPU (network part), communication may be stopped. Execute requests while control is not being performed at P1 or P2.

Communications by network number/station number

- For the network number, station number, and transient transmission group number (RJ71EN71 or RnENCPU (network part) only), the values in the IP address storage area have precedence over the module parameter values. To use the network number, station number, and transient transmission group number specified in the module parameters, clear the IP address storage area.
- When the IP address is stored in the IP address storage area, if the network number, station number, and transient transmission group number (RJ71EN71 or RnENCPU (network part) only) are not stored, communications using the network number and station number become impossible. For communications using the network number and station number, even if not changing the values, store the network number, station number, and transient transmission group number in the IP address storage area.

Execution of the IP address change function during execution of another function

During execution of the CPU module data backup/restoration function, the IP address change function of the CPU module (built-in Ethernet port part) cannot be executed. Check that the CPU module data backup/restoration function is not being executed and then execute the IP address change function.

1.18 Redundant System Function

The system with a control system and a standby system is configured using the RJ71EN71. If an error occurs in the control system, the standby system is switched as the new control system to continue communication.

Before using function, check the firmware version of the RJ71EN71 and the CPU module used. (☞ Page 564 Added and Enhanced Functions)

When mounting the RJ71EN71 on the extension base unit in the redundant system with redundant extension base unit, refer to the following.

☞ Page 542 Using the Module in the Redundant System with Redundant Extension Base Unit

Point

To switch the system when a communication error or cable disconnection on Ethernet is detected, use the RJ71EN71.

The system is not switched when a communication error or cable disconnection in the CPU module (built-in Ethernet port part) occurs.

System configuration

The Process CPU, redundant function module, and RJ71EN71 are mounted on the base units of both the system A and system B of a redundant system.

A redundant system is configured by connecting the redundant function modules of both systems using tracking cables and connecting the RJ71EN71s in both systems using Ethernet cables.

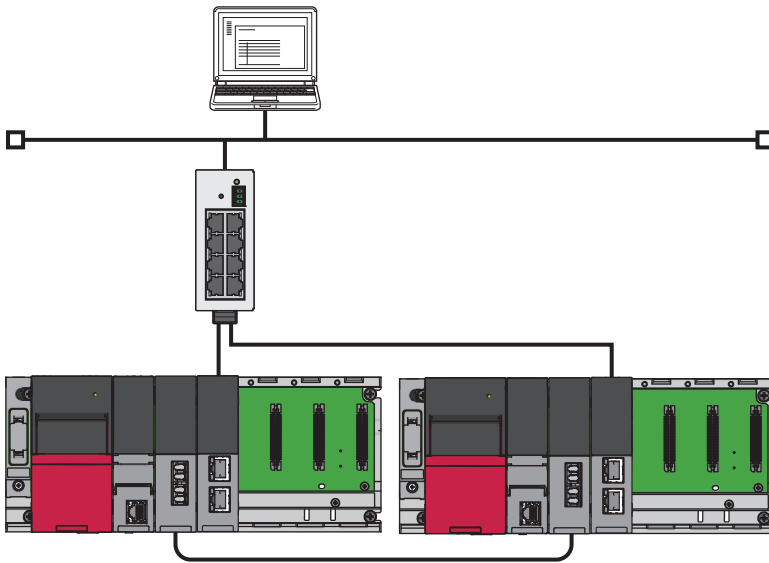

Point

Set the network type for the RJ71EN71 to either of the following.

- "Port 1 Network Type" and "Port 2 Network Type" are set to "Ethernet".
- "Port 1 Network Type" is set to "Q Compatible Ethernet".

System switching request

If an error of system switching cause occurs in the control system, the RJ71EN71 issues a system switching request to the control system CPU module to switch the system.

Restriction

The CPU module (built-in Ethernet port part) cannot issue a system switching request.

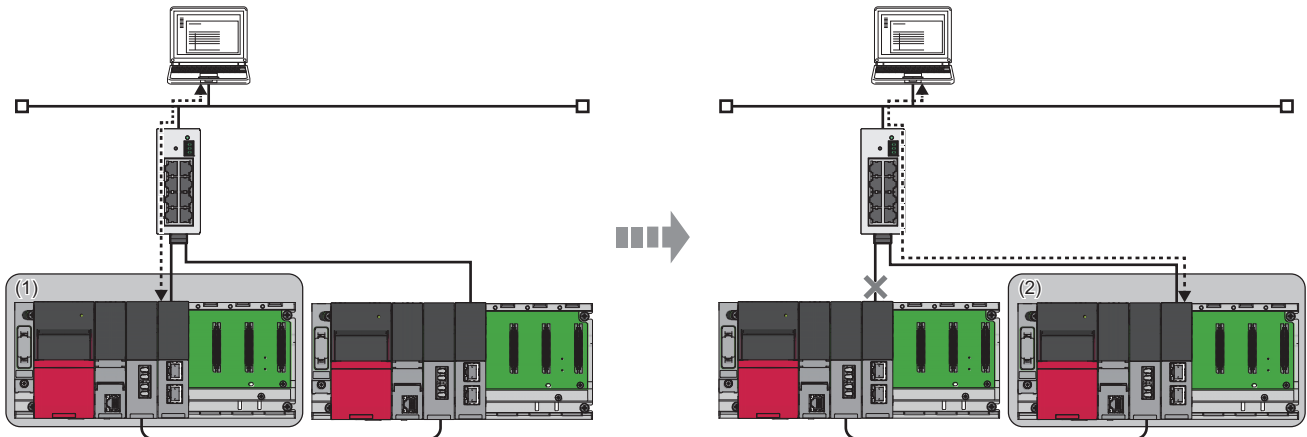

1. A system switching request occurs in the control system (1). (☞ Page 295 System switching request)
2. The RJ71EN71 of control system (1) issues a system switching request to the control system CPU module.
3. The system switches from the control system to the standby system.
4. Standby system (2) starts operating as the new control system to continue network control.

Point

For OPS connection, through establishing a TCP/IP connection with both systems, communication can be smoothly continued simply by changing the communication destination even when system switching occurs.

Precautions

Depending on the operating status of the standby system, system switching is not executed.

For details on the operating status of the standby system and whether system switching is executable, refer to the following.

📖 MELSEC iQ-R Process CPU Module User's Manual

In the following cases, system switching is not executed even if the RJ71EN71 issues a system switching request.

- When one module in the redundant module group is operating normally (☞ Page 298 Redundant module group settings)
- When another port in the port group is operating normally (☞ Page 299 Port group setting)

System switching cause

This section describes causes that make the RJ71EN71 issue a system switching request. Whether to issue a system switching request due to each cause is set in "Redundant System Settings" under "Application Settings". ( Page 407 Redundant System Settings)

Point

For details on system switching causes other than a system switching request from the RJ71EN71, refer to the following.

 MELSEC iQ-R Process CPU Module User's Manual

Moderate/major error and hardware failure

When detecting an error where the module cannot continue the processing, the RJ71EN71 notifies the control system CPU module about the error and issues a system switching request.

Communication error detection

Set connections targeted by communication error detection in "Redundant System Settings" under "Application Settings". ( Page 407 Redundant System Settings)

The following connections can be set as targets of communication error monitoring.

- User connections
- Auto-open UDP port
- FTP transmission port (TCP/IP)
- MELSOFT transmission port (TCP/IP)
- MELSOFT transmission port (UDP/IP)
- Simple CPU communication port

■Alive check error

When the RJ71EN71 has not communicated with the external device for a certain period of time while the connection is open, this function checks whether the external device is alive. ( Page 322 Existence Confirmation)

When no response is returned from the external device, the Ethernet-equipped module closes the relevant connection and issues a system switching request to the control system CPU module.

■ULP timeout

When the TCP/IP connection is open and when data is being sent, if no ACK response is returned from the external device for a period exceeding the TCP/ULP timer value set in the "Timer Settings for Data Communication" under "Application Settings", a send error occurs and a system switching request is issued to the control system CPU module. ( Page 392 Timer Settings for Data Communication)

■Precautions

- The auto-open UDP port and MELSOFT transmission port (UDP/IP) will be handled as targets of communication error monitoring only when the remote password setting is enabled and these ports are unlocked.
- Do not set connections with the following settings in module parameters as connections targeted by communication error detection. Otherwise, when a communication error occurs by cable disconnection detection or due to the power-off of the external device, system switching may continuously occur in a redundant system.

Setting items	Description
"Own Node Settings" under "Basic Settings"	"Do Not Open by Program" is selected for "Opening Method".
"External Device Configuration" under "Basic Settings"	"UDP" is selected for "Protocol".
	"KeepAlive" or "UDP" is set for "Existence Confirmation".

- Do not set connections with "MELSOFT Connection" set for "Communication Method" in "External Device Configuration" under "Basic Settings", as connections targeted by communication error detection. Otherwise, all MELSOFT products connected to the network will be targeted by communication error monitoring and external devices cannot be set.

Disconnection detection

Monitor the connection status of the cable connected to the RJ71EN71 in the control system.

When the disconnection state continues even after the disconnection detection monitoring time has elapsed, a system switching request is issued to the control system CPU module. Disconnection detection occurs in any of the following cases.

- Disconnection between the RJ71EN71 and the hub
- Cable disconnection at the connector on the hub side
- Power-off of the hub
- Cable disconnection at the connector on the RJ71EN71 side

Point

- Cable connection status monitoring is started after link-up. Disconnection detection is not performed on a port that has never been linked up and a port unconnected to an Ethernet cable.
- Set a value in the range from several seconds to several tens of seconds for the disconnection detection monitoring time. If the disconnection detection monitoring time is set too short, system switching may occur due to such factors as noise.

Redundant group setting

The redundant group setting is used to ensure that when the Ethernet network is duplicated in a redundant system, system switching is not executed for an error that occurs in one Ethernet network.

There are two types of redundant group setting: redundant module group setting and port group setting.

Restriction

The redundant group setting is not available for the CPU module (built-in Ethernet port part).

Redundant module group settings

Two RJ71EN71s are mounted on each of the control system and standby system, so even if a communication error occurs in one of the RJ71EN71s, when communication is possible using the network of the other RJ71EN71, a system switching request is not issued and communication by the control system continues.

The redundant module group can be set only on modules that have adjacent start I/O numbers and are mounted on adjacent slots of the base unit.

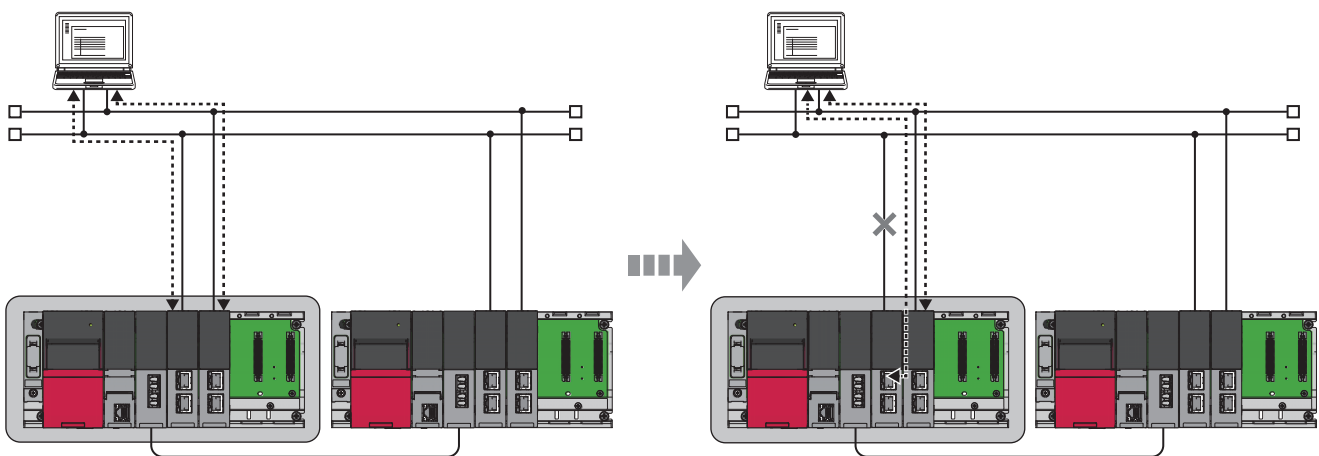

When both grouped RJ71EN71s have a communication error, a system switching request is issued.

Setting procedure

[Navigation window] ⇒ [Parameter] ⇒ [System Parameter] ⇒ [I/O Assignment] tab ⇒ [Redundant Module Group Setting]

Setting Item				
Read Mounting Status(R)		Base Mode: Automatic		
Module No.	Points	Start XY	Module Name	Redundant Module Group Setting
1	32 Points	0020	RJ71EN71(E+E)	Group
2	32 Points	0040	RJ71EN71(E+E)	Group

Point

If the RJ71EN71s set as a redundant module group are not mounted adjacently to each other on the base unit, an error occurs. Check the mounting positions on the base unit and the start I/O number again.

Port group setting

A cable is connected to each of the two Ethernet port of RJ71EN71, so even if a communication error occurs in one of the ports, when communication is possible on the other port, a system switching request is not issued and communication by the control system continues.

Restriction

This function cannot be used when "Q Compatible Ethernet" is selected in the network type.

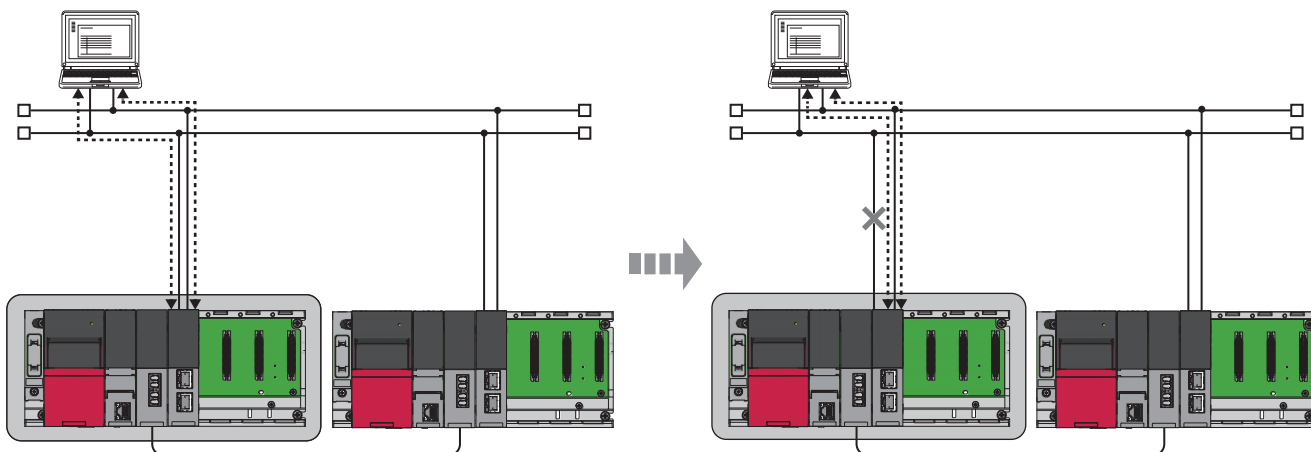

Setting procedure

Set the port group in "Redundant System Settings" under "Application Settings". (☞ Page 407 Redundant System Settings)

Point

- When "Switch Systems When a System Switching Error Occurs in Both of Port 1 and Port 2" is selected for "Port Group Setting", an event at the time of system switching is registered into the event history of the P1 side only.
- Set the same value for the port group setting on the P1 side and P2 side each.

Precautions

- The redundant group setting is enabled when the RJ71EN71 issues a system switching request. When a cause other than a moderate/major error or hardware failure in the RJ71EN71 occurs, or when a system switching request caused by other than the system switching cause from the RJ71EN71 occurs, systems are switched regardless of this setting.
- In "Redundant System Settings" under "Application Settings", set "Enable" for either "System Switching Request Issuing at Disconnection Detection" or "System Switching Request Issue at Communication Error". If "Disable" is set to the both settings, system does not switch because a system switching request is not issued to the CPU module.

Communication path bypass function

When a communication error occurs between the application and Ethernet-equipped module supporting the following redundant system, the path on which the error occurs is bypassed so that communication can continue without changing the communication path setting.

- Applications operating on OPS
- GX Works3

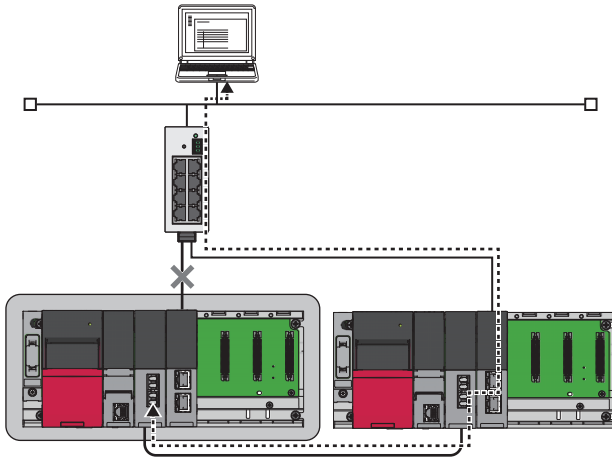

Restriction

The communications path bypass function cannot be used for direct connection. Use for connection via a hub.

Setting procedure

The bypass function is always enabled. The parameter setting is not required.

Precautions

If an Ethernet-equipped module detects a disconnection or communication error, it does not release the relevant connection until the alive check function detects an error.

When a disconnection or communication error occurs continually, if the relevant connection has not been released, an Ethernet-equipped module bypasses the communication path by using a new connection.

For that reason, if a disconnection or communication error is detected over and over again in a short period of time, available connections run out and an error occurs in GX Works3.

Both systems identical IP address setting function

When an IP address common to systems A and B (control system IP address) is used, even if system switching occurs, programs can perform communication without changing the connection destination.

Note that even when this setting is used, communication using the individual IP address of systems A and B each is possible.

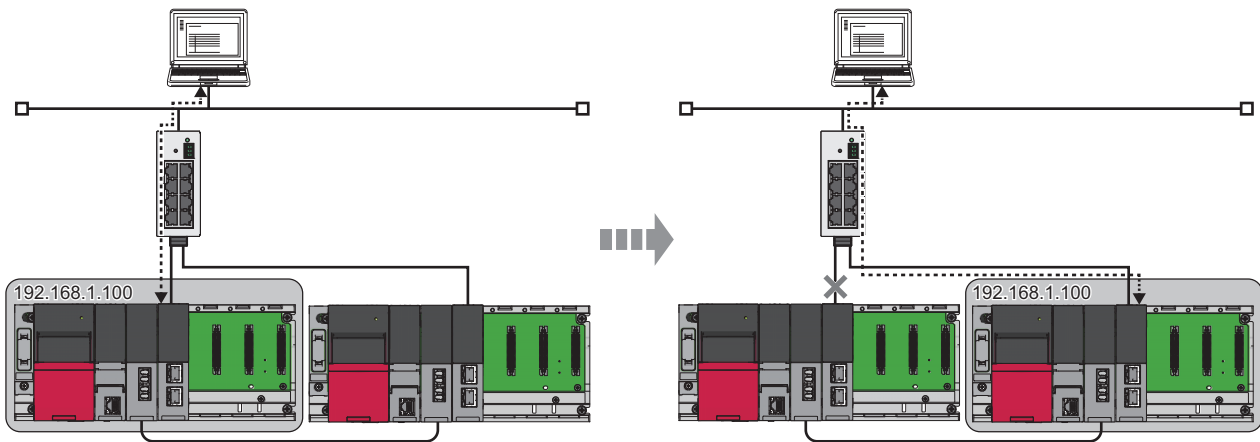

Restriction

This control system IP address cannot be used when the network type for the RJ71EN71 is set to "Q Compatible Ethernet".

Setting procedure

Set the control system IP address in "Redundant System Settings" under "Application Settings". ( Page 407 Redundant System Settings)

Access range

When communicating using the control system IP address, access is only possible from an external device in the same network.

Since a network number and station number are used for access from another network, communication using the control system IP address is not possible.

Availability of control system IP address for each function

The following table lists the availability of control system IP address for each function.

○: Available, △: Restrictions exist, ×: Not available

Function	Availability	Precautions
Connection with MELSOFT products and a GOT	△	<ul style="list-style-type: none"> When accessing from MELSOFT products (excluding GX Works3), the control system IP address can be used. When accessing from GX Works3 and a GOT, use the IP address of system A or B. When system switching occurs during file access, file access is interrupted. When accessing files, use the IP address of system A or B. When system switching occurs due to a timeout or communication error in TCP/IP communications, the connection needs to be re-opened. When the control system IP address is used, neither the write operation nor the control operation can be performed. Use the IP address of system A or B.
SLMP communications	△	<ul style="list-style-type: none"> When system switching occurs during file access, file access is interrupted. When accessing files, use the IP address of system A or B. When system switching occurs due to a timeout or communication error in TCP/IP communications, the connection needs to be re-opened.
Communications using the predefined protocol	△	<ul style="list-style-type: none"> In TCP/IP communications, the control system IP address can be used only when the Ethernet-equipped module side is set as Passive open. When it is set as Active open, use the IP address of system A or B. In UDP/IP communications, the control system IP address can be used only when the Ethernet-equipped module receives data. When system switching occurs due to a timeout or communication error in TCP/IP communications, the connection needs to be re-opened. When using the protocol used for sending or sending/receiving data, use the IP address of system A or B.
Socket communications	△	<ul style="list-style-type: none"> In TCP/IP communications, the control system IP address can be used only when the Ethernet-equipped module side is set as Passive open. When it is set as Active open, use the IP address of system A or B. In UDP/IP communications, the control system IP address can be used only when the Ethernet-equipped module receives data. When system switching occurs due to a timeout or communication error in TCP/IP communications, the connection needs to be re-opened.
Communications using the fixed buffer	△	
Communication using the random access buffer	△	
Communications using a link dedicated instruction	○	For details on dedicated instructions, refer to the following. (☞ Page 302 How to use dedicated instructions)
File transfer function (FTP server)	△	When system switching occurs during file access, file access is interrupted. When accessing files, use the IP address of system A or B.
Time setting function (SNTP client)	×	—
Security function	○	When using the remote password, after system switching occurs, the unlock processing needs to be performed again.
IP address change function	×	—
MODBUS/TCP communications	○	The device can be used when the firmware version of "42" or later is used.
Simple CPU Communication Function	○	The device can be used when the firmware version of "42" or later is used.

■How to use dedicated instructions

The following table lists how to use the control system IP address for dedicated instructions specifying an IP address.

Dedicated instruction	Usage methods
GP.CONOPEN	Set the external device IP address in the control data for the control system IP address.
SP.SOCOPEN	
OPEN	
SP.SOCCINF	
SP.SOCCSET	
READ	Set the address specification method for the target station in the control data as the IP address, and set the control system IP address to the target station.
SREAD	
WRITE	
SWRITE	

Precautions

- When using the control system IP address, set connections separately for system A and B IP addresses. When the control system IP address and IP addresses of systems A and B are used together for the same connection, loss of data, data arrival order interchange, and others may occur.
- Even when the control system IP address is used, the IP address on the programmable controller side shown in "External Device Configuration" under "Basic Settings" displays the IP address set in "Own Node Settings" under "Basic Settings".
- Do not set the control system IP address to the IP address in "PLC side I/F" of the "Specify Connection Destination Connection" window. Even when the control system IP address is set, if system switching occurs during connection, the new control system cannot be tracked.
- In TCP/IP communications, the control system IP address can be used only when the Ethernet-equipped module side is set as Passive open. When it is set as Active open, use the IP address of system A or B.
- In UDP/IP communications, the control system IP address can be used only when the Ethernet-equipped module receives data.
- When systems are switched, if communication using the control system IP address cannot be performed normally, perform the processing to update the ARP table of the external device.
- If the external device does not have a function to update the ARP table when receiving a GARP, it cannot track the new control system at the time of system switching, and communication becomes impossible until the ARP table of the external device is updated. The following table lists modules with function to update the ARP table when receiving a GARP.

Applicable module		Applicable version
MELSEC iQ-R series	Process CPU (redundant mode)	Firmware version of "04" or later
	RJ71EN71	Firmware version of "12" or later
MELSEC-Q series	QJ71E71-100	Serial number (first five digits) of "12062" or later
MELSEC-L series	LJ71E71-100	—

Point

For whether an external device not manufactured by Mitsubishi supports a function to update the ARP table when receiving a GARP, check the manual or specifications for the relevant external device.

Functions restricted in a redundant system

Functions with restrictions when communicating with a redundant system over Ethernet are as follows.

Re-initial processing

When performing the re-initial processing, specify "0H" for the modification specification (S+2) in the control data of the UINI instruction to execute the instruction.

Open/close processing

■Communications using TCP/IP

Set the Ethernet-equipped module side as Passive open and perform the open/close processing from the external device side. When Active open is performed from the Ethernet-equipped module side, if system switching occurs before execution of the close processing from the Ethernet-equipped module side, the close processing may become unexecutable.

■SLMP communications and communications using the random access buffer

When communicating with the standby system using user connection, set "Do Not Open by Program" for "Opening Method" in "Own Node Settings" under "Basic Settings".

■When the network type is "Q Compatible Ethernet"

For the standby system CPU module, the open/close processing by input/output signals cannot be performed.

Direct connection with MELSOFT products and a GOT

When the network type is "Q Compatible Ethernet", execute direct connection with the engineering tool either using the CPU module (built-in Ethernet port part) or after setting "Disable" for "System Switching Request Issuing at Disconnection Detection" in "Redundant System Settings" under "Application Settings".

When "Enable" is set for "System Switching Request Issuing at Disconnection Detection", if a cable is disconnected after a direct connection with the engineering tool is made, system switching will occur.

Searching the CPU module on the network

Even with the control system IP address set, when a CPU module search is performed, the control system IP address is not displayed. The IP addresses of systems A and B are displayed.

SLMP communications

■Message format

For the request message, set 00H to the request destination network number and FFH to the request destination station number.

■Access to the control system, standby system, and systems A and B

For SLMP communications, using the command request destination module I/O number, the control system CPU, standby system CPU, system A CPU, or system B CPU can be specified as the access destination.

By specifying the access destination CPU module, even if system switching occurs due to a communication error, access to the specified CPU module is possible using the communications path bypass function. For details on the request destination module I/O number, refer to the following.

 SLMP Reference Manual

■When accessing other stations via a redundant system

When accessing other stations by dynamic routing via a redundant system on the same Ethernet, access via the control system. An error occurs if accessing via the standby system.

When accessing other stations via the standby system on the same Ethernet, set "Routing Setting" of "CPU Parameter".

■When the control system IP address is not used

When the control system IP address is not used, access the control system CPU module by using the following procedure.

1. Execute the open processing in the order system A → B.
2. Read 'Control system judgment flag' (SM1634) and 'Standby system judgment flag' (SM1635) to judge the control system.
3. Specify the control system CPU module for the request destination module I/O number and send a command message.
4. Check the response message.

To continue the communication, send command messages continuously.

5. Execute the close processing in the order the control system → the standby system.

Communications using the predefined protocol

When the control system IP address is not used, establish the connection with the Ethernet-equipped modules of both systems and perform communications. When only sending data from the external device to the Ethernet-equipped module, send the data to the Ethernet-equipped modules of both the control and standby systems because the system switching timing is not able to be ascertained.

Socket communications

■Receive processing by the standby system

If data is sent to the standby system Ethernet-equipped module, data reception processing will not be performed because the module reads and discards the received data.

■Receive processing with interrupt program

If system switching occurs before execution with the interrupt program, and the control system is switched to the standby system, the interrupt factor will not be transferred to the other system. The interrupt factor will be retained on the own system. Therefore, if system switching occurs again and the own system becomes the control system, the interrupt program will be executed by the retained interrupt factor.

■When data is sent from an external device

- When the control system IP address is not used, the system switching timing is not able to be ascertained. Send data to the Ethernet-equipped modules of both the control and standby systems.
- To use the control system IP address, check whether the Ethernet-equipped module is alive from the external device side.

Communications using the fixed buffer

■Receive processing by the standby system

If data is sent to the standby system Ethernet-equipped module, data reception processing will not be performed because the module reads and discards the received data.

■Receive processing with interrupt program

If system switching occurs before execution with the interrupt program, and the control system is switched to the standby system, the interrupt factor will not be transferred to the other system. The interrupt factor will be retained on the own system. Therefore, if system switching occurs again and the own system becomes the control system, the interrupt program will be executed by the retained interrupt factor.

■When data is sent from an external device

The data sending method will differ according to whether the communication method and the control system IP address are used.

Communication method	Control system IP address	Send method
Fixed Buffer (Procedure Exist)	Not Use	When system switching occurs because of a response timeout to the Ethernet-equipped module, send by changing the connection destination to the other system.
	Use	When system switching occurs because of a response timeout to the Ethernet-equipped module, open a new control system. Also, check whether the Ethernet-equipped module is alive from the external device side.
Fixed Buffer (No Procedure)	—	System switching timing cannot be ascertained because of no setting for the response timeout. Send data to the Ethernet-equipped modules of both systems.

Point

When performing the resend processing when system switching occurs, pay attention to the following.

- When communicating while synchronizing send and receive, system switching may occur in the middle of communication, and systems may be switched in a state where send and receive are not synchronized together. When system switching occurs, out of safety considerations, restart communication after initialization of synchronization.
- When using dedicated instructions, note that the completion of the execution of a write instruction needs to be executed is difficult to judge, and that the same instruction needs to be executed again. Note, however, that the same instruction may be executed twice.

Communication using the random access buffer

Because tracking is not performed on the buffer memory of the Ethernet-equipped module, when writing data to the random access buffer, write the same data to the control and standby systems.

Communications using a dedicated instruction

■System switching during dedicated instruction execution

When systems are switched during execution of a dedicated instruction, the dedicated instruction may not be completed. Execute the dedicated instruction again from the control system CPU module after system switching.

■When the control system IP address is used

When using dedicated instructions for the Ethernet-equipped modules of a redundant system, the same IP address can be set for both systems A and B by setting the control system IP address for the external device IP address in the control data. (☞ Page 301 Both systems identical IP address setting function)

■Specification of the target station CPU type in dedicated instructions

For a dedicated instruction in which the target station CPU type is specified as a control data, the control system CPU, standby system CPU, system A CPU, and system B CPU can be accessed by specifying the type. By specifying the access destination CPU module, even if system switching occurs due to a communication error, access to the specified CPU module is possible using the communications path bypass function. (📖 MELSEC iQ-R Programming Manual (CPU Module Instructions, Standard Functions/Function Blocks, 📖 MELSEC iQ-R Programming Manual (Module Dedicated Instructions))

■Processing when a dedicated instruction abnormally ends

When the dedicated instruction is executed by specifying the access destination CPU module, it may be completed with an error if systems are switched in the target station. If the dedicated instruction was completed with an error, execute it again.

■SEND instruction

- When the target station is in a redundant system, the communication request source station must identify that the target station is the control system to execute the SEND instruction. When the target station is the standby system, the RECV instruction is not executed at the target station after data is sent by the SEND instruction, and the target station storage channel becomes occupied and unable to be used.
- When a redundant system exists in a network where broadcast communications are performed, the RECV instruction is not executed at the standby system, and the storage channel becomes occupied and unable to be used.

■RECV and RECVS instructions

- When the SEND instruction is executed for the control system, if the systems are switched before execution of the RECV instruction and interrupt program, the control system retains 'RECV instruction execution request' (Un\G5301) and the interrupt program interrupt factor (interrupt pointer). If system switching occurs again, and the standby system is switched to the control system, the RECV instruction and interrupt program will be executed by the retained 'RECV instruction execution request' (Un\G5301) and interrupt program interrupt factor.
- When the SEND instruction is executed for the standby system, and the standby system receives data from the sending station, the standby system retains 'RECV instruction execution request' (Un\G5301) and the interrupt program interrupt factor (interrupt pointer). Therefore, when the standby system is switched to the control system due to system switching, the RECV instruction and interrupt program will be executed by the retained 'RECV instruction execution request' (Un\G5301) and interrupt program interrupt factor.

■REQ instruction

When performing remote STOP or remote RUN on a redundant system, do as follows: Perform STOP on the standby system → STOP on the control system → RUN on the control system → RUN on the standby system.

File transfer function (FTP server)

Perform file writing with the file transfer function (FTP server) as follows.

1. Log into the Ethernet-equipped modules of both systems.
2. Perform remote STOP on the CPU modules of both systems.*1
3. Write the file to the CPU modules of both systems.*2
4. Perform remote RUN on the CPU modules of both systems.
5. Log out from the Ethernet-equipped modules of both systems.
6. Clear the errors of the standby system CPU module.*3

*1 When the status of the control system CPU module is STOP state, a continuation error occurs in the standby system CPU module.

*2 When the parameter file has been written, the CPU modules must be reset.

*3 When the status of the control system CPU module changed from STOP to RUN state, check the error status of the standby system CPU module, and if an error has occurred, turn on 'Error reset' (SM50) to clear the error.

Time setting function (SNTP client)

When the time is set by a program, an error may occur if system switching occurs in the timing in which the program is executed. If an error occurs, execute the program after system switching.

IP filter

When using an IP filter, exclude the control system IP address, system A IP address, and system B IP address from the IP filter settings. Otherwise, operation may not be performed normally.

IP address change function

Do not use the IP address change function to change IP addresses in a redundant system. Normal communication is not possible if an IP address has been changed. When the IP address is changed using the IP address change function, clear the IP address storage area.

Communications with Different Networks

Precautions exist for communications with different networks via a redundant system. (📖 Page 534 When the networks contain a redundant system)

MODBUS/TCP slave function

■When the control system IP address is not used

The processing to determine the present control system on the MODBUS/TCP master device side and to switch the communication destination (system A or system B) is required. Whether the communication destination is the control system or the standby system is determined by reading Control system judgment flag (SM1634) and Standby system judgment flag (SM1635) of the slave station CPU module.

■When the control system IP address is used

Once system switching is executed, TCP connection used before is disconnected.

Execute the re-connection processing from the MODBUS/TCP master device to restart TCP connection.

■When the data is written to the buffer memory (H)

The buffer memory of the Ethernet-equipped module is not tracked. When executing the MODBUS command for write to the MODBUS device assigned in the buffer memory (H), write the same data to the system A and system B.

Simple CPU communications

■When system switching is executed

Communications stop temporarily due to execution of system switching, therefore communications may not execute within the "Execution Interval" specified in the "Simple CPU Communication Setting" under "Application Settings".

■When User setting area (Un\G722500 to Un\G1246787) is used

The buffer memory of the Ethernet-equipped module is not tracked. When writing the data to User setting area (Un\G722500 to Un\G1246787), write the same data to the system A and system B.

Point

Even if system switching is executed, the data of User setting area (Un\G722500 to Un\G1246787) is held in the system A and system B.

Simple device communications

Since redundant systems are not supported, the operation is not guaranteed.

Setting example

This section describes the setting details for socket communications in a redundant system.

System configuration example

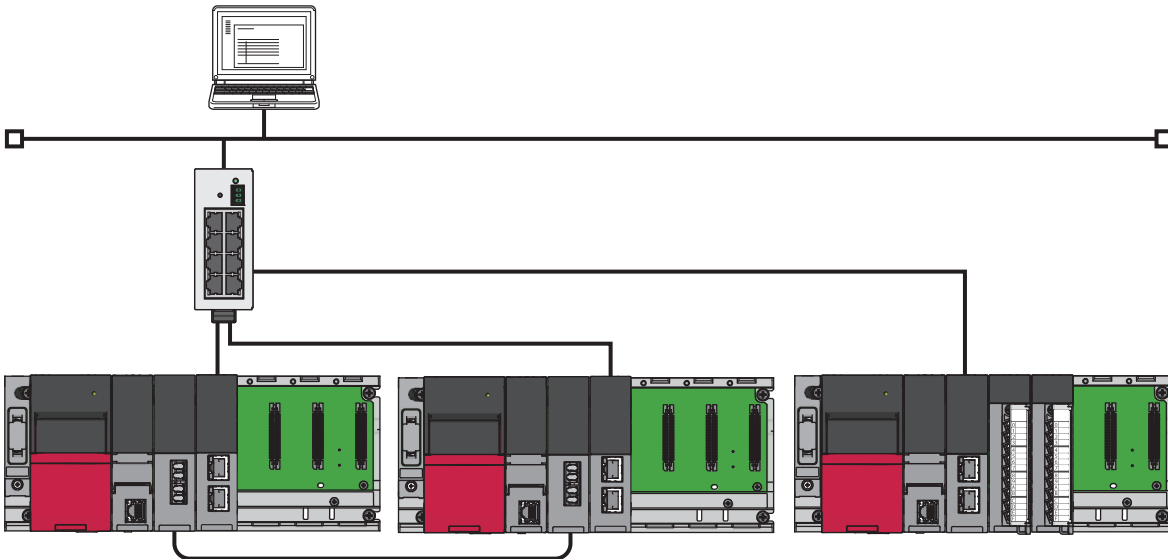

Receiving side (redundant system) settings

Connect the engineering tool to the CPU module to be set as the control system and set the parameters.

In a redundant system, the same program and parameter are written to both systems. A new project does not need to be created for the standby system.

1. Set the CPU module as follows.

[Project] ⇒ [New]

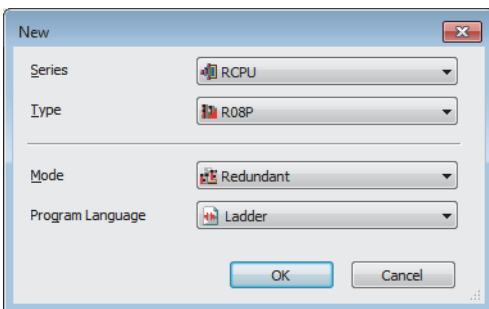

2. Click the [OK] button to add the module labels of the CPU module.

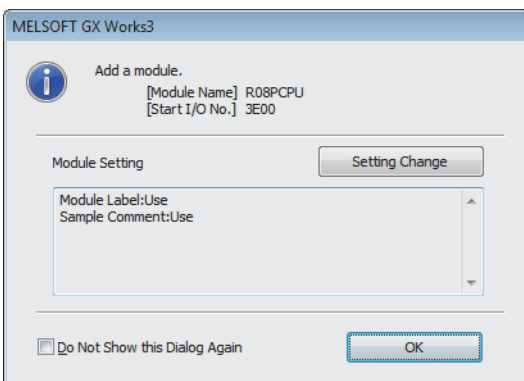

3. In the I/O assignment setting, set the redundant function module for slot No.0.

[Navigation window] ⇒ [Parameter] ⇒ [System Parameter] ⇒ [I/O Assignment] tab ⇒ [I/O Assignment Setting]

Add New Module

Module Selection

Module Type: CPU Extension
Module Name: R6RFM
Station Type:

Advanced Settings

Mounting Position

Mounting Base: Main Base
Mounting Slot No.: 0
Start I/O No. Specification: Not Set
Start I/O No.: 0000 H
Number of Occupied Points per 1 Slot: 32 Points

Module Type
Select module type.

OK Cancel

4. Set the RJ71EN71 for slot No.1

Add New Module

Module Selection

Module Type: Information Module
Module Name: RJ71EN71(E+E)
Port 1 Network Type: Ethernet
Port 1 Station Type:
Port 2 Network Type: Ethernet
Port 2 Station Type:

Advanced Settings

Mounting Position

Mounting Base: Main Base
Mounting Slot No.: 1
Start I/O No. Specification: Not Set
Start I/O No.: 0020 H
Number of Occupied Points per 1 Slot: 32 Points

Module Type
Select module type.

OK Cancel

5. Click the [OK] button to add the module labels of the RJ71EN71.

MELSOFT GX Works3

Add a module.

[Module Name] RJ71EN71(E+E)
[Start I/O No.] 0020

Module Setting Setting Change

Module Label:Use

Do Not Show this Dialog Again OK

6. Set the items in "Basic Settings" as follows.

[Navigation window] ⇒ [Parameter] ⇒ [Module Information] ⇒ [RJ71EN71] ⇒ [Port 1 Module Parameter (Ethernet)] ⇒ [Basic Settings]

Setting Item	Item	Setting
Own Node Settings	Parameter Setting Method	Parameter Editor
	IP Address	192.168.1.101
	Subnet Mask	. . .
	Default Gateway	. . .
	Communications by Network No./Station No.	Disable
	Setting Method	Use IP Address
	Network Number	----
	Station No.	----
	Transient Transmission Group No.	0
	Enable/Disable Online Change	Disable All (SLMP)
	Communication Data Code	Binary
Opening Method	Do Not Open by Program	
External Device Configuration	External Device Configuration	<Detailed Setting>

7. Set the network configuration as follows.

[Navigation window] ⇒ [Parameter] ⇒ [Module Information] ⇒ [RJ71EN71] ⇒ [Port 1 Module Parameter (Ethernet)] ⇒ [Basic Settings] ⇒ [External Device Configuration]

Ethernet Configuration (Start I/O: 0020)

Ethernet Configuration Edit View Close with Discarding the Setting Close with Reflecting the Setting

No.	Model Name	Communication Method	Protocol	Fixed Buffer Send/Receive Setting	PLC		Sensor/Device				Existence Confirmation	
					IP Address	Port No.	MAC Address	Host Name	IP Address	Port No.		Subnet Mask
	Host Station				192.168.1.101							
1	MELSOFT Connection Module	MELSOFT Connection	TCP		192.168.1.101							KeepAlive
2	MELSOFT Connection Module	MELSOFT Connection	TCP		192.168.1.101							KeepAlive
3	MELSOFT Connection Module	MELSOFT Connection	TCP		192.168.1.101							KeepAlive
4	MELSOFT Connection Module	MELSOFT Connection	TCP		192.168.1.101							KeepAlive
5	MELSOFT Connection Module	MELSOFT Connection	TCP		192.168.1.101							KeepAlive
6	MELSOFT Connection Module	MELSOFT Connection	TCP		192.168.1.101							KeepAlive
7	MELSOFT Connection Module	MELSOFT Connection	TCP		192.168.1.101							KeepAlive
8	MELSOFT Connection Module	MELSOFT Connection	TCP		192.168.1.101							KeepAlive
9	MELSOFT Connection Module	MELSOFT Connection	TCP		192.168.1.101							KeepAlive
10	MELSOFT Connection Module	MELSOFT Connection	TCP		192.168.1.101							KeepAlive
11	MELSOFT Connection Module	MELSOFT Connection	TCP		192.168.1.101							KeepAlive
12	MELSOFT Connection Module	MELSOFT Connection	TCP		192.168.1.101							KeepAlive
13	MELSOFT Connection Module	MELSOFT Connection	TCP		192.168.1.101							KeepAlive
14	MELSOFT Connection Module	MELSOFT Connection	TCP		192.168.1.101							KeepAlive
15	MELSOFT Connection Module	MELSOFT Connection	TCP		192.168.1.101							KeepAlive
16	MELSOFT Connection Module	MELSOFT Connection	TCP		192.168.1.101							KeepAlive
17	Unpassive Connection Module	Socket Communication	TCP		192.168.1.101	4096						KeepAlive

Connection No.	Connection No. 2	Connection No. 3	Connection No. 4	Connection No. 5	Connection No. 6	Connection No. 7	Connection No. 8	Connection No. 9	Connection No. 10	Connection No. 11	Connection No. 12	Connection No. 13	Connection No. 14	Connection No. 15	Connection No. 16	Connection No. 17
MEL	MEL	MEL	MEL	MEL	MEL	MEL	MEL	MEL	MEL	MEL	MEL	MEL	MEL	MEL	MEL	UP
MELSOFT Connection Module	MELSOFT Connection Module	MELSOFT Connection Module	MELSOFT Connection Module	MELSOFT Connection Module	MELSOFT Connection Module	MELSOFT Connection Module	MELSOFT Connection Module	MELSOFT Connection Module	MELSOFT Connection Module	MELSOFT Connection Module	MELSOFT Connection Module	MELSOFT Connection Module	MELSOFT Connection Module	MELSOFT Connection Module	MELSOFT Connection Module	Unpassive Connection Module

Host Station Connected Count : 17

8. Set the redundant settings in the following items.

[Navigation window] ⇒ [Parameter] ⇒ [Module Information] ⇒ [RJ71EN71] ⇒ [Port 1 Module Parameter (Ethernet)] ⇒ [Application Settings] ⇒ [Redundant System Settings]

Setting Item	Item	Setting
Redundant System Settings		
	Own Node (System A) IP Address	192.168.1.101
	System B IP Address	192.168.1.102
	Own Node (System A) Station Number	-----
	System B Station Number	-----
	Use of Control System IP Address	Use
	Control System IP Address	192.168.1.100
	Own Node (System A) Module Operation Mode	Online
	System B Module Operation Mode	Online
	Port Group Setting	No Setting
	System Switching Request Issuing at Disconnection Detection	Enable
	Disconnection Detection Monitoring Time	2
	Unit	s
	System Switching Request Issue at Communication Error	Enable
	User Connection	<Detailed Setting>
	System Connection	
	Auto-open UDP Port	No System Switching Request at Communication Error
	MELSOFT Transmission Port (UDP/IP)	No System Switching Request at Communication Error
	MELSOFT Transmission Port (TCP/IP)	No System Switching Request at Communication Error
	FTP Transmission Port (TCP/IP)	No System Switching Request at Communication Error

9. Set whether to issue a system switching request for the user connection.

[Navigation window] ⇒ [Parameter] ⇒ [Module Information] ⇒ [RJ71EN71] ⇒ [Port 1 Module Parameter (Ethernet)] ⇒ [Application Settings] ⇒ [Redundant System Settings] ⇒ [System Switching Request Issue at Communication Error] ⇒ [User Connection]

Connection No.	System Switching Request	Communication Method	Protocol	Fixed Buffer Send/Receive Setting	Existence Confirmation	Comment
1	Not to Issue	MELSOFT Connection	TCP		KeepAlive	
2	Not to Issue	MELSOFT Connection	TCP		KeepAlive	
3	Not to Issue	MELSOFT Connection	TCP		KeepAlive	
4	Not to Issue	MELSOFT Connection	TCP		KeepAlive	
5	Not to Issue	MELSOFT Connection	TCP		KeepAlive	
6	Not to Issue	MELSOFT Connection	TCP		KeepAlive	
7	Not to Issue	MELSOFT Connection	TCP		KeepAlive	
8	Not to Issue	MELSOFT Connection	TCP		KeepAlive	
9	Not to Issue	MELSOFT Connection	TCP		KeepAlive	
10	Not to Issue	MELSOFT Connection	TCP		KeepAlive	
11	Not to Issue	MELSOFT Connection	TCP		KeepAlive	
12	Not to Issue	MELSOFT Connection	TCP		KeepAlive	
13	Not to Issue	MELSOFT Connection	TCP		KeepAlive	
14	Not to Issue	MELSOFT Connection	TCP		KeepAlive	
15	Not to Issue	MELSOFT Connection	TCP		KeepAlive	
16	Not to Issue	MELSOFT Connection	TCP		KeepAlive	
17	Issue	Socket Communication	TCP		KeepAlive	

10. In the "System A/B Setting" window, set the redundant function module of own system to system A, and either reset the CPU modules of both systems or power off and on both systems.

[Online] ⇒ [Redundant PLC Operation] ⇒ [System A/B Setting]

Please set the connective system of redundant system. Please set other system based on the setting of connective system.	
System Status	Set the Connective System
Connective System: <input type="text" value="System Unknown"/>	<input type="text" value="System A"/>
Other System: <input type="text" value="System Unknown"/>	
<input type="button" value="Execute"/> <input type="button" value="Close"/>	

11. Write the set parameters to the system A CPU module.

 [Online] ⇒ [Write to PLC]

12. Click the [Yes] button to write to the CPU modules of both systems.

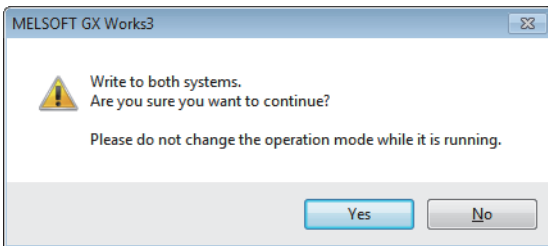

13. Either reset the CPU modules of both systems or power off and on both systems.

Point

In this setting example, default settings are used for the parameters other than those described. For the parameter setting, refer to the chapter explaining the parameters in this manual. ( Page 317 PARAMETER SETTINGS)

Sending side

Connect the engineering tool to the CPU module on the sending side and set the parameters.

1. Set the CPU module as follows.

 [Project] ⇒ [New]

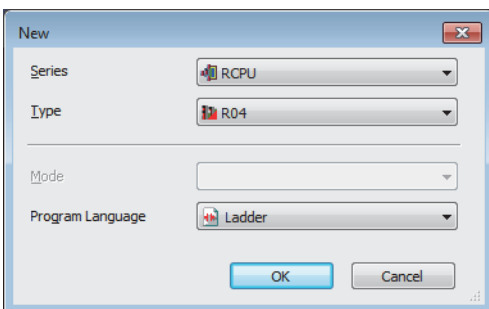

2. Click the [Setting Change] button in the following window and set the item to use module labels.

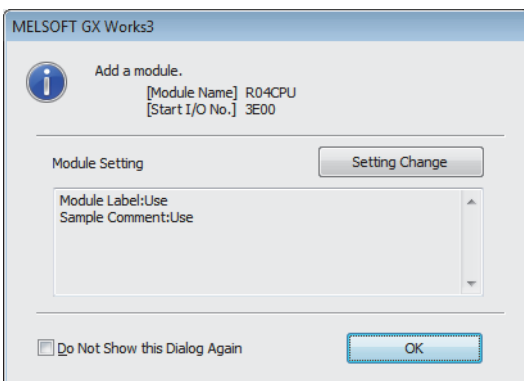

3. Click the [OK] button to add the module labels of the CPU module.

4. In the I/O assignment setting, set the RJ71EN71 for slot No.0.

[Navigation window] ⇒ [Parameter] ⇒ [System Parameter] ⇒ [I/O Assignment] tab ⇒ [I/O Assignment Setting]

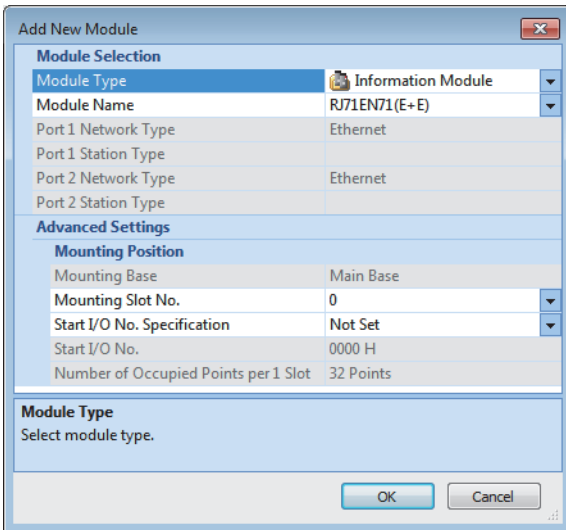

5. Click the [OK] button to add the module labels of the RJ71EN71.

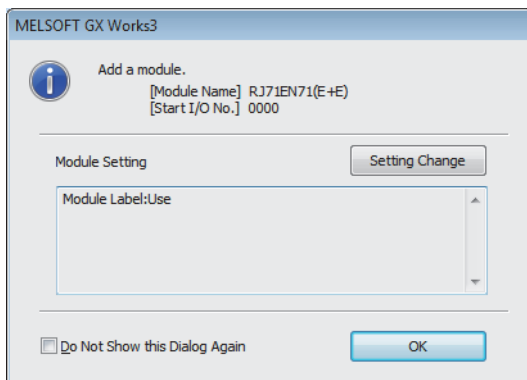

6. Set the items in "Basic Settings" as follows.

[Navigation window] ⇒ [Parameter] ⇒ [Module Information] ⇒ [RJ71EN71] ⇒ [Port 1 Module Parameter (Ethernet)] ⇒ [Basic Settings]

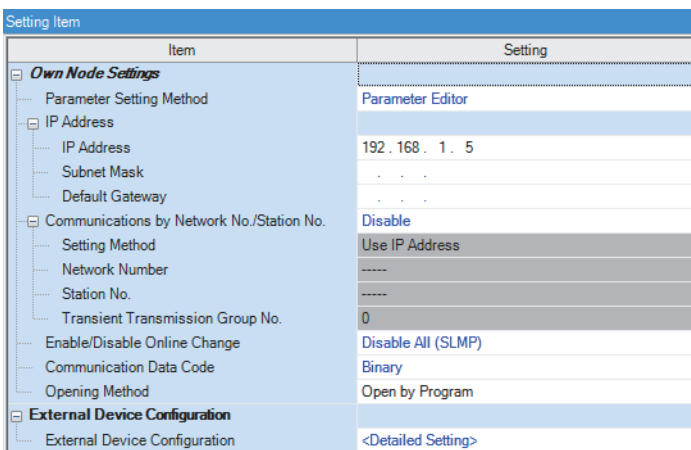

7. Set the network configuration as follows. The redundant system control system IP address is specified for the send destination IP address.

[Navigation window] ⇒ [Parameter] ⇒ [Module Information] ⇒ [RJ71EN71] ⇒ [Port 1 Module Parameter (Ethernet)] ⇒ [Basic Settings] ⇒ [External Device Configuration]

The screenshot displays the 'Ethernet Configuration' window. The main area contains a table with the following data:

No.	Model Name	Communication Method	Protocol	Fixed Buffer Send/Receive Setting	PLC		Sensor/Device				Existence Confirmation	
					IP Address	Port No.	MAC Address	Host Name	IP Address	Port No.		Subnet Mask
	Host Station				192.168.1.5							
1	MELSOFT Connection Module	MELSOFT Connection	TCP		192.168.1.5							KeepAlive
2	MELSOFT Connection Module	MELSOFT Connection	TCP		192.168.1.5							KeepAlive
3	MELSOFT Connection Module	MELSOFT Connection	TCP		192.168.1.5							KeepAlive
4	MELSOFT Connection Module	MELSOFT Connection	TCP		192.168.1.5							KeepAlive
5	MELSOFT Connection Module	MELSOFT Connection	TCP		192.168.1.5							KeepAlive
6	MELSOFT Connection Module	MELSOFT Connection	TCP		192.168.1.5							KeepAlive
7	MELSOFT Connection Module	MELSOFT Connection	TCP		192.168.1.5							KeepAlive
8	MELSOFT Connection Module	MELSOFT Connection	TCP		192.168.1.5							KeepAlive
9	MELSOFT Connection Module	MELSOFT Connection	TCP		192.168.1.5							KeepAlive
10	MELSOFT Connection Module	MELSOFT Connection	TCP		192.168.1.5							KeepAlive
11	MELSOFT Connection Module	MELSOFT Connection	TCP		192.168.1.5							KeepAlive
12	MELSOFT Connection Module	MELSOFT Connection	TCP		192.168.1.5							KeepAlive
13	MELSOFT Connection Module	MELSOFT Connection	TCP		192.168.1.5							KeepAlive
14	MELSOFT Connection Module	MELSOFT Connection	TCP		192.168.1.5							KeepAlive
15	MELSOFT Connection Module	MELSOFT Connection	TCP		192.168.1.5							KeepAlive
16	MELSOFT Connection Module	MELSOFT Connection	TCP		192.168.1.5							KeepAlive
17	Active Connection Module	Socket Communication	TCP		192.168.1.5	8192			192.168.1.100	4096		KeepAlive

Below the table, a visual representation shows 17 connection modules labeled 'Connection No. 1' through 'Connection No. 17'. Modules 1-16 are 'MELSOFT Connection Module' and module 17 is 'Active Connection Module'. A 'Host Station Connected Count' of 17 is shown on the left.

8. Write the set parameters to the CPU module. Then reset the CPU module or power off and on the system.

[Online] ⇒ [Write to PLC]

Point

In this setting example, default settings are used for the parameters other than those described. For the parameter setting, refer to the chapter explaining the parameters in this manual. (Page 317 PARAMETER SETTINGS)

1.19 Discard Received Data at CPU STOP

The received data from the communication destination is discarded when the status of the CPU module is changed from RUN to STOP (PAUSE).

This function is available for below two communication methods:

- Communications using the fixed buffer
- Socket communications

Setting procedure

This function can be enabled/disabled by directly changing the value in 'Discard received data at CPU STOP setting area' of buffer memory areas with a program.

■Discard received data at CPU STOP setting area



RJ71EN71, RnENCPU (network part): Un\G1950032 to Un\G1950039

CPU module (built-in Ethernet port part): Un\G275

2 PARAMETER SETTINGS

This chapter describes the parameter settings required for communications between the Ethernet-equipped module and external devices.

2.1 Setting Parameters

1. Add the RJ71EN71 in the engineering tool.*1
 [Navigation window] ⇒ [Parameter] ⇒ [Module Information] ⇒ Right-click ⇒ [Add New Module]
2. The basic setting and application setting are included in the parameter settings. Select one of the settings from the tree on the window shown below.
3. After setting parameters, click the [Apply] button.
 [Navigation window] ⇒ [Parameter] ⇒ Target module ⇒ [Module Parameter]
4. Write the settings to the CPU module using the engineering tool.
 [Online] ⇒ [Write to PLC]
5. The settings are reflected by resetting the CPU module or powering off and on the system.

*1 Addition of the module is not required when using the Ethernet function of the CPU module (CPU part for the RnENCPU).

2.2 Basic Settings

Set the own node settings and external device configuration of the Ethernet-equipped module.

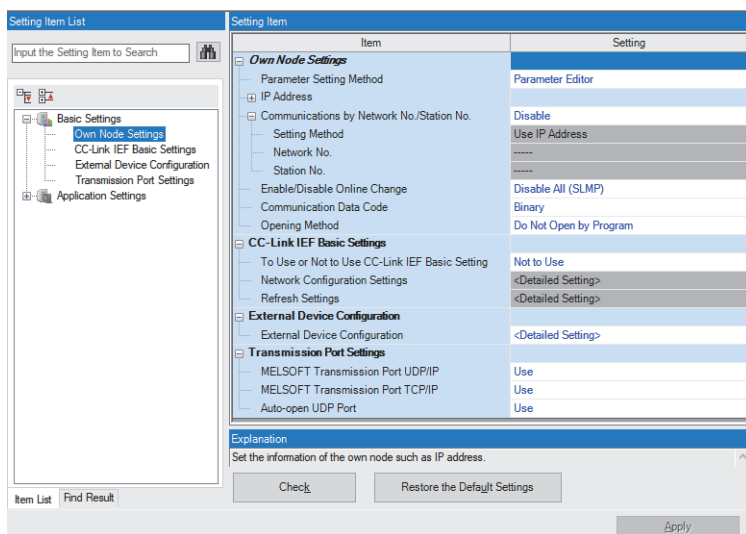

Setting items	Description	Reference
Own Node Settings	Set the IP address and communication data code of the Ethernet-equipped module.	Page 318 Own Node Settings
CC-Link IEF Basic Settings*1	Set the network configuration settings and refresh settings of CC-Link IE Field Network Basic.	CC-Link IE Field Network Basic Reference Manual
External Device Configuration	Set the method and protocol used for communicating with external devices.	Page 320 External Device Configuration
Transmission Port Settings	Set the Ethernet ports used for communication and functions.	Page 323 Transmission Port Settings

*1 This setting is displayed only for modules supporting CC-Link IE Field Network Basic.

Own Node Settings

Set the IP address and communication data code of the Ethernet-equipped module.

Item	Description	Setting range	
Parameter Setting Method	Set the own station settings by parameters.	Parameter Editor (fixed)	
IP Address	IP Address	Set the IP address of the own station. Set the IP address class within the range of classes A, B and C. Ensure that the Ethernet-equipped module on the own station and the external device to be communicated with have the same class and subnet address. Consult with the network manager for the IP address setting. When the parameters are written without the IP address set (blank), the following IP address is set. <ul style="list-style-type: none"> • P1 connector of RJ71EN71: 192.168.3.40 • P2 connector of RJ71EN71: 192.168.4.40 • RnENCPU (network part): 192.168.3.40 • CPU module (built-in Ethernet port part): 192.168.3.39 When using the IP address in a redundant system, use as the system A IP address.	<ul style="list-style-type: none"> • Blank • 0.0.0.1 to 223.255.255.254 (Default: Blank)
	Subnet Mask	Set the subnet mask pattern of the default gateway when setting the IP address of the default gateway and communicating with an external device on another network via a router. All the devices on a subnetwork must have the same subnet mask. This setting is not required when communicating in single network.	<ul style="list-style-type: none"> • Blank • 0.0.0.1 to 255.255.255.255 (Default: Blank)
	Default Gateway	Set the IP address of the default gateway (the device which the own node passes through to access a device of another network). Set the value that satisfies the following conditions. <ul style="list-style-type: none"> • The IP address class is any of A, B, and C. • The subnet address of the default gateway is the same as that of the Ethernet-equipped module on the own station. • The host address bits are not all "0" or all "1". 	<ul style="list-style-type: none"> • Blank • 0.0.0.1 to 223.255.255.254 (Default: Blank)
Communications by Network No./Station No.	—	Select "Enable" to set the network number, station number, and transient transmission group number ^{*1} . This setting is not required when the following functions are not used. <ul style="list-style-type: none"> • Connection with the MELSOFT products and the GOT (when connecting by specifying the network number and station number) • Communications using the SLMP (when specifying the target station with its network number and station number)^{*1} • Communications using a link dedicated instruction^{*1} • Communications with different networks 	<ul style="list-style-type: none"> • Disable • Enable (Default: Disable)
	Setting Method	Select the method for setting the network number and station number. (☞ Page 319 Setting Method)	<ul style="list-style-type: none"> • Use IP Address • Not Use IP Address (Default: Use IP Address)
	Network Number	Enter the network number of the own station when selecting "Not Use IP Address" in "Setting Method". Set a unique network number.	1 to 239 (Default: 1)
	Station No.	Enter the station number of the own station when selecting "Not Use IP Address" in "Setting Method".	1 to 120 (Default: 1)
	Transient Transmission Group No. ^{*1}	Set the transient transmission group number of the own station.	0 to 32 (Default: 0)
Enable/Disable Online Change	Select whether to enable external devices to write data in SLMP communications while the CPU module is in RUN state. (☞ Page 319 Enable/Disable Online Change)	<ul style="list-style-type: none"> • Disable All (SLMP) • Enable All (SLMP) (Default: Disable All (SLMP)) 	
Communication Data Code	Select the communication data code used for communications.	<ul style="list-style-type: none"> • Binary • ASCII (Default: Binary) 	
Opening Method	Select how to open a connection when using UDP/IP communications or Passive open of TCP/IP communications. <ul style="list-style-type: none"> • When "Do Not Open by Program" is selected, a connection is open when the system received the Active request. Program for open/close processing is not required. • When "Open by Program" is selected, the open/close processing are performed by a program. The module cannot communicate when the CPU module is in STOP state. 	<ul style="list-style-type: none"> • Do Not Open by Program • Open by Program (Default: Do Not Open by Program) 	

*1 This setting is not available for the CPU module (built-in Ethernet port part).

Details of items

■Setting Method

When "Use IP Address" is selected, network number and station number will be set from the third and fourth octet of the IP address.

For example, when IP address is set to 192.168.1.10, the network number is set to "1" and the station number is set to "10". When the IP address is used, the value out of the range of the network number and station number cannot be set in the third octet and fourth octet

When "Not Use IP Address" is selected, set the network number and station number.

Point

When "Port 1 Network Type" and "Port 2 Network Type" are set to "Ethernet" for the RJ71EN71 and the same network number is set for both of P1 and P2, P1 is always used for relay to other networks.

■Enable/Disable Online Change

Select whether to enable SLMP data write command received by the Ethernet-equipped module received while the CPU module is in RUN state.

This setting is effective for not only the CPU module on the own station but also the ones on the other stations.

When "Disable All (SLMP)" is selected, data writing using SLMP is disabled while the CPU module is in RUN state.

When "Enable All (SLMP)" is selected, data writing using SLMP is enabled even when the CPU module is in RUN state.

To write data to the FTP server when the CPU module is in RUN state, set "Allow Online Change" under "FTP Server Settings" in "Application Settings". ( Page 329 FTP Server Settings)

External Device Configuration

Set the method and protocol used for communicating with external devices.

Setting procedure

The procedure for setting the external device to be connected is shown below.

1. Select the external device to be connected in "Module List" and drag it to "List of devices" or "Device map area".

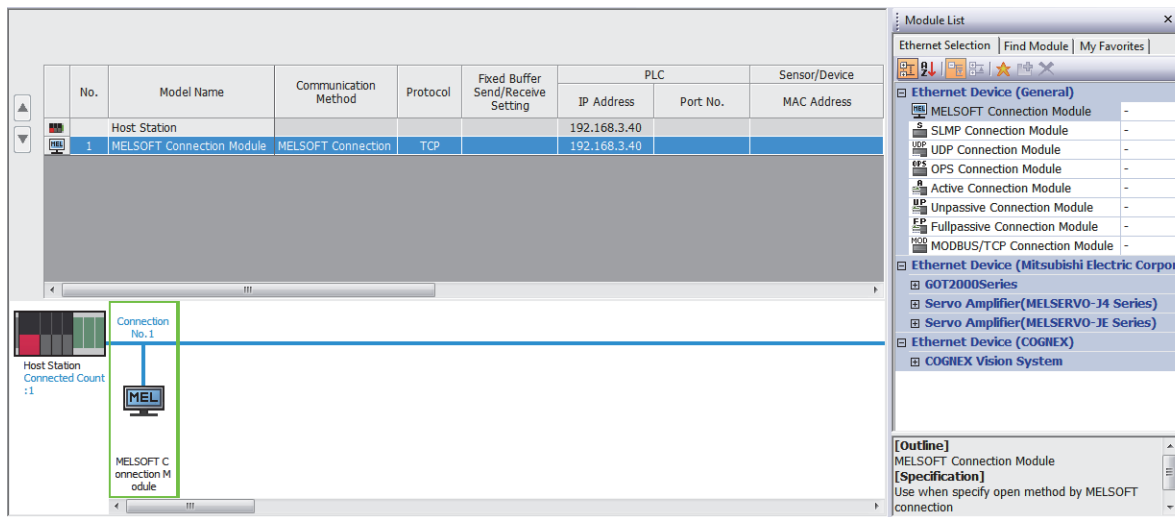

2. Set the required items. The required items vary depending on the selected external device.

3. Select [Close with Reflecting the Setting] to finish the external device configuration settings.

[Ethernet Configuration] ⇒ [Check] ⇒ [System Configuration]

Restriction

External devices must be set from the connection No.1

To use specific connection number, set "MELSOFT Connection Module" in the connection number not used.

- When only the connection No.5 is used.

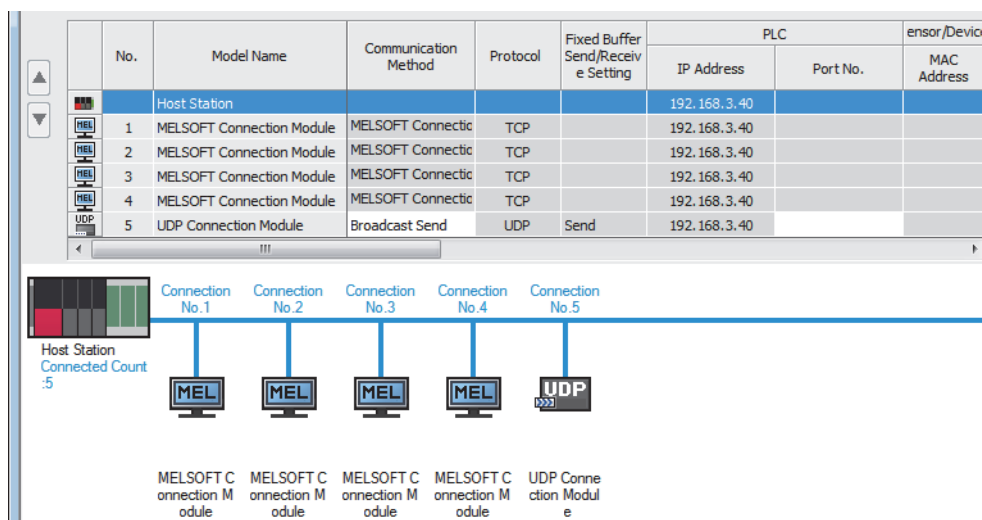

Setting items

Item	Description	Setting range	
[Detect Now] button	Execute the automatic detection of connected devices. The [Detect Now] button is displayed only when the CPU module (built-in Ethernet port part) is used. For details, refer to the following.  iQ Sensor Solution Reference Manual	—	
No.	Connection number for distinguishing settings for each user connection.	The number is set in the following range starting with 1. • RJ71EN71 and RnENCPU (network part): 1 to 64 ^{*1} • CPU module (built-in Ethernet port part): 1 to 16	
Model Name	The name of the external device is displayed.	—	
Communication Method	Set the method for communication with the external device.	<ul style="list-style-type: none"> • Broadcast Send • Broadcast Receive • Fixed Buffer (Procedure Exist)^{*2} • Fixed Buffer (No Procedure)^{*2} • Random Access Buffer^{*2} • Predefined Protocol • Socket Communication^{*3} • MELSOFT Connection • SLMP • OPS Connection • MODBUS/TCP^{*2} 	
Protocol	Select the communication protocol for the external device.	<ul style="list-style-type: none"> • TCP^{*4} • UDP^{*4} 	
Fixed Buffer Send/Receive Setting ^{*2}	For communications using the fixed buffer, select whether to use the buffer for sending or for receiving in a connection to the external device.	<ul style="list-style-type: none"> • Send • Receive • Pairing (Receive) • Pairing (Send) 	
PLC	IP Address	The IP address of the own node, which is set in "IP Address" under "Own Node Settings" of "Basic Settings", is displayed. Or the IP address of the communication destination set in the device supporting iQSS is displayed when using the automatic detection of connected devices.	—
	Port No.	Set the port number for each connection of the Ethernet-equipped module. When "Communication Method" is set to "MODBUS/TCP", set the same value to all port numbers.	1 to 4999, 5010 to 65534 (Default: Blank) ^{*4}
Sensor/Device	MAC Address	The MAC address of the device supporting iQSS is displayed when using the automatic detection of connected devices.	—
	Host Name	Set the name for identifying the device supporting iQSS. This setting is available only for the devices supporting iQSS which were detected by automatic detection of connected devices.	63 characters maximum The following one-byte characters can be used. <ul style="list-style-type: none"> • Number (0 to 9) • Alphabetical character (a to z, A to Z) • Hyphen (-) • Period (.) • Colon (:) • Underscore (_) (Default: Blank) ^{*4}
	IP Address	Set the IP address of the external device.	0.0.0.1 to 223.255.255.254, 255.255.255.255 ^{*5} (Default: Blank) ^{*4}
	Port No.	Set the port number of the external device. Set "65535" to set all the port numbers as the target of data receive.	1 to 65534, 65535 (Default: Blank) ^{*4}
	Subnet Mask	Set the subnet mask of the device supporting iQSS. This setting is available only for the devices supporting iQSS which were detected by automatic detection of connected devices.	192.0.0.0 to 255.255.255.252 (Default: Blank) ^{*4}
	Default Gateway	Set the default gateway of the device supporting iQSS. This setting is available only for the devices supporting iQSS which were detected by automatic detection of connected devices.	0.0.0.1 to 223.255.255.254 (Default: Blank) ^{*4}

Item	Description	Setting range
Existence Confirmation	Select the method of alive check which is performed when the Ethernet-equipped module has not communicated with the external device for a certain period of time. When the module cannot communicate with the external device, the connection will be closed. ( Page 322 Existence Confirmation)	<ul style="list-style-type: none"> • KeepAlive • UDP • Do not confirm existence

*1 When "Q Compatible Ethernet" is selected in the network type, the setting range is 1 to 16.

*2 This setting is not available for the CPU module (built-in Ethernet port part).

*3 This setting is not available when the RJ71EN71 network type is set to "Q Compatible Ethernet".

*4 When the automatic detection of the connected devices is executed, the values read from the connected devices will be the default.

*5 When "Communication Method" is set to "OPS Connection", 255.255.255.255 can be set.

Point

Comment can be set on the "Properties" window displayed by right-clicking the module in "List of devices" or "Device map area" and selecting "Properties". The following can be performed depending on the selected device.

- Changing the image
- Creating association with a file or application

■ Existence Confirmation

When the Ethernet-equipped module has not communicated with the external device for a certain period of time while the connection is open, this function checks whether the external device is alive by sending an alive check message to the device and waiting for the response.

The following table lists the details on alive check.

Item	Applicable protocol	Description
KeepAlive	TCP/IP	This method is used for a connection opened using TCP/IP. The Ethernet-equipped module performs an alive check by sending an alive check ACK message to the external device with which communications have not been performed for a certain period of time and waiting to see whether the response is received. The connection will be automatically closed when the open state is not continued.*1
UDP	UDP/IP	This method is used for a connection opened using UDP/IP. The Ethernet-equipped module performs an alive check by sending the PING command (ICMP echo request/response function) to the external device with which communications have not been performed for a certain period of time and waiting to see whether the response is received.*2
Do not confirm existence	TCP/IP, UDP/IP	Alive check is not performed.

*1 The connection may be disconnected if the external device does not support the TCP KeepAlive function (response to a KeepAlive ACK message).

*2 The Ethernet-equipped module automatically sends an echo response packet when it receives a PING echo request command. (It sends a response to the received PING command even if the connection used in the data communications with the external device is closed.)

If a response message cannot be received from the external device (or if an error has been detected) using the alive check function, the following are performed.

- The corresponding connection will be forcibly closed. (The line is disconnected.) Open the connection again using a user program.
- Open completion signal is turned off, and the error code is stored in the buffer memory areas.

Transmission Port Settings

Set the Ethernet ports used for communication and functions.

Item	Description	Setting range
MELSOFT Transmission Port UDP/IP	Select whether to use transmission port 5001 or 5006 for UDP/IP connection.	<ul style="list-style-type: none">• Use• Not Use (Default: Use)
MELSOFT Transmission Port TCP/IP	Select whether to use transmission port 5007 for TCP/IP connection.	<ul style="list-style-type: none">• Use• Not Use (Default: Use)
Auto-open UDP Port	Select whether to use transmission port 5005 for auto-open UDP.	<ul style="list-style-type: none">• Use• Not Use (Default: Use)

Precautions

When all transmission port settings are set to "Not Use", communication with engineering tools by using Ethernet ports is not possible.

If communication using a port other than an Ethernet port (USB) or direct connection with MELSOFT is allowed, communicate with direct connection.

2.3 Application Settings

Set frame or communication speed of the Ethernet-equipped module.

RJ71EN71, RnENCPU (network part)

0000:RJ71EN71(E+E) Module Parameter

Setting Item List

- Basic Settings
- Application Settings
 - Frame Settings
 - Communication Speed
 - FTP Server Settings
 - MODBUS/TCP Settings
 - Simple CPU Communication Setting
 - Simple Device Communication Setting
 - Time Setting
 - Timer Settings for Data Communication
 - Security
 - Gateway Parameter Settings
 - Network/Station No. <-> IP information setting
 - Interrupt Settings
 - IP Packet Transfer Setting
 - Network Dynamic Routing
 - Module Operation Mode

Setting Item

Item	Setting
Frame Settings	
Send Frame	Ethernet (V2.0) Frame
Jumbo Frame	Invalid (MTU 1500 byte)
Communication Speed	
Communication Speed	Automatic Negotiation
FTP Server Settings	
FTP Server	Not to Use
Login Name	RJ71EN71
Advanced Settings	
Password Setting	
Current Password	
New Password	
Confirm New Password	
FTP Timer Settings	
Command Input Monitoring Timer	900
Unit	s
Response Monitoring Timer	5
Unit	s
Allow Online Change	Disable
MODBUS/TCP Settings	
To Use or Not to Use MODBUS/TCP Setting	Not to Use
CPU Response Monitoring Timer	5
Unit	s
Device Assignment	<Detailed Setting>
Simple CPU Communication Setting	
To Use or Not to Use Simple CPU Communication	Not to Use
CPU Response Monitoring Timer	5
Unit	s
Simple CPU Communication Setting	<Detailed Setting>
Simple Device Communication Setting	
To Use or Not to Use Simple Device Communication Setting	Not to Use
Resource Setting	Normal
Instruction Initial Value to Start/Stop Function	Start
CPU Response Monitoring Timer	5
Unit	s
Communication Destination Setting	<Detailed Setting>
Device List	<Confirmation>

Explanation
Set parameters for the Ethernet frame.

Check
Restore the Default Settings

Item List Find Result
Apply

Setting item	Description	Reference
Frame Settings	Set parameters for the Ethernet frame.	Page 327 Frame Settings
Communication Speed	Set the communication speed between the module and the external device.	Page 328 Communication Speed
FTP Server Settings	Set the file transfer function (FTP server).	Page 329 FTP Server Settings
MODBUS/TCP Settings ^{*1}	Set MODBUS/TCP.	Page 331 MODBUS/TCP Settings
Simple CPU Communication Setting ^{*1}	Set the simple CPU communication setting.	Page 333 Simple CPU communication setting (RJ71EN71, RnENCPU (network part))
Simple Device Communication Setting	Set the simple device communication setting.	Page 338 Simple Device Communication Setting
Time Setting ^{*1}	Set the time setting function (SNTP client).	Page 391 Time Setting
Timer Settings for Data Communication	Set the timer used for the following communications. <ul style="list-style-type: none"> • Connection with MELSOFT products and a GOT • Communications using the SLMP • Communications using the predefined protocol • Socket communications/Communications using the fixed buffer • Communication using the random access buffer • File transfer function (FTP server) • File Transfer Function (FTP Client) 	Page 392 Timer Settings for Data Communication
Security ^{*1}	Set the security measures for access to the Ethernet-equipped module.	Page 395 Security
Gateway Parameter Settings	Set to communicate with an external device on Ethernet via a router and gateway.	Page 395 Gateway Parameter Settings
Network/Station No. <-> IP information setting	Set to communicate with another network module or CPU module by network number and station number.	Page 398 Network/Station No. <-> IP information setting
Interrupt Settings	Set to start up an interrupt program.	Page 405 Interrupt Settings
IP Packet Transfer Setting ^{*1}	Set the IP packet transfer function. For details on the IP packet transfer function, refer to the following. <ul style="list-style-type: none"> 📖 MELSEC iQ-R CC-Link IE Controller Network User's Manual (Application) 📖 MELSEC iQ-R CC-Link IE Field Network User's Manual (Application) 	Page 405 IP Packet Transfer Setting
Network Dynamic Routing ^{*1}	Set the dynamic routing.	Page 406 Network Dynamic Routing
Module Operation Mode	Set the module operation mode.	Page 406 Module Operation Mode
Redundant system settings ^{*2}	Set when using an RJ71EN71 in a redundant system.	Page 407 Redundant System Settings

*1 This setting is not available when the RJ71EN71 network type is set to "Q Compatible Ethernet".

*2 This item is displayed only when the module configuration for a redundant system is used.

CPU module (built-in Ethernet port part)

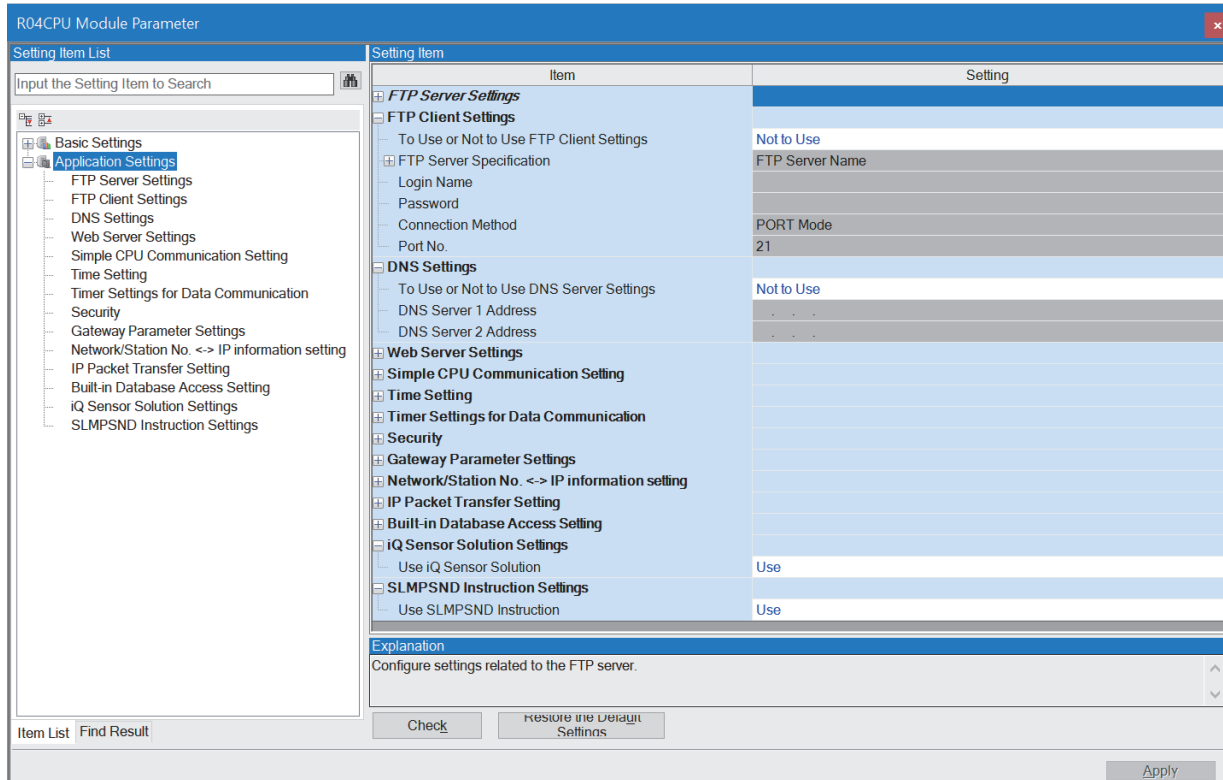

Setting item	Description	Reference
FTP Server Settings	Set the file transfer function (FTP server).	Page 329 FTP Server Settings
FTP Client Settings	Set the file transfer function (FTP client).	Page 330 FTP Client Settings
DNS Settings	Set the DNS setting.	Page 330 DNS Settings
Web Server Settings	Set the Web server function. (MELSEC iQ-R/MELSEC iQ-F Web Server Function Guide Book)	—
Simple CPU Communication Setting	Set the simple CPU communication setting.	Page 336 Simple CPU communication setting (CPU module (built-in Ethernet port part))
Time Setting	Set the time setting function (SNTP client).	Page 391 Time Setting
Timer Settings for Data Communication	Set the timer used for the following communications. <ul style="list-style-type: none"> • Connection with MELSOFT products and a GOT • Communications using the SLMP • Communications using the predefined protocol • Socket communications/Communications using the fixed buffer • Communication using the random access buffer • File transfer function (FTP server) • File Transfer Function (FTP Client) 	Page 392 Timer Settings for Data Communication
Security	Set the security measures for access to the Ethernet-equipped module.	Page 395 Security
Gateway Parameter Settings	Set to communicate with an external device on Ethernet via a router and gateway.	Page 395 Gateway Parameter Settings
Network/Station No. <-> IP information setting	Set to communicate with another network module or CPU module by network number and station number.	Page 398 Network/Station No. <-> IP information setting
IP Packet Transfer Setting	Set the IP packet transfer function. For details on the IP packet transfer function, refer to the following. <ul style="list-style-type: none"> 📖 MELSEC iQ-R CC-Link IE Controller Network User's Manual (Application) 📖 MELSEC iQ-R CC-Link IE Field Network User's Manual (Application) 	Page 405 IP Packet Transfer Setting
Redundant System Settings	Set the redundant system function. Only functions that meet usage conditions with a redundant system can be set. (Page 294 Redundant System Function)	Page 407 Redundant System Settings
Built-in database access setting	Set the function of CPU module built-in database access from an external device. (MELSEC iQ-R Programmable Controller CPU Module User's Manual)	—
iQ Sensor Solution Settings	Set the setting related to iQ Sensor Solution.	Page 410 iQ Sensor Solution Settings
SLMPSND Instruction Settings	Set the setting related to the SLMPSND instruction.	Page 410 SLMPSND Instruction Settings

Frame Settings

Set parameters for the Ethernet frame.

Item	Description	Setting range
Send Frame	Set the frame of the Ethernet header for the data link layer to be sent by the RJ71EN71 or the RnENCPU (network part) to the Ethernet (V2.0) frame.	Ethernet (V2.0) Frame (fixed)
Jumbo Frame ^{*1}	Set the frame size of the data to be sent over Ethernet. Set when the data transmission speed is 1Gbps and communication is not efficient because the frame size is too small.	<ul style="list-style-type: none">• Invalid (MTU 1500 byte)• 2KB (MTU 2034 byte)• 3KB (MTU 3058 byte)• 4KB (MTU 4082 byte)• 5KB (MTU 5106 byte)• 6KB (MTU 6130 byte)• 7KB (MTU 7154 byte)• 8KB (MTU 8178 byte)• 9KB (MTU 9004 byte) (Default: Invalid (MTU 1500 byte))

*1 This setting is not available when the RJ71EN71 network type is set to "Q Compatible Ethernet".

Jumbo Frame

The following describes the precautions for using jumbo frames.

- In TCP/IP communications, the setting is enabled when the external device supports jumbo frames. If the external device does not support jumbo frames, the Ethernet-equipped module sends data in normal frame size even though the "Jumbo Frame" is enabled.
- In TCP/IP communications, data sending from the external device may fail when "Jumbo Frame" of the Ethernet-equipped module is set to "Invalid (MTU 1500 byte)" and that of the external device is enabled. When communicating in jumbo frames, enable the jumbo frame setting for both of the Ethernet-equipped module and external device.
- In UDP/IP communications, the Ethernet-equipped module sends data in jumbo frames according to the "Jumbo Frame" even though the external device does not support jumbo frames.
- When the hub on the communication path does not support jumbo frames, the Ethernet-equipped module cannot communicate with the external device because the hub discards the packets even if the module sends data in jumbo frame.
- Data can be sent in jumbo frames only when the transmission speed is 1Gbps. When "Automatic Negotiation" in "Communication Speed" is set to "Jumbo Frame" and the Ethernet-equipped module communicates at a speed less than 1Gbps, the module sends data in the standard frame size.
- When the item other than "Automatic Negotiation" or "1Gbps/Full-Duplex" is set in "Communication Speed" of "Application Settings", "Jumbo Frame" cannot be set to other than "Invalid (MTU 1500 byte)".

Communication Speed

Select the communication speed and communication mode from the following. (Default: Automatic Negotiation)

When "Automatic Negotiation" is selected, communication speed will be automatically set to be the same as that of another device connected to the network.

- Automatic Negotiation
- 1Gbps/Full-Duplex^{*1}
- 100Mbps/Half-Duplex
- 100Mbps/Full-Duplex
- 10Mbps/Half-Duplex
- 10Mbps/Full-Duplex

*1 This setting is not available when the RJ71EN71 network type is set to "Q Compatible Ethernet".
Select "Automatic Negotiation" to use 1Gbps/full-duplex.

Point

- When the auto-negotiation function is used, there is a time lag before starting communication because it requires the time to determine the communication speed and communication mode by FLP burst.
 - It is recommended to set the auto-negotiation also in the communication destination when using the auto-negotiation function. If auto-negotiation is not set in either of the Ethernet-equipped module or partner external device, communication mode cannot be identified and it is automatically set to half-duplex mode, resulting in unstable communication.
 - Set the lower communication speed when communication fails due to noise or other causes.
-

FTP Server Settings

Set the file transfer function (FTP server).

Item	Description	Setting range	
FTP Server	Select whether to use the file transfer function (FTP server) of the Ethernet-equipped module.	<ul style="list-style-type: none"> • Not Use • Use (Default: Not Use)	
Login Name	Set the login name to be used for file transfer request (login) from the external device.	12 characters maximum (one-byte alphanumeric character) [Default] <ul style="list-style-type: none"> • RJ71EN71 and RnENCPU (network part): RJ71EN71 • CPU module (built-in Ethernet port part): RCPU 	
Advanced Settings	Password Setting	Set the password to be used for file transfer request (login) from the external device to the Ethernet-equipped module. (☞ Page 329 Password Setting)	—
	FTP Timer Settings	Set the following timers used for the file transfer function (FTP server). (☞ Page 329 FTP Timer Settings) <ul style="list-style-type: none"> • Command Input Monitoring Timer • Response Monitoring Timer 	—
	Allow Online Change	Select whether to enable data writing from the external device using the file transfer function (FTP server) while the CPU module is in RUN state.	<ul style="list-style-type: none"> • Disable • Enable (Default: Disable)

Password Setting

■Current Password

Enter the current password for login to the Ethernet-equipped module.

Default password (initial setting) is the following.

Module	Password
RJ71EN71, RnENCPU (network part)	RJ71EN71
CPU module (built-in Ethernet port part)	RCPU

Although the default password can be used, it is recommended to change it to another password to prevent unauthorized access.

■New Password, Confirm New Password

Enter the new password in "New Password" and "Confirm New Password" when changing the password.

Set a password within 0 to 32 one-byte characters. Number, alphabet, special character (?,!&%#*) can be used.

FTP Timer Settings

■Command Input Monitoring Timer

Set the monitoring time for the Ethernet-equipped module to monitor the command input time from the FTP client

It is recommended to use the default value (900s) for this timer value as much as possible.

When changing the setting value, determine the command input monitoring timer value upon consulting with the administrator of the external device or system.

Set a value within the following range.

Unit	Setting range
s	1 to 16383
ms*1	100 to 16383000

*1 Set in increments of 100ms.

The FTP connection is disconnected if there is no command input from the FTP client side within the time of the command input monitoring timer value after the FTP client login.

When restarting the file transfer, start over from the login operation again.

■Response Monitoring Timer

Set the monitoring time for a response from the CPU module after the Ethernet-equipped module receives the request data from the external device and requests the CPU module for read/write.

It is recommended to use the default value (5s) for this timer value as much as possible.

When changing the setting value, determine the response monitoring timer value upon consulting with the system administrator.

Set a value within the following range.

Unit	Setting range
s	1 to 16383
ms	100 to 16383000 (in increments of 100ms)

FTP Client Settings

Set the file transfer function (FTP client).

Item	Description	Setting range
To Use or Not to Use FTP Client Settings	Set whether to use the file transfer function (FTP client) or not.	<ul style="list-style-type: none">• Not Use• Use (Default: Not Use)
FTP Server Specification	Set the specification method of the FTP server.	<ul style="list-style-type: none">• FTP Server Name• FTP Server IP Address (Default: FTP Server Name)
FTP Server Name	Set the FTP server name (domain name) of the connection destination.	1 to 256 characters
FTP Server IP Address	Set the IP address of the FTP server of the connection destination in the decimal format.	0.0.0.1 to 223.255.255.254
Login Name	Set the login name for login to the FTP server.	1 to 32 characters
Password	Set the password for login to the FTP server.	0 to 32 characters
Connection Method	Set the connection method of the FTP server.	<ul style="list-style-type: none">• PORT Mode• PASV Mode (Default: PORT Mode)
Port No.	Set the port number for control of the FTP server.	1 to 65535 (Default: 21)

DNS Settings

Set the IP address of the DNS server.

Set the IP address in the following cases.

- When "FTP Server Specification" in "FTP Client Settings" is set to "FTP Server Name"
- When the FTP server is specified with the server name for the data logging file transfer function.



Item	Description	Setting range
To Use or Not to Use DNS Server Settings	Set whether to use the DNS server or not.	<ul style="list-style-type: none">• Not Use• Use (Default: Not Use)
DNS Server 1 Address	Set the IP address of the DNS server 1 in the decimal format.	0.0.0.1 to 223.255.255.254
DNS Server 2 Address	Set the IP address of the DNS server 2 in the decimal format.	0.0.0.1 to 223.255.255.254

Point

When "To Use or Not to Use DNS Server Settings" is set to "Use", set either one or both "DNS Server 1 Address" and "DNS Server 2 Address".

MODBUS/TCP Settings

Set MODBUS/TCP.

Item	Description	Setting range
To Use or Not to Use MODBUS/TCP Setting	"Use" is displayed when a MODBUS/TCP connection device is added in "External Device Configuration" under "Basic Settings". ("To Use or Not to Use MODBUS/TCP Setting" cannot be edited.)	<ul style="list-style-type: none"> • Not Use • Use (Default: Not Use)
CPU Response Monitoring Timer	Set the time for monitoring the response from the CPU module. ( Page 331 CPU Response Monitoring Timer)	—
Device Assignment	Set the parameters to associate the MODBUS devices with the device memory areas of the CPU module. ( Page 332 Device Assignment)	—

CPU Response Monitoring Timer

Set the time for monitoring the response from the CPU module.

When the CPU module does not send a response within the set time after the reception of a request message from the MODBUS/TCP master device, the state of waiting for the response from the Ethernet-equipped module is canceled.

Set the CPU Response Monitoring Timer within the following range.

Unit	Setting range
s	1 to 16383
ms	100 to 16383000 (in increments of 100ms)

Device Assignment

Set the MODBUS device assignment parameters to use the MODBUS device assignment function.

Create the association between the following MODBUS devices and the device memory areas of the CPU module.

- Coil
- Input
- Input register
- Holding register

Item	Coil	Input	Input Registers	Holding Registers
MODBUS Device Allocation Parameter Set the parameter so that the MODBUS device can be related to the device memory of PLC CPU as a slave.				
Allocation 1				
Device	Y0	X0		D0
Start MODBUS Device No.	0	0	0	0
Allocation Points	8192	8192	0	12288
Allocation 2				
Device	M0			SD0
Start MODBUS Device No.	8192	0	0	20480
Allocation Points	8192	0	0	2048
Allocation 3				
Device	S0			H1D5000
Start MODBUS Device No.	20480	0	0	22528
Allocation Points	2048	0	0	4096
Allocation 4				
Device	L0			W0
Start MODBUS Device No.	22528	0	0	30720
Allocation Points	8192	0	0	8192
Allocation 5				
Device	B0			SW0
Start MODBUS Device No.	30720	0	0	40960
Allocation Points	8192	0	0	2048
Allocation 6				
Device	F0			TN0
Start MODBUS Device No.	38912	0	0	53248
Allocation Points	2048	0	0	1024

Set the parameter so that the MODBUS device can be related to the device memory of PLC CPU as a slave.

Buttons: Check, Restore the Default Settings, Clear, OK, Cancel

Item	Description
Device	Set the devices of the CPU module to be assigned to the MODBUS devices. Use H to specify a buffer memory area. (Example: H1D5000)
Start MODBUS Device No.	Set the start number of the devices of the CPU module to be assigned to the MODBUS devices. The setting value for the start MODBUS device number can be obtained with the following formula. • Start MODBUS device number = Last five digits of the target MODBUS device number - 1
Allocation Points	Set the number of device points of the CPU module to be assigned to the MODBUS devices.

Point

When "Device" is blank, values set in "Start MODBUS Device No." and "Allocation Points" are ignored. In this case, data written into the programmable controller will not be assigned to the MODBUS devices. (When the written data are read from the programmable controller, "Start MODBUS Device No." and "Allocation Points" are set to 0.)

Simple CPU communication setting (RJ71EN71, RnENCPU (network part))

This setting is used for using the simple CPU communication function with the RJ71EN71 or RnENCPU (network part). Set "Use" to "To Use or Not to Use Simple CPU Communication" before setting other items.

Item	Description	Setting range
To Use or Not to Use Simple CPU Communication	Select whether to use the simple CPU communication or not.	<ul style="list-style-type: none"> • Not Use • Use (Default: Not Use)
CPU Response Monitoring Timer	Set the time for monitoring the response from the CPU module. When the CPU module does not send a response within the set time, the state of waiting for the response from the Ethernet-equipped module is canceled.	<ul style="list-style-type: none"> • s: 1 to 16383 • ms: 100 to 16383000 (in increments of 100ms) (Default: 5s)
Simple CPU Communication Setting	Set the items to use the simple CPU communication. (☞ Page 333 Simple CPU communication setting)	
"Communication Destination Setting" window	Click "Detailed Setting" to display the window. (☞ Page 335 "Communication Destination Setting" window)	

Details of items

■ Simple CPU communication setting

Set the items to use the simple CPU communication.

Item	Description	Setting range
Latency Time	Set the time required to start communications after completion of the CPU module startup. This setting is common to all the setting numbers and cannot be changed for each setting number. After system switching in a redundant system, communications are restarted regardless of the latency time.	0 to 255s (in increments of 1s) (Default: 0s)
Setting No.	Setting numbers 1 to 512 are available. Any numbers can be used. (Numbers to use do not have to be sequential.)	—
Communication Pattern	Set whether to read or write data.	<ul style="list-style-type: none"> • Read • Write (Default: Blank)
Communication Setting: Execution Interval (ms)	Communication setting	<ul style="list-style-type: none"> • Fixed Interval • On Request (Default: Fixed Interval)
	Execution interval	Set the execution interval of communications when "Fixed Interval" is set for the communication setting. 1 to 65535ms (in increments of 1ms) (Default: 100ms)
Communication Destination (IP Address)	Source	Set the transmission source. When "Write" is set to "Communication Pattern", the own station (IP address of the own station) is displayed.
	Destination	Set the transmission destination. When "Read" is set to "Communication Pattern", the own station (IP address of the own station) is displayed.
Target PLC No. ^{*1}	Specify the CPU number of the communication destination. It will be the connected station when "Not Specified" is selected.	<ul style="list-style-type: none"> • Not Specified • PLC No.1 • PLC No.2 • PLC No.3 • PLC No.4 • PLC No.5 • PLC No.6 • PLC No.7 • PLC No.8 (Default: Not Specified)

Item		Description	Setting range
Bit Device	Points	Set the type, start number, and end number of the "Source" bit device and the type and start number of the "Destination" bit device. When these values are input, the number of points will be displayed automatically.	The setting range differs depending on the communication destination. (☞ Page 196 Devices that can be specified)
	Type		
	Start		
	End		
Word Device	Points	Set the type, start number, and end number of the "Source" word device and the type and start number of the "Destination" word device. When these values are input, the number of points will be displayed automatically.	
	Type		
	Start		
	End		
Communication Time-out Period (ms)		Set the time period until retries are performed after an error response from the communication destination, the time period until the abnormal state is detected, and the time period to wait for a response from the communication destination. Configure the setting so that (communication time-out period) ≥ (execution interval). For details on the communication time-out period, refer to the following. ☞ Page 213 Communication Time-out Period/Communication Retry Count/Monitoring Time At Error	10 to 65535ms (in increments of 1ms) (Default: 1000ms) When the device type of the communication destination set to "SLMP Corresponding Device (QnA Compatible 3E Frame)", the value is fixed to 65535ms.
Communication Retry Count		Set the number of communication retry to be performed within the communication time-out period when the communication destination returns an error response or does not respond. For details on the communication retry count, refer to the following. ☞ Page 213 Communication Time-out Period/Communication Retry Count/Monitoring Time At Error	0 to 255 times (Default: 3) When the device type of the communication destination set to "SLMP Corresponding Device (QnA Compatible 3E Frame)", the value is fixed to 0.
Monitoring Time At Error (s)		Set the communication time after a communication error has occurred. For details on the monitoring time at error, refer to the following. ☞ Page 213 Communication Time-out Period/Communication Retry Count/Monitoring Time At Error	1 to 300s (Default: 30s)
Comment		Sets a comment for the setting number, if required.	32 characters maximum (Default: Blank)

*1 The target PLC number differs depending on the communication destination. For details, refer to the following.

☞ Page 195 Target PLC No.





■ "Communication Destination Setting" window

The communication destination of the simple CPU communication is specified on the window.

Item	Description	Setting range
Device Type	Specify the device type of the communication destination.	<ul style="list-style-type: none"> • MELSEC iQ-R (Built-in Ethernet) • MELSEC-Q (Built-in Ethernet) • MELSEC-L (Built-in Ethernet) • MELSEC iQ-F (Built-in Ethernet) • MELSEC iQ-L (Built-in Ethernet) • MELSEC iQ-R (Ethernet Module) • MELSEC-Q (Ethernet Module) • MELSEC-L (Ethernet Module) • MELSEC-A/AnS (Ethernet Module) • MELSEC-FX3 (Ethernet Block/Adapter) • SLMP Corresponding Device (QnA Compatible 3E Frame) • OMRON (CS/CJ series) • KEYENCE (KV series) • Panasonic (FP2SH series) • Panasonic (FP7 series) • YASKAWA MP3000 series • YASKAWA MP2000 series • Yokogawa FA-M3 series • MODBUS/TCP Corresponding Device • SIEMENS S7 series • SIEMENS S7 series (extension) • Fuji Electric MICREX-SX series • JTEKT TOYOPUC series (Default: Blank)
UDP/TCP	Set the protocol used for the communication.	<ul style="list-style-type: none"> • UDP • TCP (Default: Blank)
IP Address	Enter the IP address of the communication destination.	0.0.0.1 to 223.255.255.254 (Default: Blank)
Port No.	Set the port number of the communication destination.	1 to 65534 (Default: Blank)
Host Station Port No.	Set the port number of the own station.	1 to 65534 (Default: Blank)
Option (hexadecimal)	Set the option setting value.	The value differs depending on the external devices. ( Page 193 Option (hexadecimal))

Simple CPU communication setting (CPU module (built-in Ethernet port part))

Set the following items when using the simple CPU communication function with the CPU module (built-in Ethernet port part).

Item		Description	Setting range
Latency Time		Set the time required to start communications after completion of the CPU module startup. This setting is common to all the setting numbers and cannot be changed for each setting number.	0 to 255s (in increments of 1s) (Default: 0s)
Initial Communication Setting		Set the operation when the communication destination does not respond at the initial communication. This setting is enabled when the communication setting is set to "Fixed Interval". In addition, this setting is common to all the setting numbers and cannot be changed for each setting number.  Page 237 Initial Communication Setting	Communicate until the communication destination responds. (Default: Without check for the Rn(EN)CPU, with check for the RnPCPU (fixed))
Setting No.		Displays setting No.1 to 64. An arbitrary setting number can be set. (Numbers to use do not have to be sequential.)	—
Communication Pattern		Set whether to read or write data.	<ul style="list-style-type: none"> • Read • Write (Default: Blank)
Communication Setting: Execution Interval (ms)	Communication setting	Sets this item to communicate data periodically.	<ul style="list-style-type: none"> • Fixed Interval • On Request*2 (Default: Fixed Interval)
	Execution interval	Set the execution interval of communications when "Fixed Interval" is set for the communication setting.	10 to 65535ms (in increments of 1ms) (Default: 100ms)
Communication Destination (IP Address)	Source	Set the transmission source. When "Write" is set to "Communication Pattern", the own station (IP address of the own station) is displayed.	 Page 337 Communication destination setting
	Destination	Set the transmission destination. When "Read" is set to "Communication Pattern", the own station (IP address of the own station) is displayed.	
Target PLC No.*1		Specify the CPU number of the communication destination. It will be the connected station when "Not Specified" is selected.	<ul style="list-style-type: none"> • Not Specified • PLC No.1 • PLC No.2 • PLC No.3 • PLC No.4 (Default: Not Specified)
Bit Device	Points	Set the type, start number, and end number of the "Source" bit device and the type and start number of the "Destination" bit device. When these values are input, the number of points will be displayed automatically.	The setting range differs depending on the communication destination. ( Page 231 Devices that can be specified)
	Type		
	Start		
	End		
Word Device	Points	Set the type, start number, and end number of the "Source" word device and the type and start number of the "Destination" word device. When these values are input, the number of points will be displayed automatically.	
	Type		
	Start		
	End		
Communication Time-out Period (ms)		Set the time period until the retry is performed, the time period until a communication error occurs, and the time period to wait a response from the communication destination after an error response from the communication destination. Configure the setting so that (communication time-out period) ≥ (execution interval). For details on the communication time-out period, refer to the following.  Page 237 Communication Time-out Period/Communication Retry Count/Monitoring Time At Error	10 to 65535ms (in increments of 1ms) (Default: 1000ms) When the communication destination set to "SLMP Corresponding Device (QnA Compatible 3E Frame)", the value is fixed at 65535ms.
Communication Retry Count		Set the number of communication retry to be performed within the communication time-out period when the communication destination returns an error response or does not respond. For details on the communication retry count, refer to the following.  Page 237 Communication Time-out Period/Communication Retry Count/Monitoring Time At Error	0 to 255 times (Default: 3) When the communication destination set to "SLMP Corresponding Device (QnA Compatible 3E Frame)", the value is fixed at 0.

Item	Description	Setting range
Monitoring Time At Error (s)	Set the communication time after a communication error has occurred. This setting is enabled when the communication setting is set to "Fixed Interval". For details on the monitoring time at error, refer to the following.  Page 237 Communication Time-out Period/Communication Retry Count/ Monitoring Time At Error	1 to 300s (Default: 30s)
Comment	Sets a comment for the setting number, if required.	32 characters maximum (Default: Blank)

*1 Although the target PLC No.5 to 8 can be selected for the communication destination in the engineering tool, they cannot be used for the CPU module (built-in Ethernet port part).

*2 To set this value, check the versions of the CPU module and engineering tool.

Communication destination setting

The following table lists the communication destination setting specified for the simple CPU communication.

Item	Description	Setting range
Device Type	Specify the device type of the communication destination.	<ul style="list-style-type: none"> • MELSEC iQ-R (Built-in Ethernet) • MELSEC iQ-L (Built-in Ethernet) • MELSEC iQ-F (Built-in Ethernet) • MELSEC-Q (Built-in Ethernet) • MELSEC-L (Built-in Ethernet) • MELSEC-Q (Ethernet Module)^{*1} • MELSEC-L (Ethernet Module)^{*1} • MELSEC-A/AnS (Ethernet Module) • MELSEC-FX3 (Ethernet Block/Adapter) • SLMP Corresponding Device (QnA Compatible 3E Frame) (Default: Blank)
IP Address	Enter the IP address of the communication destination.	0.0.0.1 to 223.255.255.254 (Default: Blank)
Port No.	Set the port number of the communication destination.	<ul style="list-style-type: none"> • MELSEC-A/AnS (Ethernet Module): 256 to 65534 • MELSEC-FX3 (Ethernet Block/Adapter): 1025 to 5548, 5552 to 65534 • SLMP Corresponding Device (QnA Compatible 3E Frame): 1 to 4999, 5010 to 65534 • Other than the above: Setting not required (Default: Blank)
Host Station Port No.	Set the port number of the own station.	<ul style="list-style-type: none"> • MELSEC-A/AnS (Ethernet Module): 1 to 4999, 5010 to 65534 • MELSEC-FX3 (Ethernet Block/Adapter): 1 to 4999, 5010 to 65534 • SLMP Corresponding Device (QnA Compatible 3E Frame): 1 to 4999, 5010 to 65534 • Other than the above: Setting not required (Default: Blank)

*1 This cannot be selected for the RnPCPU.

Simple Device Communication Setting

This setting is used for using the simple device communication function with the RJ71EN71 or RnENCPU (network part). Set "To Use or Not to Use Simple Device Communication" to "Use" before setting other items.

Item	Description	Setting range
To Use or Not to Use Simple Device Communication	Select whether to use the simple device communication or not.	<ul style="list-style-type: none"> • Not Use • Use (Default: Not Use)
Resource Setting	Set the maximum numbers of the communication destinations, protocols, and packets that can be set. (☞ Page 339 Resource Setting)	<ul style="list-style-type: none"> • Normal • Extension 1^{*2} • Extension 2 (Default: Normal)
Instruction Initial Value to Start/Stop Function	Select whether to start the simple device communication with the function enabled or stopped.	<ul style="list-style-type: none"> • Start • Stop (Default: Start)
CPU Response Monitoring Timer	Set the time for monitoring the response from the CPU module. When the CPU module does not send a response within the set time, the state of waiting for the response from the Ethernet-equipped module is canceled.	<ul style="list-style-type: none"> • s: 1 to 16383 • ms: 100 to 16383000 (in increments of 100ms)^{*1} (Default: 5)
Unit	Select the unit of the CPU response monitoring timer. When "ms" is selected, set the value in increments of 100ms.	<ul style="list-style-type: none"> • s • ms (Default: s)
"Communication Destination Setting" window	Click "Detailed Setting" to display the window. (☞ Page 340 "Communication Destination Setting" window)	
"Device List" window	Click "Confirmation" to display the window. (☞ Page 390 "Device List" window)	

*1 The setting range differs for each timer setting unit. In addition, the error of the timer is ± 10 ms.

*2 When RJ71EN71(E+E) is used for the module and does not support "Extension 2", set "To Use or Not to Use Simple Device Communication" of the other ports to "Not to Use". (☞ Page 285 Restrictions applicable depending on versions)

Resource Setting

The module name (network type) determines the availability of the options.

When the value of "Resource Setting" is changed from "Extension 1" to "Normal", any communication destination information that falls outside the range for "Normal" will be deleted.

When the value of "Resource Setting" is changed from "Extension 2" to either "Extension 1" or "Normal", all communication destination information will be deleted.

Resource Setting	Availability/Maximum number of settings	Model name (network type)		
		RJ71EN71(E+E)	RJ71EN71(E+CCIEC) _RJ71EN71(E+IEC)	RJ71EN71(E+CCIEF) _RJ71EN71(E+IEF)
Normal	Availability	Available	Available	Available
	No. of communication destinations	16 destinations/port		
	No. of protocols	256/port		
	No. of packets	768/port		
	Packet data area	61440 bytes/port		
	No. of elements	1 to 32/packet		
	Packet length (except for the header)	4096 bytes/packet		
Extension 1	Availability	Available ^{*1}	Available	Available
	No. of communication destinations	32 destinations/port		
	No. of protocols	512/port		
	No. of packets	1536/port		
	Packet data area	122880 bytes/port		
	No. of elements	1 to 32/packet		
	Packet length (except for the header)	4096 bytes/packet		
Extension 2	Availability	Available	Available	Available
	No. of communication destinations	64 destinations/port		
	No. of protocols	2048/port		
	No. of packets	6144/port		
	Packet data area	491520 bytes/port		
	No. of elements	1 to 128/packet		
	Packet length (except for the header)	10238 bytes/packet		

*1 Without "Extension 2" supported, this option cannot be set if "To Use or Not to Use Simple Device Communication" of other ports is set to "Use". (☞ Page 285 Restrictions applicable depending on versions)

*2 Up to 512 protocols can be set for each "Communication Destination Setting".

Instruction Initial Value to Start/Stop Function

Set the initial value to be stored in 'Function start/stop instruction' (Un\G1249300.0) when the initialization of the simple device communication is completed.

- Start: On (1)
- Stop: Off (0)

Point

To start up with an instruction from the communication destination, set to "Stop". To perform rudderless communications, set to "Start".

For details on the operations, refer to the following pages.

☞ Page 261 Normal operation (when "Instruction Initial Value to Start/Stop Function" is set to "Start")

☞ Page 262 Normal operation (when "Instruction Initial Value to Start/Stop Function" is set to "Stop")

"Communication Destination Setting" window

The communication destination of the simple device communication is set on the window.

Select the checkbox (enable the communication destination setting) before setting other items.

Item	Description	Setting range
Checkbox (Enable the communication destination setting)	Set "Enable" or "Disable" for the communication destination.	<ul style="list-style-type: none"> • Disable (Not select) • Enable (Select) (Default: Disable (Not select))
Setting No. ^{*1}	Displays the number of communication destinations that can be set. The communication destination can be set to a desired setting number.	<ul style="list-style-type: none"> • 1 to 16 • 1 to 32 • 1 to 64 (Default: 1 to 16, 1 to 32, or 1 to 64)
Setting Method	Select the setting method for the communication destination.	<ul style="list-style-type: none"> • Select from library • User Selection (Default: Blank)
Manufacturer ^{*2}	Set the manufacturer name of the communication destination.	<ul style="list-style-type: none"> • When selected from library: Simple device communication library file • When set by user: 0 to 32 characters (Default: Blank)
Device Type ^{*2}	Set the device type of the communication destination.	<ul style="list-style-type: none"> • When selected from library: Simple device communication library file • When set by user: 0 to 32 characters (Default: Blank)
Model ^{*2}	Set the model of the communication destination.	<ul style="list-style-type: none"> • When selected from library: Simple device communication library file • When set by user: 0 to 32 characters (Default: Blank)
IP Address	Enter the IP address of the communication destination.	0.0.0.1 to 223.255.255.254 (Default: Blank)
Port No.	Host Station ^{*3}	Set the port number of the own station. 1 to 4999, 5010 to 65534 (Default: Blank)
	Communication Destination	Set the port number of the communication destination. 1 to 65534 (Default: Blank)
TCP/UDP	Select the protocol used for the communication.	<ul style="list-style-type: none"> • TCP Active • UDP (Default: Blank)
"Protocol Setting" window	Set the protocol(s) to be used for the communication. (☞ Page 342 "Protocol Setting" window)	
Comment ^{*2}	Set (and displays) any comment, if required.	Up to 64 characters (Default: Blank)

Item	Description	Setting range
Latency Time ^{*4}	Set the time required to start communications after completion of the CPU module startup. This setting is common to "Setting No." and cannot be changed for each "Setting No."	0 to 255 (in increments of 1s) (Default: 0)
Import/Export of Settings	[Import] button	—
	[Export] button	—

*1 The default is 1 to 16 when "Resource Setting" is set for "Normal", 1 to 32 for "Extension 1", and 1 to 64 for "Extension 2".

*2 Because this item is saved as character string, the display language change of the engineering tool is not applicable. The content is always displayed in the language of the parameter settings.

*3 Use 1024 to 4999 or 5010 to 61439 for the port number of the own station. 1 to 1023 are typically reserved port numbers (WELL KNOWN PORT NUMBERS) and 61440 to 65534 are used by other communication functions.

*4 When the latency time is set, the system delays the communication start timing for the specified time before performing the simple device communication. To start communications after the communication destination is ready for the communications, intentionally change the start time to avoid errors in the simple device communications.

■ Import/export of simple device communication setting file

This function saves the protocol information, including the set communication destination information and device assignment information, to a file and restores the parameters from that file. Saving is performed for each communication destination, and one file can contain multiple instances of communication destination information.



By using import/export, the communication destination settings, including the protocol settings, can be easily duplicated and reused for other systems and devices.

• Import procedure

1. Click the [Import] button.
2. Select the simple device communication setting file (*.gx3sc) to import, and click the [Open] button.
3. Set the first setting number of the setting reflection destination, and then click the [OK] button.

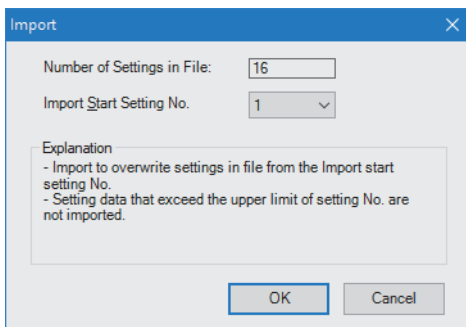

Settings that exceed the upper limit of the setting number are not imported.

• Export procedure

1. Click the [Export] button.
2. Set the range of setting numbers to be saved, and then click the [OK] button.

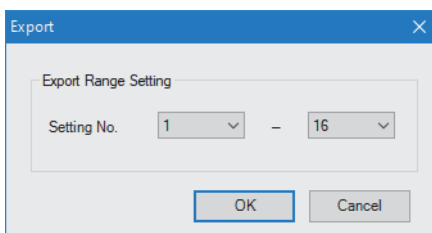

3. Select the save destination, and click the [Save] button.

"Protocol Setting" window

Set the protocol for communicating with the communication destination.

Click the [Add Protocol] button before setting other items.

Item	Description	Setting range
[Tree Display] button (protocol list display switching)	Shows/hides the protocol list.	—
Protocol list	Displays the registered protocols in tree format.	—
[Add Protocol] button	Adds a new protocol. Defaults are entered in "Protocol Name" and "Packet Name". When "Setting Method" on the "Communication Destination Setting" window is set to "Select from library", the protocol to be set (the protocol registered in the simple device communication library file) can be selected from the "Protocol Name" drop-down menu.	—
Total Number of Registered Protocols ^{*1}	Displays the total number of protocols registered for all the communication destinations including the destinations for which the checkbox (enable the communication destination setting) is not selected on the "Communication Destination Setting" window.	<ul style="list-style-type: none"> • 0/256 to 256/256 • 0/512 to 512/512 • 0/2048 to 2048/2048
Total Number of Registered Packets ^{*2}	Displays the total number of packets registered for all the communication destinations including the destinations for the checkbox (enable the communication destination setting) is not selected on the "Communication Destination Setting" window.	<ul style="list-style-type: none"> • 0/768 to 768/768 • 0/1536 to 1536/1536 • 0/6144 to 6144/6144
Total Usage of Packet Data Area	Displays the ratio of the currently registered packet data size to the maximum size that can be registered in the packet data area (flash ROM area in the module that stores packet data for communications with the communication destination). The currently registered packet data size includes the communication destinations for which the checkbox (enable the communication destination setting) is not selected on the "Communication Destination Setting" window.	0% to 100.0%
Protocol No. ^{*3}	Set (and displays) the protocol number.	<ul style="list-style-type: none"> • 1 to 256 • 1 to 512 (Default: Blank)
Protocol Name ^{*5*6}	From the simple device communication library, select the protocol to be used. The name of the selected protocol can also be edited.	<ul style="list-style-type: none"> • Select from the simple device communication library file. • 1 to 48 characters (Default: Blank)

Item	Description	Setting range
Comm Set	Select the communication method for the protocol. Request: Data are communicated upon request only. Fixed Intrvl: Data are communicated at a specified execution interval.	<ul style="list-style-type: none"> Request Fixed Intrvl (Default: Blank)
Execution Interval (ms)	Set the cycle (interval) for sending data to the communication destination. This item cannot be set for protocols whose "Comm Set" is "Request". This item cannot be set for protocols whose "Communication Type" is "Receive Only".	1 to 65535ms (to be specified in increments of 1ms) (Default: Blank)
Communication Type	Displays the protocol communication type. <ul style="list-style-type: none"> Send Only: The send packet is sent once. Receive Only: If there is a matching packet up to 16 registered and received packets, it is received. Send & Receive: After the send packet is sent, a packet is received if the packet matches any of receive packets registered up to 16. 	<ul style="list-style-type: none"> Send Only Receive Only Send & Receive (Default: Blank)
Received Data Verification Result	Set (and displays) the device that stores the received packet number. This item cannot be set if "Communication Type" is "Send".	Refer to devices that can be specified on the following page. ☞ Page 255 Devices that can be specified (Default: Blank)
Send/Receive Parameter Setting	Configure the settings for communications with the protocol. (☞ Page 388 "Send/Receive Parameter Setting" window)	
→ Send ← Receive	Displays the packet send direction. For receive packets, this item also displays the packet number. →: Indicates send cases. ←(n): Indicates receive cases. (n: Receive packet number (1 to 16))	For send cases: → For receive cases: ←(n) (Default: Blank)
Packet Name ^{*5}	Displays the packet name. The name of the selected packet can also be edited.	1 to 48 characters (Default: Blank)
Element No.	Displays the packet element number.	<ul style="list-style-type: none"> 1 to 32 1 to 128 (Default: Blank)
Element Type	Displays the packet element type.	<ul style="list-style-type: none"> Static Data ☞ Page 351 Element type (Static data) Length ☞ Page 352 Element type (Length) Non-conversion Variable (Fixed-Length) ☞ Page 354 Element type (Non-conversion variable) Non-conversion Variable (Variable Length) ☞ Page 354 Element type (Non-conversion variable) Conversion Variable (Fixed-Length) ☞ Page 361 Element type (Conversion variable) Conversion Variable (Variable-Length) ☞ Page 361 Element type (Conversion variable) Non-verified Reception (Fixed-Length) ☞ Page 378 Element type (Non-verified reception) Non-verified Reception (Variable-Length) ☞ Page 378 Element type (Non-verified reception) Error check code ☞ Page 379 Element type (Error check code) (Default: Blank)
Element Name ^{*5}	Displays the packet element name.	1 to 48 characters (Default: Blank)
Element Setting	Set the packet elements.	Refer to the element types below. ☞ Page 345 Element setting (Default: Blank)
[Device Batch Setting] button	Set devices used in the protocol by batch. (☞ Page 389 "Device Batch Setting" window)	
[Check] button	Checks the setting details of the protocol setting.	
Protocol No.	Displays the number of the protocol where an error occurred.	<ul style="list-style-type: none"> 1 to 512 —: Protocol-independent error
Packet No.	Displays the packet where an error occurred. (n: Receive packet number (1 to 16))	<ul style="list-style-type: none"> → ←(n) —: Packet-independent error
Element No.	Displays the number of the element where an error occurred.	<ul style="list-style-type: none"> 1 to 32 —: Element-independent error
Error Details	Displays the error details.	Character string of the error details

- *1 The number will be 0/256 to 256/256 when "Resource Setting" is set for "Normal", 0/512 to 512/512 for "Extension 1", and 0/2048 to 2048/2048 for "Extension 2".
- *2 The number will be 0/768 to 768/768 when "Resource Setting" is set for "Normal", 0/1536 to 1536/1536 for "Extension 1", and 0/6144 to 6144/6144 for "Extension 2".
- *3 The number will be 1 to 256 when "Resource Setting" is set for "Normal", and 1 to 512 for either "Extension 1" or "Extension 2".
- *4 The number will be 1 to 32 when "Resource Setting" is set for either "Normal" or "Extension 1", and 1 to 128 for "Extension 2".
- *5 Because this item is saved as character string, the display language change of the engineering tool is not applicable. The content is always displayed in the language of the parameter settings.
- *6 If the protocol name entered by text input matches a protocol name obtained from the simple device communication library, the behavior is the same as when the protocol name is selected from the drop-down menu.

Point

- To delete a protocol, select any item from "Protocol No." to "Send/Receive Parameter Setting", and press the  key.
- To delete multiple protocols, right-click anywhere, select "Delete Multiple Protocols", set the "Protocol No." range to be deleted, and then click the [OK] button. Click the [Yes] button on the confirmation window to delete the specified protocols. (The protocols that are not deleted move forward.)
- If the "Protocol Setting" window is opened with no protocol set, a specific protocol is automatically added. For details, refer to the list of applicable protocols on the following page.

 MELSEC iQ-R Simple Device Communication Library Reference Manual

■ Protocol editing

Protocol editing is done with the right-click menu.

Item	Description	Remarks
Add Protocol	Same as the [Add Protocol] button	—
Open Send/Receive Parameter Setting	Same as "Send/Receive Parameter Setting"	—
Add Receive Packet	Adds a receive packet to the end of the protocol on which the cursor is positioned.	Receive packets can be interchanged from the drop-down menu of the "→ Send ← Receive" column.
Add Element	Adds an element to the end of the packet on which the cursor is positioned.	After an element is added, the element can be interchanged by editing the number in the "Element No." column.
Delete	Deletes the protocol/packet/element on the cursor line.	Send packets cannot be deleted.
Copy	Copies the protocol/packet/element on the cursor line.	—
Paste Overwrite	Pastes the copied protocol/packet/element over the protocol/packet/element at the cursor position.	—
Paste New	Pastes the copied protocol/packet/element as a new protocol/packet/element.	—
Delete Multiple Protocols	Opens the "Delete Multiple Protocols" window.	—
Device Batch Setting	Same as the [Device Batch Setting] button	—

Element setting

The packet is created with a combination of packet elements.

The number of elements that can be set in one packet and the maximum data length per packet are as follows:

- "Resource Setting" set to either "Normal" or "Extension 1": Up to 32 elements can be set in one packet; The maximum data length per packet is 4096 bytes.
- "Resource Setting" set to "Extension 2": Up to 128 elements can be set in one packet; The maximum data length per packet is 10238 bytes.

The data length of one packet is calculated by adding up the data length of each element set in the packet. The following table shows the setting items used to calculate the data length of each element.

Element type	Setting item used to calculate data length
Static Data	Byte size of data set in "Setting Value"
Length	"Data Length"
Non-conversion Variable	"Data Length/Maximum Data Length"
Conversion Variable	"Number of Data/Maximum Number of Data", "Digit", "Signed/Unsigned", "Number of Decimals", "Delimiter"  Page 345 How to calculate the data length of a conversion variable
Non-verified Reception	"Data Length"*1
Error check code	"Data Length"*2

*1 If the value is 0 (variable number of characters), it is treated as data length 0.

*2 If the processing method is 16-bit CRC (MODBUS specification), it is treated as data length 2.

Point

If the software version of the engineering tool is 1.075D or earlier, the only element type for which settings can be made is static data.

How to calculate the data length of a conversion variable

Number of Data/Maximum Number of Data	Delimiter	Calculation method
1	—	Data length of a conversion variable = (data length per data piece × "Number of Data/Maximum Number of Data")
2 or more	No Delimiter	
	Other than "No Delimiter"	Data length of a conversion variable = (data length per data piece × "Number of Data/Maximum Number of Data") - 1

The data length per data piece is calculated with the following formula: "Digit"*1 + "Signed/Unsigned"*2 + "Number of Decimals"*3 + "Delimiter"*4

*1 The calculation value varies depending on the following conditions.

Digit	Conversion	Conversion data type	Calculation value
Variable Number of Digits	<ul style="list-style-type: none"> • HEX→ASCII Hexadecimal • ASCII Hexadecimal→HEX 	Word	4
		Double Word	8
	<ul style="list-style-type: none"> • HEX→ASCII Decimal • ASCII Decimal→HEX 	Word	5
		Double Word	10
		FLOAT [Single Precision]	7
		FLOAT [Double Precision]	15
Other than "Variable Number of Digits"	—	—	1 to 16

*2 "Unsigned": 0, Other than "Unsigned": 1

*3 "No Decimal Point": 0, Other than "No Decimal Point": 1

*4 "No Delimiter": 0, Other than "No Delimiter": 1

Ex.

When the following settings are configured: "Conversion": "HEX→ASCII Decimal" or "ASCII Decimal→HEX", "Conversion Data Type": "Word", "Number of Data/Maximum Number of Data": 256, "Digit": 5, "Signed/Unsigned": Other than "Unsigned", "Number of Decimals": "Variable Point", "Delimiter": "Comma"

Data length of the conversion variable = ((5 + 1 + 1 + 1) × 256) - 1 = 2047 bytes

Ex.

When the following settings are configured: "Conversion": "HEX→ASCII Decimal" or "ASCII Decimal→HEX", "Conversion Data Type": "FLOAT [Double Precision]", "Number of Data/Maximum Number of Data": 227, "Digit": "Variable Number of Digits", "Signed/Unsigned": Other than "Unsigned", "Number of Decimals": "Variable Point", "Delimiter": "Comma"
Data length of the conversion variable = $((15 + 1 + 1 + 1) \times 227) - 1 = 4085$ bytes

■Display format of each element type

Element type	Setting item	Display format	Display example
Static Data	<ul style="list-style-type: none"> Code Type Setting Value 	(Size) "Setting Value" (When "Code Type" is "ASCII String")	(4B)"1234"
		(Size) Setting Value (When "Code Type" is "HEX")	(2B)1234
Length	<ul style="list-style-type: none"> Code Type Data Length Data Flow Data Unit Calculation Range 	(Calculation Range/Code Type/Data Flow/Data Length/Data Unit)	(7-12/HEX/Forward/2B/×1)
Non-conversion Variable (Fixed-Length)	<ul style="list-style-type: none"> Data Length/Maximum Data Length Unit of Stored Data Byte Swap Send/Receive Data Storage Area 	[Data storage area](Data Length/Unit of Stored Data/ Byte Swap)	[W0-W9](20B/Lower Byte + Upper Byte/No Swap)
Non-conversion Variable (Variable-Length)	<ul style="list-style-type: none"> Data Length/Maximum Data Length Unit of Stored Data Byte Swap Send/Receive Data Length Storage Area 	[Data length storage area](Data storage area)(Data Length/Unit of Stored Data/ Byte Swap)	[W0][W1-W0A](20B/Lower Byte + Upper Byte/No Swap)
Conversion Variable (Fixed-Length)	<ul style="list-style-type: none"> Conversion Fixed Number of Data/Variable Number of Data Number of Data/Maximum Number of Data Conversion Data Type Digit Blank-padded Character Signed/Unsigned Number of Decimals Delimiter Send/Receive Data Storage Area 	[Data storage area] (Conversion/Number of Data/ Conversion Data Type/Digit/Blank-padded Character/Singed/Unsigned/Number of Decimals/Delimiter)	[W0-W1] (→ 10/2/W/Digit (1)/ Padding (0)/Unsigned/Decimal Point (none)/Delimiter (none))
Conversion Variable (Variable-Length)	<ul style="list-style-type: none"> ■When "Fixed Number of Data/ Variable Number of Data" is "Fixed Number of Data" Conversion Fixed Number of Data/Variable Number of Data Number of Data/Maximum Number of Data Conversion Data Type Digit Blank-padded Character Signed/Unsigned Number of Decimals Delimiter Send/Receive Data Storage Area ■When "Fixed Number of Data/ Variable Number of Data" is "Variable Number of Data" Conversion Fixed Number of Data/Variable Number of Data Number of Data/Maximum Number of Data Conversion Data Type Digit Blank-padded Character Signed/Unsigned Number of Decimals Delimiter Send/Receive Data Count Storage Area 	<ul style="list-style-type: none"> ■When "Fixed Number of Data/Variable Number of Data" is "Fixed Number of Data" [Data storage area] (Conversion/Number of Data/ Conversion Data Type/Digit/Blank-padded Character/Singed/Unsigned/Number of Decimals/Delimiter) ■When "Fixed Number of Data/Variable Number of Data" is "Variable Number of Data" [Data count storage area] [Data storage area] (Conversion/Number of Data/Conversion Data Type/Digit/Blank-padded Character/Singed/ Unsigned/Number of Decimals/Delimiter) 	<ul style="list-style-type: none"> ■When "Fixed Number of Data/ Variable Number of Data" is "Fixed Number of Data" [W0-W1] (→ 10/2/W/Digit (variable)/ Padding (0)/Unsigned/Decimal point (none)/Delimiter (none)) ■When "Fixed Number of Data/ Variable Number of Data" is "Variable Number of Data" [W0] [W1-W2] (→ 10/2/W/Digit (1)/ Padding (0)/Unsigned/Decimal point (none)/Delimiter (none))
Non-verified Reception (Fixed-Length)	Data Length (1 to 4096)	(Data Length)	(20B)
Non-verified Reception (Variable-Length)	Data Length (0)	(Variable)	(Variable)

Element type	Setting item	Display format	Display example
Error check code	<ul style="list-style-type: none"> Processing Method Code Type Data Length Data Flow Complement Calculation Calculation Range 	(Calculation Range/Processing Method/Code Type/Complement Calculation/Data Flow/Data Length)	(7-12/Prty/HEX/2C/Forward/2B)

■Terms related to element settings

Term	Description
Fixed length element	<p>An element that determines the packet data length when setting parameters.</p> <ul style="list-style-type: none"> Length Non-conversion Variable (Fixed-Length) Conversion Variable^{*1} Non-verified Reception (Fixed-Length) Error check code
Variable length element	<p>An element that does not determine the packet data length when setting parameters.</p> <ul style="list-style-type: none"> Non-conversion Variable (Variable-Length) Conversion Variable^{*2} Non-verified Reception (Variable-Length)
Variable length element that determines the data length by itself	<p>A variable length element that determines the data length by itself regardless of the placement of other elements during verification when a packet is received.</p> <ul style="list-style-type: none"> Conversion Variable^{*3}
Innermost length	<ul style="list-style-type: none"> If an element is included in multiple length calculation ranges, the length with the innermost calculation range is the innermost length of that configuration. (If multiple lengths have the same calculation range, then the length placed earlier is the innermost length.) If an element is included in only a single length calculation range, that length is the innermost length. If an element is not included in any length calculation ranges, that element does not have an innermost length. <p>■Example 1: Innermost length of element 5 (Non-conversion Variable (Variable-Length)) → Element 4</p> <p>■Example 2: Innermost length of element 4 (Non-conversion Variable (Variable-Length)) → Element 2</p>

*1 When the following settings are configured: "Fixed Number of Data/Variable Number of Data": "Fixed Number of Data", "Digit": Other than "Variable Number of Digits", "Signed/Unsigned": Other than "Signed/Positive Sign Character (None)", "Number of Decimals": Other than "Variable Point"

*2 When the conditions of a fixed length element are not met

*3 When either one of the below is applicable

(1) "Fixed Number of Data/Variable Number of Data" is "Fixed Number of Data", "Digit" is not "Variable Number of Digits", and conditions of a fixed length element are not met.

(2) "Fixed Number of Data/Variable Number of Data" is "Fixed Number of Data", "Number of Data/Maximum Number of Data" is "1", "Digit" is "Variable Number of Digits", and also "Delimiter" is "No Delimiter".

■ Restrictions on placement of variable length elements in a receive packet

No.	Restriction
1	<p>One or more following conditions must be satisfied when a variable length element is used outside the length calculation range.</p> <p>❶ There is static data outside the length calculation range after a variable length element. (A fixed length element outside the calculation range can be placed between the variable length element and static data)</p> <p>❷ The final element of a packet is a variable length element or there is only a fixed length element outside the length calculation range after a variable length element.</p> <p>❸ The variable length element determines the data length by itself.</p>
2	<p>When the variable length element that does not determine the data length by itself is used within the length calculation range, place the innermost length before the variable length element.</p>
3	<p>One or more following conditions must be satisfied when a variable length element is used within the length calculation range.</p> <p>❶ Static data is placed after the variable length element, and the innermost length of both the variable length element and static data is the same. (If the innermost length is the same, a fixed length element can be placed between the variable length element and static data.)</p> <p>❷ The variable length element is the final element within the innermost length calculation range or there is only a fixed length element with the same innermost length that is placed after the variable length element.</p> <p>❸ The variable length element determines the data length by itself.</p>

Ex.

❶ in No.1: When there is static data outside the length calculation range after a variable length element

- Can be set.

Element 1	Element 2	Element 3	Element 4	Element 5	Element 6	Element 7	...	Element 32
Static data	Variable length element	Static data	Length	Variable length element	Static data	Static data	No setting	No setting
—				Calculation range of element 4			—	

- Cannot be set.

Element 1	Element 2	Element 3	Element 4	Element 5	Element 6	Element 7	...	Element 32
Static data	Variable length element	Static data	Length	Variable length element	Static data	Static data	No setting	No setting
—		Calculation range of element 4					—	

Ex.

❷ of No.1: When a variable length element is the final element of a packet or when there is only a fixed length element outside the calculation range after a variable length element

- Can be set.

Element 1	Element 2	Element 3	...	Element 32
Static data	Variable length element	Non-verified reception (fixed length)	No setting	No setting

- Cannot be set.

Element 1	Element 2	Element 3	...	Element 32
Static data	Variable length element	Variable length element	No setting	No setting

Ex.

❸ of No.1: When the variable length element determines the data length by itself

- Can be set.

Element 1	Element 2	Element 3	...	Element 32
Static data	Variable length element (Determines the data length by itself.)	Non-conversion variable (variable length)	No setting	No setting

- Cannot be set.

Element 1	Element 2	Element 3	...	Element 32
Static data	Variable length element (Does not determine the data length by itself.)	Non-conversion variable (variable length)	No setting	No setting

Ex.

No.2: When the variable length element that does not determine the data length by itself is used within the length calculation range and the innermost length is placed before the variable length element

- Can be set.

Element 1	Element 2	Element 3	Element 4	Element 5	...	Element 32
Static data	Length	Length	Static data	Variable length element	No setting	No setting
—	Calculation range of element 2				—	
—	Calculation range of element 3				—	

- Cannot be set.

Element 1	Element 2	Element 3	Element 4	Element 5	...	Element 32
Static data	Length	Variable length element (The innermost length is before a variable length element.)	Length	Static data	No setting	No setting
—	Calculation range of element 2				—	
—	Calculation range of element 4				—	

Ex.

① of No.3: When static data is placed after the variable length element and the innermost length of both the variable length element and static data is the same.

- Can be set.

Element 1	Element 2	Element 3	Element 4	Element 5	Element 6	Element 7	...	Element 32
Static data	Length	Variable length element	Non-verified reception (fixed length)	Static data	Length	Variable length element	No setting	No setting
—					Calculation range of element 6		—	
—	Calculation range of element 2						—	

- Cannot be set.

Element 1	Element 2	Element 3	Element 4	Element 5	Element 6	Element 7	...	Element 32
Static data	Length	Variable length element	Non-verified reception (fixed length)	Static data (Its innermost length is not the same.)	Length	Variable length element	No setting	No setting
—					Calculation range of element 6		—	
—	Calculation range of element 2						—	

Ex.

② of No.3: When the variable length element is the final element within the innermost length calculation range or there is only a fixed length element with the same innermost length that is placed after the variable length element

- Can be set.

Element 1	Element 2	Element 3	Element 4	Element 5	Element 6	...	Element 32
Static data	Length	Variable length element	Non-verified reception (fixed length)	Length	Non-verified reception (fixed length)	No setting	No setting
—	Calculation range of element 2			Calculation range of element 5		—	

- Cannot be set.

Element 1	Element 2	Element 3	Element 4	Element 5	Element 6	...	Element 32
Static data	Length	Variable length element	Non-verified reception (fixed length)	Length	Non-verified reception (fixed length)	No setting	No setting
—				Calculation range of element 5 (Its innermost length is not the same.)		—	
—	Calculation range of element 2						—

Ex.

③ of No.3: When the variable length element determines the data length by itself

- Can be set.

Element 1	Element 2	Element 3	Element 4	...	Element 32
Static data	Length	Variable length element (Determines the data length by itself.)	Non-conversion variable (variable length)	No setting	No setting
—		Calculation range of element 2		—	

- Cannot be set.

Element 1	Element 2	Element 3	Element 4	...	Element 32
Static data	Length	Variable length element (Does not determine the data length by itself.)	Non-conversion variable (variable length)	No setting	No setting
—		Calculation range of element 2		—	

■Element type (Static data)

Use this type when specific codes such as commands or character strings are contained in the packet.

- When sending: The specified code or character string is sent.
- When receiving: The receive data is verified.

Up to 32 static data elements can be placed anywhere in the data part when "Resource Setting" is set to either "Normal" or "Extension 1", and up to 128 static data elements can be placed anywhere in the data part when "Resource Setting" is set to "Extension 2".

Item	Description	Setting range	Display example in "Element Setting"
Element Name	Set the element name.	48 characters (Default: Fixed Data + Element No.)	—
Code Type	Select a data type of the setting value.	<ul style="list-style-type: none"> • ASCII String • HEX (Default: HEX)	—
Setting Value	Set data within 1 to 64 bytes.	<ul style="list-style-type: none"> • When "Code Type" is "ASCII String": 20H to 7EH • When "Code Type" is "HEX": 00H to FFH (Default: Blank)	<ul style="list-style-type: none"> • When "Code Type" is "ASCII String": "1234" • When "Code Type" is "HEX": 1234

■Element type (Length)

The length code is used when there is an element that indicates the data length in the packet.

- When sending: Automatically calculates the data length in the specified range, and adds it to the packet.
- When receiving: From the received data, the data (value) corresponding to the length is verified as the specified range's data length.

Up to 31 length elements can be placed anywhere in the data part when "Resource Setting" is set to either "Normal" or "Extension 1", and up to 127 length elements can be placed anywhere in the data part when "Resource Setting" is set to "Extension 2".

Item	Description	Setting range	Display example in "Element Setting"									
Element Name	Set the element name.	48 characters (Default: Length + Element No.)	—									
Code Type	Select the data length type.	<ul style="list-style-type: none"> • ASCII HEX • ASCII DEC • HEX (Default: HEX)	<ul style="list-style-type: none"> • Hexadecimal • Decimal • HEX 									
Data Length	Select the data length on the line.	1 to 4 (Default: 1)	4B									
Data Flow ^{*1}	<table border="1"> <tr> <td>Forward Direction (Upper Byte → Lower Byte)</td> <td> <ul style="list-style-type: none"> • When sending: Sends the calculated length in order from the upper byte. • When receiving: Receives the data in order from the upper byte. </td> </tr> <tr> <td>Reverse Direction (Lower Byte → Upper Byte)</td> <td> <ul style="list-style-type: none"> • When sending: Sends the calculated length in order from the lower byte. • When receiving: Receives the data in order from the lower byte. </td> </tr> <tr> <td>Byte Swap (by Word)^{*2}</td> <td> <ul style="list-style-type: none"> • When sending: Interchanges the bytes in word units and sends the calculated length. • When receiving: Interchanges the bytes in word units and receives the data. </td> </tr> </table>	Forward Direction (Upper Byte → Lower Byte)	<ul style="list-style-type: none"> • When sending: Sends the calculated length in order from the upper byte. • When receiving: Receives the data in order from the upper byte. 	Reverse Direction (Lower Byte → Upper Byte)	<ul style="list-style-type: none"> • When sending: Sends the calculated length in order from the lower byte. • When receiving: Receives the data in order from the lower byte. 	Byte Swap (by Word) ^{*2}	<ul style="list-style-type: none"> • When sending: Interchanges the bytes in word units and sends the calculated length. • When receiving: Interchanges the bytes in word units and receives the data. 	<ul style="list-style-type: none"> • Forward Direction (Upper Byte → Lower Byte) • Reverse Direction (Lower Byte → Upper Byte) • Byte Swap (by Word) (Default: -)	<table border="1"> <tr> <td>Forward</td> </tr> <tr> <td>Reverse</td> </tr> <tr> <td>Byte</td> </tr> </table>	Forward	Reverse	Byte
Forward Direction (Upper Byte → Lower Byte)	<ul style="list-style-type: none"> • When sending: Sends the calculated length in order from the upper byte. • When receiving: Receives the data in order from the upper byte. 											
Reverse Direction (Lower Byte → Upper Byte)	<ul style="list-style-type: none"> • When sending: Sends the calculated length in order from the lower byte. • When receiving: Receives the data in order from the lower byte. 											
Byte Swap (by Word) ^{*2}	<ul style="list-style-type: none"> • When sending: Interchanges the bytes in word units and sends the calculated length. • When receiving: Interchanges the bytes in word units and receives the data. 											
Forward												
Reverse												
Byte												
Data Unit	Select the data unit. ^{*3}	<ul style="list-style-type: none"> • Byte (×1) • Bit (×8) • Word (×1/2) • Double Word (×1/4) • Custom (×1/N)^{*4} (Default: Byte (×1))	<ul style="list-style-type: none"> • ×1 • ×8 • ×1/2 • ×1/4 • ×1/N 									
Calculation Range (Start) ^{*5}	Select the start packet element number for the range to be calculated.	<ul style="list-style-type: none"> • 1 to 32 • 1 to 128 (Default: 1)	1 to 128									
Calculation Range (End) ^{*5}	Select the end packet element number for the range to be calculated.	<ul style="list-style-type: none"> • 1 to 32 • 1 to 128 (Default: 1)										

*1 This cannot be set if "Data Length" is 1 byte.

*2 This can be selected only when "Data Length" is set to 4 bytes.

*3 If the data length cannot be divided when sending, decimal places are rounded up.

*4 N is a value between 1 and 128.

*5 The number will be 1 to 32 when "Resource Setting" is set for either "Normal" or "Extension 1", and 1 to 128 for "Extension 2".

-
- If there are no elements other than length, an element error occurs. (When using length, one or more elements other than length are required.)
 - If the calculation result exceeds the number of digits set with "Data Length", the excessive digit value is discarded (invalidated). (For example, if the data length is 2 bytes and the data size calculation results are 123 bytes, the length value will be 23.)
 - When "Code Type" is "ASCII HEX", a mismatch will occur if a character string other than "0" to "9", "A" to "F", and "a" to "f" is received.
 - When "Code Type" is "ASCII DEC", a mismatch will occur if a character string other than "0" to "9" is received.
 - When converting to ASCII characters during send, Ethernet-equipped modules use "0" to "9" and "A" to "F".
 - When arranging multiple length elements, the length calculation ranges must not overlap even partially, and the previous length calculation range may not exceed the arranged length.
 - A length element cannot be arranged at the final position of the packet elements.
-

■Element type (Non-conversion variable)

Use this type to send data of the CPU module device or buffer memory as part of the send packet, or to store part of the receive packet in the CPU module device or buffer memory.

Up to 32 non-conversion variables can be placed in one packet when "Resource Setting" is set to either "Normal" or "Extension 1", and up to 128 non-conversion variables can be placed in one packet when "Resource Setting" is set to "Extension 2".

- Use for send packets: For the data length storage area, specify the size of data to be sent in the unit of bytes.
- Use for receive packets: The Ethernet-equipped module stores the size of received data in the unit of bytes in the data length storage area. (When the receive data is an odd number of bytes, the last data is stored with one byte of 00H.)

Item	Description		Setting range	Display example in "Element Setting"
Element Name	Set the element name.		48 characters (Default: Non-conversion Variable + Element No.)	—
Fixed Length/ Variable Length	Fixed Length	The data whose length is fixed is sent and received.	<ul style="list-style-type: none"> • Fixed Length • Variable Length (Default: Fixed Length)	—
	Variable Length	<ul style="list-style-type: none"> • When sending: The data length is specified at the time of the protocol execution and the data is sent. • When receiving: The data whose length is variable is received. 		
Data Length/ Maximum Data Length ³	Set the data length of the send/receive data in byte units. (When "Fixed Length/Variable Length" is "Variable Length", set the maximum data length that can be specified for the data length storage area.)		<ul style="list-style-type: none"> • 1 to 4096 • 1 to 10238 (Default: 1)	4096B
Unit of Stored Data	Lower Byte + Upper Byte	<ul style="list-style-type: none"> • When sending: Each one word (2 bytes) data in the data storage area is sent in the order of the lower byte to the upper byte. • When receiving: The receive data is stored to the data storage area in the order of the lower byte to the upper byte. 	<ul style="list-style-type: none"> • Lower Byte + Upper Byte • Lower Bytes Only (Default: Lower Byte + Upper Byte)	Lower/Upper
	Lower Bytes Only	<ul style="list-style-type: none"> • When sending: Each lower byte data in the data storage area is sent. The Ethernet-equipped module ignores the upper byte data. • When receiving: The receive data is stored to each lower byte in the data storage area. The Ethernet-equipped module stores 00H in the upper byte. 		Lower

Item	Description		Setting range	Display example in "Element Setting"
Byte Swap	Disable (Lower → Upper)	Byte swap is not performed.	<ul style="list-style-type: none"> • Disable (Lower → Upper) • Enable (Upper → Lower) • Enable (Upper → Lower, two-word units)^{*2} • Enable (Upper → Lower, four-byte units)^{*2} (Default: Disable (Lower → Upper))	No Swap
	Enable (Upper → Lower)	<ul style="list-style-type: none"> • When sending: Data in the upper byte and lower byte are swapped by one word (2 bytes) and sent. When "Unit of Stored Data" is "Lower Byte + Upper Byte" and "Data Length" is an odd number of bytes, the upper byte is sent at transmission of the last byte. When "Unit of Stored Data" is "Lower Bytes Only" and "Data Length" is an odd number of bytes, data without any byte swap is sent at transmission of the last byte. • When receiving: Data in the upper byte and lower byte are swapped by word and sent. When "Unit of Stored Data" is "Lower Byte + Upper Byte" and "Data Length" is an odd number of bytes, the last byte is stored to the upper byte. When "Unit of Stored Data" is "Lower Bytes Only" and "Data Length" is an odd number of bytes, the last byte is stored without any byte swap. 		Swap
	Enable (Upper → Lower, two-word units) ^{*1}	<ul style="list-style-type: none"> • When sending: Data in the upper byte and lower byte are swapped by two words (4 bytes) and sent. When "Data Length" is not a multiple of 4, the remainder of the data is sent without any byte swap. • When receiving: Data in the upper word and lower word are swapped in two-word units and sent. When "Data Length" is not a multiple of 4, the remainder of the data is stored without any byte swap. 		Swap (2W)
	Enable (Upper → Lower, four-byte units) ^{*1}	<ul style="list-style-type: none"> • When sending: Four-byte data is sent in order from the upper byte. When "Data Length" is not a multiple of 4, the remainder of the data is sent without any byte swap. • When receiving: The receive data is received in four-byte units in order from the upper byte. When "Data Length" is not a multiple of 4, the remainder of the data is stored without any byte swap. 		Swap (4B)
Data Storage Area Specification	Specify the start device for storing the variable value.		Refer to devices that can be specified on the following page.  Page 255 Devices that can be specified (Default: Blank)	<ul style="list-style-type: none"> • [W0-W9] • [W0][W1-W0A]

*1 This cannot be set if "Data Length" is 3 bytes or less. This can be selected only when "Data Length" is set to 4 bytes or more.

*2 The device with the firmware version of "71" or later is available.

*3 The number will be 1 to 4096 when "Resource Setting" is set for either "Normal" or "Extension 1", and 1 to 10238 for "Extension 2".

- When "Fixed Length/Variable Length" is "Fixed Length"

The area after the specified device number becomes the data storage area.

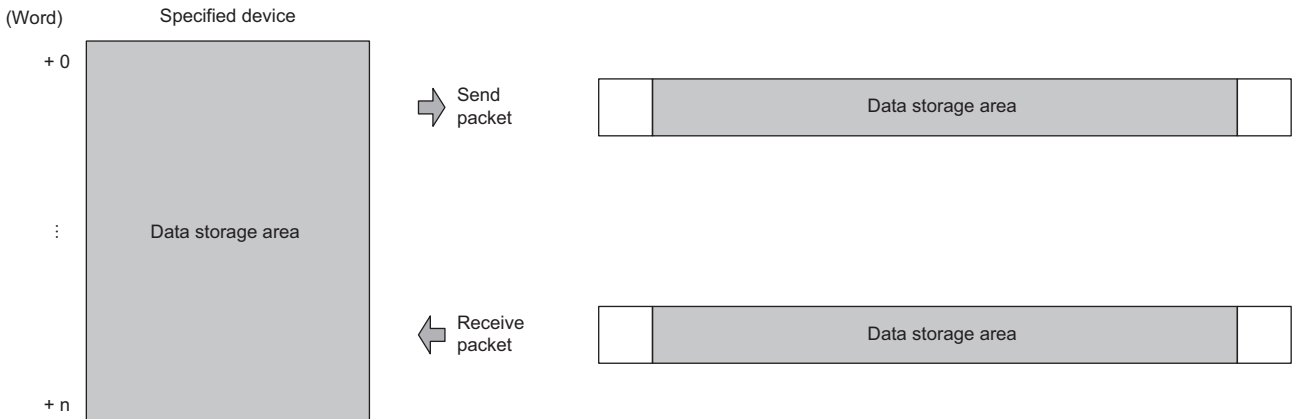

For send packet: Send data is stored by the program.

For receive packet: Receive data is stored by the Ethernet-equipped module.

Point

The occupied data storage area differs according to the "Unit of Stored Data".

- When "Lower Byte + Upper Byte" is selected, the same size as the data length is occupied. (However, when the data length of a send packet is an odd number, the upper byte (lower byte for "Byte Swap") of the end device is not sent. When the data length of a receive packet is an odd number, the last data is stored with one byte of 00H.)
- When "Lower Bytes Only" is selected, a size double the data length is occupied.

- When "Fixed Length/Variable Length" is "Variable Length"

The first word of the specified device number becomes the data length storage area, and the area after the specified device number + 1 becomes the data storage area.

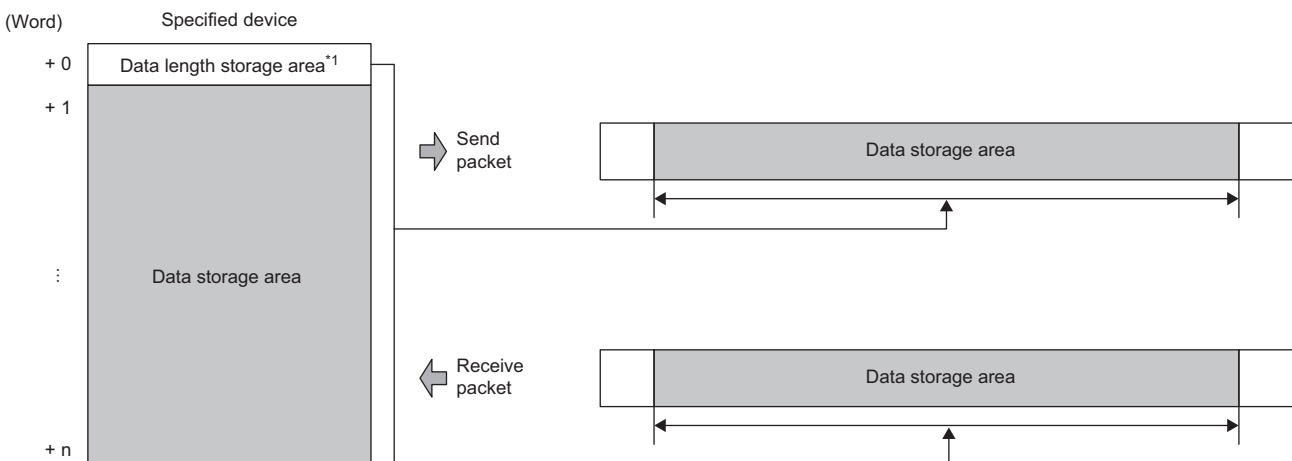

For send packet: Send data is stored by the program.

For receive packet: Receive data is stored by the Ethernet-equipped module.

*1 The data length unit is byte fixed.

Point

The occupied data storage area differs according to the "Unit of Stored Data".

- When "Lower Byte + Upper Byte" is selected, the same size as the data length + one word (for data length storage area) are occupied. (However, when the data length of a send packet is an odd number, the upper byte (lower byte for "Byte Swap") of the end device is not sent. When the data length of a receive packet is an odd number, the last data is stored with one byte of 00H.)
- When "Lower Bytes Only" is selected, a size double the data length + one word (for data length storage area) is occupied.

For restrictions, refer to the following.

 [Page 349 Restrictions on placement of variable length elements in a receive packet](#)

Precautions

When a non-conversion variable (variable length) is used in a TCP receive packet, the placed non-conversion variable (variable length) is not included in the length calculation range, and if no static data is placed in the subsequent elements, the system will continue to wait until the following number of bytes of response data are received, regardless of the value set in "Data Length/Maximum Data Length" of the non-conversion variable (variable length).

- When "Resource Setting" is set to either "Normal" or "Extension 1": 4096 bytes
- When "Resource Setting" is set to "Extension 2": 10238 bytes

- Byte swap operation

Specific operation examples for each byte swap setting are shown below.

Ex.

Example of sending when "Unit of Stored Data" is set to "Lower Byte + Upper Byte"

- When "Data Length" is a multiple of 4

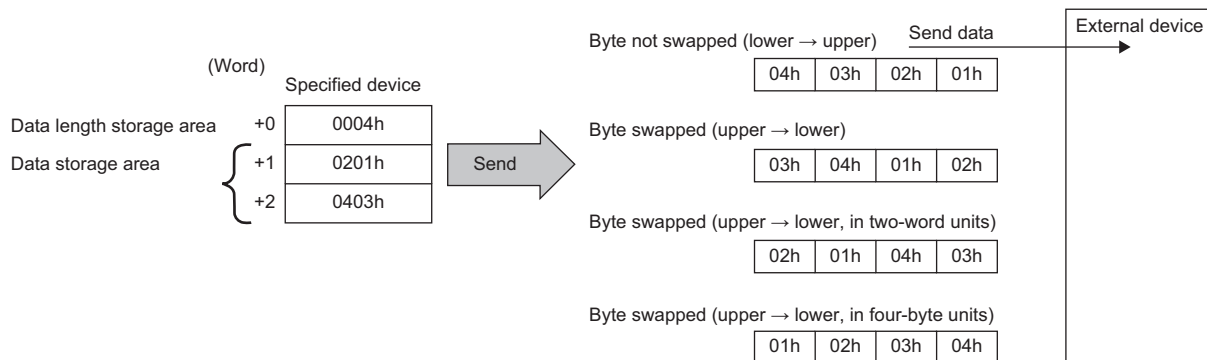

- When "Data Length" is not a multiple of 4

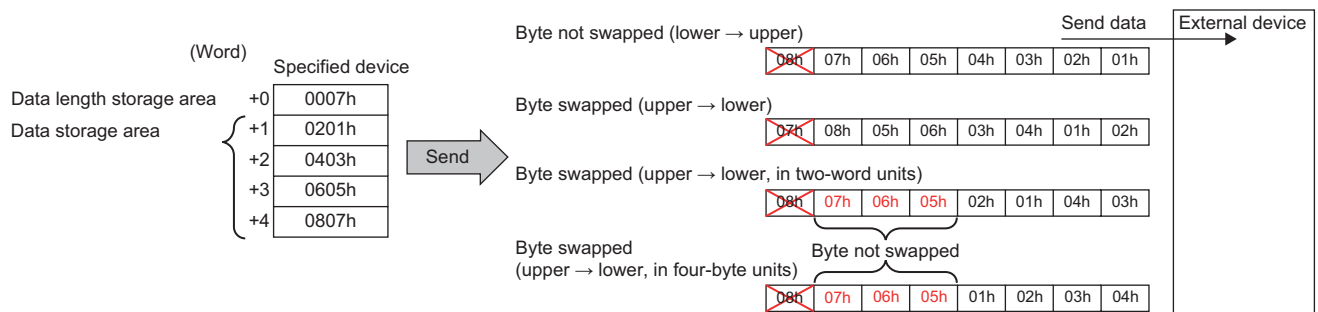

Ex.

Example of sending when "Unit of Stored Data" is set to "Lower Byte Only"

- When "Data Length" is a multiple of 4

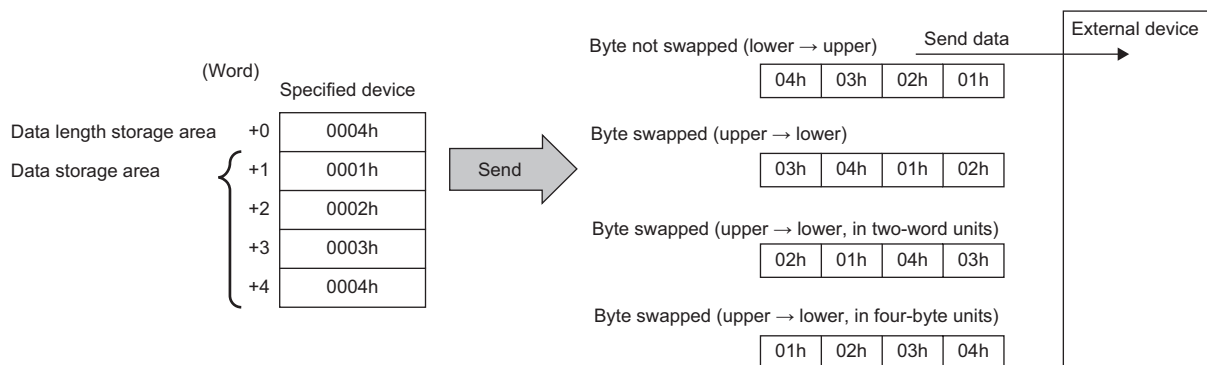

- When "Data Length" is not a multiple of 4

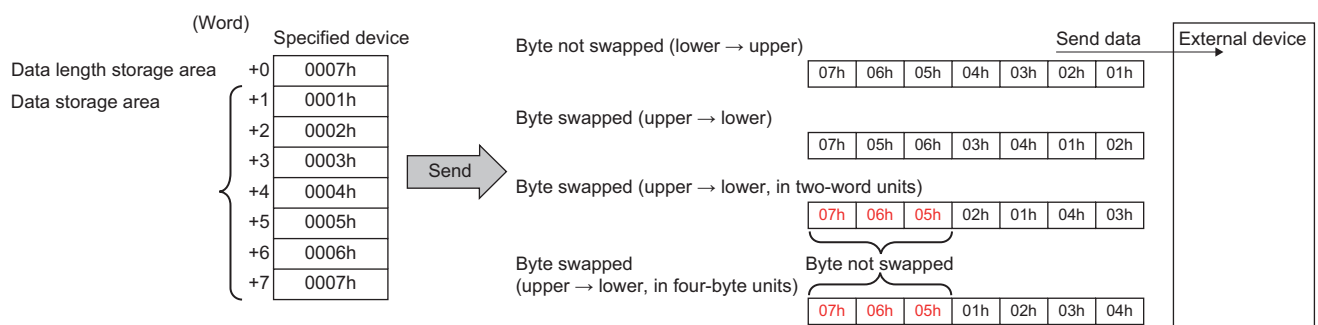

Ex.

Example of receiving when "Unit of Stored Data" is set to "Lower Byte + Upper Byte"

- When "Data Length" is a multiple of 4

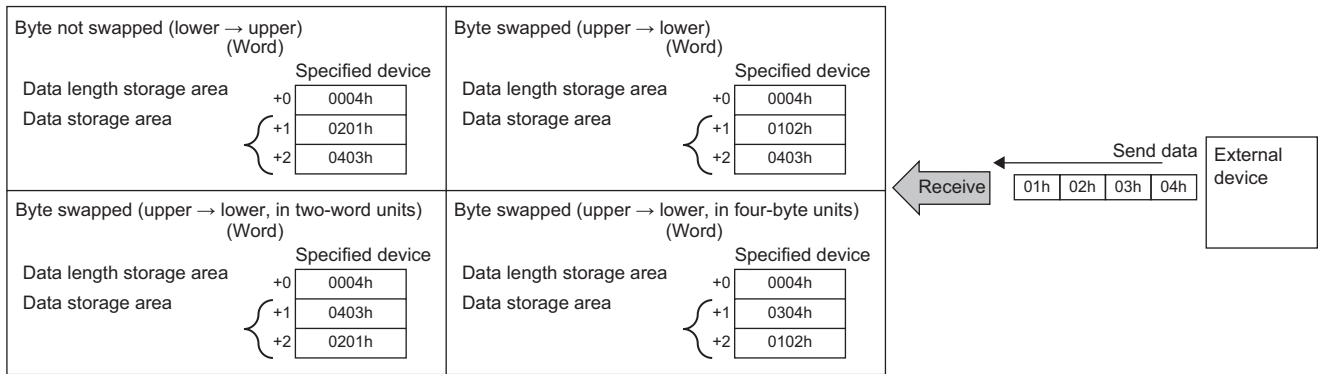

- When "Data Length" is not a multiple of 4

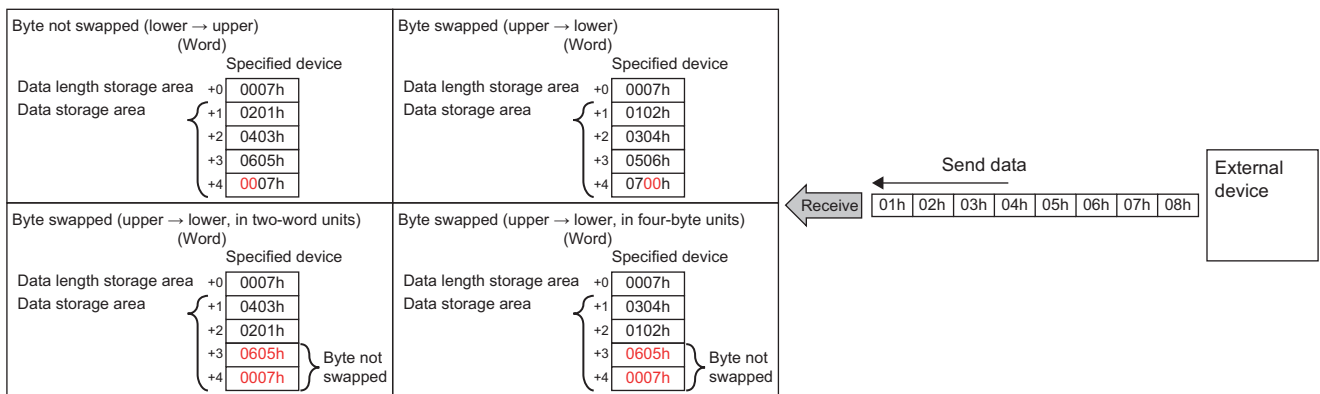

Ex.

Example of receiving when "Unit of Stored Data" is set to "Lower Byte Only"

- When "Data Length" is a multiple of 4

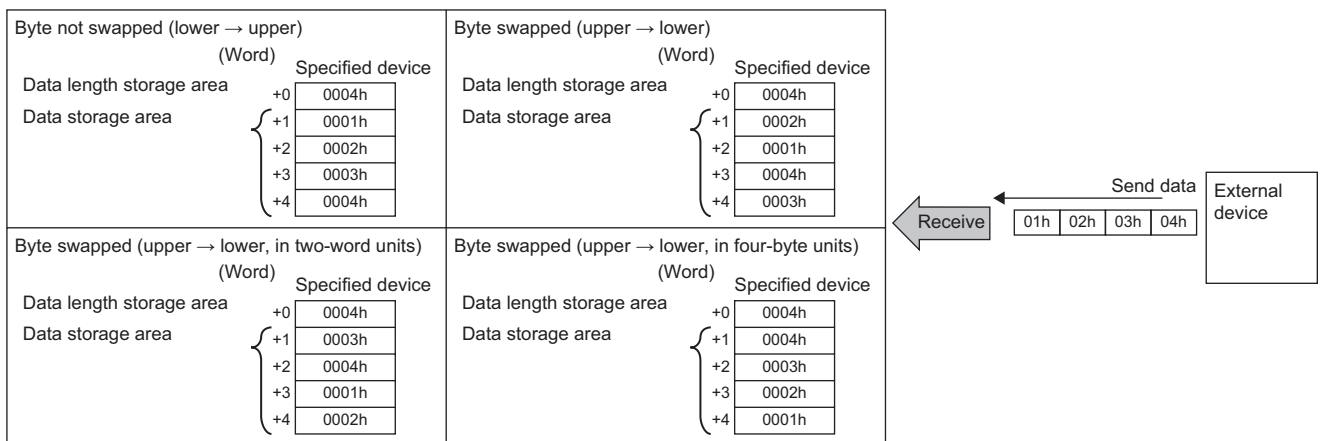

- When "Data Length" is not a multiple of 4

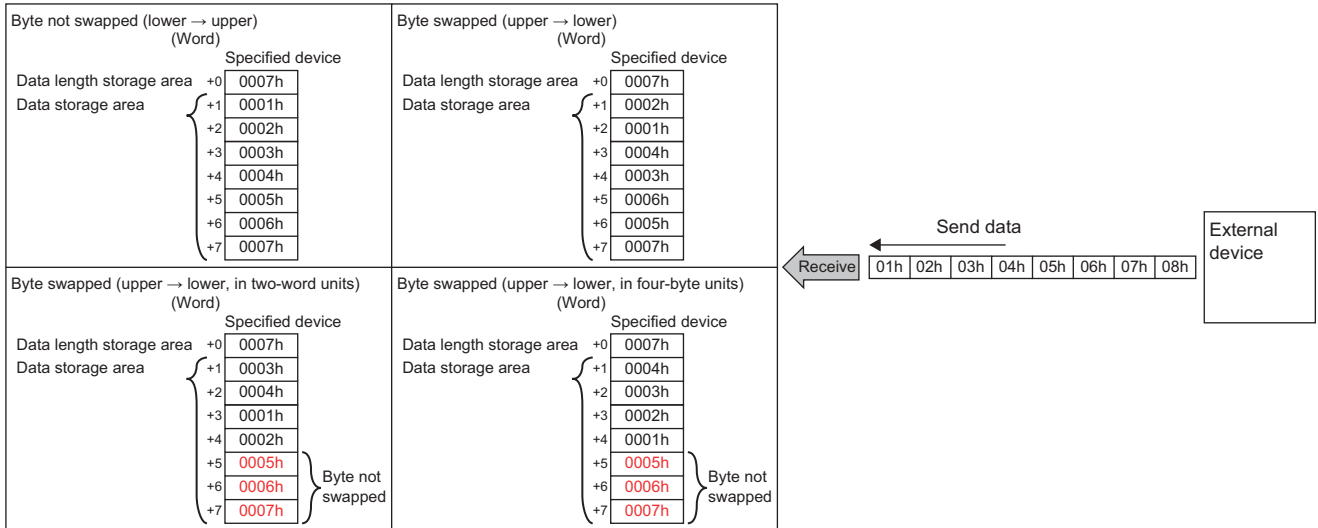

■Element type (Conversion variable)

Use this type to send numerical value data of the CPU module device or buffer memory while converting it into an ASCII string or to store receive data (ASCII string) in the CPU module device or buffer memory while converting it into numerical value data.

Up to 32 conversion variables can be placed in one packet when "Resource Setting" is set to either "Normal" or "Extension 1", and up to 128 conversion variables can be placed in one packet when "Resource Setting" is set to "Extension 2".

Item	Description		Setting range	Display example in "Element Setting"
Element Name	Set the element name.		48 characters (Default: Conversion Variable + Element No.)	—
Conversion	When sending	HEX→ASCII Hexadecimal	Numerical value data stored in the data storage area is converted into a hexadecimal ASCII string.	→16 →10 (Default: HEX→ASCII Decimal)
		HEX→ASCII Decimal		
	When receiving	ASCII Hexadecimal→HEX	Receive data is handled as a hexadecimal ASCII string, converted into numerical value data, and stored in the data storage area.	16→ 10→ (Default: ASCII Decimal→HEX)
		ASCII Decimal→HEX	Receive data is handled as a decimal ASCII string, converted into numerical value data, and stored in the data storage area.	
Fixed Number of Data/Variable Number of Data	Fixed Number of Data	The quantity of send/receive data is fixed.	• Fixed Number of Data • Variable Number of Data (Default: Fixed Number of Data)	—
	Variable Number of Data	• When sending: Data quantity to be sent is specified at the time of the protocol execution and the data is sent. • When receiving: The data whose quantity is variable is received. (When "Variable Number of Digits" is set, a delimiter is required.)		

Item	Description		Setting range	Display example in "Element Setting"
Number of Data/ Maximum Number of Data	Set the quantity of send/receive data using the unit specified in "Conversion Data Type". (When "Variable Number of Data" is set, set the maximum data quantity that can be specified for the data quantity storage area.)		1 to 256 (Default: 1)	1
Conversion Data Type	Select the number of words to be handled as a piece of data regarding data in the data storage area. When "Word" is selected, a word is converted as a piece of data. When "Double Word" is selected, two words are converted as a piece of data. When "FLOAT [Single Precision]" is selected, two words are converted as a piece of data. When "FLOAT [Double Precision]" is selected, four words are converted as a piece of data.		<ul style="list-style-type: none"> • Word • Double Word • FLOAT [Single Precision] • FLOAT [Double Precision] (Default: Word)	<ul style="list-style-type: none"> • W • D • Single • Double
Digit ²	1 to 15	Select the number of digits per data of the send/receive data. If the specified number of digits is not reached, the upper digits are padded with the character specified in "Blank-padded Character".	<ul style="list-style-type: none"> • 1 to 16 • Variable Number of Digits (Default: 5)	<ul style="list-style-type: none"> • Digit (1) • Digit (variable)
	Variable Number of Digits	<ul style="list-style-type: none"> • When sending: Only the data section converted into an ASCII string is sent in variable length. • When receiving: An ASCII string of only the data section is received in variable length. When "Number of Data/ Maximum Number of Data" is 2 or more, a delimiter is required. When "Conversion" is "HEX→ASCII Decimal" and "Conversion Data Type" is "FLOAT [Single Precision]", the maximum number of digits is 7. When "Conversion" is "HEX→ASCII Decimal" and "Conversion Data Type" is "FLOAT [Double Precision]", the maximum number of digits is 15.		
	8	When "Conversion" is "HEX→ASCII Hexadecimal" or "ASCII Hexadecimal→HEX" and "Conversion Data Type" is "FLOAT [Single Precision]", the number of digits is fixed to 8.		
	16	When "Conversion" is "HEX→ASCII Hexadecimal" or "ASCII Hexadecimal→HEX" and "Conversion Data Type" is "FLOAT [Double Precision]", the number of digits is fixed to 16.		
Blank-padded Character	Select the character for padding the upper digits to satisfy the specification of digits when the number of digits is not "Variable Number of Digits" and the send/receive data does not satisfy the specified number of digits.		<ul style="list-style-type: none"> • 0 • Space (Default: 0)	<ul style="list-style-type: none"> • Padding (0) • Padding (S)
Signed/ Unsigned ^{*1}	Unsigned	Signed characters of send/receive data are not added or specified.	<ul style="list-style-type: none"> • Unsigned • Signed/Positive Sign Character (None) • Signed/Positive Sign Character (+) • Signed/Positive Sign Character (0) • Signed/Positive Sign Character (Space) (Default: Unsigned)	<ul style="list-style-type: none"> • Unsigned • Signed (none) • Signed (+) • Signed (0) • Signed (S)
	Signed/Positive Sign Character (None)	Signed characters are not added or specified when the send/receive data is a positive number. Signed characters for negative numbers are fixed to "-".		
	Signed/Positive Sign Character (+)	<ul style="list-style-type: none"> • When sending: If send data is a positive number, the set signed character is added. Signed characters for negative numbers are fixed to "-". • When receiving: Specify the signed character for the positive number of receive data. Signed characters for negative numbers are fixed to "-". 		
	Signed/Positive Sign Character (0)			
Signed/Positive Sign Character (Space)				

Item	Description		Setting range	Display example in "Element Setting"
Number of Decimals ^{*1*3}	No Decimal Point	Decimal point is not added to send/receive data.	<ul style="list-style-type: none"> No Decimal Point Variable Point 1 to 14 (Default: No Decimal Point)	<ul style="list-style-type: none"> Decimal point (none) Decimal point (variable) Decimal point (1)
	Variable Point	When "Conversion Data Type" is "Word" or "Double Word", a decimal point is added to send/receive data based on the value stored at the decimal point position of the data storage area. When "Conversion Data Type" is "FLOAT [Single Precision]" or "FLOAT [Double Precision]", a decimal point is added to send/receive data based on the value stored in the exponent of the numerical value data.		
	1 to 14	Specify the number of digits for the decimal part of send/receive data.		
Delimiter	Select the delimiter for data to be entered after each data piece. When the data quantity is 2 or more, a delimiter is not placed after the final data. When sending: A desired delimiter can be set. When receiving: "No Delimiter" cannot be set in either of the following cases. <ul style="list-style-type: none"> When "Fixed Number of Data/Variable Number of Data" is "Variable Number of Data" and also "Digit" is "Variable Number of Digits" When "Number of Data/Maximum Number of Data" is 2 or more and also "Digit" is "Variable Number of Digits" 		<ul style="list-style-type: none"> No Delimiter Comma Space (Default: No Delimiter)	<ul style="list-style-type: none"> Delimiter (none) Delimiter (C) Delimiter (S)
Data Storage Area Specification	Specify the start device for storing the variable value.		Refer to devices that can be specified on the following page.  Page 255 Devices that can be specified (Default: Blank)	<ul style="list-style-type: none"> [W0-W1] [W0][W1-W2]

*1 This item can be set when "Conversion" is "HEX→ASCII Decimal" or "ASCII Decimal→HEX".

*2 The setting range differs according to the setting details of other setting items. For details, refer to the following.

Conversion data type	Conversion details	Setting range for number of digits
Word	<ul style="list-style-type: none"> HEX→ASCII Hexadecimal ASCII Hexadecimal→HEX 	Variable Number of Digits, 1 to 4
	<ul style="list-style-type: none"> HEX→ASCII Decimal ASCII Decimal→HEX 	Variable Number of Digits, 1 to 5
Double Word	<ul style="list-style-type: none"> HEX→ASCII Hexadecimal ASCII Hexadecimal→HEX 	Variable Number of Digits, 1 to 8
	<ul style="list-style-type: none"> HEX→ASCII Decimal ASCII Decimal→HEX 	Variable Number of Digits, 1 to 10
FLOAT [Single Precision]	<ul style="list-style-type: none"> HEX→ASCII Hexadecimal ASCII Hexadecimal→HEX 	8
	<ul style="list-style-type: none"> HEX→ASCII Decimal ASCII Decimal→HEX 	Variable Number of Digits, 1 to 7
FLOAT [Double Precision]	<ul style="list-style-type: none"> HEX→ASCII Hexadecimal ASCII Hexadecimal→HEX 	16
	<ul style="list-style-type: none"> HEX→ASCII Decimal ASCII Decimal→HEX 	Variable Number of Digits, 1 to 15

*3 The setting range differs according to the setting details of other setting items. For details, refer to the following.

Conversion data type	Digit	Setting range for number of decimal places
Word	1	No Decimal Point
	2 to 5	<ul style="list-style-type: none"> No Decimal Point Variable Point 1 to ("Digit" - 1)
	Variable Number of Digits	<ul style="list-style-type: none"> No Decimal Point Variable Point 1 to 4

Conversion data type	Digit	Setting range for number of decimal places
Double Word	1	No Decimal Point
	2 to 10	<ul style="list-style-type: none"> • No Decimal Point • Variable Point • 1 to ("Digit" - 1)
	Variable Number of Digits	<ul style="list-style-type: none"> • No Decimal Point • Variable Point • 1 to 9
FLOAT [Single Precision]	1	No Decimal Point
	2 to 7	<ul style="list-style-type: none"> • No Decimal Point • Variable Point • 1 to ("Digit" - 1)
	Variable Number of Digits	<ul style="list-style-type: none"> • No Decimal Point • Variable Point • 1 to 6
FLOAT [Double Precision]	1	No Decimal Point
	2 to 15	<ul style="list-style-type: none"> • No Decimal Point • Variable Point • 1 to ("Digit" - 1)
	Variable Number of Digits	<ul style="list-style-type: none"> • No Decimal Point • Variable Point • 1 to 14

- When "Fixed Number of Data/Variable Number of Data" is "Fixed Number of Data"

The area after the specified device number becomes the data storage area.

For send packet: Send data is stored by the program.

For receive packet: Receive data is stored by the Ethernet-equipped module.

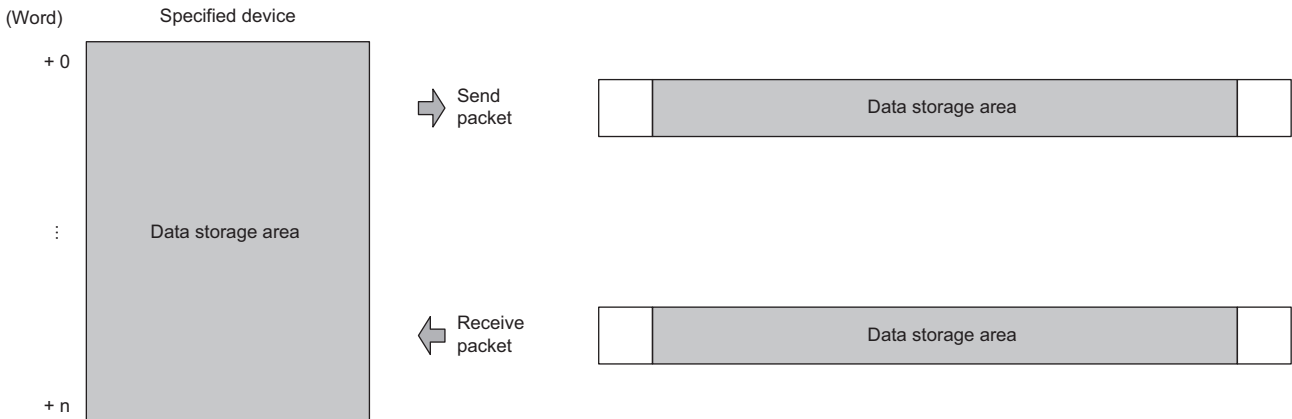

- When "Fixed Number of Data/Variable Number of Data" is "Variable Number of Data"

The first word of the specified device number becomes the data quantity storage area, and the area after the specified device number + 1 becomes the data storage area.

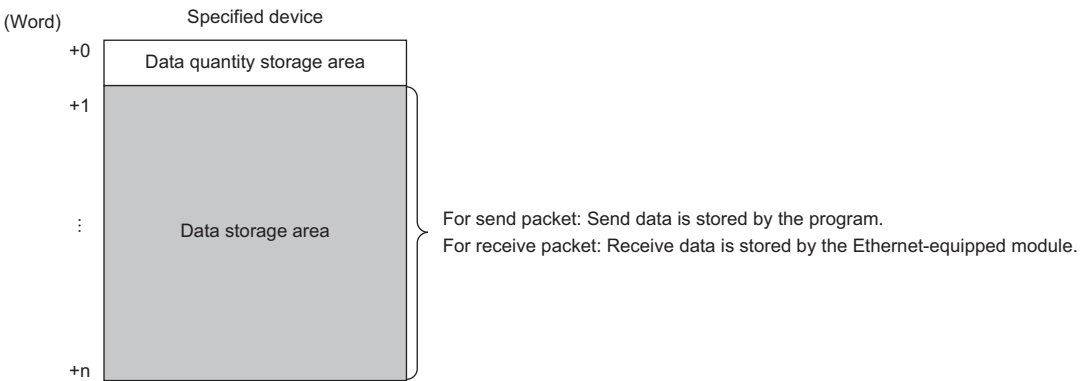

- Occupied size of data storage area

The size occupying the data storage area differs according to the "Conversion Data Type" and "Number of Decimals" settings.

Setting item		Occupied size of data storage area per data
Conversion data type	Number of decimals	
Word	No Decimal Point, 1 to 4	1 word
	Variable Point	2 words
Double Word	No Decimal Point, 1 to 9	2 words
	Variable Point	4 words
FLOAT [Single Precision]	No Decimal Point, 1 to 6	2 words
	Variable Point	2 words
FLOAT [Double Precision]	No Decimal Point, 1 to 14	4 words
	Variable Point	4 words

- Data storage area structure per data

This section describes data storage area structure per data.

Ex.

"Conversion Data Type": "Word", "Number of Decimals": "No Decimal Point" or 1 to 4

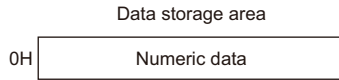

Ex.

"Conversion Data Type": "Word", "Number of Decimals": "Variable Point"

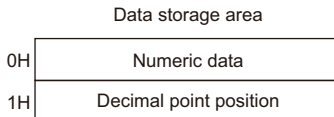

At the decimal point position, the decimal point position of send/receive data is stored as shown in the table below.

Send/receive data (when the number of digits is 5)	0H: Numerical value data	1H: Decimal point position ^{*1}
12345	12345(3039H)	1(1H)
1234.5	12345(3039H)	10(AH)
123.45	12345(3039H)	100(64H)
12.345	12345(3039H)	1000(3E8H)
1.2345	12345(3039H)	10000(2710H)

*1 For send packets, an error occurs if a value other than the values shown in the table is stored at the decimal point position.

Ex.

"Conversion Data Type": "Double Word", "Number of Decimals": "No Decimal Point" or 1 to 9

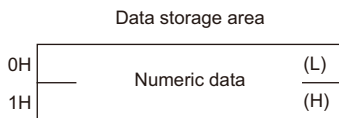

Ex.

"Conversion Data Type": "Double Word", "Number of Decimals": "Variable Point"

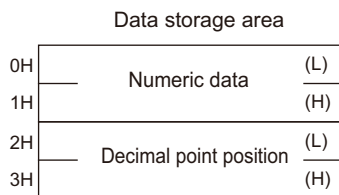

At the decimal point position, the decimal point position of send/receive data is stored as shown in the table below.

Send/receive data (when the number of digits is 10)	0H to 1H: Numerical value data	2H to 3H: Decimal point position ^{*1}
1234567890	1234567890(499602D2H)	1(1H)
123456789.0	1234567890(499602D2H)	10(AH)
12345678.90	1234567890(499602D2H)	100(64H)
1234567.890	1234567890(499602D2H)	1000(3E8H)
:	:	:
1.234567890	1234567890(499602D2H)	100000000(3B9ACA00H)

*1 For send packets, an error occurs if a value other than the values shown in the table is stored at the decimal point position.

Ex.

"Conversion Data Type": "FLOAT [Single Precision]"

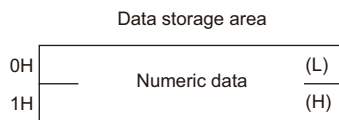

Ex.

"Conversion Data Type": "FLOAT [Double Precision]"

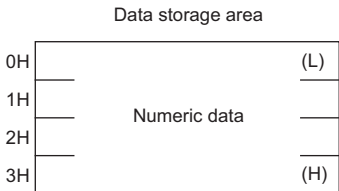

- Range of numerical values that can be handled in the data storage area

The range of numerical values that can be handled in the data storage area is as shown below.

Conversion	Signed/unsigned	Conversion data type	Numerical value range
<ul style="list-style-type: none"> • HEX→ASCII Decimal • ASCII Decimal→HEX 	Unsigned	Word	0 to 65535 (0H to FFFFH)
		Double Word	0 to 4294967295 (0H to FFFFFFFFH)
		FLOAT [Single Precision]	$0 \leq [\text{Single-precision real number data}] \leq 9999999$
		FLOAT [Double Precision]	$0 \leq [\text{Double-precision real number data}] \leq 999999999999999$
	Other than unsigned	Word	-32768 to 32767 (8000H to FFFFH, 0H to 7FFFH)
		Double Word	-2147483648 to 2147483647 (80000000H to FFFFFFFFH, 0H to 7FFFFFFFH)
		FLOAT [Single Precision]	$-9999999 \leq [\text{Single-precision real number data}] \leq 9999999$
		FLOAT [Double Precision]	$-999999999999999 \leq [\text{Double-precision real number data}] \leq 999999999999999$
<ul style="list-style-type: none"> • HEX→ASCII Hexadecimal • ASCII Hexadecimal→HEX 	—	Word	0H to FFFFH
		Double Word	0H to FFFFFFFFH
		FLOAT [Single Precision]	0H to FFFFFFFFH
		FLOAT [Double Precision]	0H to FFFFFFFFFFFFFFFFH

- Operation when "Conversion" is "HEX→ASCII Hexadecimal" or "ASCII Hexadecimal→HEX" and "Conversion Data Type" is "Word" or "Double Word"

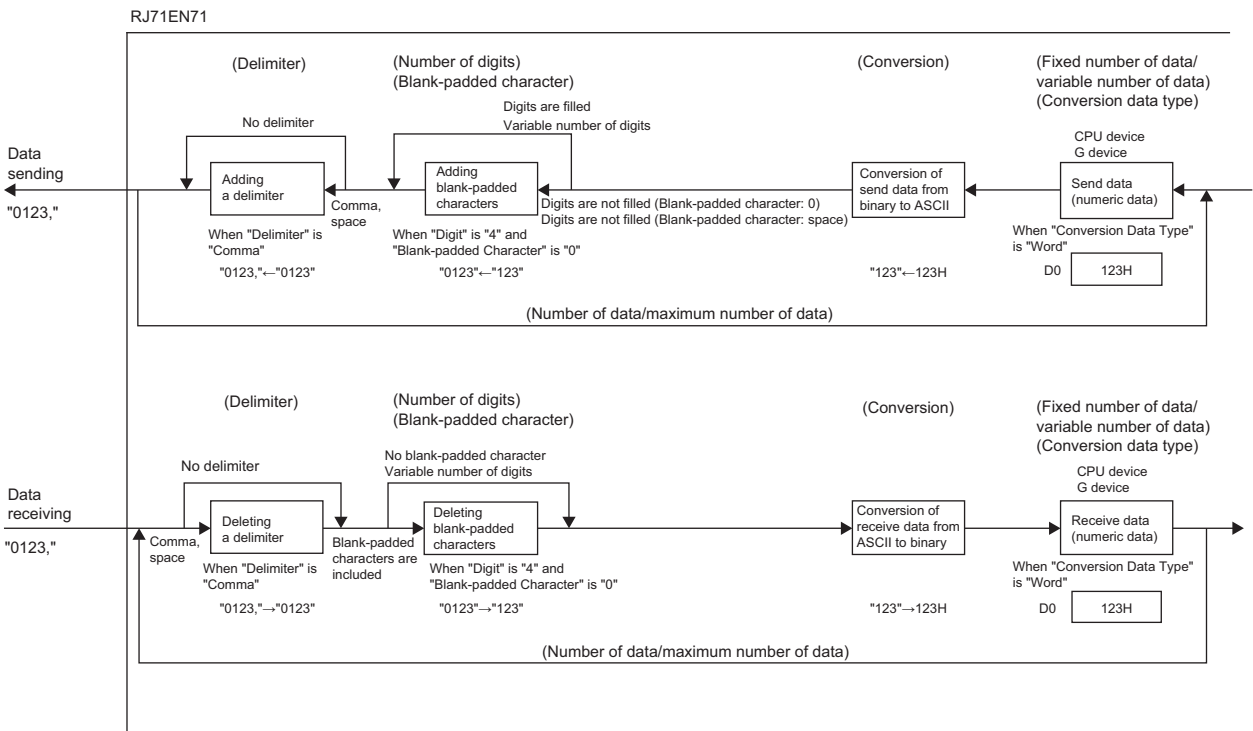

- Operation when "Conversion" is "HEX→ASCII Hexadecimal" or "ASCII Hexadecimal→HEX" and "Conversion Data Type" is "FLOAT [Single Precision]" or "FLOAT [Double Precision]"

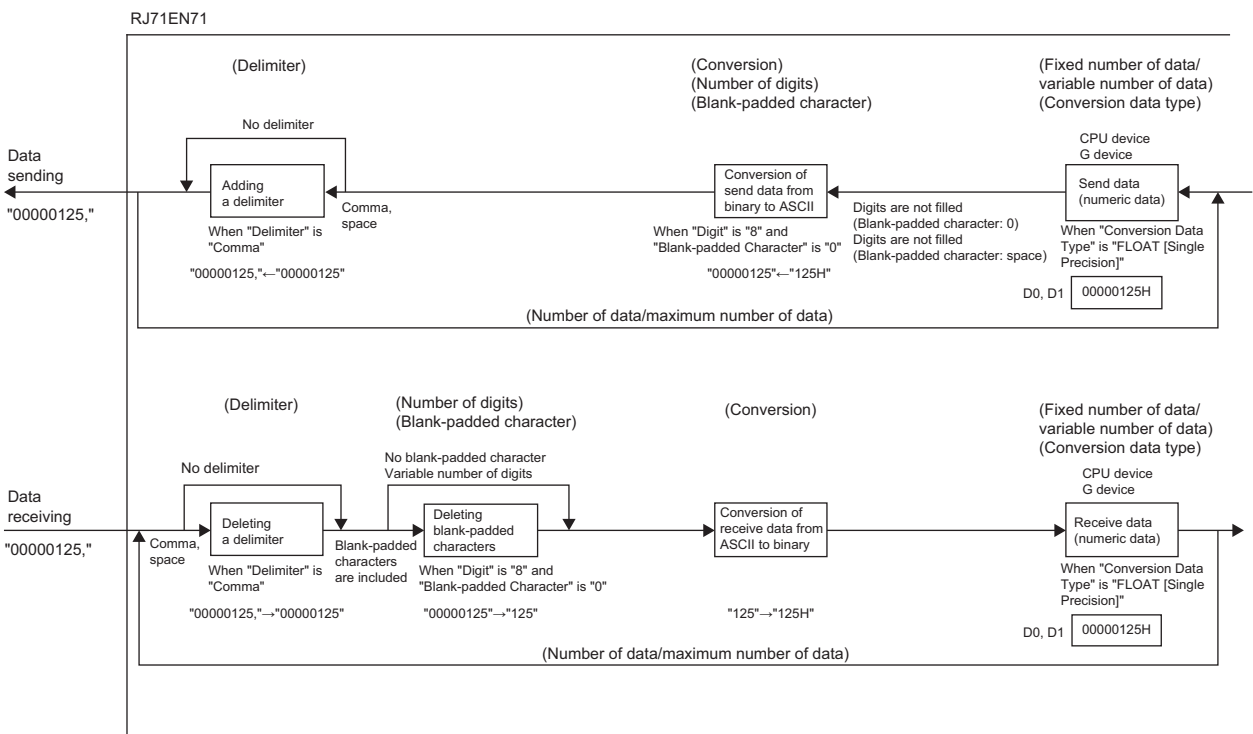

- Operation when "Conversion" is "HEX→ASCII Decimal" or "ASCII Decimal→HEX" and "Conversion Data Type" is "Word" or "Double Word"

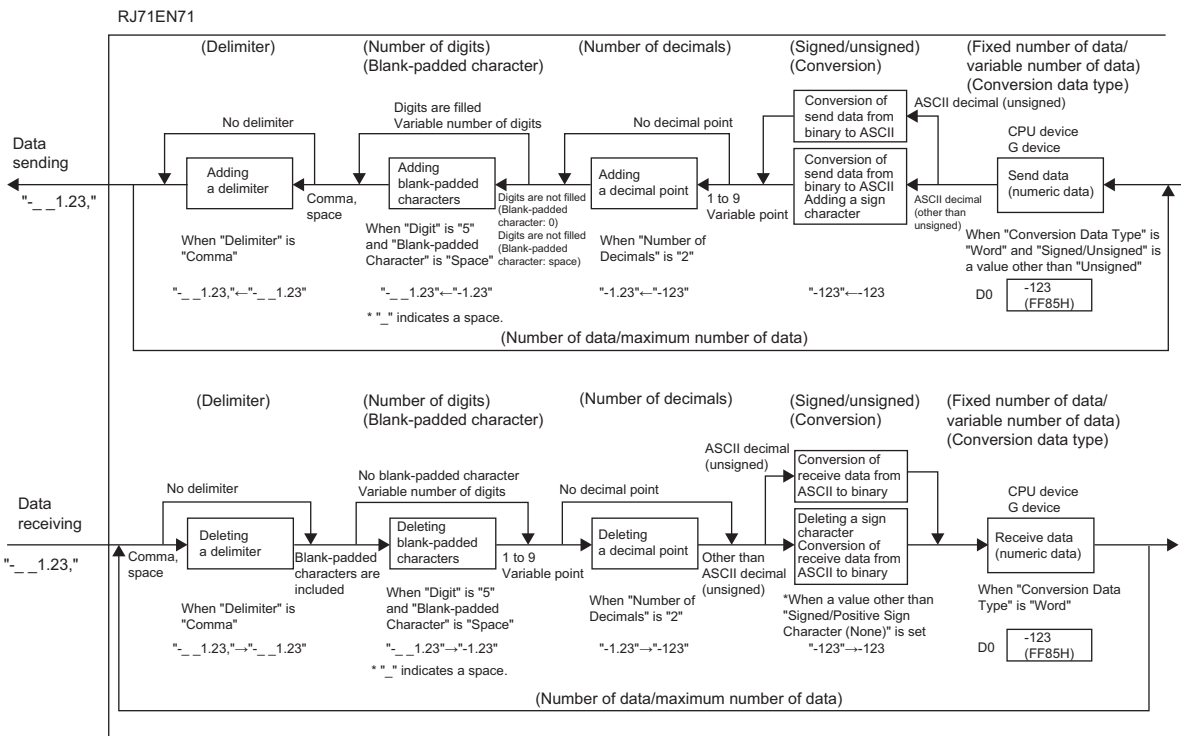

- Operation when "Conversion" is "HEX→ASCII Decimal" or "ASCII Decimal→HEX" and "Conversion Data Type" is "FLOAT [Single Precision]" or "FLOAT [Double Precision]"

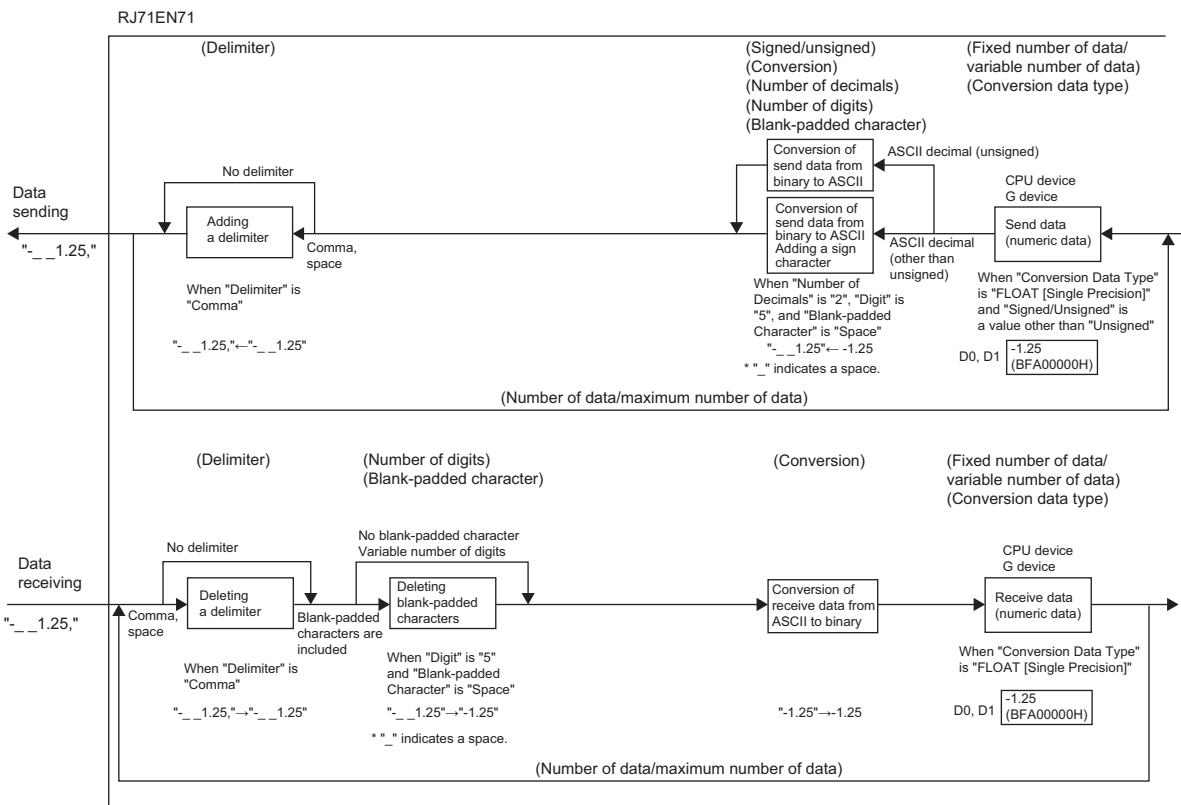

- Character for padding blank digits

If the number of digits specified in "Digit" is not reached when sending, the upper digits are padded with the character specified in "Blank-padded Character".

When receiving, both "0" and " " (space) are processed as the character for padding blank digits regardless of the specification in "Blank-padded Character".

When six digits are specified in "Digit", data is handled as shown below. (" " in the table indicates a space.)

Receive data	Operation
000120	The first three digits are handled as the character for padding blank digits.
__ 0120	The first three digits are handled as the character for padding blank digits.
0 _ 0120	The first three digits are handled as the character for padding blank digits.
___ 120	The first three digits are handled as the character for padding blank digits.
__00120	The first three digits are handled as the character for padding blank digits.
00012 _	The data is handled as a verification mismatch.
___ 12 _	The data is handled as a verification mismatch.
0001 _ 0	The data is handled as a verification mismatch.
0_1200	The data is handled as a verification mismatch.
_ (space only)	The data is handled as a verification mismatch.

Ex.

The following table shows send data when a packet is formed in the structure of [Static data], [Conversion variable], [Static data], and the data stored in the data storage area is as follows: D0 = 837 (0345H), D1 = 18 (0012H). (120345H = 1180485 in decimal)

Item	Description			
Example 1	Fixed Number of Data/Variable Number of Data	Fixed Number of Data	Fixed Number of Data	Fixed Number of Data
	Number of Data/Maximum Number of Data	1	1	1
	Send/Receive Data Storage Area	D0	D0	D0
	Conversion Data Type	Word	Word	Word
	Conversion	HEX→ASCII Decimal	HEX→ASCII Decimal	HEX→ASCII Decimal
	Digit	5	5	Variable Number of Digits
	Blank-padded Character	0	Space	—
	Signed/Unsigned	Signed/Positive Sign Character (None)	Signed/Positive Sign Character (+)	Signed/Positive Sign Character (+)
	Number of Decimals	No Decimal Point	2	No Decimal Point
	Delimiter	No Delimiter	Comma	Comma
Send data ^{*1}	[Static data]00837[Static data]	[Static data]+_ 8.37,[Static data]	[Static data]+837,[Static data]	
Example 2	Fixed Number of Data/Variable Number of Data	Fixed Number of Data	Fixed Number of Data	Fixed Number of Data
	Number of Data/Maximum Number of Data	1	2	2
	Send/Receive Data Storage Area	D0	D0	D0
	Conversion Data Type	Double Word	Word	Word
	Conversion	HEX→ASCII Decimal	HEX→ASCII Decimal	HEX→ASCII Decimal
	Digit	10	5	5
	Blank-padded Character	0	Space	0
	Signed/Unsigned	Signed/Positive Sign Character (+)	Signed/Positive Sign Character (None)	Signed/Positive Sign Character (+)
	Number of Decimals	8	No Decimal Point	2
	Delimiter	No Delimiter	No Delimiter	Comma
Send data ^{*1}	[Static data]+00.01180485[Static data]	[Static data]__ 837 ___ 18[Static data]	[Static data]+008.37,+000.18[Static data]	

*1 " " indicates a one-byte space.

Ex.

The following table shows send data when a packet is formed in the structure of [Static data], [Conversion variable], [Static data], and the data stored in the data storage area is as follows: D0 = 34790 (87E6H), D1 = 16709 (4145H), D2 = 31458 (7AE2H), D3 = 16628 (40F4H), D4 = 0 (0000H), D5 = 17334 (43B6H), D6 = 65262 (FEEEEH), D7 = 17095 (42C7H). (414587E6H, 40F47AE2H, 43B60000H, and 42C7FEEEEH are 12.345678329467773, 7.640000343322754, 364, and 99.99790954589844 in single-precision real numbers.)

When numerical values do not fit in the decimal part after conversion due to the stored data and setting details in "Digit" and "Number of Decimals", the uppermost digit of the decimal part that does not fit is rounded off.

Item	Description *1			
Example 1	Fixed Number of Data/Variable Number of Data	Fixed Number of Data	Fixed Number of Data	Fixed Number of Data
	Number of Data/Maximum Number of Data	4	4	4
	Send/Receive Data Storage Area	D0	D0	D0
	Conversion Data Type	FLOAT [Single Precision]	FLOAT [Single Precision]	FLOAT [Single Precision]
	Conversion	HEX→ASCII Decimal	HEX→ASCII Decimal	HEX→ASCII Decimal
	Digit	Variable Number of Digits	Variable Number of Digits	4
	Blank-padded Character	—	—	0
	Signed/Unsigned	Unsigned	Signed/Positive Sign Character (None)	Signed/Positive Sign Character (+)
	Number of Decimals	Variable Point	1	Variable Point
	Delimiter	No Delimiter	Comma	Space
Send data *2	[Static data]12.345687.6436499.99791[Static data]	[Static data]12.3,7.6,364.0,100.0[Static data]	[Static data]+12.35_+07.64_+0364_+0100[Static data]	
Example 2	Fixed Number of Data/Variable Number of Data	Fixed Number of Data	Fixed Number of Data	Fixed Number of Data
	Number of Data/Maximum Number of Data	4	4	4
	Send/Receive Data Storage Area	D0	D0	D0
	Conversion Data Type	FLOAT [Single Precision]	FLOAT [Single Precision]	FLOAT [Single Precision]
	Conversion	HEX→ASCII Decimal	HEX→ASCII Decimal	HEX→ASCII Decimal
	Digit	5	6	7
	Blank-padded Character	Space	0	Space
	Signed/Unsigned	Signed/Positive Sign Character (0)	Signed/Positive Sign Character (Space)	Signed/Positive Sign Character (+)
	Number of Decimals	No Decimal Point	3	Variable Point
	Delimiter	No Delimiter	Comma	Space
Send data *2	[Static data]0_ _ _120_ _ _80_ _3640_ _100[Static data]	[Static data]_012.346_ _007.640_ _364.000_ _099.998[Static data]	[Static data]+12.34568_+_ _ _ _7.64_+_ _ _ _364_+_99.99791[Static data]	

*1 When "Conversion" is "HEX→ASCII Decimal" and "Conversion Data Type" is "FLOAT [Single Precision]", the maximum number of digits is 7 if "Digit" is "Variable Number of Digits".

*2 "_ " indicates a one-byte space.

Ex.

The following table shows send data when a packet is formed in the structure of [Static data], [Conversion variable], [Static data], and the data stored in the data storage area is as follows: D0 = 28790 (7076H), D1 = 54063 (D32FH), D2 = 45308 (B0FCH), D3 = 16424 (4028H), D4 = 49812 (C294H), D5 = 10485 (28F5H), D6 = 36700 (8F5CH), D7 = 16414 (401EH), D8 = 0 (0000H), D9 = 0 (0000H), D10 = 49152 (C000H), D11 = 16502 (4076H), D12 = 21142 (5296H), D13 = 55872 (DA40H), D14 = 65535 (FFFFH), D15 = 16472 (4058H). (4028B0FCD32F7076H, 401E8F5C28F5C294H, 4076C00000000000H, and 4058FFFFDA405296H are 12.34567890123456, 7.640000000000004, 364, and 99.99999099999908 in double-precision real numbers.)

When numerical values do not fit in the decimal part after conversion due to the stored data and setting details in "Digit" and "Number of Decimals", the uppermost digit of the decimal part that does not fit is rounded off.

Item		Description*1		
Example 1	Fixed Number of Data/Variable Number of Data	Fixed Number of Data	Fixed Number of Data	Fixed Number of Data
	Number of Data/Maximum Number of Data	4	4	4
	Send/Receive Data Storage Area	D0	D0	D0
	Conversion Data Type	FLOAT [Double Precision]	FLOAT [Double Precision]	FLOAT [Double Precision]
	Conversion	HEX→ASCII Decimal	HEX→ASCII Decimal	HEX→ASCII Decimal
	Digit	Variable Number of Digits	Variable Number of Digits	4
	Blank-padded Character	—	—	0
	Signed/Unsigned	Unsigned	Signed/Positive Sign Character (None)	Signed/Positive Sign Character (+)
	Number of Decimals	Variable Point	1	Variable Point
	Delimiter	No Delimiter	Comma	Space
Send data*2	[Static data]12.34567890123467.6436499.9999909999991[Static data]	[Static data]12.3,7.6,364.0,100.0[Static data]	[Static data]+12.35_+07.64_+0364_+0100[Static data]	
Example 2	Fixed Number of Data/Variable Number of Data	Fixed Number of Data	Fixed Number of Data	Fixed Number of Data
	Number of Data/Maximum Number of Data	4	4	4
	Send/Receive Data Storage Area	D0	D0	D0
	Conversion Data Type	FLOAT [Double Precision]	FLOAT [Double Precision]	FLOAT [Double Precision]
	Conversion	HEX→ASCII Decimal	HEX→ASCII Decimal	HEX→ASCII Decimal
	Digit	8	9	15
	Blank-padded Character	Space	0	Space
	Signed/Unsigned	Signed/Positive Sign Character (0)	Signed/Positive Sign Character (Space)	Signed/Positive Sign Character (+)
	Number of Decimals	No Decimal Point	6	Variable Point
	Delimiter	No Delimiter	Comma	Space
Send data*2	[Static data]0_____120_____ ____80_____3640_____ _100[Static data]	[Static data]_012.345679_007.640000_364.000000_099.999991[Static data]	[Static data]+12.3456789012346_+_____ _____7.64_+_____ _____ _364_+99.9999909999991[Static data]	

*1 When "Conversion" is "HEX→ASCII Decimal" and "Conversion Data Type" is "FLOAT [Double Precision]", the maximum number of digits is 15 if "Digit" is "Variable Number of Digits".

*2 " _ " indicates a one-byte space.

Ex.

The following table shows send data when a packet is formed in the structure of [Static data], [Conversion variable], [Static data], and data stored in the data storage area is as follows: D0 = 837 (0345H), D1 = 18 (0012H), D2 = 43913 (AB89H), D3 = 26607 (67EFH).

Item	Description			
Example 1	Fixed Number of Data/ Variable Number of Data	Fixed Number of Data	Fixed Number of Data	Fixed Number of Data
	Number of Data/Maximum Number of Data	1	1	1
	Send/Receive Data Storage Area	D0	D0	D0
	Conversion Data Type	Word	Double Word	FLOAT [Single Precision]
	Conversion	HEX→ASCII Hexadecimal	HEX→ASCII Hexadecimal	HEX→ASCII Hexadecimal
	Digit	3	7	8
	Blank-padded Character	0	Space	0
	Signed/Unsigned	—	—	—
	Number of Decimals	—	—	—
	Delimiter	No Delimiter	Comma	Space
	Send data *1	[Static data]345[Static data]	[Static data]_120345,[Static data]	[Static data]00120345_[Static data]
Example 2	Fixed Number of Data/ Variable Number of Data	Fixed Number of Data	Fixed Number of Data	Fixed Number of Data
	Number of Data/Maximum Number of Data	1	2	3
	Send/Receive Data Storage Area	D0	D0	D1
	Conversion Data Type	FLOAT [Double Precision]	Double Word	Word
	Conversion	HEX→ASCII Hexadecimal	HEX→ASCII Hexadecimal	HEX→ASCII Hexadecimal
	Digit	16	Variable Number of Digits	4
	Blank-padded Character	Space	—	0
	Signed/Unsigned	—	—	—
	Number of Decimals	—	—	—
	Delimiter	No Delimiter	Space	Comma
	Send data *1	[Static data]67EFAB8900120345[Static data]	[Static data]120345_67EFAB89[Static data]	[Static data]0012,AB89,67EF[Static data]

*1 " _" indicates a one-byte space.

Precautions

■Error in a single-precision real number and a double-precision real number

When "Conversion Data Type" is "FLOAT [Single Precision]" or "FLOAT [Double Precision]", an error may occur during the "HEX→ASCII Decimal" conversion or "ASCII Decimal→HEX" conversion.

In this case, the conversion result may not match the conversion result of using the ESTR instruction or EVAL instruction of the CPU module or the value that can be monitored using the engineering tool. To obtain matching data, use "Word" or "Double Word".

■Restrictions by placement

Refer to the following.

📄 Page 349 Restrictions on placement of variable length elements in a receive packet

When a conversion variable is used in a TCP receive packet, if the conversion variable shown below is not included in the length calculation range and if no static data is placed in the subsequent elements, the system will continue to wait until 4096 bytes of response data are received with "Resource Setting" set to either "Normal" or "Extension 1". Or, the system will continue to wait until 10238 bytes of response data are received with "Resource Setting" set to "Extension 2".

- "Fixed Number of Data/Variable Number of "Data" is "Variable Number of Data".
- "Fixed Number of Data/Variable Number of "Data" is "Fixed Number of Data" and "Digit" is "Variable Number of Digits" (except when "Number of Data/Maximum Number of Data" is 1 and "Delimiter" is not "No Delimiter").

Restrictions when sending

- When "Conversion Data Type" is "Word" or "Double Word", "Digit" is not "Variable Number of Digits", and "Number of Decimals" is "Variable Point", an error occurs if the decimal point position is larger than the numerical value data.
- When "Conversion" is "HEX→ASCII Decimal" and "Conversion Data Type" is "FLOAT [Single Precision]" or "FLOAT [Double Precision]", an error occurs if data outside the range that can be handled in the send data storage area is set. The following shows setting examples where an error occurs.

Conversion data type	Signed/unsigned	Data stored in send data storage area	Error details
FLOAT [Single Precision]	Unsigned	• D0 = 34790 (87E6H) • D1 = 49477 (C145H)	C14587E6H is -12.345678329467773 in a single-precision real number.
FLOAT [Single Precision]	Other than "Unsigned"	• D0 = 38528 (9680H) • D1 = 19224 (4B18H)	4B189680H is 10000000 in a single-precision real number.
FLOAT [Double Precision]	Unsigned	• D0 = 0 (0000H) • D1 = 9780 (2634H) • D2 = 27637 (6BF5H) • D3 = 17164 (430CH)	430C6BF526340000H is 1000000000000000 in a double-precision real number.
FLOAT [Double Precision]	Other than "Unsigned"	• D0 = 65530 (FFFAH) • D1 = 9779 (2633H) • D2 = 27637 (6BF5H) • D3 = 49932 (C30CH)	C30C6BF52633FFFAH is -99999999999999.2 in a double-precision real number.

- An error occurs if the integer part is omitted after conversion due to setting details in "Digit" and "Number of Decimals". The following shows setting examples where an error occurs.

Conversion	Conversion data type	Number of digits	Number of decimal places	Data stored in send data storage area	Error details
HEX→ASCII Decimal	Word	"3"	—	D0 = 1234 (4D2H)	The integer part "1" is omitted as "1234" is converted into "234" due to the "Digit" setting value.
HEX→ASCII Decimal	Double Word	"6"	—	• D0 = 24910 (614EH) • D1 = 188 (00BCH)	The integer part "12" is omitted as "12345678" is converted into "345678" due to the "Digit" setting value.
HEX→ASCII Decimal	FLOAT [Single Precision]	Variable Number of Digits	"6"	• D0 = 34790 (87E6H) • D1 = 16709 (4145H)	414587E6H is 12.345678329467773 in a single-precision real number. The integer part "1" is omitted as "12.345678329467773" is converted into "2.345678" when the seventh decimal place of send data is rounded off due to the "Digit" and "Number of Decimals" setting values. (When "Conversion" is "HEX→ASCII Decimal" and "Conversion Data Type" is "FLOAT [Single Precision]", the maximum number of digits is 7 if "Digit" is "Variable Number of Digits".)
HEX→ASCII Decimal	FLOAT [Single Precision]	"2"	Variable Point	• D0 = 59872 (E9E0H) • D1 = 17142 (42F6H)	42F6E9E0H is 123.456787109375 in a single-precision real number. The integer part "1" is omitted as "123.456787109375" is converted into "23" when the first decimal place of send data is rounded off due to the "Digit" and "Number of Decimals" setting values.
HEX→ASCII Decimal	FLOAT [Single Precision]	"3"	Variable Point	• D0 = 65534 (FFFEH) • D1 = 17529 (4479H)	4479FFFEH is 999.9998779296875 in a single-precision real number. The integer part "1" is omitted as "999.9998779296875" is converted into "000" when the first decimal place of send data is rounded off due to the "Digit" and "Number of Decimals" setting values.

Conversion	Conversion data type	Number of digits	Number of decimal places	Data stored in send data storage area	Error details
HEX→ASCII Decimal	FLOAT [Single Precision]	"5"	"4"	<ul style="list-style-type: none"> D0 = 34790 (87E6H) D1 = 16709 (4145H) 	414587E6H is 12.345678329467773 in a single-precision real number. The integer part "1" is omitted as "12.345678329467773" is converted into "2.3457" when the fifth decimal place of send data is rounded off due to the "Digit" and "Number of Decimals" setting values.
HEX→ASCII Decimal	FLOAT [Single Precision]	"6"	"3"	<ul style="list-style-type: none"> D0 = 65534 (FFFEH) D1 = 17529 (4479H) 	4479FFFEH is 999.9998779296875 in a single-precision real number. The integer part "1" is omitted as "999.9998779296875" is converted into "000.000" when the fourth decimal place of send data is rounded off due to the "Digit" and "Number of Decimals" setting values.
HEX→ASCII Decimal	FLOAT [Double Precision]	Variable Number of Digits	"14"	<ul style="list-style-type: none"> D0 = 28794 (707AH) D1 = 54063 (D32FH) D2 = 45308 (B0FCH) D3 = 16424 (4028H) 	4028B0FCD32F707AH is 12.345678901234567 in a double-precision real number. The integer part "1" is omitted as "12.345678901234567" is converted into "2.34567890123457" when the 15th decimal place of send data is rounded off due to the "Digit" and "Number of Decimals" setting values. (When "Conversion" is "HEX→ASCII Decimal" and "Conversion Data Type" is "FLOAT [Double Precision]", the maximum number of digits is 15 if "Digit" is "Variable Number of Digits".)
HEX→ASCII Decimal	FLOAT [Double Precision]	Variable Number of Digits	"7"	<ul style="list-style-type: none"> D0 = 65533 (FFFDH) D1 = 65535 (FFFFH) D2 = 55171 (D783H) D3 = 16791 (4197H) 	4197D783FFFFFFFDH is 99999999.99999996 in a double-precision real number. The integer part "1" is omitted as "99999999.99999996" is converted into "00000000.00000000" when the eighth decimal place of send data is rounded off due to the "Digit" and "Number of Decimals" setting values. (When "Conversion" is "HEX→ASCII Decimal" and "Conversion Data Type" is "FLOAT [Double Precision]", the maximum number of digits is 15 if "Digit" is "Variable Number of Digits".)
HEX→ASCII Decimal	FLOAT [Double Precision]	"2"	Variable Point	<ul style="list-style-type: none"> D0 = 19609 (4C99H) D1 = 2043 (07FBH) D2 = 56636 (DD3CH) D3 = 16478 (405EH) 	405EDD3C07FB4C99H is 123.45678901234568 in a double-precision real number. The integer part "1" is omitted as "123.45678901234568" is converted into "23" when the first decimal place of send data is rounded off due to the "Digit" and "Number of Decimals" setting values.
HEX→ASCII Decimal	FLOAT [Double Precision]	"8"	Variable Point	<ul style="list-style-type: none"> D0 = 65533 (FFFDH) D1 = 65535 (FFFFH) D2 = 55171 (D783H) D3 = 16791 (4197H) 	4197D783FFFFFFFDH is 99999999.99999996 in a double-precision real number. The integer part "1" is omitted as "99999999.99999996" is converted into "00000000" when the first decimal place of send data is rounded off due to the "Digit" and "Variable Number of Digits" setting values.
HEX→ASCII Decimal	FLOAT [Double Precision]	"9"	"8"	<ul style="list-style-type: none"> D0 = 28794 (707AH) D1 = 54063 (D32FH) D2 = 45308 (B0FCH) D3 = 16424 (4028H) 	4028B0FCD32F707AH is 12.345678901234567 in a double-precision real number. The integer part "1" is omitted as "12.345678901234567" is converted into "2.34567890" when the ninth decimal place of send data is rounded off due to the "Digit" and "Number of Decimals" setting values.
HEX→ASCII Decimal	FLOAT [Double Precision]	"14"	"6"	<ul style="list-style-type: none"> D0 = 65533 (FFFDH) D1 = 65535 (FFFFH) D2 = 55171 (D783H) D3 = 16791 (4197H) 	4197D783FFFFFFFDH is 99999999.99999996 in a double-precision real number. The integer part "1" is omitted as "99999999.99999996" is converted into "00000000.00000000" when the first decimal place of send data is rounded off due to the "Digit" and "Number of Decimals" setting values.
HEX→ASCII Hexadecimal	Word	"3"	—	D0 = 4660 (1234H)	The integer part "1" is omitted as "1234" is converted into "234" due to the "Digit" setting value.
HEX→ASCII Hexadecimal	Double Word	"5"	—	<ul style="list-style-type: none"> D0 = 17767 (4567H) D1 = 291 (0123H) 	The integer part "12" is omitted as "1234567" is converted into "34567" due to the "Digit" setting value.

- When "Fixed Number of Data/Variable Number of Data" is "Variable Number of Data", an error occurs if the value stored in the data quantity storage area is larger than the value set in "Number of data/Maximum Number of Data".

■ Restrictions when receiving

- When "Conversion" is "ASCII Hexadecimal→HEX", a verification mismatch occurs if a character string other than "0" to "9", "A" to "F", or "a" to "f" is received.
- When "Conversion" is "ASCII Decimal→HEX", a verification mismatch occurs if a character string other than "0" to "9" is received. However, a verification mismatch does not occur in the following cases.

Item	Operation
Signed/Unsigned	When an item other than "Unsigned" is set, signed characters can be received. However, when a signed character is received at a position other than the start of a piece of data, a verification mismatch occurs.
Number of Decimals	When an item other than "No Decimal Point" is set, a period (.) can be received. However, when a period (.) is received at a digit other than the set digit or when a period (.) is received at the start or end of a piece of data, a verification mismatch occurs.
Delimiter	When an item other than "No Delimiter" is set, a delimiter can be received. However, when a delimiter is received at a position other than a delimiting point of data or when data not including a delimiter is received when an item other than "No Delimiter" is set, a verification mismatch occurs.

- When "Digit" is "Variable Number of Digits", a verification mismatch occurs if the number of digits of received data exceeds the following upper limit.

Conversion data type	Conversion	Upper limit of receive data quantity
Word	ASCII Decimal→HEX	5 digits maximum
	ASCII Hexadecimal→HEX	4 digits maximum
Double Word	ASCII Decimal→HEX	10 digits maximum
	ASCII Hexadecimal→HEX	8 digits maximum
FLOAT [Single Precision]	ASCII Decimal→HEX	7 digits maximum
	ASCII Hexadecimal→HEX	Cannot be set.
FLOAT [Double Precision]	ASCII Decimal→HEX	15 digits maximum
	ASCII Hexadecimal→HEX	Cannot be set.

- When "Digit" is "Variable Number of Digits", if received data only contains a delimiter or blank character string, it is handled as if 0 was received and the corresponding receive data storage area is overwritten with 0.

Ex.

When "Number of data/Maximum Number of Data" is 3 and received data is ",", it is handled as if "0,0,0" was received.

- When "Fixed Number of Data/Variable Number of Data" is "Variable Number of Data", a verification mismatch may occur if data whose number of digits is less than the number of digits specified in "Digit" is received. However, when "Digit" is "Variable Number of Digits" and "Delimiter" is set, if received data contains parts where delimiters repeat (no data), it is handled as if 0 was received and the corresponding receive data storage area is overwritten with 0.

Ex.

When "Digit" is set to 4 digits

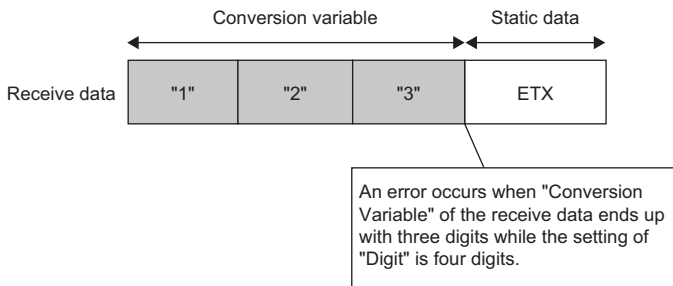

- When a conversion variable is a variable length element and a data quantity more than "Number of data/Maximum Number of Data" is received, only data that meets "Number of data/Maximum Number of Data" is stored and the remaining receive data is discarded. (The protocol is completed successfully. However, a verification mismatch occurs in the following cases.)
 - "Fixed Number of Data/Variable Number of Data" is "Fixed Number of Data", "Digit" is "Variable Number of Data", and "Number of data/Maximum Number of Data" is 2 or more.
 - "Fixed Number of Data/Variable Number of Data" is "Fixed Number of Data", "Digit" is "Variable Number of Data", "Number of data/Maximum Number of Data" is 1, and "Delimiter" is "No Delimiter".
- Among packet data received from an external device, data corresponding to a variable must be distinguished from static data immediately after a conversion variable. If it cannot be distinguished, receive processing may not be performed normally. (For example, if the value of static data immediately after a conversion variable is used for a conversion variable, verification and receive processing are performed while recognizing the value as static data right after a conversion variable.)
- When "Conversion Data Type" is "FLOAT [Single Precision]" or "FLOAT [Double Precision]", receiving data outside the range causes a verification mismatch.
- When "Number of Decimals" is 1 to 15, if the number of decimal places set in the parameter does not match the number of decimal places of received data, a verification mismatch occurs. (For example, when "Digit" is "Variable Number of Digits", "Number of Decimals" is 1, and received data is 1.23, a verification mismatch occurs as the number of decimal places set in the parameter is 1 while the received data has two decimal digits.)

■Element type (Non-verified reception)

Use this when receive data includes unnecessary data.

If the receive packet contains non-verified reception, Ethernet-equipped module skims over the specified number of characters.

Up to 32 non-verified reception elements can be placed in one packet when "Resource Setting" is set to either "Normal" or "Extension 1", and up to 128 non-verified reception elements can be placed in one packet when "Resource Setting" is set to "Extension 2".

Item	Description		Setting range	Display example in "Element Setting"
Element Name	Set the element name.		48 characters (Default: Non-verified Reception + Element No.)	—
Data Length	0 (variable number of characters)	Set when the number of characters that are not verified differs between each communication session.	<ul style="list-style-type: none"> • 0 to 4096 • 1 to 10238 (Default: 0)	(Variable)
	<ul style="list-style-type: none"> • 1 to 4096 • 1 to 10238 (Specified number of characters)	Set the number of characters that are not verified.*1		(4096B)

*1 The number will be 1 to 4096 when "Resource Setting" is set for either "Normal" or "Extension 1", and 1 to 10238 for "Extension 2".

Restriction

When setting non-verified reception (variable number of characters), one of the following conditions must be met.

- Place the static data after the non-verified reception. However, placing fixed-length elements between non-verified reception and static data is not a problem.
- Set the length before non-verified reception (ensuring that the calculation range includes the non-verified reception). However, when placing multiple non-verified receptions within the calculation range of one length, the above condition must be satisfied.
- Place the non-verified receptions at the end of the packet elements. However, placing fixed-length elements after non-verified reception is not a problem.

■Element type (Error check code)

Use this when there is a packet element that indicates the error check code data.

This element automatically calculates the error check code specified during transmission and reception, adds the code to the send packet, and detects errors in the receive packet.

Item	Description	Setting range	Display example in "Element Setting"									
Element Name	Set the element name.	48 characters (Default: Element Type + Element No.)	—									
Processing method	Select the processing method.	<ul style="list-style-type: none"> Horizontal parity Sum check 16-bit CRC (MODBUS specification) (Default: Horizontal parity)	<ul style="list-style-type: none"> PrtY Sum C(M) 									
Code type	Select the error check code format. This item cannot be set when the processing method is "16-bit CRC (MODBUS specification)".	<ul style="list-style-type: none"> ASCII HEX ASCII DEC HEX (Default: HEX)	<ul style="list-style-type: none"> Hexadecimal Decimal HEX 									
Data length	Select the data length on the line. This item cannot be set when the processing method is "16-bit CRC (MODBUS specification)".	1 to 4 (Default: 1)	1B									
Data flow ^{*1}	<table border="1"> <tr> <td>Forward direction (upper byte → lower byte)</td> <td> <ul style="list-style-type: none"> When sending: The calculated error check code is sent in order from the upper byte. When receiving: The data is treated as error check code in order from the upper byte. </td> </tr> <tr> <td>Reverse direction (lower byte → upper byte)</td> <td> <ul style="list-style-type: none"> When sending: The calculated error check code is sent in order from the lower byte. When receiving: The data is treated as error check code in order from the lower byte. </td> </tr> <tr> <td>Byte swap (by word)</td> <td> <ul style="list-style-type: none"> When sending: The bytes are swapped in word units and the calculated error check code is sent. When receiving: The bytes are swapped in word units and the data is treated as error check code. </td> </tr> </table>	Forward direction (upper byte → lower byte)	<ul style="list-style-type: none"> When sending: The calculated error check code is sent in order from the upper byte. When receiving: The data is treated as error check code in order from the upper byte. 	Reverse direction (lower byte → upper byte)	<ul style="list-style-type: none"> When sending: The calculated error check code is sent in order from the lower byte. When receiving: The data is treated as error check code in order from the lower byte. 	Byte swap (by word)	<ul style="list-style-type: none"> When sending: The bytes are swapped in word units and the calculated error check code is sent. When receiving: The bytes are swapped in word units and the data is treated as error check code. 	<ul style="list-style-type: none"> Forward direction (upper byte → lower byte) Reverse direction (lower byte → upper byte) Byte swap (by word) (Default: -)	<table border="1"> <tr> <td>Forward</td> </tr> <tr> <td>Reverse</td> </tr> <tr> <td>Byte</td> </tr> </table>	Forward	Reverse	Byte
Forward direction (upper byte → lower byte)	<ul style="list-style-type: none"> When sending: The calculated error check code is sent in order from the upper byte. When receiving: The data is treated as error check code in order from the upper byte. 											
Reverse direction (lower byte → upper byte)	<ul style="list-style-type: none"> When sending: The calculated error check code is sent in order from the lower byte. When receiving: The data is treated as error check code in order from the lower byte. 											
Byte swap (by word)	<ul style="list-style-type: none"> When sending: The bytes are swapped in word units and the calculated error check code is sent. When receiving: The bytes are swapped in word units and the data is treated as error check code. 											
Forward												
Reverse												
Byte												
Complement calculation	Select the complement calculation. This item cannot be set when the processing method is "16-bit CRC (MODBUS specification)".	<ul style="list-style-type: none"> No complement calculation One's complement calculation Two's complement calculation (Default: No complement calculation)	<ul style="list-style-type: none"> NoC 1C 2C 									
Calculation Range (Start) ^{*2}	Select the start packet element number for the range to be calculated.	<ul style="list-style-type: none"> 1 to 31 1 to 127 (Default: 1)	1-1									
Calculation Range (End) ^{*2}	Select the end packet element number for the range to be calculated.											

*1 This cannot be set if "Data length" is 1 byte. "Byte swap (by word)" can be selected only when "Data length" is set to 4 bytes.
This cannot be set when "Processing method" is 16-bit CRC (MODBUS specification).

*2 The number will be 1 to 31 when "Resource Setting" is set for either "Normal" or "Extension 1", and 1 to 127 for "Extension 2".

- Calculation of error check code

The following shows procedures for calculating the error check code.

Ex.

Calculation of horizontal parity

The following shows how to calculate horizontal parity using the following data as an example.

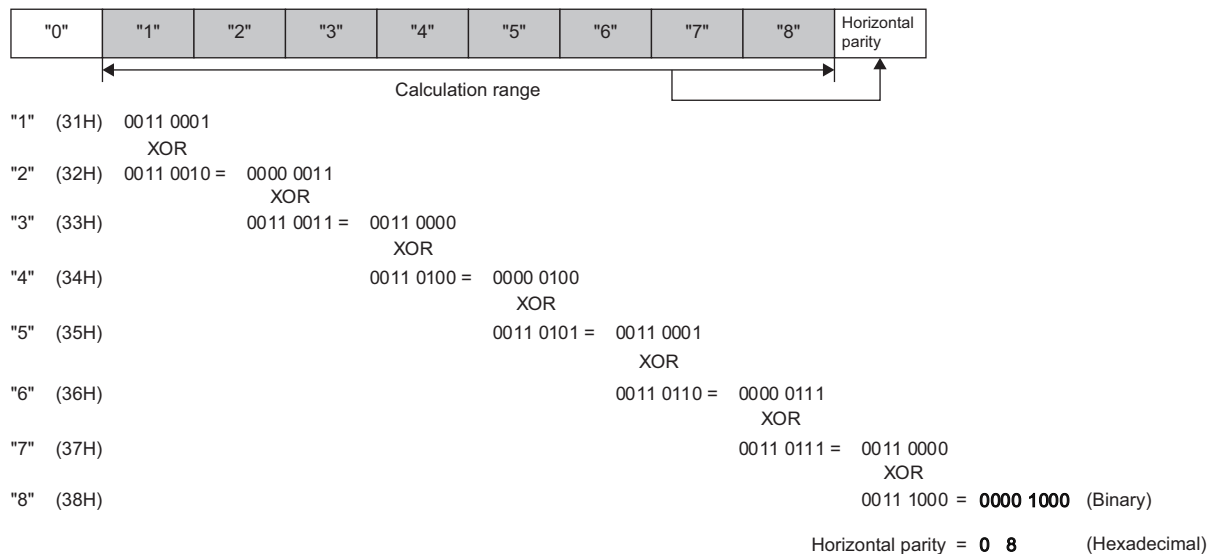

- Data flow: Forward direction, "No complement calculation" specified (08H in hexadecimal is 8 in decimal)

Code type	Data length*1			
	1 byte	2 bytes	3 bytes	4 bytes
ASCII HEX	"8" (38H)	"08" (30H 38H)	"008" (30H 30H 38H)	"0008" (30H 30H 30H 38H)
ASCII DEC	"8" (38H)	"08" (30H 38H)	"008" (30H 30H 38H)	"0008" (30H 30H 30H 38H)
HEX	08H	0008H	000008H	00000008H

*1 The values in parentheses are the ASCII codes.

- Data flow: Forward direction, "One's complement calculation" specified (One's complement of 0000 0008H is FFFF FFF7H.)

When "Code type" is "ASCII DEC", the last one word is extracted and converted from hexadecimal to decimal. (FFF7H in hexadecimal is 65527 in decimal.)

Code type	Data length*1			
	1 byte	2 bytes	3 bytes	4 bytes
ASCII HEX	"7" (37H)	"F7" (46H 37H)	"FF7" (46H 46H 37H)	"FFF7" (46H 46H 46H 37H)
ASCII DEC	"7" (37H)	"27" (32H 37H)	"527" (35H 32H 37H)	"5527" (35H 35H 32H 37H)
HEX	F7H	FFF7H	FFFFF7H	FFFFFFF7H

*1 The values in parentheses are the ASCII codes.

- Data flow: Forward direction, "Two's complement calculation" specified (Two's complement of 0000 0008H is FFFF FFF8H.)

When "Code type" is "ASCII DEC", the last one word is extracted and converted from hexadecimal to decimal. (FFF8H in hexadecimal is 65528 in decimal.)

Code type	Data length* ¹			
	1 byte	2 bytes	3 bytes	4 bytes
ASCII HEX	"8" (38H)	"F8" (46H 38H)	"FF8" (46H 46H 38H)	"FFF8" (46H 46H 46H 38H)
ASCII DEC	"8" (38H)	"28" (32H 38H)	"528" (35H 32H 38H)	"5528" (35H 35H 32H 38H)
HEX	F8H	FFF8H	FFFFF8H	FFFFFFF8H

*1 The values in parentheses are the ASCII codes.

- Data flow: Reverse direction, "No complement calculation" specified (08H in hexadecimal is 8 in decimal.)

Code type	Data length* ¹			
	1 byte	2 bytes	3 bytes	4 bytes
ASCII HEX	—	"80" (38H 30H)	"800" (38H 30H 30H)	"8000" (38H 30H 30H 30H)
ASCII DEC	—	"80" (38H 30H)	"800" (38H 30H 30H)	"8000" (38H 30H 30H 30H)
HEX	—	0800H	080000H	08000000H

*1 The values in parentheses are the ASCII codes.

- Data flow: Reverse direction, "One's complement calculation" specified (One's complement of 0000 0008H is FFFF FFF7H.)

When "Code type" is "ASCII DEC", the last one word is extracted and converted from hexadecimal to decimal. (FFF7H in hexadecimal is 65527 in decimal.)

Code type	Data length* ¹			
	1 byte	2 bytes	3 bytes	4 bytes
ASCII HEX	—	"7F" (37H 46H)	"7FF" (37H 46H 46H)	"7FFF" (37H 46H 46H 46H)
ASCII DEC	—	"72" (37H 32H)	"725" (37H 32H 35H)	"7255" (37H 32H 35H 35H)
HEX	—	F7FFH	F7FFFFH	F7FFFFFFH

*1 The values in parentheses are the ASCII codes.

- Data flow: Reverse direction, "Two's complement calculation" specified (Two's complement of 0000 0008H is FFFF FFF8H.)

When "Code type" is "ASCII DEC", the last one word is extracted and converted from hexadecimal to decimal. (FFF8H in hexadecimal is 65528 in decimal.)

Code type	Data length* ¹			
	1 byte	2 bytes	3 bytes	4 bytes
ASCII HEX	—	"8F" (38H 46H)	"8FF" (38H 46H 46H)	"8FFF" (38H 46H 46H 46H)
ASCII DEC	—	"82" (38H 32H)	"825" (38H 32H 35H)	"8255" (38H 32H 35H 35H)
HEX	—	F8FFH	F8FFFFH	F8FFFFFFH

*1 The values in parentheses are the ASCII codes.

- Data flow: Byte swap, "No complement calculation" specified (08H in hexadecimal is 8 in decimal)

Code type	Data length* ¹			
	1 byte	2 bytes	3 bytes	4 bytes
ASCII HEX	—	—	—	"0800" (30H 38H 30H 30H)
ASCII DEC	—	—	—	"0800" (30H 38H 30H 30H)
HEX	—	—	—	00080000H

*1 The values in parentheses are the ASCII codes.

- Data flow: Byte swap, "One's complement calculation" specified (One's complement of 0000 0008H is FFFF FFF7H.)
When "Code type" is "ASCII DEC", the last one word is extracted and converted from hexadecimal to decimal. (FFF7H in hexadecimal is 65527 in decimal.)

Code type	Data length* ¹			
	1 byte	2 bytes	3 bytes	4 bytes
ASCII HEX	—	—	—	"F7FF" (46H 37H 46H 46H)
ASCII DEC	—	—	—	"2755" (32H 37H 35H 35H)
HEX	—	—	—	FFF7FFFFH

*1 The values in parentheses are the ASCII codes.

- Data flow: Byte Swap, "Two's complement calculation" specified (Two's complement of 0000 0008H is FFFF FFF8H.)
When "Code type" is "ASCII DEC", the last one word is extracted and converted from hexadecimal to decimal. (FFF8H in hexadecimal is 65528 in decimal.)

Code type	Data length* ¹			
	1 byte	2 bytes	3 bytes	4 bytes
ASCII HEX	—	—	—	"F8FF" (46H 38H 46H 46H)
ASCII DEC	—	—	—	"2855" (32H 38H 35H 35H)
HEX	—	—	—	FFF8FFFFH

*1 The values in parentheses are the ASCII codes.

Ex.

Calculation of sum check

The following shows how to calculate sum check codes using the following data as an example.

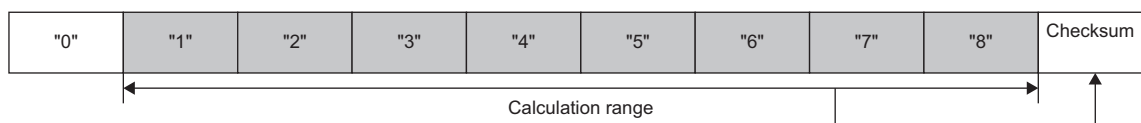

(For above packet)

Checksum value = 31H + 32H + 33H + 34H + 35H + 36H + 37H + 38H = 1A4H

- Data flow: Forward direction, "No complement calculation" specified (1A4H in hexadecimal is 420 in decimal.)

Code Type	Data Length* ¹			
	1 byte	2 bytes	3 bytes	4 bytes
ASCII HEX	"4" (34H)	"A4" (41H 34H)	"1A4" (31H 41H 34H)	"01A4" (30H 31H 41H 34H)
ASCII DEC	"0" (30H)	"20" (32H 30H)	"420" (34H 32H 30H)	"0420" (30H 34H 32H 30H)
HEX	A4H	01A4H	0001A4H	000001A4H

*1 The values in parentheses are the ASCII codes.

- Data flow: Forward direction, "One's complement calculation" specified (One's complement of 0000 01A4H is FFFF FE5BH.)

When "Code type" is "ASCII DEC", the last one word is extracted and converted from hexadecimal to decimal. (FE5BH in hexadecimal is 65115 in decimal.)

Code type	Data length* ¹			
	1 byte	2 bytes	3 bytes	4 bytes
ASCII HEX	"B" (42H)	"5B" (35H 42H)	"E5B" (45H 35H 42H)	"FE5B" (46H 45H 35H 42H)
ASCII DEC	"5" (35H)	"15" (31H 35H)	"115" (31H 31H 35H)	"5115" (35H 31H 31H 35H)
HEX	5BH	FE5BH	FFFE5BH	FFFFFE5BH

*1 The values in parentheses are the ASCII codes.

- Data flow: Forward direction, "Two's complement calculation" specified (Two's complement of 0000 01A4H is FFFF FE5CH.)

When "Code type" is "ASCII DEC", the last one word is extracted and converted from hexadecimal to decimal. (FE5CH in hexadecimal is 65116 in decimal.)

Code type	Data length* ¹			
	1 byte	2 bytes	3 bytes	4 bytes
ASCII HEX	"C" (43H)	"5C" (35H 43H)	"E5C" (45H 35H 43H)	"FE5C" (46H 45H 35H 43H)
ASCII DEC	"6" (36H)	"16" (31H 36H)	"116" (31H 31H 36H)	"5116" (35H 31H 31H 36H)
HEX	5CH	FE5CH	FFFE5CH	FFFFFE5CH

*1 The values in parentheses are the ASCII codes.

- Data flow: Reverse direction, "No complement calculation" specified (1A4H in hexadecimal is 420 in decimal.)

Code type	Data length* ¹			
	1 byte	2 bytes	3 bytes	4 bytes
ASCII HEX	—	"4A" (34H 41H)	"4A1" (34H 41H 31H)	"4A10" (34H 41H 31H 30H)
ASCII DEC	—	"02" (30H 32H)	"024" (30H 32H 34H)	"0240" (30H 32H 34H 30H)
HEX	—	A401H	A40100H	A4010000H

*1 The values in parentheses are the ASCII codes.

- Data flow: Reverse direction, "One's complement calculation" specified (One's complement of 0000 01A4H is FFFF FE5BH.)

When "Code type" is "ASCII DEC", the last one word is extracted and converted from hexadecimal to decimal. (FE5BH in hexadecimal is 65115 in decimal.)

Code type	Data length* ¹			
	1 byte	2 bytes	3 bytes	4 bytes
ASCII HEX	—	"B5" (42H 35H)	"B5E" (42H 35H 45H)	"B5EF" (42H 35H 45H 46H)
ASCII DEC	—	"51" (35H 31H)	"511" (35H 31H 31H)	"5115" (35H 31H 31H 35H)
HEX	—	5BFEH	5BFEFFH	5BFEFFFFH

*1 The values in parentheses are the ASCII codes.

- Data flow: Reverse direction, "Two's complement calculation" specified (Two's complement of 0000 01A4H is FFFF FE5CH.)

When "Code type" is "ASCII DEC", the last one word is extracted and converted from hexadecimal to decimal. (FE5CH in hexadecimal is 65116 in decimal.)

Code type	Data length ^{*1}			
	1 byte	2 bytes	3 bytes	4 bytes
ASCII HEX	—	"C5" (43H 35H)	"C5E" (43H 35H 45H)	"C5EF" (43H 35H 45H 46H)
ASCII DEC	—	"61" (36H 31H)	"611" (36H 31H 31H)	"6115" (36H 31H 31H 35H)
HEX	—	5CFEH	5CFEFFFH	5CFEFFFFH

*1 The values in parentheses are the ASCII codes.

- Data flow: Byte swap, "No complement calculation" specified (1A4H in hexadecimal is 420 in decimal.)

Code type	Data length ^{*1}			
	1 byte	2 bytes	3 bytes	4 bytes
ASCII HEX	—	—	—	"A401" (41H 34H 30H 31H)
ASCII DEC	—	—	—	"2004" (32H 30H 30H 34H)
HEX	—	—	—	01A40000H

*1 The values in parentheses are the ASCII codes.

- Data flow: Byte Swap, "One's complement calculation" specified (One's complement of 0000 01A4H is FFFF FE5BH.)

When "Code type" is "ASCII DEC", the last one word is extracted and converted from hexadecimal to decimal. (FE5BH in hexadecimal is 65115 in decimal.)

Code type	Data length ^{*1}			
	1 byte	2 bytes	3 bytes	4 bytes
ASCII HEX	—	—	—	"5BFE" (35H 42H 47H 46H)
ASCII DEC	—	—	—	"1551" (31F 35H 35H 31H)
HEX	—	—	—	FE5BFFFFH

*1 The values in parentheses are the ASCII codes.

• Data flow: Byte Swap, "Two's complement calculation" specified (Two's complement of 0000 01A4H is FFFF FE5CH.)
When "Code type" is "ASCII DEC", the last one word is extracted and converted from hexadecimal to decimal. (FE5CH in hexadecimal is 65116 in decimal.)

Code type	Data length ^{*1}			
	1 byte	2 bytes	3 bytes	4 bytes
ASCII HEX	—	—	—	"5CFE" (35H 43H 47H 46H)
ASCII DEC	—	—	—	"1651" (31F 36H 35H 31H)
HEX	—	—	—	FE5CFFFFH

*1 The values in parentheses are the ASCII codes.

Ex.

16-bit CRC (MODBUS specification) calculation procedure

This error check method is used when data are sent/received with the RTU mode of the MODBUS protocol. The data length of CRC is fixed at 2 bytes (16 bits), and the CRC is calculated every 1 byte (8 bits) from the start of the calculation range according to the following procedure.

1. Load a 16-bit register whose bits are all "1".
2. Calculate the exclusive OR (XOR) of the first 1 byte (8 bits) in the calculation range and the bits in Step 1 above.
3. Shift the result of Step 2 to the right by 1 bit.
4. If the least significant bit of Step 2 is "1", calculate the exclusive OR (XOR) of the result of Step 3 and the generator polynomial (A001H). If the least significant bit is "0", shift the result to the right by 1 bit without calculating the exclusive OR (XOR).
5. Repeat Steps 3 and 4 eight times.
6. Calculate the exclusive OR (XOR) of the result of Step 5 and the next 1 byte (8 bits).
7. Repeat Steps 3 through 6 until all bytes in the calculation range have been processed. The resulting value is the calculated CRC value.
8. The CRC value is stored in a packet in the order of lower 8 bits to upper 8 bits.

For specific calculation examples, refer to the following.

A calculation example for adding an error check (16-bit CRC (MODBUS specification)) to a MODBUS RTU mode frame is shown below.

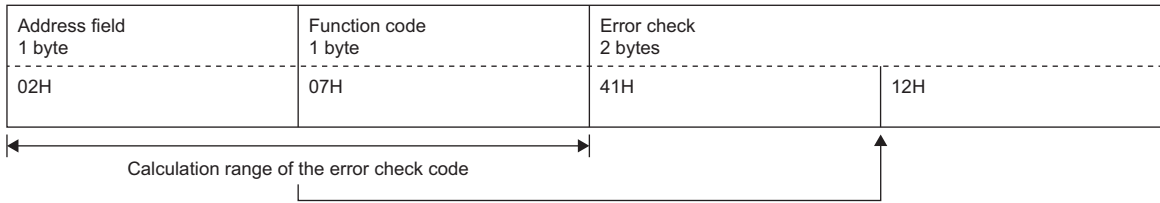

The calculation process is shown below.

CRC error check procedure	16-bit register (MSB)			Flag ^{*1}
1	Load a 16-bit register whose bits are all "1".	1111 1111	1111 1111	—
2	Address field (02H)	—	0000 0010	—
	Exclusive OR (XOR)	1111 1111	1111 1101	
3	Shift 1	0111 1111	1111 1110	1
4	Generator polynomial (A001H)	1010 0000	0000 0001	—
	Exclusive OR (XOR)	1101 1111	1111 1111	
5	Shift 2	0110 1111	1111 1111	1
	Generator polynomial (A001H)	1010 0000	0000 0001	—
	Exclusive OR (XOR)	1100 1111	1111 1110	
	Shift 3	0110 0111	1111 1111	0
	Shift 4	0011 0011	1111 1111	1
	Generator polynomial (A001H)	1010 0000	0000 0001	—
	Exclusive OR (XOR)	1001 0011	1111 1110	
	Shift 5	0100 1001	1111 1111	0
	Shift 6	0010 0100	1111 1111	1
	Generator polynomial (A001H)	1010 0000	0000 0001	—
	Exclusive OR (XOR)	1000 0100	1111 1110	
	Shift 7	0100 0010	0111 1111	0
	Shift 8	0010 0001	0011 1111	1
	Generator polynomial (A001H)	1010 0000	0000 0001	—
	Exclusive OR (XOR)	1000 0001	0011 1110	
	6	Function code (07H)	—	0000 0111
Exclusive OR (XOR)		1000 0001	0011 1001	
7	Shift 1	0100 0000	1001 1100	1
	Generator polynomial (A001H)	1010 0000	0000 0001	—
	Exclusive OR (XOR)	1110 0000	1001 1101	
	Shift 2	0111 0000	0100 1110	1
	Generator polynomial (A001H)	1010 0000	0000 0001	—
	Exclusive OR (XOR)	1101 0000	0100 1111	
	Shift 3	0110 1000	0010 0111	1
	Generator polynomial (A001H)	1010 0000	0000 0001	—
	Exclusive OR (XOR)	1100 1000	0010 1110	
	Shift 4	0110 0100	0001 0011	0
	Shift 5	0011 0010	0000 1001	1
	Generator polynomial (A001H)	1010 0000	0000 0001	—
	Exclusive OR (XOR)	1001 0010	0000 1000	
	Shift 6	0100 1001	0000 0100	0
	Shift 7	0010 0100	1000 0010	0
	Shift 8	0001 0010	0100 0001	0
8	CRC value	12H	41H	—

*1 Least significant bit of previous exclusive OR (XOR)

Ex.**Calculation range of error check code**

The following shows an example of specifying the calculation range of the error check code.

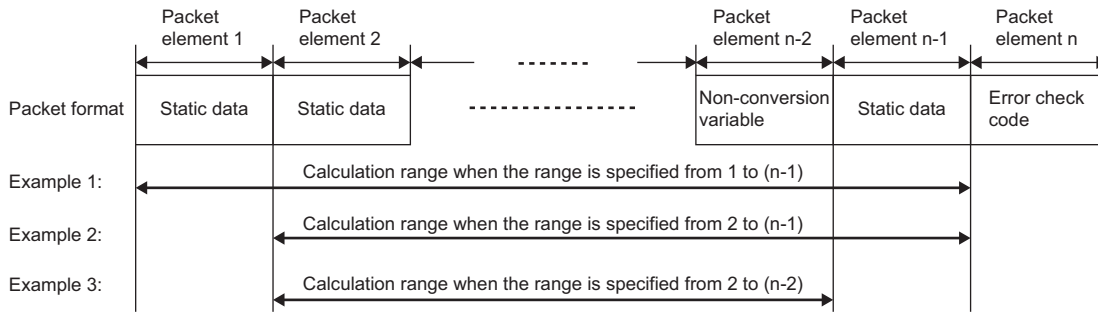
**Restriction**

- When the "Code type" setting is "ASCII HEX", a verification mismatch is judged to have occurred if a character string other than "0" to "9", "A" to "F", or "a" to "f" is received.
- When the "Code type" setting is "ASCII DEC", a verification mismatch is judged to have occurred if a character string other than "0" to "9" is received.
- When converting to ASCII characters during send, Ethernet-equipped modules use "0" to "9" and "A" to "F".
- Only one "Error check code" can be set in one packet.
- Packet elements after "Error check code" cannot be included in the calculation range.
- "Error check code" cannot be included in the calculation range.
- Set at least one element before "Error check code".
- If the calculated "Error check code" and the received "Error check code" do not match, a verification mismatch is judged to have occurred.

"Send/Receive Parameter Setting" window

The data area at reception and the timeout are set for each protocol.

The screenshot shows a dialog box titled "Send/Receive Parameter Setting". It has a "Timeout Setting" section with three input fields: "Timeout Time" (1000 ms), "Timeout Retry Count Setting" (3 Times), and "Monitoring Time At Error" (30 s). Below this is a "Clear Receive System Area" section with two radio buttons: "Yes" (selected) and "No". At the bottom are "OK" and "Cancel" buttons.

Item	Description	Setting range
Timeout Time	Set the time to wait for the response from the communication destination. Set "Timeout Time" that equals to or is longer than the execution interval. 0 (infinite wait) can be set only when "Comm Set" is set to "Request" and "Communication Type" is "Receive Only".	<ul style="list-style-type: none"> • 10 to 65535 (to be specified in increments of 1ms) • 0 (infinite wait) (Default: 1000)
Timeout Retry Count Setting	Set the number of retries to wait the communication time-out period when the communication destination does not respond.	0 to 255 (Default: 3)
Monitoring Time At Error	Set the time to monitor when a communication error occurs. Set "Monitoring Time At Error" that is longer than "Timeout Time". This item cannot be set when "Comm Set" is "Request".	1 to 300 (to be specified in increments of 1s) (Default: 30)
Clear Receive System Area	Select whether to clear the system area (receive data area) of the module before execution of the protocol. When "No" is selected, data received before the module executes the protocol is also included in the reception target for the protocol. This item cannot be set if "Communication Type" is "Receive Only".	<ul style="list-style-type: none"> • Yes • No (Default: Yes)

"Device Batch Setting" window

Select the protocol range and setting items to be set to configure the settings for desired devices by batch.

Item	Description	Setting range
Setting Protocol No. Range ^{*1}	Select the start number and end number of the protocols whose settings are configured by batch.	<ul style="list-style-type: none"> • 1 to 256 • 1 to 512 (Default: 1)
Start device No.	Set the start number of devices whose settings are configured by batch. Items for which the device is set will be set by batch, and items with blank will not be set by batch.	Refer to devices that can be specified on the following page. Page 255 Devices that can be specified (Default: Blank)

*1 The number will be 1 to 256 when "Resource Setting" is set for "Normal", and 1 to 512 for either "Extension 1" or "Extension 2".

"Device List" window

Displays devices that are being used for the simple device communications to check if any duplicate devices exist. When a blank is shown, click the [Create List] button.

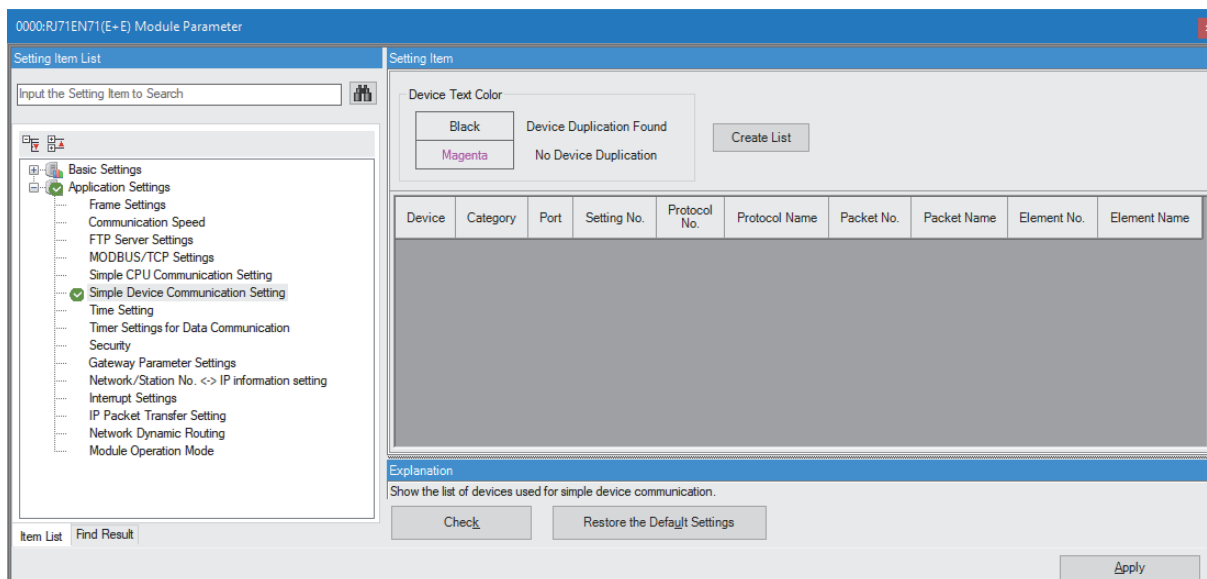

Item	Description
[Create List] button	Creates the list of set devices.
Device	Displays devices that are being used for the simple device communications.
Category	Displays the classification for which "Device" is set.
Port	Displays the Ethernet port for which "Device" is set.
Setting No.	Displays the setting number of the protocol for which "Device" is set.
Protocol No.	Displays the protocol number of the protocol for which "Device" is set.
Protocol Name	Displays the protocol name of the protocol for which "Device" is set.
Packet No.	Displays the packet number of the packet for which "Device" is set. This item is not displayed for devices whose "Category" is not set to "Variable". <ul style="list-style-type: none"> • Send: Indicates the send packets. • Receive(n): Indicates the receive packets. (n: Receive packet number (1 to 16))
Packet Name	Displays the packet name of the packet for which "Device" is set. This item is not displayed for devices whose "Category" is not set to "Variable".
Element No.	Displays the element number of the element for which "Device" is set. This item is not displayed for devices whose "Category" is not set to "Variable".
Element Name	Displays the element name of the element for which "Device" is set. This item is not displayed for devices whose "Category" is not set to "Variable".

Point

Enable the float display on the "Device List" window to edit the program while referring to the list of set devices.

Precautions

The device list is cleared if the following operations are performed.

- When "Resource Setting" is changed
- When any cell of "Communication Destination Setting" is edited
- When the [OK] button is clicked on the "Protocol Setting" window
- When any parameter of other ports is set and the [Apply] button is clicked (RJ71EN71(E+E) only)

Time Setting

Set the time setting function (SNTP client).

Item	Description	Setting range
Time Setting (SNTP Client)	Select whether to use the time setting function (SNTP client).	<ul style="list-style-type: none"> • Not Use • Use (Default: Not Use)
SNTP Server IP Address	Set the IP address of the SNTP server.	0.0.0.1 to 223.255.255.254 (Default: 0.0.0.1)
Timer Setting After Power-on and Reset	Select whether to execute the time setting function upon power-on or reset.	<ul style="list-style-type: none"> • Disable • Enable (Default: Disable)
Execution Timing	—	Select the execution timing of the time setting.
	Time Intervals	When "Fixed Scan Interval" is selected, set the time interval (minute) of time setting executions.
	Specified Time (Hour, Minute, Day of Week)	When "Fixed Time" is selected, set the day of the week and the clock time (hour and minute) when the time setting function is executed. ( Page 391 Specified Time (Hour, Minute, Day of Week))
		<ul style="list-style-type: none"> • Fixed Time • Fixed Scan Interval (Default: Fixed Time)
		1 to 1440 (Default: 1 Minute)
		—

Point 

The SNTP server must be only one in a network. The time to be output is the same even though multiple modules in the same system retrieve time from the same SNTP server.

Execution Timing

■ Specified Time (Hour, Minute, Day of Week)

Set an execution time value within the following range in "Clock Time (Hour, Minute)".

Item	Setting range
Hour	0 to 23 (Default: 12)
Minute	0 to 59 (Default: 0)

To specify the day of the week when time setting is executed, set "Not Set" in the day when time setting is not executed under "Day of Week". (Time setting is set to be executed every day (all the days are set to "Set") by default.)

When specifying the day of the week, set at least one day of the week to "Set". An error occurs when all the days are set to "Not Set".

Timer Settings for Data Communication

Set the timer used for the following communications.

- Connection with MELSOFT products and a GOT
- Communications using the SLMP
- Communications using the predefined protocol
- Socket communications/Communications using the fixed buffer
- Communication using the random access buffer
- File transfer function (FTP server)
- File Transfer Function (FTP Client)

When changing the timer settings for data communication, refer to the precautions before setting. (Page 393 Precautions for settings)

Item		Description	Setting range
Change/Set Timer Value		Select whether to change timer values from the default. The timer operates with its default value when "No" is selected.	<ul style="list-style-type: none"> • No • Yes (Default: No)
TCP Resend Timer		Set the waiting time to resend ACK if it is not returned when a connection is opened or data is sent in TCP/IP. This timer is also used as the minimum set time for arrival monitoring for data link instructions.	Unit [s]: 1 to 16383 Unit [ms]: 100 to 16383000* ¹ (Default: 10s)
Destination Alive Check Start Interval Timer		Set the time interval between the reception of the last message from the external device and the start of alive check.	Unit [s]: 1 to 16383 Unit [ms]: 100 to 16383000* ¹ (Default: 600s)
Destination Alive Check Interval Timer		Set the time interval for performing alive check again when no response is returned from the external device of alive check target.	Unit [s]: 1 to 16383 Unit [ms]: 100 to 16383000* ¹ (Default: 10s)
Destination Alive Check Resend Count		Set the number of times to perform alive check when no response is returned from the external device of alive check target.	1 to 99999 (Default: 3)
Advanced Settings	Response Monitoring Timer	Set the following time. <ul style="list-style-type: none"> • The time to wait for a response after sending command in communications with a fixed buffer (procedure exists) • The time interval between the first message and last message when receiving the divided messages. 	Unit [s]: 1 to 16383 Unit [ms]: 100 to 16383000* ¹ (Default: 30s)
	TCP ULP Timer	Set the time-to-live of the send packet in TCP/IP communications. For example, when the TCP resend timer value is set to 10 seconds and the TCP ULP timer value is set to 30 seconds, data will be resend every 10 seconds if no response is returned from the external device after data sending, and timeout error occurs if no response is returned within 30 seconds.	Unit [s]: 1 to 16383 Unit [ms]: 100 to 16383000* ¹ (Default: 30s)
	TCP End Timer	When closing the TCP/IP connection by the own station, set the monitoring time for waiting for a FIN from the external device after the own station sends a FIN and an ACK is returned from the external device. If a FIN is not received from the external device within the time specified by the TCP end timer value, an RST is sent to the external device and the connection is forcibly closed.	Unit [s]: 1 to 16383 Unit [ms]: 100 to 16383000* ¹ (Default: 20s)
	TCP Zero Window Timer	The window means the receive buffer on the receive side. If the receive buffer on the receive side has no free space (window size = 0), data sending is waited until the receive side has free receive buffer space. At this time, the sending side sends packets for checking the send window to the receive side according to the TCP zero window timer value to check the receiving status.	Unit [s]: 1 to 16383 Unit [ms]: 100 to 16383000* ¹ (Default: 10s)
	IP Assembly Timer	The communication data may be divided at the IP level before being sent due to the buffer limitation of the sending station or the receiving station. Set the waiting time for the divided data in such a case.	Unit [s]: 1 to 16383 Unit [ms]: 100 to 16383000* ¹ (Default: 5s)

*1 Set in increments of 100ms.

Precautions for settings

■Setting value for each timer of the Ethernet-equipped module side.

Set the timer values so that the following formula is met.

$$\left(\begin{array}{c} \text{Response} \\ \text{monitoring timer} \\ \text{value} \end{array} \right) \geq \left(\begin{array}{c} \text{TCP ULP} \\ \text{timer value} \end{array} \right) \geq \left(\begin{array}{c} \text{TCP end} \\ \text{timer value} \end{array} \right) \geq \left(\begin{array}{c} \text{TCP} \\ \text{resend} \\ \text{timer value} \end{array} \right) > \left(\begin{array}{c} \text{IP} \\ \text{assembly} \\ \text{timer value} \end{array} \right)$$

$$\left(\begin{array}{c} \text{TCP resend} \\ \text{timer value} \end{array} \right) = \left(\begin{array}{c} \text{TCP zero window} \\ \text{timer value} \end{array} \right)$$

When connecting Mitsubishi products to the line, configure the same settings for both modules.

■Setting value for each timer of the external device side.

Set the timer values so that the following formula is met. The frequency of a communication error, such as a transmission timeout, may be higher if the timer values do not meet the formula.

$$\left(\begin{array}{c} \text{TCP ULP timer} \\ \text{value on the external} \\ \text{device} \end{array} \right) > \left(\begin{array}{c} \text{TCP resend timer value} \\ \text{on the Ethernet-equipped} \\ \text{module} \end{array} \right)$$

$$\left(\begin{array}{c} \text{Monitoring timer value of the} \\ \text{application software on the external} \\ \text{device} \end{array} \right) > \left\{ \left(\begin{array}{c} \text{TCP ULP timer value on} \\ \text{the Ethernet-equipped} \\ \text{module} \end{array} \right) \times n^{*1} \right\}$$

*1 "n" is the number of TCP segment transmission and is calculated by the following formula.

$$n = \text{A value that } \left(\frac{\text{Message size sent by the Ethernet-equipped module}}{\text{Maximum Segment size}} \right) \text{ is rounded up to the nearest integer}$$

Ex.

The number of TCP segment transmission when communications are performed on the same line

The Maximum Segment Size is 1460 bytes on the same line (without a router) and the number of TCP segment transmissions is as follows.

- n = 1 when the size of the message sent by the Ethernet-equipped module is 1460 bytes or less
- n = 2 when the size of the message sent by the Ethernet-equipped module is greater than 1460 bytes

Ex.

The number of TCP segment transmission when communications are performed on a different line

The Maximum Segment Size is at least 536 bytes on another line (via a dial-up router or other communication device) and the number of TCP segment transmissions is as follows.

- n = 1 when the size of the message sent by the Ethernet-equipped module is 536 bytes or less
- n = 2 when the size of the message sent by the Ethernet-equipped module is greater than 536 bytes and no more than 1072 bytes
- n = 3 when the size of the message sent by the Ethernet-equipped module is greater than 1072 bytes and no more than 1608 bytes

■Number of retries

When a communication failure occurs due to a problem such as noise, change the value so that the number of retries may increase. The number of retries is obtained using the following formula. (When using the default values, $3 = 30 \div 10$)

Number of retries = TCP ULP timer value \div TCP resend timer value

Ex.

When the number of retries is three and data sending fails, a data sending error occurs at the timing shown in the figure below (in communications using the fixed buffer).

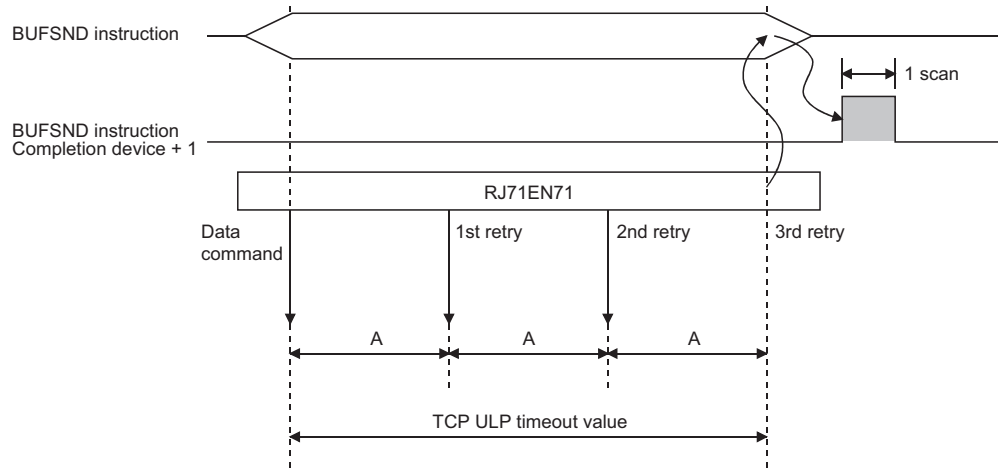

A: TCP resend timer value (The time at which data are sent when ACK is not returned after data transmission)

When not performing the above retry process (when setting 0 time), configure the setting so that the following formula is met.

TCP ULP timer value = TCP end timer value = TCP resend timer value

(Set the same value for the timer values.)

Security

Set the security measures for access to the Ethernet-equipped module.

Item		Description	Setting range
IP Filter Settings	IP Filter	Set whether to enable the IP filter.	<ul style="list-style-type: none"> • Not Use • Use (Default: Not Use)
	IP Filter Settings	Set the IP address to be allowed or denied. (☞ Page 395 IP Filter Settings)	—
Disable Direct Connection with MELSOFT		Set whether enable or disable direct connection to the engineering tool.	<ul style="list-style-type: none"> • Disable • Enable (Default: Enable)
Do Not Respond to CPU Module Search		Select whether to respond to the CPU module search.	<ul style="list-style-type: none"> • Do Not Respond • Respond (Default: Respond)

IP Filter Settings

Up to 32 IP addresses can be set as an IP address to be allowed or denied by the IP filter.

Range specification and specification of the IP addresses to be excluded from the set range are also possible.

Item		Description	Setting range
Access from IP address below		Select whether to allow or deny the access from the specified IP addresses.	<ul style="list-style-type: none"> • Allow • Deny (Default: Allow)
Range Setting		Select this item when specifying the IP addresses by range.	(Default: Clear)
IP Address		Set the IP address to be allowed or denied. When selecting "Range Setting", enter the start IP address (left field) and end IP address (right field) of the range.	0.0.0.1 to 223.255.255.254 (Default: Blank)
IP Address Excluded from Range		When selecting "Range Setting", set the IP address to be excluded from the set range. Up to 32 IP addresses can be set.	0.0.0.1 to 223.255.255.254 (Default: Blank)

Gateway Parameter Settings

With gateway parameter settings, the Ethernet-equipped module can communicate with external devices on other Ethernet networks via a router and gateway. One default router and up to eight routers can be set.

Item		Description	Setting range
Gateway Other Than Default Gateway		Set to communicate with an external device on the other Ethernet via a router.	<ul style="list-style-type: none"> • Use • Not Use (Default: Not Use)
Gateway Information	No.1 to No.8	Set the information of the gateway other than the default gateway. (☞ Page 396 Gateway Information)	—



Set the default gateway when communicating via the default gateway. (☞ Page 318 Own Node Settings)

Gateway Information

■ Gateway IP Address

When communicating with an external device on another Ethernet network through a gateway other than the default gateway, set the IP address of the gateway. (Setting range: 0.0.0.1 to 223.255.255.254)

Set a value that satisfies the following conditions.

- The IP address class is any of A, B, and C.
- The subnet address of the gateway is the same as that of the Ethernet-equipped module on the own station.
- The host address bits are not all "0" or all "1".

Point

- When the Ethernet-equipped module communicates with an external device on another Ethernet network by Passive open, communication is possible without gateway parameter settings.
- In a system where the Proxy router is used, the gateway parameter settings are not required.

■ Subnet Address

When communicating with an external device on another Ethernet network through a gateway other than the default gateway, set the network address ^{*1} or subnet address ^{*2} of the external device. (Setting range: 0.0.0.1 to 255.255.255.254)

Set a value that satisfies the following conditions.

- The IP address class is any of A, B, and C.
- The host address bits are all "0".

*1 Set the network address of the external device when its class (network address) is different from that of the Ethernet-equipped module on the own station.

*2 Set the network address of the external device when its class (network address) is the same as that of the Ethernet-equipped module on the own station.

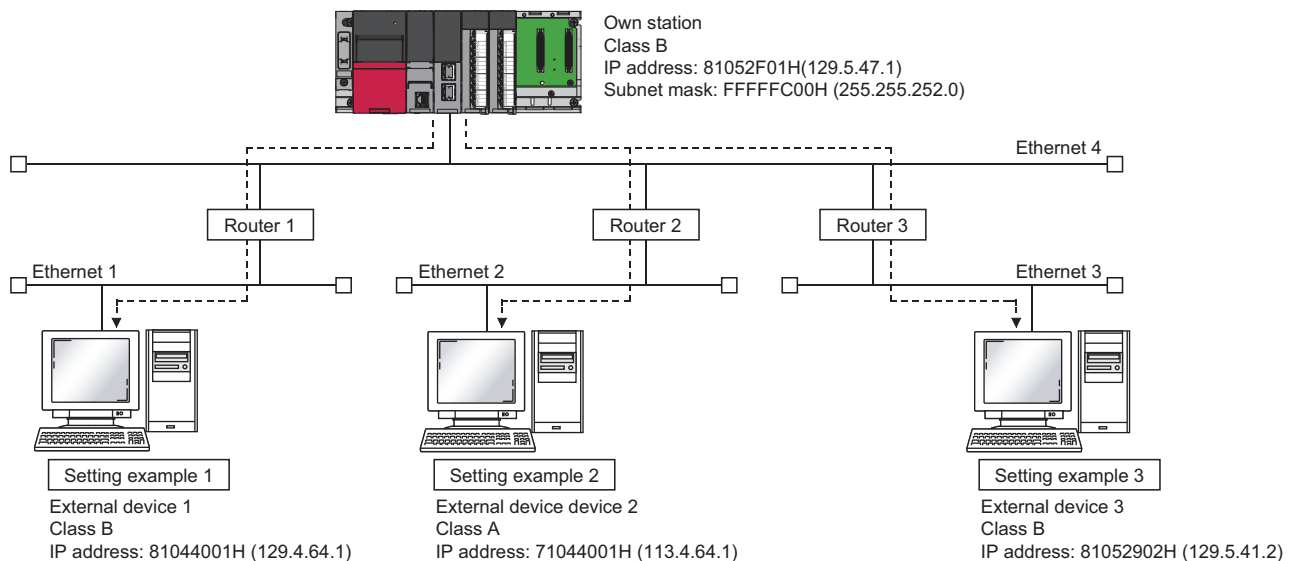

Ex.

When the network addresses differ between the Ethernet-equipped module on the own station and the external device

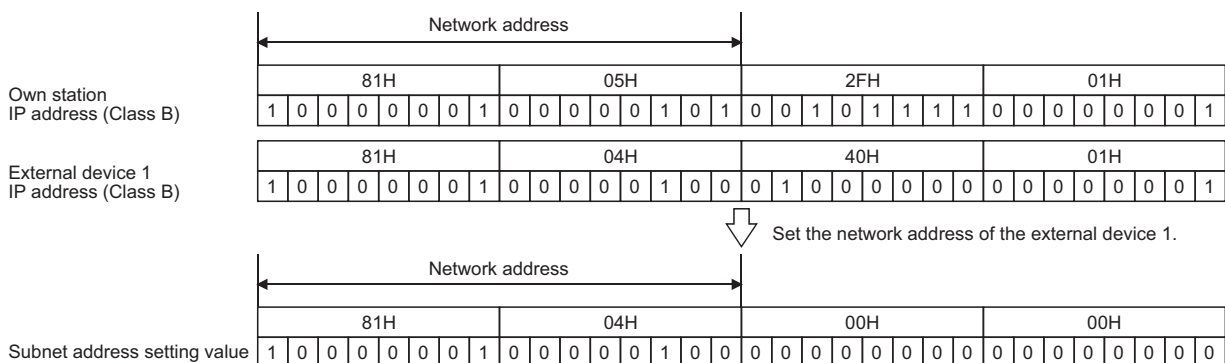

Ex.

When the classes differ between the Ethernet-equipped module on the own station and the external device

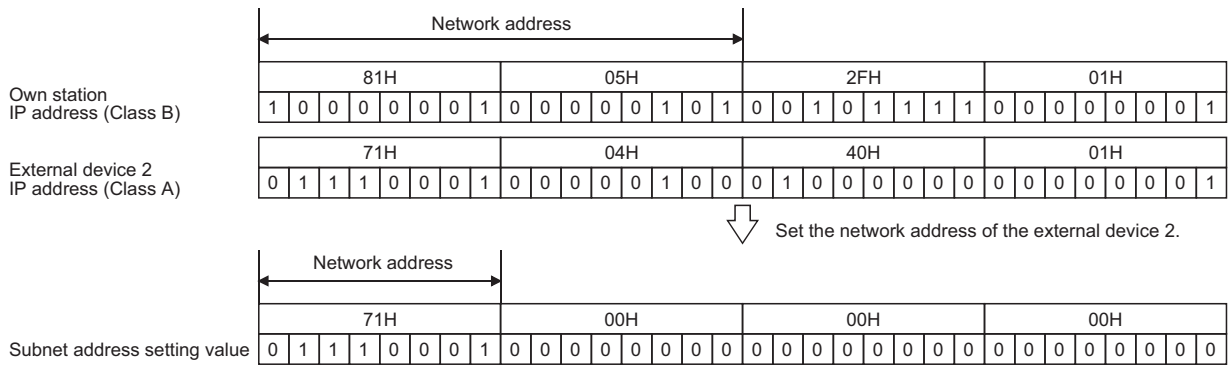

Ex.

When the network address of the Ethernet-equipped module on the own station is the same as that of the external device

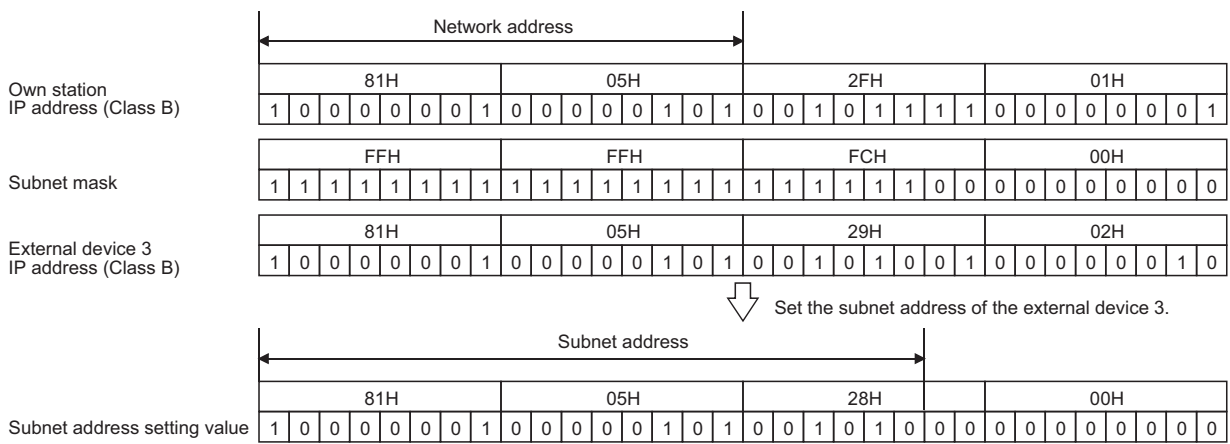



Network/Station No. <-> IP information setting



Set to communicate with another network module or CPU module by network number and station number.

Communication in Ethernet is performed according to the IP address and UDP port number, and access to another network is performed according to the network number and station number.

Therefore, when the Ethernet-equipped module accesses another network, the IP address and UDP port number must be converted into the network number and station number of the network.

Item	Description	Setting range
Setting System	Select the system to obtain the IP address and port number of the external device from its network number and station number. ( Page 398 Setting system)	<ul style="list-style-type: none"> Automatic Response System IP Address Calculation System Table Conversion System Combination System (Default: Automatic Response System)
Subnet Mask Pattern	Set the subnet mask pattern. ( Page 404 Subnet Mask Pattern)	<ul style="list-style-type: none"> Blank 0.0.0.1 to 255.255.255.255 (Default: Blank)
Conversion Settings	Set the information of the external device. ( Page 404 Conversion Settings)	—

Point

- When transferring messages which are sent to other stations specifying network number and station number, to another network, "Gateway Parameter Settings" in "Application Settings" is required. ( Page 395 Gateway Parameter Settings)
- "Network/Station No. <-> IP information setting" is required when other stations are accessed via other Ethernet network systems and must be registered in all the Ethernet-equipped module which has the network number and station number.
- The setting can be made in the CPU module (built-in Ethernet port part) if it has the firmware version supporting communications by network number/station number. ( Page 564 Added and Enhanced Functions)

Setting system

Select the system to obtain the IP address and port number of the external device from its network number and station number.

There are four methods as shown below. The items required to be set ("Subnet Mask Pattern" and "Conversion Settings") differ depending on the method.

○: Setting is required, ×: Setting is not required

Setting system	Subnet mask pattern	Conversion settings
Automatic Response System	×	×
IP Address Calculation System	○	×
Table Conversion System	×	○
Combination System	○	○

Point

- In MELSOFT connection using UDP/IP, if the external device is not registered in the conversion table of table conversion system, the Ethernet-equipped module communicates with the device using the automatic response system. Therefore, even when both of communications with different networks using the link dedicated instruction and MELSOFT connection are performed simultaneously, the Ethernet-equipped module can communicate with the external device in MELSOFT connection regardless of the registered data in the conversion table.
- If the IP address and port number cannot be retrieved when IP address calculation system, table conversion system, or combination system is set, the Ethernet-equipped module will retrieve them using the automatic response system and send a response to the external device.

■ Automatic Response System

This system differs from the other conversion method in that specification can only be made when the own station is the communication request destination station or communication relay receiving station.

Relay communications via other networks can be performed easily because the IP address and port number of the destination station are not required to be set.

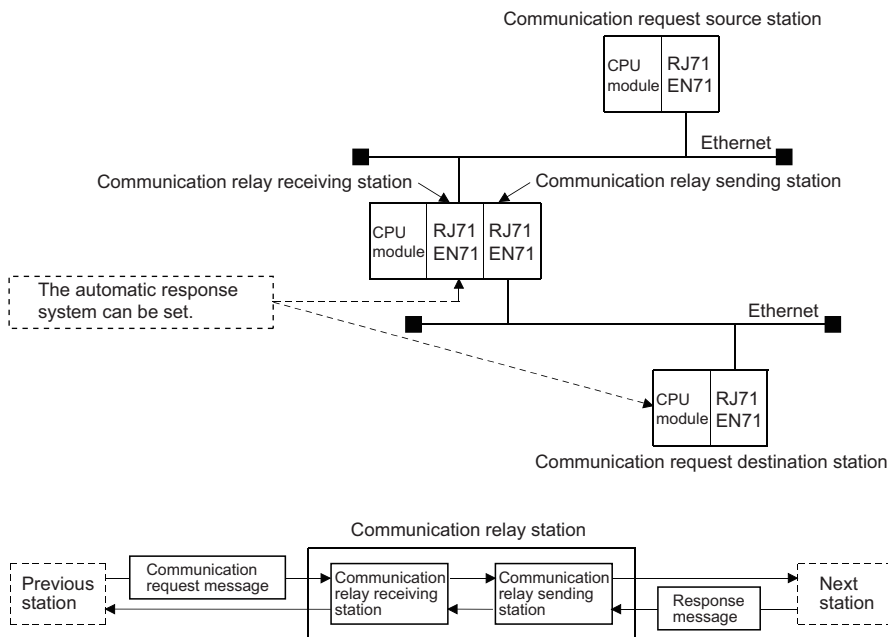

Conversion processing of the automatic response system is as below.

- When receiving the communication request message (command frame), the Ethernet-equipped module internally stores the send source network number, IP address, and UDP port number in the request message, as the station information. The response message (response) for the communication request message is returned to the destination IP address and UDP port number calculated from the stored network number and station number. Therefore, by receiving the other station access communication request message first, the communication destination stations can be maintained.
- The maximum number of station information that can be set is 120. When more than 120 other station access communication request messages are received, the Ethernet-equipped module starts deleting from the oldest data to store the station information in the newly received message communication request message. However, it is ignored if the station information is the same as the station information already stored. (Information from the same station is not stored twice.)

■ IP Address Calculation System

This system obtains the IP address of the destination station by calculating the network number and station number with the formula described below. The UDP port number predefined for the Ethernet-equipped module is used as the UDP port number of the destination.

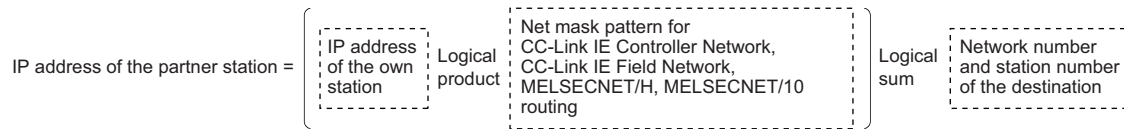

Conversion processing of the IP address calculation system is as below.

- When a communication request message (command frame) to access other station is received, the IP address is calculated from the network number and station number of the destination in the communication request message, which are stored in the Ethernet-equipped module, and the communication request message is sent to the next station (relay station or destination station).
- The response message (response) for the communication request message is returned based on the return IP address and the stored data above.

Ex.

IP address calculation example

The logical product and logical sum are calculated differently depending on the class of the own station IP address. An IP address is calculated as follows.

(For class A)

- When the own station IP address is 79238102H
- When the net mask pattern for routing other networks is FF000000H
- When the destination network number is 03H, and the station number is 05H

Own station IP Address		7 9 . 2 3 . 8 1 . 0 2
Net Mask Pattern	Logical product	F F . 0 0 . 0 0 . 0 0
Logical product value		7 9 . 0 0 . 0 0 . 0 0
Network No. and station No.	Logical sum	0 3 . 0 5
Partner station IP Address		7 9 . 0 0 . 0 3 . 0 5

(For class B)

- When the own station IP address is 8438FA0AH
- When the net mask pattern for routing other networks is FFFF0000H
- When the destination network number is 03H, and the station number is 05H

Own station IP Address		8 4 . 3 8 . F A . 0 A
Net Mask Pattern	Logical product	F F . F F . 0 0 . 0 0
Logical product value		8 4 . 3 8 . 0 0 . 0 0
Network No. and station No.	Logical sum	0 3 . 0 5
Partner station IP Address		8 4 . 3 8 . 0 3 . 0 5

(For class C)

- When the own station IP address is CA65300AH
- When the net mask pattern for routing other networks is FFFFFFF0H
- When the destination station number is 02H (The network number is not used.)

Own station IP Address		C A . 6 5 . 3 0 . 0 A
Net Mask Pattern	Logical product	F F . F F . F F . 0 0
Logical product value		C A . 6 5 . 3 0 . 0 0
Network No. and station No.	Logical sum	0 2
Partner station IP Address		C A . 6 5 . 3 0 . 0 2

Point

- IP address configuration of class A

	31	30	...	24	23	...	16	15	...	0	
Class	Network address						Host address				

- IP address configuration of class B

	31	30	29	...	16	15	...	0
Class	Network address				Host address			

- IP address configuration of class C

	31	...	29	28	...	8	7	...	0
Class	Network address						Host address		

■Table Conversion System

This system uses the network number, station number, IP address set in the conversion table of the Network/Station number <-> IP information. The UDP port number predefined for the Ethernet-equipped module is used as the UDP port number of the destination.

If duplicate network and station numbers are set in the conversion table, the data set with the younger registration number is used.

If no data is registered in the conversion table, communication may not be performed successfully.

Conversion processing of the table conversion system is as below.

- When a communication request message (command frame) to access other station is received, the same network number and station number are searched in the conversion table of the Network/Station No. <-> IP information, and the communication request message is sent to the destination station with the corresponding IP address.
- The response message (response) for the communication request message is returned based on the return IP address and the data in the conversion table above.

Ex.

Conversion table registration example

The following shows the example of conversion table registration based on the network map.

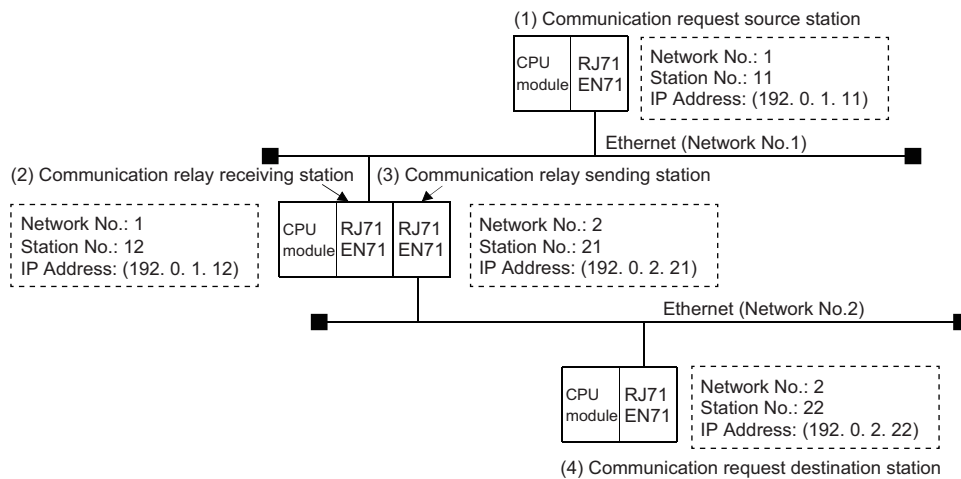

(a): For communication request message transmission, b): For response message transmission

Item		Setting details of each Ethernet-equipped module when accessing from (1) to (4)			
		(1) Communication request source station (a)	(2)	(3)	(4)
Setting value (decimal)	Network No., Station No.	1, 12	Setting not required	Setting not required	Setting not required
	IP Address	192.0.1.12			

Item		Setting details of each Ethernet-equipped module when accessing from (1) to (4)			
		(1) Communication request source station (a)	(2) Communication relay receiving station (b)	(3) Communication relay sending station (a)	(4) Communication request destination station (b)
Setting value (decimal)	Network No., Station No.	1, 12	1, 11	2, 22	2, 21
	IP Address	192.0.1.12	192.0.1.11	192.0.2.22	192.0.2.21

Item		Setting details of each Ethernet-equipped module when accessing from (2) to (1)			
		(1)	(2) Communication request destination station (a)	(3)	(4)
Setting value (decimal)	Network No., Station No.	Setting not required	1, 11	Setting not required	Setting not required
	IP Address		192.0.1.11		

Item		Setting details of each Ethernet-equipped module when accessing from (3) to (4)			
		(1)	(2)	(3) Communication relay sending station (a)	(4)
Setting value (decimal)	Network No., Station No.	Setting not required	Setting not required	2, 22	Setting not required
	IP Address			192.0.2.22	

Item		Setting details of each Ethernet-equipped module when accessing from (4) to (1)			
		(1) Communication request source station (b)	(2) Communication relay sending station (a)	(3) Communication relay receiving station (b)	(4) Communication request destination station (a)
Setting value (decimal)	Network No., Station No.	1, 12	1, 11	2, 22	2, 21
	IP Address	192.0.1.12	192.0.1.11	192.0.2.22	192.0.2.21

Item		Setting details of each Ethernet-equipped module when accessing from (4) to (3)			
		(1)	(2)	(3)	(4) Communication request destination station (a)
Setting value (decimal)	Network No., Station No.	Setting not required	Setting not required	Setting not required	2, 21
	IP Address				192.0.2.21

■Combination System

This system combines the IP address calculation system and the table conversion system.

Select this system when accessing other stations with the same network number, accessing other stations in other networks or Ethernet with different network number, or relaying from other networks to the Ethernet network system.

The set target Ethernet-equipped module can be installed either at a communication request source station, communication relay station, or communication request destination station.

Conversion processing of the combination system is as below.

- When a communication request message (command frame) to access other station is received, the communication request message is sent to the next station obtained by the table conversion system at first.
- If the IP address of the external device cannot be retrieved by the table conversion system, the IP address is retrieved by the IP address calculation system to send the communication request message.
- The response message (response) to the communication request message is returned based on the return IP address and data in the conversion table, or the stored data.

The relationship between the conversion method and the definition of the Ethernet-equipped module mounted station is as follows.

○: Can be set, ×: Cannot be set

Conversion method	Ethernet-equipped module mounted station definition			
	Communication request source station	Communication relay station		Communication request destination station
		Relay receiving station	Relay sending station	
Automatic Response System	×*1	○	×*1	○
IP Address Calculation System	○	○	○	○
Table Conversion System	○	○	○	○
Combination System	○	○	○	○

*1 For the external device that completed the communication, the station can be a communication request source station or a relay sending station.

Subnet Mask Pattern

Specify the mask value based on the guidelines given below. This pattern is used in a logical sum with the own station IP address when calculating the IP address of the external device using the IP address calculation system.

When setting the subnet mask, specify the target settings of the IP address class, network address, and subnet address so that all bits are "1" in the mask pattern.

Specify the mask pattern with a decimal/hexadecimal value obtained by dividing the 32-bit mask value into 8-bit segments. When the subnet mask is not specified, the mask pattern setting is not necessary. The following mask value is used as the mask pattern according to the own station IP Address class.

Class	Mask value used
Class A	FF.00.00.00H
Class B	FF.FF.00.00H
Class C	FF.FF.FF.00H

Conversion Settings

The conversion setting is required to obtain the IP address from the network number and station number using the table conversion system.

If the own station is an Ethernet-equipped module and the next station to which the communication request/response message is passed to access other station is also an Ethernet-equipped module, specify the network number, station number, and IP address of the Ethernet-equipped module of the next station.

Interrupt Settings

Set the parameters required for starting up an interrupt program.

Item	Description	Setting range
Interrupt Occurrence Factor	Set the interrupt cause.*2	<ul style="list-style-type: none"> SEND Instruction Data Reception*3 Reception Connection (Default: Blank)
Channel No./Connection No.	Set the start condition of an interrupt program. When "Interrupt Occurrence Factor" is set to "SEND Instruction Data Reception", set the number of the channel which receives send data. When "Interrupt Occurrence Factor" is set to "Reception Connection", set the number of the connection which receives send data.	<ul style="list-style-type: none"> SEND Instruction Data Reception: 1 to 8 Reception Connection: 1 to 64*1 (Default: Blank)
Detection Method	The detection method for the interrupt condition is displayed when "Interrupt Occurrence Factor" is set.	Edge (Default: Blank)
Interrupt Pointer	Set an interrupt pointer (device (I)) to be used for a program.	Device: I0 to I15, I50 to I1023 (Default: Blank)
Comment	Set a comment for the interrupt pointer used, if required.	256 one-byte characters maximum (Default: Blank)

*1 When "Q Compatible Ethernet" is selected in the network type, the setting range is 1 to 16.

*2 An interrupt program is started when the receive data is stored in the channel or connection specified in "Channel No./Connection No.".

*3 When selecting "SEND Instruction Data Reception", set "Communications by Network No./Station No." under "Own Node Settings" of "Basic Settings" to "Enable", and set the network number and station number.

Point

Maximum number of interrupt settings can be set to one module (sum of the settings for the P1 connector and the P2 connector) is 16.

Setting number of the interrupt settings is shared in P1 connector and P2 connector.

For example, when SI00 is set on the P1 connector side, SI00 on the P2 connector side cannot be set.



IP Packet Transfer Setting

Set when using the IP packet transfer function.

The IP packet transfer function enables the Ethernet device (such as computers) connected to the Ethernet-equipped module to communicate with the device on other networks that has an IP address via CC-Link IE Field Network or CC-Link IE Controller Network.

To use this function, set "IP Packet Transfer Function" to "Use". (Default: Not Use)

For details on the IP packet transfer function, refer to the following.

-  MELSEC iQ-R CC-Link IE Controller Network User's Manual (Application)
-  MELSEC iQ-R CC-Link IE Field Network User's Manual (Application)

Point

If the application timeout of the request source device occurs due to a heavy communication load on the path that an IP packet takes, measure the response time using the PING command from the request source device and adjust the application timeout time. Data size must be within 1460 bytes when the PING command is used.

Network Dynamic Routing

Set when using the dynamic routing.

Setting "Network Dynamic Routing" is possible only when values are set in "Network No." and "Station No." under "Own Node Settings" of "Basic Settings". (📖 Page 319 Details of items)

For details, refer to the following.

📖 Page 532 Communications with Different Networks

Point

- When the communication path is set in "Routing Setting" of "CPU Parameter", setting of "Routing Setting" has a priority.
- When enabling dynamic routing, do not connect the CPU module (built-in Ethernet port part) and the Ethernet-equipped module on the same Ethernet using a hub or other means.

Module Operation Mode

Set the module operation mode.

Set the same operation mode for both of the P1 connector and P2 connector.

For a redundant system, select the module operation mode of system A.

For details on module communication test mode, refer to the following.

📖 Page 415 Module communication test

Item	Description	Setting range
Module Operation Mode	<p>Online</p> <ul style="list-style-type: none"> • Normal operation mode <p>Offline</p> <ul style="list-style-type: none"> • Communication with other stations and dedicated instruction cannot be performed in this mode. Select this mode to debug the program while the network is not yet connected. <p>Module Communication Test</p> <ul style="list-style-type: none"> • A mode for operating the module communication test. Select this mode to check the operation when the module is in abnormal condition. 	<ul style="list-style-type: none"> • Online • Offline • Module Communication Test (Default: Online)



When different operation modes are set for the P1 connector and P2 connector, the Ethernet-equipped module operates with the following operation modes.

Module Operation Mode		Operation mode of Ethernet-equipped module
P1 connector	P2 connector	
Online	Offline	Offline
	Module Communication Test	Module Communication Test
Offline	Online	Offline
	Module Communication Test	Module Communication Test
Module Communication Test	Online	Module Communication Test
	Offline	

Redundant System Settings

Set when using an Ethernet-equipped module in a redundant system.

Item	Description	Setting range
To Use or Not to Use Redundant System Settings	Select whether to use the redundant function or not. Set the same setting for port 1 and port 2. Select "Use" when installing the RJ71EN71 to the main base unit. Select "Not Use" when installing the RJ71EN71 to the extension base unit.	<ul style="list-style-type: none"> • Use • Not Use (Default: Use)
Own Node (System A) IP Address	The IP address set in "Own Node Settings" under "Basic Settings" is displayed. Not displayed when it has not been set.	—
System B IP Address	Set the IP address of system B. Ensure that this address has the same class and subnet address as "Own Node (System A) IP Address". When the parameters are written without the IP address set (blank), the following IP address is set. <ul style="list-style-type: none"> • P1 connector of RJ71EN71: 192.168.3.42 • P2 connector of RJ71EN71: 192.168.4.42 • CPU module (built-in Ethernet port part): 192.168.3.41 	<ul style="list-style-type: none"> • Blank • 0.0.0.1 to 223.255.255.254 (Default: Blank)
Own Node (System A) Station Number	The station number set in "Own Node Settings" under "Basic Settings" is displayed. Not displayed when it has not been set.	—
System B Station Number ^{*1}	Set the system B station number. Set when the station number is set in "Own Node Settings" under "Basic Settings".	1 to 120 (Default: 2)
Use of Control System IP Address ^{*2}	Set whether to use the control system IP address or not. <ul style="list-style-type: none"> • When "Use" is selected, set the control system IP address. When the control system IP address is used, access using the control IP address is possible even if system switching occurs. • When "Not Use" is selected, access is made using the own node (system A) or system B IP address. When the RJ71EN71 is used, pay attention to the following. <ul style="list-style-type: none"> • When using port group settings, the setting for "Use of Control System IP Address" should be the same for port 1 and port 2. 	<ul style="list-style-type: none"> • Not Use • Use (Default: Not Use)
Control System IP Address ^{*2}	Set the control system IP address. Set the address after setting "Use" to "Use of Control System IP Address". Set so that the IP address has the same class and subnet address as the IP addresses used in the system. Consult with the network manager for the IP address setting. Set the IP address not to overlap the one used in the system. Set the IP address class within the range of classes A, B and C. Set the same control system IP address for system A P1 and system B P1, or for system A P2 and system B P2.	<ul style="list-style-type: none"> • Blank • 0.0.0.1 to 223.255.255.254 (Default: Blank)
Own Node (System A) Module Operation Mode	The module operation mode set for "Module Operation Mode" under "Application Settings" is displayed.	—
System B Module Operation Mode ^{*1}	Set the module operation mode of system B. For details on the module operation mode, refer to the following.  Page 406 Module Operation Mode	<ul style="list-style-type: none"> • Online • Offline • Module Communication Test (Default: Online)
Port Group Setting ^{*1*2}	Set the port group. Set the same value for port 1 and port 2. If "No Setting" is selected, when a system switching error occurs on either port, performs system switching. This setting is not available when "Q Compatible Ethernet" is set for the RJ71EN71 network type.	<ul style="list-style-type: none"> • No Setting • Switch Systems When a System Switching Error Occurs in Port 1 • Switch Systems When a System Switching Error Occurs in Port 2 • Switch Systems When a System Switching Error Occurs in Both of Port 1 and Port 2 (Default: No Setting)
System Switching Request Issuing at Disconnection Detection ^{*1}	Set whether to issue a system switching request when a cable disconnection is detected.	<ul style="list-style-type: none"> • Enable • Disable (Default: Enable)
Disconnection Detection Monitoring Time ^{*1}	Set the time between cable disconnection detection after communication starts normally and issuance of a system switching request to the control system CPU module.	Unit [s]: 0.0 to 30.0 Unit [ms]: 0 to 30000 (in increments of 100ms) (Default: 2s)

Item	Description	Setting range
System Switching Request Issue at Communication Error* ¹	Set whether to issue a system switching request when a communication error occurs.	<ul style="list-style-type: none"> • Enable • Disable (Default: Disable)
User Connection* ¹	Set the connection for issuance of a system switching request when a communication error occurs, from the connections set in "External Device Configuration" under "Basic Settings". By setting the comment for the connection device in "External Device Configuration" under "Basic Settings", the connection can be easily identified. ( Page 320 External Device Configuration)	<ul style="list-style-type: none"> • Not to Issue • Issue (Default: Not to Issue)
System Connection* ¹	Set whether to issue a system switching request when a communication error occurs for each port. Set this item after setting "Enable" to "System Switching Request Issue at Communication Error". ( Page 408 System connection)	

*¹ This setting is not available for the CPU module (built-in Ethernet port part).

*² This setting is not available when the RJ71EN71 network type is set to "Q Compatible Ethernet".

System connection

Set "Enable" to "System Switching Request Issue at Communication Error" before setting the following items.

Item	Description	Setting range
Auto-open UDP Port	Set whether to issue a system switching request using the auto open UDP port when a communication error occurs. This port is used for SLMP communications. This setting is enabled when the following conditions are met. <ul style="list-style-type: none"> • The remote password setting is enabled. • The remote password is unlocked. When the above conditions are not met, even if a communication error occurs in the target connection, a system switching request will not be issued.	<ul style="list-style-type: none"> • No System Switching Request at Communication Error • System Switching Request at Communication Error (Default: No System Switching Request at Communication Error)
MELSOFT Transmission Port (UDP/IP)	Set whether to issue a system switching request using the MELSOFT transmission port (UDP/IP) when a communication error occurs. This port is used for UDP/IP communications with MELSOFT products. This setting is enabled when the following conditions are met. <ul style="list-style-type: none"> • The remote password setting is enabled. • The remote password is unlocked. When the above conditions are not met, even if a communication error occurs in the target connection, a system switching request will not be issued. When "System Switching Request at Communication Error" is selected, a system switching request is issued when a communication error occurs in the following ports. <ul style="list-style-type: none"> • Port used for communications using a dedicated instruction • Relay transmission port with other networks • MELSOFT direct connection port • Direct connection port with the engineering tool When "No System Switching Request at Communication Error" is selected, even if a communication error occurs in any of the above ports, a system switching request will not be issued.	<ul style="list-style-type: none"> • No System Switching Request at Communication Error • System Switching Request at Communication Error (Default: No System Switching Request at Communication Error)
MELSOFT Transmission Port (TCP/IP)	Set whether to issue a system switching request using the MELSOFT transmission port (TCP/IP) when a communication error occurs. This port is used for TCP/IP communications with MELSOFT products.	<ul style="list-style-type: none"> • No System Switching Request at Communication Error • System Switching Request at Communication Error (Default: No System Switching Request at Communication Error)
FTP Transmission Port (TCP/IP)	Set whether to issue a system switching request using the FTP transmission port (TCP/IP) when a communication error occurs. This port is used for the file transfer function (FTP server).	<ul style="list-style-type: none"> • No System Switching Request at Communication Error • System Switching Request at Communication Error (Default: No System Switching Request at Communication Error)
Simple CPU communication port	Set whether to issue a system switching request using the simple CPU communication port when a communication error occurs. This port is used for the simple CPU communication function.	<ul style="list-style-type: none"> • No System Switching Request at Communication Error • System Switching Request at Communication Error (Default: No System Switching Request at Communication Error)

Precautions on simple CPU communication

Before using the simple CPU communication in a redundant system, check the following.

■Redundant system settings

To execute system switching when a communication error (alive check error and ULP timeout) is detected, set the following items in "Redundant System Settings" under "Application Settings". (☞ Page 296 Communication error detection)

- "System Switching Request Issue at Communication Error": Enable
- "Simple CPU Communication Port under System connection": System Switching Request at Communication Error (☞ Page 408 System connection)

System switching is executed only when a communication error occurs. When the following errors occur, system switching is not executed.

- CFB4H: An abnormal response was received from the external device.
- CFB5H: The frame received from the external device is incorrect.

When the simple CPU communication have never been executed, system switching is not executed even if a communication error occurs.

■Operation during system switching

Depending on "Communication Setting: Execution Interval (ms)" in "Simple CPU Communication Setting" under "Application Settings", system switching operates in the following manner.

Communication setting	Operation
Fixed interval	Communications stop temporarily during system switching and restart automatically from the new control system.
On Request	In the same manner as in the normal operation start, when Request to start communication at request (Un\G721896 to Un\G721899, Un\G1247300 to Un\G1247327) of each setting numbers is turned on under the following status after system switching is completed, communications restart. <ul style="list-style-type: none"> • Preparation completion (Un\G721912 to Un\G721915, Un\G1247412 to Un\G1247439) for each setting number is turned on: Ready • Simple CPU communication status (Un\G721936 to Un\G721999, Un\G1247460 to Un\G1247907) for each setting number is 2: Waiting for request

iQ Sensor Solution Settings

Set the setting related to iQ Sensor Solution.

Item	Description	Setting range
Use iQ Sensor Solution	Select whether to use iQ Sensor Solution compatible functions.	<ul style="list-style-type: none">• Use• Not to Use (Default: Use)

SLMPSND Instruction Settings

Set the setting related to the SLMPSND instruction.

Item	Description	Setting range
Use SLMPSND Instruction	Select whether to use the SLMPSND instruction.	<ul style="list-style-type: none">• Use• Not to Use (Default: Use)

3 TROUBLESHOOTING

This chapter describes troubleshooting of when the Ethernet function is used.

3.1 Checking with LED

This section describes troubleshooting using LED.

Error status can be determined by status of the RUN LED and the ERR LED.

RUN LED	ERR LED	Error status*1	Description
Off	On, flashing	Major error	An error such as hardware failure or memory failure. The module stops operating.
On	Flashing	Moderate error	An error, such as parameter error, which affect module operation. The module stops operating.
On	On	Minor error	An error such as communication failure. The module continues operating.

*1 When multiple errors occur, the error status is displayed in the order of major, moderate, and minor.

Point

For the RJ71EN71 or RnENCPU, whether the error occurs in the P1 or P2 can be checked with P ERR LED.

When the RUN LED or READY LED turns off

When the READY LED of the CPU module turns off after power-on, refer to the troubleshooting of the CPU module. (📖 MELSEC iQ-R CPU Module User's Manual (Application))

When the RUN LED of the RJ71EN71 or RnENCPU turns off, check the following.

Check item	Action
Is the Ethernet-equipped module mounted correctly?	Securely mount the Ethernet-equipped module on the base unit.

If the above action does not solve the problem, perform the module communication test to check for hardware failure. (👉 Page 415 Module communication test)

When the ERROR LED or ERR LED turns on or is flashing

When the ERROR LED of the CPU module turns on or is flashing, perform the module diagnostics of the CPU module.

🔍 [Diagnostics] ⇒ [Module Diagnostics (CPU Diagnostics)]

When the ERR LED of the RJ71EN71 or RnENCPU turns on or is flashing, identify the error cause using the engineering tool. (👉 Page 413 Checking the Module Status)

If the above action does not solve the problem, perform the module communication test to check for hardware failure. (👉 Page 415 Module communication test)

When the SD/RD LED does not turn on at data sending

When the SD/RD LED does not turn on at data sending, check the following items.

Check item	Action
Is the ERROR LED or ERR LED on or flashing?	Identify the error cause using the engineering tool. (🔍 Page 413 Checking the Module Status, 🔍 Page 417 Checking the Network Status).
Are the cables properly connected?	Correct the cable properly. Perform the following tests to check for the status of the cable connection and line. <ul style="list-style-type: none"> • PING test (🔍 Page 422 PING Test) • Communication status test (🔍 Page 423 Communication Status Test)
Is the program correct?	Check and correct the send program of the Ethernet-equipped module.

If the above action does not solve the problem, perform the module communication test to check for hardware failure. (🔍 Page 415 Module communication test)^{*1}

*1 The module communication test cannot be performed for the CPU module (built-in Ethernet port part). Perform the troubleshooting of the CPU module and check for hardware failure. (📖 MELSEC iQ-R CPU Module User's Manual (Startup))

When data cannot be received with the SD/RD LED off

When data cannot be received with the SD/RD LED off, check the following.

Check item	Action
Is the ERROR LED or ERR LED on or flashing?	Identify the error cause using the engineering tool. (🔍 Page 413 Checking the Module Status, 🔍 Page 417 Checking the Network Status).
Are the cables properly connected?	Correct the cable properly. Perform the following tests to check for the status of the cable connection and line. <ul style="list-style-type: none"> • PING test (🔍 Page 422 PING Test) • Communication status test (🔍 Page 423 Communication Status Test)
Are the parameter settings correct?	Check the module parameters of the Ethernet-equipped module. Correct the value for the following setting if it is wrongly set. <ul style="list-style-type: none"> • "IP Address" under "Own Node Settings" of "Basic Settings" • "Gateway Parameter Settings" of "Application Settings" 🔍 Page 317 PARAMETER SETTINGS
Is the program correct?	Check and correct the send program of the external device.

If the above action does not solve the problem, perform the module communication test to check for hardware failure. (🔍 Page 415 Module communication test)^{*1}

*1 The module communication test cannot be performed for the CPU module (built-in Ethernet port part). Perform the troubleshooting of the CPU module and check for hardware failure. (📖 MELSEC iQ-R CPU Module User's Manual (Startup))

When the L ER LED turns on

When the L ER LED turns on, check the following.

Check item	Action
Are the Ethernet cables used normally?	<ul style="list-style-type: none"> • Check if the Ethernet cable which conforms the standard is used. (📖 MELSEC iQ-R Ethernet/CC-Link IE User's Manual (Startup)) • Check if the station-to-station distance is set within range. (📖 MELSEC iQ-R Ethernet/CC-Link IE User's Manual (Startup)) • Check if the Ethernet cables are not disconnected.
Does the cabling condition (bending radius) meet the specifications?	Refer to the manual for the Ethernet cable, and correct the bending radius.
Is the hub used operating normally?	<ul style="list-style-type: none"> • Check if the hub which conforms the standard is used. (📖 MELSEC iQ-R Ethernet/CC-Link IE User's Manual (Startup)) • Power off and on the hub.
Is there any source of noise near the module or cables?	Change the location of the module or cables.

If the above action does not solve the problem, perform the module communication test to check for hardware failure. (🔍 Page 415 Module communication test)

3.2 Checking the Module Status

The following table lists the functions which can be used in the "Module Diagnostics" window of the Ethernet-equipped module.

Functions		Applications
Error Information		Displays the details of the errors currently occurring and the actions to remove them. "." may be displayed for "Occurrence Date" of an error that occurred immediately after power-on. To check the occurrence date, click the [Event History] button to refer to the event history.
Module information list		Displays various status information of the Ethernet-equipped module
Supplementary Function	Ethernet Diagnostics	Enables checking the cause to resolve the problem when an error occurs in the Ethernet system. (☞ Page 417 Checking the Network Status)

3

Error Information

Check the details of the error currently occurring and action to remove the error.

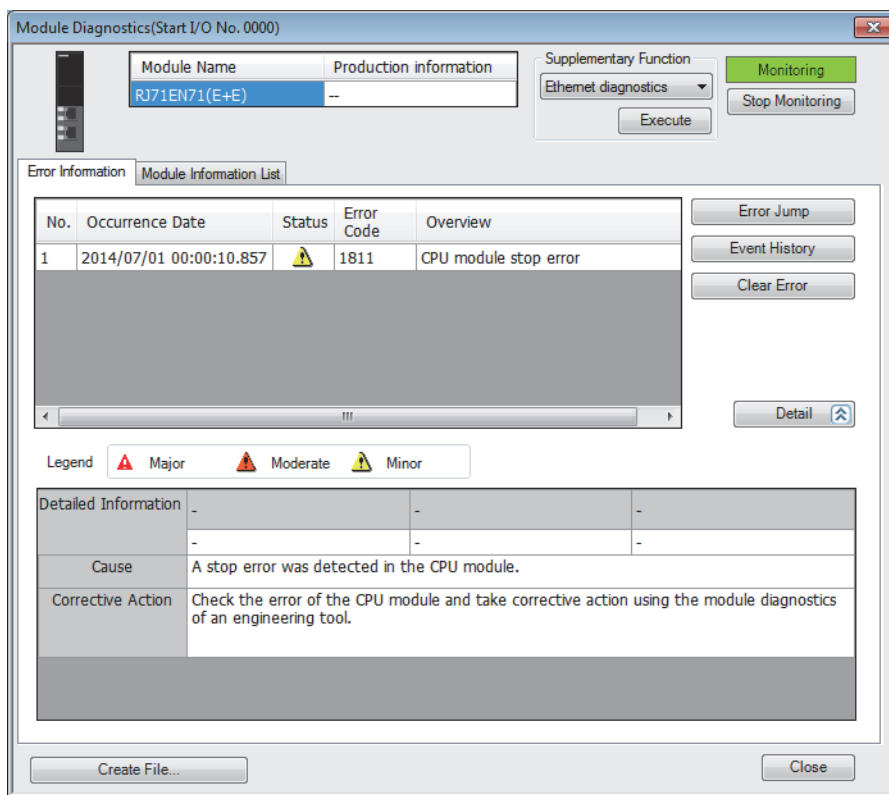

Item	Description
Status	Major: An error such as hardware failure or memory failure. The module stops operating.
	Moderate: An error, such as parameter error, which affect module operation. The module stops operating.
	Minor: An error such as communication failure. The module continues operating.
Detailed Information	Displays detailed information about each error (maximum of 3 pieces).
Cause	Displays the detailed error causes.
Corrective Action	Displays the actions to eliminate the error causes.

Module Information List

Switch to the [Module Information List] tab to check various status information of the Ethernet-equipped module. (The displayed items vary depending on the module.)

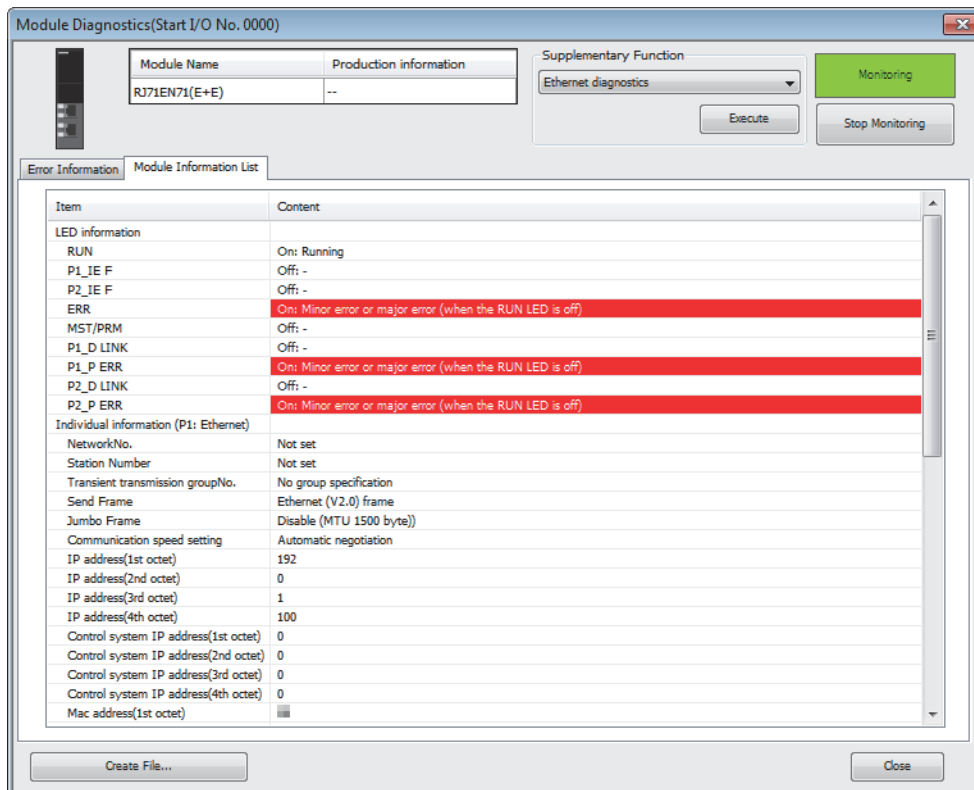

Item	Description
LED information	Displays the LED status of the Ethernet-equipped module.
Individual information (P1: Ethernet)*1	
Network Number	Displays the network number set for the selected module.
Station Number	Displays the station number set for the selected module.
Transient transmission group No.	Displays the transient transmission group number set for the selected module.
Send Frame	Displays the send frame setting set for the selected module.
Jumbo Frame	Displays the jumbo frame setting set for the selected module.
Communication speed setting	Displays the communication mode set for the selected module.
IP address (1st octet) to IP address (4th octet)	Displays the IP address set for the selected module.
Control system IP address (1st octet) to Control system IP address (4th octet)	Displays the control system IP address set for the selected module.
MAC address (1st octet) to MAC address (6th octet)	Displays the MAC address of the selected module.
Individual information (P2: Ethernet)*1	(Same as the P1 connector)

- *1 This item is displayed when the network type is set to "Ethernet".
 For when the network type is set to "CC-Link IE Control", refer to the following.
 📖 MELSEC iQ-R CC-Link IE Controller Network User's Manual (Application)
 For when the network type is set to "CC-Link IE Field", refer to the following.
 📖 MELSEC iQ-R CC-Link IE Field Network User's Manual (Application)

Module communication test

The module communication test checks the hardware of the RJ71EN71 or the RnENCPU (network part). When the communication using the RJ71EN71 or the RnENCPU (network part) is unstable, whether a hardware failure occurs or not can be checked.

The following table lists the tests performed.

Test item	Description
Internal self-loopback test	Checks whether the communication function of the module can be performed normally.
External self-loopback test	Checks whether the communication can be performed normally with the cable connected between two connectors.

3

Procedure

■Systems other than the redundant system

1. Set the module operation mode for P1 and P2 each to module communication test mode in the following item.

 [Navigation window] ⇒ [Parameter] ⇒ [Module Information] ⇒ [RJ71EN71] ⇒ [Module Parameter] ⇒ [Application Settings] ⇒ [Module Operation Mode]

2. Connect the P1 and P2 of the RJ71EN71 or the RnENCPU (network part) with an Ethernet cable.

3. Write the module parameters to the CPU module.

4. Reset or power off and on the CPU module to start the module communication test.

Point

Do not perform a module communication test while connected to another station. The operation of another station may failed.

■Redundant system

To perform a module communication test for a redundant system, set the operation mode to separate mode. ( MELSEC iQ-R CPU Module User's Manual (Application))

Before execution, perform system switching in advance so that the module communication test target station operates as the standby system.

The following describes a procedure for executing a module communication test for the RJ71EN71 of system B (standby system).

1. Set the module operation mode of system A to online mode in the following item.

 [Navigation window] ⇒ [Parameter] ⇒ [Module Information] ⇒ [RJ71EN71] ⇒ [Module Parameter] ⇒ [Application Settings] ⇒ [Module Operation Mode]

2. Set the module operation mode of system B to module communication test mode in the following item.

 [Navigation window] ⇒ [Parameter] ⇒ [Module Information] ⇒ [RJ71EN71] ⇒ [Module Parameter] ⇒ [Application Settings] ⇒ [Redundant System Settings] ⇒ [System B Module Operation Mode]

3. Connect the P1 and P2 of the RJ71EN71 of system B with an Ethernet cable.

4. Set the system B CPU module to the STOP state.

5. Write the module parameters to the system B CPU module.

6. Reset or power off and on the system B CPU module to start a module communication test.

- To perform a module communication test on system A, set the module operation mode of system A to module communication test mode and the module operation mode of system B to online mode.
- When returning the module to a normal operation state after the test, reconnect the Ethernet cable as before the test, and then execute the CPU module memory copy to transfer the parameters of the control system to the standby system. ( MELSEC iQ-R CPU Module User's Manual (Application))
- Do not perform a module communication test while connected to another station. The operation of another station may failed.

Check of status and result

The test status and result can be checked with the dot matrix LED of the module.

Test status	LED display
Test in progress	The dot matrix LED displays "UCT".
Normal completion	The dot matrix LED displays "OK".
Abnormal end	The ERR LED turns on and the dot matrix LED indicates "ERR" and error number alternately at intervals of 1 second.

■Error number when the test abnormally ended.

The dot matrix LED indicates the error number with the form of "Target Ethernet port Error number".

For example, "1 3" is displayed when error No.3 occurs in P1.

If the module communication test fails, take the following actions.

Error number	Description	Action
1	Internal self-loopback test failure	Please consult your local Mitsubishi representative.
2	External self-loopback test connection error	Check the Ethernet cable connection or replace the Ethernet cable, and perform the test again. If the test fails again, Please consult your local Mitsubishi representative.
3	External self-loopback test communication error	Replace the Ethernet cable and perform the test again. If the test fails again, Please consult your local Mitsubishi representative.

3.3 Checking the Network Status

Ethernet diagnostics

The communication status of the Ethernet-equipped module and external device can be checked with Ethernet diagnostics.

[Diagnostics] ⇒ [Ethernet Diagnostics]

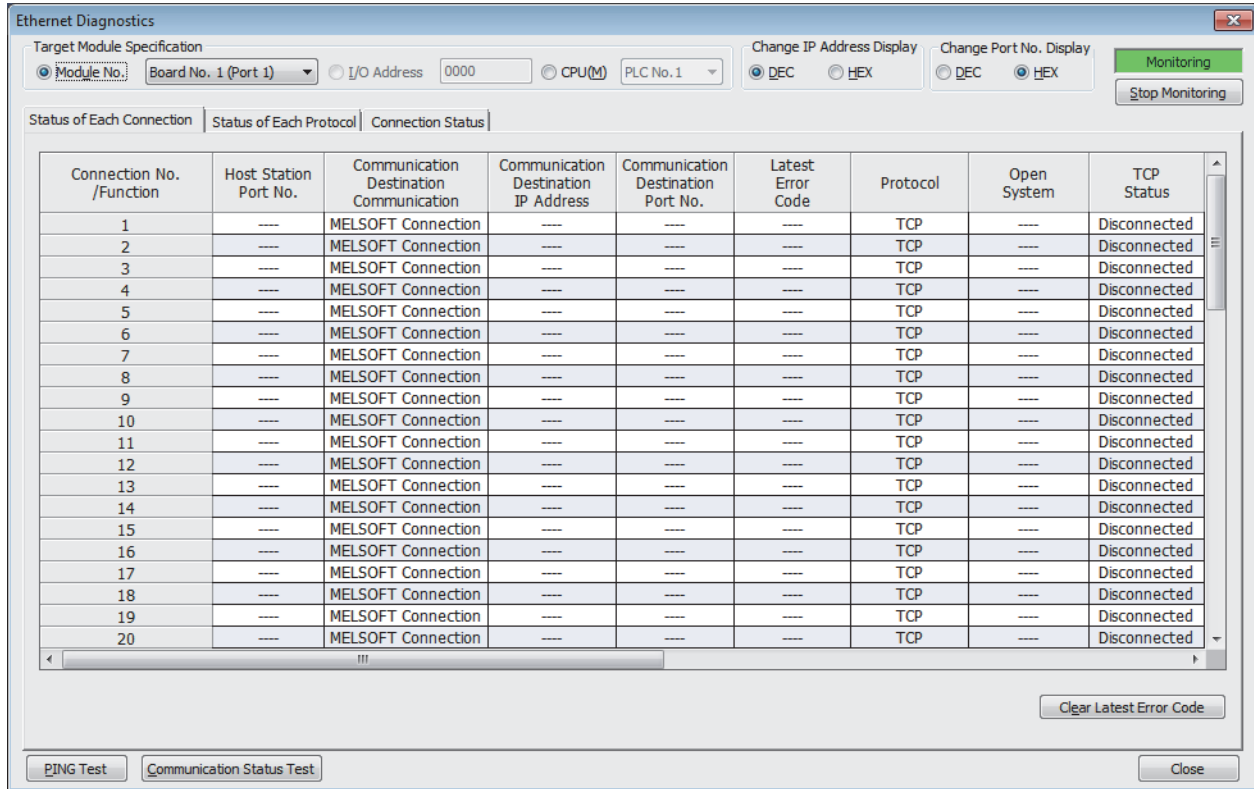

Set the Ethernet-equipped module to be diagnosed in "Target Module Specification".

-
- The Ethernet diagnostics cannot be started when "Other Station (Co-existence Network)" has been specified in "Other Station Setting" on the "Specify Connection Destination Connection" window and "CC-Link" or "C24" has been specified in "Co-existence Network Route".
 - When starting the Ethernet diagnostics with a setting other than "No Specification" in "Other Station Setting" on the "Specify Connection Destination Connection" window, use the engineering tool of the version 1.035M or later.
 - When a setting other than "No Specification" has been specified in "Other Station Setting" of "Specify Connection Destination Connection", specify an Ethernet-equipped module to be diagnosed in "Other Station Setting" of "Specify Connection Destination Connection". If another Ethernet-equipped module is specified, the Ethernet diagnostics can be started only for the specified Ethernet-equipped module, but not for the non-specified Ethernet-equipped module even if it is on the same base unit. The Ethernet diagnostics can be started for stations of up to eight networks ahead (number of relay stations: 7) including the network to which the station directly connected with the engineering tool belongs.
 - In a redundant system, the Ethernet diagnostics cannot be started when system A or system B has been specified under "Specify Redundant CPU" of "Target system" in the "Specify Connection Destination Connection" window. Directly connect a station to be diagnosed to the engineering tool and specify the host CPU module ("Specify Redundant CPU" is set to "Not Specified") to start the Ethernet diagnostics.
 - In a redundant system configuration of the remote head module, the Ethernet diagnostics cannot be started when the engineering tool is connected to the remote head module of the standby system. Connect it to the remote head module of the control system, and start the diagnostics.
 - In a redundant system, the Ethernet diagnostics cannot be started when the system is switched from A/B to B/A in "Main Base Information" of "System Monitor".
-

Precautions

If the communication path includes the following items, the Ethernet diagnostics cannot be started.

- MELSECNET/H
- Multidrop connection with a serial communication module
- Interface board for a personal computer
- GOT (when the transparent function is used)
- MELSEC-Q/L series network module

Status of Each Connection

The status of each connection of the Ethernet-equipped module selected.

Connection No. /Function	Host Station Port No.	Communication Destination Communication	Communication Destination IP Address	Communication Destination Port No.	Latest Error Code	Protocol	Open System	TCP Status
1	---	MELSOFT Connection	---	---	---	TCP	---	Disconnected
2	---	MELSOFT Connection	---	---	---	TCP	---	Disconnected
3	---	MELSOFT Connection	---	---	---	TCP	---	Disconnected
4	---	MELSOFT Connection	---	---	---	TCP	---	Disconnected
5	---	MELSOFT Connection	---	---	---	TCP	---	Disconnected
6	---	MELSOFT Connection	---	---	---	TCP	---	Disconnected
7	---	MELSOFT Connection	---	---	---	TCP	---	Disconnected
8	---	MELSOFT Connection	---	---	---	TCP	---	Disconnected
9	---	MELSOFT Connection	---	---	---	TCP	---	Disconnected
10	---	MELSOFT Connection	---	---	---	TCP	---	Disconnected
11	---	MELSOFT Connection	---	---	---	TCP	---	Disconnected
12	---	MELSOFT Connection	---	---	---	TCP	---	Disconnected
13	---	MELSOFT Connection	---	---	---	TCP	---	Disconnected
14	---	MELSOFT Connection	---	---	---	TCP	---	Disconnected
15	---	MELSOFT Connection	---	---	---	TCP	---	Disconnected
16	---	MELSOFT Connection	---	---	---	TCP	---	Disconnected
17	---	MELSOFT Connection	---	---	---	TCP	---	Disconnected
18	---	MELSOFT Connection	---	---	---	TCP	---	Disconnected
19	---	MELSOFT Connection	---	---	---	TCP	---	Disconnected
20	---	MELSOFT Connection	---	---	---	TCP	---	Disconnected

The following table lists the displayed items in "Status of Each Connection" tab.

Item	Description
Connection No./Function	Displays the connection number and functions (FTP server, FTP client ^{*3} , MELSOFT direct connection).
Host Station Port No.	Displays the own station port number used.
Communication Destination Communication Method ^{*2}	Displays the communication method.
Communication Destination IP Address	Displays the IP address of the sensor/device to be connected, which is set in the parameter settings.
Communication Destination Port No.	Displays the port number of the sensor/device to be connected, which is set in the parameter settings.
Latest Error Code	Displays the error code that indicates the definition of latest error occurred.
Protocol	Displays the protocol (TCP/IP or UDP/IP)
Open System	Displays the open method (Active, Unpassive, or Fullpassive) when the protocol of the connection is TCP/IP.
TCP Status	Displays the status (open status) of connection with the sensor/device when the protocol of the connection status is TCP/IP.
Pairing Open ^{*1}	Displays the setting status of pairing open when the communication method of the connection is the fixed buffer.
Existence Confirmation ^{*1}	Displays the alive check method set in the parameter settings.
Remote Password Status	Displays the remote password setting status.
Consecutive failed unlock attempts	Displays the total number of continuous failure of remote password unlock.
Force Deactivation Status	Displays the status of forced invalidation specification.

*1 This item is displayed only for the RJ71EN71 and the RnENCPU (network part).

*2 This item is displayed only when the network type of the RJ71EN71 is set to "Q Compatible Ethernet" and "MELSOFT Connection Module" is set as an external device in "External Device Configuration" of "Basic Settings".

*3 This item is displayed only for the CPU module (built-in Ethernet port part).

Click the [Clear Latest Error Code] button to clear all the errors displayed in "Latest Error Code" of each connection.

Point

Information about connection No.17 to 64, FTP server, MELSOFT direct connection are not displayed when "Q Compatible Ethernet" is set in the network type of the RJ71EN71.

Status of Each Protocol

The total number of packets sent/received by each protocol of the selected Ethernet-equipped module can be checked.

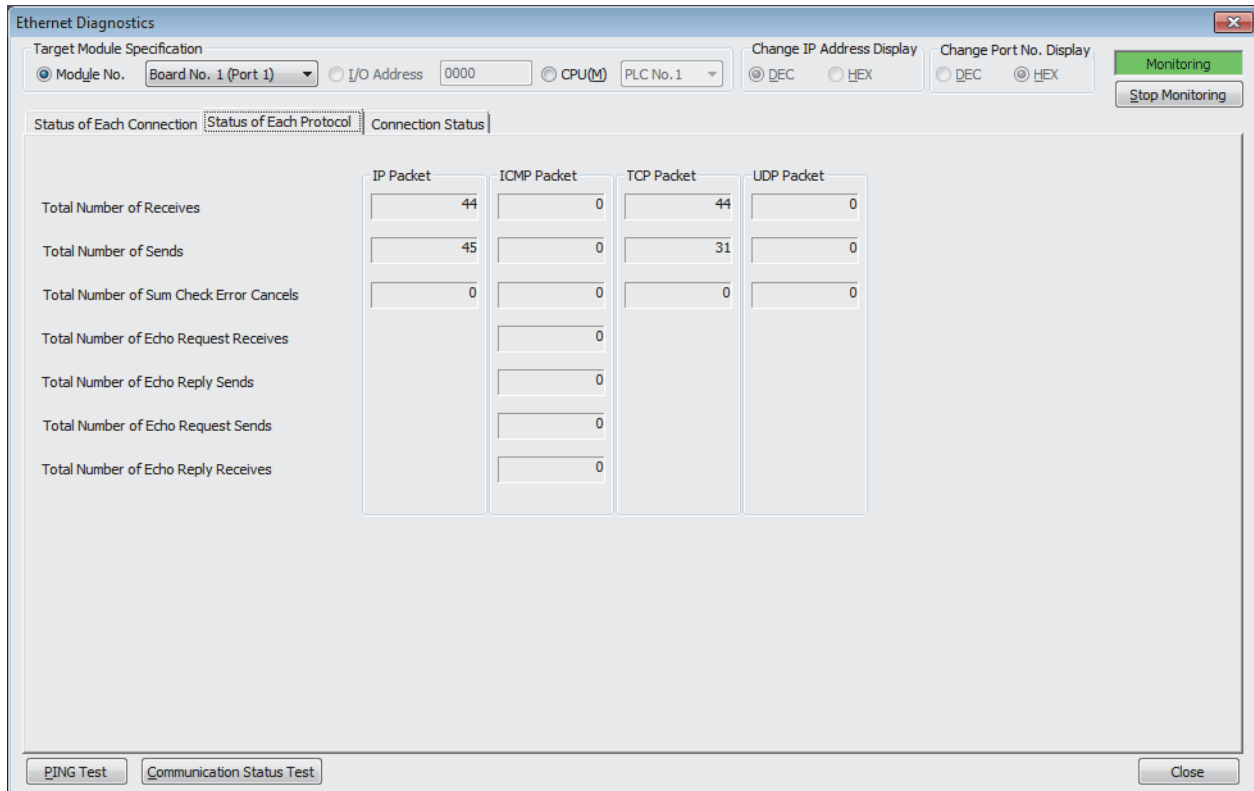

The following table lists the displayed items in "Status of Each Protocol" tab.

Item	Description	Display range
Total Number of Receives	Displays the total number of received packets.	0 to 4294967295
Total Number of Sends	Displays the total number of sent packets.	0 to 4294967295
Total Number of Sum Check Error Cancels	Displays the number of times the received packet was discarded due to checksum error.	0 to 4294967295
Total Number of Echo Request Receives	Displays the total number of received ICMP echo request packets.	0 to 4294967295
Total Number of Echo Reply Sends	Displays the total number of sent ICMP echo reply packets.	0 to 4294967295
Total Number of Echo Request Sends	Displays the total number of sent ICMP echo request packets.	0 to 4294967295
Total Number of Echo Reply Receives	Displays the total number of received ICMP echo reply packets.	0 to 4294967295

Connection Status

The communication status of the Ethernet-equipped module.

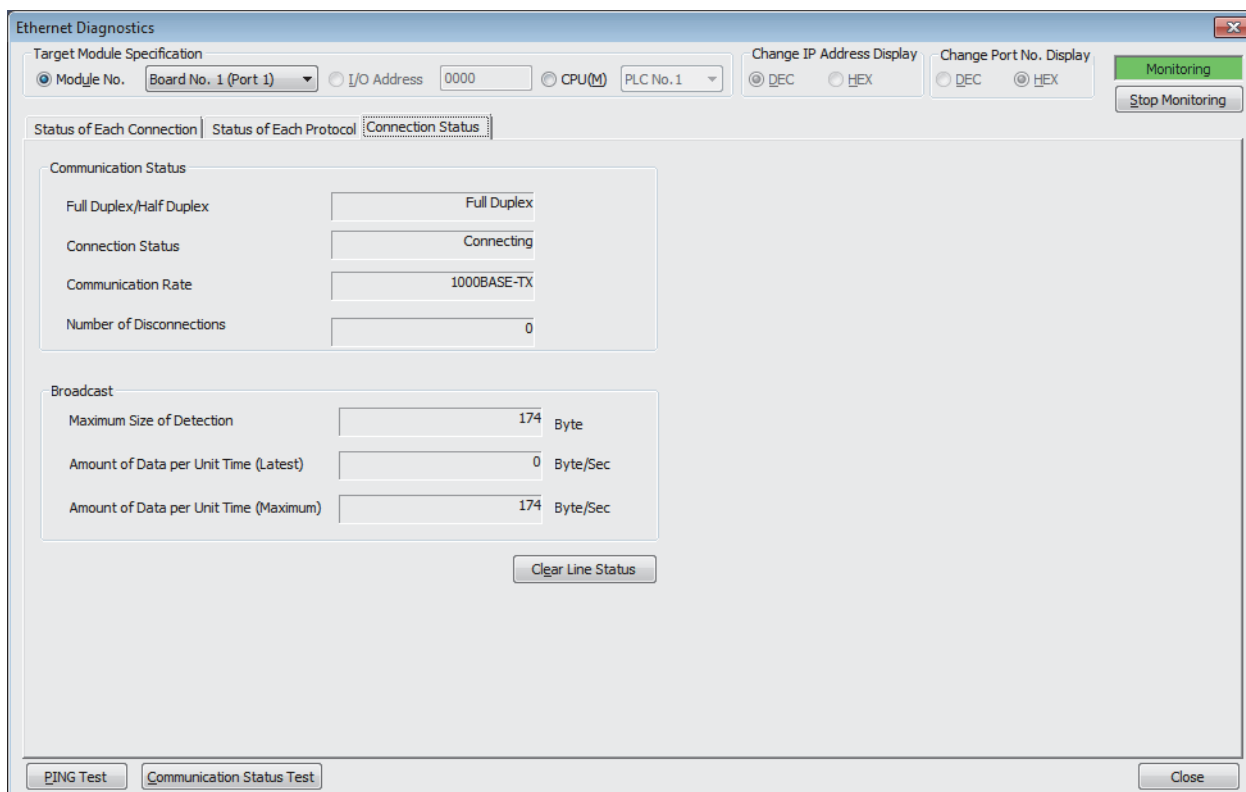

The following table lists the displayed items in "Connection Status" tab.

Item		Description	Display range
Communication Status	Full Duplex/Half Duplex	Displays whether the line is full-duplex or half-duplex.	—
	Connection Status	Displays the cable connection status.	—
	Communication Rate	Displays the communication speed.	—
	Number of Disconnections	Displays the number of times the line entered a state where communication cannot be performed.	0 to 65535
Broadcast	Maximum Size of Detection	Displays the maximum size of discarded broadcast messages.	0 to 65535
	Amount of Data per Unit Time (Latest)	Displays the size (latest value) per second of discarded broadcast messages.	0 to 4294967295
	Amount of Data per Unit Time (Maximum)	Displays the size (maximum value) per second of discarded broadcast messages.	0 to 4294967295

Click the [Clear Line Status] button to clear all the data in "Broadcast".



Information in "Broadcast" is not displayed when "Q Compatible Ethernet" is selected for the network type of the RJ71EN71.

PING Test

The PING test checks existence of an Ethernet device on the same Ethernet network.

This test is performed on the network of stations connected to the engineering tool by sending packets for check. If a response returns, the communication can be performed.

 "Ethernet Diagnostics" window ⇨ [PING Test] button

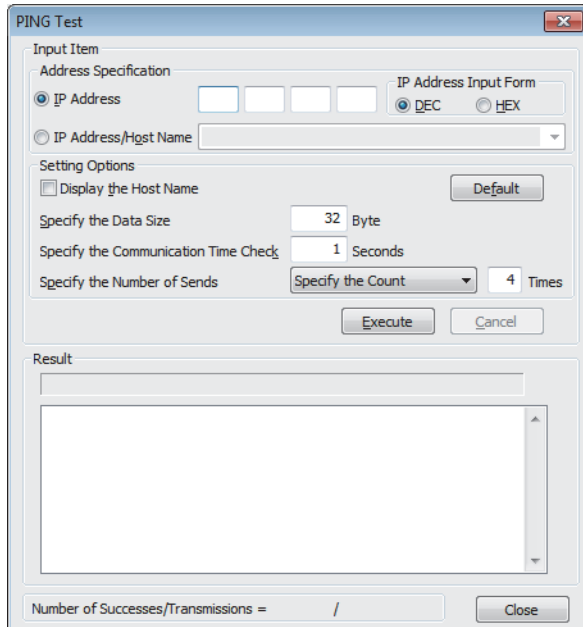

■ Procedure

Set the required items in "Input Item" and click the [Execute] button to execute the PING test. The test results are displayed in the "Result" box.

Point

- When executing the PING test from the RJ71EN71 and the RnENCPU (network part) by connecting the engineering tool and CPU module with a USB cable, network number and station number setting is required to specify the PING executing station.
- When the Ethernet diagnostics are started with a setting other than "No Specification" in "Other Station Setting" on the "Specify Connection Destination Connection" window, the PING test cannot be used.

■ Action for abnormal end

If the test fails, check the following and perform the test again.

- Whether the Ethernet-equipped module is properly mounted on the base unit
- Connection to the Ethernet network
- Parameter settings written in the CPU module
- Operating status of the CPU module (whether or not an error has occurred)
- IP addresses set in the engineering tool and the PING test target station
- Whether the external device has been reset after the Ethernet-equipped module was replaced

Communication Status Test

The communication status test checks whether the communication between the own station and the external device on the same Ethernet is operated normally.

The following external devices are the target of communication status test.

- RJ71EN71 (when the Ethernet function is used)
- RnENCPU (network part) (when the Ethernet function is used)
- MELSEC-Q series Ethernet interface module (function version B or later)
- MELSEC-L series Ethernet interface module

This test is performed on the network of stations connected to the engineering tool, by sending the test messages sequentially to specified network and station number range. If the module that received the message returns a response, communication is normal.

 "Ethernet Diagnostics" window ⇨ [Communication Status Test] button

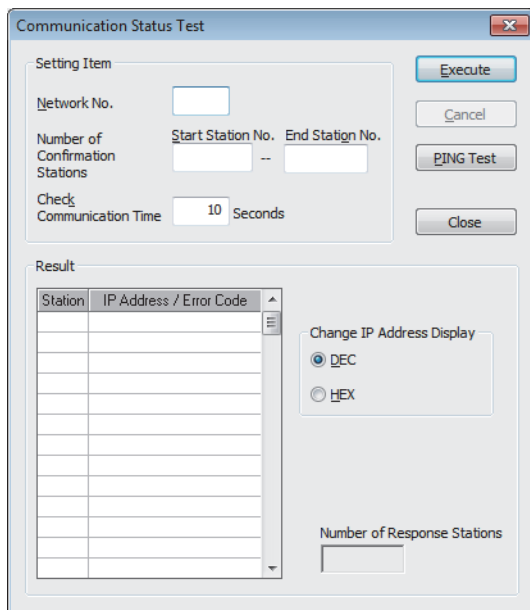

Restriction

The communication status test cannot be used in the following cases.

- When the Ethernet function of the CPU module (CPU part for the RnENCPU) is used
- When the Ethernet diagnostics are started with a setting other than "No Specification" in "Other Station Setting" on the "Specify Connection Destination Connection" window

■ Procedure

Set the required items in "Setting Item" and click the [Execute] button to execute the communication status test. The test results are displayed in the "Result" box.

■Action for abnormal end

If the communication status test fails, "No Response" or an error code is displayed in the "IP Address / Error Code" field in "Result".

Displayed test result	Status of the external device	Cause	Action
No Response	No error	The initial process for the Ethernet-equipped module has not been completed normally.	Correct the module parameters.
		There is an error in the line connection to the Ethernet-equipped module. (Cable disconnection, line disconnection, or others)	<ul style="list-style-type: none"> • Check the cable. • Check the hub and gateway.
		The IP address of the Ethernet-equipped module is incorrect. (The class or subnet address differs from that of the Ethernet-equipped module.)	Correct the module parameters.
		The same IP address has been set to multiple Ethernet-equipped modules.	
		The same network number or station number has been set to multiple Ethernet-equipped modules.	
	No error/Error exists	The Ethernet line is heavily loaded.	Perform the test again when the Ethernet line is not heavily loaded.
Error exists	The routing settings are not configured.	Correct the set value for "Routing Setting" of "CPU Parameter".	
Error code	No error	The "MELSOFT Transmission Port (UDP/IP)" for the Ethernet-equipped module is locked with the remote password.	Disable the remote password setting and write the parameters to the CPU module.
		The target module does not support the communication status test.	Check the module name and function version.
	No error/Error exists	The Ethernet line is heavily loaded.	Perform the test again when the Ethernet line is not heavily loaded.

■Precautions

- The communication status test cannot be executed when "MELSOFT Transmission Port (UDP/IP)" for the target Ethernet-equipped module is locked with the remote password.
- When executing the communication status test, set "Gateway Other Than Default Gateway" under "Gateway Parameter Settings" in "Application Settings" to "Not Use".

Simple CPU communication diagnostics

The communication status of the simple CPU communication function can be checked with "Simple CPU Communication Diagnostics".

[Diagnostics] ⇒ [Simple CPU Communication Diagnostics]

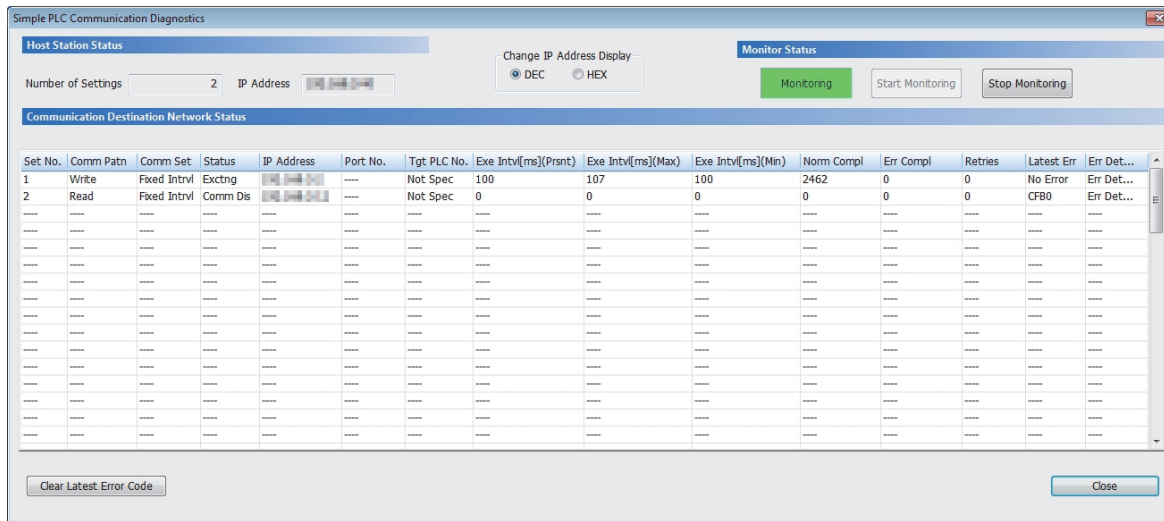

Item	Description
Set No.	Displays the setting number of the simple CPU communication.
Comm Patn	Displays the communication pattern (read/write) set with the parameters.
Comm Set	Displays the communication setting (Fixed Interval/On Request) set with the parameters.
Tgt PLC No.	Displays the communication destination set with the parameters. The destination is displayed when the simple CPU communication is executed with the RJ71EN71 or RnENCPU (network part).
Status	Displays the communication status ("Not Set", "Prepg", "Rqst Wtng", "Exctng", "Stpng", "Rtryng", "Mntrng", or "Comm Dis"). During system switching in a redundant system, "Prepg" is displayed.
IP Address	Displays the IP address of the communication destination set with the parameters.
Port No.	Displays the port number of the communication destination set with the parameters.
Tgt PLC No.	Displays the target PLC number set with the parameters.
Exe Intvl [ms] (Prsnt)	Displays the current value, the maximum value, and the minimum value of the execution interval in increments of ms.
Exe Intvl [ms] (Max)	The values will not be updated during retry or monitoring. During communication stop, 0 is displayed on "Exe Intvl [ms] (Prsnt)".
Exe Intvl [ms] (Min)	Displays "-----" when "On Request" is set to "Comm Set" in "Simple CPU Communication Settings" under "Application Setting".
Norm Compl	Displays the accumulated count of communications that have been completed successfully, completed with an error, and retried. • 0 to 4294967295: Accumulated count When the count exceeds 4294967295, counting is continued from 1 again.
Err Compl	
Retries	
Latest Err	Displays the latest error code. When no error has occurred, "No Error" is displayed. The error remains displayed even after the communication status has changed to the state in which the communication can be performed normally. When another error occurs, it will be overwritten with a new one.
Err Det..	Displays the descriptions and corrective actions for the error occurring in the selected setting number.
[Clear Latest Error Code] button	Clears the error code. This operation also clears the error codes (Un\G1194 to Un\G1257) of the corresponding setting number in the CPU buffer memory.
(Own station) IP address	The IP address of the connected own station is displayed. • The IP address set in "Own Node Settings" under "Basic Settings" in the RJ71EN71 or RnENCPU (network part) is displayed. • When the RJ71EN71 is used in a redundant system, the control system IP address is displayed. • For the Process CPU (redundant mode), the IP address of the connected system A or system B is displayed.

- Even if system switching is executed, "Norm Compl", "Err Compl", "Retries", "Latest Err", and "Err Det..." are not tracked and the data is stored in the system A and system B. Therefore, "Norm Compl", "Err Compl", and "Retries" is accumulated per system and "Latest Err" and "Err Det..." are different between the system A and system B.
- When the engineering tool version is not the latest version, "-----" is displayed as a diagnostics result. To diagnose correctly, update the engineering tool version.
- In a redundant system, to specify the RJ71EN71 as the target module in the simple CPU communication diagnostics, directly connect the station to be diagnosed to the engineering tool and specify the host CPU module ("Specify Redundant CPU" is set to "Not Specified").
- In a redundant system of the remote head module, the simple CPU diagnostics does not start when the engineering tool is connected to the remote head module of the standby system. Connect an engineering tool to the control system and start the diagnostics.
- In a redundant system, the simple CPU communication diagnostics cannot be started when the system is switched between A and B in "Main Base Information" of "System Monitor".
- When "Other Station (Co-existence Network)" has been specified in "Other Station Setting" of "Specify Connection Destination Connection", the simple CPU communication diagnostics cannot be started by specifying "CC-Link" or "C24" in "Co-existence Network Route".
- When a setting other than "No Specification" has been specified in "Other Station Setting" of "Specify Connection Destination Connection", specify an Ethernet-equipped module to be diagnosed in "Other Station Setting" of "Specify Connection Destination Connection". Unless the desired Ethernet-equipped module is specified, even if a different Ethernet-equipped module on the same base unit is specified, the simple CPU communication diagnostics cannot be started for the desired module. The simple CPU communication diagnostics can be started for stations of up to eight networks ahead (number of relay stations: 7) including the network to which the station directly connected with the engineering tool belongs.

Precautions

If the communication path includes the following items, the simple CPU communication diagnostics cannot be started.

- MELSECNET/H
- Multidrop connection with a serial communication module
- Interface board for a personal computer
- GOT (when the transparent function is used)
- MELSEC-Q/L series network module

Error log area

Errors that occurred in each processing operation for data communications between the RJ71EN71 and RnENCPU (network part) and the external device can be checked with the buffer memory. For details, refer to the following.

☞ Page 493 Error log area

3.4 Troubleshooting by Symptom

This section describes troubleshooting method by symptom. If an error has occurred in the Ethernet-equipped module, identify the error cause using the engineering tool. (☞ Page 413 Checking the Module Status)

Communications cannot be performed with the external device.

The following table lists how to troubleshoot the problem when the Ethernet-equipped module cannot communicate with the external device.

Check item	Action
Is the READY LED of the CPU module off?	If the READY LED of the CPU module is off, perform the troubleshooting of the CPU module. (☞ MELSEC iQ-R CPU Module User's Manual (Application))
Is the RUN LED of the RJ71EN71 or the RnENCPU (network part) off?	If the RUN LED of the RJ71EN71 or the RnENCPU (network part) is off, reset the CPU module. If the RUN LED is still off even after resetting the CPU module, the possible cause is a hardware failure. Replace the RJ71EN71 or RnENCPU and restart all the external devices that were performing communications with the own station.*1
Is the Ethernet cable securely connected?	If the Ethernet cable is not securely connected, take following actions. <ul style="list-style-type: none"> Securely lock the cable. Check the wiring. (☞ MELSEC iQ-R Ethernet/CC-Link IE User's Manual (Startup))
Does the external device conform to the Ethernet standard?	If the device does not conform to the Ethernet standard, replace it with one conforming to the standard. (☞ MELSEC iQ-R Ethernet/CC-Link IE User's Manual (Startup))
Is the external device powered on?	If the external device is not powered on, power it on.
Does any error occur in the external device, hub, router, or other devices?	If an error occurs, refer to the manual for each device and take action.
Does the protocol (TCP/IP or UDP/IP) match with that of the external device?	Correct the parameters so that the protocol matches with that of the external device. (☞ Page 320 External Device Configuration)
Is the access from the external device set to be denied in "IP Filter Settings" under "Security" of "Application Settings"?	If the access from the external device is denied, change the setting so that the access is allowed. (☞ Page 395 IP Filter Settings)
Was a device on the line (such as an Ethernet-equipped module, external device, hub, and router) replaced with the one with the same IP address?	If a device was replaced, take any of the following actions. <ul style="list-style-type: none"> Wait for update of the ARP cache (waiting time varies depending on the device) Restart all the devices on the line.*1
Is the IP address of the external device specified correctly?	Execute a PING test to the IP address of the external device. If the existence of the external device cannot be checked, network configuration is incorrect. Consult with the system or network manager.
Is "Module Operation Mode" of "Application Settings" set to a mode other than "Online"?*4	Set "Module Operation Mode" of "Application Settings" to "Online". (☞ Page 406 Module Operation Mode)
Has the initial processing been completed normally? (Check 'Initial status' (Un\G1900024.0).)*3	If the initial processing has not been completed successfully, correct the module parameters. (☞ Page 317 PARAMETER SETTINGS)
Does the communication data code (ASCII or binary) setting match with that of the external device?	If the communication data code settings do not match, data cannot be sent or received because the external device cannot normally decode commands.*2 Set the same data code as that of the external device in "Communication Data Code" under "Own Node Settings" of "Basic Settings". (☞ Page 318 Own Node Settings)
Is the target connection in forcibly invalidated state in the "Force Deactivation Status" column in the "Status of Each Connection" tab of the "Ethernet Diagnostics" window?	Turn off the area corresponding to the target connection in 'Forced connection invalidation setting area' (Un\G5646 to Un\G5650) to cancel the forced invalidation.
Is the access from the Ethernet-equipped module denied by the security setting of the external device?	Correct the security setting (such as firewall) of the external device.
For the RJ71EN71 or the RnENCPU (network part), is 'IP address change function operating status' (Un\G11715.0) on?	When 'IP address change function operating status' (Un\G11715.0) is on, the module is operating according to the settings of the IP address change function. Either clear the IP address storage area, or correct the settings. (☞ Page 286 IP Address Change Function)
Does a timeout occur when connecting to the engineering tool?	Increase the value for "Check at Communication Time" and "Retry Times" in the following windows in the "Specify Connection Destination Connection" window and connect again. <ul style="list-style-type: none"> "Host Station Detailed Setting" window of "No Specification" "Other Station Detailed Setting" window of "Other Station (Single Network)" or "Other Station (Co-existence Network)"

Check item	Action
When connecting to an engineering tool, use [Ethernet Diagnostics] ⇒ [TCP Status] to check if the connection to be established is "Connected".	Another user may be connected, so wait for the connection to be disconnected or try to connect using UDP/IP. If no connection is familiar, turn on the target connection area in the forced connection invalidation setting area, and execute forced invalidation. (☞ Page 516 Forced connection invalidation setting area)

When the problem cannot be solved with above actions, check the error cause according to the communication processing and take action.

- Communications using the SLMP (☞ Page 431 Communications using the SLMP cannot be performed.)
- Communications using the predefined protocol (☞ Page 432 Communications using the predefined protocol cannot be performed.)
- Socket communications/Communications using the fixed buffer (☞ Page 434 Socket communications/communications using the fixed buffer cannot be performed.)
- Communications using the random access buffer (☞ Page 433 Communications using the random access buffer cannot be performed.)
- Communications using link dedicated instructions (☞ Page 436 Communications using a link dedicated instruction cannot be performed.)
- File transfer function (FTP server) (☞ Page 436 Access using the file transfer function (FTP server) cannot be performed.)

*1 A device on Ethernet has a table of IP addresses and their corresponding MAC address, called "ARP cache". When a device on the line is replaced by the one having the same IP address, the MAC address in the ARP cache is different from that of the replaced device; therefore, communications may not be normally performed. The "ARP cache" is updated by resetting the device or after a while. The time varies depending on the device.

*2 If the communication data code setting is different between the Ethernet-equipped module and the external device, error codes that are not found in the error code list may be returned to the external device. When receiving data with different data codes, the Ethernet-equipped module cannot decode commands normally. The Ethernet-equipped module returns an error response according to the communication data code setting.

*3 The buffer memory address is for when the network type of the RJ71EN71 or the RnENCPU (network part) is set to "Ethernet" and the P1 connector is used.

When using the P2 connector or the CPU module (built-in Ethernet port part), or setting the network type to "Q Compatible Ethernet", refer to the following.

☞ Page 473 Buffer Memory



*4 Check this item only for the modules that have the relevant setting in the module parameters.

A message sent from the external device cannot be received frequently.

When the Ethernet-equipped module frequently fails to receive a message sent from the external device, check the following items.

Check item	Action
Are errors frequently detected in 'Simultaneous transmission error detection count (receive buffer full count)' (Un\G5022 to Un\G5023)?*1	If many errors are detected or a system error is stored, there may be a heavy load on the Ethernet line due to data sending and receiving between connected devices. <ul style="list-style-type: none"> • Taking action such as separating networks or decreasing the number of data sending reduces the load on the Ethernet line. • Consult with the network manager and reduce the load on the Ethernet line.
Has a system error been stored in 'Latest error code' (Un\G100 to Un\G163 (Connection No.1 to No.64 latest error code))?*1	
Has 1H been stored in 'State of receive buffer' (Un\G1900030)?*3	<ul style="list-style-type: none"> • Taking action such as separating networks or decreasing the number of data sending reduces the load on the Ethernet line. • When communications using the fixed buffer is used, check whether the BUFRCV instruction is executed. (☞ Page 78 Receive procedure) • To receive data at shorter intervals than the scan time of the CPU module using the fixed buffer, add the normally closed contact for the completion device of the BUFRCV instruction to the execution conditions of the BUFRCV instruction. (☞ Page 97 Labels)

If the above action does not solve the problem, perform the module communication test to check for hardware failure. (☞ Page 415 Module communication test)*2

- *1 The buffer memory address is for when the network type of the RJ71EN71 or the RnENCPU (network part) is set to "Ethernet" and the P1 connector is used.
When using the P2 connector or the CPU module (built-in Ethernet port part), or setting the network type to "Q Compatible Ethernet", refer to the following.
 Page 473 Buffer Memory
- *2 The module communication test cannot be performed for the CPU module (built-in Ethernet port part). Perform the troubleshooting of the CPU module and check for hardware failure. ( MELSEC iQ-R CPU Module User's Manual (Startup))
- *3 Availability for the buffer memory depends on the firmware version. ( Page 564 Added and Enhanced Functions)

Direct connection to the engineering tool is not possible.

When the direct connection to the engineering tool is not possible, check the following items.

Check item	Action
Is the Ethernet-equipped module directly connected to the engineering tool with a single cable?	Directly connect the Ethernet-equipped module to the engineering tool with a single cable.
Is "Disable Direct Connection with MELSOFT" under "Security" of "Application Settings" is set to "Disable"?	If "Disable Direct Connection with MELSOFT" is set to "Disable", change the setting to "Enable".
Is the transfer setup setting of the engineering tool correct?	If the setting is incorrect, check the following items. <ul style="list-style-type: none"> • Check that "Ethernet Board" is selected in "PC side I/F". • Check that "Ethernet Port Direct Connection" is selected in the "PLC side I/F Detailed Setting of PLC Module" window or "PLC side I/F Detailed Setting of Ethernet Module" window of "PLC side I/F". • When "PLC side I/F" is "Ethernet Module", check that "Other Station (Single Network)" is selected for "Other Station Setting" and "Access to Ethernet module set on PLC side I/F" is selected in the "Network Communication Route Detailed Setting of Ethernet" window of "Network Communication Route".
Does a timeout occur when connecting to the engineering tool?	Increase the value for "Check at Communication Time" and "Retry Times" in the "Other Station Detailed Settings" window of "Other Station Setting" of the "Specify Connection Destination Connection" window and connect again.
Does the device (personal computer) to be connected support the direct connection?	If the device does not support the direct connection, connect a hub.

If the above action does not solve the problem, perform the module communication test to check for hardware failure. ( Page 415 Module communication test)*¹

- *1 The module communication test cannot be performed for the CPU module (built-in Ethernet port part). Perform the troubleshooting of the CPU module and check for hardware failure. ( MELSEC iQ-R CPU Module User's Manual (Startup))

CPU module search on the network cannot be performed.

When the CPU module search on the network cannot be performed, check the following items.

Check item	Action
Is "Do Not Respond to CPU Module Search" under "Security" of "Application Settings" is set to "Do Not Respond"?	Set "Do Not Respond to CPU Module Search" under "Security" of "Application Settings" to "Respond".
Is the CPU module cannot be searched connected to a router?	The CPU module connected via a router cannot be searched. Modify the connection to search the CPU module.
Is the CPU module cannot be searched connected with wireless LAN?	Perform the search again. (The packet may be lost.)
Is the service processing (such as file read) load of the search target CPU module high?	<ul style="list-style-type: none"> • Increase the response waiting time and perform the search again. • Reduce the service processing load of the CPU module.

Communications using the SLMP cannot be performed.

When communications using the SLMP cannot be performed, check the following items.

Check item	Action
Has the connection with the external device been opened? (Check 'Open completion signal' (Un\G1900000 to Un\G1900007).)*1*2	<ul style="list-style-type: none"> • If the connection with the external device is not opened, perform the open processing. • If an error occurs, check and eliminate the error cause.
Is the correct command format used for the command type, device, address, and others?	Correct the command format. (📖 SLMP Reference Manual)
Is "Enable/Disable Online Change" under "Own Node Settings" in "Basic Settings" set to "Disable All (SLMP)"?	If "Enable/Disable Online Change" is set to "Disable All (SLMP)", change the setting to "Enable All (SLMP)". (📖 Page 318 Own Node Settings)
Did the external device send a command?	If the device did not send a command, send a command to the Ethernet-equipped module.
Was a response returned to the device that had sent the command?	<ul style="list-style-type: none"> • If no response was returned, check if the correct IP address was specified in the command. If not, correct the IP address and send the command again. • If a response was returned, check the end and error codes to correct the error.
Is the communication method of the connection used for communication with the external device is set to an item other than "SLMP" in the "External Device Configuration" window of "Basic Settings"?	Correct the communication method setting if an item other than "SLMP" is set. (📖 Page 320 External Device Configuration)

If the above action does not solve the problem, perform the module communication test to check for hardware failure. (📖 Page 415 Module communication test)*3

- *1 The buffer memory address is for when the network type of the RJ71EN71 or the RnENCPU (network part) is set to "Ethernet" and the P1 connector is used.
When using the P2 connector or the CPU module (built-in Ethernet port part), or setting the network type to "Q Compatible Ethernet", refer to the following.
(📖 Page 473 Buffer Memory)
- *2 If the connection of only the external device is closed due to cable disconnection, personal computer restart, or other reasons, reopen the connection using the same port used before the error occurred. The E71 does not close a connection if it receives an Active open request again from the external device with a different IP address or a port number.
- *3 The module communication test cannot be performed for the CPU module (built-in Ethernet port part). Perform the troubleshooting of the CPU module and check for hardware failure. (📖 MELSEC iQ-R CPU Module User's Manual (Startup))

Communications using the predefined protocol cannot be performed.

When communications using the predefined protocol cannot be performed, check the following items and take action.

Check item	Action
Is the IP address setting of the external device correct?	Check and correct the IP address of the external device.
Has the connection with the external device been opened? (Check 'Open completion signal' (Un\G1900000 to Un\G1900007).) ^{*1*2}	<ul style="list-style-type: none"> • If the connection with the external device is not opened, perform the open processing. • If an error occurs, check and eliminate the error cause.
Has the send/receive processing (dedicated instruction) for the communications using the predefined protocol been executed properly?	<ul style="list-style-type: none"> • If the send/receive processing has not been executed, check and correct the execution condition of the send/receive processing. • If send/receive processing has completed with an error, check the error code in the completion status and eliminate the error cause.
Is the appropriate protocol used for the external device in the predefined protocol settings and program?	<p>Correct the predefined protocol settings and program if inappropriate protocol is used.</p> <p>For appropriate protocol for the external device, refer to the manual for the device used.</p>
Is the communication method of the connection used for communication with the external device is set to an item other than "Predefined Protocol" in the "External Device Configuration" window of "Basic Settings"?	Correct the communication method setting if an item other than "Predefined Protocol" is set. (☞ Page 320 External Device Configuration)
Is 'Predefined protocol ready' (Un\G1901002.0) on? ^{*1}	If 'Predefined protocol ready' (Un\G1901002.0) is off, write the protocol setting data to the module.

If the above action does not solve the problem, perform the module communication test to check for hardware failure. (☞ Page 415 Module communication test)^{*3}

- *1 The buffer memory address is for when the network type of the RJ71EN71 or the RnENCPU (network part) is set to "Ethernet" and the P1 connector is used.
When using the P2 connector or the CPU module (built-in Ethernet port part), or setting the network type to "Q Compatible Ethernet", refer to the following.
☞ Page 473 Buffer Memory
- *2 If the connection of only the external device is closed due to cable disconnection, personal computer restart, or other reasons, reopen the connection using the same port used before the error occurred. The E71 does not close a connection if it receives an Active open request again from the external device with a different IP address or a port number.
- *3 The module communication test cannot be performed for the CPU module (built-in Ethernet port part). Perform the troubleshooting of the CPU module and check for hardware failure. (☞ MELSEC iQ-R CPU Module User's Manual (Startup))

Communications using the random access buffer cannot be performed.

When communications using the random access buffer cannot be performed, check the following items and take action.

Check item	Action
Has the connection with the external device been opened? (Check 'Open completion signal' (Un\G1900000 to Un\G1900007).)*1*2	<ul style="list-style-type: none"> • If the connection with the external device is not opened, perform the open processing. • If an error occurs, check and eliminate the error cause.
Did the external device send a command?	Send a command to the Ethernet-equipped module from the external device.
Is the correct buffer memory address specified for the command?	If the specified buffer memory address is incorrect, correct it and send the command again.
Has data been set in the specified address of the random access buffer?	If any data has not been set, write the data.
Has the write data been set in the external device?	If any write data has not been set, set the data.
Was a response returned to the device that had sent the command?	<ul style="list-style-type: none"> • If no response was returned, check if the correct IP address was specified in the command. If not, correct the IP address and send the command again. • If a response was returned, check the end and error codes to correct the error.
Is the communication method of the connection used for communication with the external device is set to an item other than "Random Access Buffer" in the "External Device Configuration" window of "Basic Settings"?	Correct the communication method setting if an item other than "Random Access Buffer" is set. (☞ Page 320 External Device Configuration)

If the above action does not solve the problem, perform the module communication test to check for hardware failure. (☞

Page 415 Module communication test)

*1 The buffer memory address is for when the network type of the RJ71EN71 or the RnENCPU (network part) is set to "Ethernet" and the P1 connector is used.

When using the P2 connector or setting the network type to "Q Compatible Ethernet", refer to the following.

☞ Page 473 Buffer Memory

*2 If the connection of only the external device is closed due to cable disconnection, personal computer restart, or other reasons, reopen the connection using the same port used before the error occurred. The E71 does not close a connection if it receives an Active open request again from the external device with a different IP address or a port number.

Socket communications/communications using the fixed buffer cannot be performed.

When socket communications or communications using the fixed buffer cannot be performed, check the following items and take action.

Check item	Action
Has the connection with the external device been opened? (Check 'Open completion signal' (Un\G1900000 to Un\G1900007).)* ^{1,2}	<ul style="list-style-type: none"> • If the connection with the external device is not opened, perform the open processing. • If an error occurs, check and eliminate the error cause.
Has the send/receive processing been executed properly?	<ul style="list-style-type: none"> • If the send/receive processing has not been executed, check and correct the execution condition of the send/receive processing. • If send/receive processing has completed with an error, check the error code in the completion status and eliminate the error cause.
Does 'Socket/fixed buffer reception status signal' (Un\G1900016 to Un\G1900023) turn on when receive processing is executed?	<ul style="list-style-type: none"> • Send data from the external device. • If data has been sent, check that the destination address (IP address and port number) is correctly set.
Is the communication method of the connection used for communication with the external device is set to an item other than the following in the "External Device Configuration" window of "Basic Settings"? <ul style="list-style-type: none"> • Socket communications: "Socket Communication" • Communications using the fixed buffer: "Fixed Buffer (Procedure Exist)" or "Fixed Buffer (No Procedure)" 	Correct the communication method setting if an item other than the one described in the left is set. (📖 Page 320 External Device Configuration)
Is the communication method of the connection used for communication with the external device is set to an item other than "Broadcast Send" or "Broadcast Receive" in the "External Device Configuration" window of "Basic Settings" when broadcast communications is performed?	Correct the communication method setting if an item other than the one described in the left is set. (📖 Page 320 External Device Configuration)

If the above action does not solve the problem, perform the module communication test to check for hardware failure. (📖 Page 415 Module communication test)^{*3}

- *1 The buffer memory address is for when the network type of the RJ71EN71 or the RnENCPU (network part) is set to "Ethernet" and the P1 connector is used.
When using the P2 connector or the CPU module (built-in Ethernet port part), or setting the network type to "Q Compatible Ethernet", refer to the following.
(📖 Page 473 Buffer Memory)
- *2 If the connection of only the external device is closed due to cable disconnection, personal computer restart, or other reasons, reopen the connection using the same port used before the error occurred. The E71 does not close a connection if it receives an Active open request again from the external device with a different IP address or a port number.
- *3 The module communication test cannot be performed for the CPU module (built-in Ethernet port part). Perform the troubleshooting of the CPU module and check for hardware failure. (📖 MELSEC iQ-R CPU Module User's Manual (Startup))

Communications using MODBUS/TCP cannot be performed.

Communication fails at MODBUS/TCP connection.

When communication is not possible at MODBUS/TCP connection, check the following items and take action.

Check item	Action
Does the external device support MODBUS/TCP?	If the device does not support MODBUS/TCP, replace it with the one supporting the MODBUS/TCP standard.
Is the external device a MODBUS/TCP master device?	The external device must be a MODBUS/TCP master device.
Was a new connection attempted when 64 external devices have already been connected?	Reduce the number of external devices connected to the Ethernet-equipped module. If the number of connections with external devices exceeds 64, the connection is disconnected automatically from the device for which the longest time has elapsed from the last communication.
Is the Ethernet-equipped module supporting the MODBUS/TCP function used?	Check the firmware version of the Ethernet-equipped module and ensure that the module supports the MODBUS/TCP function. When the Ethernet-equipped module being used does not support the MODBUS/TCP function, replace it with the module that supports the function.

3

Messages sent from the MODBUS/TCP master device cannot be received.

When messages sent from the MODBUS/TCP master device cannot be received completely or frequently, check the following items and take action.

Check item	Action
Are there times when 'State of receive buffer' (Un\G1900030) becomes 1 (Receive buffer full)?	The load on the Ethernet line may high due to the data communication between the nodes. Take the following actions. <ul style="list-style-type: none">• Reduce the load on the Ethernet line by separating networks, decreasing the number of data sending, or other method.• Consult with the network manager and reduce the load on the Ethernet line.

A response message cannot be sent to the MODBUS/TCP master device.

When a response message to the request message sent from the MODBUS/TCP master device or a supposed response message cannot be sent, check the following items and take action.

Check item	Action
Is the registration of the MODBUS device assignment parameters correct?	Check the settings of the MODBUS device assignment parameters.
Was an abnormal response code sent?	Check the abnormal response code and correct any possible problems.
Is there any error code stored in 'Error log area for MODBUS/TCP function' (Un\G720896 to Un\G721153)?	Take an appropriate action in accordance with the stored error code. ( Page 443 List of Error Codes)
Is the request message received from the MODBUS/TCP master device correct?	Correct the request message that the MODBUS/TCP master device sends.
Is the message length of the application data area of the Ethernet frame six bytes or longer (from communication ID to message length of the MBAP header)?	
Does the message length of the MBAP header + 6 bytes match with the message length of the application data area of the Ethernet frame?	

A dedicated instruction is not completed.

If the dedicated instruction is not completed when using the RJ71EN71 or the RnENCPU (network part), check if an option other than "Online" is set in "Module Operation Mode" under "Application Settings".
Set "Online".

Communications using a link dedicated instruction cannot be performed.

When communications using a link dedicated instruction cannot be performed, check the following items and take action.

Check item	Action
Are the network number and station number set in the Ethernet-equipped module?	Set the network number and station number.
Is the number of resends set upon every instruction execution?	Modify the program to set the number of resends upon every instruction execution.
Are station numbers unique?	Change the duplicated station number.
Is the network number duplicated on the network?	Correct the parameters so that the network number is not overlapped.
Is a communication path by the dynamic routing function is determined?	<ul style="list-style-type: none">• Power on the system and start transient transmission after a while.• When "Dynamic Routing" under "Application Settings" of the station on the communication path is set to "Disable", change it to "Enable".
Does the relay station to be passed support the dynamic routing function?	If the relay station to be passed does not support the dynamic routing function, set all the stations on the communication path in "Routing Setting" of "CPU Parameter".
Are multiple link dedicated instructions with same channel setting executed simultaneously?	<ul style="list-style-type: none">• Set different channel to each instructions.• Shift the execution timing of the link dedicated instructions.

If the above action does not solve the problem, perform the module communication test to check for hardware failure. (🔗
Page 415 Module communication test)

Access using the file transfer function (FTP server) cannot be performed.

When the Ethernet-equipped module cannot be accessed from the external device (FTP client) using the file transfer function (FTP server), check the following items and take action.

Check item	Action
Is the file transfer function (FTP server) for the Ethernet-equipped module enabled?	Set "FTP Server" under "FTP Server Settings" of "Application Settings" to "Use". (🔗 Page 329 FTP Server Settings)
Are the login name and password correct?	Check the login name and password set in the parameters, and log in again. (🔗 Page 329 FTP Server Settings)
Is the IP address entered at login correct?	Check the IP address of the Ethernet-equipped module set in the parameters, and log in again. (🔗 Page 318 Own Node Settings)
Is executed command used properly?	Check the instructions of the command and use the command properly. (🔗 Page 125 FTP command)
In multiple CPU system, is the access destination CPU module correct?	Execute the cpuchg command and change the access destination CPU module.

If the above action does not solve the problem, perform the module communication test to check for hardware failure. (🔗
Page 415 Module communication test)*¹

*¹ The module communication test cannot be performed for the CPU module (built-in Ethernet port part). Perform the troubleshooting of the CPU module and check for hardware failure. (🔗 MELSEC iQ-R CPU Module User's Manual (Startup))

Access using the file transfer function (FTP client) cannot be performed.

When the CPU module cannot access to the external device (FTP server) during execution of the file transfer function (FTP client), check the following items and take action.

Check item	Action
Is a value other than 0000H stored in (s1)+1 (Completion status) of the SP.FTPPUT or SP.FTPGET instruction?	Take action for the error code stored in (s1)+1 (Completion status), and execute the instruction again. (☞ Page 443 List of Error Codes)

The time setting function (SNTP client) cannot be performed normally.

When the time setting function (SNTP client) cannot be performed normally, check the following items and take action.

Check item	Action
Is the time setting function (SNTP client) is enabled for the Ethernet-equipped module?	Set "Time Setting (SNTP Client)" under "Time Setting" of "Application Settings" to "Use". (☞ Page 391 Time Setting)
Is "SNTP Server IP Address" set correctly?	Change the "SNTP Server IP Address" under "Time Setting" in "Application Settings" to the correct IP address. (☞ Page 391 Time Setting)

If the above action does not solve the problem, perform the module communication test to check for hardware failure. (☞ Page 415 Module communication test)*1

*1 The module communication test cannot be performed for the CPU module (built-in Ethernet port part). Perform the troubleshooting of the CPU module and check for hardware failure. (📖 MELSEC iQ-R CPU Module User's Manual (Startup))

The access cannot be allowed/denied correctly by the IP filter.

When the access cannot be allowed/denied correctly by the IP filter, check the following items and take action.

Check item	Action
Is "Access from IP address below" correctly set in "IP Filter Settings" under "Security" of "Application Settings"?	Correct the setting of "Access from IP address below".
Are the IP addresses set in "IP Address" in "IP Filter Settings" under "Security" of "Application Settings"?	Correct the IP addresses. When the IP addresses are specified by range, check also "IP Address Excluded from Range".
Is the IP address of the proxy server set to be allowed?	Set the IP address of the proxy server to be denied.

Remote password does not work.

When the remote password does not work, check the following items and take action.

Check item	Action
Is the remote password setting of the target connection disabled in the "Remote Password Detail Setting" window?	If the remote password is disabled, change the setting so that it is enabled. (☞ Page 181 Remote password)

Communications using the built-in Ethernet port are slow.

When communications using the built-in Ethernet port are slow, check the following items and take action.

Check item	Action
Is the communication request load from the external device high?	<p>Check the buffer memory Un\G100 (receive packet count (current) per unit time (one second)) of the CPU module (built-in Ethernet port part), and if the value is significantly large compared to the normal communications, the following actions may improve the processing speed.</p> <ul style="list-style-type: none"> • Review the communication request from the engineering tool and GOT. • Review the communication request from the transfer destination (execution source) of the simple CPU communications. • Review the file transfer function (FTP server). • Review the communications using the SLMP.
Is the communication request load from the CPU module high?	<p>Check the buffer memory Un\G102 (send packet count (current) per unit time (one second)) of the CPU module (built-in Ethernet port part), and if the value is significantly large compared to the normal communications, the following actions may improve the processing speed.</p> <ul style="list-style-type: none"> • Review the execution frequency of the instructions for the built-in Ethernet function (socket communications instruction/predefined protocol support function instruction/SLMP frame send instruction/file transfer function instruction) • Review the settings (such as the number of points) of CC-Link IE Field Network Basic. • Review the settings (such as the execution interval and the number of points) of the simple CPU communications. • Review the settings (such as automatic detection and backup execution) of iQSS (built-in Ethernet). • Review the settings (such as the number of executions) of data logging file transfer.

When the simple CPU communication function is used

Communications cannot be performed with the communication destination.

When communications with the external device cannot be performed using the simple CPU communication function, check the following items and take action.

Check item	Action
Does any error occur in the simple CPU communication diagnostics or simple CPU communication error code in the buffer memory?	<p>Eliminate the error cause. When communications can be performed by increasing the communication retry count and communication time-out period, review the communication retry count and communication time-out period, or check the line status of Ethernet communications with the external device, such as a cable, hub, and router, to check if the line is busy.</p>
Is the communication status of the simple CPU communication diagnostics or the simple CPU communication status of the buffer memory "preparing"?	<p>Check the cable between the Ethernet-equipped module and hub, and check if the hub is operating normally.</p>
Is the module supporting the simple CPU communication function used?	<p>Refer to the following page and check the firmware version of the module that can use a desired device as a communication destination. (☞ Page 224 Restrictions applicable depending on versions) In "Product Information List" of "System Monitor", check the firmware version of the target module, and ensure that the module supports the simple CPU communication. When the module used does not support the simple CPU communication, update the firmware to the version supporting the function or replace the module with a module that supports the function.</p>
Is the own station port number set in the external device configuration within the range of 61696 to 65534?	<p>When the communication destination of the simple CPU communication is a Mitsubishi Electric programmable controller, the own station port number is dynamically set within the range of 61696 to 65534. When the own station port number is set within the range of 61696 to 65534 in the external device configuration, the port numbers overlap, resulting in a communication failure. Set the own station port number to a number other than 61696 to 65534 in the external device configuration.</p>

If communications cannot be performed despite the check for the above items, the hardware failure may have been occurred. Please consult your local Mitsubishi representative.

Data cannot be read or written in the specified way.

If data cannot be read or written in the specified way by using the simple CPU communication function, check the following items and take action.

Check item	Action
Is the set module type applicable to the module used?	Refer to the following page and check the firmware version of the module that can use the set module type. (Page 224 Restrictions applicable depending on versions) In "Product Information List" of "System Monitor", check the firmware version of the target module, and ensure that the module supports the simple CPU communication. When the module used does not support the simple CPU communication, update the firmware to the version supporting the function or replace the module with a module that supports the function.
Are the settings of the communication destination correct?	Check that the module type and the range set in "Simple CPU Communication Setting" match with the settings of the communication destination.

Communications with the communication destination are unstable.

When communications with the communication destination using the simple CPU communication is unstable, check the following items and take action.

Check item	Action
Does any error occur in the simple CPU communication diagnostics or simple CPU communication error code in the CPU buffer memory?	Eliminate the error cause.
Is the retry of communications performed?	Check the line status of Ethernet communications with the external device, such as a cable, hub, and router, to check if the line is busy.

Communications cannot be performed at the set execution interval.

When communications cannot be performed at the set execution interval in the simple CPU communication function, check the following items and take action.

Check item	Action
Is another Ethernet function executed simultaneously in the CPU module where the simple CPU communication function is set?	Review the Ethernet function executed simultaneously in the CPU module where the simple CPU communication function is set.
Is the service processing load of the CPU module of the communication destination high?	<ul style="list-style-type: none"> When the communication destination is the model for which service processing setting is available, increase the number of times and the time of service processing of the communication destination. If the communication destination supports the COM(P) instruction and CCOM instruction, incorporate the COM(P) instruction and CCOM instruction into the sequence program of the communication destination. Review the execution interval.
Is the Ethernet communication load high? Or, is the communication quality low?	Check the line status of Ethernet communication with the external device, such as a cable, hub, and router, to reduce the load and improve the communication quality. (Check the buffer memory Un\G100/Un\G101 (receive packet count per unit time (one second)) or Un\G102/Un\G103 (send packet count per unit time (one second)) of the CPU module (built-in Ethernet port part) and reduce the load and improve the communication quality.)
Is the response from the SLMP-compatible device delayed? (When the SLMP-compatible device (QnA-compatible 3E frame) is used)	<ul style="list-style-type: none"> Check the function execution status of the communication destination (SLMP-compatible device). Review the execution interval.

The update by reading and writing the device data is slow.

When the update by reading and writing the device data is slow in the simple CPU communications, check the following items and take action.

Check item	Action
The scan time of the CPU module where the simple CPU communication function is set is long.	Incorporate the COM(P) instruction and CCOM instruction into the sequence program of the CPU module where the simple CPU communication function is set.

When the simple device communication function is used

Unable to communicate with the communication destination.

When communications with the communication destination cannot be performed using the simple device communication function, check the following items and take action.

Check item	Action
Is the module supporting the simple device communication function used?	In "Product Information List" of "System Monitor", check the firmware version of the target module, and ensure that the module supports the simple device communication. When the module being used does not support the simple device communication, update the firmware that supports the function or replace the module with a module that supports the function.
Is the IP address setting of the communication destination correct?	Check the IP address of the communication destination, and correct it if incorrect.
Is 'Status of connection' (Un\G1249309) 3H (communicating)?	<ul style="list-style-type: none">• If the status is 1H (preparing), wait until the latency time has elapsed.• If the status is 2H (waiting for the request) or 4H (communication stop), turn on 'Function start/stop instruction' (Un\G1249300.0) and 'Start request for each protocol' (Un\G1249348 to Un\G1249379).• If the status is 5H (retry being executed) or 6H (monitoring at error), wait until "Timeout Time" or "Monitoring Time At Error" has elapsed and then check the status again.
Is the Ethernet cable securely connected?	Connect the Ethernet cable correctly.*1
Is the appropriate protocol used for the communication destination in the protocol settings?	If the protocol for the communication destination is inappropriate, correct it to the appropriate protocol. For protocols, refer to the manual for the communication destination.

*1 When 'Status of connection' (Un\G1249309) is 5H (retry being executed) at reconnection of the Ethernet cable, the time until the communication returns to the normal state may result in $((\text{Retry Count} + 1) \times \text{"Timeout Time"}) + (\text{"Monitoring Time At Error"} \times 2)$ at the maximum.
When 'Status of connection' (Un\G1249309) is 6H (monitoring at error), the time until the communication returns to the normal state may result in $(\text{"Monitoring Time At Error"} \times 2)$ at the maximum.

Verification mismatch occurs even when the response is received.

When the verification mismatch occurs even when the response from the communication destination is received using the simple device communication function, check the following items and take action.

Check item	Action
Check 'Verification mismatch protocol number' (Un\G1249317) and 'Verification mismatch information' (Un\G1249318 to Un\G1249333).	Check the element number with which the verification mismatch has occurred and the cause of the verification mismatch, and correct the setting details of the element that causes the mismatch.
Check the setting details of "Clear Receive System Area" of "Send/Receive Parameter Setting".	If "No" is set, change the setting to "Yes".

Data communications cannot be performed with the device supporting iQ Sensor Solution.

When communications with the device supporting iQ Sensor Solution cannot be performed, check the following items and take action.

Check item	Action
In "iQ Sensor Solution Settings" under "Application Settings", is "Use" set for "iQ Sensor Solution Settings" under "Application Settings"?	If "Not to Use" is set, change the setting to "Use".

When the redundant system function is used

Communications cannot be performed with the external device.

When communications with the external device cannot be performed using the redundant system function, check the following items and take action.

Check item	Action
Are the control system IP address and the IP addresses of systems A and B used together for the same connection?	Set the different connections for the each of control system IP address and IP addresses of systems A and B.

3

System switching cannot be performed normally.

When system switching cannot be performed normally by the redundant system function, check the following items and take action.

Check item	Action
Is the power supply module, CPU module, or redundant function module of the standby system operating normally?	Perform troubleshooting on the power supply module, CPU module, or redundant function module of the standby system. (MELSEC iQ-R CPU Module User's Manual (Startup))
Has a system switching request been issued to the CPU module? (Check 'Module number in the system switching request issued from the own system network module' (SD1645) of the control system CPU module.)	Check an error on the Ethernet-equipped module mounted on the control system CPU module, and correct the error.
In "Redundant System Settings" under "Application Settings", is "Enable" selected for "System Switching Request Issue at Communication Error"?	In "Redundant System Settings" under "Application Settings", select "Enable" for "System Switching Request Issue at Communication Error".
For "User Connection" or "System Connection" of "System Switching Request Issue at Communication Error" in "Redundant System Settings" under "Application Settings", is it specified that a system switching request is issued in the target connection?	For "User Connection" or "System Connection" of "System Switching Request Issue at Communication Error" in "Redundant System Settings" under "Application Settings", specify that a system switching request is issued in the target connection.
Do the settings of the engineering tool and the buffer memory details match?	Write the set parameters to the CPU module, and reset the CPU module or power off and on the system.
Has a cable disconnection been detected?	Check that there is no error in the external device.
In "Redundant System Settings" under "Application Settings", is "Enable" selected for "System Switching Request Issuing at Disconnection Detection"?	In "Redundant System Settings" under "Application Settings", select "Enable" for "System Switching Request Issuing at Disconnection Detection".
In "Redundant System Settings" under "Application Settings", is the value set for "Disconnection Detection Monitoring Time" correct?	In "Redundant System Settings" under "Application Settings", correct the value set for "Disconnection Detection Monitoring Time".
In "Timer Settings for Data Communication" under "Application Settings", is the value set for "TCP ULP Timer" correct?	In "Timer Settings for Data Communication" under "Application Settings", correct the value set for "TCP ULP Timer".
In "External Device Configuration" under "Basic Settings", is "Existence Confirmation" set to "KeepAlive"?	In "External Device Configuration" under "Basic Settings", set "Existence Confirmation" to "KeepAlive".
In "Timer Settings for Data Communication" under "Application Settings", is the value set for "Destination Alive Check Start Interval Timer" correct?	In "Timer Settings for Data Communication" under "Application Settings", correct the value set for "Destination Alive Check Start Interval Timer".
In "Timer Settings for Data Communication" under "Application Settings", is the value set for "Destination Alive Check Interval Timer" correct?	In "Timer Settings for Data Communication" under "Application Settings", correct the value set for "Destination Alive Check Interval Timer".
In "External Device Configuration" under "Basic Settings", is "Communication Method" set to "Broadcast Send"?	In "External Device Configuration" under "Basic Settings", set "Communication Method" to an option other than "Broadcast Send", and set "IP Address" in "Sensor/Device".
Has the connection with the external device been opened? (Check 'Open completion signal' (Un\G1900000 to Un\G1900007).)*1*2	<ul style="list-style-type: none"> • If the connection with the external device is not opened, perform the open processing. • If an error occurs, check and eliminate the error cause.
For configuration using the redundant module group setting, are settings made for "Redundant Module Group Setting" in the [I/O Assignment] tab of the "System Parameter" window?	Correct the settings for "Redundant Module Group Setting" in the [I/O Assignment] tab of the "System Parameter" window.
For configuration using the port group setting, are settings made for "Port Group Setting" in "Redundant System Settings" under "Application Settings"?	In "Redundant System Settings" under "Application Settings", correct the settings for "Port Group Setting".

*1 The buffer memory address is for when the network type of the RJ71EN71 is set to "Ethernet" and the P1 connector is used. When using the P2 connector or the CPU module (built-in Ethernet port part), or setting the network type to "Q Compatible Ethernet", refer to the following.

 Page 473 Buffer Memory

*2 If the connection of only the external device is closed due to cable disconnection, personal computer restart, or other reasons, reopen the connection using the same port used before the error occurred. The E71 does not close a connection if it receives an Active open request again from the external device with a different IP address or a port number.

Communication fails at OPS connection.

When communication using the redundant system function is not possible at the time of an OPS connection, check the following items and take action.

Check item	Action
In "External Device Configuration" under "Basic Settings", is "OPS Connection Module" set for the external device?	Correct the settings for "External Device Configuration" under "Basic Settings".
In "External Device Configuration" under "Basic Settings", is the port number setting correct?	
In "External Device Configuration" under "Basic Settings", is the external device IP address setting correct?	

3.5 List of Error Codes

This section lists the error codes, error details and causes, and action for the errors occur in the processing for data communication between the Ethernet-equipped module and slave stations or caused by processing requests from the CPU module on the own station.

Error codes are classified into major error, moderate error, and minor error, and can be checked in the [Error Information] tab in the "Module Diagnostics" window of an Ethernet-equipped module. (🖱️ Page 413 Error Information)

Error code	Error details and causes	Action	Detailed information
1080H	The number of writes to the flash ROM has exceeded 100000.	Replace the module.	—
1120H	Clock setting has failed when the system is powered on or the CPU module is reset.	<ul style="list-style-type: none"> • Check if the time settings are correctly set in parameter. • Check if the specified SNTP server is operating normally and there is no failure on the network accessing to the SNTP server computer. 	—
1124H	<ul style="list-style-type: none"> • The default gateway is not set correctly. • The gateway IP address is not set correctly. • The default gateway/gateway IP address (network address after the subnet mask) is different from that of the IP address of the own node. 	<ul style="list-style-type: none"> • Correct the default gateway IP address. • Set the same network address as that of the IP address. 	Parameter information <ul style="list-style-type: none"> • Parameter type • I/O No. • Parameter No. • Network No. • Station No.
1128H	The port number is incorrect.	Correct the port number.	—
1129H	The port number of the external device is not set correctly.	Correct the port number of the external device.	—
112CH	The request using all stations specification has failed.	Try the request using current station specification.	—
112DH	The data was sent to the external device while the IP address setting of the device set in "External Device Configuration" under "Basic Settings" was incorrect.	<ul style="list-style-type: none"> • Correct the IP address of the external device in "External Device Configuration" under "Basic Settings". • Check that the IP address class of the external device is set to A/B/C in "External Device Configuration" under "Basic Settings". 	—
112EH	A connection could not be established in the open processing.	<ul style="list-style-type: none"> • Check the operation of the external device. • Check if the open processing has been performed in the external device. • Correct the port number of the Ethernet-equipped module, IP address/port number of the external device, and opening method. • When the firewall is set in the external device, check if the access is permitted. • Check if the Ethernet cable is disconnected. 	—
1133H	The response send failed during socket communications or communications using the fixed buffer.	<ul style="list-style-type: none"> • Check the operation of the external device or switching hub. • Since there may be congestion of packets on the line, send data after a certain period of time. • Check if the connection cable is disconnected. • Check that there is no connection failure with the switching hub. • Execute the communication status test, and if the test was completed with an error, take the corrective action. • Execute the module communication test, and check that there is no failure in the module. 	—
1134H	A TCP ULP timeout error has occurred in the TCP/IP communication. (The external device does not send an ACK response.)	<ul style="list-style-type: none"> • Check the operation of the external device. • Correct the TCP ULP timeout value of the Ethernet-equipped module. • Since there may be congestion of packets on the line, send data after a certain period of time. • Check if the connection cable is disconnected. 	—
1152H	<ul style="list-style-type: none"> • The IP address is not set correctly. • The same IP address has been set to port 1 and port 2 of the Ethernet-equipped module. 	<ul style="list-style-type: none"> • Correct the IP addresses. • Set different IP addresses for port 1 and port 2. 	Parameter information <ul style="list-style-type: none"> • Parameter type • I/O No. • Parameter No. • Network No. • Station No.

Error code	Error details and causes	Action	Detailed information
1155H	<ul style="list-style-type: none"> The specified connection was already closed in TCP/IP communications. Open processing is not performed. 	<ul style="list-style-type: none"> Perform the open processing for the specified connection. Check if the open processing has been performed in the external device. 	—
1157H	<ul style="list-style-type: none"> The specified connection was already closed in UDP/IP communications. Open processing is not performed. 	<ul style="list-style-type: none"> Perform the open processing for the specified connection. Check if the open processing has been performed in the external device. 	—
1158H	<ul style="list-style-type: none"> The receive buffer or send buffer is not sufficient. The window size of the external device is not sufficient. 	<ul style="list-style-type: none"> Check the operation of the external device or switching hub. When communications using a fixed buffer or socket communications is used, increase the execution frequency of the BUFRCV/SOCRCV instruction. When the value of 'State of receive buffer' (Un\G1900030) is 0001H, reduce the frequency of data receive from the external device. 	—
1165H	Data was not sent correctly with UDP/IP.	<ul style="list-style-type: none"> Check the settings for connection with the external device. Check the operation of the external device or switching hub. Since there may be congestion of packets on the line, send data after a certain period of time. Check if the connection cable is disconnected. Check that there is no connection failure with the switching hub. Execute the PING test and communication status test, and if the test was completed with an error, take the corrective action. 	—
1166H	Data was not sent correctly with TCP/IP.	<ul style="list-style-type: none"> Check the settings for connection with the external device. Check the operation of the external device or switching hub. Since there may be congestion of packets on the line, send data after a certain period of time. Check if the connection cable is disconnected. Check that there is no connection failure with the switching hub. Execute the PING test and communication status test, and if the test was completed with an error, take the corrective action. The close request may have been received from the external device when the data was sent. Check whether "TCP Status" of the corresponding connection number is set to "Disconnected" with the Ethernet diagnostics of the engineering tool. 	—
1167H	Unsent data found, but could not be sent.	<ul style="list-style-type: none"> Check the settings for connection with the external device. Check the operation of the external device or switching hub. Since there may be congestion of packets on the line, send data after a certain period of time. Check if the connection cable is disconnected. Check that there is no connection failure with the switching hub. Execute the PING test and communication status test, and if the test was completed with an error, take the corrective action. 	—
1180H	<ul style="list-style-type: none"> The same IP address has been set as the system A IP address, system B IP address, and/or control system IP address. Network addresses of the system A IP address, system B IP address, and control system IP address are different. 	<ul style="list-style-type: none"> Set different IP addresses for the system A IP address, system B IP address, and control system IP address. Set the same network address for the system A IP address, system B IP address, and control system IP address. 	Parameter information <ul style="list-style-type: none"> Parameter type I/O No. Parameter No. Network No. Station No.

Error code	Error details and causes	Action	Detailed information
1801H	IP address of the external device could not be acquired.	<ul style="list-style-type: none"> Correct the IP address in "Network/Station No. <-> IP information setting" under "Application Settings". Check if the network or station number of the external device is correctly specified by using control data of the dedicated instruction. 	Parameter information <ul style="list-style-type: none"> Parameter type I/O No. Parameter No. Network No. Station No.
1811H	An error was detected in the CPU module.	Check the error of the CPU module and take action using the module diagnostics of the engineering tool.	—
1830H	Number of reception requests of transient transmission (link dedicated instruction) exceeded upper limit of simultaneously processable requests.	Lower the transient transmission usage frequency, and then perform again.	—
1845H	Too many processings of transient transmission (link dedicated instruction) and cannot perform transient transmission.	Correct the transient transmission execution count.	—
1F07H	An error occurs in the protocol data set in "Simple Device Communication Setting".	<ul style="list-style-type: none"> From "Communication Destination Setting" under "Simple Device Communication Setting", correct the setting details of "Protocol Setting". If the error occurs again even after taking the above actions, the possible cause is a hardware failure of the error module. Please consult your local Mitsubishi representative. 	Packet error information <ul style="list-style-type: none"> Setting No. Protocol No. Packet type Element No.
20E0H	The module cannot communicate with the CPU module.	The hardware failure of the CPU module may have been occurred. Please consult your local Mitsubishi representative.	—
2160H	Overlapping IP addresses were detected.	Check and correct the IP addresses.	—
2220H	<ul style="list-style-type: none"> A network module having the firmware version not supporting the simple CPU communication function is used. The number of simple CPU communication settings is 65 or more. The parameter setting is corrupted. 	<ul style="list-style-type: none"> Use a network module having the firmware version that supports 512 simple CPU communication settings. Set the simple CPU communication setting within the range from No.1 to No.64. Check the detailed information of the error by executing module diagnostics using the engineering tool, and write the displayed parameter. If the error occurs again even after taking the above, the possible cause is a hardware failure of the module. Please consult your local Mitsubishi representative. 	Parameter information <ul style="list-style-type: none"> Parameter type
2221H	The set value is out of the range.	Check the detailed information (parameter information) of the error by executing module diagnostics using the engineering tool, and correct the parameter setting corresponding to the displayed number (parameter number). If the same error code is displayed again, the possible cause is a hardware failure of the data memory of the CPU module, a memory card, the I/O module, or intelligent function module. Please consult your local Mitsubishi representative.	Parameter information <ul style="list-style-type: none"> Parameter type I/O No. Parameter No. Network No. Station No.
2250H	The protocol setting data stored in the CPU module is not for the Ethernet-equipped module.	Write the protocol setting data for the Ethernet-equipped module to the CPU module.	Parameter information <ul style="list-style-type: none"> Parameter type
24C0H to 24C3H	An error was detected on the system bus.	<ul style="list-style-type: none"> Take measures to reduce noise. Reset the CPU module, and run it again. If the error occurs again even after taking the above, the possible cause is a hardware failure of the module, base unit, or extension cable. Please consult your local Mitsubishi representative. 	System configuration information <ul style="list-style-type: none"> I/O No. Base No. Slot No. CPU No.
24C6H	An error was detected on the system bus.	<ul style="list-style-type: none"> Take measures to reduce noise. Reset the CPU module, and run it again. If the error occurs again even after taking the above, the possible cause is a hardware failure of the module, base unit, or extension cable. Please consult your local Mitsubishi representative. 	—
3008H	In the redundant system with redundant extension base unit, a module name other than "RJ71EN71(E+E)" and "RJ71EN71(Q)" is set on the extension base.	When mounting a module on the extension base unit in the redundant system with redundant extension base unit, select "RJ71EN71(E+E)" or "RJ71EN71(Q)" for the module name in the "Add New Module" window.	Parameter information <ul style="list-style-type: none"> Parameter type I/O No. Parameter No. Network No. Station No.

Error code	Error details and causes	Action	Detailed information
3019H	<ul style="list-style-type: none"> When mounting a module on the main base unit in the redundant system, "Not Use" is set to "To Use or Not to Use Redundant System Settings" under "Application Settings". When mounting a module on the extension base unit in the redundant system with redundant extension base unit, "Use" is set to "To Use or Not to Use Redundant System Settings" under "Application Settings". 	<ul style="list-style-type: none"> When mounting a module on the main base unit in the redundant system, set "Use" to "To Use or Not to Use Redundant System Settings" under "Application Settings". When installing a module to the extension base unit in the redundant system with redundant extension base unit, set "Not Use" to "To Use or Not to Use Redundant System Settings" under "Application Settings". 	Parameter information <ul style="list-style-type: none"> Parameter type
301AH	When mounting a module on the extension base unit in the redundant system with redundant extension base unit, "Enable" is set to "Dynamic Routing" under "Application Settings".	When mounting a module on the extension base unit in the redundant system with redundant extension base unit, Set "Disable" to "Dynamic Routing" under "Application Settings".	Parameter information <ul style="list-style-type: none"> Parameter type
301BH	When mounting a module on the extension base unit in the redundant system with redundant extension base unit, "Use" is set to "IP Packet Transfer Function" under "Application Settings".	When mounting a module on the extension base unit in the redundant system with redundant extension base unit, set "Not Use" to "IP Packet Transfer Function" under "Application Settings".	Parameter information <ul style="list-style-type: none"> Parameter type
301CH	<ul style="list-style-type: none"> Incorrect protocol data is set in "Simple Device Communication Setting". A packet used is not supported by the current firmware version. 	<ul style="list-style-type: none"> From "Communication Destination Setting" under "Simple Device Communication Setting", correct the setting details of "Protocol Setting". Update the firmware. If the error occurs again even after taking the above actions, the possible cause is a hardware failure of the error module. Please consult your local Mitsubishi representative. 	<ul style="list-style-type: none"> ■Detailed information 1 Parameter information • Parameter type ■Detailed information 2 Packet error information • Setting No. • Protocol No. • Packet type • Element No.
301DH	A function used is not supported by the current firmware version.	Update the firmware.	<ul style="list-style-type: none"> ■Detailed information 1 Parameter information • Parameter type ■Detailed information 2 Packet error information • Setting No. • Protocol No. • Packet type
301EH	The "Resource Setting" is incorrectly set in "Simple Device Communication Setting" of the port 1 or port 2.	<ul style="list-style-type: none"> To select "Extension 1" in "Resource Setting", set "To Use or Not Use Simple Device Communication" of the other ports to "Not Use". To select "Normal" in "Resource Setting", set "Resource Setting" of the other ports to "Normal" or set "To Use or Not Use Simple Device Communication" to "Not Use". 	Parameter information <ul style="list-style-type: none"> Parameter type
3020H	A value of the port number is out of range.	<ul style="list-style-type: none"> Check the each system port number registered in the buffer memory. If the error occurs again even after taking the above, the possible cause is a hardware failure of the error module. Please consult your local Mitsubishi representative. 	—
3022H	The total number of external devices and communication destinations set using parameters exceeds 64.	Set the total number of external devices set in "External Device Configuration", communication destinations set in "Simple CPU Communication Setting", and communication destinations set in "Simple Device Communication Setting" within a range that does not exceed 64 per port.	—
3023H	"Port No. Host Station" set in "Simple Device Communication Setting" overlaps a value set for another function.	<ul style="list-style-type: none"> Change "Port No. Host Station" set in "Simple Device Communication Setting" to a value different from "PLC Port No." of "External Device Configuration". Change "Port No. Host Station" set in "Simple Device Communication Setting" to a value different from "Host Station Port No." of "Simple CPU Communication Setting". If "Port No. Host Station" of "Simple Device Communication Setting" is set within a range of 61440 to 65534, set within a range of 1024 to 4999 or 5010 to 61439. 	Packet error information <ul style="list-style-type: none"> Setting No.

Error code	Error details and causes	Action	Detailed information
3040H	Response data of the dedicated instruction cannot be created.	<ul style="list-style-type: none"> • Increase the request interval. • Decrease the number of request nodes. • Wait for a response to the previous request before sending the next request. • Correct the timeout value. 	—
3060H	The send/receive data size exceeds the allowable range.	<ul style="list-style-type: none"> • Check and change the send data size of the Ethernet-equipped module or the external device. • If the same error code is displayed again, the possible cause is a hardware failure of the error module or CPU module. Please consult your local Mitsubishi representative. 	—
3C00H to 3C03H	A hardware failure has been detected.	<ul style="list-style-type: none"> • Take measures to reduce noise. • Reset the CPU module, and run it again. If the same error code is displayed again, the possible cause is a hardware failure of the error module. Please consult your local Mitsubishi representative. 	—
3C0FH to 3C11H	A hardware failure has been detected.	<ul style="list-style-type: none"> • Take measures to reduce noise. • Reset the CPU module, and run it again. If the same error code is displayed again, the possible cause is a hardware failure of the error module. Please consult your local Mitsubishi representative. 	—
3C13H	A hardware failure has been detected.	Reset the CPU module, and run it again. If the same error code is displayed again, the possible cause is a hardware failure of the error module. Please consult your local Mitsubishi representative.	—
3C14H	A hardware failure has been detected.	Reset the CPU module, and run it again. If the same error code is displayed again, the possible cause is a hardware failure of the error module or CPU module. Please consult your local Mitsubishi representative.	—
3C2FH	An error was detected in the memory.	Reset the CPU module, and run it again. If the same error code is displayed again, the possible cause is a hardware failure of the error module. Please consult your local Mitsubishi representative.	—
3E01H	Network type of the own station is unexpected setting.	Rewrite the module parameter using the engineering tool. If the same error code is displayed again, the possible cause is a hardware failure of the error module. Please consult your local Mitsubishi representative.	—
4000H to 4FFFH	Errors detected by the CPU module (MELSEC iQ-R CPU Module User's Manual (Application))		
C001H	<ul style="list-style-type: none"> • The IP address setting value of the E71 for the initial processing is incorrect. • The setting value of the subnet mask field for the router relay function is incorrect. 	<ul style="list-style-type: none"> • Correct the IP address setting value for the initial processing. • Check if the class of the IP address is set to A/B/C. • Correct the subnet mask setting value for the initial processing. 	—
C012H	The port number used in a connection already opened is set. (For TCP/IP)	Correct the port numbers of the Ethernet-equipped module and the external device.	—
C013H	The port number used in a connection already opened is set. (For UDP/IP)	Correct the port numbers of the Ethernet-equipped module and the external device.	—
C015H	<ul style="list-style-type: none"> • The specified IP address of the external device for the open processing is incorrect. • The specified IP address of the external device of the dedicated instruction is incorrect. 	<ul style="list-style-type: none"> • Correct the specified IP address of the external device of the CONOPEN/OPEN instruction. Set the class to A/B/C. • Execute the dedicated instruction again after correcting the specified IP address of the external device. 	—
C016H	The open processing of the connection specified for pairing open has been already completed.	<ul style="list-style-type: none"> • Check that none of the connections targeted for pairing open has been opened. • Correct the combination of modules set for pairing open. 	—
C018H	The specified IP address of the external device is incorrect.	Correct the specified IP address of the external device.	—
C020H	The send/receive data length exceeds the allowable range.	<ul style="list-style-type: none"> • Correct the data length to be sent. • When the amount of data to be sent exceeds the limit, divide the data into smaller chunks to send it. 	—

Error code	Error details and causes	Action	Detailed information
C021H	An abnormal end response was received for communications using the fixed buffer and random access buffer.	<ul style="list-style-type: none"> • Check the command/response type of the subheader. • Check the data length setting to be sent. • Check if the communication data code setting of the Ethernet-equipped module meets the binary/ASCII of the message to be sent. 	—
C022H	<ul style="list-style-type: none"> • A response could not be received within the response monitoring timer value. • The connection with the external device was closed while waiting for a response. 	<ul style="list-style-type: none"> • Check the operation of the external device. • Correct the response monitoring timer value of the Ethernet-equipped module. • Check the open status of the connection with the external device. 	—
C024H	<ul style="list-style-type: none"> • Communications using the fixed buffer or communications using a random access buffer were executed when communication method is set to the "Predefined Protocol" connection. • Predefined protocol was executed when communication method is set to "Fixed Buffer (Procedure Exist)" or "Fixed Buffer (No Procedure)" connection. 	<ul style="list-style-type: none"> • Check that there is no error in the connection number specification of the dedicated instruction. • Correct the communication method of the connection with the external device. 	—
C025H	There is an error in the usage setting area when starting the open processing by the CONOPEN/OPEN instruction or I/O signals.	<ul style="list-style-type: none"> • When starting the open by using the CONOPEN/OPEN instruction, correct the usage setting area of the control data. • When starting the open by I/O signals, correct the connection usage setting area of the buffer memory. 	—
C026H	An error has occurred when reading/writing/verifying the predefined protocol setting data.	<ul style="list-style-type: none"> • Check that connection cable with the engineering tool is not disconnected and read/write/verify the predefined protocol setting data again. • Do not write data simultaneously when writing protocol setting data from multiple engineering tools. 	—
C027H	Message send of the socket communications has failed.	<ul style="list-style-type: none"> • Check the operation of the external device or switching hub. • Since there may be congestion of packets on the line, send data after a certain period of time. • Check if the connection cable is disconnected. • Check that there is no connection failure with the switching hub. • Execute the communication status test, and if the test was completed with an error, take the corrective action. • Execute the module communication test, and check that there is no failure in the module. • Check the IP address specified as the destination. 	—
C028H	Message send of the fixed buffer has failed.	<ul style="list-style-type: none"> • Check the operation of the external device or switching hub. • Since there may be congestion of packets on the line, send data after a certain period of time. • Check if the connection cable is disconnected. • Check that there is no connection failure with the switching hub. • Execute the communication status test, and if the test was completed with an error, take the corrective action. • Execute the module communication test, and check that there is no failure in the module. • Check the IP address specified as the destination. 	—
C029H	<ul style="list-style-type: none"> • Description of control data is not correct. • Open instruction was executed through open settings parameter even though parameters are not set. 	<ul style="list-style-type: none"> • Correct the descriptions of the control data. • Set the open settings parameters. Execute the OPEN instruction through control data. 	—
C035H	The existence of the external device could not be checked within the response monitoring timer value.	<ul style="list-style-type: none"> • Check the operation of the external device. • Correct the settings in "Timer Settings for Data Communication" under "Application Settings" of the Ethernet-equipped module. • Check if the connection cable is disconnected. 	—
C040H	<ul style="list-style-type: none"> • Not all the data could be received within the response monitoring timer value. • Sufficient data for the data length could not be received. • The remaining part of the message divided at the TCP/IP level could not be received within the response monitoring timer value. 	<ul style="list-style-type: none"> • Correct the data length of the communication data. • The packets may be crowded in the line, so send the data again from the external device after a random time has passed. 	—

Error code	Error details and causes	Action	Detailed information
C050H	When "ASCII" has been selected in the communication data code setting of the Ethernet-equipped module, ASCII code data which cannot be converted into binary code data has been received.	Check if ASCII code data which cannot be converted into binary code data has been sent from the external device.	—
C051H	<ul style="list-style-type: none"> The number of read/write points from/to the device of SLMP message is out of the allowable range in the CPU module (in units of words). The number of write points for the long counter of SLMP message is not in two-word units. 	Correct the number of read/write points and send the SLMP message to the Ethernet-equipped module again.	—
C052H	The number of read/write points from/to the device of SLMP message is out of the allowable range in the CPU module (in units of bits).	Correct the number of read/write points and send the SLMP message to the Ethernet-equipped module again.	—
C053H	The number of read/write points from/to the random device of SLMP message is out of the allowable range in the CPU module (in units of bits).	Correct the number of read/write points and send the SLMP message to the Ethernet-equipped module again.	—
C054H	The number of read/write points from/to the random device of SLMP message is out of the allowable range in the CPU module (in units of words, double words).	Correct the number of read/write points and send the SLMP message to the Ethernet-equipped module again.	—
C055H	The read/write size from/to the file data of SLMP message is out of the allowable range.	Correct the read/write size and send the SLMP message to the Ethernet-equipped module again.	—
C056H	The read/write request exceeds the largest address.	Correct the start address or the number of read/write points so that the request does not exceed the largest address and send the data to the Ethernet-equipped module again.	—
C057H	The request data length of the SLMP message does not match with the number of data in the character (a part of text).	Check and correct the text or request data length, and send the SLMP message to the Ethernet-equipped module again.	—
C058H	The request data length of the SLMP message after the ASCII/binary conversion does not match with the number of data in the character (a part of text).	Check and correct the text or request data length, and send the SLMP message to the Ethernet-equipped module again.	—
C059H	<ul style="list-style-type: none"> The specified command and subcommand of the SLMP message are incorrect The function which is not supported by the target device was executed. 	<ul style="list-style-type: none"> Check that there is no error in the specification of the command and subcommand of the SLMP message. Check whether the function executed is supported by the target device. Check the version of the target device. 	—
C05AH	The Ethernet-equipped module cannot read/write data from/to the device specified by the SLMP message.	Correct the specification of the device to be read/written and send the SLMP message to the Ethernet-equipped module again.	—
C05BH	The Ethernet-equipped module cannot read/write data from/to the device specified by the SLMP message.	Correct the specification of the device to be read/written and send the SLMP message to the Ethernet-equipped module again.	—
C05CH	<ul style="list-style-type: none"> The received request data of the SLMP message is incorrect. The setting value of the communication setting when the iQSS function is executed is out of range. When the iQSS function is executed, the items of communication setting which cannot be set on the target device are set. When the iQSS function is executed, the required setting items have not been set to the target device. 	<ul style="list-style-type: none"> Correct the request data and send the SLMP message to the Ethernet-equipped module again. Correct the setting details of when the iQSS function is executed, and retry the operation. 	—
C05DH	The "Monitor Request" command is received before the monitor registration is performed by "Monitor Registration/Clear" command of the SLMP message.	Register the monitoring data using "Monitor Registration/Clear" command and perform monitoring.	—

Error code	Error details and causes	Action	Detailed information
C05EH	<ul style="list-style-type: none"> The time between received the SLMP message from the Ethernet-equipped module and returned response from the access destination exceeded the monitoring timer value set in the SLMP command. An SLMP request message to which a command without a response message is specified is send to a module with the other network number as an access destination. 	<ul style="list-style-type: none"> Increase the monitoring timer value. Check if the access destination is operating normally. Correct the network number or request destination station number. When the access destination is a module with a different network number, check if "Routing Setting" of "CPU Parameter" is correctly set. If the access destination is a module with a different network number, check if the network number is not in use. If an SLMP request message to which a command without a response message is specified is send to a module with the other network number as an access destination, this error code is responded, which does not mean failure. 	—
C05FH	This request cannot be executed to the access destination specified by the SLMP message.	Correct the access destination.	—
C060H	The request details for bit devices of the SLMP message is incorrect.	Correct the request details and send the SLMP message to the Ethernet-equipped module again.	—
C061H	<ul style="list-style-type: none"> The request data length of the SLMP message does not match with the number of data in the character (a part of text). The write data length specified by the label write command is not even byte. When the iQSS function is executed, incorrect frame is received. 	<ul style="list-style-type: none"> Check and correct the text or request data length, and send the SLMP message to the Ethernet-equipped module again. Add the dummy data for one byte, and specify the length by even byte. Check the operating status and connection status of the target device of when the iQSS function is executed. Check the connection of an Ethernet cable and a hub of when the iQSS function is executed. Check the line status of Ethernet of when the iQSS function is executed. Reset the CPU module and device to be targets of the iQSS function, and retry the operation. <p>For the error occurred when the iQSS function is executed, contact the manufacturer of the target device if the above actions do not solve the problem.</p>	—
C070H	The device memory cannot be extended for the access destination specified by the SLMP message.	<ul style="list-style-type: none"> Correct the SLMP message to read/write data without the device memory set for extension. Specify the extension of the device memory only for an Ethernet-equipped module mounted station and an R/Q/QnACPU via CC-Link IE Controller Network, MELSECNET/H, or MELSECNET/10. 	—
C071H	The number of device points for data read/write set for modules other than an R/Q/QnACPU is out of the range.	Correct the number of read/write points and send the SLMP message to the Ethernet-equipped module again.	—
C072H	The request details of the SLMP message is incorrect. (For example, a request for data read/write in bit units has been issued to a word device.)	<ul style="list-style-type: none"> Check if the data can be requested to the access destination. Correct the request details and send the SLMP message to the Ethernet-equipped module again. 	—
C073H	The access destination of the SLMP message cannot issue this request. (For example, the number of double word access points cannot be specified for modules other than an R/Q/QnACPU.)	Correct the request details of the SLMP message.	—
C075H	The request data length for the label access is out of range.	<ul style="list-style-type: none"> Correct the number of array points and the number of read/write points, and send the SLMP message to the Ethernet-equipped module again. Correct the number of abbreviated label points and send the SLMP message to the Ethernet-equipped module again. Correct the label name length and send the SLMP message to the Ethernet-equipped module again. Correct the label to shorten the label name and send the SLMP message to the Ethernet-equipped module again. Correct the read/write data length and send the SLMP message to the Ethernet-equipped module again. 	—

Error code	Error details and causes	Action	Detailed information
C081H	The termination processing for the Ethernet-equipped module that is involved with the reinitialization processing is being performed, and arrival of link dedicated instructions cannot be checked.	Finish all the communications to perform the reinitialization processing of the Ethernet-equipped module.	—
C083H	The communication processing was abnormally ended in the link dedicated instruction communications	<ul style="list-style-type: none"> • Check if the relay station and external station are operating normally. • Check if there is an error with the cable connection between the own station and the external station. • If the line is heavily loaded, reduce the load, and retry the operation. • Increase the number of resends for the link dedicated instructions and execute the operation. 	—
C084H	The communication processing was abnormally ended in the link dedicated instruction communications	<ul style="list-style-type: none"> • Check if the own station/relay station/external station is operating normally. • Check if there is an error with the cable connection between the own station and the external station. • Increase the TCP resend timer value of the Ethernet-equipped module. 	—
C085H	The target station's channel specified by the link dedicated instruction SEND is currently in use.	Correct the target station's channel of the SEND instruction.	—
C0B2H	There is no sufficient space in the receive buffer or the send buffer of the relay station or external station for the MELSOFT connection, link dedicated instructions, or SLMP. (Send · receive buffer full error)	<ul style="list-style-type: none"> • Increase the request interval (execution interval) and execute the operation. • Do not access through one station using the MELSOFT connection, link dedicated instruction, or SLMP. • Wait for a response to the previous request before sending the next request. • Correct the set value for "Timer Settings for Data Communication" under "Application Settings" of the Ethernet-equipped module. 	—
C0B3H	A request that cannot be processed was issued from the CPU module.	<ul style="list-style-type: none"> • Correct the request details. • Correct the network number or request destination station number. 	—
C0B6H	The channel specified by the dedicated instruction is out of the range.	Correct the channel to a value within the allowable range of each dedicated instruction.	—
C0BAH	Since the close processing is in execution using the CONCLOSE/CLOSE instruction, a send request cannot be accepted.	Do not perform the send processing during the close processing.	—
C0C4H	The UINI instruction has been executed during communications.	Execute the UINI instruction after closing all connections.	—
C0D0H	The specified data length of the link dedicated instruction is incorrect.	Correct the data length.	—
C0D1H	The number of resends of the link dedicated instruction is incorrect.	Correct the number of resends.	—
C0D3H	The number of relay stations to communicate with other networks exceeds the allowable range.	<ul style="list-style-type: none"> • Check if the specification (network number/station number) for the communication destination is correct. • Check that number of relay stations accessing to the communication destination is 7 or less. • Correct the settings in the Network station number <-> IP information for the stations between the own station and the communication destination. 	—
C0D4H	The number of relay stations to communicate with other networks exceeds the allowable range.	<ul style="list-style-type: none"> • Check if the specification (network number/station number) for the communication destination is correct. • Check that number of relay stations accessing to the communication destination is 7 or less. • Correct the settings in the Network station number <-> IP information for the stations between the own station and the communication destination. 	—
C0D5H	The number of retries of the link dedicated instruction is incorrect.	Correct the number of retries.	—
C0D6H	The network number or station number of the link dedicated instruction is incorrect.	Check if the specification (network number/station number) for the communication destination is correct.	—
C0D7H	Data were sent without the initial processing completed.	After normal completion of the initial processing, perform the communications with the external device.	—

Error code	Error details and causes	Action	Detailed information
C0D8H	The number of specified blocks exceeded the range.	Correct the number of blocks.	—
C0D9H	The specified subcommand of the SLMP message is incorrect.	Correct the subcommand.	—
C0DAH	A response to the PING test could not be received within the time of the communication time check.	<ul style="list-style-type: none"> • Correct the IP address and host name of the target module where the PING test is executed. • Check that the initial processing of the Ethernet-equipped module where the PING test is executed is completed successfully. 	—
C0DBH	The IP address and host name of the target module where the PING test is execute are incorrect.	Correct the IP address and host name of the target module where the PING test is executed.	—
C0DEH	Data could not be received within the specified arrival monitoring time.	<ul style="list-style-type: none"> • Correct the specified arrival monitoring time. • Correct the channel of the link dedicated instruction. • Check if the sending station and relay station are operating normally. 	—
C101H	A response could not be received from the DNS server.	<ul style="list-style-type: none"> • Check the address of the DNS server. • Check that the data communications with the DNS server is possible by using the Ping command. • Check that the own station IP address and the DNS server IP address are in the same class. (If not, check the router setting.) 	—
C1A2H	<ul style="list-style-type: none"> • A response to the request could not be received. • In transient transmission, the number of relay to other networks exceeded seven. 	<ul style="list-style-type: none"> • Check and correct the response waiting time. • Change the system configuration so that the number of relay may be seven or less. • For the RECV instruction, execute again after correcting the channels used by own station in the control data. • For the RECV instruction, check that 'RECV execution request' (Un\G5301 b0 to b7) are on. • Check the operation of the external device. • Check if the external device supports the executed function. • If the request destination is on another network, check if the CPU module working as the relay station supports the routing setting, and take action. 	—
C1A4H	<ul style="list-style-type: none"> • Any of the specified command, subcommand, or request destination module I/O number of the SLMP message is incorrect. • The specified clear function set by the ERRCLEAR instruction is incorrect. • The specified information to be read set by the ERRRD instruction is incorrect. • The Ethernet diagnostics, CC-Link IE Field Network diagnostics, or CC-Link IE Controller Network diagnostics was tried to be used when the engineering tool is directly connected to the Ethernet port of the RJ71EN71. • The function which is not supported by the target device was executed. 	<ul style="list-style-type: none"> • Check that all of the specified command, subcommand, and request destination module I/O number of the SLMP message is correct. • Correct the specified value for the clear function set by the ERRCLEAR instruction. • Correct the specified value for the information to be read set by the ERRRD instruction. • Connect it directly to the CPU module (built-in Ethernet port part) or use a USB cable to use the Ethernet diagnostics, CC-Link IE Field Network diagnostics, or CC-Link IE Controller Network diagnostics. 	—
C1A5H	The specified target station or clear target is incorrect.	Correct the specified the target station or clear target.	—
C1A6H	The specified connection number is incorrect.	Correct the setting value of the connection number.	—
C1A7H	The specified network number is incorrect.	Correct the specified network number.	—
C1A8H	The specified station number is incorrect.	Correct the specified station number.	—
C1A9H	The specified device number is incorrect.	Correct the specified device number.	—
C1AAH	The specified device name is incorrect.	Correct the specified device name.	—
C1ACH	The specified number of resends is incorrect.	Correct the number of resends.	—
C1ADH	The specified data length is incorrect.	Correct the specified data length.	—
C1AFH	The specified port number is incorrect.	Correct the specified port number	—
C1B0H	The open processing of the specified connection has been already completed.	<ul style="list-style-type: none"> • Do not perform the open processing to a connection already opened. • When communications with the external device cannot be performed, perform the close processing before the open processing. 	—
C1B1H	The open processing of the specified connection has not been completed.	After completion of the open processing, perform the communication.	—

Error code	Error details and causes	Action	Detailed information
C1B2H	The open or close processing using CONOPEN/ CONCLOSE/OPEN/CLOSE instruction is being executed in the specified connection.	Execute again after the CONOPEN/CONCLOSE/OPEN/ CLOSE instruction is completed.	—
C1B3H	Another send or receive instruction is being executed in the specified channel.	<ul style="list-style-type: none"> • Change the channel number. • Execute again after the send or receive instruction is completed. 	—
C1B4H	The specified arrival monitoring time is incorrect.	Set the arrival monitoring time to a value within the allowable range.	—
C1B8H	The RECV instruction was executed for the channel that had not received data.	<ul style="list-style-type: none"> • Correct the execution condition of the RECV instruction for the channel that had received data. • Correct the specified channel of the RECV instruction. 	—
C1B9H	The CONOPEN/OPEN instruction cannot be executed for the specified connection.	Correct the specified connection.	—
C1BAH	The dedicated instruction was executed with the initialization not completed.	Execute the dedicated instruction after the initial processing is completed.	—
C1BBH	The target station CPU type of the link dedicated instruction is incorrect.	Correct the specified target station CPU type.	—
C1BCH	The target network number of the link dedicated instruction is incorrect.	<ul style="list-style-type: none"> • Execute the link dedicated instruction again after correcting the network number. • When specifying another network station, check if the settings in "Routing Setting" of "CPU Parameter" are made correctly. 	—
C1BDH	The target station number of the link dedicated instruction is incorrect.	<ul style="list-style-type: none"> • Execute the link dedicated instruction again after correcting the target station number. • When specifying another network station, check if the settings in "Routing Setting" of "CPU Parameter" are made correctly. 	—
C1BEH	The command code of the dedicated instruction is incorrect.	<ul style="list-style-type: none"> • Execute again after correcting the command code at the request source. • If the request source is on another network, check if the routing parameters are set correctly, and take action. 	—
C1BFH	The channel used in the dedicated instruction is incorrect.	<ul style="list-style-type: none"> • Execute again after correcting the used channel within the allowable range at the request source. • If the request source is on another network, check if the routing parameters are set correctly, and take action. 	—
C1C0H	The transient data is incorrect.	<ul style="list-style-type: none"> • Correct the transient data at the request source, and retry the operation. • If the error occurs again even after taking the above, please consult your local Mitsubishi representative. 	—
C1C1H	The transient data is incorrect.	<ul style="list-style-type: none"> • Correct the transient data at the request source, and retry the operation. • If the error occurs again even after taking the above, please consult your local Mitsubishi representative. 	—
C1C2H	When the dedicated instruction was executed, data was received twice.	<ul style="list-style-type: none"> • Check the network status and take corrective action using the Ethernet diagnostics of the engineering tool. • Check if the switching hub and the cables at the request source are connected properly. • If the request source is on another network, check if the routing parameters are set correctly, and take action. 	—
C1C4H	The arrival check of the link dedicated instruction was completed with an error.	<ul style="list-style-type: none"> • Execute link dedicated instruction again after changing the execution type in the control data to "No arrival acknowledgment". • For the REQ instruction, execute again after correcting request type. 	—
C1C5H	A dedicated instruction which the target station does not support was executed.	<ul style="list-style-type: none"> • Change the target station at the station that executed the SEND instruction. • If the error occurs again even after taking the above, please consult your local Mitsubishi representative. 	—

Error code	Error details and causes	Action	Detailed information
C1C6H	The execution or error completion type of the dedicated instruction is incorrect.	<ul style="list-style-type: none"> Execute again after correcting the execution/error completion type in the control data. If the problem cannot be resolved with the above actions, the possible cause is a hardware failure of the module. Please consult your local Mitsubishi representative. 	—
C1C7H	The request type of the REQ instruction is incorrect.	<ul style="list-style-type: none"> Execute again after correcting the request type of the REQ instruction. If the problem cannot be resolved with the above actions, the possible cause is a hardware failure of the module. Please consult your local Mitsubishi representative. 	—
C1C8H	The channel specified in the dedicated instruction is in use.	Change the channels used by own station or the target station's channel in the control data.	—
C1C9H	The device specification for the ZNRD/ZNWR instruction is not correct.	<ul style="list-style-type: none"> Execute again after correcting the device specification for the ZNRD/ZNWR instruction. If the problem cannot be resolved with the above actions, the possible cause is a hardware failure of the module. Please consult your local Mitsubishi representative. 	—
C1CAH	The device specification for the ZNRD/ZNWR instruction is not correct.	<ul style="list-style-type: none"> Execute again after correcting the device specification for the ZNRD/ZNWR instruction. If the problem cannot be resolved with the above actions, the possible cause is a hardware failure of the module. Please consult your local Mitsubishi representative. 	—
C1CBH	The transient data is incorrect.	<ul style="list-style-type: none"> Correct the transient data at the request source, and retry the operation. If the error occurs again even after taking the above, please consult your local Mitsubishi representative. 	—
C1CCH	A response of the data length that exceeds the allowable range was received by the SLMPSND instruction.	<ul style="list-style-type: none"> Execute again after correcting the request data to be within the range. If the error occurs again even after taking the above, please consult your local Mitsubishi representative. 	—
C1CDH	Message send of the SLMPSND instruction has failed.	<ul style="list-style-type: none"> Check the operation of the external device or switching hub. Since there may be congestion of packets on the line, send data after a certain period of time. Check if the connection cable is disconnected. Check that there is no connection failure with the switching hub. Execute the communication status test, and if the test was completed with an error, take the corrective action. Execute the module communication test, and check that there is no failure in the module. Check the IP address specified as the destination. Change "Use" in "SLMPSND Instruction Settings" under "Application settings" of the module for which the SLMPSND instruction was executed, and retry the operation. 	—
C1D0H	The requested module I/O No. of the dedicated instruction is incorrect.	<ul style="list-style-type: none"> Execute again after correcting the requested module I/O No. at the request source of the dedicated instruction. If the error occurs again even after taking the above, please consult your local Mitsubishi representative. 	—
C1D2H	The target station IP address of the link dedicated instruction is incorrect.	Execute the link dedicated instruction again after correcting the IP address.	—
C1D3H	The dedicated instruction not supported by the communication method of the connection was executed.	<ul style="list-style-type: none"> Check that the dedicated instruction can be executed by the specified communication method. Correct the program when the instruction cannot be executed. Check that there is no error in the connection specification of the dedicated instruction. 	—
C200H	The remote password is incorrect.	Correct the remote password, and unlock/lock the remote password again.	—
C201H	The remote password status of the port used for communications is in the lock status.	After unlocking the remote password, perform communications.	—

Error code	Error details and causes	Action	Detailed information
C202H	When another station was accessed, the remote password could not be unlocked.	When accessing another station, do not set the remote password on the relay station or access station, or do not execute the remote password check on them.	—
C203H	An error has occurred by checking the remote password.	Correct the remote password, and unlock/lock the remote password again.	—
C204H	The device is different from the one requesting the remote password unlock processing.	Request the lock processing of the remote password from the external device that requested the unlock processing of the remote password.	—
C205H	When another station was accessed, the remote password could not be unlocked.	When accessing another station, do not set the remote password on the relay station or access station, or do not execute the remote password check on them.	—
C207H	The file name has too many characters.	Name the file with 255 characters or less.	—
C208H	The password length is out of range.	Set the password within 6 to 32 characters.	—
C400H	The ECPRTCL instruction was executed when Predefined protocol ready is not completed.	<ul style="list-style-type: none"> Execute the ECPRTCL instruction after Predefined protocol ready has turned on. Execute the ECPRTCL instruction after rewriting the protocol setting data to the Ethernet-equipped module. If the error occurs again even after taking the above, the possible cause is a hardware failure of the module. Please consult your local Mitsubishi representative. 	—
C401H	The protocol number specified by the ECPRTCL instruction is not registered in the Ethernet-equipped module.	<ul style="list-style-type: none"> Correct the specified protocol number and execute the instruction again. Register the protocol specified protocol number to the Ethernet-equipped module. 	—
C402H	An error has occurred in the protocol setting data registered in the Ethernet-equipped module and the ECPRTCL instruction cannot be executed.	Correct the protocol setting data and register it again.	—
C403H	Multiple dedicated instructions was executed simultaneously.	<ul style="list-style-type: none"> Do not execute the dedicated instructions which do not support simultaneous execution. Correct the specified connection number and execute the dedicated instruction again. 	—
C404H	The protocol being executed by the ECPRTCL instruction was canceled.	Check the canceled protocol in the control data of the ECPRTCL instruction (execution count result) and eliminate the cause of the cancellation.	—
C405H	The protocol number specified by the ECPRTCL instruction is incorrect.	Correct the specified protocol number.	—
C406H	The continuous protocol execution count of the ECPRTCL instruction is incorrect.	Correct the continuous protocol execution count.	—
C407H	The connection number specified by the ECPRTCL instruction is incorrect.	<ul style="list-style-type: none"> Correct the specified connection number and execute the protocol again. Correct the specified connection number in "External Device Configuration" under "Basic Settings" of the Ethernet-equipped module and execute the protocol again. 	—
C408H	An error has occurred when the send processing of the predefined protocol using the ECPRTCL instruction was performed.	<ul style="list-style-type: none"> Check the operation of the external device or switching hub. Since there may be congestion of packets on the line, send data after a certain period of time. Check if the connection cable is disconnected. Check that there is no connection failure with the switching hub. Execute the communication status test, and if the test was completed with an error, take the corrective action. Execute the module communication test, and check that there is no failure in the module. 	—

Error code	Error details and causes	Action	Detailed information
C410H	Receive waiting time of the ECPRTCL instruction timed out.	<ul style="list-style-type: none"> • Check if the cable is disconnected. • Correct the specified connection number in "External Device Configuration" under "Basic Settings" of the Ethernet-equipped module and execute the protocol again. • Check that there is no error in the external device. • Check that the sending from the external device is not interrupted. • Check that there is no data lost due to a receive error. • Check that there is no error in the data (packet) sent by the external device. 	—
C412H	The data which cannot be converted from ASCII to binary code was received.	<ul style="list-style-type: none"> • Check that there is no data lost due to a receive error. • Check that there is no error in the data (packet) sent by the external device. 	—
C413H	The number of digits of the received data using the predefined protocol is not sufficient.	<ul style="list-style-type: none"> • Check that there is no data lost due to a receive error. • Check that there is no error in the data (packet) sent by the external device. 	—
C414H	The number of digits of the received data using the predefined protocol is incorrect.	<ul style="list-style-type: none"> • Check that there is no data lost due to a receive error. • Check that there is no error in the data (packet) sent by the external device. 	—
C417H	The data length or data quantity of the received data using the predefined protocol is out of range.	<ul style="list-style-type: none"> • Check the maximum allowable data length and specify the maximum length or less in the data length storage area. • Check the maximum allowable data quantity, and specify the maximum quantity or less in the data quantity storage area. 	—
C420H	Protocol setting data write has failed.	<ul style="list-style-type: none"> • Write the data again. • If the error occurs again even after taking the above, the possible cause is a hardware failure of the specified module. Please consult your local Mitsubishi representative. 	—
C421H	Writing was requested to the module whose flash ROM write count had exceeded the limit.	Replace the module because the number of writes exceeded the limit.	—
C430H	Protocol setting data was written during the ECPRTCL instruction execution.	Do not write the protocol setting data during the ECPRTCL instruction execution.	—
C431H	Close processing of the connection was performed during the ECPRTCL instruction execution.	<ul style="list-style-type: none"> • Check the operation of the external device. • Check the connection open status with the external device. • Open the connection with the external device again and execute the instruction. 	—
C440H to C44FH	A communication error has occurred with an engineering tool when executing the Ethernet diagnostics.	<ul style="list-style-type: none"> • Execute the communication status test, and if the test was completed with an error, take the corrective action. • Execute the module communication test, and check that there is no failure in the module. 	—
C610H to C613H	The module processing was completed with an error.	<ul style="list-style-type: none"> • Execute the communication status test, and if the test was completed with an error, take the corrective action. • Execute the module communication test, and check that there is no failure in the module. 	—
C614H	The module processing was completed with an error.	<ul style="list-style-type: none"> • Correct the setting value of "Response Monitoring Timer" under "FTP Server Settings" because writing files may require a longer time. • Execute the communication status test, and if the test was completed with an error, take the corrective action. • Execute the module communication test, and check that there is no failure in the module. 	—
C615H	The module processing was completed with an error.	<ul style="list-style-type: none"> • Execute the communication status test, and if the test was completed with an error, take the corrective action. • Execute the module communication test, and check that there is no failure in the module. 	—

Error code	Error details and causes	Action	Detailed information
C616H	Connection of the control port to the FTP server failed.	<ul style="list-style-type: none"> • Correct the IP address setting of the Ethernet-equipped module. • Correct the FTP server setting. • Check connection with the FTP server. • Disconnect the user session on the FTP server. • Data communications may not be ready. Wait for a while and perform the operation again. • Correct the TCP ULP timeout value because connecting to the FTP server may require a longer time. 	—
C617H	Disconnection of the control port to the FTP server failed.	<ul style="list-style-type: none"> • Correct the FTP server setting. • Check connection with the FTP server. 	—
C618H	Login to the FTP server failed.	<ul style="list-style-type: none"> • Correct the FTP server setting (login user name and login password). • Check the FTP server software settings (login user name and login password). • Check the data communication history of the FTP server software. 	—
C619H	Execution of the FTP command to the FTP server failed.	<ul style="list-style-type: none"> • Correct the FTP server setting (folder path and connection method). • Check that the user has a right to access (read/write) the FTP server or the specified file. • Check that the specified folder path exists in the FTP server. • Check that the specified file exists in the FTP server. • Correct the FTP server software settings. • Check the data communication history of the FTP server software. • Check that the file access is being performed in the FTP server. 	—
C620H	Connection of the data transfer port to the FTP server failed.	<ul style="list-style-type: none"> • Check connection with the FTP server. • Correct the FTP server setting (connection method). • If a firewall is active or the proxy server is on the connection path, consult a network administrator about the settings. 	—
C621H	Disconnection of the data transfer port to the FTP server failed.	<ul style="list-style-type: none"> • Check connection with the FTP server. • Correct the FTP server setting (connection method). • If a firewall is active or the proxy server is on the connection path, consult a network administrator about the settings. 	—
C622H	An error has occurred during file transfer to the FTP server.	<ul style="list-style-type: none"> • Delete unnecessary files on the FTP server to increase free space. • Check connection with the FTP server. • The specified file may be used in the other process. Wait for a while and perform the operation again. • The Ethernet line may be congested. Wait for a while and perform the operation again. 	—
C623H	A response could not be received from the FTP server.	<ul style="list-style-type: none"> • Check that the FTP server name is registered in the DNS. • Change the FTP server name to the IP address, and check the operation. • Check that the data communications with the FTP server is possible by using the Ping command. 	—
C700H	The module processing was completed with an error.	<ul style="list-style-type: none"> • Execute the communication status test, and if the test was completed with an error, take the corrective action. • Execute the module communication test, and check that there is no failure in the module. 	—
C701H	The IP address (network number) setting is incorrect in communications using the IP packet transfer function.	Check the IP address (network number).	—
C702H	The IP address (station number) setting is incorrect in communications using the IP packet transfer function.	Check the IP addresses (station number).	—
C703H	The destination IP address (upper level) setting is incorrect in communications using the IP packet transfer function.	Check the destination IP address.	—

Error code	Error details and causes	Action	Detailed information
C704H	The destination IP address (lower level) setting is incorrect in communications using the IP packet transfer function.	Check the destination IP address.	—
C705H to C707H	The module processing was completed with an error.	<ul style="list-style-type: none"> Execute the communication status test, and if the test was completed with an error, take the corrective action. Execute the module communication test, and check that there is no failure in the module. 	—
C708H	When communicating with the IP packet transfer function, "IP Packet Transfer Function" is set as "Not Use" in "IP Packet Transfer Setting" under "Application Settings" of the Ethernet-equipped module connected with the Ethernet devices.	When communicating with the IP packet transfer function, set "IP Packet Transfer Function" as "Not Use" in "IP Packet Transfer Setting" under "Application Settings".	—
C709H	A communication error has occurred with MELSOFT direct connection.	<ul style="list-style-type: none"> Do not execute the specification of the direct connection when direct connection is not used. Do not power off the system or reset the CPU module, or remove the cable during the communications when direct connection is used. 	—
C810H	Remote password authentication has failed when required.	Set a correct password and perform password authentication again.	—
C811H	Remote password authentication has failed when required.	Set a correct password and perform password authentication again one minute later.	—
C812H	Remote password authentication has failed when required.	Set a correct password and perform password authentication again 5 minutes later.	—
C813H	Remote password authentication has failed when required.	Set a correct password and perform password authentication again 15 minutes later.	—
C814H	Remote password authentication has failed when required.	Set a correct password and perform password authentication again 60 minutes later.	—
C815H	Remote password authentication has failed when required.	Set a correct password and perform password authentication again 60 minutes later.	—
C816H	The security function was activated and remote password authentication cannot be performed.	Set a correct password and perform password authentication again after a certain period of time.	—
C840H	Number of transient request exceeded the upper limit of simultaneously processable requests.	<ul style="list-style-type: none"> Pause the transient transmission temporarily, and retry the operation. Lower the transient transmission usage frequency, and then perform again. 	—
C842H	The routing setting is not set to reach to the destination network number.	<ul style="list-style-type: none"> Execute the link dedicated instruction again after correcting the target network number and station number. When the dynamic routing is used, check that communication path to the destination network number is set. When the dynamic routing is not used, or a module of the series other than MELSEC iQ-R is included, retry the operation after correcting the settings in "Routing Setting" of "CPU Parameter". 	—
C843H	Link dedicated instruction that cannot be executed on the network type were executed.	Check the network type of the Ethernet-equipped module.	—
C844H	Incorrect frame is received. <ul style="list-style-type: none"> Unsupported pre-conversion protocol Unsupported frame type Application header variable part Application header HDS Application header RTP Read command not requiring response 	Correct the request data at the transient request source, and retry the operation.	—
C860H	The CPU response monitoring timer issued a timeout during MODBUS/TCP communications.	When the CPU module has an error, eliminate it.	—
C861H	A request message containing an unsupported function code was received during MODBUS/TCP communications.	Check the supported function code, and correct the request message issued on the master side.	—
C862H	A request message containing an unsupported sub-code was received during MODBUS/TCP communications.	Check the supported sub-code and correct the request message issued on the master side.	—

Error code	Error details and causes	Action	Detailed information
C863H	The MODBUS device assignment parameters have not been set for the MODBUS device specified in the received request message in MODBUS/TCP communications.	Set the MODBUS device assignment parameters for the MODBUS device specified in the request message.	—
C864H	The range of the MODBUS devices specified in the received request message exceeded the setting range of the MODBUS device assignment parameters in MODBUS/TCP communications.	Set the MODBUS device assignment parameters so that they include the range of the MODBUS devices specified in the request message.	—
C865H	The range of the MODBUS devices specified in the received request message exceeded the upper limit for the MODBUS devices in MODBUS/TCP communications. (The upper limit of extended file register is 10000 and the upper limit of the MODBUS device is 65536.)	Check the MODBUS devices specified on the master side that sent the request message.	—
C866H	The start address and the number of access points of the MODBUS device specified in the received request message are incorrect in MODBUS/TCP communications.	<ul style="list-style-type: none"> • Check if the specified value exceeds the maximum number of access points for the function. • Ensure that the number of access points is not 0. • When accessing a MODBUS device to which a long device is assigned in the MODBUS device assignment parameters, check that the start address and the number of access points are specified in units of two points. • When accessing a MODBUS device to which LTN or LSTN is assigned in the MODBUS device assignment parameters, check that the start address and the number of access points are specified in units of four points. 	—
C867H	The number of write points specified for the received request message does not match with the specified number of bytes in MODBUS/TCP communications.	Check the number of write points and the number of bytes specified on the master side that issued the request message.	—
C868H	The received write data size does not match with the specified number of bytes in MODBUS/TCP communications.	Check the write data size and the number of bytes specified on the master side that issued the request message.	—
C869H	The value of the reference type specified in the received request message (FC20, FC21) is incorrect in MODBUS/TCP communications.	Check the reference type specified on the master side that issued the request message.	—
C86AH	The content of the data part of the received request message is incorrect in MODBUS/TCP communications. The size of the received request message is smaller than the minimum size required for the function code, or larger than the maximum size required for the function code.	Check the data part of the request message on the master side that issued the message.	—
C86BH	The content of MBAP header of the received request message is incorrect in MODBUS/TCP communications.	Check the content of the request message on the master side that issued it.	—
C86CH	The number of received request messages exceeded the number that can be received simultaneously.	Wait for a while and retry sending on the master side that issued it. (The number of request messages that can be received simultaneously is 64 for each of PORT1 and PORT2.)	—
CEE0H	The devices supporting iQSS which were detected by the other peripheral device, or other iQSS functions were executed while the automatic detection of connected devices is in process.	Execute the other function after the automatic detection of connected devices is completed.	—
CEE1H	Incorrect frame is received.	<ul style="list-style-type: none"> • Check the operating status and connection status of the target device. • Check the connection of an Ethernet cable and a hub. • Check the line status of Ethernet. • Reset the CPU module and target device, and retry the operation. If the above actions do not solve the problem, contact the manufacturer of the target device.	—

Error code	Error details and causes	Action	Detailed information
CEE2H	Incorrect frame is received.	<ul style="list-style-type: none"> • Check the operating status and connection status of the target device. • Check the connection of an Ethernet cable and a hub. • Check the line status of Ethernet. • Reset the CPU module and target device, and retry the operation. <p>If the above actions do not solve the problem, contact the manufacturer of the target device.</p>	—
CF10H	Incorrect frame is received.	<ul style="list-style-type: none"> • Check the operating status and connection status of the target device. • Check the connection of an Ethernet cable and a hub. • Check the line status of Ethernet. • Reset the CPU module and target device, and retry the operation. <p>If the above actions do not solve the problem, contact the manufacturer of the target device.</p>	—
CF20H	<ul style="list-style-type: none"> • The setting value of the communication setting is out of range. • The items of communication setting which cannot be set on the target device are set. • The required setting items have not been set to the target device. 	Correct the setting details, and retry the operation.	—
CF30H	The parameter which is not supported by the target device was specified.	Check the version of the target device.	—
CF31H	Incorrect frame is received.	<ul style="list-style-type: none"> • Check the operating status and connection status of the target device. • Check the connection of an Ethernet cable and a hub. • Check the line status of Ethernet. • Reset the CPU module and target device, and retry the operation. <p>If the above actions do not solve the problem, contact the manufacturer of the target device.</p>	—
CF70H	An error occurred on the Ethernet communication path.	<ul style="list-style-type: none"> • Check the operation of the target device. • Check if the connection cable is disconnected. 	—
CF71H	A timeout error has occurred.	<ul style="list-style-type: none"> • Check the operation of the target device. Since there may be congestion of packets on the line, perform the operation after a while. • Correct the setting details of when the iQSS function is executed, and retry the operation. • Check the connection of an Ethernet cable and a hub. 	—
CF80H	During the simple device communication, communications with the communication destination cannot be executed. Or the external device is disconnected.	<ul style="list-style-type: none"> • Check if the connection cable is disconnected. • Check the line status with the communication destination such as a cable, hub, and router. • Correct the IP address and Ethernet address of the communication destination. • Check if the communication destination has the ARP function, and communicate with a communication destination that has the ARP function. 	—
CF81H	During the simple device communication, the communication has failed due to a communication timeout.	<ul style="list-style-type: none"> • Check the operation of the communication destination. • Check the line status with the communication destination such as a cable, hub, and router. • Correct the communication timeout period. • Correct the setting of the relevant setting number for the Ethernet-equipped module, and execute the protocol again. • Check if the communication destination has the ARP function, and communicate with a communication destination that has the ARP function. 	—
CF82H	During the simple device communication, the "Send/Receive Data Length Storage Area" or "Send/Receive Data Count Storage Area" value in "Non-conversion Variable (variable length)" or "Conversion Variable (variable length)" of "Variable Number of Data" set for the send packet exceeds the range that can be set.	Check that the value set in "Send/Receive Data Length Storage Area" or "Send/Receive Data Count Storage Area" or "Send/Receive Data Count Storage Area" is equal to or below "Data Length/Maximum Data Length" or "Number of Data/Maximum Number of Data" set in "Element Setting".	—

Error code	Error details and causes	Action	Detailed information
CF83H	During the simple device communication, the data size of send data has been 0.	<ul style="list-style-type: none"> Correct the setting of the element for the send packet. When "Non-conversion Variable (variable length)" or "Conversion Variable (variable length)" of "Variable Number of Data" is used for the element, check that the value in "Send/Receive Data Length Storage Area" or "Send/Receive Data Count Storage Area" is not 0. 	—
CF84H	During the simple device communication, sending the send packet has failed.	<ul style="list-style-type: none"> When the communication setting is "Request", execute the protocol again after a while. When the communication setting is "Fixed Intrvl", extend the execution interval. 	—
CF8AH	During the simple device communication, the request to the CPU module has been failed.	<ul style="list-style-type: none"> Check and correct the monitoring time of the CPU Response Monitoring Timer. Correct "Device/Label Access Service Processing Setting" under "Service Processing Setting" of "CPU Parameter". 	—
CF85H	Data outside the range was set during simple device communication.	<p>When "Conversion Variable" is used for the element, check the following items.</p> <ul style="list-style-type: none"> If the conversion data type is "Word" or "Double Word", the number of digits is not "Variable Number of Digits", and also the number of decimal places is "Variable Point", check the numerical value data as well as the decimal point position value and configure settings so that the decimal point position does not exceed the numerical value data. Check that the value in the send data storage area is not outside the range of numerical values that can be used. The range of numerical values that can be used is shown below. <ul style="list-style-type: none"> ■When conversion is "HEX→ASCII Decimal" [Signed/Unsigned: "Unsigned"] <Single-precision real number> $0 \leq [\text{Single-precision real number data}] \leq 9999999$ <Double-precision real number> $0 \leq [\text{Double-precision real number data}] \leq 9999999999999999$ [Signed/Unsigned: Other than "Unsigned"] <Single-precision real number> $-9999999 \leq [\text{Single-precision real number data}] \leq 9999999$ <Double-precision real number> $-9999999999999999 \leq [\text{Double-precision real number data}] \leq 9999999999999999$ ■When conversion is "HEX→ASCII Hexadecimal" <Single-precision real number> 0H to FFFFFFFFH <Double-precision real number> 0H to FFFFFFFFFFFFFFFFH Check the send data storage area value, number of digits, as well as the setting for the number of decimal places and set them so that the integer part remains after conversion. When the conversion data type is "Word" or "Double Word" and the number of decimal places is "Variable Point", check whether the correct value is stored at the decimal point position of the send/receive data storage area. 	—
CF8CH	During the simple device communication, the receive data does not match with any of the receive packets set using the parameter.	Check 'Verification mismatch protocol number' (Un\G1249317) and 'Verification mismatch information' (Un\G1249318 to Un\G1249333) and correct the setting details of the element.	—

Error code	Error details and causes	Action	Detailed information
CFB0H	Sending data failed due to a resend timeout while the simple CPU communication.	<ul style="list-style-type: none"> • Check the operation of the communication destination. • Check the line status with the communication destination such as a cable, hub, and router. • Check and correct the latency time. • Correct the IP address and Ethernet address of the communication destination. • Check if the communication destination has the ARP function, and communicate with a communication destination that has the ARP function. • When the communication destination is a MODBUS/TCP-compatible device and "Write" is set to "Communication Pattern", do not specify Input or Input Register for the transmission destination. • The type of the communication destination depends on the firmware version of the network module. Check the firmware version. (☞ Page 224 Restrictions applicable depending on versions) 	—
CFB1H	Communications with the communication destination do not executed while the simple CPU communication. Or the external device is disconnected.	<ul style="list-style-type: none"> • Check if the connection cable is disconnected. • Check the line status with the communication destination such as a cable, hub, and router. • Correct the IP address and Ethernet address of the communication destination. • Check if the communication destination has the ARP function, and communicate with a communication destination that has the ARP function. • The type of the communication destination depends on the firmware version of the network module. Check the firmware version. (☞ Page 224 Restrictions applicable depending on versions) 	—
CFB2H	The same specified own station port number is already used for the simple CPU communication.	<ul style="list-style-type: none"> • Correct the specified port number so that it is not duplicate. • It depends on the firmware version whether the network module can make multiple settings for the same communication destination. Check the firmware version of the network module. 	—
CFB3H	The request to the CPU module has failed while the simple CPU communication.	<ul style="list-style-type: none"> • Check and correct the monitoring time of the CPU Response Monitoring Timer. • Correct "Device/Label Access Service Processing Setting" under "Service Processing Setting" of "CPU Parameter". 	—
CFB4H	An abnormal response was received from the communication destination while the simple CPU communication.	Check the abnormal response code in the buffer memory.	—
CFB5H	The frame received from the communication destination is incorrect while the simple CPU communication.	<ul style="list-style-type: none"> • Check the operation of the communication destination. • Check the line status with the communication destination such as a cable, hub, and router. • When the communication destination is SIEMENS S7 series or SIEMENS S7 series (extension), check "Simple CPU Communication Setting" to see whether "Type", "Start", "End" of the specified device match with the assignment of the communication destination. 	—
CFBDH	The device specified as the communication destination is out of specification range for the simple CPU communication.	Correct the address of "Type", "Start", "End" of the device specified as the communication destination in "Simple CPU Communication Setting" under "Application settings".	—
CFBEH	A communication error has occurred with an engineering tool during the simple CPU communication diagnostics.	<ul style="list-style-type: none"> • Execute the communication status test, and if the test was completed with an error, take the corrective action. Execute the module communication test, and check that there is no failure in the module. 	—

Error code	Error details and causes	Action	Detailed information
CFBFH	The simple CPU communication cannot be executed.	<ul style="list-style-type: none">• When the communication destination is the MELSEC-Q (Ethernet module) or MELSEC-L (Ethernet module), set the network number and station number in "Own Node Settings" under "Basic Settings".• Take measures to reduce noise.• It depends on the firmware version of the network module whether the on-request communications is possible or not. Check the firmware version of the network module.• The type of the communication destination depends on the firmware version of the network module. Check the firmware version. (☞ Page 224 Restrictions applicable depending on versions)• If the same error code is displayed even after executing the simple CPU communication again, please consult your local Mitsubishi representative.	—

3.6 List of Parameter Numbers

This section lists the parameter numbers displayed in the module diagnostics.

System Parameter

Item	Parameter No.
Redundant Module Group Setting	0400H

Basic Settings

Item	Parameter No.		
Own Node Settings	Parameter Setting Method	7100H	
	IP Address	IP Address	A012H
		Subnet Mask	A012H
		Default Gateway	A013H
	Communications by Network No./Station No. (RJ71EN71 and RnENCPU (network part))	7100H	
	Communications by Network No./Station No. (CPU module (built-in Ethernet port part))	7A20H	
	Setting Method	7100H	
	Network Number	7100H	
	Station No.	7100H	
	Transient Transmission Group No.	A010H	
	Enable/Disable Online Change	A030H	
	Communication Data Code	A031H	
	Opening Method	A031H	
CC-Link IEF Basic Setting	Network Configuration Settings	7A00H	
	Refresh Settings	7420H	
External Device Configuration	A031H		
Transmission Port Settings (RJ71EN71 and RnENCPU (network part))	MELSOFT Transmission Port UDP/IP	A0E4H	
	MELSOFT Transmission Port TCP/IP		
	Auto-open UDP Port		
Transmission Port Settings (CPU module (built-in Ethernet port part))	MELSOFT Transmission Port UDP/IP	7A30H	
	MELSOFT Transmission Port TCP/IP		
	Auto-open UDP Port		

Application Settings

Item	Parameter No.	
Frame Settings	A036H	
Communication Speed	7100H	
FTP Server Settings	A037H	
FTP Client Settings	A03DH	
DNS Settings	A03EH	
Web Server Settings	A035H	
MODBUS/TCP Settings	To Use or Not to Use MODBUS/TCP Setting	A0B0H
	CPU Response Monitoring Timer	A0B0H
	Device Assignment	A0B2H
Simple CPU Communication Setting (RJ71EN71 and RnENCPU (network part))	A0E1H	
Simple CPU Communication Setting (CPU Module (built-in Ethernet port part))	7A10H	
Simple Device Communication Setting	A0E2H	
Time Setting	A039H	
Timer Settings for Data Communication	A038H	
Security	IP Filter Settings	A03AH
	Disable Direct Connection with MELSOFT	A034H
	Do Not Respond to CPU Module Search	A034H

Item	Parameter No.	
Gateway Parameter Settings	A013H	
Network/Station No. <-> IP information setting	A033H	
Interrupt Settings	Interrupt Occurrence Factor	A014H
	Channel No./Connection No.	A014H
	Detection Method	A014H
	Interrupt Pointer	A014H
	Comment	A015H
IP Packet Transfer Setting	A030H	
Network Dynamic Routing	A030H	
Module Operation Mode	7100H	
Redundant System Settings	System B IP Address	A03CH
	System B Station Number	7110H
	Use of Control System IP Address	A03CH
	Control System IP Address	A03CH
	System B Module Operation Mode	7110H
	Port Group Setting	A03CH
	System Switching Request Issuing at Disconnection Detection	A03CH
	Disconnection Detection Monitoring Time	A03CH
	System Switching Request Issue at Communication Error	A03CH
	User Connection	A03CH
System Connection	A03CH	
Built-in database access setting	A0E0H	
iQ Sensor Solution Settings	7A31H	
SLMPSND Instruction Settings		

3.7 Event List

This section lists the events occurs in Ethernet.

Event code	Event type	Description	Cause
00100	System	Link-up	Link-up has occurred when the network cable connected to the external device was connected.
00110		TCP connection communication start/end	Communication using the TCP connection with the external device was started or ended.
00120		FTP connection start/stop	FTP connection was started from the external device or disconnected.
00130		Receive frame error	<ul style="list-style-type: none"> Receive frame error was detected. The Ethernet-equipped module was connected to the CC-Link IE Controller Network or CC-Link IE Field Network.
00140		Time synchronization failure	No response was returned from the time information server (SNTP server) and time synchronization has failed.
00400		Restart by a program	The module was restarted by the program.
00800		Link-down	Link-down has occurred when network cable connected to the external device was disconnected.
00901		Data length error	The send/receive data length exceeds the allowable range.
00902		Initial processing error	Socket communications or communications using the fixed buffer were executed before the initial processing was completed.
00903		Specification IP address error	Broadcast address was specified to the IP address of the external device other than Unpassive.
00904		Socket communications transmission failed	Message send of the socket communications has failed.
00905		Not opened	<ul style="list-style-type: none"> The open processing of the external device has not been completed. The connection with the external device is closed.
00906		Alive check error	The existence of the external device could not be checked within the response monitoring timer value.
00907		Divided messages receive timeout error	<ul style="list-style-type: none"> Not all the data could be received within the response monitoring timer value. Sufficient data for the data length could not be received. The remaining part of the message divided at the TCP/IP level could not be received within the response monitoring timer value.
00908		IP assembly timeout error	An IP assembly timeout error has occurred. (The remaining part of the divided data could not be received and a timeout has occurred.)
00909		TCP specification port number error	The port number used in a connection already opened is set. (For TCP/IP)
0090A		UDP specification port number error	The port number used in a connection already opened is set. (For UDP/IP)
00A00		System switching request issued	A system switching request occurred.
00C02		Access abnormal response of another station	<ul style="list-style-type: none"> Abnormal response was returned from another station when accessing another station. Abnormal response was returned to another station when accessed from another station.
00D00		Fixed buffer response send failed	Response send of the communications using the fixed buffer has failed.
00D01		Pairing open error	The open processing of the connection specified for pairing open has been already completed.
00D02		End code error	An abnormal end response was received for communications using the fixed buffer and random access buffer.
00D03		Response monitoring timeout error	<ul style="list-style-type: none"> A response could not be received within the response monitoring timer value. The connection with the external device was closed while waiting for a response.
00D04		Fixed buffer send failed	Message send of the fixed buffer has failed.
00D05		Random access communication error	The parameter (start address and data word) of the data received by the random access communication is faulty.

Event code	Event type	Description	Cause
10200	Security	Remote password lock	The lock processing of the remote password was performed.
10201		Remote password unlock successful	The unlock processing of the remote password was succeeded.
10202		Remote password unlock failed	The unlock processing of the remote password has failed.
10300		Access from IP restricted with IP filter setting	Accessed from IP address restricted with the IP filter setting.
10500		Forced invalidation setting	Forced invalidation setting was executed.
10501		Forced invalidation cancel	Forced invalidation setting was canceled.
24E00	Operation	ERR LED off execution	The ERR LED has turned off using the output signal Y17 of the module.

3.8 End Codes Returned to an External Device During Data Communications

The following table lists the error codes stored in the end code appended to a response during data communications.

End code	Error details and causes	Action
00H	Normal completion	When each communication is normally completed, the error code 00H is stored.
02H	The device range destination of devices to be read/written from/to is incorrect.	Check and correct the specified start device and the number of points.
50H	<ul style="list-style-type: none"> Codes for the command/response type of a subheader are not within the specifications. In communications using the fixed buffer, if the data length setting is smaller than the actual data amount, the remaining data is processed as the second data. In this case, a subheader undefined command type error may occur. 	<ul style="list-style-type: none"> Check and correct the command/response type set for the external device. (Because the Ethernet-equipped module automatically adds the command/response type, the user setting is not required.) Check and correct the data length.
51H	In communications using the random access buffer, the start address specified by an external device has been set outside the range from 0 to 6143.	Check and correct the specified start address.
52H	<ul style="list-style-type: none"> In communications using the random access buffer, the start address and the number of data words (depending on the setting when reading data) specified by an external device exceeds the range from 0 to 6143. Data by the number of words specified (text) cannot be sent in one frame. (The data length value or the amount of the text sent/received are not in the allowable range.) 	<ul style="list-style-type: none"> Check and correct the start address and the number of data words. Correct the number of read/write points.
54H	When "ASCII" has been selected for "Communication Data Code" in "Own Node Settings" under "Basic Settings" of the Ethernet-equipped module, ASCII code data which cannot be converted into binary code data has been sent from the external device.	Check and correct the data sent from the external device.
55H	<ul style="list-style-type: none"> When "Disable All (SLMP)" has been selected for "Enable/Disable Online Change" in "Own Node Settings" under "Basic Settings" of the Ethernet-equipped module, the external device requested a data write while the CPU module was running. While the CPU module was running, the external device requested for writing a parameter or program. 	<ul style="list-style-type: none"> Set "Enable All (SLMP)" for "Enable/Disable Online Change" in "Own Node Settings" under "Basic Settings" of the Ethernet-equipped module, and write data. (However, a parameter, program, or microcomputer program cannot be written while the CPU module is running.) Set the switch on the CPU module to STOP and write the data.
56H	The external device specified an incorrect device.	Correct the device specification.
57H	<ul style="list-style-type: none"> The number of points for a command specified by an external device exceeds the maximum number of processing points (number of processes that can be executed per communication) for each process. Addresses from the start address (start device number and start step number) to the specified number of points exceed the largest addresses (device number and step number) for each process. The byte length of a command is not within the range defined by the specifications. When data is written, the set number of write data points is different from the specified number of points. A monitor request was issued even though monitoring data is not registered. 	<ul style="list-style-type: none"> Correct the specified points or the start address (device number and step number). Check the data length of the command and set the data again. Register the monitoring data. Data cannot be read from/written to an area with an address after the last address. Correct the specified address. Correct the block number. In the block number specification of the extension file register, do not specify a block number exceeding the range of the corresponding memory cassette size.
58H	<ul style="list-style-type: none"> The start address (start device number and start step number) of a command specified by an external device has been set outside the range that can be specified. For data read/write in a microcomputer program or file register (R), values exceeding the CPU module parameter setting range has been specified. A block number specified for an extension file register does not exist. A file register cannot be specified. A word device has been specified for the command for bit devices. The start number of bit devices has been specified using a value other than a multiple of 16 in the command for word devices. 	<ul style="list-style-type: none"> Correct the value to the one within the range that can be specified for each process. Correct the block number. Correct the device specification. Correct the command or specified device.
59H	An extension file register cannot be specified.	Correct the device specification.
60H	The communication time between the CPU module and the Ethernet-equipped module exceeded the response monitoring timer value.	Increase the response monitoring timer value.

End code	Error details and causes	Action
63H	In communications using the fixed buffer, the remote password of the port for the destination Ethernet module is in the lock status.	<ul style="list-style-type: none"> • After unlocking the remote password using the SLMP, perform communications using the fixed buffer. • Exclude ports used for communications using the fixed buffer from the targets of the remote password check.
A0H	The request cannot be specified for the target connection.	<ul style="list-style-type: none"> • Correct the request details. • Correct the open settings.
A1H	The request details cannot be analyzed because the text part length or the request data length is short.	Correct the text part length or the header request data length, and send the request to the Ethernet-equipped module again.
A2H	The request cannot be processed.	Correct the request details and command.

APPENDICES

Appendix 1 Module Label

The I/O signals and buffer memory of the Ethernet-equipped module can be set using module label.

Structure of the module label

The module label name is defined with the following structure.

"Instance name"_"Module number"."Port number"."Label name"

"Instance name"_"Module number"."Label name"

"Instance name"_"Module number"."Port number"."Label name"_D

"Instance name"_"Module number"."Label name"_D

Ex.

EN71_EE_1.stPort1.wnVal_IP_Address_D[0]

■Instance name

The following are the instance names of the RJ71EN71 and the RnENCPU (network part) corresponding to each network type setting.

Model		Instance name
RJ71EN71	RnENCPU (network part)	
RJ71EN71 (E+E)	—	EN71_EE
RJ71EN71 (CCIEC)	_RJ71EN71(CCIEC)	EN71_C
RJ71EN71 (E+CCIEC)	_RJ71EN71(E+IEC)	EN71_EC
RJ71EN71 (CCIEF)	_RJ71EN71(CCIEF)	EN71_F
RJ71EN71 (E+CCIEF)	_RJ71EN71(E+IEF)	EN71_EF

■Module number

A sequential number starting with "1" for identifying a module from the one with the same instance name.

■Port number

The port number is added to the module labels corresponding the buffer memory areas other than P1/P2 common area.

The following lists the characters corresponding to the port numbers

Port number	Added characters
P1	stPort1
P2	stPort2

■Label name

A label name unique to the module.

■_D

This symbol indicates that the module label is for direct access. The label without "_D" is for refresh. The following are the differences between refresh and direct access.

Type	Description	Access timing
Refresh	The values read/written from/to the module labels are reflected to the module at refresh. The execution time of the program can be shortened.	At refresh
Direct access	The values read/written from/to the module labels are reflected to the module immediately. Although the execution time of the program is longer than the one at refresh, the responsiveness is improved.	At writing to or reading from the module label

Appendix 2 I/O Signals

This section describes the I/O signals of the RJ71EN71 and the RnENCPU (network part) for the CPU module. The I/O signal assignment of when the start I/O number of the RJ71EN71 or the RnENCPU (network part) is "0" is listed below.

List of I/O signals

The following table lists I/O signals. The device X is an input signal from the RJ71EN71 and the RnENCPU (network part) to the CPU module. The device Y is an output signal from the CPU module to the RJ71EN71 and the RnENCPU (network part). The I/O signals differ when the network type is Ethernet, and Q-compatible Ethernet.

When network type is "Ethernet"

■Input signals

Device number	Signal name
X0 ^{*1}	Module failure (On: Module failure, Off: Module normal)
X1 to XE	Use prohibited
XF	Module READY (On: Module operation possible, Off: Module operation not possible)
X10 to X1F	Use prohibited



*1 This signal enabled when the network type for the P2 connector is set to "CC-Link IE Field". For details on operation of the signal, refer to the following.

 MELSEC iQ-R CC-Link IE Field Network User's Manual (Application)

■Output signals

Device number	Signal name
Y0 to Y1F	Use prohibited

Point

- Do not use (turn on) any "use prohibited" signals as an input or output signal to the CPU module. Doing so may cause malfunction of the programmable controller system.
- For the I/O signals of the P2 connector when its network type is set to "CC-Link IE Control", refer to the following.
 MELSEC iQ-R CC-Link IE Controller Network User's Manual (Application)
- For the I/O signals of the P2 connector when its network type is set to "CC-Link IE Field", refer to the following.
 MELSEC iQ-R CC-Link IE Field Network User's Manual (Application)

A

When the network type is "Q Compatible Ethernet"

With the Q-compatible Ethernet, the same I/O signals as the MELSEC-Q series Ethernet interface module can be used except in some cases.

The following table lists the differences of the RJ71EN71 and MELSEC-Q series Ethernet interface modules.

Device number	RJ71EN71	QJ71E71-100
X1C	ERR LED lit confirmation*1 (On: Lit, Off: —)	COM.ERR. LED lit confirmation (On: Lit, Off: —)
Y17	ERR LED off request*2 (On: At off request, Off: —)	COM.ERR. LED off request (On: At off request, Off: —)
Y19	Use prohibited	Initial request signal (On: At request, Off: —)

*1 This signal turns on when the ERR LED or the P ERR LED of P1 is on or flashing.

*2 The details are listed below.

- The ERR LED and the P ERR LED of P1 turn off.
- An off request continues to be issued while this signal is on. (Does not light while on.)
- The event is registered in event history when off process is executed.
- This signal cannot be turned off during major error.
- If the error occurs again after turning on and off, the ERR LED or P ERR LED will turn on or flash according to the details of the error.
- Currently occurring error and error history information is not cleared.

For details on the other I/O signals, refer to the following.

 Q Corresponding Ethernet Interface Module User's Manual (Basic)

Point

Do not use (turn on) any "use prohibited" signals as an input or output signal to the CPU module. Doing so may cause malfunction of the programmable controller system.

Appendix 3 Buffer Memory

The buffer memory is used for the following applications.

Module	Application
RJ71EN71, RnENCPU (network part)	Exchanges data with the CPU module.
CPU module (built-in Ethernet port part)	Stores data such as the setting values for the Ethernet function and monitor values, and data used for exchanging data with the multiple CPU function.

Buffer memory values are reset to default when the CPU module is reset or the system is powered off.

List of buffer memory addresses

RJ71EN71, RnENCPU (network part)

The following table lists the buffer memory addresses of the RJ71EN71 and the RnENCPU (network part) when the network type is set to "Ethernet".

For the addresses of the RJ71EN71 when the network type is set to "Q Compatible Ethernet", refer to the following.

( Page 486 When using the RJ71EN71 (network type: Q-compatible Ethernet))

P1 address (P2 address ^{*1})		Application	Name
Decimal	Hexadecimal		
0 to 3 (2000000 to 2000003)	0H to 3H (1E8480H to 1E8483H)	System area	
4 to 5 (2000004 to 2000005)	4H to 5H (1E8484H to 1E8485H)	Own node setting status storage area	Own node IP address
6 to 13 (2000006 to 2000013)	6H to DH (1E8486H to 1E848DH)		System area
14 to 15 (2000014 to 2000015)	EH to FH (1E848EH to 1E848FH)		Subnet mask
16 to 17 (2000016 to 2000017)	10H to 11H (1E8490H to 1E8491H)		System area
18 to 19 (2000018 to 2000019)	12H to 13H (1E8492H to 1E8493H)		Default gateway IP address
20 to 27 (2000020 to 2000027)	14H to 1BH (1E8494H to 1E849BH)		System area
28 to 30 (2000028 to 2000030)	1CH to 1EH (1E849CH to 1E849EH)		Own node MAC address
31 (2000031)	1FH (1E849FH)		Own node network number
32 (2000032)	20H (1E84A0H)		Station number
33 (2000033)	21H (1E84A1H)		Transient transmission group number
34 (2000034)	22H (1E84A2H)		Send frame setting
35 (2000035)	23H (1E84A3H)		Jumbo frame setting
36 (2000036)	24H (1E84A4H)		Communication speed setting
37 (2000037)	25H (1E84A5H)		Auto-open UDP port number
38 (2000038)	26H (1E84A6H)		MELSOFT connection TCP port number
39 (2000039)	27H (1E84A7H)		MELSOFT connection UDP port number
40 (2000040)	28H (1E84A8H)	MELSOFT direct connection port number	
41 to 99 (2000041 to 2000099)	29H to 63H (1E84A9H to 1E84E3H)	System area	

P1 address (P2 address*1)		Application	Name		
Decimal	Hexadecimal				
100 to 163 (2000100 to 2000163)	64H to A3H (1E84E4H to 1E8523H)	Connection status storage area	Connection No.1 latest error code to Connection No.64 latest error code		
164 to 226 (2000164 to 2000226)	A4H to E2H (1E8524H to 1E8562H)	System area			
227 (2000227)	E3H (1E8563H)	Error log area	Number of errors		
228 (2000228)	E4H (1E8564H)		Error log write pointer		
229 (2000229)	E5H (1E8565H)		Error log block 1	Error code/end code	
230 (2000230)	E6H (1E8566H)			Subheader	
231 (2000231)	E7H (1E8567H)			Command code	
232 (2000232)	E8H (1E8568H)			Connection No.	
233 (2000233)	E9H (1E8569H)			Own station port number	
234, 235 (2000234, 2000235)	EAH, EBH (1E856AH, 1E856BH)			Communication destination IP address	
236 (2000236)	ECH (1E856CH)			Communication destination port No.	
237 (2000237)	EDH (1E856DH)			System area	
238 to 372 (2000238 to 2000372)	EEH to 174H (1E856EH to 1E85F4H)		Error log block 2 to 16	(Same as Error log block 1)	
373 to 999 (2000373 to 2000999)	175H to 3E7H (1E85F5H to 1E8867H)		System area		
1000 (2001000)	3E8H (1E8868H)		System port latest error code storage area	FTP server latest error code	
1001 (2001001)	3E9H (1E8869H)	MELSOFT direct connection latest error code			
1002 to 4999 (2001002 to 2004999)	3EAH to 1387H (1E886AH to 1E9807H)	System area			

P1 address (P2 address*1)		Application	Name	
Decimal	Hexadecimal			
5000 to 5001 (2005000 to 2005001)	1388H to 1389H (1E9808H to 1E9809H)	Status for each protocol	IP packet	Received packet total count
5002 to 5003 (2005002 to 2005003)	138AH to 138BH (1E980AH to 1E980BH)			Received packet checksum error discard count
5004 to 5005 (2005004 to 2005005)	138CH to 138DH (1E980CH to 1E980DH)			Sent packet total count
5006 to 5021 (2005006 to 2005021)	138EH to 139DH (1E980EH to 1E981DH)			System area
5022 to 5023 (2005022 to 2005023)	139EH to 139FH (1E981EH to 1E981FH)			Simultaneous transmission error detection count (receive buffer full count)
5024 to 5028 (2005024 to 2005028)	13A0H to 13A4H (1E9820H to 1E9824H)			System area
5029 (2005029)	13A5H (1E9825H)			Receive abort count
5030 to 5039 (2005030 to 2005039)	13A6H to 13AFH (1E9826H to 1E982FH)		System area	
5040 to 5041 (2005040 to 2005041)	13B0H to 13B1H (1E9830H to 1E9831H)		ICMP packet	Received packet total count
5042 to 5043 (2005042 to 2005043)	13B2H to 13B3H (1E9832H to 1E9833H)			Received packet checksum error discard count
5044 to 5045 (2005044 to 2005045)	13B4H to 13B5H (1E9834H to 1E9835H)			Sent packet total count
5046 to 5047 (2005046 to 2005047)	13B6H to 13B7H (1E9836H to 1E9837H)			Received echo request total count
5048 to 5049 (2005048 to 2005049)	13B8H to 13B9H (1E9838H to 1E9839H)			Sent echo reply total count
5050 to 5051 (2005050 to 2005051)	13BAH to 13BBH (1E983AH to 1E983BH)			Sent echo request total count
5052 to 5053 (2005052 to 2005053)	13BCH to 13BDH (1E983CH to 1E983DH)			Received echo reply total count
5054 to 5079 (2005054 to 2005079)	13BEH to 13D7H (1E983EH to 1E9857H)			System area
5080 to 5081 (2005080 to 2005081)	13D8H to 13D9H (1E9858H to 1E9859H)		TCP packet	Received packet total count
5082 to 5083 (2005082 to 2005083)	13DAH to 13DBH (1E985AH to 1E985BH)			Received packet checksum error discard count
5084 to 5085 (2005084 to 2005085)	13DCH to 13DDH (1E985CH to 1E985DH)			Sent packet total count
5086 to 5119 (2005086 to 2005119)	13DEH to 13FFH (1E985EH to 1E987FH)		System area	
5120 to 5121 (2005120 to 2005121)	1400H to 1401H (1E9880H to 1E9881H)	UDP packet	Received packet total count	
5122 to 5123 (2005122 to 2005123)	1402H to 1403H (1E9882H to 1E9883H)		Received packet checksum error discard count	
5124 to 5125 (2005124 to 2005125)	1404H to 1405H (1E9884H to 1E9885H)		Sent packet total count	
5126 to 5159 (2005126 to 2005159)	1406H to 1427H (1E9886H to 1E98A7H)	System area		
5160 to 5161 (2005160 to 2005161)	1428H to 1429H (1E98A8H to 1E98A9H)	Status for each protocol	Receiving error	Framing error count
5162 to 5163 (2005162 to 2005163)	142AH to 142BH (1E98AAH to 1E98ABH)			Receive FIFO overflow count
5164 to 5165 (2005164 to 2005165)	142CH to 142DH (1E98ACH to 1E98ADH)			CRC error count
5166 to 5188 (2005166 to 2005188)	142EH to 1444H (1E98AEH to 1E98C4H)		System area	



P1 address (P2 address*1)		Application	Name		
Decimal	Hexadecimal				
5189 (2005189)	1445H (1E98C5H)	Own node operation status storage area	LED status		
5190 (2005190)	1446H (1E98C6H)		System area		
5191 (2005191)	1447H (1E98C7H)		Hub connection status area	Communication mode	
5192 (2005192)	1448H (1E98C8H)			Connection status	
5193 (2005193)	1449H (1E98C9H)			Communication speed	
5194 (2005194)	144AH (1E98CAH)			Disconnection count	
5195 to 5199 (2005195 to 2005199)	144BH to 144FH (1E98CBH to 1E98CFH)		System area		
5200 (2005200)	1450H (1E98D0H)		IP address duplication status storage area	Same IP address detection flag	
5201 to 5203 (2005201 to 2005203)	1451H to 1453H (1E98D1H to 1E98D3H)			MAC address of the station already connected to the network	
5204 to 5206 (2005204 to 2005206)	1454H to 1456H (1E98D4H to 1E98D6H)			MAC address of the station with the IP address already used	
5207 to 5300 (2005207 to 2005300)	1457H to 14B4H (1E98D7H to 1E9934H)	System area			
5301 (2005301)	14B5H (1E9935H)	Area for sending/receiving instructions	RECV instruction execution request		
5302 to 5322 (2005302 to 2005322)	14B6H to 14CAH (1E9936H to 1E994AH)		System area		
5323 (2005323)	14CBH (1E994BH)		Link dedicated instruction	ZNRD instruction execution result	
5324 (2005324)	14CCH (1E994CH)			System area	
5325 (2005325)	14CDH (1E994DH)			ZNWR instruction execution result	
5326 to 5625 (2005326 to 2005625)	14CEH to 15F9H (1E994EH to 1E9A79H)	System area			
5626 (2005626)	15FAH (1E9A7AH)	Remote password lock status storage area	Remote password lock status (connection No.1 to 16)		
5627 (2005627)	15FBH (1E9A7BH)		Remote password lock status (connection No.17 to 32)		
5628 (2005628)	15FCH (1E9A7CH)		Remote password lock status (connection No.33 to 48)		
5629 (2005629)	15FDH (1E9A7DH)		Remote password lock status (connection No.49 to 64)		
5630 (2005630)	15FEH (1E9A7EH)		Remote password lock status system port		
5631 to 5645 (2005631 to 2005645)	15FFH to 160DH (1E9A7FH to 1E9A8DH)	System area			
5646 (2005646)	160EH (1E9A8EH)	Forced connection invalidation setting area	Forced connection invalidation (connection No.1 to 16)		
5647 (2005647)	160FH (1E9A8FH)		Forced connection invalidation (connection No.17 to 32)		
5648 (2005648)	1610H (1E9A90H)		Forced connection invalidation (connection No.33 to 48)		
5649 (2005649)	1611H (1E9A91H)		Forced connection invalidation (connection No.49 to 64)		
5650 (2005650)	1612H (1E9A92H)		Forced connection invalidation system port		
5651 to 8299 (2005651 to 2008299)	1613H to 206BH (1E9A93H to 1EA4EBH)	System area			

P1 address (P2 address*1)		Application	Name	
Decimal	Hexadecimal			
8300 (2008300)	206CH (1EA4ECH)	Predefined protocol support function execution status check area	Connection No.1	Protocol execution status
8301 (2008301)	206DH (1EA4EDH)			System area
8302 to 8317 (2008302 to 2008317)	206EH to 207DH (1EA4EEH to 1EA4FDH)			Received data verification result (receive packet No.1 to 16)
8318 (2008318)	207EH (1EA4FEH)			Protocol execution count
8319 (2008319)	207FH (1EA4FFH)			Protocol cancellation specification
8320 to 8335 (2008320 to 2008335)	2080H to 208FH (1EA500H to 1EA50FH)			System area
8336 to 8875 (2008336 to 2008875)	2090H to 22ABH (1EA510H to 1EA72BH)		Connection No.2 to Connection No.16	
8876 to 10999 (2008876 to 2010999)	22ACH to 2AF7H (1EA72CH to 1EAF77H)	System area		
11000 (2011000)	2AF8H (1EAF78H)	Time setting function (SNTP) area	Time setting function operation result	
11001 (2011001)	2AF9H (1EAF79H)		Time setting function execution time	(Year)
11002 (2011002)	2FAFH (1EAF7AH)			(Month)
11003 (2011003)	2AFBH (1EAF7BH)			(Day)
11004 (2011004)	2AFCH (1EAF7CH)			(Hour)
11005 (2011005)	2AFDH (1EAF7DH)			(Minute)
11006 (2011006)	2AFEH (1EAF7EH)			(Second)
11007 (2011007)	2AFFH (1EAF7FH)			(Day of the week)
11008 (2011008)	2B00H (1EAF80H)		Time setting function required response time	
11009 (2011009)	2B01H (1EAF81H)		Time setting function (SNTP client) execution	
11010 to 11049 (2011010 to 2011049)	2B02H to 2B29H (1EAF82H to 1EAF99H)	System area		
11050 to 11051 (2011050 to 2011051)	2B2AH to 2B2BH (1EAFAAH to 1EAFABH)	IP packet transfer function area	IP packet transfer latest data volume	
11052 to 11053 (2011052 to 2011053)	2B2CH to 2B2DH (1EAFACH to 1EAFADH)		IP packet transfer maximum data volume	
11054 to 11499 (2011054 to 2011499)	2B2EH to 2CEBH (1EAFAEH to 1EB16BH)	System area		
11500 to 11514 (2011500 to 2011514)	2CECH to 2CFAH (1EB16CH to 1EB17AH)	Dynamic routing function area	Communication path determination status	
11515 to 11599 (2011515 to 2011599)	2CFBH to 2D4FH (1EB17BH to 1EB1CFH)	System area		
11600 to 11663 (2011600 to 2011663)	2D50H to 2D8FH (1EB1D0H to 1EB20FH)	Remote password function monitoring area	Connection No.1 continuous unlock failure count to Connection No.64 continuous unlock failure count	
11664 (2011664)	2D90H (1EB210H)		Auto-open UDP port continuous unlock failure count	
11665 (2011665)	2D91H (1EB211H)		MELSOFT transmission port (UDP/IP) continuous unlock failure count	
11666 (2011666)	2D92H (1EB212H)		MELSOFT transmission port (TCP/IP) continuous unlock failure count	
11667 (2011667)	2D93H (1EB213H)		FTP transmission port (TCP/IP) continuous unlock failure count	
11668 (2011668)	2D94H (1EB214H)		MELSOFT direct connection continuous unlock failure count	



P1 address (P2 address*1)		Application	Name		
Decimal	Hexadecimal				
11669 (2011669)	2D95H (1EB215H)	System area			
11670 to 11671 (2011670 to 2011671)	2D96H to 2D97H (1EB216H to 1EB217H)	Area for both systems identical IP address setting function	Control system IP address		
11672 to 11699 (2011672 to 2011699)	2D98H to 2DB3H (1EB218H to 1EB233H)	System area			
11700 to 11701 (2011700 to 2011701)	2DB4H to 2DB5H (1EB234H to 1EB235H)	IP address change function area	IP Address	IP address	
11702 to 11703 (2011702 to 2011703)	2DB6H to 2DB7H (1EB236H to 1EB237H)			Subnet mask	
11704 to 11705 (2011704 to 2011705)	2DB8H to 2DB9H (1EB238H to 1EB239H)			Default Gateway	
11706 (2011706)	2DBAH (1EB23AH)		Communications by Network No./ Station No.	Network number	
11707 (2011707)	2DBBH (1EB23BH)			Station number	
11708 (2011708)	2DBCH (1EB23CH)			Transient transmission group number	
11709 (2011709)	2DBDH (1EB23DH)		IP address storage area write request		
11710 (2011710)	2DBEH (1EB23EH)		IP address storage area write error		
11711 (2011711)	2DBFH (1EB23FH)		IP address storage area writing error cause		
11712 (2011712)	2DC0H (1EB240H)		IP address storage area clear request		
11713 (2011713)	2DC1H (1EB241H)		IP address storage area clear error		
11714 (2011714)	2DC2H (1EB242H)		IP address storage area clear error cause		
11715 (2011715)	2DC3H (1EB243H)		IP address change function operating status		
11716 to 19999 (2011716 to 2019999)	2DC4H to 4E1FH (1EB244H to 1ED29FH)		System area		
20000 to 26143 (2020000 to 2026143)	4E20H to 661FH (1ED2A0H to 1EEA9FH)	Random access buffer area	Random access buffer		
26144 to 65534 (2026144 to 2065534)	6620H to FFFE H (1EEAA0H to 1F847EH)	System area			
65535 (2065535)	FFFFH (1F847FH)	Network type information area	Network type information		
65536 (2065536)	10000H (1F8480H)	Area for communication using a fixed buffer	Fixed buffer No.1	Data length	
65537 to 70655 (2065537 to 2070655)	10001H to 113FFH (1F8481H to 1F987FH)			Fixed buffer data	
70656 to 147455 (2070656 to 2147455)	11400H to 23FFFH (1F9880H to 20C47FH)		Fixed buffer No.2 to Fixed buffer No.16	(The bit configuration is the same as Fixed buffer No.1)	
147456 to 720895 (2147456 to 2720895)	24000H to AFFFFH (20C480H to 29847FH)	System area			

P1 address (P2 address*1)		Application	Name		
Decimal	Hexadecimal				
720896 (2720896)	B0000H (298480H)	Error log area for MODBUS/TCP function	Number of errors		
720897 (2720897)	B0001H (298481H)		Error log write pointer		
720898 (2720898)	B0002H (298482H)		Error log 1	Detail error code	
720899 (2720899)	B0003H (298483H)			Abnormal response code	
720900 (2720900)	B0004H (298484H)			Function code	
720901 (2720901)	B0005H (298485H)			Own station port number	
720902 to 720903 (2720902 to 2720903)	B0006H to B0007H (298486H to 298487H)			Destination IP address	
720904 (2720904)	B0008H (298488H)			Destination port number	
720905 (2720905)	B0009H (298489H)		System area		
720906 to 721153 (2720906 to 2721153)	B000AH to B0101H (29848AH to 298581H)		Error log 2 to Error log 32	(Same as Error log 1)	
721154 to 721895 (2721154 to 2721895)	B0102H to B03E7H (298582H to 298867H)	System area			
721896 to 721899 (2721896 to 2721899)	B03E8H to B03EBH (298868H to 29886BH)	Simple CPU communication area	Request to start communication at request for each setting number		
721900 to 721903 (2721900 to 2721903)	B03ECH to B03EFH (29886CH to 29886FH)		Request to stop fixed interval communication for each setting number		
721904 to 721907 (2721904 to 2721907)	B03F0H to B03F3H (298870H to 298873H)		Request to restart fixed interval communication for each setting number		
721908 to 721911 (2721908 to 2721911)	B03F4H to B03F7H (298874H to 298877H)		Execution status flag for each setting number		
721912 to 721915 (2721912 to 2721915)	B03F8H to B03FBH (298878H to 29887BH)		Preparation completion for each setting number		
721916 to 721935 (2721916 to 2721935)	B03FCH to B040FH (29887CH to 29888FH)		System area		
721936 to 721999 (2721936 to 2721999)	B0410H to B044FH (298890H to 2988CFH)		Simple CPU communication status for each setting number		
722000 to 722063 (2722000 to 2722063)	B0450H to B048FH (2988D0H to 29890FH)		Simple CPU communication error code for each setting number		
722064 to 722127 (2722064 to 2722127)	B0490H to B04CFH (298910H to 29894FH)		Abnormal response code for each setting number		
722128 to 722191 (2722128 to 2722191)	B04D0H to B050FH (298950H to 29898FH)		Execution interval (current value) for each setting number		
722192 to 722499 (2722192 to 2722499)	B0510H to B0643H (298990H to 298AC3H)	System area			
722500 to 1246787 (2722500 to 3246787)	B0644H to 130643H (298AC4H to 318AC3H)	Simple CPU communication area/ Simple device communication area	User setting area		

P1 address (P2 address*1)		Application	Name
Decimal	Hexadecimal		
1246788 to 1247299 (3246788 to 3247299)	130644H to 130843H (318AC4H to 318CC3H)	Simple CPU communication area	System area
1247300 to 1247327 (3247300 to 3247327)	130844H to 130859H (318CC4H to 318CDFH)		Request to start communication at request for each setting number
1247328 to 1247355 (3247328 to 3247355)	130860H to 13087BH (318CE0H to 318CFBH)		Request to stop fixed interval communication for each setting number
1247356 to 1247383 (3247356 to 3247383)	13087CH to 130897H (318CFCH to 318D17H)		Request to restart fixed interval communication for each setting number
1247384 to 1247411 (3247384 to 3247411)	130898H to 1308B3H (318D18H to 318D33H)		Execution status flag for each setting number
1247412 to 1247439 (3247412 to 3247439)	1308B4H to 1308CFH (318D34H to 318D4FH)		Preparation completion for each setting number
1247440 to 1247459 (3247440 to 3247459)	1308D0H to 1308E3H (318D50H to 318D63H)		System area
1247460 to 1247907 (3247460 to 3247907)	1308E4H to 130AA3H (318D64H to 318F23H)		Simple CPU communication status for each setting number
1247908 to 1248355 (3247908 to 3248355)	130AA4H to 130C63H (318F24H to 3190E3H)		Simple CPU communication error code for each setting number
1248356 to 1248803 (3248356 to 3248803)	130C64H to 130E23H (3190E4H to 3192A3H)		Abnormal response code for each setting number
1248804 to 1249251 (3248804 to 3249251)	130E24H to 130FE3H (3192A4H to 319463H)		Execution interval (current value) for each setting number
1249252 to 1249299 (3249252 to 3249299)	130FE4H to 131013H (319464H to 319493H)	System area	

P1 address (P2 address*1)		Application	Name		
Decimal	Hexadecimal				
1249300 (3249300)	131014H (319494H)	Simple device communication area	Function start/stop instruction		
1249301 (3249301)	131015H (319495H)		System area		
1249302 to 1249303 (3249302 to 3249303)	131016H to 131017H (319496H to 319497H)		Setting No.1	IP address	
1249304 (3249304)	131018H (319498H)			Port number	
1249305 (3249305)	131019H (319499H)			Protocol number of error	
1249306 (3249306)	13101AH (31949AH)			Error code for simple device communication	
1249307 (3249307)	13101BH (31949BH)			Error clear request	
1249308 (3249308)	13101CH (31949CH)			Ready	
1249309 (3249309)	13101DH (31949DH)			Status of connection	
1249310 to 1249311 (3249310 to 3249311)	13101EH to 13101FH (31949EH to 31949FH)			Number of successful completion	
1249312 to 1249313 (3249312 to 3249313)	131020H to 131021H (3194A0H to 3194A1H)			Number of error completion	
1249314 to 1249315 (3249314 to 3249315)	131022H to 131023H (3194A2H to 3194A3H)			Retry count	
1249316 (3249316)	131024H (3194A4H)			Protocol number currently executing	
1249317 (3249317)	131025H (3194A5H)			Verification mismatch protocol number	
1249318 to 1249333 (3249318 to 3249333)	131026H to 131035H (3194A6H to 3194B5H)			Verification mismatch information (receive packet numbers 1 to 16)	
1249334 to 1249347 (3249334 to 3249347)	131036H to 131043H (3194B6H to 3194C3H)			System area	
1249348 to 1249379 (3249348 to 3249379)	131044H to 131063H (3194C4H to 3194E3H)			Start request for each protocol	
1249380 to 1249411 (3249380 to 3249411)	131064H to 131083H (3194E4H to 319503H)			Execution completion for each protocol	
1249412 to 1249443 (3249412 to 3249443)	131084H to 1310A3H (319504H to 319523H)			Error for each protocol	
1249444 to 1249475 (3249444 to 3249475)	1310A4H to 1310C3H (319524H to 319543H)			Execution status for each protocol	
1249476 to 1249987 (3249476 to 3249987)	1310C4H to 1312C3H (319544H to 319743H)	Execution interval (current value) for each protocol			
1249988 to 1250499 (3249988 to 3250499)	1312C4H to 1314C3H (319744H to 319943H)	Execution interval (maximum value) for each protocol			
1250500 to 1325973 (3250500 to 3325973)	1314C4H to 143B95H (319944H to 32C015H)	Setting No.2 to 64	(Same as setting No.1)		
1325974 to 18999999 (3325974 to 3899999)	143B96H to 1CFDDFH (32C016H to 3B825FGH)	System area			

*1 The P2 address cannot be used for the RnENCPU (network part).



■P1/P2 common area

Address		Application	Name	
Decimal	Hexadecimal			
1900000 to 1900007	1CFDE0H to 1CFDE7H	Ethernet PORT1/2 common information	Open completion signal	
1900008 to 1900015	1CFDE8H to 1CFDEFH		Open request signal	
1900016 to 1900023	1CFDF0H to 1CFDF7H		Socket/fixed buffer reception status signal	
1900024	1CFDF8H		Initial status	
1900025	1CFDF9H		Initial error code	
1900026 to 1900029	1CFDFAH to 1CFDFDH	System area		
1900030 ^{*1}	1CFDFEH	Receive buffer status storage area	State of receive buffer	
1900031 to 1901001	1CFDFFH to 1D01C9H	System area		
1901002	1D01CAH	Predefined protocol support function check area	Predefined protocol ready	
1901003 to 1901019	1D01CBH to 1D01DBH	System area		
1901020	1D01DCH	Predefined protocol setting data check area	Predefined protocol setting data error information	Protocol number
1901021	1D01DDH			Setting type
1901022	1D01DEH		Packet number	
1901023	1D01DFH		Element number	
1901024	1D01E0H		Number of registered predefined protocols	
1901025 to 1901031	1D01E1H to 1D01E7H		System area	
1901032 to 1901047	1D01E8H to 1D01F7H		Predefined protocol registration	
1901048 to 1901999	1D01F8H to 1D05AFH		System area	
1902000 to 1904047	1D05B0H to 1D0DAFH	Send/receive area for predefined protocol support function	Send/receive area for predefined protocol support function	
1904048 to 1921023	1D0DB0H to 1D4FFFH	System area		
1921024 to 1929215	1D5000H to 1D6FFFH	User setting area for MODBUS/TCP function		
1929216 to 1950031	1D7000H to 1DC14FH	System area		
1950032 to 1950039	1DC150H to 1DC157H	Discard received data at CPU STOP setting area		
1950040 to 1999999	1DC158 to 1E847FH	System area		

*1 Availability for the buffer memory depends on the firmware version. ( Page 564 Added and Enhanced Functions)

Point

- Do not write any data to the system area. Doing so may cause malfunction of the programmable controller system.
- If the value in an area of one word in size becomes equal to or higher than 65536, the count stops at 65535 (FFFFH).

CPU module (built-in Ethernet port part)

The following table lists the buffer memory addresses related to the Ethernet function of the CPU module (built-in Ethernet port part).

Address		Application	Name		
Decimal	Hexadecimal				
50 to 51	32H to 33H	Own node setting status storage area	Own node IP address		
60 to 61	3CH to 3DH		Subnet mask		
64 to 65	40H to 41H		Default gateway IP address		
74 to 76	4AH to 4CH		Own node MAC address		
77	4DH		Own node network number		
78	4EH		Station number		
80	50H		Send frame setting		
82	52H		Communication speed setting		
83	53H		Auto-open UDP port number		
84	54H		MELSOFT connection TCP port number		
85	55H		MELSOFT connection UDP port number		
86	56H		MELSOFT direct connection port number		
87	57H		Network number/Station number setting status		
100	64H		Communication load status of the built-in Ethernet port	Receive packet count per unit time (one second)	Receive packet count (current) per unit time (one second)
101	65H				Receive packet count (maximum) per unit time (one second)
102	66H			Send packet count per unit time (one second)	Send packet count (current) per unit time (one second)
103	67H				Send packet count (maximum) per unit time (one second)
130 to 145	82H to 91H	Connection status storage area	Connection No.1 latest error code to Connection No.16 latest error code		
146	92H	System port latest error code storage area	FTP server latest error code		
147	93H		MELSOFT direct connection latest error code		
148	94H		FTP client latest error code		
150 to 151	96H to 97H	Status for each protocol	IP packet	Received packet total count	
152 to 153	98H to 99H			Received packet checksum error discard count	
154 to 155	9AH to 9BH			Sent packet total count	
172 to 173	ACH to ADH			Simultaneous transmission error detection count (Receive buffer full count)	
179	B3H			Receive abort count	
182 to 183	B6H to B7H		ICMP packet	Received packet total count	
184 to 185	B8H to B9H			Received packet checksum error discard count	
186 to 187	BAH to BBH			Sent packet total count	
188 to 189	BCH to BDH			Received echo request total count	
190 to 191	BEH to BFH			Sent echo reply total count	
192 to 193	C0H to C1H			Sent echo request total count	
194 to 195	C2H to C3H			Received echo reply total count	
196 to 197	C4H to C5H		TCP packet	Received packet total count	
198 to 199	C6H to C7H			Received packet checksum error discard count	
200 to 201	C8H to C9H			Sent packet total count	
204 to 205	CCH to CDH		UDP packet	Received packet total count	
206 to 207	CEH to CFH			Received packet checksum error discard count	
208 to 209	D0H to D1H			Sent packet total count	
224 to 225	E0H to E1H		Receiving error	Framing error count	
226 to 227	E2H to E3H			Receive FIFO overflow count	
228 to 229	E4H to E5H			CRC error count	

A

Address		Application	Name	
Decimal	Hexadecimal			
242	F2H	Own node operation status storage area	Hub connection status area	Communication mode
243	F3H			Connection status
244	F4H			Communication speed
245	F5H			Disconnection count
251	FBH		IP address duplication status storage area	Same IP address detection flag
252 to 254	FCH to FEH			MAC address of the station already connected to the network
255 to 257	FFH to 101H			MAC address of the station with the IP address already used
270	10EH	Remote password lock status storage area	Remote password lock status connection No.1 to 16	
271	10FH		Remote password lock status system port	
275	113H	Discard received data at CPU STOP setting area	Discard received data connection No.1 to 16	
280	118H	Forced connection invalidation setting area	Forced connection invalidation connection No.1 to 16	
281	119H		Forced connection invalidation system port	
290	122H	Time setting function (SNTP) area	Time setting function operation result	
291	123H		Time setting function execution time	(Year)
292	124H			(Month)
293	125H			(Day)
294	126H			(Hour)
295	127H			(Minute)
296	128H			(Second)
297	129H			(Day of the week)
298	12AH		Time setting function required response time	
299	12BH		Time setting function (SNTP client) execution	
310 to 311	136H to 137H	IP packet transfer function area	IP packet transfer latest data volume	
312 to 313	138H to 139H		IP packet transfer maximum data volume	
320 to 335	140H to 14FH	Remote password function monitoring area	Connection No.1 continuous unlock failure count to Connection No.16 continuous unlock failure count	
336	150H		Auto-open UDP port continuous unlock failure count	
337	151H		MELSOFT transmission port (UDP/IP) continuous unlock failure count	
338	152H		MELSOFT transmission port (TCP/IP) continuous unlock failure count	
339	153H		FTP transmission port (TCP/IP) continuous unlock failure count	
340	154H		MELSOFT direct connection continuous unlock failure count	
350	15EH		Predefined protocol support function execution status check area	Connection No.1
351	15FH	System area		
352 to 367	160H to 16FH	Received data verification result (receive packet No.1 to 16)		
368	170H	Protocol execution count		
369	171H	Protocol cancellation specification		
370 to 669	172H to 29DH	Connection No.2 to Connection No.16		
680	2A8H	Open completion signal	Open completion signal	
681	2A9H	Open request signal	Open request signal	
682	2AAH	Socket communications reception status signal	Socket communications reception status signal	
683	2ABH	Initial status	Initial status	
684	2ACH	Initial error code	Initial error code	
692	2B4H	Predefined protocol support function check area	Predefined protocol ready	

Address		Application	Name		
Decimal	Hexadecimal				
710	2C6H	Predefined protocol setting data check area	Predefined protocol setting data error information	Protocol number	
711	2C7H			Setting type	
712	2C8H			Packet number	
713	2C9H			Element number	
714	2CAH		Number of registered predefined protocols		
722 to 729	2D2H to 2D9H		Predefined protocol registration		
740 to 741	2E4H to 2E5H	Area for both systems identical IP address setting function	Control system IP address		
760	2F8	Socket communications (TCP/IP)	Connection close wait time setting area for socket communications (TCP/IP)	Enabling/disabling connection close wait time setting	
761	2F9			Connection close wait time setting timer value	
770 to 785	302H to 311H	Connection status storage area	Connection No.1 latest error code (communication error) to Connection No.16 latest error code (communication error)		
786	312H		FTP server latest error code (communication error)		
787	313H		MELSOFT direct connection latest error code (communication error)		
788	314H		FTP client latest error code (communication error)		
789	315H		Auto-open UDP port latest error code (communication error)		
790	316H		MELSOFT connection auto-open UDP port latest error code (communication error)		
791	317H		MELSOFT connection auto-open TCP port latest error code (communication error)		
792	318H		Insufficient send buffer or memory count		
1090 to 1093	442H to 445H		Simple CPU communication function	Request to start communication at request for each setting number	
1094	446H			Request to stop fixed interval communication for each setting number	Stop request setting No.1 to 16
1095	447H	Stop request setting No.17 to 32			
1096	448H	Stop request setting No.33 to 48			
1097	449H	Stop request setting No.49 to 64			
1098	44AH	Request to restart fixed interval communication for each setting number		Restart request setting No.1 to 16	
1099	44BH			Restart request setting No.17 to 32	
1100	44CH			Restart request setting No.33 to 48	
1101	44DH			Restart request setting No.49 to 64	
1102	44EH	Execution status flag for each setting number		Execution status flag setting No.1 to 16	
1103	44FH			Execution status flag setting No.17 to 32	
1104	450H			Execution status flag setting No.33 to 48	
1105	451H			Execution status flag setting No.49 to 64	
1106	452H	Preparation completion for each setting number		Preparation completion setting No.1 to 16	
1107	453H			Preparation completion setting No.17 to 32	
1108	454H			Preparation completion setting No.33 to 48	
1109	455H			Preparation completion setting No.49 to 64	
1130 to 1193	46AH to 4A9H	Simple CPU communication status for each setting number		Simple CPU communication status setting No.1 to Simple CPU communication status setting No.64	
1194 to 1257	4AAH to 4E9H	Simple CPU communication error code for each setting number		Simple CPU communication error code setting No.1 to Simple CPU communication error code setting No.64	
1258 to 1321	4EAH to 529H	Execution interval (current value) for each setting number	Execution interval (current value) setting No.1 to Execution interval (current value) setting No.64		
1322 to 1385	52AH to 569H	Abnormal response code for each setting number	Abnormal response code setting No.1 to Abnormal response code setting No.64		

- Do not write any data to the system area. Doing so may cause malfunction of the programmable controller system.
- If the value in an area of one word in size becomes equal to or higher than 65536, the count stops at 65535 (FFFFH).

When using the RJ71EN71 (network type: Q-compatible Ethernet)

With the Q-compatible Ethernet, the same buffer memory addresses as the MELSEC-Q series Ethernet interface module can be used, excluding some addresses.

■Buffer memory addresses usable only with RJ71EN71

The following table lists the buffer memory addresses that can be used only with RJ71EN71.

Address		Application	Name
Decimal	Hexadecimal		
20700 to 20701	50DCH to 50DDH	Forced connection invalidation	Forced connection invalidation specification 20700 (b0 to 15): Connection No.1 to 16 20701 (b0): Auto-open UDP port 20701 (b1): MELSOFT transmission port (UDP/IP) 20701 (b2): MELSOFT transmission port (TCP/IP) 20701 (b3): FTP transmission port
65535	FFFFH	Network type information	Network type information

■Buffer memory addresses differing from MELSEC-Q series Ethernet interface modules

The following table lists the buffer memory addresses having specifications that differ from the ones of the MELSEC-Q series Ethernet interface module.

Address		Name	
Decimal	Hexadecimal	MELSEC-Q series Ethernet interface module	RJ71EN71
0 to 1	0H to 1H	Own station E71 IP address Initial value: C00001FEH	Own station IP address Initial value: C0A80328H
4	4H	Special function settings Initial value: 100H	Special function settings Initial value: 10H
31	1FH	Communication condition setting (Ethernet Operation Setting) area Initial value: 0H Communication data code setting (b1) 0: Communications in a binary code 1: Communications in an ASCII code TCP existence confirmation setting (b4) 0: Use the Ping 1: Use the KeepAlive Send frame setting (b5) 0: Ethernet 1: IEEE 802.3 Setting of write enable/disable at RUN time (b6) 0: Disable 1: Enable Initial timing setting (b8) 0: Do not wait for OPEN (Communications impossible at STOP time) 1: Always wait for OPEN (Communication possible at STOP time) Reinitialization specification (b15) 0: Reinitialization process complete (reset by the system) 1: Reinitialization process request (set by the user)	Communication condition setting area Initial value: 100H Communication data code (b1) 0: Binary 1: ASCII Enable/disable online change (b6) 0: Disable all (SLMP) 1: Enable all (SLMP) Opening method (b8) 0: Open by program 1: Do not open by program Reinitialization specification (b15) 0: Reinitialization process complete (reset by the system) 1: Reinitialization process request (set by the user)

Address		Name			
Decimal	Hexadecimal	MELSEC-Q series Ethernet interface module		RJ71EN71	
40	28H	Communication address setting area	Own station port No. Initial value: 0H	Communication address setting area	Own station port No. Initial value: 0H
41 to 42	29H to 2AH	Connection No.1	Destination IP address Initial value: 0H	Connection No.1	Destination IP address Initial value: 0H
43	2BH		Destination Port No. Initial value: 0H		Destination Port No. Initial value: 0H
44 to 46	2CH to 2EH		Destination MAC address Initial value: FFFFFFFFFFFFH		System area
47 to 95	2FH to 5FH		Communication address setting area Connection No.2 to 8 (Same as connection No.1)		Communication address setting area Connection No.2 to 8 (Same as connection No.1)
106 to 107	6AH to 6BH	Own station IP address Initial value: 0H	Own station IP address Initial value: C0A80328H		
108 to 110	6CH to 6EH	Own station MAC address Initial value: 0H	Own station MAC address Initial value: MAC address of the RJ71EN71		
116	74H	Auto-open UDP port number Initial value: 0H	Auto-open UDP port number Initial value: 1388H		
200	C8H	LED status INIT. LED (b0) 0: Off 1: On (initial processing completed) OPEN LED (b1) 0: Off 1: On (connection open processing completed) ERR. LED (b3) 0: Off 1: On (setting error) COM.ERR. LED (b4) 0: Off 1: On (communication error)	LED status P ERR LED (b0) 0: Off 1: On or flashing		
201	C9H	Hub connection status area Communication mode (b9) 0: Half-duplex 1: Full-duplex Hub connection status (b10) 0: Hub not connected/disconnected 1: Hub connected Data transmission speed (b15, b14) 00: Operating at 10BASE-T 01: Operating at 100BASE-TX	Hub connection status area Communication mode (b9) 0: Half-duplex 1: Full-duplex Hub connection status (b10) 0: Hub not connected/disconnected 1: Hub connected Data transmission speed (b15, b14) 00: Operating at 10BASE-T 01: Operating at 100BASE-TX 10: Operating at 1000BASE-T		
202	CAH	Switch status (Operational mode setting) 0: Online 1: Offline 2: Self-loopback test 3: Hardware test	Module operation mode setting 0: Online mode 1: Offline mode 4: Module communication test mode		



Address		Name	
Decimal	Hexadecimal	MELSEC-Q series Ethernet interface module	RJ71EN71
203	CBH	Status of settings with a programming tool Initial value: 0H Communication data code setting (b1) 0: Communications in a binary code 1: Communications in an ASCII code Initial/open method setting (b2) 0: No parameter setting (startup according to the sequence program) 1: Parameter setting (startup according to the parameters) TCP existence confirmation setting (b4) 0: Use the Ping 1: Use the KeepAlive Send frame setting (b5) 0: Ethernet 1: IEEE 802.3 Setting of write enable/disable at RUN time (b6) 0: Disable 1: Enable Initial timing setting (b8) 0: Do not wait for OPEN (Communications impossible at STOP time) 1: Always wait for OPEN (Communication possible at STOP time)	Status of settings with a programming tool Initial value: 100H Communication data code setting (b1) 0: Communications in a binary code 1: Communications in an ASCII code Send frame setting (b5) 0: Ethernet (fixed) Setting of write enable/disable at RUN time (b6) 0: Disable 1: Enable Opening method (b8) 0: Open by program 1: Do not open by program
398 to 399	18EH to 18FH	Simultaneous transmission error detection count	Receive buffer full count
20486	5006H	Remote password status Initial value: 0H	Remote password lock/unlocked status (user connection) Initial value: Depending on the remote password setting
20487	5007H	Remote password status Initial value: 0H	Remote password lock/unlocked status (system connection) Initial value: Depending on the remote password setting
20595	5073H	Connection No.1 Accumulated count of unlock process abnormal end	Connection No.1 Remote password mismatch count
20600	5078H	Connection No.2 Accumulated count of unlock process abnormal end	Connection No.2 Remote password mismatch count
20605	507DH	Connection No.3 Accumulated count of unlock process abnormal end	Connection No.3 Remote password mismatch count
20610	5082H	Connection No.4 Accumulated count of unlock process abnormal end	Connection No.4 Remote password mismatch count
20615	5087H	Connection No.5 Accumulated count of unlock process abnormal end	Connection No.5 Remote password mismatch count
20620	508CH	Connection No.6 Accumulated count of unlock process abnormal end	Connection No.6 Remote password mismatch count
20625	5091H	Connection No.7 Accumulated count of unlock process abnormal end	Connection No.7 Remote password mismatch count
20630	5096H	Connection No.8 Accumulated count of unlock process abnormal end	Connection No.8 Remote password mismatch count
20635	509BH	Connection No.9 Accumulated count of unlock process abnormal end	Connection No.9 Remote password mismatch count
20640	50A0H	Connection No.10 Accumulated count of unlock process abnormal end	Connection No.10 Remote password mismatch count
20645	50A5H	Connection No.11 Accumulated count of unlock process abnormal end	Connection No.11 Remote password mismatch count
20650	50AAH	Connection No.12 Accumulated count of unlock process abnormal end	Connection No.12 Remote password mismatch count
20655	50AFH	Connection No.13 Accumulated count of unlock process abnormal end	Connection No.13 Remote password mismatch count
20660	50B4H	Connection No.14 Accumulated count of unlock process abnormal end	Connection No.14 Remote password mismatch count
20665	50B9H	Connection No.15 Accumulated count of unlock process abnormal end	Connection No.15 Remote password mismatch count

Address		Name	
Decimal	Hexadecimal	MELSEC-Q series Ethernet interface module	RJ71EN71
20670	50BEH	Connection No.16 Accumulated count of unlock process abnormal end	Connection No.16 Remote password mismatch count
20675	50C3H	Auto-open UDP port Accumulated count of unlock process abnormal end	Auto-open UDP port Remote password mismatch count
20680	50C8H	MELSOFT application transmission port (UDP) Accumulated count of unlock process abnormal end	MELSOFT transmission port (UDP/IP) Remote password mismatch count
20685	50CDH	MELSOFT application transmission port (TCP) Accumulated count of unlock process abnormal end	MELSOFT transmission port (TCP/IP) Remote password mismatch count
20690	50D2H	FTP transmission port Accumulated count of unlock process abnormal end	FTP transmission port Remote password mismatch count
21056	5240H	Receive buffer full detection signal	State of receive buffer

■Buffer memory addresses not supported by the RJ71EN71

The following table lists the buffer memory addresses of the MELSEC-Q series Ethernet interface modules that are not supported by the RJ71EN71.

Address		Application	Name		
Decimal	Hexadecimal				
944 to 949	3B0H to 3B5H	FTP setting area	FTP login name		
950 to 953	3B6H to 3B9H		Password		
20488	5008H	System port information area	System port use prohibited designation area	System port use prohibited designation	
20592	5070H	Monitoring area	Remote password function monitoring area	Remote password mismatch notification accumulated count designation (user connection)	
20593	5071H			Remote password mismatch notification accumulated count designation (system connection)	
20594	5072H			Connection No. 1	Accumulated count of unlock process normal completion
20596	5074H				Accumulated count of lock process normal completion
20597	5075H				Accumulated count of lock process abnormal end
20598	5076H				Accumulated count of lock process based on close
20599	5077H			Connection No. 2	Accumulated count of unlock process normal completion
20601	5079H				Accumulated count of lock process normal completion
20602	507AH				Accumulated count of lock process abnormal end
20603	507BH				Accumulated count of lock process based on close
20604	507CH			Connection No. 3	Accumulated count of unlock process normal completion
20606	507EH				Accumulated count of lock process normal completion
20607	507FH				Accumulated count of lock process abnormal end
20608	5080H				Accumulated count of lock process based on close
20609	5081H			Connection No. 4	Accumulated count of unlock process normal completion
20611	5083H				Accumulated count of lock process normal completion
20612	5084H				Accumulated count of lock process abnormal end
20613	5085H				Accumulated count of lock process based on close
20614	5086H			Connection No. 5	Accumulated count of unlock process normal completion
20616	5088H				Accumulated count of lock process normal completion
20617	5089H				Accumulated count of lock process abnormal end
20618	508AH				Accumulated count of lock process based on close
20619	508BH			Connection No. 6	Accumulated count of unlock process normal completion
20621	508DH				Accumulated count of lock process normal completion
20622	508EH				Accumulated count of lock process abnormal end
20623	508FH				Accumulated count of lock process based on close
20624	5090H			Connection No. 7	Accumulated count of unlock process normal completion
20626	5092H				Accumulated count of lock process normal completion
20627	5093H				Accumulated count of lock process abnormal end
20628	5094H				Accumulated count of lock process based on close
20629	5095H	Connection No. 8	Accumulated count of unlock process normal completion		
20631	5097H		Accumulated count of lock process normal completion		
20632	5098H		Accumulated count of lock process abnormal end		
20633	5099H		Accumulated count of lock process based on close		
20634	509AH	Connection No. 9	Accumulated count of unlock process normal completion		
20636	509CH		Accumulated count of lock process normal completion		
20637	509DH		Accumulated count of lock process abnormal end		
20638	509EH		Accumulated count of lock process based on close		
20639	509FH	Connection No. 10	Accumulated count of unlock process normal completion		
20641	50A1H		Accumulated count of lock process normal completion		
20642	50A2H		Accumulated count of lock process abnormal end		
20643	50A3H		Accumulated count of lock process based on close		

Address		Application	Name		
Decimal	Hexadecimal				
20644	50A4H	Monitoring area	Remote password function monitoring area	Connection No. 11	Accumulated count of unlock process normal completion
20646	50A6H				Accumulated count of lock process normal completion
20647	50A7H				Accumulated count of lock process abnormal end
20648	50A8H				Accumulated count of lock process based on close
20649	50A9H			Connection No. 12	Accumulated count of unlock process normal completion
20651	50ABH				Accumulated count of lock process normal completion
20652	50ACH				Accumulated count of lock process abnormal end
20653	50ADH				Accumulated count of lock process based on close
20654	50AEH			Connection No. 13	Accumulated count of unlock process normal completion
20656	50B0H				Accumulated count of lock process normal completion
20657	50B1H				Accumulated count of lock process abnormal end
20658	50B2H				Accumulated count of lock process based on close
20659	50B3H			Connection No. 14	Accumulated count of unlock process normal completion
20661	50B5H				Accumulated count of lock process normal completion
20662	50B6H				Accumulated count of lock process abnormal end
20663	50B7H				Accumulated count of lock process based on close
20664	50B8H			Connection No. 15	Accumulated count of unlock process normal completion
20666	50BAH				Accumulated count of lock process normal completion
20667	50BBH				Accumulated count of lock process abnormal end
20668	50BCH				Accumulated count of lock process based on close
20669	50BDH			Connection No. 16	Accumulated count of unlock process normal completion
20671	50BFH				Accumulated count of lock process normal completion
20672	50C0H				Accumulated count of lock process abnormal end
20673	50C1H				Accumulated count of lock process based on close
20674	50C2H			Auto-open UDP port	Accumulated count of unlock process normal completion
20676	50C4H				Accumulated count of lock process normal completion
20677	50C5H				Accumulated count of lock process abnormal end
20678	50C6H			MELSOFT transmission port (UDP/IP)	Accumulated count of lock process based on close
20679	50C7H				Accumulated count of unlock process normal completion
20681	50C9H				Accumulated count of lock process normal completion
20682	50CAH			MELSOFT transmission port (TCP/IP)	Accumulated count of lock process abnormal end
20683	50CBH				Accumulated count of lock process based on close
20684	50CCH				Accumulated count of unlock process normal completion
20686	50CEH	FTP transmission port	Accumulated count of lock process normal completion		
20687	50CFH		Accumulated count of lock process abnormal end		
20688	50D0H		Accumulated count of lock process based on close		
20689	50D1H	FTP transmission port	Accumulated count of unlock process normal completion		
20691	50D3H		Accumulated count of lock process normal completion		
20692	50D4H		Accumulated count of lock process abnormal end		
20693	50D5H		Accumulated count of lock process based on close		
20737 to 20855	5101H to 5177H	HTTP status storage area			
20992	5200H	"Issue system switching request at disconnection detection" status storage area	"Issue system switching request at disconnection detection"		
20993	5201H		Disconnection detection monitoring time		
21008 to 21009	5210H to 5211H	"System switching settings when communication error occurs" status storage area			
22640 to 24575	5870H to 5FFFH	E-mail status storage area			

For details on other buffer memory addresses that can be used in the RJ71EN71, refer to the following.

📖 Q Corresponding Ethernet Interface Module User's Manual (Basic)

Details of buffer memory addresses (RJ71EN71, RnENCPU (network part))

This section describes the details of buffer memory addresses of the RJ71EN71 and RnENCPU (network part).
The buffer memory addresses are for when the P1 connector is used.

Own node setting status storage area

■Own node IP address (Un\G4 to Un\G5)

The IP address set with the module parameter is stored.

Address	Description
Un\G4	Third octet, fourth octet
Un\G5	First octet, second octet

■Subnet mask (Un\G14 to Un\G15)

The subnet mask set with the module parameter is stored.

Address	Description
Un\G14	Third octet, fourth octet
Un\G15	First octet, second octet

■Default gateway IP address (Un\G18 to Un\G19)

The default gateway IP address set with the module parameter is stored.

Address	Description
Un\G18	Third octet, fourth octet
Un\G19	First octet, second octet

■Own node MAC address (Un\G28 to Un\G30)

The MAC address of the Ethernet-equipped module is stored.

Address	Description
Un\G28	5th byte, 6th byte of the MAC address
Un\G29	3rd byte, 4th byte of the MAC address
Un\G30	1st byte, 2nd byte of the MAC address

■Jumbo frame setting (Un\G35)

Address	Description
Un\G35	Stores the jumbo frame set with the module parameter. 0: Disable (MTU 1500 byte) 2: 2KB (MTU 2034 byte) 3: 3KB (MTU 3058 byte) 4: 4KB (MTU 4082 byte) 5: 5KB (MTU 5106 byte) 6: 6KB (MTU 6130 byte) 7: 7KB (MTU 7154 byte) 8: 8KB (MTU 8178 byte) 9: 9KB (MTU 9004 byte)

■Communication speed setting (Un\G36)

Address	Description
Un\G36	Stores the communication speed set with the module parameter. 0: Automatic negotiation 1: 10Mbps/half-duplex 2: 10Mbps/full-duplex 3: 100Mbps/half-duplex 4: 100Mbps/full-duplex 6: 1Gbps/full-duplex

Connection status storage area

■Connection No.1 latest error code to connection No.64 latest error code (Un\G100 to Un\G163)

The latest error code for each connection is stored.

Address	Name
Un\G100	Connection No.1 latest error code
Un\G101	Connection No.2 latest error code
⋮	
Un\G162	Connection No.63 latest error code
Un\G163	Connection No.64 latest error code

Error log area



■Number of errors (Un\G227)

Address	Description
Un\G227	<p>The registered error count is stored in the error log block area. If 65536 or more errors occur, the count stops at FFFFH (65535). Even if the count in the storage area for the number of errors stops, the process of storing error information in the following areas continues.</p> <ul style="list-style-type: none">• Error log write pointer (Un\G228)• Error log block area (Un\G229 to Un\G372)

■Error log write pointer (Un\G228)

Address	Description
Un\G228	<p>This area is used for storing the error log block number at which the latest error log was registered.</p> <p>0: No error (no error log registered) 1 or more: Error log block number at which the latest error log was registered</p> <p>When the pointer value is 16, this indicates that the latest error log is registered in the area of error log block 16. When 17 or more errors occur, the registration of error logs starts again from the area of error log block 1.</p>

■Error log block 1 (Un\G229 to Un\G237)

Address	Name	Description
Un\G229	Error code/end code	The error code that shows the error details and the end code that is appended to a response for data communications are stored.  Page 443 List of Error Codes  Page 468 End Codes Returned to an External Device During Data Communications
Un\G230	Subheader	The subheader code of the message that became an error is stored in b0 to b7. (0 is stored in b8 to b15.) 0: Not used, subheader code unknown
Un\G231	Command code	The command code of a message that became an error or the values for the lower bytes of the request type and subrequest type of a data link instruction are stored. ■Command code <ul style="list-style-type: none"> • b15 to b0: Command code ■Request type and subrequest type <ul style="list-style-type: none"> • b15 to b8: Subrequest type • b7 to b0: Request type 0: Not used, command code unknown
Un\G232	Connection No.	The connection number in which an error occurred is stored in b0 to b7. (0 is stored in b8 to b15.) 0: Not used, connection number unknown 1 to 128: User connections 129 or more: System connections
Un\G233	Own station port No.	The own station port number when the error occurred is stored. 0: Not used, own station port number unknown
Un\G234, Un\G235	Communication destination IP address	The IP address of the communication destination when the error occurred is stored. 0: Not used, communication destination IP address unknown
Un\G236	Communication destination port No.	The port number of the communication destination when the error occurred is stored. 0: Not used, communication destination port number unknown
Un\G237	System area	

Point

The values stored in the error log areas are cleared when the Ethernet module mounted station is powered on, reset is operated, or the ERRCLEAR instruction is executed.

(However, when the network type is "Q Compatible Ethernet", the values are not cleared by execution of the UINI instruction and re-initial processing by 'Communication condition setting area' (Un\G31) of the buffer memory.)

For details on the ERRCLEAR instruction, refer to the following.

 MELSEC iQ-R Programming Manual (Module Dedicated Instructions)

■Error log block 2 to 16 (Un\G238 to Un\G372)

These areas are used for storing the information of error log block 2 to 16 in the same order as Error log block 1.

Status for each protocol

■IP packet (Un\G5000 to Un\G5029)

The IP status is counted in the range of 0 to 4294967295 (FFFFFFFF). (The number of receive aborts is counted in the range of 0 to 65535 (FFFFH).)

Address	Name
Un\G5000 to Un\G5001	Received packet total count
Un\G5002 to Un\G5003	Received packet checksum error discard count
Un\G5004 to Un\G5005	Sent packet total count
Un\G5022 to Un\G5023	Simultaneous transmission error detection count (receive buffer full count)
Un\G5029	Receive abort count

■ICMP packet (Un\G5040 to Un\G5053)

The ICMP status is counted in the range of 0 to 4294967295 (FFFFFFFFH).

Address	Name
Un\G5040 to Un\G5041	Received packet total count
Un\G5042 to Un\G5043	Received packet checksum error discard count
Un\G5044 to Un\G5045	Sent packet total count
Un\G5046 to Un\G5047	Received echo request total count
Un\G5048 to Un\G5049	Sent echo reply total count
Un\G5050 to Un\G5051	Sent echo request total count
Un\G5052 to Un\G5053	Received echo reply total count

■TCP packet (Un\G5080 to Un\G5085)

The TCP status is counted in the range of 0 to 4294967295 (FFFFFFFFH).

Address	Name
Un\G5080 to Un\G5081	Received packet total count
Un\G5082 to Un\G5083	Received packet checksum error discard count
Un\G5084 to Un\G5085	Sent packet total count

■UDP packet (Un\G5120 to Un\G5125)

The UDP status is counted in the range of 0 to 4294967295 (FFFFFFFFH).

Address	Name
Un\G5120 to Un\G5121	Received packet total count
Un\G5122 to Un\G5123	Received packet checksum error discard count
Un\G5124 to Un\G5125	Sent packet total count

■Receiving error (Un\G5160 to Un\G5165)

The receive error status is counted in the range of 0 to 4294967295 (FFFFFFFFH).

Address	Description
Un\G5160 to Un\G5161	Framing error count
Un\G5162 to Un\G5163	Receive FIFO overflow count
Un\G5164 to Un\G5165	CRC error count

A

Own node operation status storage area

■LED status (Un\G5189)

Address	Description
Un\G5189	Stores the on/off status of the P ERR LED. 0: Off 1: On or flashing

■Hub connection status area (Un\G5191 to Un\G5194)

The hub connection status of the Ethernet-equipped module is stored.

Address	Name	Description
Un\G5191	Communication mode	Stores the communication mode. 0: Half-duplex 1: Full-duplex
Un\G5192	Connection status	Stores the connection status. 0: Hub not connected or disconnected 1: Hub connected
Un\G5193	Communication speed	Stores the communication speed. 0: Operating at 10BASE-T 1: Operating at 100BASE-TX 2: Operating at 1000BASE-T
Un\G5194	Disconnection count	Stores the number of times the cable was disconnected.

■IP address duplication status storage area (Un\G5200 to Un\G5206)

Information when IP address is duplicated is stored.

Address	Name	Description
Un\G5200	Same IP address detection flag	Stores IP address duplication status. 0: IP address not duplicated 1: IP address duplicated
Un\G5201 to Un\G5203	MAC address of the station already connected to the network	Stores the MAC address of the station that has been already connected to the network in the station with duplicated IP address. Un\G5201: 5th and 6th byte of the MAC address Un\G5202: 3rd and 4th byte of the MAC address Un\G5203: 1st and 2nd byte of the MAC address "FFFFFFFFFFFFH" is stored in the station that has been already connected to the network.
Un\G5204 to Un\G5206	MAC address of the station with the IP address already used	Stores the MAC address of the station with duplicated IP address in the station that has been already connected to the network. Un\G5204: 5th and 6th byte of the MAC address Un\G5205: 3rd and 4th byte of the MAC address Un\G5206: 1st and 2nd byte of the MAC address "FFFFFFFFFFFFH" is stored in the station with the duplicated IP address.

Area for sending/receiving instructions

■RECV instruction execution request (Un\G5301)

Address	Description
Un\G5301	Stores the RECV instruction execution request status of each channel in b0 to b7 (channel 1 to 8). On: Requesting Off: No request

■Link dedicated instruction (Un\G5323 to Un\G5325)

The execution result of the link dedicated instruction is stored.

Address	Name	Description
Un\G5323	ZNRD instruction execution result	Stores the execution result of the ZNRD instruction. 0: Completed successfully Other than 0: Completed with an error (An error code is stored.)
Un\G5325	ZNWR instruction execution result	Stores the execution result of the ZNWR instruction. 0: Completed successfully Other than 0: Completed with an error (An error code is stored.)

Remote password lock status storage area

The remote password lock status of each connection is stored.

- 0: Unlocked or remote password not set
- 1: Lock status

Address	b15	b14	b13	b12	b11	b10	b9	b8	b7	b6	b5	b4	b3	b2	b1	b0
Un\G5626	16	15	14	13	12	11	10	9	8	7	6	5	4	3	2	1
⋮																
Un\G5629	64	63	62	61	60	59	58	57	56	55	54	53	52	51	50	49

The numbers in the table indicate connection numbers.

Remote password lock status system port (Un\G5630)

Address	Description
Un\G5630	<p>Stores the remote password lock status of the system port in b0 to b4.</p> <p>0: Unlocked or remote password not set</p> <p>1: Lock status</p> <p>The bits corresponding to each system port are shown below.</p> <p>b0: Auto-open UDP port</p> <p>b1: MELSOFT transmission port (UDP/IP)</p> <p>b2: MELSOFT transmission port (TCP/IP)</p> <p>b3: FTP transmission port</p> <p>b4: MELSOFT direct connection</p>

Forced connection invalidation setting area

Set the connection to be forcibly invalidated.

- 0: Use allowed
- 1: Use prohibited

Address	b15	b14	b13	b12	b11	b10	b9	b8	b7	b6	b5	b4	b3	b2	b1	b0
Un\G5646	16	15	14	13	12	11	10	9	8	7	6	5	4	3	2	1
⋮																
Un\G5649	64	63	62	61	60	59	58	57	56	55	54	53	52	51	50	49

The numbers in the table indicate connection numbers.

Forced connection invalidation system port (Un\G5650)

Address	Description
Un\G5650	<p>Set the system port to be forcibly invalidated.</p> <p>0: Use allowed</p> <p>1: Use prohibited</p> <p>The bits corresponding to each system port are shown below.</p> <p>b0: Auto-open UDP port</p> <p>b1: MELSOFT transmission port (UDP/IP)</p> <p>b2: MELSOFT transmission port (TCP/IP)</p> <p>b3: FTP transmission port</p> <p>b4: MELSOFT direct connection</p>



Predefined protocol support function execution status check area

■Connection No.1 (Un\G8300 to Un\G8335)

The execution status of the predefined protocol support function is stored.

For addresses corresponding to connections after the connection No.2, refer to the following.

☞ Page 473 List of buffer memory addresses

Address	Name	Description
Un\G8300	Protocol execution status	Stores the status of the protocol being executed at connection No.1. 0: Unexecuted 1: Waiting for transmission 2: Sending 3: Waiting for data reception 4: Receiving 5: Execution completed
Un\G8301	System area	—
Un\G8302	Received data verification result (receive packet No.1)	Stores the verification results of receive packet No.1. • Element No. where the verification result did not match (b0 to b7) 0: Verification matched 1 to 32: Element No. where the verification result did not match FFH: Verification not performed • The cause of mismatch (verification result code) (b8 to b15) ^{*1}
Un\G8303 to Un\G8317	Received data verification result (receive packet No.2 to 16)	The configuration is the same as receive packet No.1.
Un\G8318	Protocol execution count	Stores the number of protocol executions in Connection No.1. 0: Protocol not executed 1 to 65535: Number of executions (When the number exceeds 65535, the value remains 65535.)
Un\G8319	Protocol cancellation specification	Cancels the protocol executed in Connection No.1. 0: No cancellation instruction 1: Cancellation request (set by user) 2: Cancellation completed (set by system)
Un\G8320 to Un\G8335	System area	—

*1 The following table lists the verification result codes and causes of verification mismatch.

Stored value	Description	Cause
00H	Normal	—
01H	Insufficient receive data	The total packet size of receive data is smaller than that set in protocol data.
10H	Data not matched	The receive data do not match the value set in protocol data.
11H	ASCII-binary conversion error	When the code type setting is "ASCII Hexadecimal", data not in ASCII code are received.
12H	Data length error	The received length value exceeded 2046 bytes.
30H	Data length size error	The Length value received from the external device does not match the actual length.
FFH	Verification not performed	—

Time setting function (SNTP) area

■Time setting function operation result (Un\G11000)

Address	Description
Un\G11000	Stores the operation result of the time setting function. 0: Unexecuted 1: Success FFFFH: Failure

■Time setting function execution time (Un\G11001 to Un\G11007)

Address	Name	Description
Un\G11001	Year	Stores the year that the time setting function was executed.
Un\G11002	Month	Stores the month that the time setting function was executed.
Un\G11003	Day	Stores the date that the time setting function was executed.
Un\G11004	Hour	Stores the time (hour) that the time setting function was executed.
Un\G11005	Minute	Stores the time (minute) that the time setting function was executed.
Un\G11006	Second	Stores the time (second) that the time setting function was executed.
Un\G11007	Day of the week	Stores the day of the week that the time setting function was executed. 0: Sunday 1: Monday 2: Tuesday 3: Wednesday 4: Thursday 5: Friday 6: Saturday

■Time setting function required response time (Un\G11008)

Address	Description
Un\G11008	Stores the time required for the module to set the time after sending to the SNTP server. Range: 0 to FFFEH (Unit: ms)

■Time setting function (SNTP client) execution (Un\G11009)

Address	Description
Un\G11009	Executes the time setting function when b0 is turned on. The time setting function can be executed at a random time from a program. The function is not executed if b0 is turned on during execution of the time setting function. This is valid only when "Use" is set for "Time Setting (SNTP Client)" under "Time Setting" in "Application Settings".

IP packet transfer function area

■IP packet transfer latest data volume (Un\G11050 to Un\G11051)

Address	Description
Un\G11050 to Un\G11051	Stores the latest value (byte/s) of the total size (byte) per unit time (one second) of the transferred IP packet. (The low-order 16-bit value is stored in the 1st word, and the high-order 16-bit value is stored in the 2nd word.) Range: 0 to 4294967295 (FFFFFFFFH) The value is 4294967295 (FFFFFFFFH) if the above value is exceeded.

■IP packet transfer maximum data volume (Un\G11052 to Un\G11053)

Address	Description
Un\G11052 to Un\G11053	Stores the maximum value (byte/s) of the total size (byte) per unit time (one second) of the transferred IP packet. (The low-order 16-bit value is stored in the 1st word, and the high-order 16-bit value is stored in the 2nd word.) Range: 0 to 4294967295 (FFFFFFFFH) The value is 4294967295 (FFFFFFFFH) if the above value is exceeded.

Dynamic routing function area

■Communication path determination status (Un\G11500 to Un\G11514)

The determination status of the communication path for each network number of the destination station is stored.

- 0: Path undetermined
- 1: Path determined

Address	b15	b14	b13	b12	b11	b10	b9	b8	b7	b6	b5	b4	b3	b2	b1	b0
Un\G11500	16	15	14	13	12	11	10	9	8	7	6	5	4	3	2	1
⋮																
Un\G11514	Empty	239	238	237	236	235	234	233	232	231	230	229	228	227	226	225

The numbers in the table indicate network numbers.

Remote password function monitoring area

The number of times each connection and system port remote password unlocking failed continuously is counted in the range of 0 to 65535.

Address	Name
Un\G11600	Connection No.1 continuous unlock failure count
Un\G11601	Connection No.2 continuous unlock failure count
⋮	
Un\G11662	Connection No.63 continuous unlock failure count
Un\G11663	Connection No.64 continuous unlock failure count
Un\G11664	Auto-open UDP port continuous unlock failure count
Un\G11665	MELSOFT transmission port (UDP/IP) continuous unlock failure count
Un\G11666	MELSOFT transmission port (TCP/IP) continuous unlock failure count
Un\G11667	FTP transmission port (TCP/IP) continuous unlock failure count
Un\G11668	MELSOFT direct connection continuous unlock failure count

Area for both systems identical IP address setting function

■Control system IP address (Un\G11670 to Un\G11671)

The control system IP address set with the module parameter is stored.

Address	Description
Un\G11670	Third octet, fourth octet
Un\G11671	First octet, second octet

IP address change function area

■IP address setting (Un\G11700 to Un\G11705)

Set the IP address, subnet mask, and default gateway to be stored in the IP address storage area (flash ROM).

Address	Name	Description
Un\G11700	IP address	Third octet, fourth octet
Un\G11701		First octet, second octet
Un\G11702	Subnet mask	Third octet, fourth octet
Un\G11703		First octet, second octet
Un\G11704	Default Gateway	Third octet, fourth octet
Un\G11705		First octet, second octet

■Communications by network number/station number (Un\G11706 to Un\G11708)

Set the network number, station number, and transient transmission group number to be stored in the IP address storage area (flash ROM).

Address	Name
Un\G11706	Network number
Un\G11707	Station number
Un\G11708	Transient transmission group number

■IP address storage area write request (Un\G11709)

Address	Description
Un\G11709	<ul style="list-style-type: none">When b0 is turned off and on, writes the values stored in 'IP address setting' (Un\G11700 to Un\G11705) and 'Communications by Network No./Station No.' (Un\G11706 to Un\G11708) to the IP address storage area (flash ROM).When the data is completely written to the IP address storage area (flash ROM), b0 turns off regardless of the write results.

■IP address storage area write error (Un\G11710)

Address	Description
Un\G11710	When writing to the IP address storage area (flash ROM) ends abnormally, b0 turns on. When writing completes successfully, b0 turns off.

■IP address storage area writing error cause (Un\G11711)

Address	Description
Un\G11711	<p>Stores the cause of the abnormal end of writing to the IP address storage area (flash ROM).</p> <p>0H: No error</p> <p>100H:The value for 'IP address' (Un\G11700 to Un\G11701) exceeds the setting range.</p> <p>101H:The value for 'Default gateway' (Un\G11704 to Un\G11705) exceeds the setting range.</p> <p>102H:The network address of 'Default gateway' (Un\G11704 to Un\G11705) or of the gateway IP address is different from that of the IP address of the own node.</p> <p>103H:The value for 'Network number' (Un\G11706) exceeds the setting range.</p> <p>104H:The value for 'Station number' (Un\G11707) exceeds the setting range.</p> <p>105H:The value for 'Transient transmission group number' (Un\G11708) exceeds the setting range.</p> <p>106H:The port 1 and port 2 IP addresses written in the IP address storage area are the same.</p> <p>107H:The port 1 and port 2 network numbers or station numbers written in the IP address storage area are the same.</p> <p>200H:An error occurred during write.</p> <p>400H:Writing was started during the clear processing.</p>

■IP address storage area clear request (Un\G11712)

Address	Description
Un\G11712	<ul style="list-style-type: none">When b0 is turned off and on, clears the IP address storage area (flash ROM).When the IP address storage area (flash ROM) is cleared completely, b0 turns off regardless of the clear results.

■IP address storage area clear error (Un\G11713)

Address	Description
Un\G11713	When clearing the IP address storage area (flash ROM) ends abnormally, b0 turns on. When clearing completes successfully, b0 turns off.

■IP address storage area clear error cause (Un\G11714)

Address	Description
Un\G11714	Stores the cause of the abnormal end of clearing the IP address storage area (flash ROM). 0H: No error 200H:Error occurred during clearing. 400H:Clearing was started during the write processing.

■IP address change function operating status (Un\G11715)

Address	Description
Un\G11715	Stores the IP address change function operating status. 0: Operating according to the module parameter settings 1: Operating according to the IP address storage area (flash ROM) settings

Random access buffer area

■Random access buffer (Un\G20000 to Un\G26143)

This area is used for reading or writing the data when exchanging data with the random access buffer.

Network type information area

■Network type information (Un\G65535)

Address	Description
Un\G65535	Stores the network type. 0: Ethernet 1: CC-Link IE Field Network 2: CC-Link IE Controller Network 3: Ethernet (Q series-compatible)

Area for communication using a fixed buffer

■Fixed buffer No.1 (Un\G65536 to Un\G70655)

This area is used for sending and receiving data during fixed buffer communication.

For addresses corresponding to connections after the connection No.2, refer to the following.

 Page 473 List of buffer memory addresses

Address	Name	Description
Un\G65536	Data length	Stores the data length of the fixed buffer data.
Un\G65537 to Un\G70655	Fixed buffer data	Stores the fixed buffer data.

Error log area for MODBUS/TCP function



■Number of errors (Un\G720896)

This area is used for storing the number of errors that occurred during communications using MODBUS/TCP.

■Error log write pointer (Un\G720897)

This area is used for storing the error log number at which the latest error log was registered.

■Error log 1 (Un\G720898 to Un\G720905)

Address	Name	Description
Un\G720898	Detail error code	Stores an error code. ( Page 443 List of Error Codes)
Un\G720899	Abnormal response code	Stores a MODBUS abnormal response code. ( MELSEC iQ-R MODBUS and MODBUS/TCP Reference Manual)
Un\G720900	Function code	Stores a function code that caused the error.
Un\G720901	Own station port number	Stores the own station port number when the error occurred.
Un\G720902 to Un\G720903	Destination IP address	Stores the IP address of the destination station when the error occurred.
Un\G720904	Destination port number	Stores the port number of the destination station when the error occurred.
Un\G720905	System area	—

■Error log 2 to 32 (Un\G720906 to Un\G721153)

These areas are used for storing the information of the 2nd to 32nd errors in the same order as Error log 1.

Simple CPU communication area

■Request to start communication at request for each setting number (Un\G721896 to Un\G721899, Un\G1247300 to Un\G1247327)

This request contact starts the data send when the communication setting is "On Request" and is stored using the following bit pattern for each setting number.

- Off → On: Requested (start request)
- On → Off: Completed (start completion)

Address	b15	b14	b13	b12	b11	b10	b9	b8	b7	b6	b5	b4	b3	b2	b1	b0
Un\G721896	16	15	14	13	12	11	10	9	8	7	6	5	4	3	2	1
⋮																
Un\G721899	64	63	62	61	60	59	58	57	56	55	54	53	52	51	50	49
Address	b15	b14	b13	b12	b11	b10	b9	b8	b7	b6	b5	b4	b3	b2	b1	b0
Un\G1247300	80	79	78	77	76	75	74	73	72	71	70	69	68	67	66	65
⋮																
Un\G1247327	512	511	510	509	508	507	506	505	504	503	502	501	500	509	508	507

■Request to stop fixed interval communication for each setting number (Un\G721900 to Un\G721903, Un\G1247328 to Un\G1247355)

This request contact stops the data send when the communication setting is "Fixed Interval" and is stored using the following bit pattern for each setting number.

- Off → On: Requested (stop request)
- On → Off: Completed (stop completion)

Address	b15	b14	b13	b12	b11	b10	b9	b8	b7	b6	b5	b4	b3	b2	b1	b0
Un\G721900	16	15	14	13	12	11	10	9	8	7	6	5	4	3	2	1
⋮																
Un\G721903	64	63	62	61	60	59	58	57	56	55	54	53	52	51	50	49
Address	b15	b14	b13	b12	b11	b10	b9	b8	b7	b6	b5	b4	b3	b2	b1	b0
Un\G1247328	80	79	78	77	76	75	74	73	72	71	70	69	68	67	66	65
⋮																
Un\G1247355	512	511	510	509	508	507	506	505	504	503	502	501	500	509	508	507

■Request to restart fixed interval communication for each setting number (Un\G721904 to Un\G721907, Un\G1247356 to Un\G1247383)

This request contact restarts the data send when the communication setting is "Fixed Interval" and is stored using the following bit pattern for each setting number.

- Off → On: Requested (restart request)
- On → Off: Completed (restart completion)

Address	b15	b14	b13	b12	b11	b10	b9	b8	b7	b6	b5	b4	b3	b2	b1	b0
Un\G721904	16	15	14	13	12	11	10	9	8	7	6	5	4	3	2	1
⋮																
Un\G721907	64	63	62	61	60	59	58	57	56	55	54	53	52	51	50	49
Address	b15	b14	b13	b12	b11	b10	b9	b8	b7	b6	b5	b4	b3	b2	b1	b0
Un\G1247356	80	79	78	77	76	75	74	73	72	71	70	69	68	67	66	65
⋮																
Un\G1247383	512	511	510	509	508	507	506	505	504	503	502	501	500	509	508	507

■ Execution status flag for each setting number (Un\G721908 to Un\G721911, Un\G1247384 to Un\G1247411)

The status of data communication is stored using the following bit pattern for each setting number.

- Off: Communication stop (function not used)
- On: Communicating

Address	b15	b14	b13	b12	b11	b10	b9	b8	b7	b6	b5	b4	b3	b2	b1	b0
Un\G721908	16	15	14	13	12	11	10	9	8	7	6	5	4	3	2	1
⋮																
Un\G721911	64	63	62	61	60	59	58	57	56	55	54	53	52	51	50	49
Address	b15	b14	b13	b12	b11	b10	b9	b8	b7	b6	b5	b4	b3	b2	b1	b0
Un\G1247384	80	79	78	77	76	75	74	73	72	71	70	69	68	67	66	65
⋮																
Un\G1247411	512	511	510	509	508	507	506	505	504	503	502	501	500	509	508	507

■ Preparation completion for each setting number (Un\G721912 to Un\G721915, Un\G1247412 to Un\G1247439)

The preparation completion status of the simple CPU communication is stored using the following bit pattern for each setting number.

- Off: Not ready (function not used)
- On: Ready

Address	b15	b14	b13	b12	b11	b10	b9	b8	b7	b6	b5	b4	b3	b2	b1	b0
Un\G721912	16	15	14	13	12	11	10	9	8	7	6	5	4	3	2	1
⋮																
Un\G721915	64	63	62	61	60	59	58	57	56	55	54	53	52	51	50	49
Address	b15	b14	b13	b12	b11	b10	b9	b8	b7	b6	b5	b4	b3	b2	b1	b0
Un\G1247412	80	79	78	77	76	75	74	73	72	71	70	69	68	67	66	65
⋮																
Un\G1247439	512	511	510	509	508	507	506	505	504	503	502	501	500	509	508	507

■ Simple CPU communication status for each setting number (Un\G721936 to Un\G721999, Un\G1247460 to Un\G1247907)

Address	Name	Description
Un\G721936	Simple CPU communication status setting No.1	The simple CPU communication status is stored. 0H: Unset (function not used) 1H: Preparing 2H: Waiting for the request 3H: Communicating 4H: Communication stop 5H: Retry being executed 6H: Monitoring AH: Communications impossible
Un\G721937	Simple CPU communication status setting No.2	
⋮		
Un\G721998	Simple CPU communication status setting No.63	
Un\G721999	Simple CPU communication status setting No.64	
Address	Name	Description
Un\G1247460	Simple CPU communication status setting No.65	The simple CPU communication status is stored. 0H: Unset (function not used) 1H: Preparing 2H: Waiting for the request 3H: Communicating 4H: Communication stop 5H: Retry being executed 6H: Monitoring AH: Communications impossible
Un\G1247461	Simple CPU communication status setting No.66	
⋮		
Un\G1247906	Simple CPU communication status setting No.511	
Un\G1247907	Simple CPU communication status setting No.512	

■Simple CPU communication error code for each setting number (Un\G722000 to Un\G722063, Un\G1247908 to Un\G1248355)

Address	Name	Description
Un\G722000	Simple CPU communication error code setting No.1	The cause of the error detected in the simple CPU communication is stored. 0: No error (function not used) Other than 0: Error code (☞ Page 443 List of Error Codes)
Un\G722001	Simple CPU communication error code setting No.2	
⋮		
Un\G722062	Simple CPU communication error code setting No.63	The value is cleared to 0 with a clear request from the engineering tool.
Un\G722063	Simple CPU communication error code setting No.64	
Address	Name	Description
Un\G1247908	Simple CPU communication error code setting No.65	The cause of the error detected in the simple CPU communication is stored. 0: No error (function not used) Other than 0: Error code (☞ Page 443 List of Error Codes)
Un\G1247909	Simple CPU communication error code setting No.66	
⋮		
Un\G1248354	Simple CPU communication error code setting No.511	The value is cleared to 0 with a clear request from the engineering tool.
Un\G1248355	Simple CPU communication error code setting No.512	

■Abnormal response code for each setting number (Un\G722064 to Un\G722127, Un\G1248356 to Un\G1248803)

Address	Name	Description
Un\G722064	Abnormal response code setting No.1	The abnormal response code detected in the simple CPU communication is stored. 0: No error (function not used) Other than 0: Abnormal response code
Un\G722065	Abnormal response code setting No.2	
⋮		
Un\G722126	Abnormal response code setting No.63	For abnormal response codes, refer to the manual for the external device. This function is available when CFB4H is stored in "Simple CPU communication error code for each setting number" (Un\G722000 to Un\G722063).
Un\G722127	Abnormal response code setting No.64	
Address	Name	Description
Un\G1248356	Abnormal response code setting No.65	The abnormal response code detected in the simple CPU communication is stored. 0: No error (function not used) Other than 0: Abnormal response code
Un\G1248357	Abnormal response code setting No.66	
⋮		
Un\G1248802	Abnormal response code setting No.511	For abnormal response codes, refer to the manual for the external device. This function is available when CFB4H is stored in "Simple CPU communication error code for each setting number" (Un\G1247908 to Un\G1248355).
Un\G1248803	Abnormal response code setting No.512	

■Execution interval (current value) for each setting number (Un\G722128 to Un\G722191, Un\G1248804 to Un\G1249251)

Address	Name	Description
Un\G722128	Execution interval (current value) setting No.1	If "Fixed" is set for communication setting, the current value of the execution interval is stored. 0: Unset (function not used), communications impossible Other than 0: Execution interval (unit: ms)
Un\G722129	Execution interval (current value) setting No.2	
⋮		
Un\G722190	Execution interval (current value) setting No.63	
Un\G722191	Execution interval (current value) setting No.64	
Address	Name	Description
Un\G1248804	Execution interval (current value) setting No.65	If "Fixed" is set for communication setting, the current value of the execution interval is stored. 0: Unset (function not used), communications impossible Other than 0: Execution interval (unit: ms)
Un\G1248805	Execution interval (current value) setting No.66	
⋮		
Un\G1249250	Execution interval (current value) setting No.511	
Un\G1249251	Execution interval (current value) setting No.512	

■User setting area (Un\G722500 to Un\G1246787)

This area can be used freely during simple CPU communication and simple device communication.

Simple device communication area

■Function start/stop instruction (Un\G1249300.0)

This instruction is the contact to start the simple device communication function. The initial value can be changed with "Instruction Initial Value to Start/Stop Function".

☞ Page 339 Instruction Initial Value to Start/Stop Function

- 0: Stop
- 1: Start (Initial value)

■Setting No.1 (Un\G1249302 to Un\G1250499)

Address	Name	Description
Un\G1249302	IP address	Third octet, fourth octet
Un\G1249303		First octet, second octet
Un\G1249304	Port No.	Stores the port number set for setting No.1.
Un\G1249305	Protocol number of error	Stores the protocol number of an error detected in setting No.1.
Un\G1249306	Error code for simple device communication	Stores the latest error code of an error detected in setting No.1.
Un\G1249307	Error clear request	Stores the contact to clear the error code detected in setting No.1 in the program. <ul style="list-style-type: none"> • 0H: Error clear not instructed • 1H: Error clear request (set by users) • 2H: Error clear completed (set by system)
Un\G1249308.0	Ready	Stores the ready status of setting No.1. <ul style="list-style-type: none"> • 0: Not ready • 1: Ready
Un\G1249309	Status of connection	Stores the connection status of setting No.1. <ul style="list-style-type: none"> • 0H: Unset • 1H: Preparing • 2H: Waiting for the request • 3H: Communicating • 4H: Function being stopped • 5H: Retry being executed • 6H: Monitoring at error
Un\G1249310 to Un\G1249311	Number of successful completion	Stores the number of times that protocols executed in setting No.1 are successfully completed. <ul style="list-style-type: none"> • 0: Protocol not executed • 1 to 4294967295: Number of successful completion (When the number reaches or exceeds 4294967295, the value does not change.)
Un\G1249312 to Un\G1249313	Number of error completion	Stores the number of times that protocols executed in setting No.1 are completed with error. <ul style="list-style-type: none"> • 0: Protocol not executed • 1 to 4294967295: Number of error completion (When the number reaches or exceeds 4294967295, the value does not change.)
Un\G1249314 to Un\G1249315	Retry count	Stores the number of protocol retries executed in setting No.1. <ul style="list-style-type: none"> • 0: Protocol not executed • 1 to 4294967295: Number of retries (When the number reaches or exceeds 4294967295, the value does not change.)
Un\G1249316	Protocol number currently executing	Stores the protocol number currently executed in setting No.1. (Stores the value at a timing of execution of the protocol and holds the value until the next protocol execution.) <ul style="list-style-type: none"> • 0: The protocol has never been executed. • Other than 0: Protocol number currently executed
Un\G1249317	Verification mismatch protocol number	Stores the latest protocol number that results in the verification mismatch in setting No.1. This area will not be cleared even when the verification mismatch has been resolved. To clear the area, use 'Error clear request' (Un\G1249307).

Address	Name	Description
Un\G1249318 to Un\G1249333	Verification mismatch information (receive packet numbers 1 to 16)	Displays the verification mismatch information of the protocol number stored in 'Verification mismatch protocol number' (Un\G1249317) for each receive packet. bit 0 to 7: Element number where the verification mismatch occurred <ul style="list-style-type: none"> • 0H: Verification matched • 1 to 32: Element number where the verification mismatch occurred • FEH: Whole packets • FFH: Verification not performed bit 8 to F: Cause of the verification mismatch* ¹ This area will not be cleared even when the verification mismatch has been resolved. To clear the area, use 'Error clear request' (Un\G1249307).
Un\G1249334 to Un\G1249347	System area	—
Un\G1249348 to Un\G1249379	Start request for each protocol	Stores the request contact to start the execution of each protocol in setting No.1. <ul style="list-style-type: none"> • Un\G1249348.0: Protocol 1 • Un\G1249348.1: Protocol 2 ⋮ • Un\G1249379.15: Protocol 512 The default differs depending on the communication setting of the protocol settings. <ul style="list-style-type: none"> • Default when the communication setting is "Fixed Intrvl": On (Start) • Default when the communication setting is "Request": Off (Stop)
Un\G1249380 to Un\G1249411	Execution completion for each protocol	Stores the execution completion status for each protocol of setting No.1. <ul style="list-style-type: none"> • Un\G1249380.0: Protocol 1 • Un\G1249380.1: Protocol 2 ⋮ • Un\G1249411.15: Protocol 512 Default: Off (Not completed)
Un\G1249412 to Un\G1249443	Error for each protocol	Stores the error status for each protocol of setting No.1. <ul style="list-style-type: none"> • Un\G1249412.0: Protocol 1 • Un\G1249412.1: Protocol 2 ⋮ • Un\G1249443.15: Protocol 512 Default: Off (Not occurred)
Un\G1249444 to Un\G1249475	Execution status for each protocol	Stores the data communication status for each protocol of setting No.1. <ul style="list-style-type: none"> • Un\G1249444.0: Protocol 1 • Un\G1249444.1: Protocol 2 ⋮ • Un\G1249475.15: Protocol 512 Default: Off (Communication stop)
Un\G1249476 to Un\G1249987	Execution interval (current value) for each protocol	Stores the current value of the execution interval for each protocol whose communication setting is "Fixed Intrvl" in setting No.1. <ul style="list-style-type: none"> • Un\G1249476: Protocol 1 • Un\G1249477: Protocol 2 ⋮ • Un\G1249987: Protocol 512 Current value is 0: Unset (function not used), communications impossible Current value is other than 0: Execution interval (ms)
Un\G1249988 to Un\G1250499	Execution interval (maximum value) for each protocol	Stores the maximum value of the execution interval for each protocol whose communication setting is "Fixed Intrvl" in setting No.1. <ul style="list-style-type: none"> • Un\G1249988: Protocol 1 • Un\G1249989: Protocol 2 ⋮ • Un\G1250499: Protocol 512 Maximum value is 0: Unset (function not used), communications impossible Maximum value is other than 0: Execution interval (ms)



*1 The following table lists the verification result codes and causes of verification mismatch.

Stored value	Description	Cause
0H	No mismatch information	—
1H	Data not matched	The static data did not match the setting value.
2H	Insufficient receive data	The receive data is shorter than the length specified in the packet configuration.
3H	Packet configuration not matched	Static data that indicates the end was not received after variable length data.
4H	Packet length exceeded	<ul style="list-style-type: none"> • According to verification results, the packet length exceeded the maximum value. • The receive data is longer than the length specified in the packet configuration.
10H	Length value range error	The length value exceeded the maximum value for packet length.
11H	Length value not matched	The length value did not match the received packet.
20H	ASCII-binary conversion error	<ul style="list-style-type: none"> • The format of the length (ASCII) or conversion variable is different from the specified format. • Analysis result of data received as a conversion variable was completed with an error.
21H	Insufficient number of digits	<ul style="list-style-type: none"> • The number of digits received as a conversion variable (ASCII HEX → HEX) was an odd number. • Data with a number of digits that is less than the number of digits specified by the conversion variable was received.
22H	Number of digits exceeded	<p>The number of digits of a conversion variable (the number of digits is variable) exceeded the range that can be stored in the data storage area.</p> <p>As a conversion variable (data quantity is fixed and the number of digits is variable), data quantity more than the data quantity set in "Number of Data/Maximum Number of Data" was received.</p>
23H	Numerical value outside the range	A value of a conversion variable after conversion was outside the range that can be stored in the data storage area.
30H	Error check code error	The calculated error check code and the received error check code did not match.
FEH	Configuration error of simple device communication packet	Incorrect protocol data is set in "Simple Device Communication Setting".

The following formulas can be used for calculating the buffer memory addresses and bit positions for Start request for each protocol, Execution completion for each protocol, Error for each protocol, and Execution status for each protocol.

- Buffer memory address^{*1}: $\text{Offset value} + (1198 \times ([\text{Setting No.}] - 1)) + (([\text{Protocol number}] - 1) / 16)$
- Bit position: $\text{Remainder of } ([\text{Protocol number}] - 1) / 16$

In the calculation, assign the values listed below to the offset value.

Name	Offset value
Start request for each protocol	1249348
Execution completion for each protocol	1249380
Error for each protocol	1249412
Execution status for each protocol	1249444

*2 Round down after decimal places

Ex.

To obtain the buffer memory address of Start request for each protocol (setting No.32, protocol number 512)

Address: $1249348 + (1198 \times (32 - 1)) + ((512 - 1) / 16) = 1286517.9375$

Bit position: $(512 - 1) / 16 = 31$ with a remainder of 15 (FH)

The buffer memory address and bit position are Un\G1286517.F.

■Setting No.2 to 64 (Un\G1250500 to Un\G1325973)

These areas are used for storing the information of setting No.2 to 64 in the same order as setting No.1.

■User setting area (Un\G722500 to Un\G1246787)

This area can be used freely during simple CPU communication and simple device communication.

Ethernet PORT1/2 common information

■Open completion signal (Un\G1900000 to Un\G1900007)

The open status of each connection is stored.

- 0: Closed or not open
- 1: Open completed

Address	b15	b14	b13	b12	b11	b10	b9	b8	b7	b6	b5	b4	b3	b2	b1	b0
Un\G1900000	16	15	14	13	12	11	10	9	8	7	6	5	4	3	2	1
⋮																
Un\G1900007	128	127	126	125	124	123	122	121	120	119	118	117	116	115	114	113

The numbers in the table indicate connection numbers.

■Open request signal (Un\G1900008 to Un\G1900015)

The open processing status of each connection is stored.

- 0: No open request
- 1: Requesting open

Address	b15	b14	b13	b12	b11	b10	b9	b8	b7	b6	b5	b4	b3	b2	b1	b0
Un\G1900008	16	15	14	13	12	11	10	9	8	7	6	5	4	3	2	1
⋮																
Un\G1900015	128	127	126	125	124	123	122	121	120	119	118	117	116	115	114	113

The numbers in the table indicate connection numbers.

■Socket/fixed buffer reception status signal (Un\G1900016 to Un\G1900023)

The reception status of each connection is stored.

- 0: Data not received
- 1: Data reception completed

Address	b15	b14	b13	b12	b11	b10	b9	b8	b7	b6	b5	b4	b3	b2	b1	b0
Un\G1900016	16	15	14	13	12	11	10	9	8	7	6	5	4	3	2	1
⋮																
Un\G1900023	128	127	126	125	124	123	122	121	120	119	118	117	116	115	114	113

The numbers in the table indicate connection numbers.

■Initial status (Un\G1900024)

Address	Description
Un\G1900024	Stores the status of the initial processing of the RJ71EN71 or the RnENCPU (network part). Initial normal completion status (b0) 0: — 1: Initialization normal completion Initial abnormal completion status (b1) 0: — 1: Initialization abnormal completion b2 to b15: Use prohibited

■Initial error code (Un\G1900025)

Address	Description
Un\G1900025	Stores the information when the initial processing of the RJ71EN71 or the RnENCPU (network part) is completed abnormally. 0: In initial processing or initial normal completion Other than 0: Initial processing error code (An error code is stored.)

Receive buffer status storage area

■State of receive buffer (Un\G1900030)

Address	Description
Un\G1900030	Stores the receive buffer status. 0: Receive buffer not full 1: Receive buffer full

Predefined protocol support function check area

■Predefined protocol ready (Un\G1901002)

Address	Description
Un\G1901002	Stores the ready status of the protocol setting data. 0: — 1: Ready

Predefined protocol setting data check area

■Predefined protocol setting data error information (Un\G1901020 to Un\G1901023)

Address	Name	Description
Un\G1901020	Protocol number	When a protocol setting data error is detected, stores the protocol number where the error was detected. Protocol is checked in order from smallest protocol number. The protocol number where an error was detected first is stored. 0: No error 1 to 128: Protocol number 65535: Cannot identify ^{*1}
Un\G1901021	Setting type	0 is stored if an error is detected in the packet setting or element setting. 1 is stored if an error is detected in the protocol detailed setting. (Valid when protocol number value is 1 to 128) 0: Packet setting or element setting 1: Protocol preferences 65535: Cannot identify ^{*1}
Un\G1901022	Packet number	When an error is detected in the protocol setting data, stores the packet number that detected the error. The packets are checked in order of send packets and then receive packets (expected packets) from smallest number. The packet number where an error was detected first is stored. (Valid when setting type value is 0) 0: Send packet 1 to 16: Receive packet number 65535: Cannot identify ^{*1}
Un\G1901023	Element number	When an error is detected in the protocol setting data, stores the element number where the error was detected. The elements are checked in order of smallest element number. The element number where an error was detected first is stored. (Valid when setting type value is 0) 1 to 32: Element number 65535: Cannot identify ^{*1}

*1 The setting value may be unidentifiable (65535) in the following cases.

- When a setting that cannot be detected by the current Ethernet-equipped module version is written in
- When protocol setting data is broken (hardware failure)

■Number of registered predefined protocols (Un\G1901024)

Address	Description
Un\G1901024	Stores the protocol number of the registered protocol setting data. 0 is stored if the protocol setting data check result is abnormal. 0: No registration 1 to 128: Number of registrations

■Predefined protocol registration (Un\G1901032 to Un\G1901047)

Whether protocol setting data is registered or not is stored.

All bits are set to 0 if the protocol setting data check result is abnormal.

- 0: No registration
- 1: Registered

Address	b15	b14	b13	b12	b11	b10	b9	b8	b7	b6	b5	b4	b3	b2	b1	b0
Un\G1901032	16	15	14	13	12	11	10	9	8	7	6	5	4	3	2	1
⋮																
Un\G1901039	128	127	126	125	124	123	122	121	120	119	118	117	116	115	114	113
Un\G1901040 to Un\G1901047	Empty															

The numbers in the table indicate protocol numbers.

Send/receive area for predefined protocol support function

■Send/receive area for predefined protocol support function (Un\G1902000 to Un\G1904047)

This area is used for sending and receiving data during communication with predefined protocol.

User setting area for MODBUS/TCP function

■User setting area for MODBUS/TCP function (Un\G1921024 to Un\G1929215)

This area is used for sending and receiving data during communications using MODBUS/TCP.

Discard received data at CPU STOP setting area

■Discard received data at CPU STOP setting area (Un\G1950032 to Un\G1950039)

Stores one of the following bit patterns for each connection number.

- 0: Disable (The receive data is not discarded during CPU STOP.)
- 1: Enable (The receive data is discarded during CPU STOP.)

Address	b15	b14	b13	b12	b11	b10	b9	b8	b7	b6	b5	b4	b3	b2	b1	b0
Un\G1950032	16	15	14	13	12	11	10	9	8	7	6	5	4	3	2	1
⋮																
Un\G1950039	128	127	126	125	124	123	122	121	120	119	118	117	116	115	114	113

The numbers in the table indicate connection numbers.

Details of buffer memory addresses (CPU module (built-in Ethernet port part))

This section describes the details of buffer memory addresses of the CPU module (built-in Ethernet port part).

Own node setting status storage area

■Own node IP address (Un\G50, Un\G51)

The IP address set with the module parameter is stored.

Address	Description
Un\G50	Third octet, fourth octet
Un\G51	First octet, second octet

■Subnet mask (Un\G60, Un\G61)

The subnet mask set with the module parameter is stored.

Address	Description
Un\G60	Third octet, fourth octet
Un\G61	First octet, second octet

■Default gateway IP address (Un\G64, Un\G65)

The default gateway IP address set with the module parameter is stored.

Address	Description
Un\G64	Third octet, fourth octet
Un\G65	First octet, second octet

■Own node MAC address (Un\G74 to Un\G76)

The MAC address of the Ethernet-equipped module is stored.

Address	Description
Un\G74	5th byte, 6th byte of the MAC address
Un\G75	3rd byte, 4th byte of the MAC address
Un\G76	1st byte, 2nd byte of the MAC address

■Network number/Station number setting status (Un\G87)

This area is used for storing the setting status of the network number/station number.

Address	Name	Description
Un\G87	Network number/Station number setting status	Stores the setting status of the network number/station number that has been set with parameters or by the IP address change function. b0: Network number/station number validity flag (0: Disabled, 1: Enabled)

A

Communication load status

Receive packet count per unit time (one second) (Un\G100, Un\G101)

The number of receive packets per unit time (one second) of the built-in Ethernet port communications is stored.

Address	Name	Description
Un\G100	Receive packet count (current) per unit time (one second)	<ul style="list-style-type: none"> ■The number of receive packets per unit time (one second) of the built-in Ethernet port is stored. ■When the processing speed of the built-in Ethernet communications is slow and if this value is large, the following actions may improve the processing speed. <ul style="list-style-type: none"> • Review the communication request from the engineering tool and GOT. • Review the communication request from the transfer destination (execution source) of the simple CPU communications. • Review the file transfer function (FTP server). • Review the communications using the SLMP.
Un\G101	Receive packet count (maximum) per unit time (one second)	The maximum value of the number of receive packets per unit time (one second) of the built-in Ethernet port is stored.

Send packet count per unit time (one second) (Un\G102, Un\G103)

The number of send packets per unit time (one second) of the built-in Ethernet port communications is stored.

Address	Name	Description
Un\G102	Send packet count (current) per unit time (one second)	<ul style="list-style-type: none"> ■The number of send packets per unit time (one second) of the built-in Ethernet port is stored. ■When the processing speed of the built-in Ethernet communications is slow and if this value is large, the following actions may improve the processing speed. <ul style="list-style-type: none"> • Review the execution frequency of the instructions for the built-in Ethernet function (socket communications instruction/predefined protocol support function instruction/SLMP frame send instruction/file transfer function instruction) • Review the settings (such as the number of points) of CC-Link IE Field Network Basic. • Review the settings (such as the execution interval and the number of points) of the simple CPU communications. • Review the settings (such as automatic detection and backup execution) of iQSS (built-in Ethernet). • Review the settings (such as the number of executions) of data logging file transfer.
Un\G103	Send packet count (maximum) per unit time (one second)	The maximum value of the number of send packets per unit time (one second) of the built-in Ethernet port is stored.

Connection status storage area

Connection No.1 latest error code to connection No.16 latest error code (Un\G130 to Un\G145)

The latest error code for each connection is stored.

Address	Name
Un\G130	Connection No.1 latest error code
Un\G131	Connection No.2 latest error code
:	
Un\G144	Connection No.15 latest error code
Un\G145	Connection No.16 latest error code

Own node operation status storage area

■Hub connection status area (Un\G242 to Un\G245)

The hub connection status of the Ethernet-equipped module is stored.

Address	Name	Description
Un\G242	Communication mode	Stores the communication mode. 0: Half-duplex 1: Full-duplex
Un\G243	Connection status	Stores the connection status. 0: Hub not connected or disconnected 1: Hub connected
Un\G244	Communication speed	Stores the communication speed. 0: Operating at 10BASE-T 1: Operating at 100BASE-TX 2: Operating at 1000BASE-T
Un\G245	Disconnection count	Stores the number of times the cable was disconnected.

■IP address duplication status storage area (Un\G251 to Un\G257)

Information when IP address is duplicated is stored.

Address	Name	Description
Un\G251	Same IP address detection flag	Stores IP address duplication status. 0: IP address not duplicated 1: IP address duplicated
Un\G252 to Un\G254	MAC address of the station already connected to the network	Stores the MAC address of the station that has been already connected to the network in the station with duplicated IP address. Un\G252: 5th and 6th byte of the MAC address Un\G253: 3rd and 4th byte of the MAC address Un\G254: 1st and 2nd byte of the MAC address "FFFFFFFFFFH" is stored in the station that has been already connected to the network.
Un\G255 to Un\G257	MAC address of the station with the IP address already used	Stores the MAC address of the station with duplicated IP address in the station that has been already connected to the network. Un\G255: 5th and 6th byte of the MAC address Un\G256: 3rd and 4th byte of the MAC address Un\G257: 1st and 2nd byte of the MAC address "FFFFFFFFFFH" is stored in the station with the duplicated IP address.

A

Remote password lock status storage area

■Remote password lock status system port (Un\G270)

The remote password lock status of each connection is stored.

- 0: Unlocked or remote password not set
- 1: Lock status

Address	b15	b14	b13	b12	b11	b10	b9	b8	b7	b6	b5	b4	b3	b2	b1	b0
Un\G270	16	15	14	13	12	11	10	9	8	7	6	5	4	3	2	1

The numbers in the table indicate connection numbers.

■Remote password lock status system port (Un\G271)

Address	Description
Un\G271	Stores the remote password lock status of the system port in b0 to b4. 0: Unlocked or remote password not set 1: Lock status The bits corresponding to each system port are shown below. b0: Auto-open UDP port b1: MELSOFT transmission port (UDP/IP) b2: MELSOFT transmission port (TCP/IP) b3: FTP transmission port b4: MELSOFT direct connection

Discard received data at CPU STOP setting area

■ Discard received data at CPU STOP setting area (Un\G275)

Stores one of the following bit patterns for each connection number.

- 0: Disable (The receive data is not discarded during CPU STOP.)
- 1: Enable (The receive data is discarded during CPU STOP.)

Address	b15	b14	b13	b12	b11	b10	b9	b8	b7	b6	b5	b4	b3	b2	b1	b0
Un\G275	16	15	14	13	12	11	10	9	8	7	6	5	4	3	2	1

The numbers in the table indicate connection numbers.

Forced connection invalidation setting area

If the connection to be established is already unintentionally "connected", the connection may have been done deliberately in bad faith. Turn on the area that corresponds to the target connection and execute forced invalidation.

■ Forced connection invalidation setting area (Un\G280)

Set the connection to be forcibly invalidated.

- 0: Use allowed
- 1: Use prohibited

Address	b15	b14	b13	b12	b11	b10	b9	b8	b7	b6	b5	b4	b3	b2	b1	b0
Un\G280	16	15	14	13	12	11	10	9	8	7	6	5	4	3	2	1

The numbers in the table indicate connection numbers.

■ Forced connection invalidation system port (Un\G281)

Address	Description
Un\G281	<p>Set the system port to be forcibly invalidated.</p> <p>0: Use allowed 1: Use prohibited</p> <p>The bits corresponding to each system port are shown below.</p> <p>b0: Auto-open UDP port b1: MELSOFT transmission port (UDP/IP) b2: MELSOFT transmission port (TCP/IP) b3: FTP transmission port b4: MELSOFT direct connection</p>

Time setting function (SNTP) area

■Time setting function operation result (Un\G290)

Address	Description
Un\G290	Stores the operation result of the time setting function. 0: Unexecuted 1: Success FFFFH: Failure

■Time setting function execution time (Un\G291 to Un\G297)

Address	Name	Description
Un\G291	Year	Stores the year that the time setting function was executed.
Un\G292	Month	Stores the month that the time setting function was executed.
Un\G293	Day	Stores the date that the time setting function was executed.
Un\G294	Hour	Stores the time (hour) that the time setting function was executed.
Un\G295	Minute	Stores the time (minute) that the time setting function was executed.
Un\G296	Second	Stores the time (second) that the time setting function was executed.
Un\G297	Day of the week	Stores the day of the week that the time setting function was executed. 0: Sunday 1: Monday 2: Tuesday 3: Wednesday 4: Thursday 5: Friday 6: Saturday

■Time setting function required response time (Un\G298)

Address	Description
Un\G298	Stores the time required for the module to set the time after sending to the SNTP server. Range: 0 to FFFEH (Unit: ms)

■Time setting function (SNTP client) execution (Un\G229)

Address	Description
Un\G229	Executes the time setting function when b0 is turned on. The time setting function can be executed at a random time from a program. The function is not executed if b0 is turned on during execution of the time setting function. This is valid only when "Use" is set for "Time Setting (SNTP Client)" under "Time Setting" in "Application Settings".

A

Connection close wait time setting area for socket communications (TCP/IP)

■Enabling/disabling connection close wait time setting (Un\G760)

Set enabling/disabling connection close wait time setting for each connection (Nos. 1 to 16) using the bit patterns listed below.

- 0: Disable
- 1: Enable*1

*1 To close the connection and then reopen it from the external device with this setting enabled, the external device needs to reopen it after the close request is sent and the timer value of the latency time setting has elapsed. Reopening the connection before the time has elapsed may fail the open processing.

Address	b15	b14	b13	b12	b11	b10	b9	b8	b7	b6	b5	b4	b3	b2	b1	b0
Un\G760	16	15	14	13	12	11	10	9	8	7	6	5	4	3	2	1

The numbers in the table indicate connection numbers.

This setting is applicable only to socket communications (TCP/IP). Other communication methods are excluded.

When the communication is disconnected from the external device, the setting of enable/disable is reflected. However, this does not apply when the own CPU module executes SP.SOC_CLOSE to disconnect the communication.

■Connection close wait time setting timer value (Un\G761)

Address	Description
Un\G761	Set the timer value (ms) of the connection close wait time setting. Range: 0 to 5000*1 When Un\G760 is "Enable" at the disconnection, the disconnection timing of the own CPU module is delayed by the timer setting value of Un\G761.

*1 When a value outside the range (5001 to 65535) is set, the latency time is 5000ms.

Connection status storage area

■Latest error code connection No.1 (communication error) to latest error code connection No.16 (communication error) (Un\G770 to Un\G785)

The latest error code (communication error) for each connection is stored.

Address	Name
Un\G770	Latest error code connection No.1 (communication error)
Un\G771	Latest error code connection No.2 (communication error)
⋮	
Un\G784	Latest error code connection No.15 (communication error)
Un\G785	Latest error code connection No.16 (communication error)

■FTP server latest error code (communication error) (Un\G786)

The latest error code (communication error) for the FTP server is stored.

Address	Name
Un\G786	FTP server latest error code (communication error)

■MELSOFT direct connection latest error code (communication error) (Un\G787)

The latest error code (communication error) for MELSOFT direct connection is stored.

Address	Name
Un\G787	MELSOFT direct connection latest error code (communication error)

■FTP client latest error code (communication error) (Un\G788)

The latest error code (communication error) for the FTP client is stored.

Address	Name
Un\G788	FTP client latest error code (communication error)

■Auto-open UDP port latest error code (communication error) (Un\G789)

The latest error code (communication error) for the auto-open UDP port is stored.

Address	Name
Un\G789	Auto-open UDP port latest error code (communication error)

■MELSOFT connection auto-open UDP port latest error code (communication error) (Un\G790)

The latest error code (communication error) for the MELSOFT connection auto-open UDP port is stored.

Address	Name
Un\G790	MELSOFT connection auto-open UDP port latest error code (communication error)

■MELSOFT connection auto-open TCP port latest error code (communication error) (Un\G791)

The latest error code (communication error) for the MELSOFT connection auto-open TCP port is stored.

Address	Name
Un\G791	MELSOFT connection auto-open TCP port latest error code (communication error)

■Send buffer memory number of exhaustion (Un\G792)

The insufficient send buffer or memory count is stored.

Address	Name
Un\G792	Send buffer memory number of exhaustion

Simple CPU communication function

■Request to start communication at request for each setting number (Un\G1090 to Un\G1093)

This request contact sends and receives the data when the communication setting is "On Request" and is stored using the following bit pattern for each setting number.

- Off → On: Requested (start request)
- On → Off: Completed (start completion)

Address	b15	b14	b13	b12	b11	b10	b9	b8	b7	b6	b5	b4	b3	b2	b1	b0
Un\G1090	16	15	14	13	12	11	10	9	8	7	6	5	4	3	2	1
⋮																
Un\G1093	64	63	62	61	60	59	58	57	56	55	54	53	52	51	50	49

■Request to stop fixed interval communication for each setting number (Un\G1094 to Un\G1097)

This request contact stops the data send when the communication setting is "Fixed Interval" and is stored using the following bit pattern for each setting number.

- Off → On: Requested (stop request)
- On → Off: Completed (stop completion)

Address	b15	b14	b13	b12	b11	b10	b9	b8	b7	b6	b5	b4	b3	b2	b1	b0
Un\G1094	16	15	14	13	12	11	10	9	8	7	6	5	4	3	2	1
⋮																
Un\G1097	64	63	62	61	60	59	58	57	56	55	54	53	52	51	50	49

■Request to restart fixed interval communication for each setting number (Un\G1098 to Un\G1101)

This request contact restarts the data send when the communication setting is "Fixed Interval" and is stored using the following bit pattern for each setting number.

- Off → On: Requested (restart request)
- On → Off: Completed (restart completion)

Address	b15	b14	b13	b12	b11	b10	b9	b8	b7	b6	b5	b4	b3	b2	b1	b0
Un\G1098	16	15	14	13	12	11	10	9	8	7	6	5	4	3	2	1
⋮																
Un\G1101	64	63	62	61	60	59	58	57	56	55	54	53	52	51	50	49

■ Execution status flag for each setting number (Un\G1102 to Un\G1105)

The status of data communication is stored using the following bit pattern for each setting number.

- Off: Communication stop (function not used)
- On: Communicating

Address	b15	b14	b13	b12	b11	b10	b9	b8	b7	b6	b5	b4	b3	b2	b1	b0
Un\G1102	16	15	14	13	12	11	10	9	8	7	6	5	4	3	2	1
⋮																
Un\G1105	64	63	62	61	60	59	58	57	56	55	54	53	52	51	50	49

■ Preparation completion for each setting number (Un\G1106 to Un\G1109)

The preparation completion status of the simple CPU communication is stored using the following bit pattern for each setting number.

- Off: Not ready (function not used)
- On: Ready

Address	b15	b14	b13	b12	b11	b10	b9	b8	b7	b6	b5	b4	b3	b2	b1	b0
Un\G1106	16	15	14	13	12	11	10	9	8	7	6	5	4	3	2	1
⋮																
Un\G1109	64	63	62	61	60	59	58	57	56	55	54	53	52	51	50	49

■ Simple CPU communication status for each setting number (Un\G1130 to Un\G1193)

Address	Name	Description
Un\G1130	Simple PLC status setting No.1	The simple CPU communication status is stored. 0H: Unset (function not used) 1H: Preparing 2H: Waiting for the request 3H: Communicating 4H: Communication stop 5H: Retry being executed 6H: Monitoring at error AH: Communications impossible
Un\G1131	Simple PLC status setting No.2	
⋮		
Un\G1192	Simple PLC status setting No.63	
Un\G1193	Simple PLC status setting No.64	

■ Simple CPU communication error code for each setting number (Un\G1194 to Un\G1257)

Address	Name	Description
Un\G1194	Simple PLC error code setting No.1	The cause of the error detected in the simple CPU communication is stored. 0: No error (function not used) Other than 0: Error code (Page 443 List of Error Codes) The value is cleared to 0 with a clear request from the engineering tool.
Un\G1195	Simple PLC error code setting No.2	
⋮		
Un\G1256	Simple PLC error code setting No.63	
Un\G1257	Simple PLC error code setting No.64	

■ Execution interval (current value) for each setting number (Un\G1258 to Un\G1321)

Address	Name	Description
Un\G1258	Execution interval (current value) setting No.1	If "Fixed" is set for communication setting, the current value of the execution interval is stored. 0: Unset (function not used), communications impossible, "Communication Setting" is "On Request" Other than 0: Execution interval (unit: ms)
Un\G1259	Execution interval (current value) setting No.2	
⋮		
Un\G1320	Execution interval (current value) setting No.63	
Un\G1321	Execution interval (current value) setting No.64	

■ Abnormal response code for each setting number (Un\G1322 to Un\G1385)

Address	Name	Description
Un\G1322	Abnormal response code setting No.1	The abnormal response code detected in the simple CPU communication is stored. 0: No error (function not used) Other than 0: Abnormal response code For abnormal response codes, refer to the manual for the external device.
Un\G1323	Abnormal response code setting No.2	
⋮		
Un\G1384	Abnormal response code setting No.63	
Un\G1385	Abnormal response code setting No.64	

Appendix 4 Dedicated Instruction

This section describes the dedicated instruction that can be used in Ethernet.

The following shows the meaning of the marks in the tables of this chapter.

○: Available, ×: Not available

Point

For details on dedicated instructions used in the RJ71EN71 and RnENCPU (network part), refer to the following.

📖 MELSEC iQ-R Programming Manual (Module Dedicated Instructions)

For details on dedicated instructions used in the CPU module (built-in Ethernet port part), refer to the following.

📖 MELSEC iQ-R Programming Manual (CPU Module Instructions, Standard Functions/Function Blocks)

Precautions

■Data change

Do not change any data specified (such as control data) until execution of the dedicated instruction is completed.

■When the dedicated instruction is not completed

Check whether "Module Operation Mode" in "Application Settings" of the RJ71EN71 and the RnENCPU (network part) is "Online".

A dedicated instruction cannot be executed when the mode is "Offline" or "Module Communication Test".

Open/close processing instructions

The following table lists the Ethernet instructions to connect or disconnect the connection with the communication destination.

Instruction symbol	Description	RJ71EN71, RnENCPU (network part)	CPU module (built-in Ethernet port part)
GP.OPEN	Establishes a connection. (Q series compatible instruction)	○	×
ZP.OPEN		○	×
GP.CONOPEN	Establishes a connection.	○	×
SP.SOCOPEN		×	○
GP.CLOSE	Closes the connection. (Q series compatible instruction)	○	×
ZP.CLOSE		○	×
GP.CONCLOSE	Closes the connection.	○	×
SP.SOCCLOSE		×	○

Instruction for SLMP communications

The following table lists the built-in Ethernet instructions used for communications using the SLMP.

Instruction symbol	Description	RJ71EN71, RnENCPU (network part)	CPU module (built-in Ethernet port part)
SP.SLMPSND	Sends SLMP message to the SLMP-compatible device.	×	○

Instructions for predefined protocol communications

The following table lists the Ethernet instructions and built-in Ethernet instructions used for communications using the communication protocol.

Instruction symbol	Description	RJ71EN71, RnENCPU (network part)	CPU module (built-in Ethernet port part)
GP.ECPRTCL	Executes the protocol registered with the engineering tool's communication protocol support function.	○	×
SP.ECPRTCL		×	○
SP.SOCCINF ^{*1}	Reads connection information	×	○ ^{*2}
SP.SOCCSET ^{*1}	Changes the communication target	×	○ ^{*2}

*1 These instructions are the same as the instruction for the socket communications (SP.SOCCINF/SP.SOCCSET). (MELSEC iQ-R Programming Manual (CPU Module Instructions, Standard Functions/Function Blocks))

*2 Only the following models can be used. The supporting firmware version differs depending on the model.

- R00CPU, R01CPU, R02CPU: There are no restrictions on the version.
- Programmable controller CPUs other than the above: "29" or later

Socket communications instructions

The following table lists the Ethernet instructions and built-in Ethernet instructions used for socket communications.

Instruction symbol	Description	RJ71EN71, RnENCPU (network part)	CPU module (built-in Ethernet port part)
GP.SOCRCV	Reads the receive data from the external device.	○	×
SP.SOCRCV		×	○
G.SOCRCVS		○	×
S.SOCRCVS		×	○
GP.SOCSND	Sends data to the external device.	○	×
SP.SOCSND		×	○
SP.SOCCINF	Reads connection information	×	○
SP.SOCCSET	Changes the communication target	×	○
SP.SOCRMODE	Changes the connection receive mode.	×	○
S.SOCRDATA	Reads the specified size of data from the socket communication receive data area.	×	○
SP.SOCRDATA		×	○

Point

If the instruction has a completion device, do not change the various data (such as control data and request data) specified with the executed instruction until execution of the instruction is completed.

Instructions for communications using the fixed buffer

The following table lists the Ethernet instructions used for communications using the fixed buffer.

Instruction symbol	Description	RJ71EN71, RnENCPU (network part)	CPU module (built-in Ethernet port part)
GP.BUFRVCV	Reads the receive data from the external device.	○	×
ZP.BUFRVCV		○	×
G.BUFRCVS	Reads the receive data with an interrupt program.	○	×
Z.BUFRCVS		○	×
GP.BUFSND	Sends data to the external device.	○	×
ZP.BUFSND		○	×

Link dedicated instructions

The following table lists the instructions common to Ethernet and CC-Link IE used for transient transmission with programmable controllers on other stations.

A station on a network other than Ethernet can also be accessed. ( Page 532 Communications with Different Networks)

Instruction symbol	Description	RJ71EN71, RnENCPU (network part)	CPU module (built-in Ethernet port part)
JP.READ	Reads data from the word device of another station.	<input type="radio"/>	×
GP.READ		<input type="radio"/>	×
JP.SREAD	Reads data from the word device of another station. (with completion device)	<input type="radio"/>	×
GP.SREAD		<input type="radio"/>	×
JP.WRITE	Writes data in the word device of another station.	<input type="radio"/>	×
GP.WRITE		<input type="radio"/>	×
JP.SWRITE	Writes data in the word device of another station. (with completion device)	<input type="radio"/>	×
GP.SWRITE		<input type="radio"/>	×
JP.SEND	Sends data to another station.	<input type="radio"/>	×
GP.SEND		<input type="radio"/>	×
JP.RECV	Reads the receive data from another station. (for main program)	<input type="radio"/>	×
GP.RECV		<input type="radio"/>	×
G.RECVS	Reads the receive data from another station. (for interrupt program)	<input type="radio"/>	×
Z.RECVS		<input type="radio"/>	×
J.ZNRD	Reads data from the word device in another station (ACPU).	<input type="radio"/>	×
JP.ZNRD		<input type="radio"/>	×
J.ZNWR	Writes data in the word device in another station (ACPU).	<input type="radio"/>	×
JP.ZNWR		<input type="radio"/>	×
J.REQ	Requests the remote RUN/STOP to the CPU module on another station.	<input type="radio"/>	×
JP.REQ		<input type="radio"/>	×
G.REQ		<input type="radio"/>	×
GP.REQ		<input type="radio"/>	×
J.REQ	Reads/Writes the clock data from/to the CPU module of other stations.	<input type="radio"/>	×
JP.REQ		<input type="radio"/>	×
G.REQ		<input type="radio"/>	×
GP.REQ		<input type="radio"/>	×

A

Precautions

When executing multiple link dedicated instructions simultaneously, check that the channels for the instructions are not duplicated. Link dedicated instructions with the same channel cannot be executed simultaneously. To use the same channel for multiple link dedicated instructions, configure an interlock so that an instruction is executed after completion of another.

File transfer function instruction

The following table lists the built-in Ethernet instructions used for the file transfer function (FTP client).

Instruction symbol	Description	RJ71EN71, RnENCPU (network part)	CPU module (built-in Ethernet port part)
SP.FTPPUT	This instruction sends files in the CPU module (FTP client) to the folder path of the specified FTP server.	×	<input type="radio"/>
SP.FTPGET	This instruction retrieves files on the FTP server to the folder path of the specified CPU module (FTP client).	×	<input type="radio"/>

Other dedicated instructions

The following table lists the other Ethernet instructions.

Instruction symbol	Description	RJ71EN71, RnENCPU (network part)	CPU module (built-in Ethernet port part)
GP.ERRCLEAR	Turns off the LED and clears error information.*1	○	×
ZP.ERRCLEAR		○	×
GP.ERRRD	Reads error information.	○	×
ZP.ERRRD		○	×
G.UINI	Performs re-initial processing.	○	×
GP.UINI		○	×
Z.UINI		○	×
ZP.UINI		○	×

*1 Availability for turning off the LED depends on the firmware version of the RJ71EN71. (📖 Page 564 Added and Enhanced Functions)

Appendix 5 TCP/IP Communications, UDP/IP Communications

This chapter describes the communication flow and procedure of TCP/IP communications and UDP/IP communications.

TCP/IP communications

This section describes TCP/IP communications.

Establishing a connection

With TCP/IP communications, a connection must be established between the communicating devices. If the server side device has executed the Passive open processing and is in the standby state, the client side device makes an open request (Active open processing) to the server. When a response is returned, the connection is established.

With TCP/IP communications, a connection is established during communication. Since data is exchanged while checking that the data has correctly reached the communication destination, the data reliability can be ensured. Note that the line load is larger than UDP/IP communications.

Ex.

When the Ethernet-equipped module is Passive open

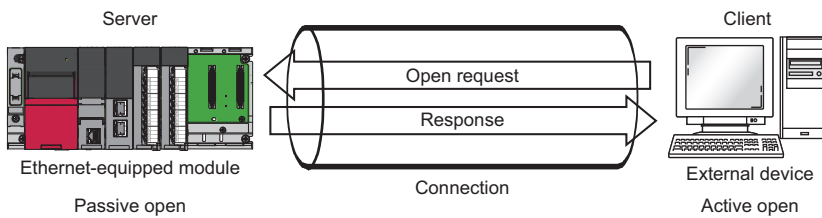

Communication flow

This section describes the flow from the establishment of connection to end of communication.

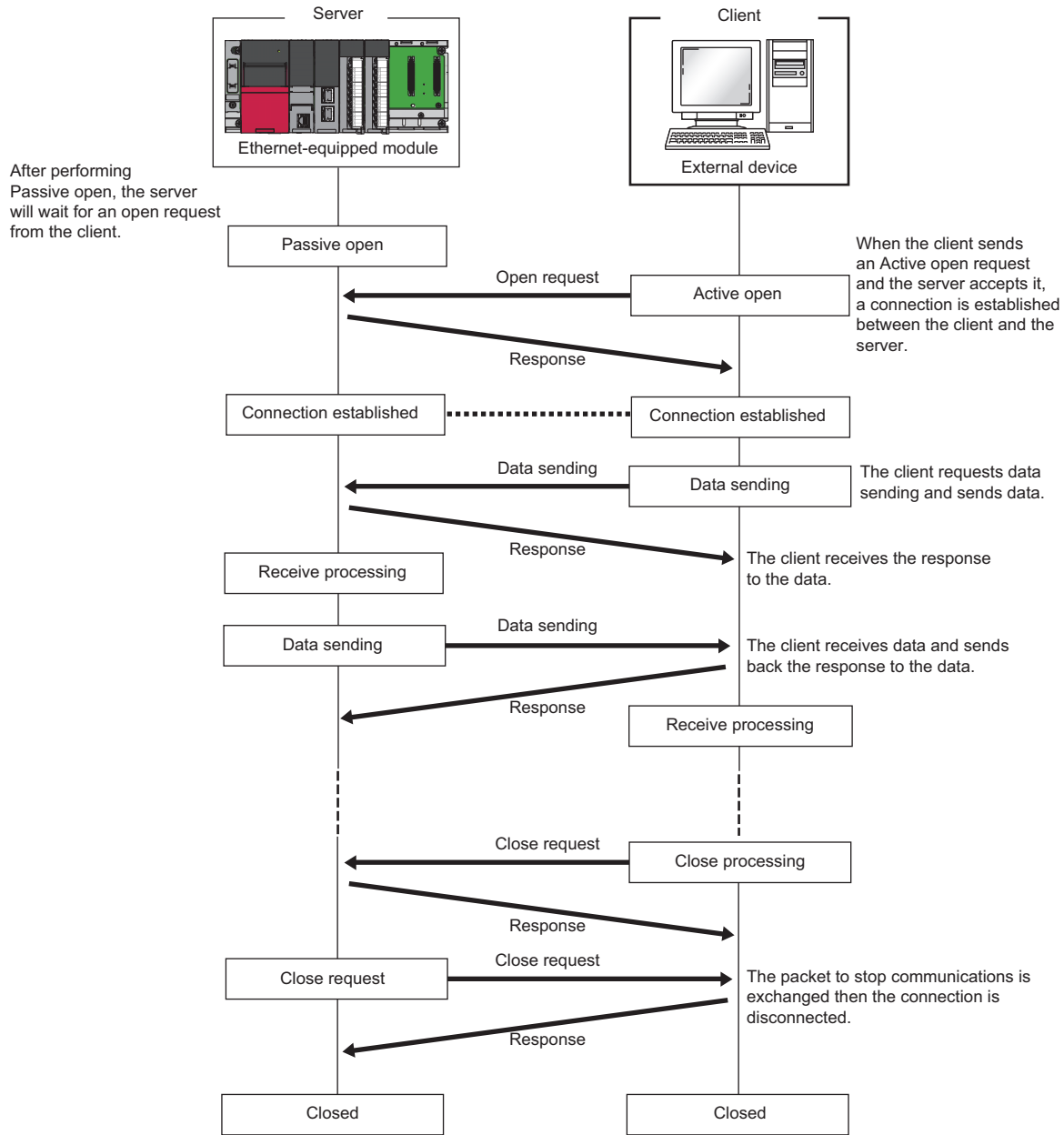

Point

Wait at least 500ms or more before executing the open processing again after the close request is sent from the external device to the Ethernet-equipped module.

Active open procedure

Active open is a connection method that performs an active open processing in respect to an external device (Passive open) that is in a passive open standby state for a connection. The following figure shows the process for the Ethernet-equipped module to Active open.

For OPEN/CLOSE instruction, refer to the following.

📖 MELSEC iQ-R Programming Manual (Module Dedicated Instructions)

Ex.

Open/close processing for connection No.1

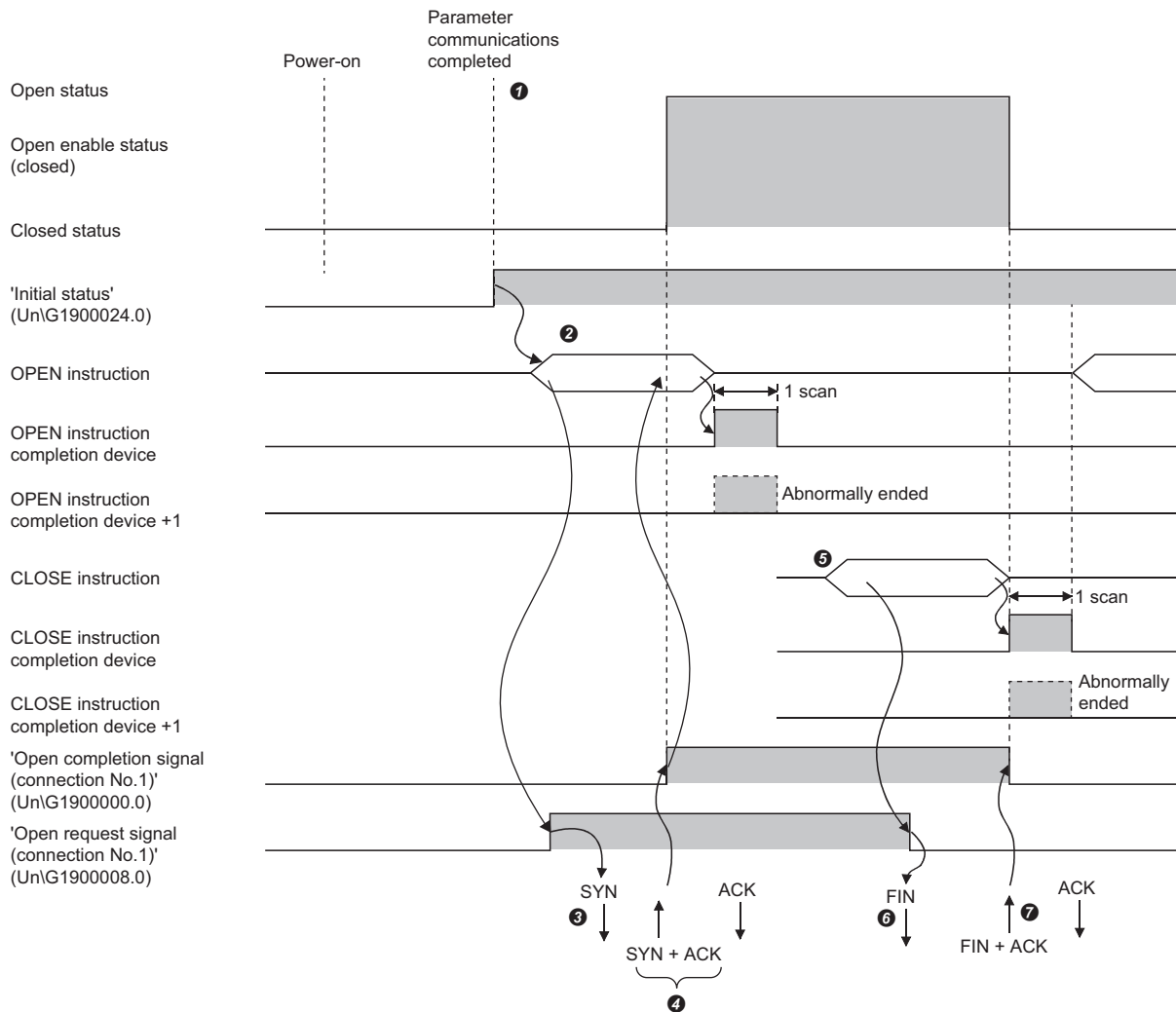

- ❶ After the module parameters are set, check that the initial processing for the Ethernet-equipped module has been completed normally. ('Initial status' (Un\G1900024.0): On)
- ❷ Start the open processing using the OPEN instruction.*³ ('Open request signal (connection No.1)' (Un\G1900008.0): On)
- ❸ The Ethernet-equipped module executes the open processing. (The module sends open request (SYN) to the external device.)
- ❹ Data can be exchanged after the open processing completes normally.*¹
- ❺ Start the close processing using the CLOSE instruction. ('Open request signal (connection No.1)' (Un\G1900008.0): Off)
- ❻ The Ethernet-equipped module executes the close processing. (The module sends close request (FIN) to external device.)
- ❼ Data communication ends when close processing completes normally.*²

*¹ If RST is returned from the external device after SYN is sent from the Ethernet-equipped module, open abnormal completion occurs immediately, and the open processing ends.

*² If ACK or FIN is not returned even after the TCP end timer time, the Ethernet-equipped module forcibly cuts off the connection (sends RST). (Close abnormal completion)

*³ If the open processing target port has not been linked up, the OPEN instruction will complete with an error. Execute the open processing again after link-up, or check that 'Connection status' (Un\G5192) is set to 1 before starting the open processing. If auto-negotiation fails, the open processing will complete with an error. Retry the open processing after a while. If the open processing completes with an error again, check the Ethernet cable connection or the operation of the external device and switching hub.



Passive open procedure

The following two types of connection methods can be used to Passive open the Ethernet-equipped module.

Connection method	Description
Unpassive	This connection method executes a passive open processing for the connection to all devices connected to the network without restriction to the IP address or port number of the communication destination.
Fullpassive	When the IP address and port number of the communication destination are specified, this connection method executes a passive open processing for the connection of the specific external device.

The open/close processing procedure for Passive open follows the setting of "Opening Method" under "Own Node Settings" in "Basic Settings". ( Page 318 Own Node Settings)

■When "Do Not Open by Program" is set

The Ethernet-equipped module is constantly in the open standby state, so the connection is established when Active open is initiated by the external device. This eliminates the need for an open/close processing program on the Ethernet-equipped module side.

Ex.

Open/close processing for connection No.1

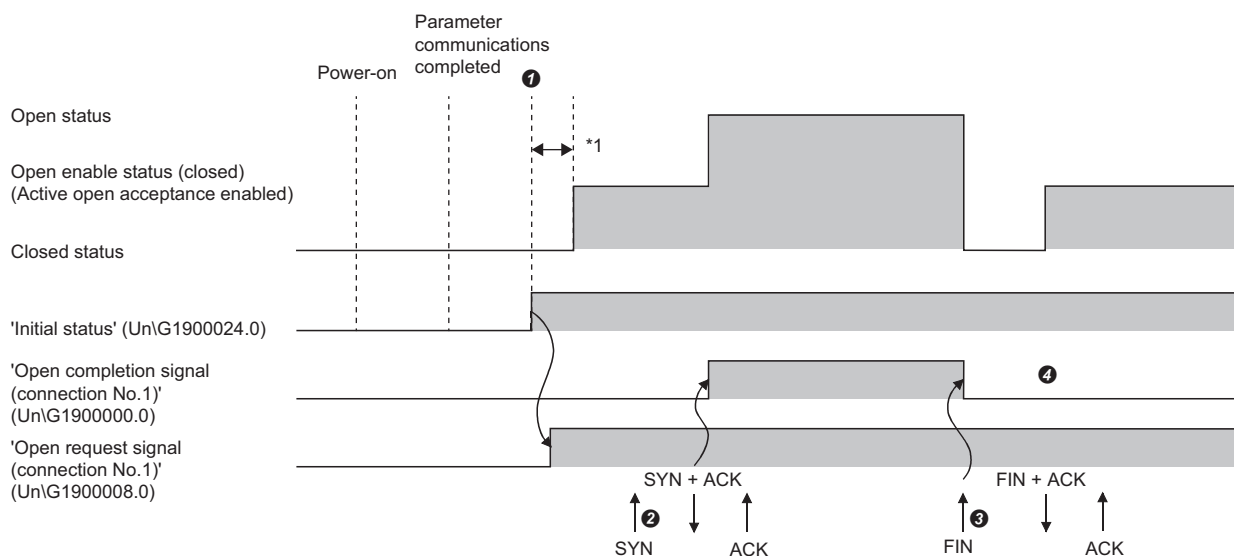

- ① After the module parameters are set, check that the initial processing for the Ethernet-equipped module has completed normally. ('Initial status' (Un\G1900024.0): On) When the initial processing completes normally, the connection enters the open enable state, and the module waits for the open request from the external device.
 - ② The Ethernet-equipped module executes the open processing when an open request (SYN) is received from the external device. When the open processing ends normally, 'Open completion signal (connection No.1)' (Un\G1900000.0) turns on and data communication is enabled.
 - ③ The Ethernet-equipped module executes the close processing when the close request (FIN) is received from the external device. When the close processing completes normally, the open completion signal turns off and data communication is disabled.
 - ④ After the internal processing in the Ethernet-equipped module completes, the connection stands by for the open request again.
- *1 The open request (SYN) received between the initial processing normal completion to the open request standby state is handled as an error, and the Ethernet-equipped module sends a connection forced close (RST) (to the external device that sent the open request (SYN)).

Point

When the open/close processing is executed with a dedicated instruction from the Ethernet-equipped module, even if "Do Not Open by Program" is set in "Opening Method" under "Own Node Settings" in "Basic Settings", the connection will not return to the open request standby state after the close processing completes.

■When "Open by Program" is set

Before the open/close request is received from the external device, the Ethernet-equipped module must execute the OPEN/CLOSE instruction and enter the open/close standby state. Data can be sent and received after the open processing completes normally.

For OPEN/CLOSE instruction, refer to the following.

📖 MELSEC iQ-R Programming Manual (Module Dedicated Instructions)

Ex.

Open/close processing for connection No.1

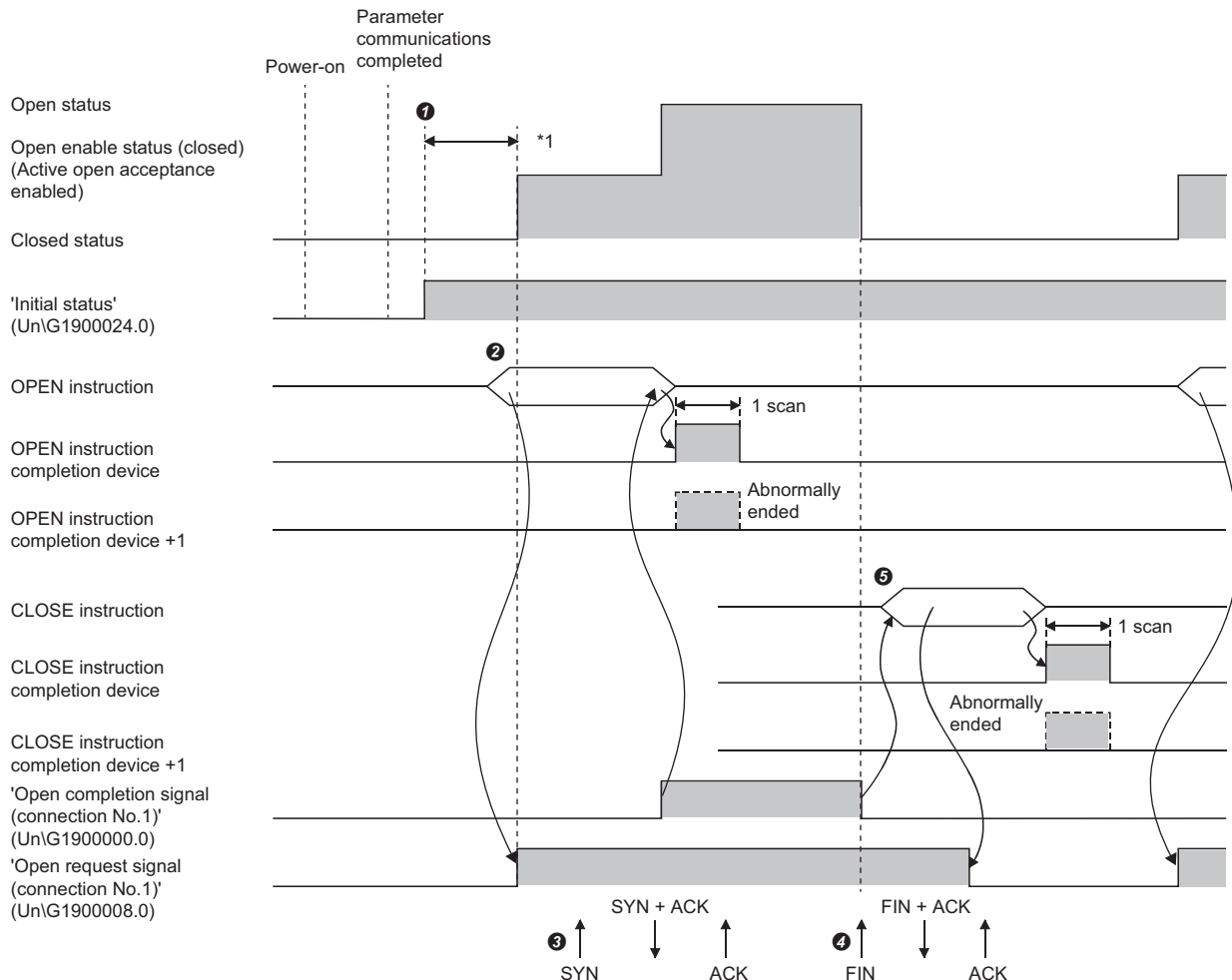

- ❶ After the module parameters are set, check that the initial processing for the Ethernet-equipped module has completed normally. ('Initial status' (UnG1900024.0): On)
 - ❷ Start the open processing using the OPEN instruction. ('Open request signal (connection No.1)' (UnG1900008.0): On)
 - ❸ The Ethernet-equipped module executes the open processing when an open request (SYN) is received from the external device. When the open processing ends normally, 'Open completion signal (connection No.1)' (UnG1900000.0) turns on and data communication is enabled.
 - ❹ The Ethernet-equipped module executes the close processing when the close request (FIN) is received from the external device. When the close processing completes normally, the open completion signal turns off and data communication is disabled.
- *1 The open request (SYN) received between the initial processing normal completion to the open request standby state is handled as an error, and the Ethernet-equipped module sends a connection forced close (RST) (to the external device that sent the open request (SYN)).

Point

- Change the connection setting before executing the OPEN instruction.
- After the open processing is executed, the open request cannot be canceled until the open processing completes. Execute the close processing (CLOSE instruction) after open completes.

A

UDP/IP communications

This section describes the UDP/IP communications. Since UDP/IP communications does not establish a connection during communication and does not check that the communication destination has correctly received the data, the line load is lower. Note that the data reliability is lower than TCP/IP communications.

Communication flow

UDP/IP communications does not require a process to establish a connection with the external device as is required with TCP/IP communications.

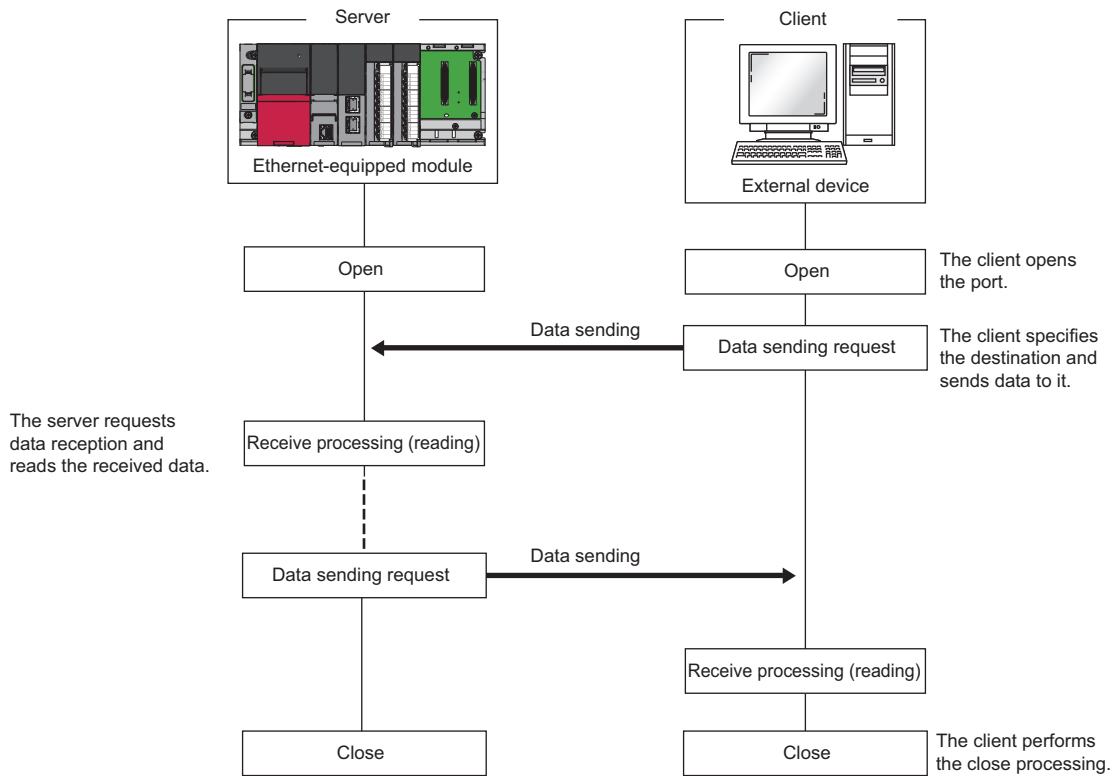

Point

Wait at least 500ms or more before executing the open processing again after the close request is sent from the external device to the Ethernet-equipped module.

Open procedure

The open/close processing procedure is as follows, according to the setting of "Opening Method" under "Own Node Settings" in "Basic Settings". (☞ Page 318 Own Node Settings)

■When "Do Not Open by Program" is set

After the Ethernet-equipped module mounted station starts up, the UDP/IP communications setting connection automatically opens, and data send/receive is enabled. Program for open/close processing is not required.

Point

When the open/close processing is executed with a dedicated instruction from the Ethernet-equipped module, even if "Do Not Open by Program" is set in "Opening Method" under "Own Node Settings" in "Basic Settings", the open/close processing after a connection with the external device is established must be executed by the program.

■When "Open by Program" is set

Before the open/close request is received from the external device, the Ethernet-equipped module must execute the OPEN/CLOSE instruction and enter the open/close standby state. Data can be sent and received after the open processing completes normally.

For OPEN/CLOSE instruction, refer to the following.

📖 MELSEC iQ-R Programming Manual (Module Dedicated Instructions)

Ex.

Open/close processing for connection No.1

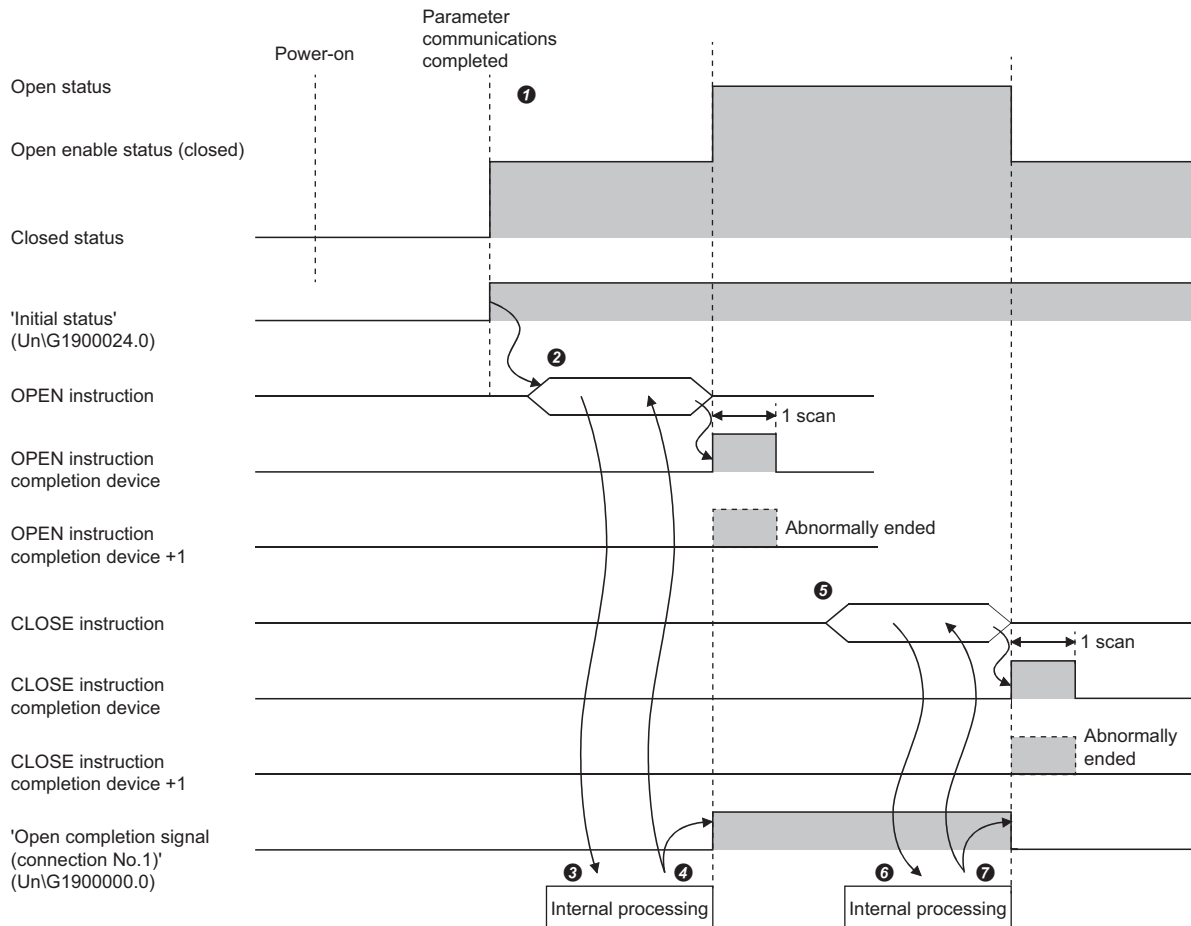

- ❶ After the module parameters are set, check that the initial processing for the Ethernet-equipped module has completed normally. ('Initial status' (Un\G1900024.0): On)
- ❷ Start the open processing using the OPEN instruction. ('Open request signal (connection No.1)' (Un\G1900008.0): On)
- ❸ The Ethernet-equipped module executes the open processing. (only internal processing)
- ❹ Data can be exchanged after the open processing completes normally.
- ❺ Start the close processing using the CLOSE instruction. ('Open request signal (connection No.1)' (Un\G1900008.0): Off)
- ❻ The Ethernet-equipped module executes the close processing. (only internal processing)
- ❼ Data communication ends when close processing completes normally.

A

Appendix 6 Communications with Different Networks

Different network stations can be accessed with dedicated instructions or the engineering tool, allowing seamless communication.

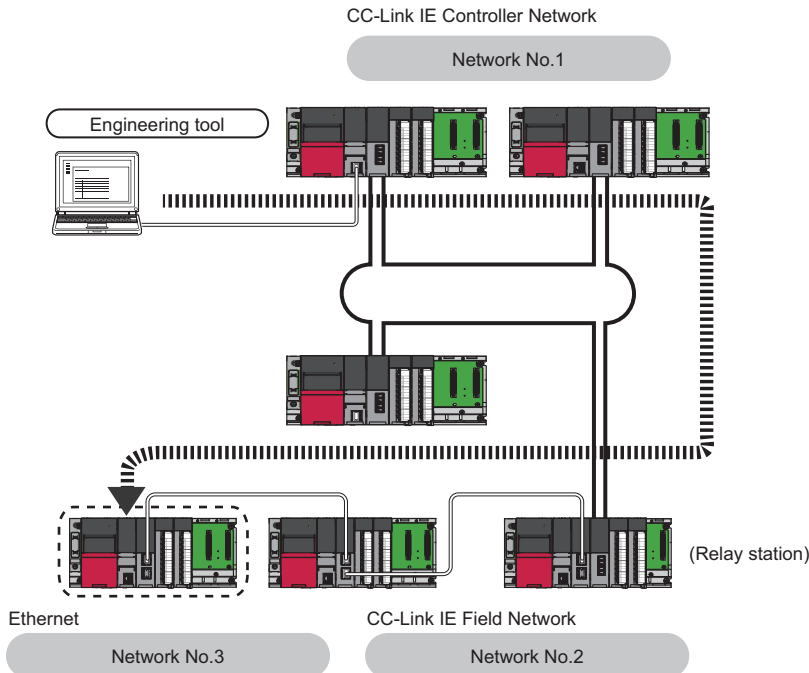

The following functions are used to communicate with different networks.

Functions capable of communication	Communication request source	Reference source
Communications using the SLMP	External device	✉ Page 31 SLMP Communications 📖 SLMP Reference Manual
Communications using a link dedicated instruction	CPU module on another station	✉ Page 120 Link Dedicated Instruction Communication
Communications with other stations using the engineering tool	Engineering tool	📖 GX Works3 Operating Manual

Point

- UDP/IP communications is used to communicate with other networks. Data is always exchanged as binary codes.
- Communications can be made with stations up to eight networks apart (number of relay stations: 7).
- When the network type for the RJ71EN71 is set to "Q Compatible Ethernet", refer to the following. (✉ Page 533 When the networks consist of MELSEC iQ-R series and other series)

When the networks consist of only MELSEC iQ-R series

Communication paths are automatically set for communication with the following networks of MELSEC iQ-R series.

- Ethernet
- CC-Link IE Controller Network
- CC-Link IE Field Network

■Setting procedure

Use the following procedure.

1. Set the network number, station number, and transient transmission group number in the "Own Node Settings" under "Basic Settings". (🔗 Page 319 Details of items)
2. Set the "Network Dynamic Routing" under "Application Settings" to "Enable".

Point

- Communication paths are automatically set, but they can also be manually set. To set communication paths manually, refer to the following. (🔗 Page 533 When the networks consist of MELSEC iQ-R series and other series)
- The communication path cannot be set automatically for Ethernet-equipped modules connected via a router. Set the communication path manually. (🔗 Page 533 When the networks consist of MELSEC iQ-R series and other series)
- After all the Ethernet-equipped module mounted stations on the path are powered on or reset, determination of the communication path may take the amount of time set in "Timer Settings for Data Communication" under "Application Settings" of the Ethernet-equipped modules on the path.

When the networks consist of MELSEC iQ-R series and other series

Setting communication paths allows communication with the following networks configured with modules other than MELSEC iQ-R series.

- Ethernet
- CC-Link IE Controller Network
- CC-Link IE Field Network
- MELSECNET/H
- MELSECNET/10

■Setting procedure

Use the following procedure.

1. Set the network number, station number, and transient transmission group number in the "Own Node Settings" under "Basic Settings". (🔗 Page 319 Details of items)
2. Set the send destination station information in "Network/Station No. <-> IP information setting" under "Application Settings". (🔗 Page 398 Network/Station No. <-> IP information setting)
3. Set communication paths in "Routing Setting" of "CPU Parameter".
(📖 MELSEC iQ-R CPU Module User's Manual (Application))

When the networks contain a redundant system

- When setting a communication path automatically, after the time specified by the destination alive check timer (time calculated from destination alive check start interval timer value, destination alive check interval timer value, and destination alive check resend count), the communication path setting will be changed. Set as small a value as possible for the "Destination Alive Check Start Interval Timer", "Destination Alive Check Interval Timer", and "Destination Alive Check Resend Count".
- When the communication paths are automatically set, the paths are updated if system switching occurs in a redundant system on the paths. During update of the communication paths, communications may be interrupted or data may be lost because the paths are temporarily undetermined. If an error occurs in communications, resend data from the request source.
- When the request source is a redundant system and the communication paths are automatically set, perform the communications from the control system. When performing the communications from the standby system, set "Routing Setting" of "CPU Parameter"
- When the request destination is a redundant system and the communication paths are automatically set, specify the control system station as the destination. When specifying the standby system as the request destination, set "Routing Setting" of "CPU Parameter".
- When relaying a redundant system and setting the communication paths manually, set the control system station as a relay station in "Routing Setting" of "CPU Parameter". If system switching occurs, the relay station needs to be changed to a station in the new control system using the RTWRITE instruction. (📖 MELSEC iQ-R Programming Manual (CPU Module Instructions, Standard Functions/Function Blocks))

Appendix 7 Processing Time

Calculate the minimum processing time for each function with the following formula. Note that the processing time may be even longer due to the network load rate (line congestion), each connected device's window size, number of connections being used simultaneously, and the system configuration. The value calculated with the following formula is a guide for the processing time when communicating with only one connection.

Minimum processing time of fixed buffer communications (between the RJ71EN71s^{*1})

*1 The processing time will be the same even if the RnENCPU (network part) is mixed.

■Procedure exists

$$Tfs = St + Ke + (Kdf \times Df) + Sr$$

- Tfs: Time from start to end of send (unit: ms)
- St: Sending station scan time
- Ke, Kdf: Constant (refer to following table)
- Df: Number of send data words
- Sr: Receiving station scan time

Item	RJ71EN71, RnENCPU			
	During TCP/IP communications		During UDP/IP communications	
	Ke	Kdf	Ke	Kdf
When communicating with binary code data	6	0.0030	3	0.0020
When communicating with ASCII code data	6	0.0100	4	0.0015

■No procedure

$$Tfs = St + Ke + (Kdf \times Df)$$

- Tfs: Time from start to end of send (unit: ms)
- St: Sending station scan time
- Ke, Kdf: Constant (refer to following table)
- Df: Number of send data bytes

Item	RJ71EN71, RnENCPU			
	During TCP/IP communications		During UDP/IP communications	
	Ke	Kdf	Ke	Kdf
When communicating with binary code data	4	0.0010	3	0.0007

Minimum processing time of communications using the random access buffer

$$Trs = Kr + (Kdr \times Df) + \text{external device ACK processing time (added only during TCP/IP communications)}$$

- Trs: Time from reception of personal computer request data to complete of process by RJ71EN71 (unit: ms)
- Kr, Kdr: Constant (refer to following table)
- Df: Number of request data words
- External device ACK process time: Time until external device returns ACK upon completion of random access buffer read/write

Item		RJ71EN71, RnENCPU			
		During TCP/IP communications		During UDP/IP communications	
		Kr	Kdr	Kr	Kdr
During read	When communicating with binary code data	2.5	0.0020	1.8	0.0025
	When communicating with ASCII code data	2.5	0.0060	1.9	0.0065
During write	When communicating with binary code data	2.5	0.0025	1.8	0.0025
	When communicating with ASCII code data	2.6	0.0070	1.9	0.0060

A

Processing time of communications using MODBUS/TCP

The following shows the time required by the Ethernet-equipped module when it receives a request message from the MODBUS/TCP master device, completes the processing, and sends a response message.

■ Calculation formula

$$Tsl = Ks1 + (Ks2 \times n1) + (St \times n2) \text{ [ms]}$$

Variable	Meaning	Processing time, constant			
Tsl	Request message processing time (performance of the automatic response function) (unit: ms)	—			
Ks1	Internal processing time of the automatic response function (unit: ms)	Fixed to 2.5ms			
Ks2	Communication time between the Ethernet-equipped module and CPU module (unit: ms)	Fixed to 4.5ms			
St	Own station scan time (unit: ms)	—			
n1	Function code for the processing target and setting details of the memory assignment	Function code	CPU module device assignment	Buffer memory assignment	
		01	1	0	
		02	1	0	
		03	1	0	
		04	1	0	
		05	1	0	
		06	1	0	
		15	1	0	
		16	1	0	
		20	1	0	
		21	1	0	
		22	2	0	
		23	2	0	
n2	Function code for the processing target and setting details of the memory assignment	Function code	CPU module device assignment		Buffer memory assignment
			Normal	Worst case	
		01	1	2	0
		02	1	2	0
		03	1	2	0
		04	1	2	0
		05	1	2	0
		06	1	2	0
		15	1	2	0
		16	1	2	0
		20	1	2	0
		21	1	2	0
		22	2	4	0
23	2	4	0		

System switching time when a redundant system is used

The following shows the system switching time when the Ethernet-equipped module mounted on the control system in the redundant system detects a communication error or cable disconnection and sends a system switching request to the control system CPU module. System switching time is the time from communication error or cable disconnection detection to when the control system CPU module is switched over.

■ Calculation formula

The following is the formula to calculate the system switching time.^{*1}

System switching cause	System switching time [ms]
Communication error detection (alive check error)	$T_{si} + (T_i \times (T_r + 1)) + T_s + T_{sw}$
Communication error detection (ULP timeout occurrence)	$T_{tu} + T_s + T_{sw}$
Disconnection detection	$T_d + T_s + T_{sw}$

*1 The meanings of the variables in the equation are as follows.

Variable	Meaning
T_{si}	Destination alive check start interval timer [ms] (📖 Page 392 Timer Settings for Data Communication)
T_i	Destination alive check interval timer [ms] (📖 Page 392 Timer Settings for Data Communication)
T_r	Destination alive check resend count (📖 Page 392 Timer Settings for Data Communication)
T_s	1 scan time [ms] (📖 MELSEC iQ-R CPU Module User's Manual (Application))
T_{sw}	CPU module system switching time [ms] (📖 MELSEC iQ-R CPU Module User's Manual (Application))
T_{tu}	TCP ULP timer value [ms] (📖 Page 392 Timer Settings for Data Communication)
T_d	Disconnection detection monitoring time [ms] (📖 Page 407 Redundant System Settings)

■ Timing chart

This section describes a timing chart for each system switching cause.

- Communication error detection (alive check error)

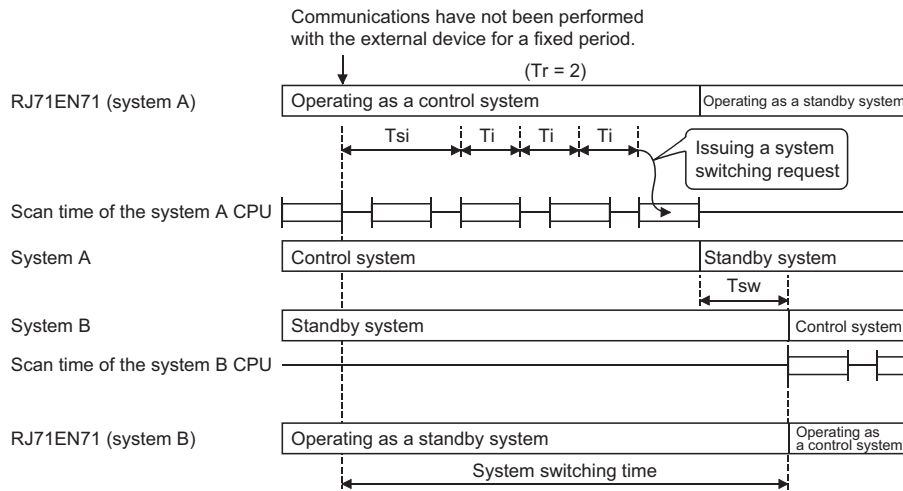

- Communication error detection (ULP timeout occurrence)

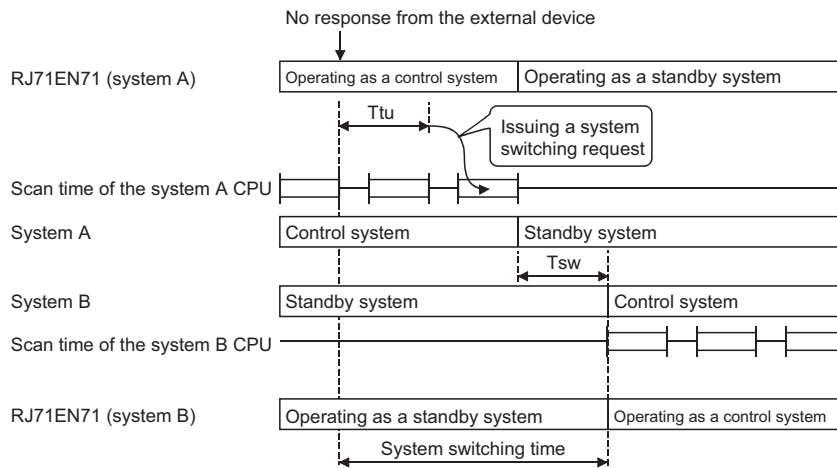

- Disconnection detection

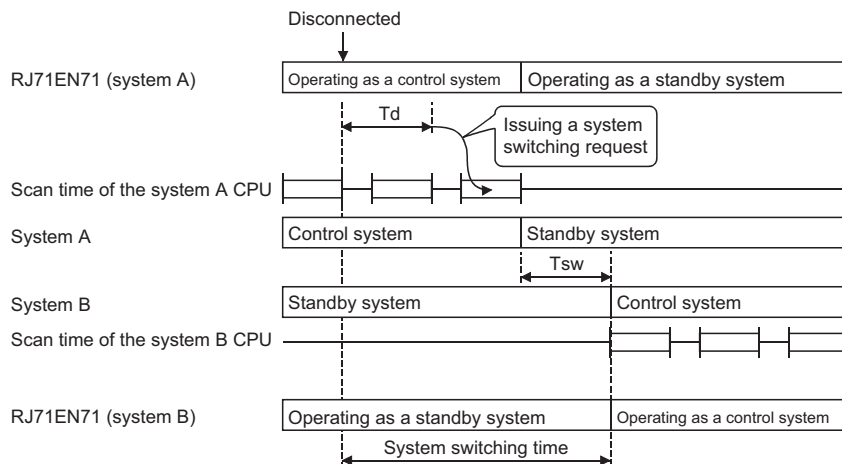

Performance list of simple CPU communication function

Execution interval

The following shows the performance of the execution interval on the simple CPU communication function (CPU module (built-in Ethernet port part)). The execution interval varies depending on the number of settings, the number of communication points, and the scan time of the CPU module. The interval is also affected by the execution conditions of other functions or Ethernet communication condition.

■When "Communication Setting" is "Fixed Interval"

- Communication setting: "Fixed Interval"
- Sequence scan time (own station): 1ms (scan time before the execution of the simple CPU communication function)
- Communication destination: MELSEC iQ-R (built-in Ethernet)^{*1}
- Device data: Bit device = M, Word device = D
- Assume the number of settings is as shown in the table and each setting is for an individual communication destination (not for the same destination). (Duplicated communication destinations may increase the execution interval. The more duplicates, the larger the delay in the execution interval, which is approximately eight times longer at maximum.)
- The retry of communication is not performed.

*1 The sequence scan time for the communication destination is 1ms (for any model).

Communication pattern	Number of communication points for one setting	Processing time by the number of settings (unit: ms)				
		1	8	16	32	64
Read	32 words for each device ^{*2} (Total 64 words)	10	11	17	34	76
	64 words for each device ^{*2} (Total 128 words)	10	11	17	35	77
	256 words for each device ^{*2} (Total 512 words)	10	13	20	— ^{*3}	— ^{*3}
Write	32 words for each device ^{*2} (Total 64 words)	10	11	18	35	77
	64 words for each device ^{*2} (Total 128 words)	10	11	18	35	80
	256 words for each device ^{*2} (Total 512 words)	10	13	20	— ^{*3}	— ^{*3}

*2 Number of points for each device (bit device and word device)

*3 Maximum number of points exceeded (maximum 8192 words)

■When "Communication Setting" is "On Request"

- Communication setting: "Fixed Interval"
- Sequence scan time (own station): 1ms (scan time before the execution of the simple CPU communication function)
- Communication destination: MELSEC iQ-R (built-in Ethernet)^{*1}
- Device data: Bit device = M, Word device = D
- Assume the number of settings is as shown in the table and each setting is for an individual communication destination (not for the same destination). (Duplicated communication destinations may increase the execution interval. The more duplicates, the larger the delay in the execution interval, which is approximately eight times longer at maximum.)
- The retry of communication is not performed.

*1 The sequence scan time for the communication destination is 1ms (for any model).

Communication pattern	Number of communication points for one setting	Processing time by the number of settings (unit: ms)					
		1		4		8	
		1st time ^{*3}	2nd time or later ^{*4}	1st time ^{*3}	2nd time or later ^{*4}	1st time ^{*3}	2nd time or later ^{*4}
Read	32 words for each device ^{*2} (Total 64 words)	6	13	8	18	13	25
	64 words for each device ^{*2} (Total 128 words)	6	13	8	18	13	25
	256 words for each device ^{*2} (Total 512 words)	6	13	8	18	13	25
Write	32 words for each device ^{*2} (Total 64 words)	6	13	8	18	13	25
	64 words for each device ^{*2} (Total 128 words)	6	13	8	18	13	25
	256 words for each device ^{*2} (Total 512 words)	6	13	8	18	13	25

*2 Number of points for each device (bit device and word device)

*3 Applicable when the identifying conditions shown below are not satisfied

*4 Applicable when the identifying conditions shown below are satisfied

[Identifying conditions]

- The communication of the same setting number has been executed for the second time or more, and the previous communication has been completed successfully without an error.
- Among the settings for the same communication destination, any of the communications is set to "Fixed Interval", and it has been executed without an error. (Except for those in a stop state.)
- Among the settings for the same communication destination, any of the communications is set to "On Request" while communications set to "Fixed Interval" do not exist or have stopped. Also, the previous execution of another setting number where the communication setting is "On Request" has been completed successfully without an error.

Appendix 8 Mounting the Module with a Remote Head Module

This chapter describes restrictions and precautions for using the RJ71EN71 that is mounted with a remote head module.

Restrictions on functions and specifications

Functions	
Function	Restriction
Communications using the SLMP	<ul style="list-style-type: none"> The command that can be used differs from that of the CPU module. (📖 SLMP Reference Manual) The file that can be operated differs from that of the CPU module. (📖 MELSEC iQ-R CC-Link IE Field Network Remote Head Module User's Manual (Application))
Communications using the predefined protocol	This function cannot be used.
Socket communications	This function cannot be used.
Communications using the fixed buffer	This function cannot be used.
Communications using MODBUS/TCP	<ul style="list-style-type: none"> When the network type is "Q Compatible Ethernet", this function cannot be used. The default values set for the MODBUS device assignment parameters cannot be used for creating a project for the engineering tool using the remote head module. Clear the values first before starting the setting.
Communications using a link dedicated instruction	Although the own station can be specified as the relay station or target station, the link dedicated instruction cannot be executed from the own station.
File transfer function (FTP server)	<ul style="list-style-type: none"> The file that can be operated differs from that of the CPU module. (📖 MELSEC iQ-R CC-Link IE Field Network Remote Head Module User's Manual (Application)) The number of files that can be written to the data memory differs from that of the CPU module. (📖 MELSEC iQ-R CC-Link IE Field Network Remote Head Module User's Manual (Startup))
Time setting function (SNTP client)	This function cannot be used.
IP filter function	When the network type is "Q Compatible Ethernet", this function cannot be used.
Simple CPU communication function	When the network type is "Q Compatible Ethernet", this function cannot be used.
Simple device communication function	This function cannot be used.
IP address change function	When the network type is "Q Compatible Ethernet", this function cannot be used.
Redundant system function	Although the RJ71EN71 can be connected to a redundant system of a remote head module, redundant system of the RJ71EN71 cannot be configured.

Module parameters

There are differences between when the RJ71EN71 is connected to the CPU module and when the RJ71EN71 is connected to the remote head module. For details, refer to the following.

📖 MELSEC iQ-R CC-Link IE Field Network Remote Head Module User's Manual (Application)

This manual describes the restrictions specific to the RJ71EN71.

Parameter name		Restrictions
Basic Settings	Own Node Settings	Select "Do Not Open by Program" for "Opening Method".
	External Device Configuration	When performing TCP/IP communications, select "Unpassive Connection Module" or "Fullpassive Connection Module" for the external device.

Open/close processing

Perform the open/close processing of the connection from the external device.

Appendix 9 Using the Module in the Redundant System with Redundant Extension Base Unit

This chapter describes restrictions and precautions for using the RJ71EN71 that is mounted on the extension base unit in the redundant system.

Restrictions on functions and specifications

Applicable network combination

Network type	Setting in GX Works3	Restrictions
Ethernet	RJ71EN71(E+E)	The network can be used for a module with firmware version of "50" or later.*1
CC-Link IE Controller Network	RJ71EN71(CCIEC)	This network type cannot be used.
CC-Link IE Field Network	RJ71EN71(CCIEF)	This network type cannot be used.
Ethernet + CC-Link IE Controller Network	RJ71EN71(E+CCIEC)	This network type cannot be used.
Ethernet + CC-Link IE Field Network	RJ71EN71(E+CCIEF)	This network type cannot be used.
Q Compatible Ethernet	RJ71EN71(Q)	The network can be used for a module with firmware version of "50" or later.*1

*1 When using the network, check the versions of the CPU module compatible with the extension base unit and the engineering tool.

Functions

Function	Restriction
Connection with MELSOFT products and a GOT	When "Not Specified" is set, a CPU module of the control system is accessed. When the CPU module in the system A is in the control system, enable communication by specifying "System A", "Control System", or "Not Specified" for "Redundant CPU Setting" in "Specify Connection Destination Connection". When the CPU module in the system A is in the standby system, enable communication by specifying "System A" or "Standby System" for "Redundant CPU Setting" in "Specify Connection Destination Connection".
Communications using the predefined protocol	This function cannot be used.
Socket communications	This function cannot be used.
Communications using the fixed buffer	When the network type is only "Q Compatible Ethernet", this function can be used. (Page 544 Example of communications using the fixed buffer)
MODBUS/TCP communications	When the network type is "Q Compatible Ethernet", this function cannot be used.
Communications using a link dedicated instruction	Although the own station can be specified as the relay station or target station, the link dedicated instruction cannot be executed from the own station.
File transfer function (FTP server)	This function cannot be used.
IP filter	When the network type is "Q Compatible Ethernet", this function cannot be used.
Simple CPU communication function	When the network type is "Q Compatible Ethernet", this function cannot be used.
Simple device communication function	This function cannot be used.
IP address change function	When the network type is "Q Compatible Ethernet", this function cannot be used.

Dedicated instructions

Any dedicated instructions of the RJ71EN71 cannot be used.

When using the dedicated instructions for the RJ71EN71, install it to the main base unit.



When the network type is "Q Compatible Ethernet", the "ERR LED off request" (Y17) can be used instead of the ERRCLEAR instruction. (Page 472 When the network type is "Q Compatible Ethernet")

Module FBs

Any module FBs of the RJ71EN71 cannot be used.

Module parameters

■Application Settings

- Set "Not Use" to "To Use or Not to Use Redundant System Settings" in "Redundant System Settings".
- Do not specify Interrupt settings.
- Set "Disable" to "Dynamic Routing Setting" under "Network Dynamic Routing".
- Set "Not Use" to "IP Packet Transfer Function" in "IP Packet Transfer Setting".

Open/close processing

The open/close processing by input/output signals cannot be performed.

Precautions

- When system switching occurs during communications using MELSOFT connection, SLMP communication from other stations, or communications using dedicated instructions of other stations, communication timeout error may occur.
- When system switching occurs during simple CPU communication, a timeout error may occur in the CPU response monitoring timer. If required, try the CPU response monitoring timer again.
- When system switching occurs during MODBUS/TCP communications, a timeout error may occur in the CPU response monitoring timer. If required, try the CPU response monitoring timer again.
- For replacement from the MELSEC-Q series, set "Q Compatible Ethernet" to the RJ71EN71 network type

Example of communications using the fixed buffer

An example of communications using a fixed buffer when the RJ71EN71 is installed to the extension base unit is shown below.

System configuration

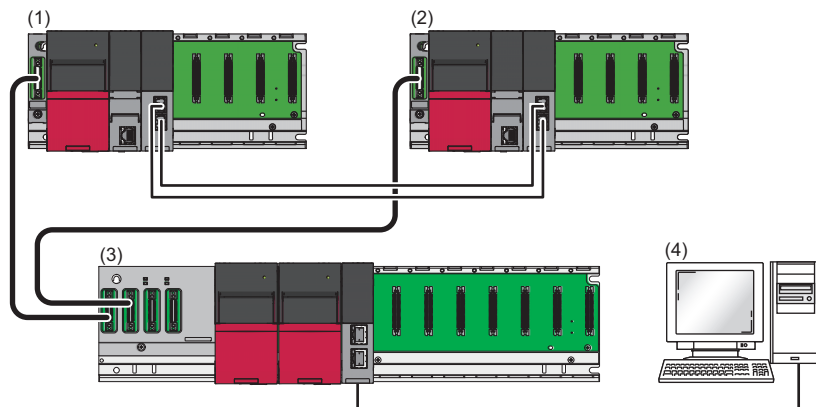

- (1) Control system (R35B, R61P, R08PCPU, R6RFM)
- (2) Standby system (R35B, R61P, R08PCPU, R6RFM)
- (3) First level (R68WRB, R63RP, R63RP, RJ71EN71)
- (4) Communication destination device

Parameter setting

Connect the engineering tool to the CPU module to be set as the control system and set the parameters.

In a redundant system, the same program and parameter are written to both systems. A new project does not need to be created for the standby system.

1. Set the CPU module as follows.

 [Project] ⇒ [New]

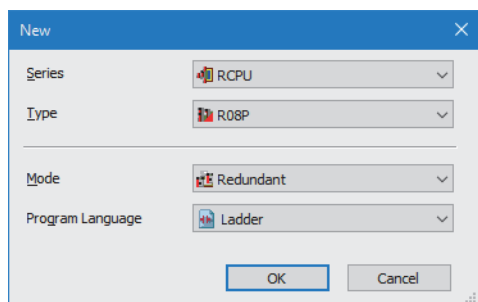

2. Click the [OK] button to add the module labels of the CPU module.

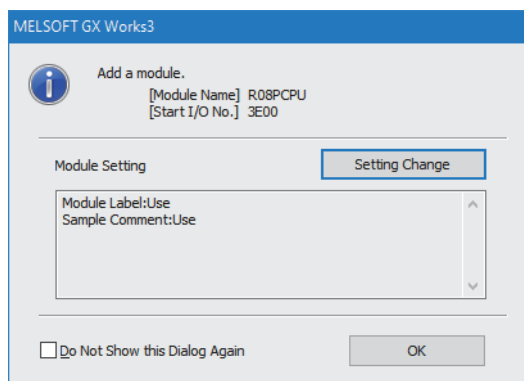

3. Set the base unit information as follows.

[Navigation window] ⇒ [Parameter] ⇒ [System Parameter] ⇒ [Base/Power/Extension Cable Setting]

Setting Item				
Read Mounting Status				
Base Mode:Details				
Base No.	Base	Slots	Power Supply Module	Extension Cable
Main	R35B	5		
Extension 1	R68WRB	8		
Extension 2				
Extension 3				

4. Specify the information for the redundant function module and RJ71EN71 as follows.

[Navigation window] ⇒ [Parameter] ⇒ [System Parameter] ⇒ [I/O Assignment Setting]

Setting Item						
Read Mounting Status						
Base Mode:Details						
Slot	Module Name	Module Status Setting	Points	Start XY	Control PLC Settings	CPU Module Operation Setting at Error Detection
Main						
CPU	R08PCPU(Host Station)			3E00		
0(0-0)	R6RFM	No Setting	32 Points	0000		Critical: Stop, Moderate: Continue
1(0-1)						
2(0-2)						
3(0-3)						
4(0-4)						
Extension 1						
5(1-0)	RJ71EN71(Q)	No Setting	32 Points	0100		Critical: Stop, Moderate: Continue
6(1-1)						

5. Set the IP address as follows.

[Navigation window] ⇒ [Parameter] ⇒ [Module Information] ⇒ [RJ71EN71(Q)] ⇒ [Basic Settings] ⇒ [Own Node Settings]

Item	Setting
Own Node Settings	
Parameter Setting Method	Parameter Editor
IP Address	
IP Address	192 . 168 . 3 . 40
Subnet Mask	. . .
Default Gateway	. . .
Communications by Network No./Station No.	
Setting Method	Disable
Setting Method	Use IP Address
Network No.	-----
Station No.	-----
Transient Transmission Group No.	0
Enable/Disable Online Change	Disable All (SLMP)
Communication Data Code	Binary
Opening Method	Do Not Open by Program
External Device Configuration	
External Device Configuration	<Detailed Setting>



6. Set the network configuration as follows.

[Navigation window] ⇒ [Parameter] ⇒ [Module Information] ⇒ [RJ71EN71(Q)] ⇒ [Basic Settings] ⇒ [External Device Configuration]

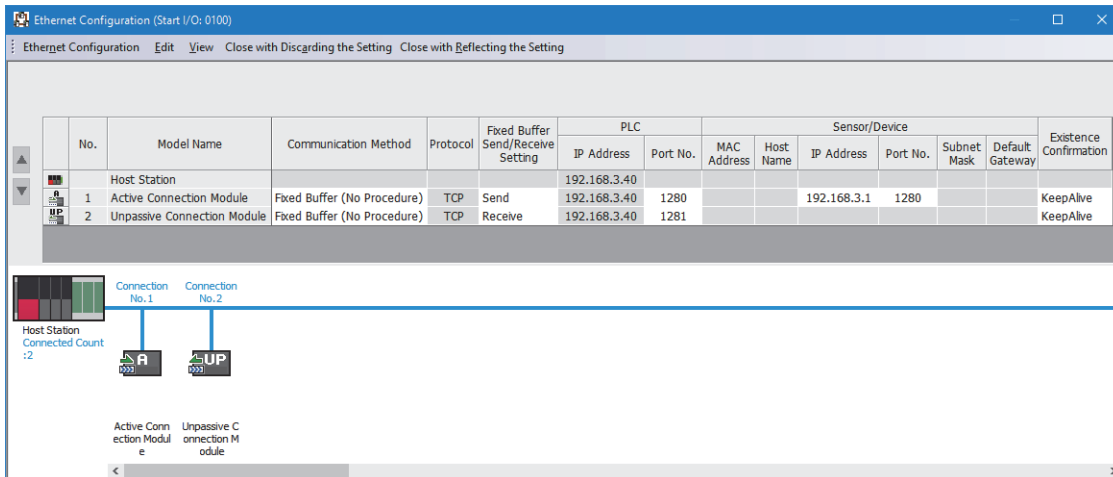

7. Set "Not Use" to "To Use or Not to Use Redundant System Settings".

[Navigation window] ⇒ [Parameter] ⇒ [Module Information] ⇒ [RJ71EN71(Q)] ⇒ [Application Settings] ⇒ [Redundant System Settings]

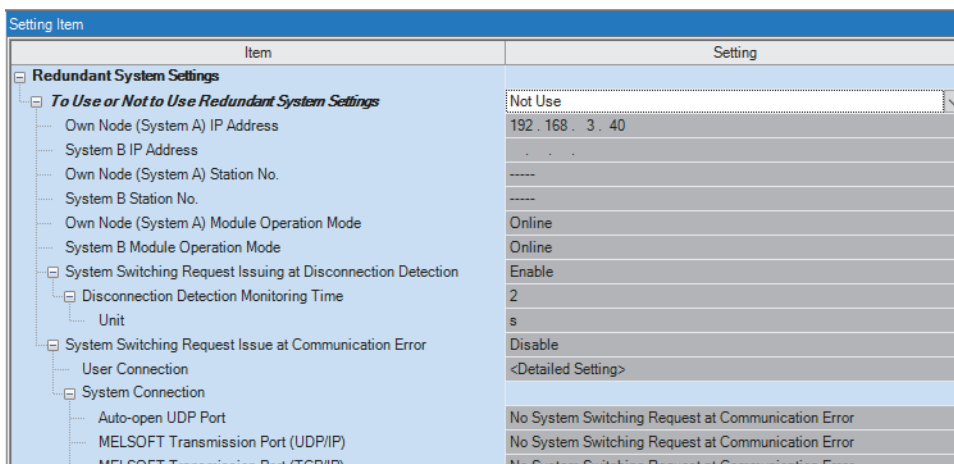

8. Write the set parameters to the control system CPU module.

[Online] ⇒ [Write to PLC]

9. Click the [Yes] button to write to the CPU modules of both systems.

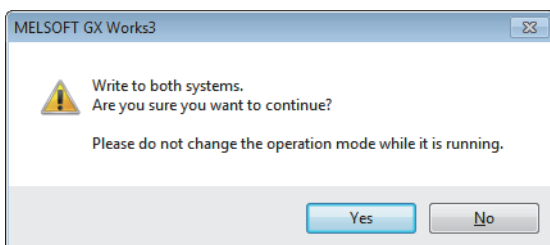

10. Either reset the CPU modules of both systems or power off and on both systems.

Point

- In this setting example, default settings other than above are used for the parameters. For the parameter setting, refer to the chapter explaining the parameters in this manual. (Page 317 PARAMETER SETTINGS)
- Since PLS instructions and other instructions in the program, check that "Transfer" has been set to "Signal Flow Memory Tracking Setting" in "Tracking Setting" under "Redundant Settings" in "CPU Parameter".

Program examples

In this example, connection No.1 is opened and data is sent to an external device.

Also, the data from an external device is received using connection No.2.

Classification	Label name																																																																																												
Label to be defined	Define global labels as shown below:																																																																																												
	<table border="1"> <thead> <tr> <th>Label Name</th> <th>Data Type</th> <th>Class</th> <th>Assign (Device/Label)</th> </tr> </thead> <tbody> <tr><td>bOpenInstruction_1</td><td>Bit</td><td>VAR_GLOBAL</td><td>X1041</td></tr> <tr><td>bSendInstruction</td><td>Bit</td><td>VAR_GLOBAL</td><td>X1043</td></tr> <tr><td>bRecvInstruction</td><td>Bit</td><td>VAR_GLOBAL</td><td>X1044</td></tr> <tr><td>bCloseInstruction_1</td><td>Bit</td><td>VAR_GLOBAL</td><td>X1045</td></tr> <tr><td>uRecvWordsCount_Tmp</td><td>Word [Unsigned]/Bit String [16-bit](0..1)</td><td>VAR_GLOBAL</td><td>D15</td></tr> <tr><td>uRecvWordsCount</td><td>Word [Unsigned]/Bit String [16-bit]</td><td>VAR_GLOBAL</td><td>D17</td></tr> <tr><td>uOpenErrCode_Tmp_1</td><td>Word [Unsigned]/Bit String [16-bit]</td><td>VAR_GLOBAL</td><td>D18</td></tr> <tr><td>uOpenErrCode_1</td><td>Word [Unsigned]/Bit String [16-bit]</td><td>VAR_GLOBAL</td><td>D100</td></tr> <tr><td>uSendErrCode_1</td><td>Word [Unsigned]/Bit String [16-bit]</td><td>VAR_GLOBAL</td><td>D108</td></tr> <tr><td>uRecvErrCode_2</td><td>Word [Unsigned]/Bit String [16-bit]</td><td>VAR_GLOBAL</td><td>D110</td></tr> <tr><td>uSendDataLength</td><td>Word [Unsigned]/Bit String [16-bit]</td><td>VAR_GLOBAL</td><td>D300</td></tr> <tr><td>uSendData</td><td>Word [Unsigned]/Bit String [16-bit](0..2)</td><td>VAR_GLOBAL</td><td>D301</td></tr> <tr><td>uRecvDataLength</td><td>Word [Unsigned]/Bit String [16-bit]</td><td>VAR_GLOBAL</td><td>D500</td></tr> <tr><td>uRecvData</td><td>Word [Unsigned]/Bit String [16-bit]</td><td>VAR_GLOBAL</td><td>D501</td></tr> <tr><td>bCommReady_1</td><td>Bit</td><td>VAR_GLOBAL</td><td>M1</td></tr> <tr><td>bCommReady_2</td><td>Bit</td><td>VAR_GLOBAL</td><td>M2</td></tr> <tr><td>bCloseOccurred_1</td><td>Bit</td><td>VAR_GLOBAL</td><td>M11</td></tr> <tr><td>bOpenImpossible_1</td><td>Bit</td><td>VAR_GLOBAL</td><td>M21</td></tr> <tr><td>bCloseAccepted_1</td><td>Bit</td><td>VAR_GLOBAL</td><td>M31</td></tr> <tr><td>bSendAccepted_1</td><td>Bit</td><td>VAR_GLOBAL</td><td>M41</td></tr> <tr><td>bOpenFailed_1</td><td>Bit</td><td>VAR_GLOBAL</td><td>M51</td></tr> <tr><td>tdOpenWait_1</td><td>Timer</td><td>VAR_GLOBAL</td><td>T1</td></tr> </tbody> </table>	Label Name	Data Type	Class	Assign (Device/Label)	bOpenInstruction_1	Bit	VAR_GLOBAL	X1041	bSendInstruction	Bit	VAR_GLOBAL	X1043	bRecvInstruction	Bit	VAR_GLOBAL	X1044	bCloseInstruction_1	Bit	VAR_GLOBAL	X1045	uRecvWordsCount_Tmp	Word [Unsigned]/Bit String [16-bit](0..1)	VAR_GLOBAL	D15	uRecvWordsCount	Word [Unsigned]/Bit String [16-bit]	VAR_GLOBAL	D17	uOpenErrCode_Tmp_1	Word [Unsigned]/Bit String [16-bit]	VAR_GLOBAL	D18	uOpenErrCode_1	Word [Unsigned]/Bit String [16-bit]	VAR_GLOBAL	D100	uSendErrCode_1	Word [Unsigned]/Bit String [16-bit]	VAR_GLOBAL	D108	uRecvErrCode_2	Word [Unsigned]/Bit String [16-bit]	VAR_GLOBAL	D110	uSendDataLength	Word [Unsigned]/Bit String [16-bit]	VAR_GLOBAL	D300	uSendData	Word [Unsigned]/Bit String [16-bit](0..2)	VAR_GLOBAL	D301	uRecvDataLength	Word [Unsigned]/Bit String [16-bit]	VAR_GLOBAL	D500	uRecvData	Word [Unsigned]/Bit String [16-bit]	VAR_GLOBAL	D501	bCommReady_1	Bit	VAR_GLOBAL	M1	bCommReady_2	Bit	VAR_GLOBAL	M2	bCloseOccurred_1	Bit	VAR_GLOBAL	M11	bOpenImpossible_1	Bit	VAR_GLOBAL	M21	bCloseAccepted_1	Bit	VAR_GLOBAL	M31	bSendAccepted_1	Bit	VAR_GLOBAL	M41	bOpenFailed_1	Bit	VAR_GLOBAL	M51	tdOpenWait_1	Timer	VAR_GLOBAL	T1
Label Name	Data Type	Class	Assign (Device/Label)																																																																																										
bOpenInstruction_1	Bit	VAR_GLOBAL	X1041																																																																																										
bSendInstruction	Bit	VAR_GLOBAL	X1043																																																																																										
bRecvInstruction	Bit	VAR_GLOBAL	X1044																																																																																										
bCloseInstruction_1	Bit	VAR_GLOBAL	X1045																																																																																										
uRecvWordsCount_Tmp	Word [Unsigned]/Bit String [16-bit](0..1)	VAR_GLOBAL	D15																																																																																										
uRecvWordsCount	Word [Unsigned]/Bit String [16-bit]	VAR_GLOBAL	D17																																																																																										
uOpenErrCode_Tmp_1	Word [Unsigned]/Bit String [16-bit]	VAR_GLOBAL	D18																																																																																										
uOpenErrCode_1	Word [Unsigned]/Bit String [16-bit]	VAR_GLOBAL	D100																																																																																										
uSendErrCode_1	Word [Unsigned]/Bit String [16-bit]	VAR_GLOBAL	D108																																																																																										
uRecvErrCode_2	Word [Unsigned]/Bit String [16-bit]	VAR_GLOBAL	D110																																																																																										
uSendDataLength	Word [Unsigned]/Bit String [16-bit]	VAR_GLOBAL	D300																																																																																										
uSendData	Word [Unsigned]/Bit String [16-bit](0..2)	VAR_GLOBAL	D301																																																																																										
uRecvDataLength	Word [Unsigned]/Bit String [16-bit]	VAR_GLOBAL	D500																																																																																										
uRecvData	Word [Unsigned]/Bit String [16-bit]	VAR_GLOBAL	D501																																																																																										
bCommReady_1	Bit	VAR_GLOBAL	M1																																																																																										
bCommReady_2	Bit	VAR_GLOBAL	M2																																																																																										
bCloseOccurred_1	Bit	VAR_GLOBAL	M11																																																																																										
bOpenImpossible_1	Bit	VAR_GLOBAL	M21																																																																																										
bCloseAccepted_1	Bit	VAR_GLOBAL	M31																																																																																										
bSendAccepted_1	Bit	VAR_GLOBAL	M41																																																																																										
bOpenFailed_1	Bit	VAR_GLOBAL	M51																																																																																										
tdOpenWait_1	Timer	VAR_GLOBAL	T1																																																																																										

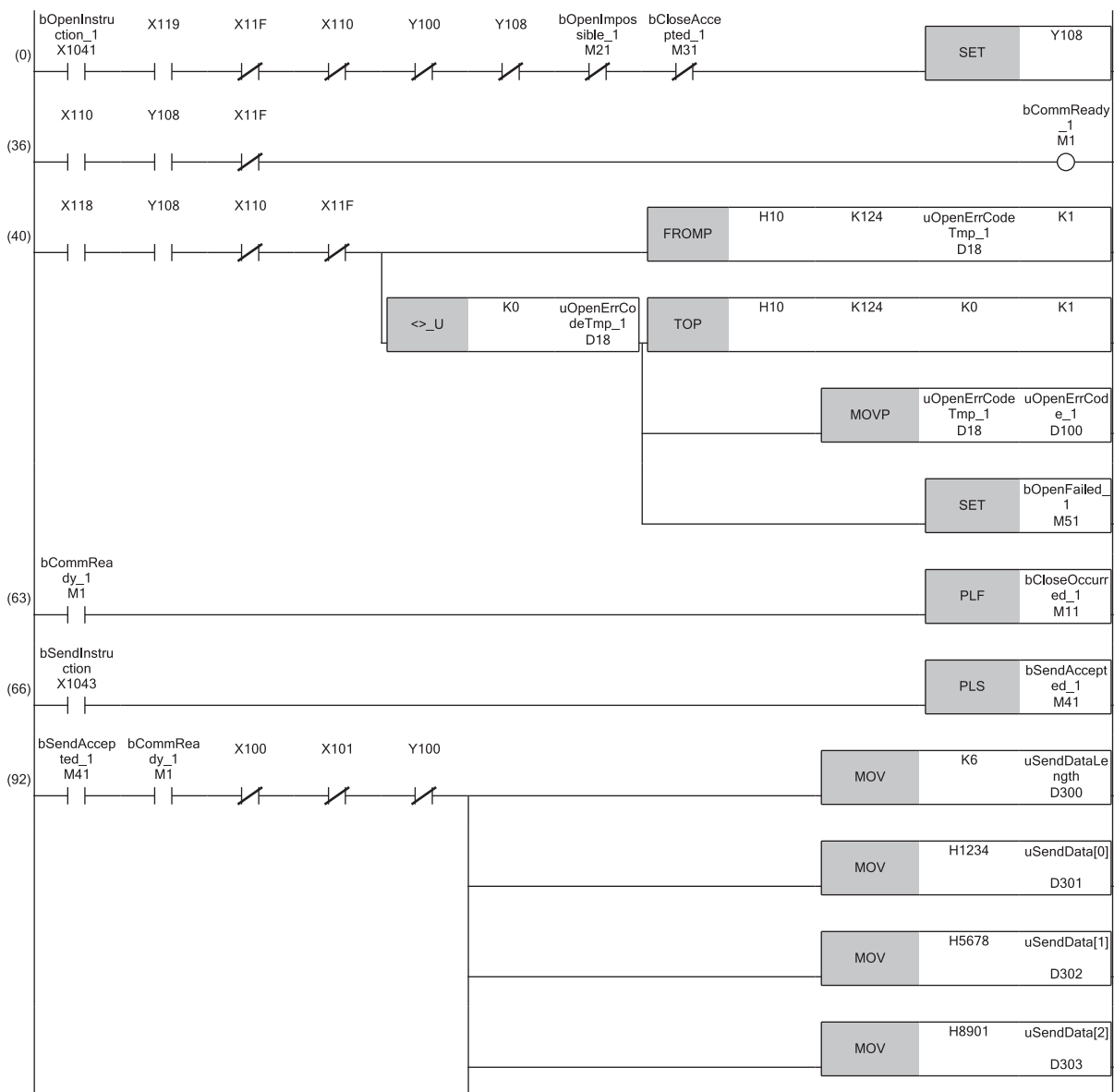

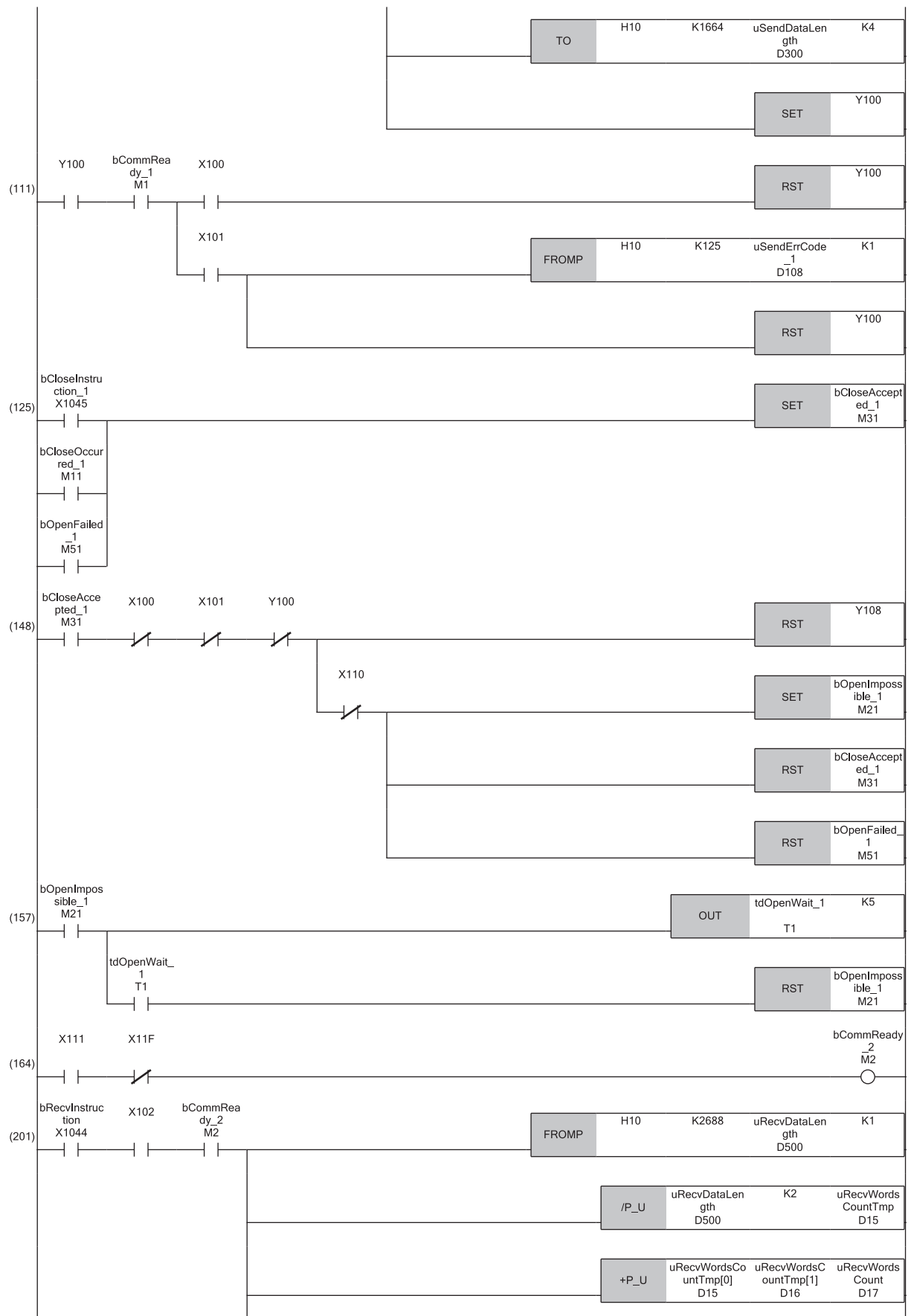

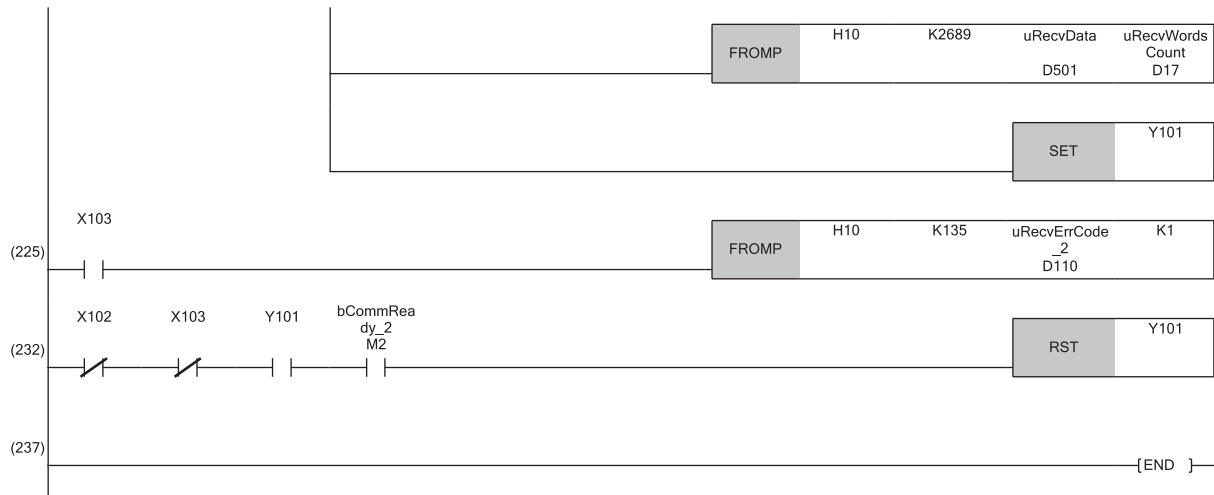

- (0) When bOpenInstruction_1 is turned on, open processing of connection No.1 is performed.
- (66)When bSendInstruction is turned on, data is sent to an external device using connection No.1.
- (125)When bCloseInstruction_1 is turned on, close processing of connection No.1 is performed.
- (201)When bRecvInstruction is turned on, data is sent to an external device using connection No.2.



Appendix 10 Port Numbers Used by Ethernet-equipped Module

The following port numbers are used by the system and cannot be specified.

RJ71EN71, network part for the RnENCPU

Port No.		Applications	Protocol	Default port status
Decimal	Hexadecimal			
20	14H	For FTP server function (data port)	TCP/IP	Close
21	15H	For FTP server function (control port)	TCP/IP	Close
123	7BH	For clock setting function (SNTP client)	TCP/IP	Close
5000	1388H	Auto-open UDP port (default value)	UDP/IP	Open
5001	1389H	MELSOFT transmission port (UDP/IP)	UDP/IP	Open
5002	138AH	MELSOFT transmission port (TCP/IP)	TCP/IP	Open
5003	138BH	MELSOFT direct connection port	UDP/IP	Open ^{*1}
5009	1391H	For searching modules on the network	UDP/IP	Open ^{*1}
61696 to 61999	F100H to F22FH	For simple CPU communication function	UDP/IP	Close

*1 This setting can be changed in "Application Settings" of the module parameter. (☞ Page 324 Application Settings)

RnCPU, CPU part of the RnENCPU

Port No.		Applications	Protocol	Default port status
Decimal	Hexadecimal			
20	14H	For FTP server function (data port)	TCP/IP	Close
21	15H	For FTP server function (control port)	TCP/IP	Close
80	50H	For Web server function	TCP/IP	Close
123	7BH	For clock setting function (SNTP client)	TCP/IP	Close
5001	1389H	MELSOFT transmission port (UDP/IP)	UDP/IP	Open ^{*1}
5005	138DH	Auto-open UDP port (default value)	UDP/IP	Open ^{*1}
5006	138EH	MELSOFT transmission port (UDP/IP)	UDP/IP	Open ^{*1}
5007	138FH	MELSOFT transmission port (TCP/IP)	TCP/IP	Open ^{*1}
5008	1390H	For MELSOFT direct connection	UDP/IP	Open ^{*2}
5009	1391H	For searching modules on the network	UDP/IP	Open ^{*2}
61440	F000H	For sending data for device supporting iQ Sensor Solution	UDP/IP	Open ^{*2}
61441	F001H	For SLMPNSD instruction	UDP/IP	Open ^{*2}
61442	F002H	For data backup/restoration for device supporting iQ Sensor Solution	UDP/IP	Open ^{*2}
61448	F008H	For DNS client	UDP/IP	Close
61450	F00AH	For CC-Link IE Field Network Basic function	UDP/IP	Close
61461	F015H	For database access function	UDP/IP	Close
61696 to 61999	F100H to F22FH	For simple CPU communication function	UDP/IP	Close
62000 to 65534	F230H to FFFE H	For file transfer function (FTP client)	TCP/IP	Close

*1 This setting can be changed in "Basic Settings" of the module parameter. (☞ Page 317 Basic Settings)

*2 This setting can be changed in "Application Settings" of the module parameter. (☞ Page 324 Application Settings)

RnPCPU

Port No.		Applications	Protocol	Default port status
Decimal	Hexadecimal			
20	14H	For FTP server function (data port)	TCP/IP	Close
21	15H	For FTP server function (control port)	TCP/IP	Close
80	50H	For Web server function	TCP/IP	Close
123	7BH	For clock setting function (SNTP client)	TCP/IP	Close
5005	138DH	Auto-open UDP port (default value)	UDP/IP	Open ^{*1}
5006	138EH	MELSOFT transmission port (UDP/IP)	UDP/IP	Open ^{*1}
5007	138FH	MELSOFT transmission port (TCP/IP)	TCP/IP	Open ^{*1}
5008	1390H	For MELSOFT direct connection	UDP/IP	Open ^{*2}
5009	1391H	For searching modules on the network	UDP/IP	Open ^{*2}
61441	F001H	For SLMPNSD instruction	UDP/IP	Open ^{*2}
61448	F008H	For DNS client	UDP/IP	Close
61696 to 61999	F100H to F22FH	For simple CPU communication function	UDP/IP	Close
62000 to 65534	F230H to FFFE H	For file transfer function (FTP client)	TCP/IP	Close

*1 This setting can be changed in "Basic Settings" of the module parameter. (☞ Page 317 Basic Settings)

*2 This setting can be changed in "Application Settings" of the module parameter. (☞ Page 324 Application Settings)

RnSFCPU

Port No.		Applications	Protocol	Default port status
Decimal	Hexadecimal			
20	14H	For FTP server function (data port)	TCP/IP	Close
21	15H	For FTP server function (control port)	TCP/IP	Close
123	7BH	For clock setting function (SNTP client)	TCP/IP	Close
5005	138DH	Auto-open UDP port (default value)	UDP/IP	Open ^{*1}
5006	138EH	MELSOFT transmission port (UDP/IP)	UDP/IP	Open ^{*1}
5007	138FH	MELSOFT transmission port (TCP/IP)	TCP/IP	Open ^{*1}
5008	1390H	For MELSOFT direct connection	UDP/IP	Open ^{*2}
5009	1391H	For searching modules on the network	UDP/IP	Open ^{*2}

*1 This setting can be changed in "Basic Settings" of the module parameter. (☞ Page 317 Basic Settings)

*2 This setting can be changed in "Application Settings" of the module parameter. (☞ Page 324 Application Settings)

RnPSFCPU

Port No.		Applications	Protocol	Default port status
Decimal	Hexadecimal			
20	14H	For FTP server function (data port)	TCP/IP	Close
21	15H	For FTP server function (control port)	TCP/IP	Close
123	7BH	For clock setting function (SNTP client)	TCP/IP	Close
5005	138DH	Auto-open UDP port (default value)	UDP/IP	Open
5006	138EH	MELSOFT transmission port (UDP/IP)	UDP/IP	Open
5007	138FH	MELSOFT transmission port (TCP/IP)	TCP/IP	Open
5008	1390H	For MELSOFT direct connection	UDP/IP	Open ^{*1}
5009	1391H	For searching modules on the network	UDP/IP	Open ^{*1}

*1 This setting can be changed in "Application Settings" of the module parameter. (☞ Page 324 Application Settings)

Appendix 11 Operation Image and Data Structure of Predefined Protocol

Operation image of each communication type of protocol

With the predefined protocol support function, data is communicated with the external device using the "Send Only", "Receive Only", and "Send & Receive" communication types.

This section describes the operation images of each communication type.

For "Send Only" communication type

The specified packet is sent once.

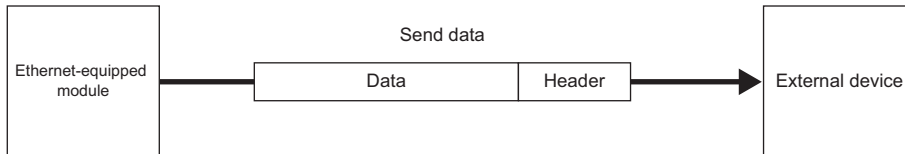

The operation image of "Send Only" is shown below.

■When the instruction completed successfully

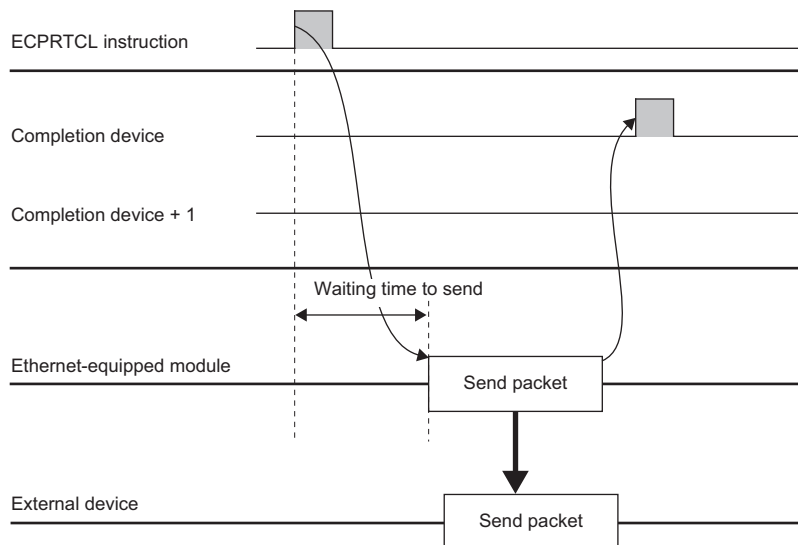

■When the instruction completed with an error at TCP/IP (timeout error)

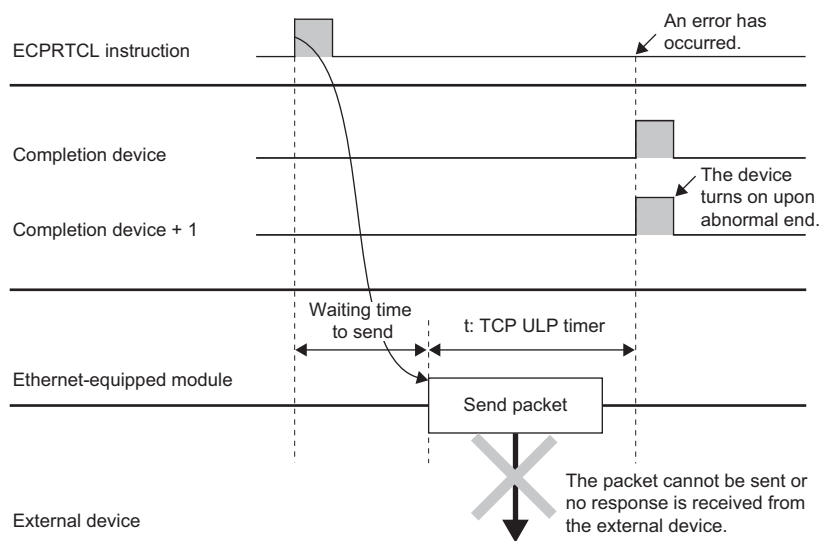

For details on errors that occur when the communication completed abnormally, refer to the error code stored in the buffer memory.

(☞ Page 443 List of Error Codes)

For "Receive Only" communication type

When data is received from the external device, it is verified with the receive packet (expected packet). If it matches, the receive processing ends. If the verification does not match, the received data is discarded.

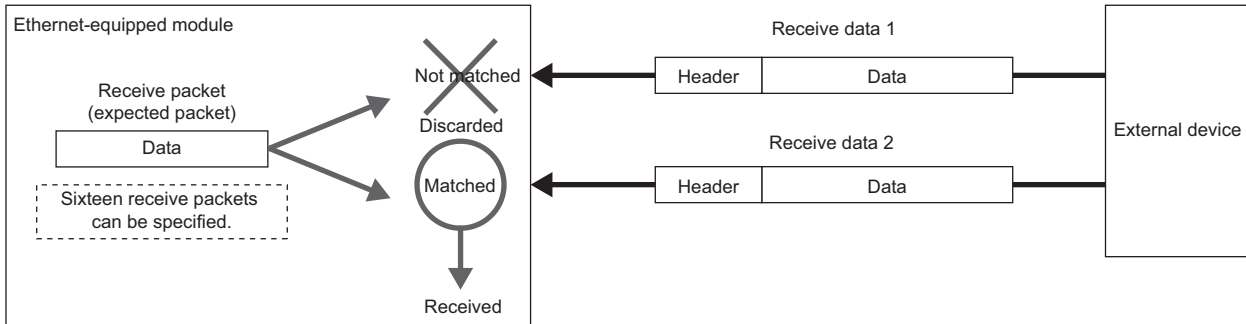

The operation image of "Receive Only" is shown below.

■When the instruction completed successfully

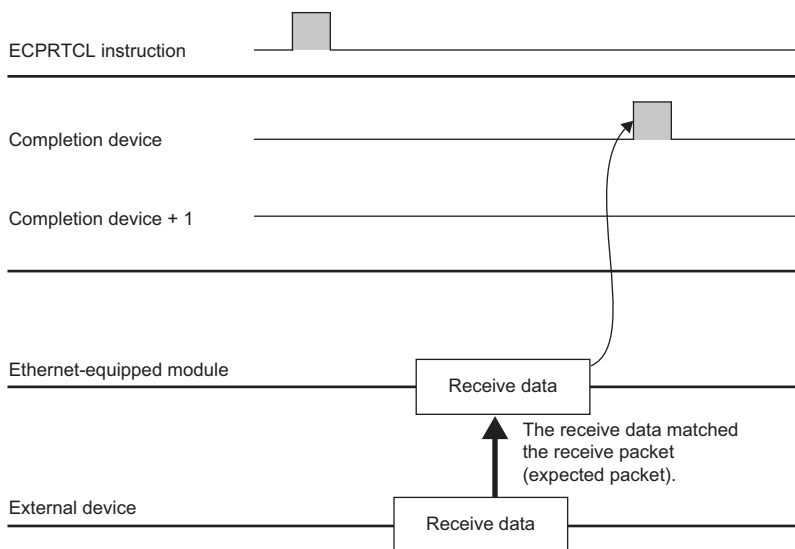

A

■When the instruction completed with an error (timeout error)

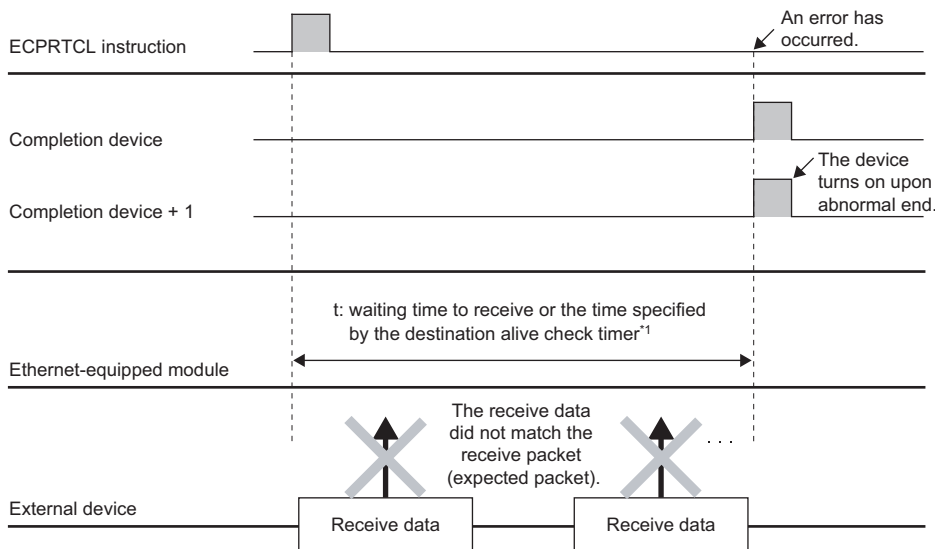

*1 When the receive packet (expected packet) verification does not match before the reception wait time, or when other device existence cannot be checked within the destination alive check time (time calculated from destination alive check start interval timer value, destination alive check interval timer value, and destination alive check resend count).

Point

- When variables are included in receive packet (expected packet) elements, variable data are not verified.
- Up to 16 receive packets (expected packets) can be specified.
- When multiple packets are specified, the received data is verified with the registered receive packet (expected packet) in the order of registration. The receive processing is completed when a matching receive packet (expected packet) is found, and the subsequent verification is canceled.
- The number of the matching received packet is stored in the control data of the ECPRTCL instruction and the buffer memory.
- For details on errors that occur when the communication completed abnormally, refer to the error code stored in the buffer memory. ( Page 443 List of Error Codes)

For "Send & Receive" communication type

The packet is sent once. If the send completed successfully, the module shifts to the receiving standby state. When data is received from the external device, it is verified with the receive packet (expected packet). If it matches, the receive processing ends.

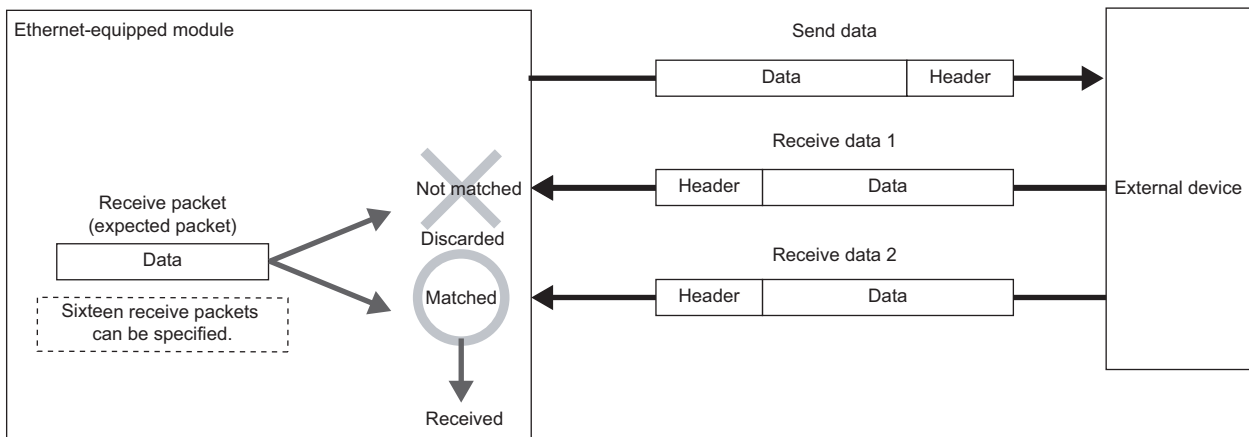

The operation image of "Send & Receive" is shown below.

■When the instruction completed successfully

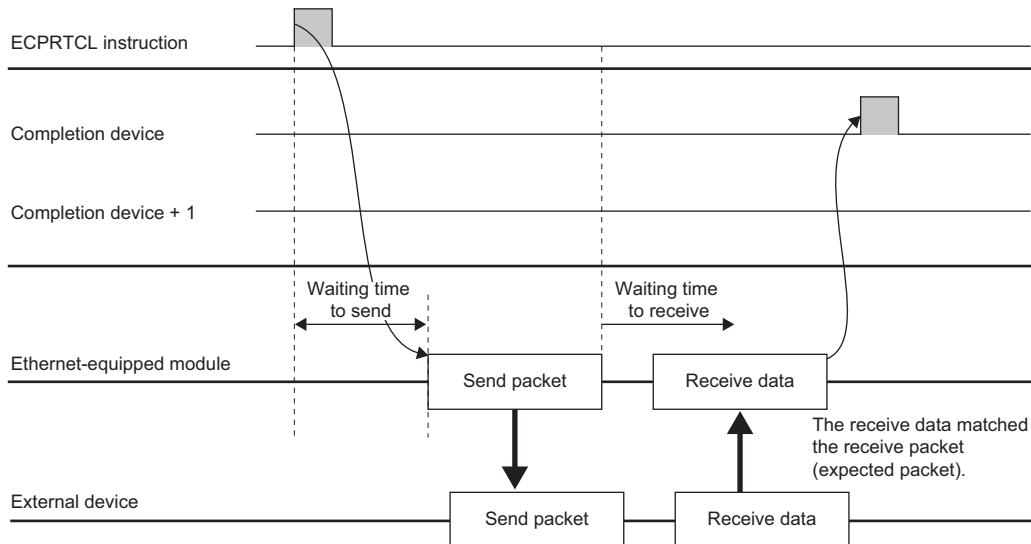

A

■When the instruction completed with an error (timeout error at sending)

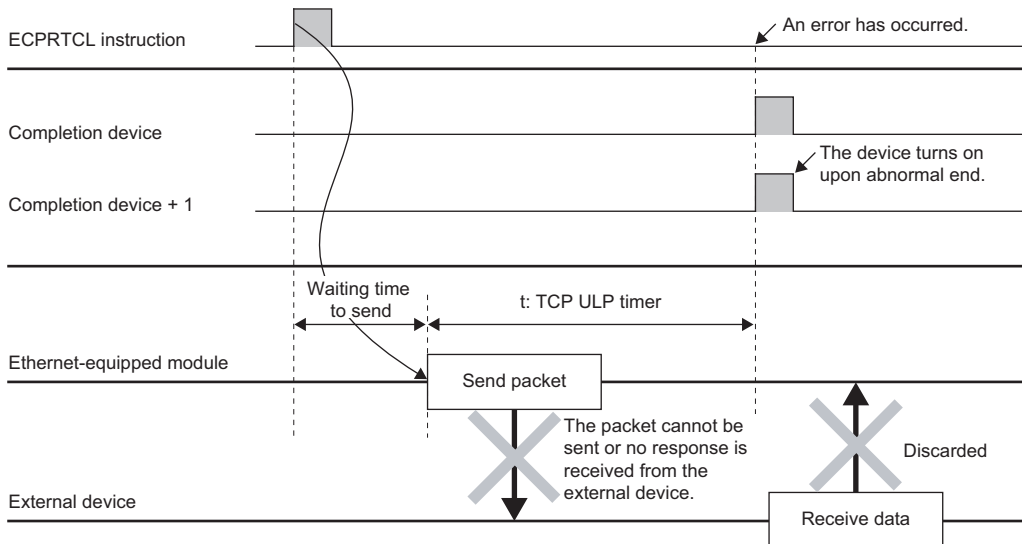

■When the instruction completed with an error (timeout error of waiting time to receive)

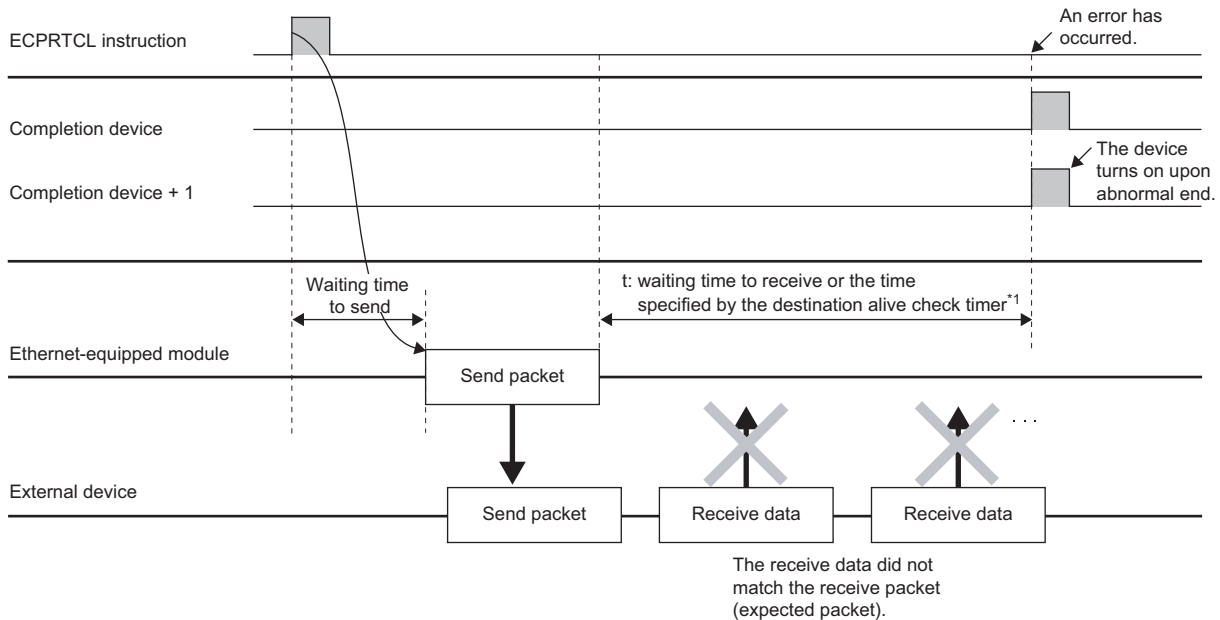

*1 When the receive packet (expected packet) verification does not match before the reception wait time, or when other device existence cannot be checked within the destination alive check time (time calculated from destination alive check start interval timer value, destination alive check interval timer value, and destination alive check resend count).

Point

For details on errors that occur when the communication completed abnormally, refer to the error code stored in the buffer memory.

(📖 Page 443 List of Error Codes)

Verification operation of receive packet

This section describes the receive packet (expected packet) verification operation for communication with an external device when the protocol communication type contains reception.

When received data are matched with a receive packet (expected packet)

The received data is compared against the receive packet (expected packet), and the receive processing completes when the verification matches.

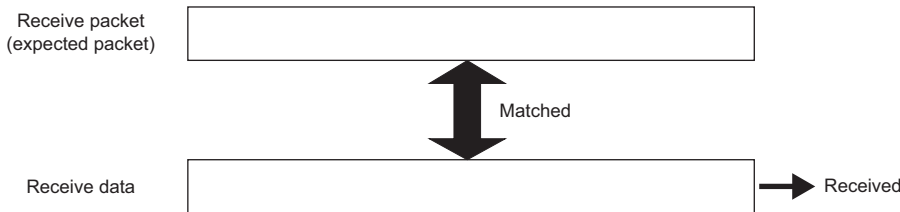

When multiple receive packets (expected packets) are specified

Up to 16 receive packets (expected packets) can be registered with the predefined protocol support function. When the data are received, the registered receive packet (expected packet) is verified in the order of registration. The receive processing completes as soon as a matching receive packet (expected packet) is found.

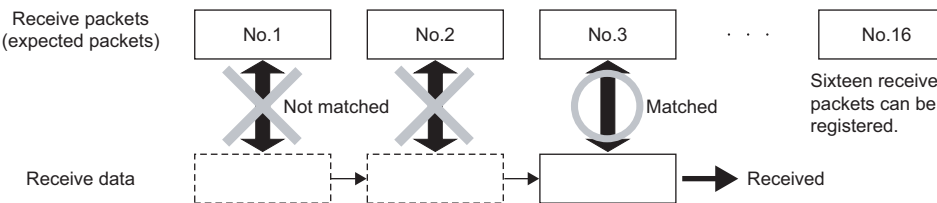

When received data does not match with all receive packet (expected packet)

If the received data does not match any of the registered receive packets (expected packets), the received data is discarded.

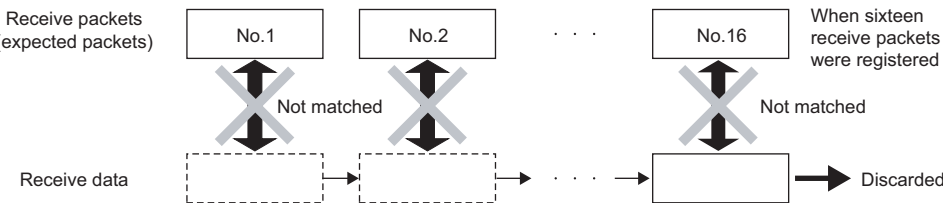

A

Example of packet element data

The element processing procedures that can be set for the packets, the actual data examples, and others are shown below.

Length

■Process procedure

The Ethernet-equipped module processes the length with the following procedure.

[During send]

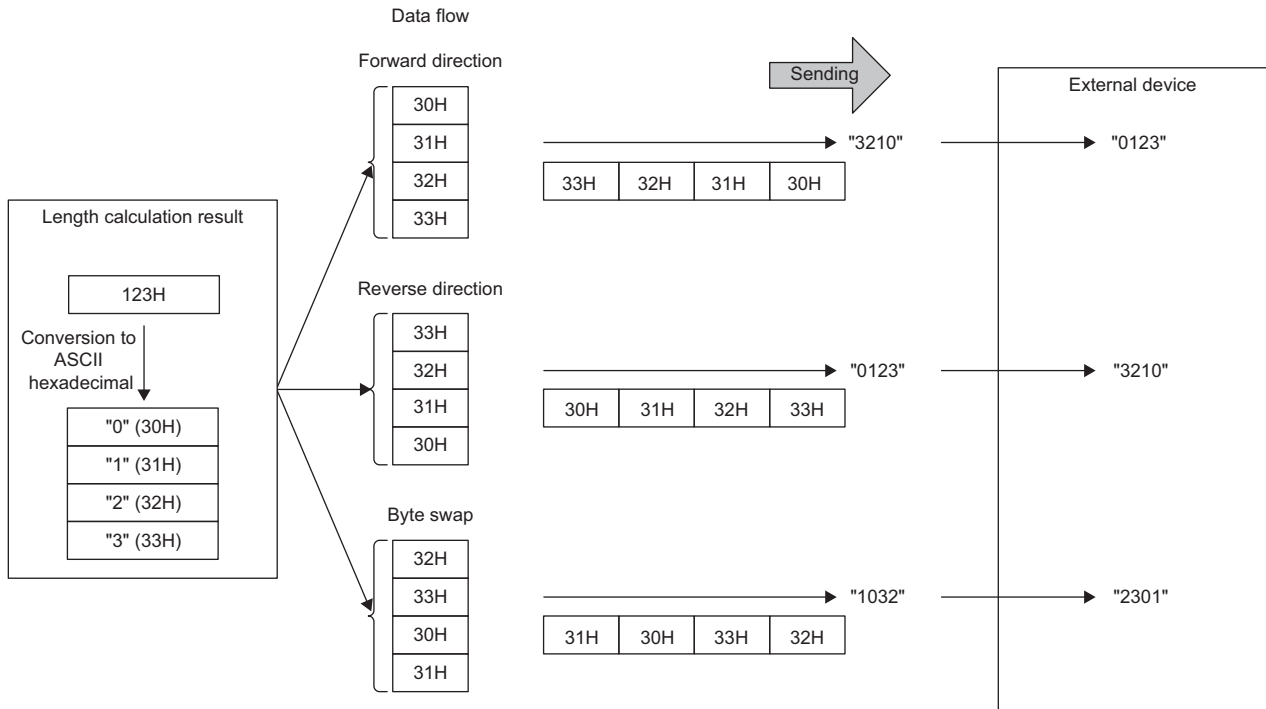

[During receive]

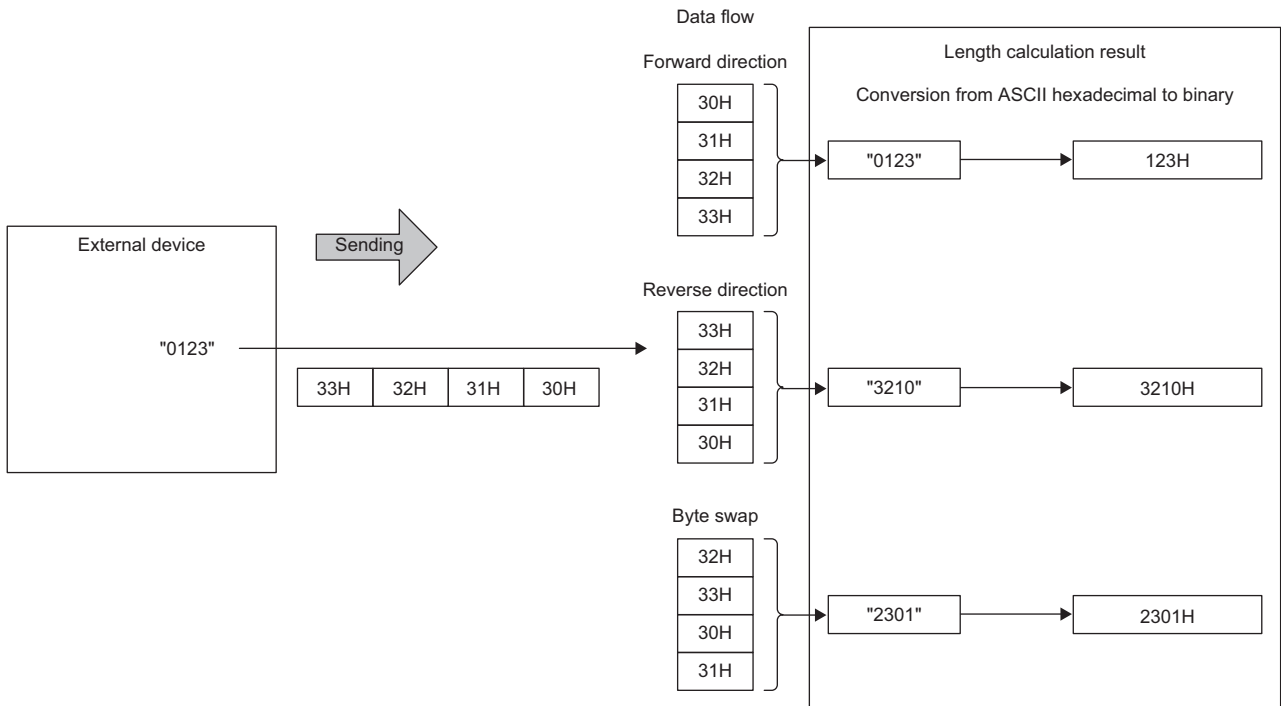

■Data flow

Data flow is used to specify the order of send data and receive data.

The data flow can be specified in forward direction (upper byte → lower byte), reverse direction (lower byte → upper byte), and byte swap (by word).

- Forward direction, reverse direction: Available when the data length is 2 bytes or more.
- Byte swap: Available only when the data length is 4 bytes.

■Calculating range

Examples of specifying the length calculating range are shown below.

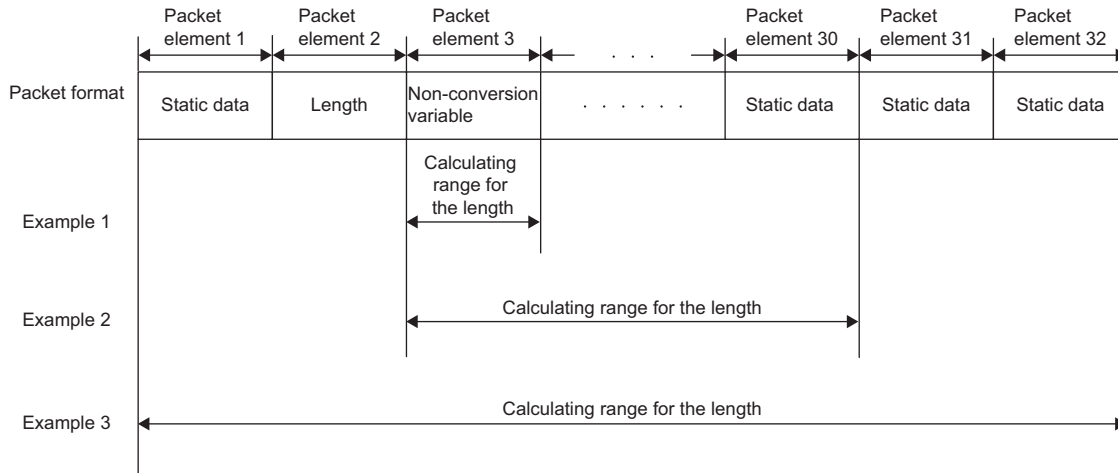

Example 1: Calculating range when start of range is set as 3 and end is set as 3

Example 2: Calculating range when start of range is set as 3 and end is set as 30

Example 3: Calculating range when start of range is set as 1 and end is set as 32

Non-conversion Variable

■Process procedure

The Ethernet-equipped module processes the non-conversion variable element with the following procedure.

When unit of stored data is "Lower Byte + Upper Byte"

- When the data length of a send packet is an odd number, the upper byte (lower byte when bytes are swapped) of the end device is not sent.
- When the data length of a receive packet is an odd number, the last data is stored with one byte of 00H.

Ex.

When sending data whose length is an odd number

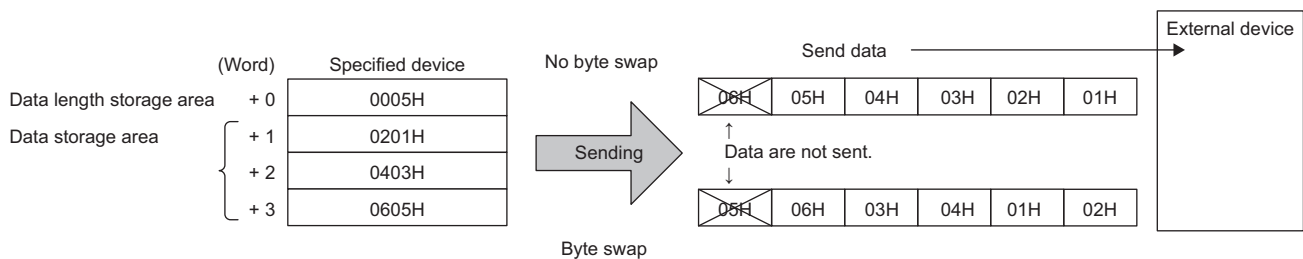

Ex.

When receiving data whose length is an odd number

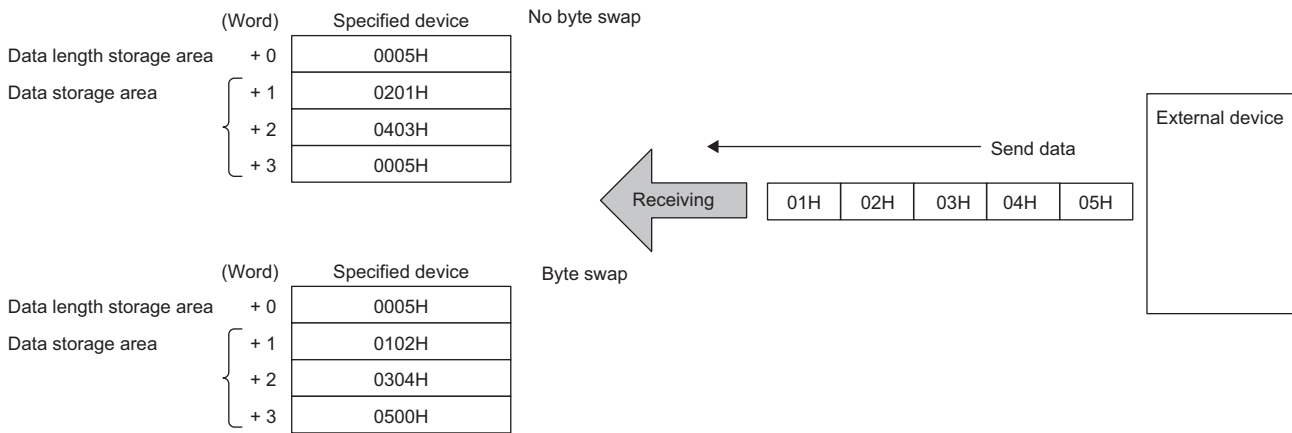

When unit of stored data is "Lower Byte Only"

- A size double the data length is occupied. For the upper data, the Ethernet-equipped module ignores the data at sending and adds 00H to the data at receiving.

Non-verified reception

The usage examples for a non-verified reception element is shown below.

Ex.

· Example of a packet format of the external device

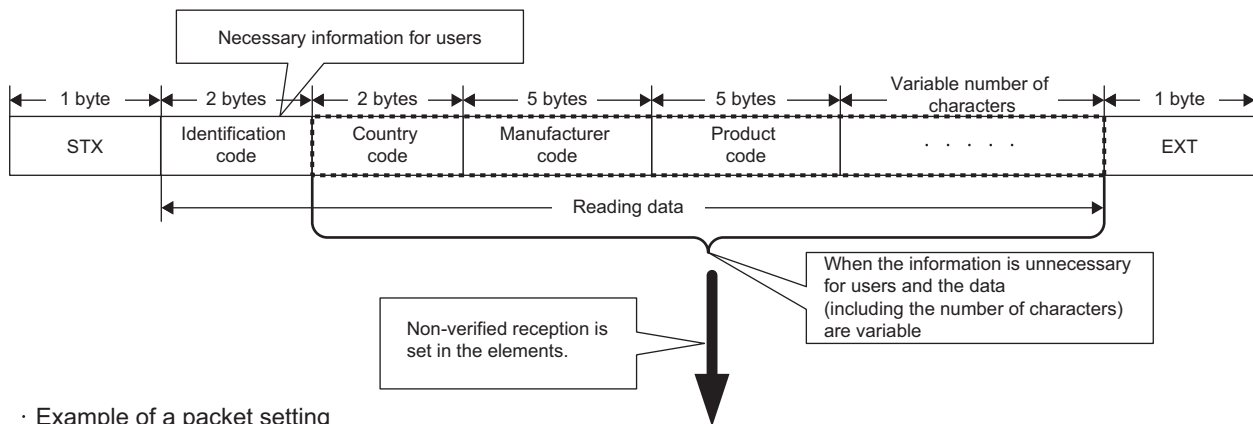

· Example of a packet setting

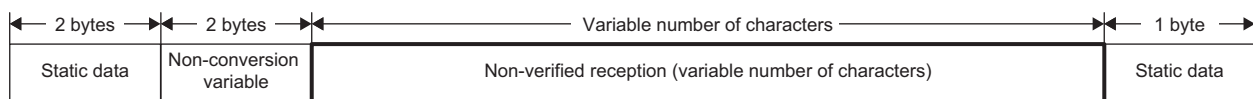

In the above type of packet format, the following operation can be executed by setting reception without verification.

- It is possible to store only the required information in the CPU module's device or buffer memory.
- Even if the received packet contains data that changes with each communication, it can be handled with one protocol (packet).

Appendix 12 Example of External Device Program

An example of the program in the external device connected to the same Ethernet as the Ethernet-equipped module is shown below. Each program is the minimum required program for the communication. Change the IP address or port number according to the system. When including process for errors, add it separately.

External device receiving process

An example of the external device receiving process is shown below.

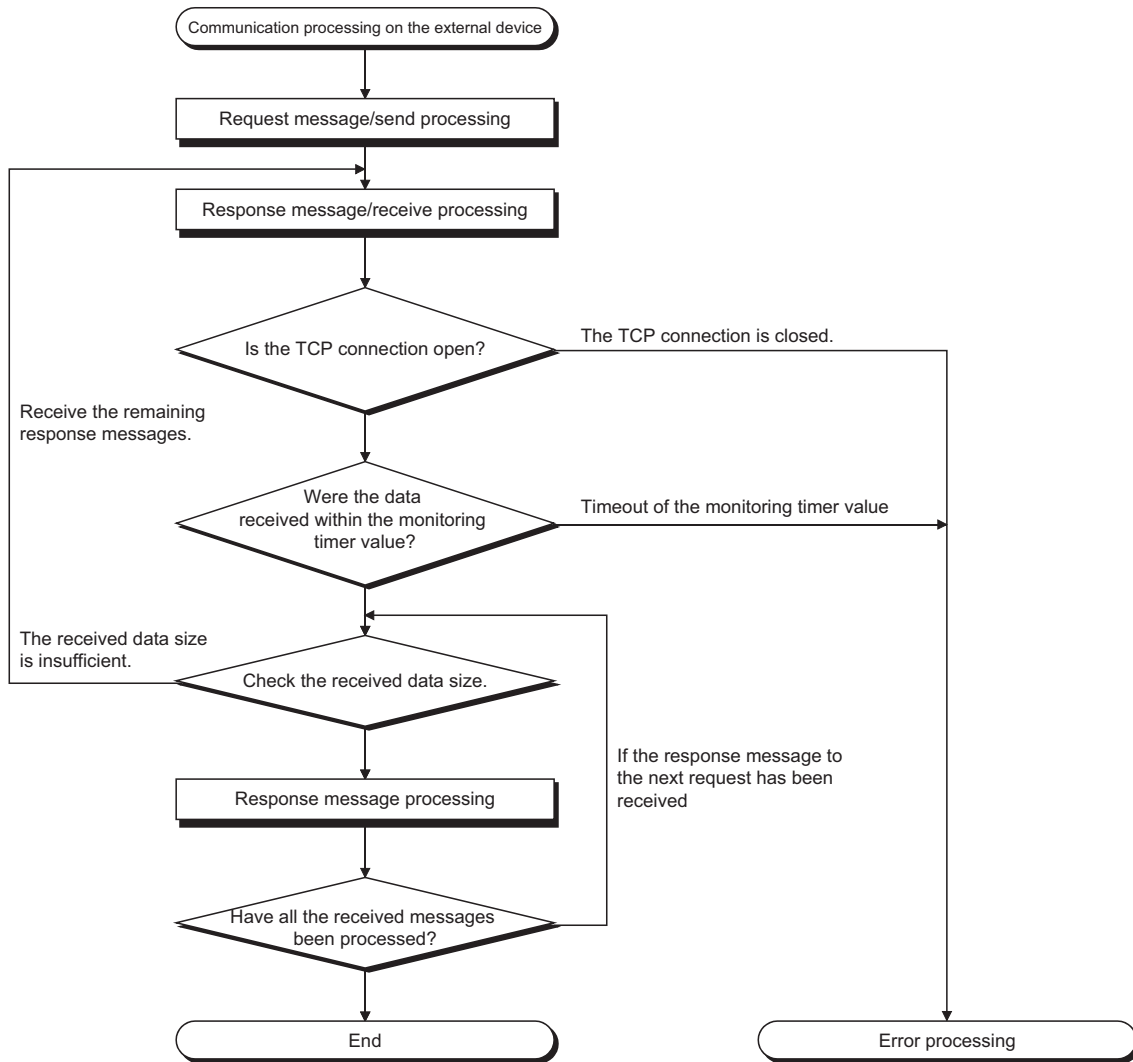

A

Point

When communicating with Ethernet, the TCP socket functions (socket functions) are used in the personal computer. There is no concept of boundary with these functions. When the send side calls the send function once and sends data, the receiving side must call the recv function once, twice, or depending on the circumstance more times to read that data. (send and recv do not correspond one-on-one.) Thus, the external device's program process must execute the receiving process as shown above.

Appendix 13 How to Turn Off ERR LED

If an error occurs in communications with the external device, the ERR LED turns on. Even though the error cause is eliminated, the ERR LED does not turn off. This section describes how to turn off the ERR LED.

Method using a dedicated instruction

The ERR LED can be turned off by the ERRCLEAR instruction. Availability for turning off the LED depends on the firmware version of the RJ71EN71. (👉 Page 564 Added and Enhanced Functions)

For details on the ERRCLEAR instruction, refer to the following.

📖 MELSEC iQ-R Programming Manual (Module Dedicated Instructions)

Method using I/O signals

When the network type is "Q Compatible Ethernet", the ERR LED can be turned off by the ERR LED off request (Y17). (👉 Page 472 When the network type is "Q Compatible Ethernet")

Appendix 14 Software Licenses and Copyrights

This section describes the licenses and copyrights of the software used in this product.

MD5 Message-Digest Algorithm

This product includes code that was developed by RSA Data Security, Inc.

Copyright © 1991-2, RSA Data Security, Inc.

License to copy and use this software is granted provided that it is identified as the "RSA Data Security, Inc. MD5 Message-Digest Algorithm" in all material mentioning or referencing this software or this function.

License is also granted to make and use derivative works provided that such works are identified as "derived from the RSA Data Security, Inc. MD5 Message-Digest Algorithm" in all material mentioning or referencing the derived work.

RSA Data Security, Inc. makes no representations concerning either the merchantability of this software or the suitability of this software for any particular purpose. It is provided "as is" without express or implied warranty of any kind.

These notices must be retained in any copies of any part of this documentation and/or software.

Appendix 15 Added and Enhanced Functions

RJ71EN71, RnENCPU (network part)

The following table lists the added and enhanced functions in the RJ71EN71, RnENCPU (network part).

○: Available (No version restriction), ×: Not available

Added and enhanced function	Firmware version	
	RJ71EN71	RnENCPU (network part)
Turning off the LED with the ERRCLEAR instruction	"05" or later	○
'State of receive buffer' (Un\G1900030)* ¹	"05" or later	○
IP address change function	"10" or later	"10" or later
Redundant system function	"12" or later	×
Remote head module redundant system	"12" or later	×
Accessing to another station via the port 1 and port 2 using SLMP communications	"18" or later	×
Simple CPU communication function	"35" or later	"35" or later
MODBUS/TCP slave function	"35" or later	"35" or later
Simple CPU communication function for MELSEC iQ-F series	"35" or later	"35" or later
Simple CPU communication function <ul style="list-style-type: none"> Setting number of up to 512 On-request communications MELSEC-A/AnS (Ethernet module) and MELSEC-FX3 (Ethernet block/adaptor) as communication destination 	"39" or later	"39" or later
MODBUS/TCP slave function for redundant system	"42" or later	"42" or later
Simple CPU communication function <ul style="list-style-type: none"> Redundant system MELSEC iQ-L series, SIEMENS S7 series, Fuji Electric MICREX-SX series, and JTEKT TOYOPUC series as communication destination 	"42" or later	"42" or later
Discard received data at CPU STOP	"42" or later	"42" or later
Optional function to specify the module ID when using MODBUS/TCP in the simple CPU communication function	"47" or later	"47" or later
Extension base unit in a redundant system with redundant extension base unit	"50" or later	×
Simple device communication function	"56" or later	"56" or later
Protocol setting editing function with simple device communication function ²	"59" or later	"59" or later
Simple CPU communication function ³ <ul style="list-style-type: none"> SIEMENS S7 series (extension) as communication destination Additional devices that can be specified 	"62" or later	"62" or later
'Error log area' (Un\G227 to Un\G372)	"66" or later	"66" or later
Time setting function (SNTP client) for daylight saving time function	"68" or later	"68" or later
Simple device communication function <ul style="list-style-type: none"> Element "Error check code" Enable (Upper → Lower, two-word units), Enable (Upper → Lower, four-word units) for byte swap for non-conversion variables 	"71" or later	"71" or later
Simple device communication function <ul style="list-style-type: none"> Element "Conversion Variable" "Data Unit" for the length 	"75" or later	"75" or later
Simple device communication function ² <ul style="list-style-type: none"> "Receive Only" in "Communication Type" "Extension 2" in "Resource Setting" 	"77" or later	"77" or later

*1 'Receive buffer full detection signal' (Un\G21056) can be used when the network type is set to "Q Compatible Ethernet".

*2 For the engineering tool software version restrictions, refer to the following.

☞ Page 285 Restrictions applicable depending on versions

*3 For the engineering tool software version restrictions, refer to the following.

☞ Page 224 Restrictions applicable depending on versions

CPU module (built-in Ethernet port part)

The following table lists the added and enhanced functions in the CPU module (built-in Ethernet port part).

R00/R01/R02: R00CPU, R01CPU, R02CPU, Rn: RnCPU (except R00CPU, R01CPU, and R02CPU), RnEN: RnENCPU, RnP(P): Process CPU (process mode), RnP(R): Process CPU (redundant mode), RnPSF: SIL2 Process CPU, RnSF: Safety CPU

○: Available (No version restriction), ×: Not available

Added and enhanced function	Firmware version						
	R00/R01/R02	Rn	RnEN	RnP(P)	RnP(R)	RnPSF	RnSF
Redundant system function	×	×	×	×	"04" or later	○	×
File transfer function (FTP client)	○	"22" or later	"22" or later	"13" or later	"13" or later	×	×
High-speed write mode (File transfer function (FTP server))	○	"23" or later	"23" or later	×	×	×	×
Simple CPU communication function	"05" or later	"35" or later	"35" or later	"34" or later	"34" or later	×	"30" or later
Communications by network number/station number	"08" or later	"40" or later	"40" or later	×	×	×	×
Simple CPU communication function for MELSEC iQ-F series	"08" or later	"40" or later	"40" or later	"34" or later	"34" or later	×	"30" or later
CPU module built-in database access function from external device	×	"28" or later	"28" or later	×	×	×	×
Simple CPU communication function • MELSEC iQ-L series as a communication destination	"14" or later	"46" or later	"46" or later	"34" or later	"34" or later	×	"30" or later
Discard received data at CPU STOP	"15" or later	"47" or later	"47" or later	"25" or later	"25" or later	×	×
Simple CPU communication function • MELSEC-Q (Ethernet module) and MELSEC-L (Ethernet module) as communication destination	"17" or later	"49" or later	"49" or later	×	×	×	×
Simple CPU communication function • MELSEC-A/AnS (Ethernet module) and MELSEC-FX3 (Ethernet block/adaptor) as communication destination	"17" or later	"49" or later	"49" or later	"34" or later	"34" or later	×	"30" or later
iQ Sensor Solution	 iQ Sensor Solution Reference Manual						
FTP server function file path name switching	"19" or later	"51" or later	"51" or later	×	×	×	×
Simple CPU communication function • Initial communication setting	"21" or later	"53" or later	"53" or later	×	×	×	"30" or later
Connection close wait time setting	"23" or later	"56" or later	"56" or later	×	×	×	×
User Web page file of the Web server function as the files that can be transferred with the file transfer function (FTP server)	"30" or later	"63" or later	"63" or later	"37" or later	"37" or later	×	×
Simple CPU communication function • "On Request" in "Communication Setting"	"38" or later*1	"71" or later*1	"71" or later*1	×	×	×	×
Simple CPU communication function • F, T, ST, and C devices that can be specified	"38" or later*1	"71" or later*1	"71" or later*1	×	×	×	×

*1 The version is available for the engineering tool with software version "1.105K" or later.

MEMO

INDEX

A

Active open	527
Application data	84,103
Area for sending/receiving instructions	496
Automatic negotiation	328
Automatic response system	399

C

Combination system	403
Command input monitoring timer	329
Communication data code	318
Communication method	321
Communication path determination status	500
Communication status test	423
Communications by network number/station number	318
Connection close wait time setting	68
Connection close wait time setting area for socket communications (TCP/IP)	518
Connection status	421
Connection status storage area	493,514,518
Creating the protocol setting data	37

D

Drive name (drive No.)	127
------------------------	-----

E

Enable/disable online change	318
End codes	468
Error information	413
Ethernet diagnostics	417
Existence confirmation	322

F

Fixed buffer send/receive setting	321
Forced connection invalidation setting area	497,516
Fullpassive	528

G

Gateway IP address	396
--------------------	-----

H

Header	84,102
--------	--------

I

Initial error code	510
Initial status	510
IP address	318
IP address calculation system	400
IP address duplication status storage area	496,515
IP filter function	180
IP filter settings	395

J

Jumbo frame	327
-------------	-----

L

Lock processing	183
Logical address	102
Login name	329

M

Module communication test	406,415
Module diagnostics	413
Module information list	414

N

Network number	318
No procedure	73
Number of retries	394

O

Offline	406
Online	406
Open completion signal	510
Open request signal	510
Opening method	318
Own node operation status storage area	495,515
Own node setting status storage area	492

P

Pairing open	82
Passive open	528
Password setting	329
Physical address	102
PING test	422
Predefined protocol library	39
Procedure exist	73

R

Remote head module	541
Remote password check operation	184
Remote password lock status storage area	497,515
Response monitoring timer	330

S

Searching modules on the network	25
Send frame	327
SLMP commands	34
Socket/fixed buffer reception status signal	510
State of receive buffer	511
Station number	318
Status for each protocol	420
Status of each connection	419
Status of each protocol	494
Structure of the module label	470

Subnet address	396
Subnet mask pattern	404

T

Table conversion system	402
Transient transmission group number	318

U

Unlock processing	183
Unpassive	528

REVISIONS

*The manual number is given on the bottom left of the back cover.

Revision date	*Manual number	Description
June 2014	SH(NA)-081257ENG-A	First edition
July 2014	SH(NA)-081257ENG-B	Error correction
November 2014	SH(NA)-081257ENG-C	<ul style="list-style-type: none"> ■ Added or modified parts Section 2.2, 3.1, 3.2, 3.5, 3.7, Appendix 1, 2
April 2015	SH(NA)-081257ENG-D	<ul style="list-style-type: none"> ■ Added models R08PCPU, R16PCPU, R32PCPU, R120PCPU ■ Added or modified parts Section 1.3, 1.5, 2.3, 3.5, Appendix 2, 4, 11
August 2015	SH(NA)-081257ENG-E	<ul style="list-style-type: none"> ■ Added models R04ENCPU, R08ENCPU, R08SFCPU, R16ENCPU, R16SFCPU, R32ENCPU, R32SFCPU, R120ENCPU, R120SFCPU ■ Added functions Automatic detection of connected device, communication setting reflection, and sensor parameter read/write of the CPU module ■ Added or modified parts INTRODUCTION, RELEVANT MANUALS, TERMS, Section 1.1, 1.2, 1.3, 1.4, 1.5, 1.6, 1.7, 1.8, 1.10, 1.11, 2.1, 2.2, 2.3, 3.1, 3.2, 3.3, 3.4, 3.5, Appendix 1, 2, 3, 4, 7, 8
January 2016	SH(NA)-081257ENG-F	<ul style="list-style-type: none"> ■ Added or modified parts RELEVANT MANUALS, TERMS, Section 1.1, 1.3, 1.5, 1.8, 1.10, 3.4, 3.5, Appendix 3, 4, 8, 11
May 2016	SH(NA)-081257ENG-G	<ul style="list-style-type: none"> ■ Added functions File transfer function (FTP client), redundant system function ■ Added or modified parts INTRODUCTION, RELEVANT MANUALS, TERMS, Section 1.1, 1.3, 1.5, 1.9, 1.11, 1.12, 1.13, 2.2, 2.3, 3.2, 3.4, 3.5, 3.6, 3.7, Appendix 3, 4, 6, 7, 8, 9, 12
October 2016	SH(NA)-081257ENG-H	<ul style="list-style-type: none"> ■ Added function High-speed write mode (File transfer function (FTP server)) ■ Added or modified parts Section 1.8, 2.2
April 2017	SH(NA)-081257ENG-I	<ul style="list-style-type: none"> ■ Added function Improvements on Ethernet diagnostics ■ Added or modified parts RELEVANT MANUALS, TERMS, Section 1.2, 1.9, 2.3, 3.3, Appendix 12
October 2017	SH(NA)-081257ENG-J	<ul style="list-style-type: none"> ■ Added models R00CPU, R01CPU, R02CPU, R08PSFCPU, R16PSFCPU, R32PSFCPU, R120PSFCPU ■ Added or modified parts SAFETY PRECAUTIONS, TERMS, Section 1.3, 1.9, 2.3, Appendix 4, 12
April 2018	SH(NA)-081257ENG-K	<ul style="list-style-type: none"> ■ Added functions Web server function and simple CPU communication function (CPU module (built-in Ethernet port part)) ■ Added or modified parts Section 1.11, 1.13, 2.3, Appendix 3, 12
October 2018	SH(NA)-081257ENG-L	<ul style="list-style-type: none"> ■ Added functions MODBUS/TCP slave function, simple CPU communication function (RJ71EN71, RnENCPU (network part)), and connection by specifying the network number and station number (CPU module (built-in Ethernet port part)) ■ Added or modified parts Section 1.1, 1.7, 1.14, 1.15, 1.16, 2.2, 2.3, Appendix 3, 9
April 2019	SH(NA)-081257ENG-M	<ul style="list-style-type: none"> ■ Added function Enhancements of the simple CPU communication function (RJ71EN71, RnENCPU (Network Part)) ■ Added or modified parts TERMS, GENERIC TERMS AND ABBREVIATIONS, Section 1.15, 2.3, 3.4, 3.5, Appendix 3, 13
August 2019	SH(NA)-081257ENG-N	Error correction
October 2019	SH(NA)-081257ENG-O	<ul style="list-style-type: none"> ■ Added functions Redundant system supported (RJ71EN71) of the MODBUS/TCP slave function, redundant system supported (RJ71EN71) of the simple CPU communication function and external device enhancement (RJ71EN71, RnENCPU (network part)), discard received data at CPU STOP (RJ71EN71, RnENCPU (network part)) ■ Added or modified parts TERMS, GENERIC TERMS AND ABBREVIATIONS, Section 1.7, 1.14, 1.15, 1.17, 1.18, 2.3, Appendix 13

Revision date	*Manual number	Description
February 2020	SH(NA)-081257ENG-P	<p>■Added function Discard received data at CPU STOP (built-in Ethernet port)</p> <p>■Added or modified parts Appendix 3, 13</p>
May 2020	SH(NA)-081257ENG-Q	<p>■Added functions Extension of the simple CPU communication function (built-in Ethernet port), optional function for specifying the module ID when using MODBUS/TCP in the simple CPU communication function</p> <p>■Added or modified parts Section 1.1, 1.14, 1.15, 2.2, 2.3, Appendix 13</p>
July 2020	SH(NA)-081257ENG-R	<p>■Added or modified parts SAFETY PRECAUTIONS, CONDITIONS OF USE FOR THE PRODUCT</p>
October 2020	SH(NA)-081257ENG-S	<p>■Added functions Directory delimiter switching setting (FTP server), extension base unit in a redundant system with redundant extension base unit</p> <p>■Added or modified parts SAFETY PRECAUTIONS, RELEVANT MANUALS, TERMS, Section 1.1, 1.5, 1.9, 1.14, 1.17, 2.3, 3.5, Appendix 9, 13</p>
April 2021	SH(NA)-081257ENG-T	<p>■Added function Simple device communication function</p> <p>■Added or modified parts TERMS, Section 1.14, 1.15, 1.16, 1.18, 2.3, 3.4, Appendix 3, 8, 9, 14, 15</p>
August 2021	SH(NA)-081257ENG-U	<p>■Added or modified part Section 1.4</p>
October 2021	SH(NA)-081257ENG-V	<p>■Added function Extension for simple device communication function</p> <p>■Added or modified parts Section 1.3, 1.4, 1.13, 1.16, 2.2, 2.3, 3.4, 3.6, Appendix 3, 6, 10, 11, 15, 16</p>
June 2022	SH(NA)-081257ENG-W	<p>■Added function Enhancements of the simple CPU communication function</p> <p>■Added or modified parts SAFETY PRECAUTIONS, RELEVANT MANUALS, Section 1.9, 1.12, 1.13, 1.14, 1.15, 1.16, 2.3, 3.4, 3.5, Appendix 10, 14, 15</p>
July 2022	SH(NA)-081257ENG-X	<p>■Added or modified part Appendix 10</p>
December 2022	SH(NA)-081257ENG-Y	<p>■Added or modified parts Section 1.15, 2.3, 3.3, 3.8, Appendix 3, 15</p>
April 2023	SH(NA)-081257ENG-Z	<p>■Added function Extension for simple device communication function</p> <p>■Added or modified parts RELEVANT MANUALS, Section 1.1, 1.3, 1.9, 1.10, 1.11, 1.12, 1.14, 1.16, 1.18, 2.3, Appendix 3, 15</p>
June 2023	SH(NA)-081257ENG-AA	<p>■Added or modified part Appendix 15</p>
November 2023	SH(NA)-081257ENG-AB	<p>■Added function Extension for simple device communication function</p> <p>■Added or modified parts Section 1.16, 2.3, 3.5 Appendix 3, 10, 15</p>
May 2024	SH(NA)-081257ENG-AC	<p>■Added function Extension for simple device communication function</p> <p>■Added or modified parts Section 1.2, 1.4, 1.7, 1.10, 1.11, 1.14, 1.15, 1.16, 2.3, 3.3, 3.4, 3.5, Appendix 3, 7, 15</p>

Japanese manual number: SH-081253-AF

This manual confers no industrial property rights or any rights of any other kind, nor does it confer any patent licenses. Mitsubishi Electric Corporation cannot be held responsible for any problems involving industrial property rights which may occur as a result of using the contents noted in this manual.

© 2014 MITSUBISHI ELECTRIC CORPORATION

WARRANTY

Please confirm the following product warranty details before using this product.

1. Gratis Warranty Term and Gratis Warranty Range

If any faults or defects (hereinafter "Failure") found to be the responsibility of Mitsubishi occurs during use of the product within the gratis warranty term, the product shall be repaired at no cost via the sales representative or Mitsubishi Service Company.

However, if repairs are required onsite at domestic or overseas location, expenses to send an engineer will be solely at the customer's discretion. Mitsubishi shall not be held responsible for any re-commissioning, maintenance, or testing on-site that involves replacement of the failed module.

[Gratis Warranty Term]

The gratis warranty term of the product shall be for one year after the date of purchase or delivery to a designated place. Note that after manufacture and shipment from Mitsubishi, the maximum distribution period shall be six (6) months, and the longest gratis warranty term after manufacturing shall be eighteen (18) months. The gratis warranty term of repair parts shall not exceed the gratis warranty term before repairs.

[Gratis Warranty Range]

- (1) The range shall be limited to normal use within the usage state, usage methods and usage environment, etc., which follow the conditions and precautions, etc., given in the instruction manual, user's manual and caution labels on the product.
- (2) Even within the gratis warranty term, repairs shall be charged for in the following cases.
 1. Failure occurring from inappropriate storage or handling, carelessness or negligence by the user. Failure caused by the user's hardware or software design.
 2. Failure caused by unapproved modifications, etc., to the product by the user.
 3. When the Mitsubishi product is assembled into a user's device, Failure that could have been avoided if functions or structures, judged as necessary in the legal safety measures the user's device is subject to or as necessary by industry standards, had been provided.
 4. Failure that could have been avoided if consumable parts (battery, backlight, fuse, etc.) designated in the instruction manual had been correctly serviced or replaced.
 5. Failure caused by external irresistible forces such as fires or abnormal voltages, and Failure caused by force majeure such as earthquakes, lightning, wind and water damage.
 6. Failure caused by reasons unpredictable by scientific technology standards at time of shipment from Mitsubishi.
 7. Any other failure found not to be the responsibility of Mitsubishi or that admitted not to be so by the user.

2. Onerous repair term after discontinuation of production

- (1) Mitsubishi shall accept onerous product repairs for seven (7) years after production of the product is discontinued. Discontinuation of production shall be notified with Mitsubishi Technical Bulletins, etc.
- (2) Product supply (including repair parts) is not available after production is discontinued.

3. Overseas service

Overseas, repairs shall be accepted by Mitsubishi's local overseas FA Center. Note that the repair conditions at each FA Center may differ.

4. Exclusion of loss in opportunity and secondary loss from warranty liability

Regardless of the gratis warranty term, Mitsubishi shall not be liable for compensation to:

- (1) Damages caused by any cause found not to be the responsibility of Mitsubishi.
- (2) Loss in opportunity, lost profits incurred to the user by Failures of Mitsubishi products.
- (3) Special damages and secondary damages whether foreseeable or not, compensation for accidents, and compensation for damages to products other than Mitsubishi products.
- (4) Replacement by the user, maintenance of on-site equipment, start-up test run and other tasks.

5. Changes in product specifications

The specifications given in the catalogs, manuals or technical documents are subject to change without prior notice.

TRADEMARKS

Microsoft and Windows are trademarks of the Microsoft group of companies.

Oracle and JavaScript are registered trademarks of Oracle and/or its affiliates.

Linux is the registered trademark of Linus Torvalds in the U.S. and other countries.

The company names, system names and product names mentioned in this manual are either registered trademarks or trademarks of their respective companies.

In some cases, trademark symbols such as [™] or [®] are not specified in this manual.

SH(NA)-081257ENG-AC(2405)MEE

MODEL: R-ETHER-U-OU-E

MODEL CODE: 13JX16

MITSUBISHI ELECTRIC CORPORATION

HEAD OFFICE: TOKYO BLDG., 2-7-3, MARUNOUCHI, CHIYODA-KU, TOKYO 100-8310, JAPAN
NAGOYA WORKS: 1-14, YADA-MINAMI 5-CHOME, HIGASHI-KU, NAGOYA 461-8670, JAPAN

When exported from Japan, this manual does not require application to the
Ministry of Economy, Trade and Industry for service transaction permission.

Specifications subject to change without notice.