

Programmable Controller

CC-Link IE Field Network Remote IO-Link Module User's Manual

-NZ2GF2S-60IOLD8
-SW1DNN-IOLCDTM-BD

SAFETY PRECAUTIONS

(Read these precautions before using this product.)

Before using this product, please read this manual and the relevant manuals carefully and pay full attention to safety to handle the product correctly.

The precautions given in this manual are concerned with this product only. For the safety precautions of the programmable controller system, refer to the user's manual for the CPU module used.

In this manual, the safety precautions are classified into two levels: "⚠ WARNING" and "⚠ CAUTION".

WARNING

Indicates that incorrect handling may cause hazardous conditions, resulting in death or severe injury.

CAUTION

Indicates that incorrect handling may cause hazardous conditions, resulting in minor or moderate injury or property damage.

Under some circumstances, failure to observe the precautions given under "⚠ CAUTION" may lead to serious consequences.

Observe the precautions of both levels because they are important for personal and system safety.

Make sure that the end users read this manual and then keep the manual in a safe place for future reference.

[Design Precautions]

WARNING

- In the case of a communication failure in the network, data in the master/local module are held. Check Data link status (each station) (SW00B0 to SW00B7) and configure an interlock circuit in the program to ensure that the entire system will operate safely.
 - When the module is disconnected due to a communication failure in the network or the CPU module is in the STOP state, all outputs are held or turned off according to the parameter setting. Configure an interlock circuit in the program to ensure that the entire system will always operate safely even in such a case. Failure to do so may result in an accident due to an incorrect output or malfunction.
 - Outputs may remain on or off due to a failure of the module. Configure an external circuit for monitoring output signals that could cause a serious accident.
 - Do not use any "use prohibited" signals as a remote input or output signal. These signals are reserved for system use. Do not write any data to the "use prohibited" areas in the remote register or the remote buffer memory. If these operations are performed, correct operation of the module cannot be guaranteed.
-

[Design Precautions]

CAUTION

- Do not install the control lines or communication cables together with the main circuit lines or power cables. Keep a distance of 100mm or more between them. Failure to do so may result in malfunction due to noise.
 - During control of an inductive load such as a lamp, heater, or solenoid valve, a large current (approximately ten times greater than normal) may flow when the output is turned from off to on. Therefore, use a module that has a sufficient current rating.
-

[Security Precautions]

WARNING

- To maintain the security (confidentiality, integrity, and availability) of the programmable controller and the system against unauthorized access, denial-of-service (DoS) attacks, computer viruses, and other cyberattacks from external devices via the network, take appropriate measures such as firewalls, virtual private networks (VPNs), and antivirus solutions.
-

[Installation Precautions]

WARNING

- Shut off the external power supply (all phases) used in the system before mounting or removing the module. Failure to do so may result in electric shock or cause the module to fail or malfunction.
-

[Installation Precautions]

CAUTION

- Use the module in an environment that meets the general specifications in this manual. Failure to do so may result in electric shock, fire, malfunction, or damage to or deterioration of the product.
 - Do not directly touch any conductive parts and electronic components of the module. Doing so can cause malfunction or failure of the module.
 - Securely connect the cable connectors. Poor contact may cause malfunction.
 - After the first use of the product, do not connect/disconnect the connector more than 50 times (IEC 61131-2/JIS B 3502 compliant). Exceeding the limit may cause malfunction.
-

[Wiring Precautions]

WARNING

- Shut off the external power supply (all phases) used in the system before wiring. Failure to do so may result in electric shock or cause the module to fail or malfunction.
-

[Wiring Precautions]

CAUTION

- Individually ground the FG terminal of the programmable controller with a ground resistance of 100 ohms or less. Failure to do so may result in electric shock or malfunction.
 - Check the rated voltage and terminal layout before wiring to the module, and connect the cables correctly. Connecting a power supply with a different voltage rating or incorrect wiring may cause a fire or failure.
 - Tighten the terminal block screws within the specified torque range. Undertightening can cause short circuit, fire, or malfunction. Overtightening can damage the screw and/or module, resulting in drop, short circuit, fire, or malfunction.
 - Prevent foreign matter such as dust or wire chips from entering the module. Such foreign matter can cause a fire, failure, or malfunction.
 - Place the cables in a duct or clamp them. If not, dangling cable may swing or inadvertently be pulled, resulting in damage to the module or cables or malfunction due to poor contact.
 - Do not install the control lines or communication cables together with the main circuit lines or power cables. Keep a distance of 100mm or more between them. Failure to do so may result in malfunction due to noise.
 - When disconnecting the cable from the module, do not pull the cable by the cable part. For the cable with connector, hold the connector part of the cable. For the cable connected to the terminal block, loosen the terminal screw. Pulling the cable connected to the module may result in malfunction or damage to the module or cable.
 - When an overcurrent caused by a failure of an external device or a programmable controller flows for a long time, it may cause smoke and fire. To prevent this, configure external safety circuits, such as fuses, for the module power supply and external power supply.
 - Mitsubishi programmable controllers must be installed in control panels. Wiring and replacement of a module must be performed by qualified maintenance personnel with knowledge of protection against electric shock. For wiring methods, refer to "INSTALLATION AND WIRING" in this manual for the module.
 - Do not connect an output device of an SIO device to the channel set to IO-Link mode. Failure to do so may cause malfunction.
-

[Startup and Maintenance Precautions]

WARNING

- Do not touch any terminal while power is on. Doing so will cause electric shock or malfunction.
 - Shut off the external power supply (all phases) used in the system before cleaning the module or retightening the terminal block screws and connector screws. Failure to do so may cause the module to fail or malfunction.
-

[Startup and Maintenance Precautions]

CAUTION

- Do not disassemble or modify the modules. Doing so may cause failure, malfunction, injury, or a fire.
 - Do not drop or apply strong shock to the module. Doing so may damage the module.
 - Shut off the external power supply (all phases) used in the system before mounting or removing the module. Failure to do so may cause the module to fail or malfunction.
 - After the first use of the product, do not mount/remove the module more than 50 times (IEC 61131-2/JIS B 3502 compliant). Exceeding the limit may cause malfunction.
 - After the first use of the product, do not connect/disconnect the connector more than 50 times (IEC 61131-2/JIS B 3502 compliant). Exceeding the limit may cause malfunction.
 - Before handling the module or the cable to be connected to the module, touch a conducting object such as a grounded metal to discharge the static electricity from the human body. Failure to do so may cause the module to fail or malfunction.
 - Startup and maintenance of a control panel must be performed by qualified maintenance personnel with knowledge of protection against electric shock. Lock the control panel so that only qualified maintenance personnel can operate it.
-

[Disposal Precautions]

CAUTION

- When disposing of this product, treat it as industrial waste.
-

CONDITIONS OF USE FOR THE PRODUCT

(1) MELSEC programmable controller ("the PRODUCT") shall be used in conditions;

- i) where any problem, fault or failure occurring in the PRODUCT, if any, shall not lead to any major or serious accident; and
- ii) where the backup and fail-safe function are systematically or automatically provided outside of the PRODUCT for the case of any problem, fault or failure occurring in the PRODUCT.

(2) The PRODUCT has been designed and manufactured for the purpose of being used in general industries.

MITSUBISHI ELECTRIC SHALL HAVE NO RESPONSIBILITY OR LIABILITY (INCLUDING, BUT NOT LIMITED TO ANY AND ALL RESPONSIBILITY OR LIABILITY BASED ON CONTRACT, WARRANTY, TORT, PRODUCT LIABILITY) FOR ANY INJURY OR DEATH TO PERSONS OR LOSS OR DAMAGE TO PROPERTY CAUSED BY THE PRODUCT THAT ARE OPERATED OR USED IN APPLICATION NOT INTENDED OR EXCLUDED BY INSTRUCTIONS, PRECAUTIONS, OR WARNING CONTAINED IN MITSUBISHI ELECTRIC USER'S, INSTRUCTION AND/OR SAFETY MANUALS, TECHNICAL BULLETINS AND GUIDELINES FOR the PRODUCT.

("Prohibited Application")

Prohibited Applications include, but not limited to, the use of the PRODUCT in;

- Nuclear Power Plants and any other power plants operated by Power companies, and/or any other cases in which the public could be affected if any problem or fault occurs in the PRODUCT.
- Railway companies or Public service purposes, and/or any other cases in which establishment of a special quality assurance system is required by the Purchaser or End User.
- Aircraft or Aerospace, Medical applications, Train equipment, transport equipment such as Elevator and Escalator, Incineration and Fuel devices, Vehicles, Manned transportation, Equipment for Recreation and Amusement, and Safety devices, handling of Nuclear or Hazardous Materials or Chemicals, Mining and Drilling, and/or other applications where there is a significant risk of injury to the public or property.

Notwithstanding the above restrictions, Mitsubishi Electric may in its sole discretion, authorize use of the PRODUCT in one or more of the Prohibited Applications, provided that the usage of the PRODUCT is limited only for the specific applications agreed to by Mitsubishi Electric and provided further that no special quality assurance or fail-safe, redundant or other safety features which exceed the general specifications of the PRODUCTS are required. For details, please contact the Mitsubishi Electric representative in your region.

(3) Mitsubishi Electric shall have no responsibility or liability for any problems involving programmable controller trouble and system trouble caused by DoS attacks, unauthorized access, computer viruses, and other cyberattacks.

INTRODUCTION

Thank you for purchasing the CC-Link IE Field Network remote IO-Link module (hereafter abbreviated as IO-Link module). This manual describes the procedures, system configuration, parameter settings, functions, and troubleshooting of the IO-Link module.

Before using this product, please read this manual and the relevant manuals carefully and develop familiarity with the functions and performance of the IO-Link module to handle the product correctly.

When applying the program examples provided in this manual to an actual system, ensure the applicability and confirm that it will not cause system control problems.

Please make sure that the end users read this manual.

Relevant product

NZ2GF2S-60IOLD8

Point

Unless otherwise specified, this manual provides program examples in which the remote I/O signals and the remote register of an IO-Link module are assigned as follows.

- Remote input signal: RX0 to RX2F
- Remote output signal: RY0 to RY2F
- Remote register: RWr0 to RWr83, RWw0 to RWw83

For the assignment of remote I/O signals and remote registers, refer to the following.

 User's manual for the master/local module used

The RJ71GF11-T2 is used as the master/local module in this manual.

CONTENTS

SAFETY PRECAUTIONS	1
CONDITIONS OF USE FOR THE PRODUCT	5
INTRODUCTION	6
RELEVANT MANUALS	10
TERMS	11
GENERIC TERMS AND ABBREVIATIONS	12
CHAPTER 1 PART NAMES	13
CHAPTER 2 SPECIFICATIONS	15
2.1 General Specifications	15
2.2 Performance Specifications	16
Function list	20
CHAPTER 3 PROCEDURES BEFORE OPERATION	22
CHAPTER 4 SYSTEM CONFIGURATION	24
4.1 Applicable Systems	24
CHAPTER 5 INSTALLATION AND WIRING	26
5.1 Before Using the IO-Link Module	26
5.2 Setting Switch	29
Setting station number setting switches	29
Function setting switch setting	30
5.3 Installation Environment and Installation Position	31
Installation environment	31
Installation position	31
Installation direction	32
5.4 Installation	33
Mounting the modules on a DIN rail	33
5.5 Wiring	35
Wiring with terminal block for module power supply and FG	35
Wiring of Ethernet cable	37
Wiring of IO-Link terminal block and external devices	39
CHAPTER 6 PARAMETER SETTING	43
6.1 CC-Link IE Field Network Parameter Setting	43
6.2 IO-Link Module Parameter Setting	45
6.3 Changing the IO-Link Module Parameters	48
6.4 IO-Link Device Parameter Setting	54
Setting procedure when FDC and CommDTM are used	54
Conversion procedure of IODD	57
Creation procedure of FDC project	59
Procedure for adding M_CommDTM-IOLink	60
Procedure for configuring communication setting with M_CommDTM-IOLink	61
Procedure for setting the IO-Link device parameter	63

CHAPTER 7 FUNCTIONS **64**

7.1	IO-Link Master Functions	64
	IO-Link cyclic transmission function	64
	IO-Link transient communication function	66
	IO-Link device setting automatic upload/download function	67
	IO-Link device validation function	70
	Disconnection detection function	73
	Input data masking function	74
	Swap function	76
	Bit segment function	78
	IO-Link communication retry count integration function	81
7.2	Input Function	83
	Input OFF delay function	83
	Input response time setting function	85
7.3	Output Function	87
	Number of output ON times integration function	87
	Output ON/OFF information hold function	88
7.4	CC-Link IE Field Network Communication Function	89
	Cyclic transmission	89
	Transient transmission	90
	Fast link-up function	91
	Output HOLD/CLEAR setting function	94
7.5	Event Acquisition Function	96
7.6	Protection Function	97
7.7	External Power Supply Monitoring Function	98
7.8	Device Replacement Function	99
	Device replacement	99

CHAPTER 8 FUNCTION BLOCK (FB) **103**

CHAPTER 9 PROGRAMMING **105**

9.1	Precautions for Programming	105
9.2	Example of Program to Communicate with an IO-Link Device	106
9.3	Example of Program to Communicate with SIO Device	115

CHAPTER 10 MAINTENANCE AND INSPECTION **119**

CHAPTER 11 TROUBLESHOOTING **121**

11.1	Checking the LEDs	121
11.2	Unit Test	124
11.3	Troubleshooting by Symptom	125
11.4	Examples of Troubles with IO-Link Modules	127
	Troubleshooting for input circuit	127
	Troubleshooting for output circuit	127
11.5	Checking for the Error Codes and the Warning Codes	129
11.6	Method for Checking the Event History	132
11.7	Error Codes and Warning Codes	134
	List of error codes and the warning codes	134
11.8	Event History List	142

APPENDICES	145
Appendix 1 Remote I/O Signals	145
List of remote I/O signals	145
Details of remote input signals	147
Details of remote output signals	150
Appendix 2 Remote Register	151
List of remote register	151
Details of remote register	154
Appendix 3 Remote Buffer Memory	161
List of remote buffer memory	161
Details of remote buffer memory addresses	167
Appendix 4 IO-Link Device Replacement Procedure	189
When the IO-Link module is replaced while the module is powered off	189
When the IO-Link module is replaced while the module is powered on	191
Appendix 5 Processing Time	193
Input response time	193
Output response time	193
Appendix 6 EMC and Low Voltage Directives	194
Measures to comply with the EMC Directive	194
Requirements to compliance with the Low Voltage Directive	199
Appendix 7 How to Check Serial Number and Function Version	200
Appendix 8 Added and Enhanced Functions	201
Appendix 9 External Dimensions	202
 INDEX	 204
REVISIONS	206
WARRANTY	207
TRADEMARKS	208

RELEVANT MANUALS

Manual name [manual number]	Description	Available form
CC-Link IE Field Network Remote IO-Link Module User's Manual [SH-081917ENG] (this manual)	Part names, specifications, procedures before operation, system configuration, installation, wiring, parameter settings, functions, programming, and troubleshooting of the IO-Link module	Print book e-Manual PDF



e-Manual refers to the Mitsubishi Electric FA electronic book manuals that can be browsed using a dedicated tool.

e-Manual has the following features:

- Required information can be cross-searched in multiple manuals.
- Other manuals can be accessed from the links in the manual.
- The hardware specifications of each part can be found from the product figures.
- Pages that users often browse can be bookmarked.
- Sample programs can be copied to an engineering tool.

TERMS

Unless otherwise specified, this manual uses the following terms.

Term	Description
CC-Link IE Field Network	A high-speed and large-capacity open field network that is based on Ethernet (1000BASE-T)
CommDTM (Communication DTM)	A software module used to configure the communication setting required for communications between a personal computer and field devices via the IO-Link master
CQ input signal	An external input signal that is input by the IO-Link master via the CQ line when the operation mode is SIO (sink input) mode
CQ output signal	An external output signal that is output by the IO-Link master via the CQ line when the operation mode is SIO (source output) mode
Cyclic transmission	A function by which data are periodically exchanged among stations on the same network using link devices
Dedicated instruction	An instruction that simplifies programming for using functions of intelligent function modules
Device DTM	A software module used to configure the parameter settings of field devices or monitor field devices
DI signal	An external input signal that is input by the IO-Link master via the DI line when the operation mode is IO-Link (sink input) mode
DTM (Device Type Manager)	A software module used to configure the communication settings, set parameters of field devices, or monitor field devices when an FDT frame application is used
Engineering tool	A tool used for setting up programmable controllers, programming, debugging, and maintenance
FDT (Field Device Tool)	Software standard specifications for management, maintenance, adjustment, and development of field devices
Global label	A label that is valid for all the program data when multiple program data are created in the project. There are two types of global label: a module specific label (module label), which is generated automatically by GX Works3, and an optional label, which can be created for any specified device.
Intelligent device station	A station that exchanges I/O signals (bit data) and I/O data (word data) with the master station by cyclic transmission. This station can perform transient transmission as well. This station responds to a transient transmission request from another station and also issues a transient transmission request to another station.
Link device	A device (RX, RY, RWr, RWw, SB, or SW) in a module on CC-Link IE Field Network and in an interface board
Local station	A station that performs cyclic transmission and transient transmission with the master station and other local stations
M_CommDTM-IOLink	A CommDTM that supports communications with IO-Link devices via an IO-Link module
Master station	A station that controls the entire network. This station can perform cyclic transmission and transient transmission with all stations. Only one master station can be used in a network.
MELSOFT FieldDeviceConfigurator	Configuration Tool, which is developed by Mitsubishi Electric Corporation. MELSOFT FieldDeviceConfigurator complies with the FDT/DTM open standard and is used for parameter settings, maintenance, and adjustment of field devices as an FDT frame application.
Module label	A label that represents one of memory areas (I/O signals and buffer memory areas) specific to each module in a given character string. For the module used, GX Works3 automatically generates this label, which can be used as a global label.
Reserved station	A station reserved for future use. This station is not actually connected, but counted as a connected station.
SIO device	An existing general-purpose I/O device that does not support IO-Link
Transient transmission	A function of communication with another station, which is used when requested by a dedicated instruction or the engineering tool

GENERIC TERMS AND ABBREVIATIONS

Unless otherwise specified, this manual uses the following generic terms and abbreviations.



Generic term/abbreviation	Description
CPU module	A generic term for the MELSEC iQ-R series CPU module, MELSEC-Q series CPU module, and MELSEC-L series CPU module
Data link	A generic term for cyclic transmission and transient transmission
Device station	A generic term for a local station, remote I/O station, remote device station, and intelligent device station
FDC	An abbreviation for MELSOFT FieldDeviceConfigurator
FDT frame application	A generic term for applications to use a DTM. An FDT frame application complies with the FDT/DTM open standard
IO-Link mode	A generic term for the IO-Link (standard) mode and IO-Link (sink input) mode
IO-Link module	An abbreviation for the CC-Link IE Field Network remote IO-Link module
Master/local module	A generic term for CC-Link IE Field Network master/local modules
REMFR	A generic term for the JP.REMFR and ZP.REMFR
REMTO	A generic term for the JP.REMTO and ZP.REMTO
SIO mode	A generic term for the SIO (sink input) mode and SIO (source output) mode

1 PART NAMES

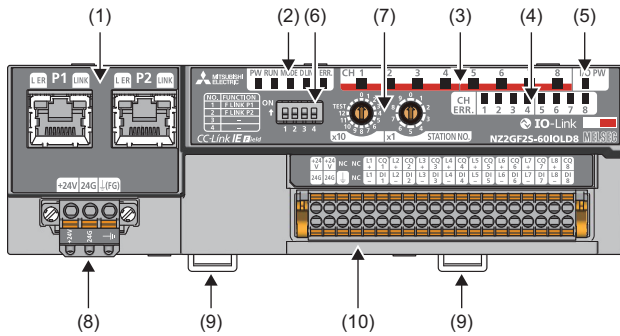
This section describes part names of the IO-Link module.



No.	Name	Application
(1)	P1	PORT1 connector for CC-Link IE Field Network (RJ45 connector) An Ethernet cable is connected. (☞ Page 37 Wiring of Ethernet cable)
	L ER LED	<ul style="list-style-type: none"> On: Module received abnormal data, or module performing loopback Off: Module received normal data, or module not performing loopback
	LINK LED	Indicates the link status <ul style="list-style-type: none"> On: Link-up in progress Off: Link-down in progress
	P2	PORT2 connector for CC-Link IE Field Network (RJ45 connector) An Ethernet cable is connected. (☞ Page 37 Wiring of Ethernet cable)
	L ER LED	(Same as the LEDs of P1 connector)
	LINK LED	
(2)	PW LED	Indicates the power supply status of the IO-Link module. <ul style="list-style-type: none"> On: Power supply ON Off: Power supply OFF
	RUN LED	Indicates the operating status of the IO-Link module. <ul style="list-style-type: none"> On: Operating normally Off: A major error has occurred.
	MODE LED	Indicates the mode of the IO-Link module. <ul style="list-style-type: none"> On: Online mode Flashing: Unit test mode Off: In offline mode, or the unit test is completed.
	D LINK LED	Indicates the data link status of the IO-Link module. <ul style="list-style-type: none"> On: Data link in operation (cyclic transmission in progress) Flashing: Data link in operation (cyclic transmission stopped) Off: Data link not performed (disconnected or in unit test mode)
	ERR. LED	Indicates the error status of the IO-Link module. <ul style="list-style-type: none"> On: A moderate or major error has occurred. Flashing: A minor error has occurred. Off: Operating normally When a major error has been occurred, check RUN LED as well.
(3)	CH1 to CH8 LED (green)	Indicates the operating status of each channel in IO-Link mode. <ul style="list-style-type: none"> On: Normal IO-Link communications Flashing: IO-Link communication error*1 Off: Other than IO-Link mode
	CH1 to CH8 LED (yellow)	Indicates on/off of input or output for each channel in SIO mode <ul style="list-style-type: none"> On: I/O is on. Off: I/O is off.
(4)	CH1 to CH8 ERR. LED	Indicates the error status of each channel in IO-Link mode or SIO mode. <ul style="list-style-type: none"> On: Channel error Off: Channels operating normally
(5)	I/O PW LED	Indicates the status of the power supply from the external power supply. <ul style="list-style-type: none"> On: External power supply ON Off: External power supply OFF
(6)	Function setting switch	A switch for the fast link-up function (☞ Page 30 Function setting switch setting)

No.	Name	Application
(7)	Station number setting switch	A rotary switch for setting station numbers and used for unit tests. <ul style="list-style-type: none"> •  Page 29 Setting station number setting switches •  Page 124 Unit Test
(8)	Terminal block for module power supply and FG	A terminal block to connect the module power supply (24VDC) and FG
(9)	DIN rail hook	A hook to mount an IO-Link module on a DIN rail
(10)	IO-Link terminal block	A terminal block to connect the external power supply and an external device

*1 IO-Link communication errors will occur if input process data and output process data are invalid. ( Page 156 Input process data, Page 159 Output process data)

2 SPECIFICATIONS

This chapter describes the specifications of the IO-Link module.

2.1 General Specifications

Item	Specifications					
Operating ambient temperature	0 to 55°C					
Storage ambient temperature	-25 to 75°C					
Operating ambient humidity	5 to 95%RH, non-condensing					
Storage ambient humidity						
Vibration resistance	Compliant with JIS B 3502 and IEC 61131-2	—	Frequency	Constant acceleration	Half amplitude	Sweep count
		Under intermittent vibration	5 to 8.4Hz	—	3.5mm	10 times each in X, Y, and Z directions
			8.4 to 150Hz	9.8m/s ²	—	
		Under continuous vibration	5 to 8.4Hz	—	1.75mm	—
8.4 to 150Hz	4.9m/s ²		—			
Shock resistance	Compliant with JIS B 3502 and IEC 61131-2 (147m/s ² , 3 times each in X, Y, and Z directions)					
Operating atmosphere	No corrosive gases, flammable gases, less conductive dust					
Operating altitude*1	0 to 2000m*5					
Installation location	Inside a control panel*2					
Overvoltage category*3	II or less					
Pollution degree*4	2 or less					
Equipment class	Class I					

- *1 Do not use or store the IO-Link module under pressure higher than the atmospheric pressure of altitude 0m. Doing so may cause malfunction. When using the IO-Link module under pressure, please consult your local Mitsubishi representative.
- *2 If the environment satisfies the operating ambient temperature, operating ambient humidity and other conditions, the module can be used even outside the control panel.
- *3 This indicates the section of the power supply to which the equipment is assumed to be connected between the public electrical power distribution network and the machinery within premises.
Category II applies to equipment for which electrical power is supplied from fixed facilities. The surge voltage withstand level for up to the rated voltage of 300V is 2500V.
- *4 This index indicates the degree to which conductive material is generated in terms of the environment in which the equipment is used. Pollution degree 2 is when only non-conductive pollution occurs. A temporary conductivity caused by condensing must be expected occasionally.
- *5 When the programmable controller is used at altitude above 2000m, the withstand voltage performance and the upper limit of the operating ambient temperature decrease. Please consult your local Mitsubishi representative.

Point 

To use the IO-Link module complying with the EMC Directive, refer to "EMC and Low Voltage Directives" in this manual. ( Page 194 EMC and Low Voltage Directives)

2.2 Performance Specifications

NZ2GF2S-60IOLD8 IO-Link module

Item		NZ2GF2S-60IOLD8
Module type	CC-Link IE Field Network	Intelligent device station
	IO-Link	IO-Link master
Rated input voltage		24VDC (ripple rate: 5% or less) (allowable voltage range 20.4 to 28.8VDC (24VDC -15 to +20%))
Insulation method	Between I/O and power supply	Digital isolator
	Between channels	None
Withstand voltage		500VDC for 1 minute between all DC external terminals and the ground
Insulation resistance		10MΩ or higher between all DC external terminals and ground (500VDC insulation resistance tester)
Noise immunity		Noise voltage 500Vp-p, noise width 1μs, noise frequency 25 to 60Hz (DC type noise simulator condition)
Protection degree		IP2X
Wiring method for common		8 points/common
Surge suppressor		Zener diode
Fuse		None
Protection function	C/Q	Overcurrent, overload protection
	L+	Overcurrent
External interface	CC-Link IE Field Network part	RJ45 connector
	Module power supply part	Terminal block for module power supply and FG (spring clamp terminal block (push-in type))
	IO-Link part	40-point 2-piece spring clamp terminal block (push-in type)
Module operation start time ⁴	IO-Link mode ⁵	<ul style="list-style-type: none"> • 1 channel: 1.5 to 4 seconds • 8 channels: 12 to 32 seconds
	SIO mode	<ul style="list-style-type: none"> • 1 channel: 0.2 seconds • 8 channels: 0.2 seconds
Applicable DIN rail		TH35-7.5Fe, TH35-7.5Al (compliant with IEC 60715)
Applicable wire size	Terminal block for module power supply and FG	Core: 0.5 to 2.0mm ² (20 to 14 AWG), terminal slot size: 2.8mm × 2.0mm
	IO-Link terminal block	<ul style="list-style-type: none"> ■ For +24V/24G/FG Core: 0.5 to 1.5mm² (20 to 16 AWG), terminal slot size: 2.4mm × 1.5mm ■ For CQ/L+/L-/DI Core: 0.2 to 1.5mm² (24 to 16 AWG), terminal slot size: 2.4mm × 1.5mm
Applicable solderless terminal	Terminal block for module power supply and FG ^{*1}	☞ Page 35 Applicable solderless terminal
	IO-Link terminal block ^{*1*3}	☞ Page 39 Applicable solderless terminal
Operation mode		<p>The following 6 modes are available.</p> <ul style="list-style-type: none"> • Disabled mode • IO-Link (standard) mode • IO-Link (sink input) mode • SIO (sink input) mode • SIO (source output) mode • Power supply mode
IO-Link mode	Supported protocol	v1.1.2
	Number of channels	8 channels max.
	Rated load current (C/Q)	200mA/channel, 4A/common
	Rated load current (L+)	1.6A/channel, 4A/common
	Transmission speed	<ul style="list-style-type: none"> • COM1: 4.8kbps • COM2: 38.4kbps • COM3: 230.4kbps <p>Determined by the IO-Link device connected. The transmission speed is switched automatically.</p>
	IO-Link mode	Compliant with IO-Link standard
Cyclic transmission	RX/Ry points	48 points
	RWr/RWw points	132 points

Item		NZ2GF2S-60IOLD8
IO-Link (sink input) mode	Number of channels	8 channels max.
	Rated input current	2.5mA TYP. (for 24VDC)
	Input response time	<ul style="list-style-type: none"> • 0ms • 1ms • 1.5ms • 5ms • 10ms (default value) • 20ms • 70ms
	ON voltage/ON current	12VDC or more/2mA or more
	OFF voltage/OFF current	6VDC or less/2mA or less
SIO (sink input) mode	Number of channels	8 channels max.
	Rated input current	2.4mA TYP. (for 24VDC)
	Input response time ^{*2}	<ul style="list-style-type: none"> • 0ms • 1ms • 1.5ms • 5ms • 10ms (default value) • 20ms • 70ms
	ON voltage/ON current	11VDC or more/2mA or more
	OFF voltage/OFF current	6VDC or less/2mA or less
SIO (source output) mode	Number of channels	8 channels max.
	Rated load current	200mA/point, 4A/common
	Maximum inrush current	650mA 100 μ s or less
	Leakage current at OFF	0.1mA or less
	Maximum voltage drop at ON	0.88V or less, 0.2mA
IO-Link cable	Cable type	Unshielded
	Cable length	20m maximum
	Cable diameter	Core 0.2 to 1.5mm ²
Communication cable		An Ethernet cable that meets the 1000BASE-T standard: Category 5e or higher (double shielded, STP), straight cable
Module power supply	Voltage	24VDC (ripple rate: 5% or less) (allowable voltage range 20.4 to 28.8VDC (24VDC -15 to +20%))
	Current	130mA (24VDC, all points ON)
	Protection function	None
	Fuse	None
External power supply	Voltage	24VDC (ripple rate: 5% or less) (allowable voltage range 20.4 to 28.8VDC (24VDC -15 to +20%))
	Current	95mA or less (24VDC, all points ON)
	Protection function	None
	Fuse	None
Weight		0.24kg

*1 Only one wire can be connected to a terminal. Multiple wires cannot be connected to a terminal. Connecting two or more wires may cause a poor contact.

*2 For details on the input response time, refer to the following.

☞ Page 193 Processing Time

*3 Use cables suitable for the current value used.

*4 The time taken for data link establishment with the master station at power-on is not included.

*5 The module operation start time written is a rough standard. The time depends on the response performance and data storage size of the IO-Link device. In addition, because the start processing is performed for each channel, it takes longer time to start operation of the module as the number of channels of which operation mode is set to IO-Link mode increases.

External connection

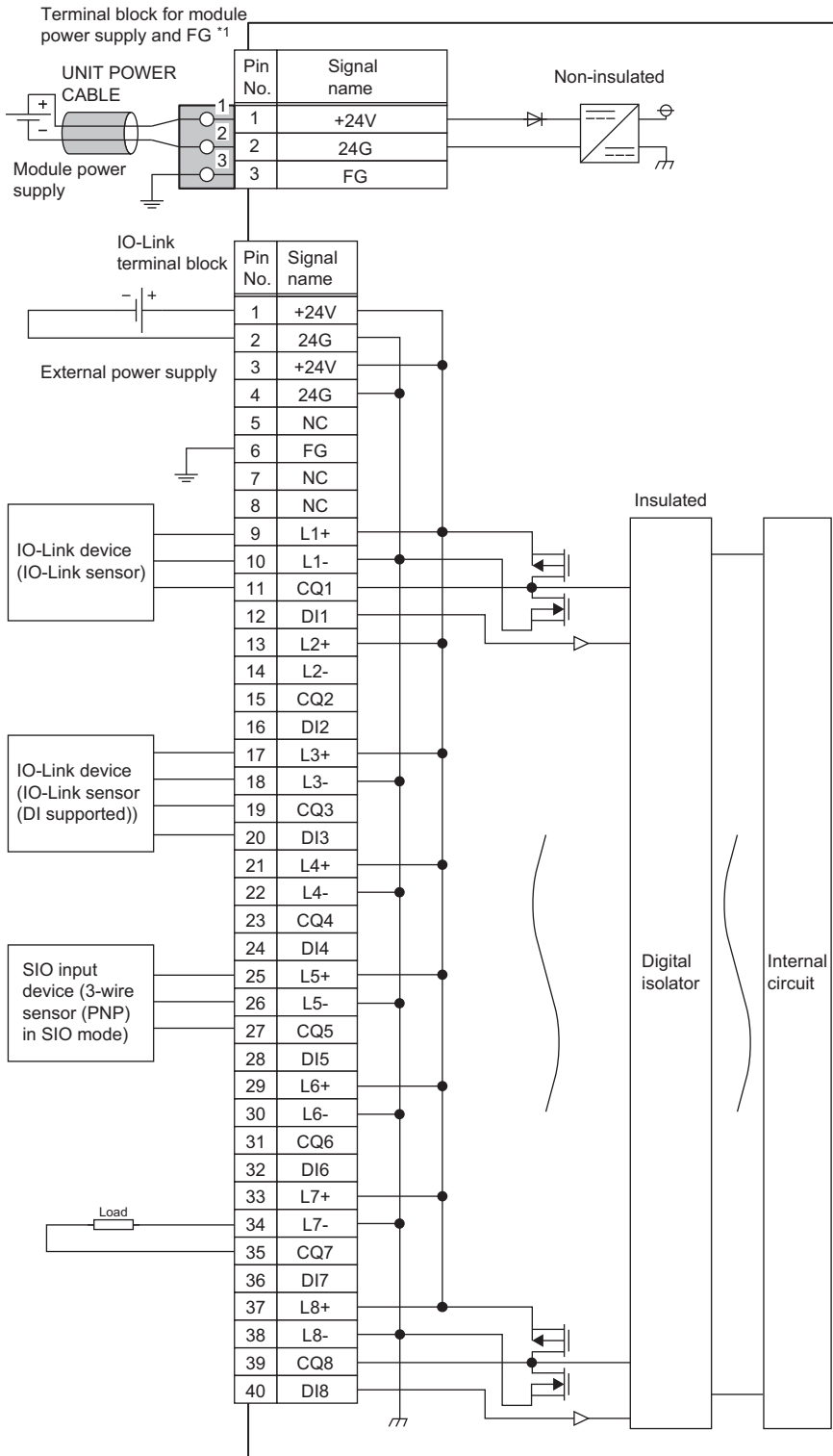

*1 Only one wire can be connected to a terminal of the terminal block for module power supply and FG. Multiple wires cannot be connected to a terminal. Connecting two or more wires may cause a poor contact.

■IO-Link terminal block

1 3 5 7 9 11 13 15 17 19 21 23 25 27 29 31 33 35 37 39

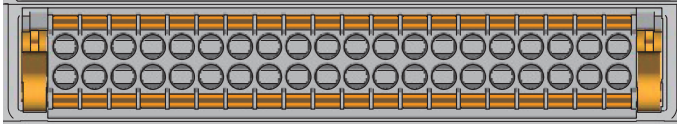

2 4 6 8 10 12 14 16 18 20 22 24 26 28 30 32 34 36 38 40

Pin number	Signal name	Pin number	Signal name
1	+24V	21	L4+
2	24G	22	L4-
3	+24V	23	CQ4
4	24G	24	DI4
5	NC	25	L5+
6	FG	26	L5-
7	NC	27	CQ5
8	NC	28	DI5
9	L1+	29	L6+
10	L1-	30	L6-
11	CQ1	31	CQ6
12	DI1	32	DI6
13	L2+	33	L7+
14	L2-	34	L7-
15	CQ2	35	CQ7
16	DI2	36	DI7
17	L3+	37	L8+
18	L3-	38	L8-
19	CQ3	39	CQ8
20	DI3	40	DI8

Function list

This section lists the functions of IO-Link modules.

IO-Link master functions

Item	Description	Reference
IO-Link cyclic transmission function	Communicates process data periodically with the IO-Link device connected to each channel.	Page 64 IO-Link cyclic transmission function
IO-Link transient communication function	Reads/writes parameters at any timing from/to the IO-Link device connected to each channel.	Page 66 IO-Link transient communication function
IO-Link device setting automatic upload/download function	Saves the parameters of the IO-Link device connected to each channel in the IO-Link module, and as necessary, overwrites the parameters of the IO-Link devices.	Page 67 IO-Link device setting automatic upload/download function
IO-Link device validation function	Validates compatibility and identity of the IO-Link device connected to each channel.	Page 70 IO-Link device validation function
Disconnection detection function	Detects disconnection if communication with an IO-Link device is lost in IO-Link mode.	Page 73 Disconnection detection function
Input data masking function	Calculates ON/OFF values in IO-Link (standard) mode according to the input process data.	Page 74 Input data masking function
Swap function	Swaps the upper and lower bytes of data sent and received between the IO-Link module and the IO-Link device connected to each channel.	Page 76 Swap function
Bit segment function	Segments input process data using the bit count set for each channel.	Page 78 Bit segment function
IO-Link communication retry count integration function	Counts the number of IO-Link communication retries for each channel	Page 81 IO-Link communication retry count integration function

Input function

Item	Description	Reference
Input OFF delay function	This function turns off an X signal after a predetermined time passed from when an actual input becomes off from on.	Page 83 Input OFF delay function
Input response time setting function	This function prevents an incorrect input due to noise by setting the response time until the module recognizes an actual input as the X signal.	Page 85 Input response time setting function

Output function

Item	Description	Reference
Number of output ON times integration function	The number of ON times of each output point is counted within the range of 0 to 2147483647.	Page 87 Number of output ON times integration function
Output ON/OFF information hold function	This function checks if the output has been turned once on or off.	Page 88 Output ON/OFF information hold function

CC-Link IE Field Network communication function

Item	Description	Reference
Cyclic transmission	Periodically exchanges data among stations on the network using link devices. An IO-Link module operates as an intelligent device station on the CC-Link IE Field Network.	Page 89 Cyclic transmission
Transient transmission	Reads or writes data on the IO-Link module in line with a dedicated instruction from the master station. The IO-Link module uses the REMFR instruction or REMTO instruction to perform transient transmission.	Page 90 Transient transmission
Fast link-up function	Shortens the time taken for data link establishment with the master station at power-on.	Page 91 Fast link-up function
Output HOLD/CLEAR setting function	Whether to hold or clear the last SIO output and output process data can be set when the IO-Link module is disconnected from data link or when the CPU module operating status is STOP.	Page 94 Output HOLD/CLEAR setting function

Others

Item	Description	Reference
Event acquisition function	Notifies of IO-Link device events upon sending of event data from the IO-Link device to the IO-Link module.	Page 96 Event Acquisition Function
Protection function	Protects internal circuits from overcurrent and its heat using an overload protection function and overheat protection function.	Page 97 Protection Function
External power supply monitoring function	Monitors the ON/OFF status of the external power supplies of IO-Link modules.	Page 98 External Power Supply Monitoring Function
Device replacement function	Enables device replacement when the IO-Link module power supply is on.	Page 99 Device Replacement Function

3 PROCEDURES BEFORE OPERATION

This chapter describes the procedures before operation.

1. Station number setting

Set the IO-Link module station number.

☞ Page 29 Setting station number setting switches

2. Function setting switch setting

Set the function setting switch.

☞ Page 30 Function setting switch setting

3. Connection

Mount the IO-Link module on the DIN rail.

☞ Page 33 Mounting the modules on a DIN rail

4. Wiring

Wire a power supply, an Ethernet cable, and an external device to the IO-Link module.

☞ Page 35 Wiring with terminal block for module power supply and FG

☞ Page 37 Wiring of Ethernet cable

☞ Page 39 Wiring of IO-Link terminal block and external devices

5. Power-on

Power on the IO-Link module.

6. Parameter setting and programming

Set parameters and create a program.

☞ Page 43 PARAMETER SETTING

☞ Page 105 PROGRAMMING

Point

To replace the IO-Link module, follow the procedure described below.

- Power off the IO-Link module and remove it.
 - Prepare a new IO-Link module and perform the above procedure. (The network parameters of the CC-Link IE Field Network master station do not need to be set again.)
 - After checking the operation, restart the control.
-

4 SYSTEM CONFIGURATION

This chapter describes system configuration using an IO-Link module.

For CC-Link IE Field Network configuration, refer to the following.

 User's manual for the master/local module used

4.1 Applicable Systems

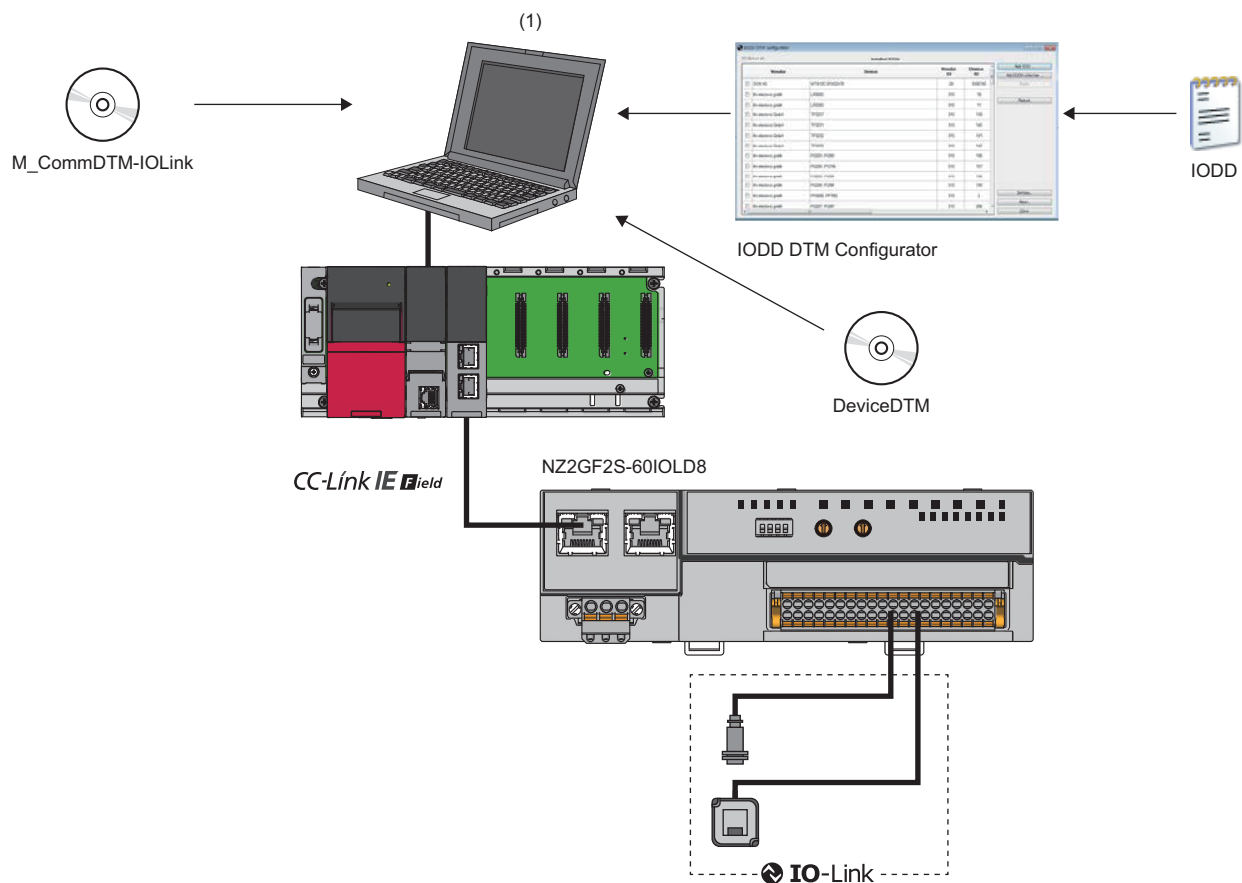

(1) Personal computer (engineering tool/FDC)

Applicable master station

When using an IO-Link module, use the following products as a master station.

Model ^{*1}	First five digits of serial number
RJ71GF11-T2	No restriction
RJ71EN71	
R04ENCPU, R08ENCPU, R16ENCPU, R32ENCPU, R120ENCPU	
QJ71GF11-T2	
LJ71GF11-T2	

*1 Simple motion modules and interface boards compatible with the CC-Link IE Field Network cannot be used. Information on "Applicable master station" described above is the ones at the point when this manual was issued.

For latest information, please visit the website of CC-Link Partner Association.

www.cc-link.org

Ethernet cable

For the specifications of the Ethernet cable, refer to the following.

 User's manual for the master/local module used

IO-Link cable

For details on IO-Link cables, refer to the following.

 Page 35 Wiring with terminal block for module power supply and FG

Available software

The following software is available for settings and diagnostics of the IO-Link module. ( Manuals of each software)

Product name	Functions/applications
GX Works2	Software for system design, programming, debugging, and maintenance of the programmable controller.
GX Works3	
MELSOFT Navigator	Integrated application of GX Works2 and GX Works3.
FDC	Application for DTM.
M_CommDTM-IOLink	
IODD DTM Configurator	

When the latest software is required, please consult your local Mitsubishi representative.

Applicable profile

To use the parameter setting function of an IO-Link module, the profile is required.

The profile is a setting file that stores information required for the start-up, operation, and maintenance of devices supporting the CC-Link family.

A module is added to "Module List" of the "CC IE Field Configuration" window by profile registration to an engineering tool. For the profile registration, refer to the operating manual for the engineering tool used.

Applicable devices

Up to eight IO-Link devices and SIO devices can be connected in combination to the IO-Link module.

The IO-Link mode and SIO mode can be set separately on the channels of the IO-Link module.

Refer to the following for operation modes supported by connected external devices.

Operation mode	Description
Disabled mode	Select this mode when no devices are connected. An error is not detected when a channel in disabled mode is operating.
IO-Link (standard) mode	Select this mode to communicate with IO-Link devices. Process data is sent and received at the following communication speeds. <ul style="list-style-type: none">• COM1: 4.8kbps• COM2: 38.4kbps• COM3: 230.4kbps
IO-Link (sink input) mode	Select this mode to connect a source-type IO-Link device. In addition to IO-Link (standard) mode, digital input is also supported.
SIO (sink input) mode	Select this mode to connect a source-type SIO (input) device. This mode communicates with general devices and supports digital input.
SIO (source output) mode	Select this mode to connect a sink-type SIO (output) device. This mode communicates with general devices and supports digital output.
Power supply mode	Select this mode to supply power to the device of another channel. An error in the power line is only detected when a channel in power supply mode is operating. For setting examples and wiring methods, refer to the following.  Page 42 Using IO-Link devices that require power supplies for their multiple terminals



For error codes and warning codes detectable in each operation mode, refer to the following.

 Page 134 List of error codes and the warning codes

5 INSTALLATION AND WIRING

This section describes the installation and wiring of the IO-Link module.

5.1 Before Using the IO-Link Module

Precautions when using SIO (sink input) mode

■Measures against back EMF

When connecting an inductive load, connect a diode in parallel with the load. Use the diode that satisfies the following conditions:

- A reverse breakdown voltage is ten times as high as the circuit voltage or more.
- A forward current is twice as high as the load current or more.

SIO (sink input)

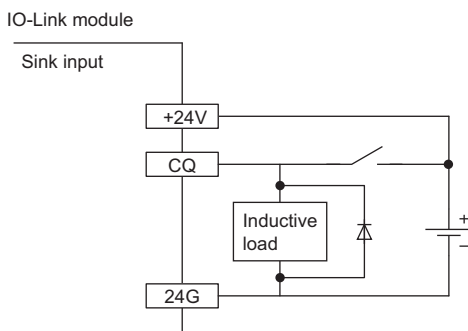

Precautions when using SIO (source output) mode

■Maximum switching frequency when L load is driven

The maximum switching frequency imposes a limit on the use; an ON state or an OFF state must not be changed without an interval of at least one second.

■Load to be connected

When connecting a counter or timer utilizing a DC/DC converter as a load of the IO-Link module, select an IO-Link module whose maximum load current is higher than the inrush current of a load to be connected. If the selection is based on the average current of a load to be connected, an inrush current flows cyclically from the load while the IO-Link module is in an ON state or in operation, which can cause failure of the module. If it is necessary to select a module on the basis of the average current of a load to be connected, to alleviate the effect of the inrush current, take any of the following corrective actions:

- Connecting a resistor in series with the load

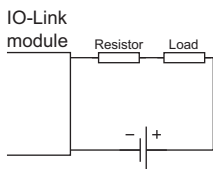

- Connecting an inductor in series with the load

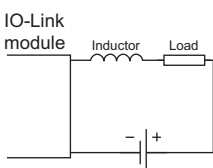

■ Measures against reverse current

In the following connections, a reverse current flows to the output element, which can cause failure.

When wiring, set up diodes as the following figures show:

- When connecting IO-Link modules in parallel

Source type

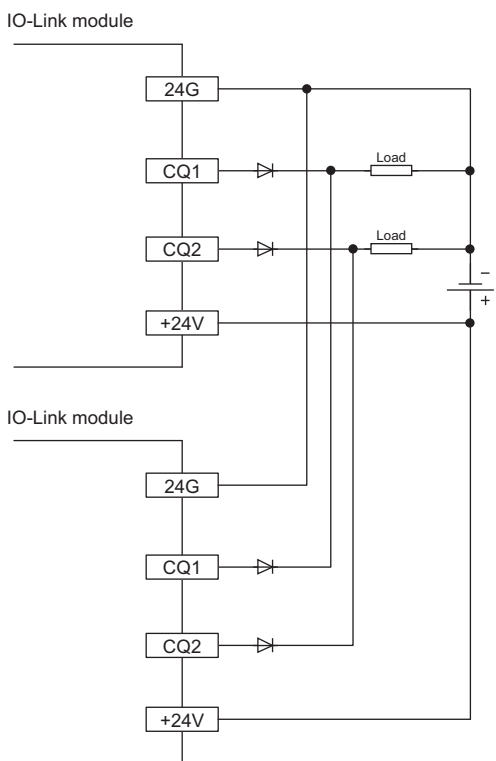

- When providing another circuit in parallel with an IO-Link module

Source type

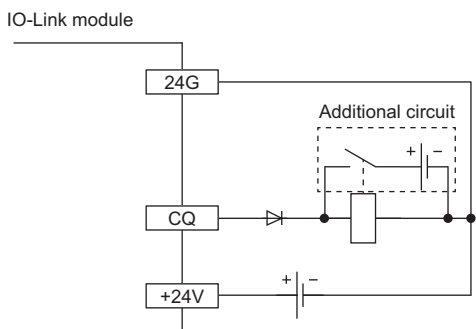

■Measures against back EMF

When connecting an inductive load, connect a diode in parallel with the load.

Use the diode that satisfies the following conditions:

- A reverse breakdown voltage is ten times as high as the circuit voltage or more.
- A forward current is twice as high as the load current or more.

Source type

IO-Link module

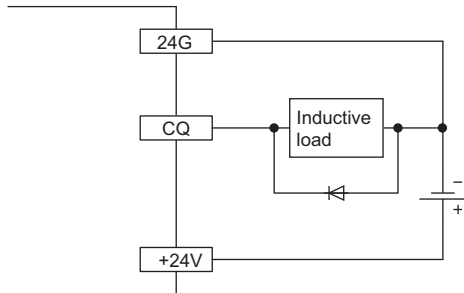

■About element protection of the IO-Link module

If excessive noise affects the terminals of the IO-Link module, the output may be turned on to help the protection of the output element. Adjust the voltage between terminals of the IO-Link module to fall within the operating load voltage range by taking measures such as the following:

- To use an inductive load such as a relay, a surge suppressor is required on the load side as well. Take appropriate measures, referring to the measures against back EMF as a guide.
- To prevent excessive noise, avoid installing power cables together with I/O cables.

5.2 Setting Switch

Setting station number setting switches

Setting procedure

Set the station number using the rotary switches on the front of the IO-Link module. The set value of the station number becomes valid when the module is powered on. Thus, set the station number while the module power is off.

- The hundreds and tens places of the station number are set with $\times 10$.
- The ones place of the station number is set with $\times 1$.

Point

To set the station number setting switches, use a flathead screwdriver with a tip width of 3.5mm or less.

Ex.

To set the station number to 115, set the switches as shown below.

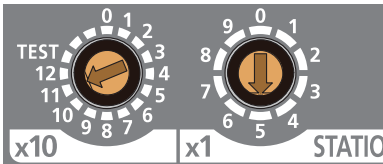

Setting range

Set the station number from 1 to 120. Setting the value other than 1 to 120 causes a communication error and the D LINK LED flashes.

Point

Do not set a station number duplicated with other station numbers. If the station number is duplicated, a communication error occurs and the D LINK LED does not turn on.

Function setting switch setting

Enable or disable the fast link-up function using the function setting switches on the front of the IO-Link module. The setting made by the function setting switches becomes valid when the module is powered on. Thus, set these switches while the module power is off.

For details on the fast link-up function, refer to the following.

☞ Page 91 Fast link-up function

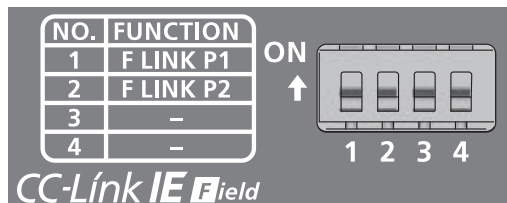

No.	Switch name	Function name	Setting details
1	Function setting switch 1 (F LINK P1)	PORT1 fast link-up function	Enables or disables the fast link-up function of PORT1. • On: Enable • Off: Disable
2	Function setting switch 2 (F LINK P2)	PORT2 fast link-up function	Enables or disables the fast link-up function of PORT2. • On: Enable • Off: Disable
3	—	Use prohibited	Always set to Off.
4	—		

Point

- To set the function setting switches, use a flathead screwdriver with a tip width of 0.9mm or less.
- Do not change the function setting switch while the module is powered on. Changing the function setting switch while the module is powered on causes a minor error and flashes the ERR. LED. Returning the function setting switch to the previous setting eliminates the error and turns off the ERR. LED.

5.3 Installation Environment and Installation Position

Installation environment

Installation location

Do not install the IO-Link module to the place under the following condition.

- Ambient temperature is outside the range from 0 to 55°C;
- Ambient humidity is outside the range from 5 to 95%RH;
- Condensation occurs due to rapid temperature change;
- Corrosive gas or combustible gas is present;
- Conductive powder such as dust and iron powder, oil mist, salinity, or organic solvent is filled;
- The I/O module is exposed to direct sunlight;
- A strong electric field or strong magnetic field is generated; and
- The I/O module is subject to vibration and shock.

Installation surface

Install the IO-Link module on the flat surface. When the installation surface is uneven, excessive force is applied to the printed-circuit board and may cause a defect.

Installation position

When installing the IO-Link module in a control panel, provide clearance of at least 60mm (1) between the IO-Link module and the sides of the control panel or neighboring modules to ensure good ventilation and easy IO-Link module replacement.

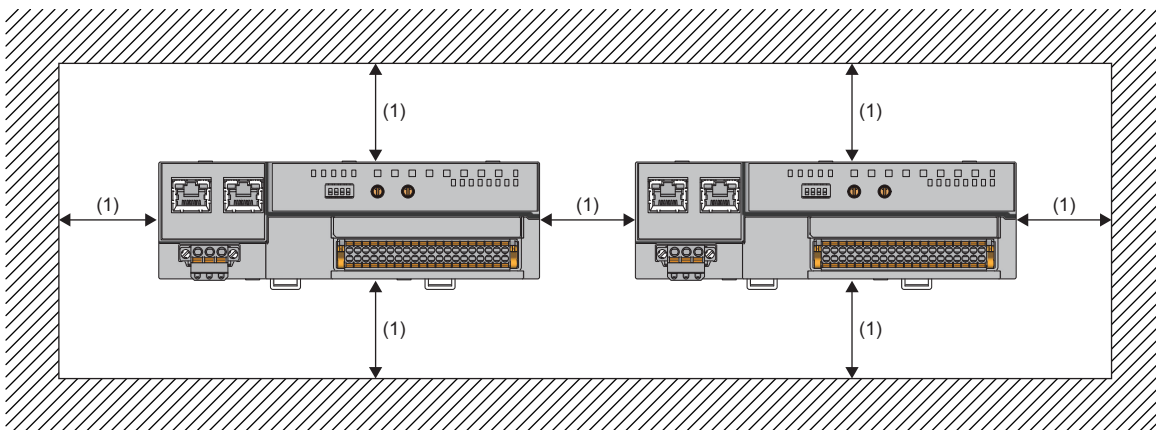

Installation direction

The IO-Link module can be installed in six directions.
Use a DIN rail to install the IO-Link module.

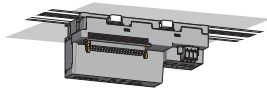

Downward installation

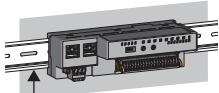

DIN rail

Horizontal installation

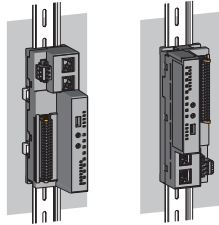

Vertical installation

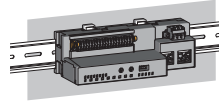

Horizontal installation
(upside down)

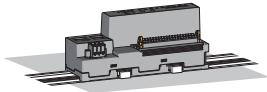

Upward installation

5.4 Installation

Mounting the modules on a DIN rail

Point

An example of the use of the DIN rail stopper is described in the following procedure. Fix the module according to the manual of the DIN rail stopper used.

Mounting procedure

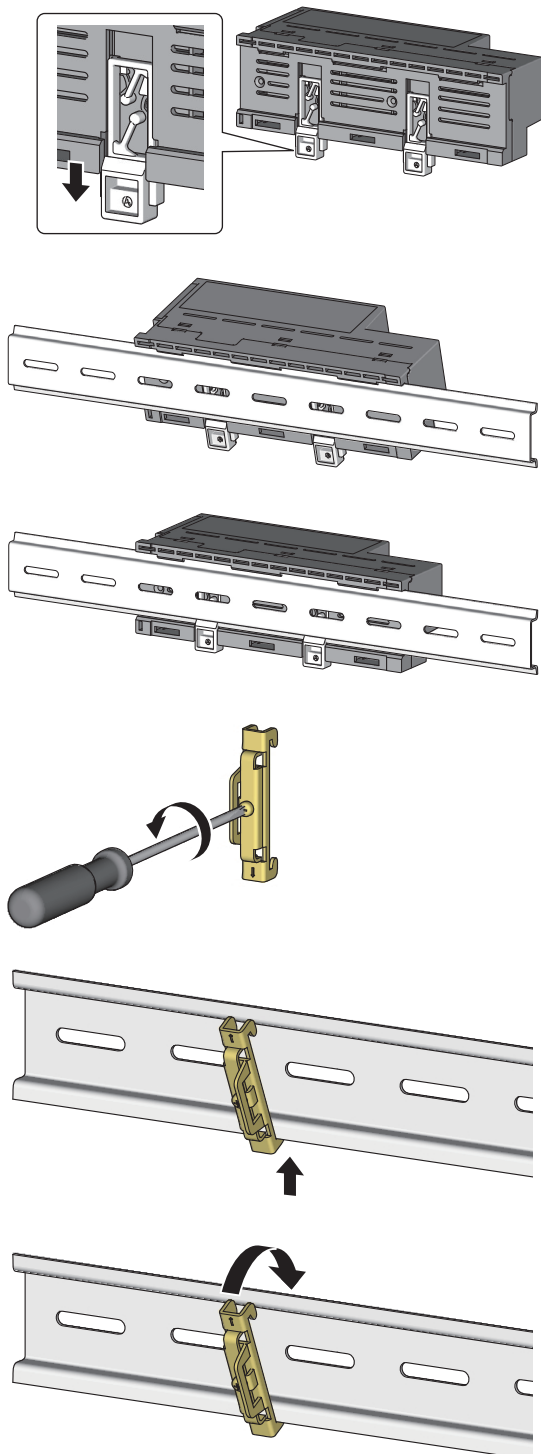

- 1.** Pull down all DIN rail hooks on the back of the modules. The levers should be pulled down until they click.
- 2.** Hang the upper tabs of the modules on a DIN rail, and push the modules in position.
- 3.** Lock the DIN rail hooks to the DIN rail to secure the modules in position. Push each hook up until it clicks. If the hooks are beyond the reach, use a tool such as a driver.
- 4.** Loosen the screw on DIN rail stopper.
- 5.** Hitch the bottom hook of the DIN rail stopper to the bottom of the DIN rail. Hitch the hook according to the orientation of the arrow on the front of the stopper.
- 6.** Hitch the upper hook of the DIN rail stopper to the top of the DIN rail.

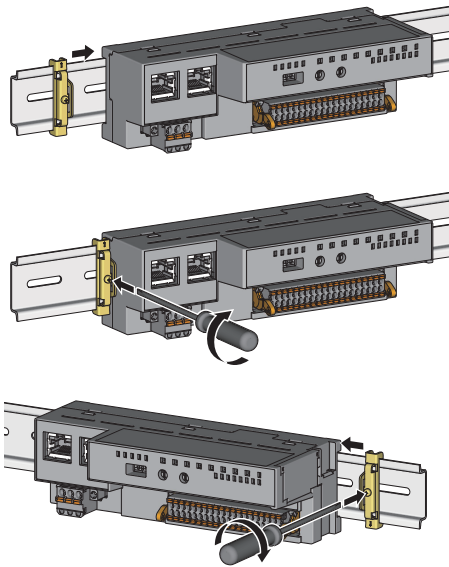

7. Slide the DIN rail stopper up to the left side of the modules.
8. Hold the DIN rail stopper in the direction opposite to the arrow on the stopper and tighten the screw with a driver.
9. Install the DIN rail stopper on the right side of the module in the same procedure.
Install the stopper upside down for the right side.

Point

Do not slide modules from the edge of the DIN rail when mounting them. The modules may be damaged.

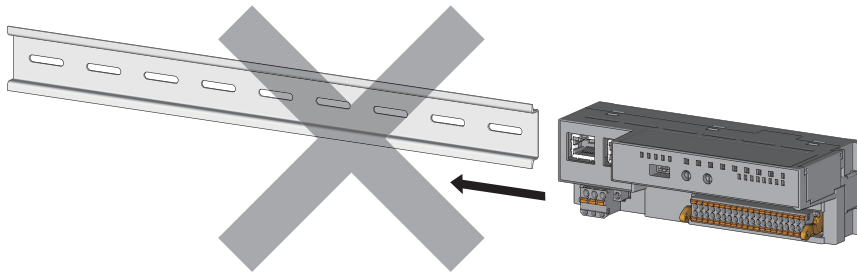

Removal procedure

Remove the modules from the DIN rail by reversing the above procedure.

Applicable DIN rail models (compliant with JIS C 2812/IEC 60715)

- TH35-7.5Fe
- TH35-7.5Al

Interval between DIN rail mounting screws

Tighten the screws at intervals of 200mm or less.

DIN rail stopper

Use a stopper that is attachable to the DIN rail.

5.5 Wiring

Wiring with terminal block for module power supply and FG

Tightening torque

Tighten the terminal block mounting screws within the following specified torque range.

Tightening the screw too much may damage the IO-Link module case.

Screw type	Tightening torque range
Terminal block mounting screw (M2.5 screw)	0.2 to 0.3N·m

Wire to be used

The following describes the wire to be connected to the terminal block for module power supply and FG.

Diameter	Type	Material	Temperature rating
20 to 14 AWG	Core	Copper wire	75°C or more

Applicable solderless terminal

The following table lists the applicable solderless terminal.

Product name	Model	Applicable wire size	Bar solderless terminal tool	Contact
Bar solderless terminal	AI 0.5-8WH, AI 0.5-10WH	0.5mm ²	CRIMPFOX6	PHOENIX CONTACT GmbH & Co. KG
	AI 0.75-8GY, AI 0.75-10GY	0.75mm ²		
	AI 1-8RD, AI 1-10RD	1.0mm ²		
	AI 1.5-8BK, AI 1.5-10BK	1.5mm ²		
	AI 2.5-10BU	2.0mm ²		

Installing and removing the terminal block

To remove the terminal block, loosen the terminal block mounting screw with a flathead screwdriver.

To install the terminal block, tighten the terminal block mounting screw with a flathead screwdriver.

Failure to secure the terminal block may cause drop, short circuit, or malfunction.

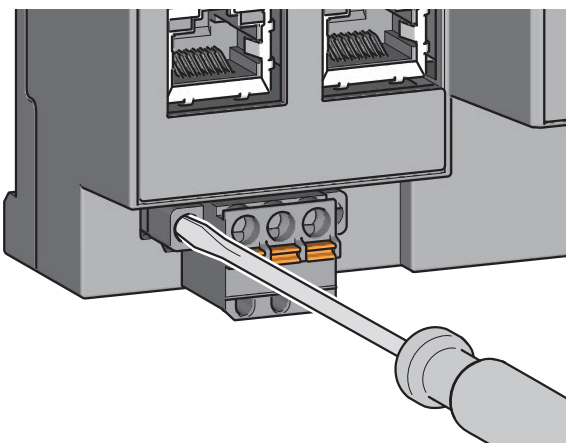

Connecting and disconnecting the cable

To connect the cable, fully insert a wire having a bar solderless terminal into a wire insertion opening. After inserting the wire, pull it lightly to check that it is securely clamped.

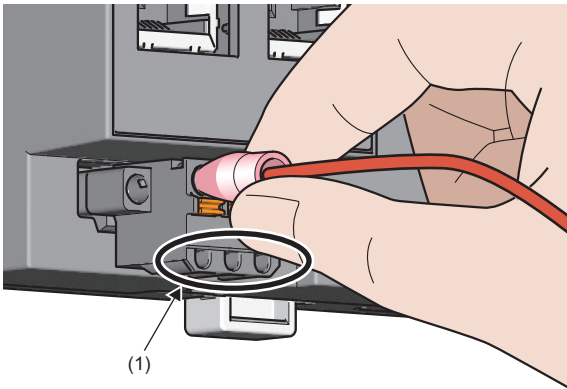

Point

A continuity check can be conducted using a test terminal (1).

To disconnect the cable, push in the open/close button with a flathead screwdriver. With the button pushed in, pull out the wire having a bar solderless terminal.

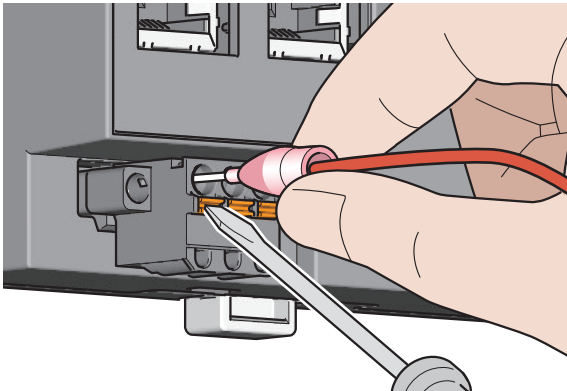

Precautions

- Use a bar solderless terminal for the wiring to the push-in type spring clamp terminal block. If a stripped wire is inserted into a wire insertion opening, the wire cannot be securely clamped.
- For how long the wire should be stripped, follow the specifications of the bar solderless terminal used. To attach a bar solderless terminal to a wire, use a crimping tool.
- Before inserting a bar solderless terminal into a wire insertion opening (1), check the shape of the opening and the shape of the terminal. Insert the terminal paying attention to the orientation. If a bar solderless terminal larger than the wire insertion opening (1) is inserted, the terminal block may be damaged.

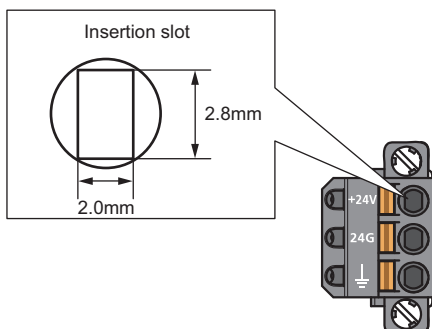

- To comply with the EMC Directive, use a separate power supply for each of the module power supply and the external power supply.

Wiring of Ethernet cable

Wiring method

■ Installation method

1. Turn off the power supplies of the IO-Link module and the external device.
2. Push the Ethernet cable connector into the IO-Link module until it clicks. Pay attention to the direction of the connector.
3. Power on the IO-Link module.
4. Power on the external device.
5. Check if the LINK LED on the port into which the Ethernet cable is connected is on. ^{* 1}

*1 The time taken for the LINK LED to turn on after connection of the cable may vary. The LINK LED normally turns on in a few seconds. However, if link-up processing is repeated due to a condition of a device on the line, the longer time may be required. If the LINK LED does not turn on, refer to the following and take a corrective action.

☞ Page 123 When the LINK LED is off

Point

- When the fast link-up function is not used, PORT1 and PORT2 connectors do not need to be distinguished. When only one connector is used in star topology, either PORT1 or PORT2 can be connected. For how to connect Ethernet cables for using the fast link-up function, refer to the following.

☞ Page 91 Fast link-up function

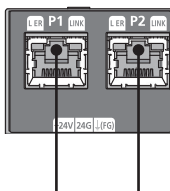

Either one can be used.

- When two connectors are used in line topology or ring topology, an Ethernet cable can be connected to the connectors in any combination. For example, the cable can be connected between PORT1s and between PORT1 and PORT2.

Connection between PORT1s or PORT2s

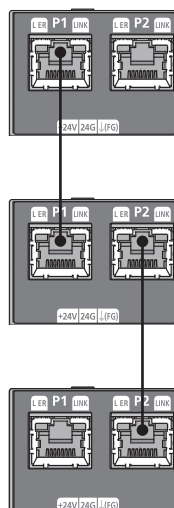

Connection between PORT1 and PORT2

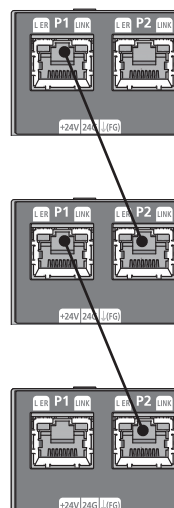

■ How to disconnect

1. Turn off the power supply of the IO-Link module.
2. Press the latch down and unplug the Ethernet cable.

Precautions

■Laying Ethernet cables

- Place the Ethernet cable in a duct or clamp them. If not, dangling cable may swing or inadvertently be pulled, resulting in damage to the module or cables or malfunction due to poor contact.
- Do not touch the core of the connector of the cable or the module, and protect it from dirt and dust. If any oil from your hand, or any dirt or dust sticks to the core, it can increase transmission loss, causing data link to fail.
- Regarding the Ethernet cable to be used, check that the Ethernet cable has no disconnections or short circuits, or problems in the connection of the connector.

■Broken cable latch

Do not use Ethernet cables with broken latches. Doing so may cause the cable to unplug or malfunction.

■Connecting and disconnecting the Ethernet cable

Hold the connector part when connecting and disconnecting the Ethernet cable. Pulling the cable connected to the module may result in damage to the module or cable or malfunction due to poor contact.

■Connectors without Ethernet cable

To prevent dust from entering the module, attach the provided connector cover.

■Maximum station-to-station distance (Maximum Ethernet cable length)

The maximum station-to-station distance is 100m. However, the distance may be shorter depending on the operating environment of the cable. For details, contact the manufacturer of the cables used.

■Bending radius of the Ethernet cable

There are restrictions on the bending radius of the Ethernet cable. Check the bending radius in the specifications of the Ethernet cables used.

Wiring of IO-Link terminal block and external devices

Wire to be used

The following describes the wire to be connected to the IO-Link terminal block.

Diameter*1	Type	Material	Temperature rating
■For +24V/24G/FG 20 to 16 AWG ■For CQ/L+/L-/DI 24 to 16 AWG	Core	Copper wire	75°C or more

*1 Use cables suitable for the current value used.

Applicable solderless terminal

The following table lists the applicable solderless terminal.

Product name	Model	Applicable wire size	Bar solderless terminal tool	Contact
Bar solderless terminal	AI 0.34-8TQ	0.2mm ²	CRIMPFOX6	PHOENIX CONTACT GmbH & Co. KG
	A 0.5-10, AI 0.5-10WH	0.5mm ²		
	A 0.75-10, AI 0.75-10GY	0.75mm ²		
	A 1-10	1.0mm ²		
	A 1.5-10	1.5mm ²		

Installing and removing the terminal block

The following procedures show how to install and remove the terminal block.

■Lock and release lever positions

To make it easy to install and remove the terminal block, a three-stage positioning stopper is attached so that the lever does not freely turn around.

When installing or removing the terminal block, turn the lever to the lock or release lever position.

Figure viewed from the module right surface: When pulling the terminal block

1. Release lever position

This lever position shows the state in which the terminal block (1) has been completely pulled out from the module. Turn the lever from the locking position to the release position (2) to lift the terminal block from the IO-Link module.

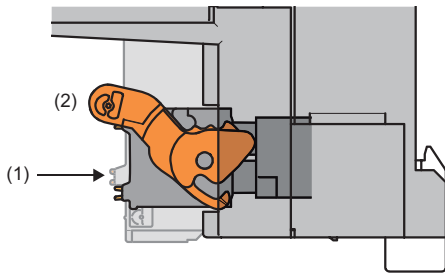
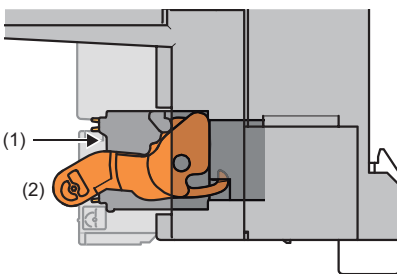

Figure viewed from the module right surface: When insertion of the terminal block has completed

2. Lock lever position

This position shows the state in which the terminal block (1) completely fits the module.

Check the lock lever position (2) and pull the terminal block lightly to confirm that the module completely fits the terminal block.



■Removal procedure

Turn the lever to the release lever position and remove the terminal block from the module.

■Installation procedure

Move the lever to the locking lever position and push the terminal block. If the terminal block is fully pushed in, the hook of the lever hangs on the module and fits the terminal block.

Point

The terminal block can be inserted with the lever locations other than the lock lever position.
After insertion, check that the lever is in the lock lever position.

Connecting and disconnecting the cable

■Connecting the cable

Insert wire in which the tip thereof has been processed into a wire insertion opening (2) and push it to the back.

If the wire cannot be inserted by this method, insert the wire completely while holding down the release button (1) using a flathead screwdriver with a tip width of 2.0 to 2.5mm. Once the wire is inserted to the back, remove the screwdriver.

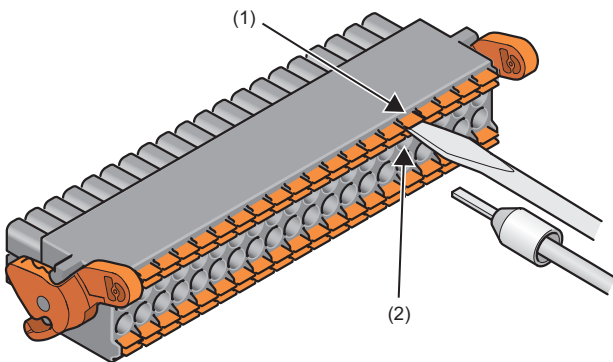

■Disconnecting the cable

Pull out the wire while holding down the release button using a flathead screwdriver with a tip width of 2.0 to 2.5mm.

■Precautions

- Use a crimping tool to connect a bar solderless terminal to a wire. (☞ Page 39 Applicable solderless terminal)
- The maximum station-to-station distance of IO-Link cables is 20m. However, the distance may be shorter depending on the operating environment of the cables. For details, contact the manufacturer of the cables used.
- When inserting a bar solderless terminal, check that the size of the terminal and its insertion direction are correct to prevent the terminal from getting stuck in or the terminal block damage. When using a bar solderless terminal other than the applicable solderless terminals, check that the cross-sectional shape of the terminal after processing (the size includes an error in processing) is smaller than the size mentioned below. For the correct terminal insertion direction, refer to the figure below.

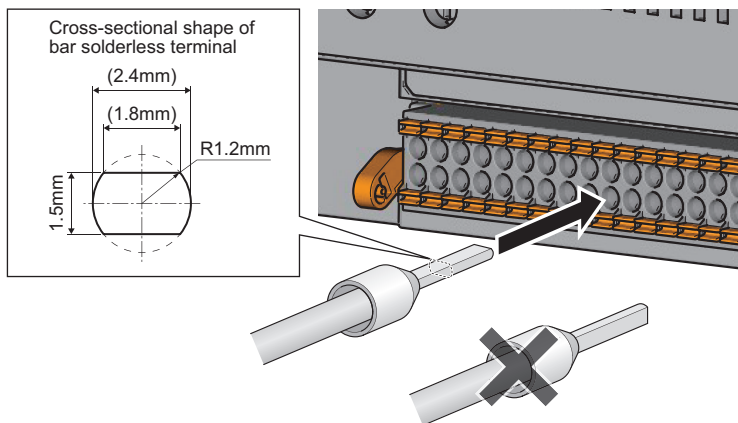

For details on the finish shape of a bar solderless terminal including an error in processing, contact the manufacturers of the bar solderless terminal and the crimping tool.

Signal names of the terminal block

The following table shows signal names of the terminal block.

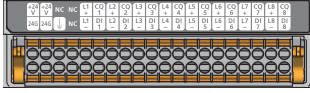

IN		OUT		FG		CH1		CH2		CH3		CH4		CH5		CH6		CH7		CH8	
+24V	+24V	NC	NC	L1+	CQ1	L2+	CQ2	L3+	CQ3	L4+	CQ4	L5+	CQ5	L6+	CQ6	L7+	CQ7	L8+	CQ8		
24G	24G	FG	NC	L1-	DI1	L2-	DI2	L3-	DI3	L4-	DI4	L5-	DI5	L6-	DI6	L7-	DI7	L8-	DI8		

Wiring to the terminal block

The following figures show wiring to the terminal block.

IO-Link (standard) mode wiring

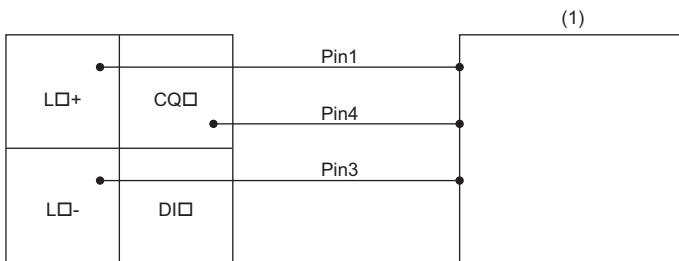

(1) IO-Link device (IO-Link sensor)

□ 1 to 8

Pin 1: Brown

Pin 3: Blue

Pin 4: Black

IO-Link (sink input) mode wiring

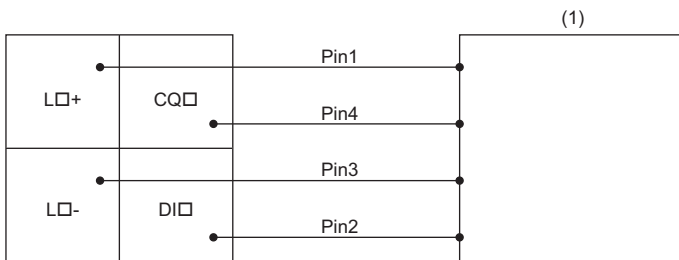

(1) IO-Link device (IO-Link sensor (DI support))

□ 1 to 8

Pin 1: Brown

Pin 2: White

Pin 3: Blue

Pin 4: Black

SIO (sink input) mode wiring

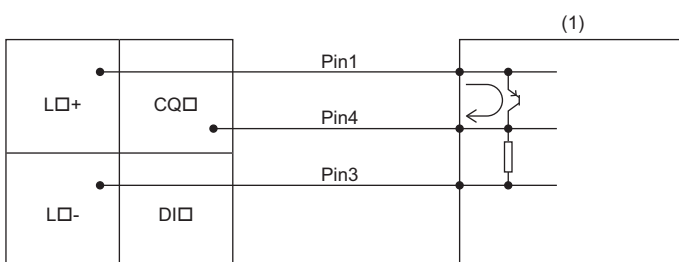

(1) SIO input device (SIO mode 3-wire sensor (PNP))

□ 1 to 8

■SIO (source output) mode wiring

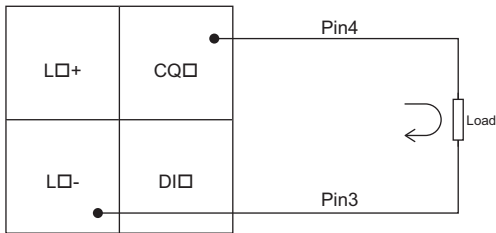

□ 1 to 8

■Using IO-Link devices that require power supplies for their multiple terminals

Some models of IO-Link device require power supplies for their multiple terminals.

Ex.

Using IO-Link devices that require power supplies for two terminals

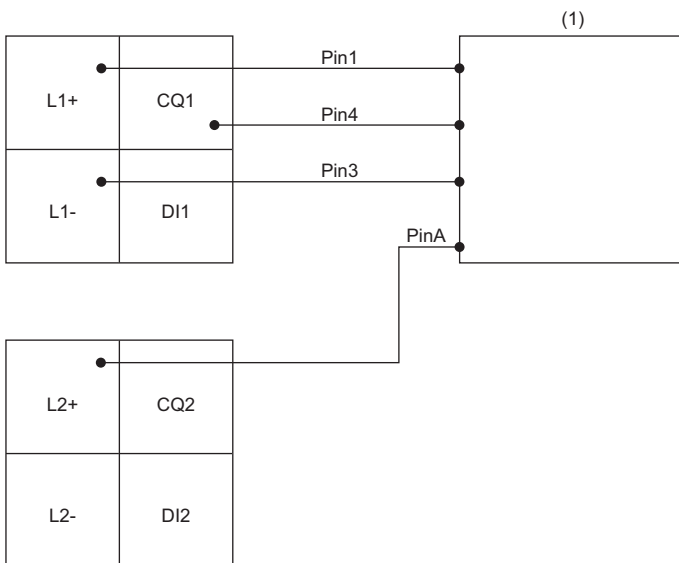

(1) IO-Link device

Pin 1: L+ (1st 24VDC)

Pin A: L+ (2nd 24VDC)

L+ of CH2 supplies power to Pin A.

Operation modes at this times are as follows.

- CH1: IO-Link (standard) mode
- CH2: Power supply mode

6 PARAMETER SETTING

This chapter describes the procedure for setting parameters of the IO-Link module.

6.1 CC-Link IE Field Network Parameter Setting

Set the parameter of the IO-Link module with the network parameter written to the CPU module of the CC-Link IE Field Network master station. For details on setting the CC-Link IE Field Network master station, refer to the following.

User's manual for the master/local module used

Operating procedure

1. Open the "CC IE Field Configuration" window.
 [Navigation window] ⇒ [Parameter] ⇒ [Module Information] ⇒ [RJ71GF11-T2] ⇒ [Basic Settings] ⇒ [Network Configuration Settings]
2. Select an IO-Link module from "Module List", and drag and drop it to the list of stations or the network map.

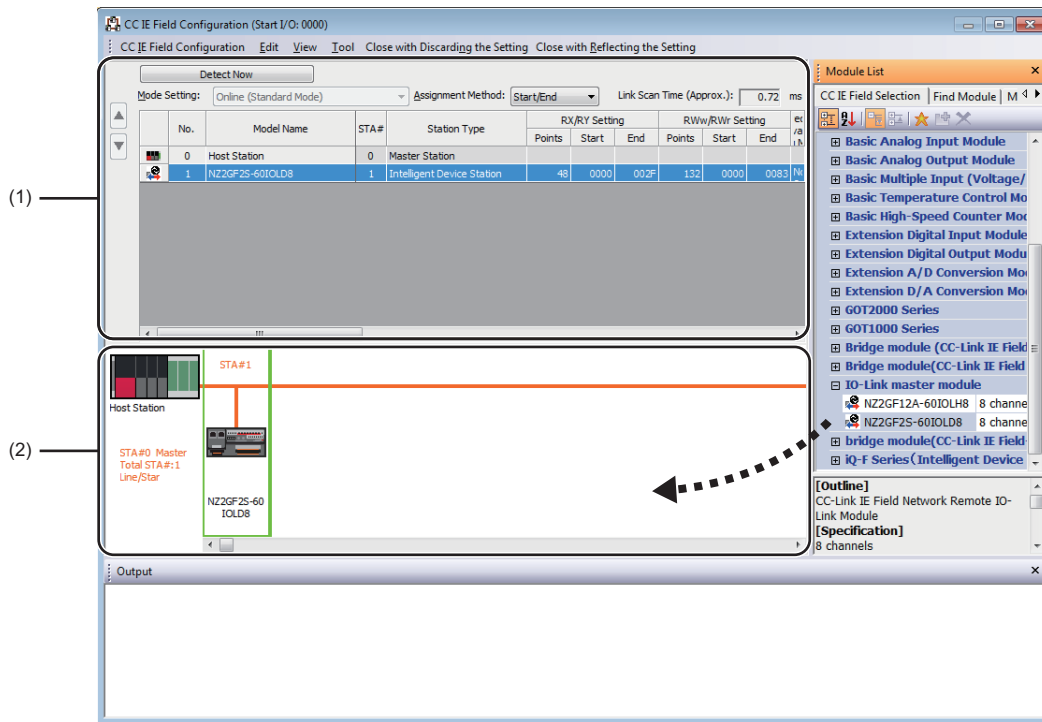

- (1) List of stations
 (2) Network map

3. Configure the IO-Link module settings.

Item	Description
STA#	Set the station number of a device station to be connected to the network. The station number need not be a serial number. (Must not be overlapped.)
Station Type	Automatically set to "Intelligent Device Station".
RX/Ry Setting	Set RX and Ry assignment. Automatically set to 48 points for the IO-Link module.
RWw/RWr Setting	Set RWw and RWr assignments. Automatically set to 132 points for the IO-Link module.
Reserved/Error Invalid Station/System Switching Monitoring Target Station	Use this to set the device station as an error invalid station or a switching monitoring target station.

4. Close the "CC IE Field Configuration" window.
 [CC IE Field Configuration] ⇒ [Close with Reflecting the Setting]

Precautions

■ Precautions before parameter settings

For the precautions before parameter settings, refer to the following.

📖 GX Works3 Operating Manual

📖 GX Works2 Version 1 Operating Manual (Common)

■ Precautions for parameter settings

- When using the IO-Link module, always enable the station-based block data assurance. When it is disabled, correct operation of the IO-Link module cannot be guaranteed. For details on the block data assurance per station, refer to the following: User's manual for the master/local module used.

Item	Setting
▣ Supplementary Cyclic Settings	
System Switching Monitoring Time	2000 ms
▣ Link Scan Mode	Sequence Scan Asynchronous
Constant Link Scan Time	0 ms
<i>Station-based Block Data Assurance</i>	Enable
▣ I/O Maintenance Settings	

- Do not set the parameter using the CCPASET instruction in the master station. Correct operation of the IO-Link module cannot be guaranteed because the module operates with the station-based block data assurance disabled when the CCPASET instruction is executed. (The CCPASET instruction is intended to configure parameters for a master/local module. For details on the CCPASET instruction, refer to the user's manual for the master/local module used.)

6.2 IO-Link Module Parameter Setting

This section describes the procedure for setting parameters of IO-Link module via the engineering tool.

Operating procedure

1. Open the "CC IE Field Configuration" window.
 - [Navigation window] ⇒ [Parameter] ⇒ [Module Information] ⇒ [RJ71GF11-T2] ⇒ [Basic Settings] ⇒ [Network Configuration Settings]
2. Open the "Parameter Processing of Device Station" window.
 - From the list of stations, select an IO-Link module ⇒ [CC IE Field Configuration] ⇒ [Online] ⇒ [Parameter Processing of Device Station].
3. Set "Method selection" to "Write Parameters".

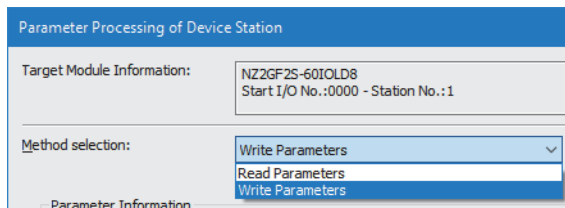

4. Double-click the item to change the setting, and input the setting value.

Item	Setting method
Items to input from the pull-down list	Double-click the item to set, to display the pull-down list. Select the item.
Items to input from the text box	Double-click the item to set, and input the setting value.

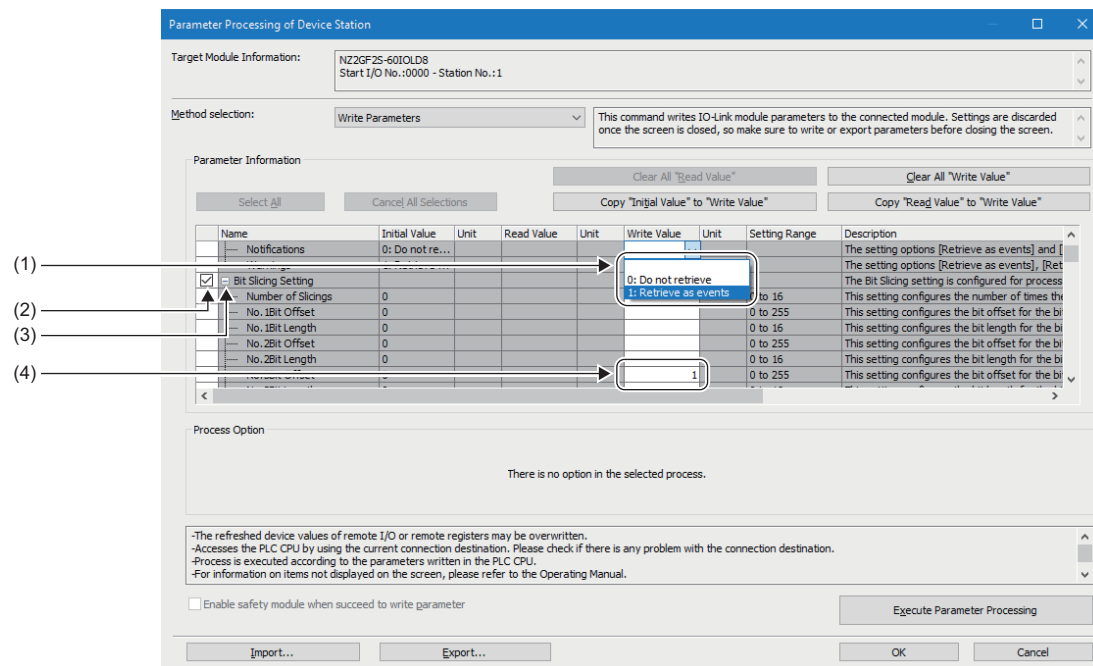

- (1) Items to input from the drop-down list
- (2) Checkbox
- (3) The list cannot be collapsed.
- (4) Items to input from the text box

5. Click the [Execute Parameter Processing] button, and the following window is displayed.

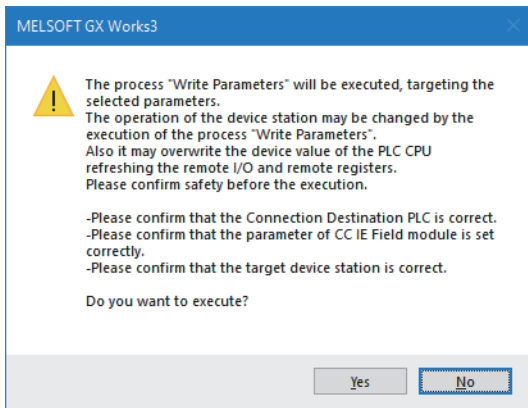

6. Click the [Yes] button.

7. The parameters are written to the IO-Link module.

8. Select [Close with Reflecting the Setting] to exit the network configuration setting.

Point

- To read the parameter from the IO-Link module, set "Method selection" to "Read Parameters" and click the [Execute Parameter Processing] button.
- Set all the items for the parameter. If any blank exists, the parameters cannot be written to the IO-Link module.

Displayed items

Setting item		Reference	
Individual Station Parameters	Input Response Time Setting	Page 85 Input response time setting function	
	Output HOLD/CLEAR Setting	Page 94 Output HOLD/CLEAR setting function	
Individual Module Parameters CH1	Operation Mode	Page 25 Applicable devices	
	Device Validation Setting	Page 70 IO-Link device validation function	
	Input OFF Delay Setting	Page 83 Input OFF delay function	
	Input Data Mask	Page 74 Input data masking function	
	Byte Position Swap	Page 76 Swap function	
	Event Retrieval Setting	Notifications	Page 96 Event Acquisition Function
		Warnings	
	Bit Slicing Setting	Number of Slicings	Page 78 Bit segment function
		No.1Bit Offset	
		No.1Bit Length	
No.2Bit Offset			
No.2Bit Length			
⋮			
No.15Bit Offset			
No.15Bit Length			
No.16Bit Offset			
No.16Bit Length			
Individual Module Parameters CH2	Same as Individual Module Parameters CH1	—	
Individual Module Parameters CH3			
⋮			
Individual Module Parameters CH7			
Individual Module Parameters CH8			

Precautions

When the following message is displayed, take corrective action for the error code in < >.

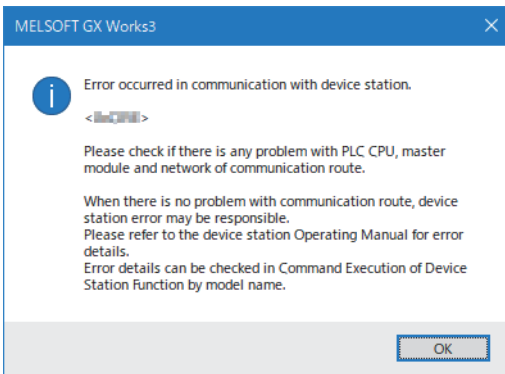

For details on the error code, refer to the following.

 Page 134 List of error codes and the warning codes

 User's manual for the master/local module used

6.3 Changing the IO-Link Module Parameters

This section describes the procedure for changing the parameter.

The precautions for changing the parameter are the same as those in the following section.

☞ Page 43 CC-Link IE Field Network Parameter Setting

Changing the network configuration

When changing the network configuration diverting the created project, set the parameter in the following procedure.

Operating procedure

1. Power off the module.
2. Connect the modules again according to the desired network configuration.
3. Power on the module.
4. Open the "CC IE Field Configuration" window.
 - ☞ [Navigation window] ⇒ [Parameter] ⇒ [Module Information] ⇒ [RJ71GF11-T2] ⇒ [Basic Settings] ⇒ [Network Configuration Settings]
5. Drag and drop a module to set the IO-Link module. Input a numerical value to set the station number of the station. Change the value as necessary.

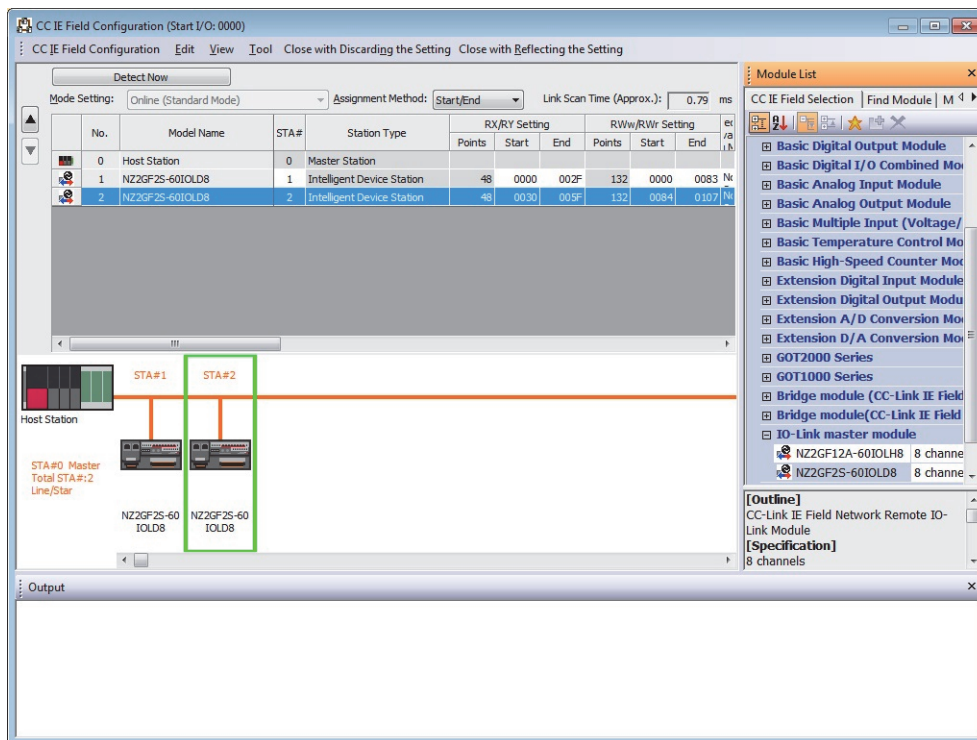

6. Open the "Parameter Processing of Device Station" window.
 - ☞ From the list of stations, select an IO-Link module ⇒ [CC IE Field Configuration] ⇒ [Online] ⇒ [Parameter Processing of Device Station].

7. Set "Method selection" to "Read Parameters".

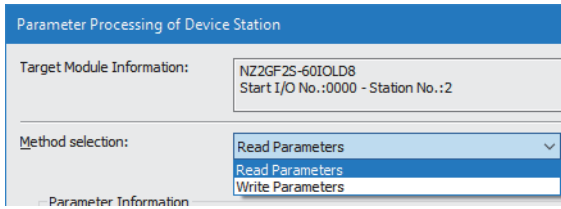

8. Click the [Execute Parameter Processing] button, and the following window is displayed.

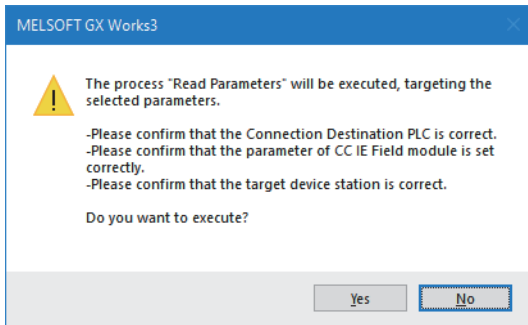

9. Click the [Yes] button.

10. The parameters are read from the IO-Link module.

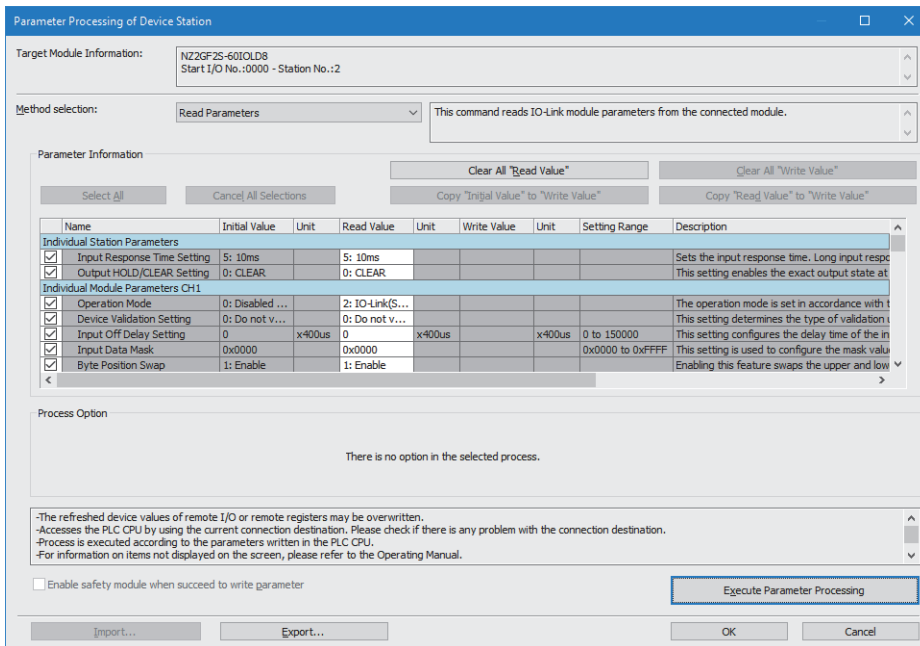

11. Set "Method selection" to "Write Parameters".

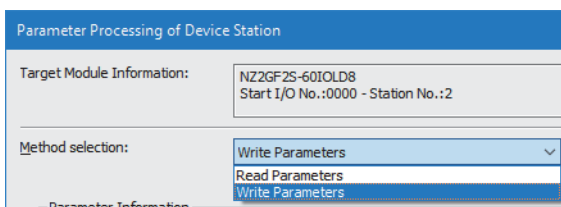

12. Set "Write Value". The following are the procedure.

- Click the title cell of "Read Value" to select all the items and copy them.
- Click the title cell of "Write Value" to select all the items and paste the copy.
- Select the items to be changed, and set new values.

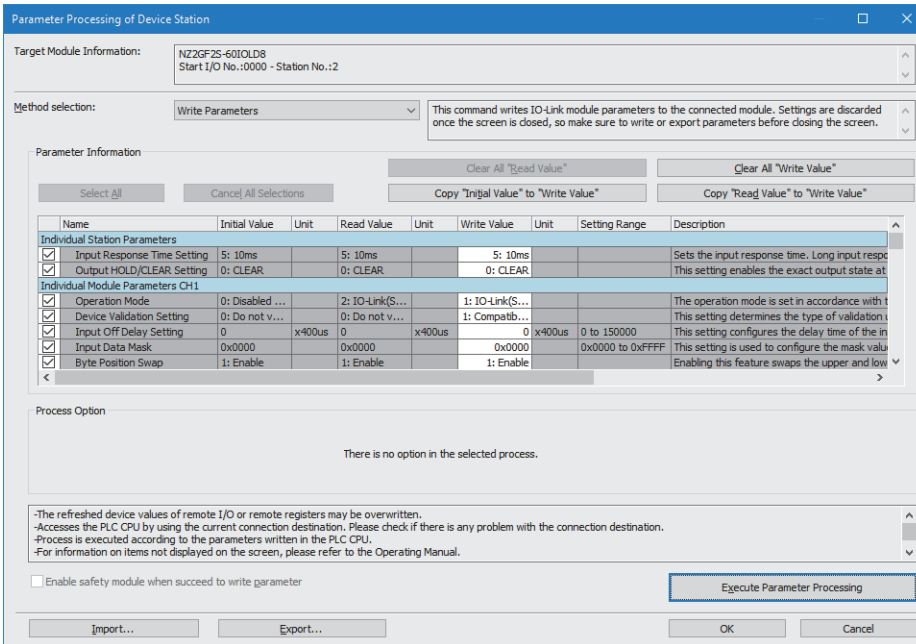

13. Click the [Execute Parameter Processing] button, and the following window is displayed.

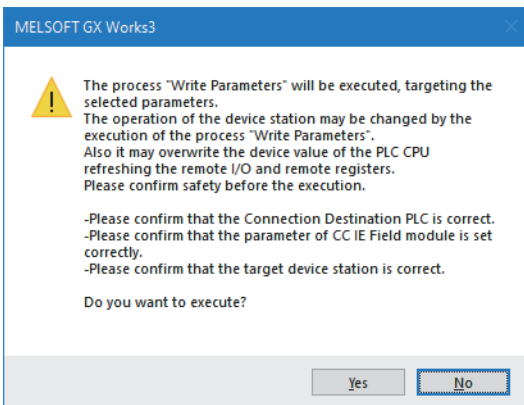

14. Click the [Yes] button.

15. The parameters are written to the IO-Link module. Click the [OK] button.

16. Close the "CC IE Field Configuration" window.

[CC IE Field Configuration] ⇒ [Close with Reflecting the Setting]

17. Set the refresh parameter. Change the value as necessary.

[Navigation window] ⇒ [Parameter] ⇒ [Module Information] ⇒ [RJ71GF11-T2] ⇒ [Basic Settings] ⇒ [Refresh Settings]

No.	Link Side					CPU Side				
	Device Name	Points	Start	End		Target	Device Name	Points	Start	End
-	SB	512	00000	001FF	↔	Module Label				
-	SW	512	00000	001FF	↔	Module Label				
1	RX	48	00000	0002F	↔	Specify Device	X	48	01000	0102F
2	RY	48	00000	0002F	↔	Specify Device	Y	48	01000	0102F
3	RWr	132	00000	00083	↔	Specify Device	W	132	00100	00183
4	RWw	132	00000	00083	↔	Specify Device	W	132	00300	00383

18. Click the [Apply] button.

19. Write the set parameters to the CPU module of the master station and reset the CPU module.

20. Change the status of the CPU module of the master station to RUN.

The network configuration setting is now completed.

Changing the parameter without changing the network configuration

To change only the created module parameter of the device station without changing the network configuration, set the parameter in the following procedure.

Operating procedure

1. Open the "CC IE Field Configuration" window.
 - [Navigation window] ⇒ [Parameter] ⇒ [Module Information] ⇒ [RJ71GF11-T2] ⇒ [Basic Settings] ⇒ [Network Configuration Settings]
2. Open the "Parameter Processing of Device Station" window.
 - From the list of stations, select an IO-Link module ⇒ [CC IE Field Configuration] ⇒ [Online] ⇒ [Parameter Processing of Device Station].
3. Set "Method selection" to "Read Parameters".

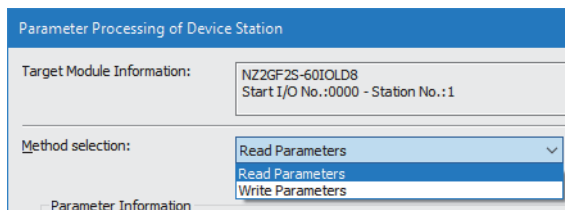

4. Click the [Execute Parameter Processing] button, and the following window is displayed.

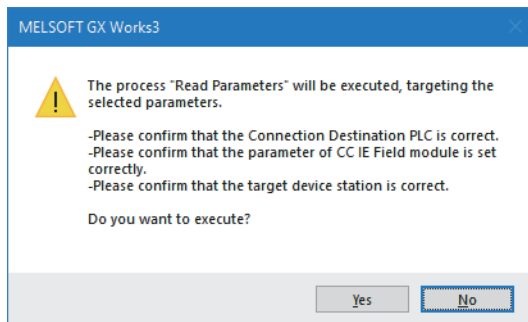

5. Click the [Yes] button.
6. The parameters are read from the IO-Link module.

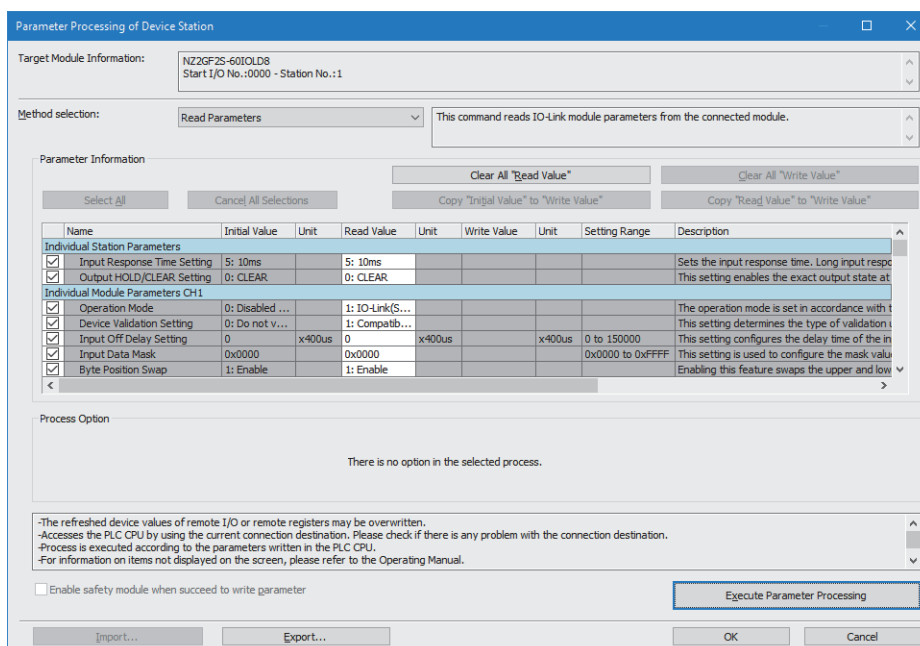

7. Set "Method selection" to "Write Parameters".

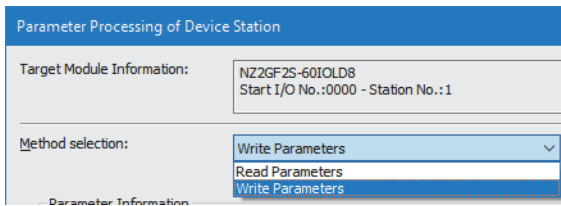

8. Set "Write Value". The following are the procedure.

- Click the title cell of "Read Value" to select all the items and copy them.
- Click the title cell of "Write Value" to select all the items and paste the copy.
- Select the items to be changed, and set new values.

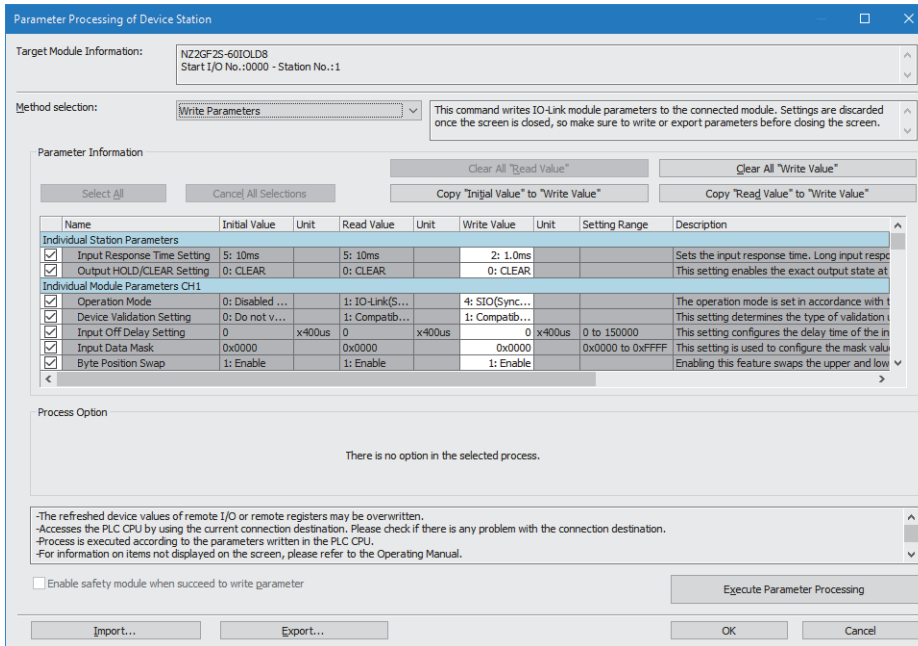

9. Click the [Execute Parameter Processing] button, and the following window is displayed.

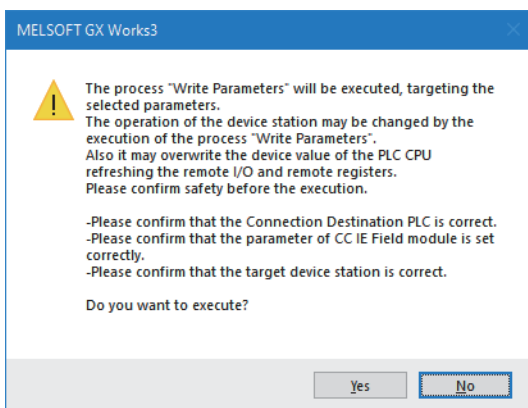

10. Click the [Yes] button.

11. The parameters are written to the IO-Link module.

The module parameter setting of the device station is completed.

6.4 IO-Link Device Parameter Setting

Using CommDTM for IO-Link in FDC, IO-Link device parameters can be read or written and data can be monitored via the IO-Link module. In addition, multiple IO-Link devices can be managed from one place. IODD can be converted to Device DTM using IODD DTM Configurator. IODD is supplied from the sensor manufacturer.

For the CommDTM for IO-Link installation procedure, refer to the following.

 Installation procedure for CommDTM/IODD DTM Configurator for IO-Link

Setting procedure when FDC and CommDTM are used

The following describes how to set the IO-Link device parameter.

Setting procedure

1. Install IODD using the installer supplied from the manufacturer of the sensor. Convert IODD supplied from the sensor manufacturer to Device DTM using IODD DTM Configurator. When Device DTM is supplied from the sensor manufacturer, this operation is not necessary.

 Page 57 Conversion procedure of IODD

2. When GX Works3 is used, double-click the IO-Link module in the network map in GX Works3 after installing Device DTM. When GX Works2 is used, start FDC directly.

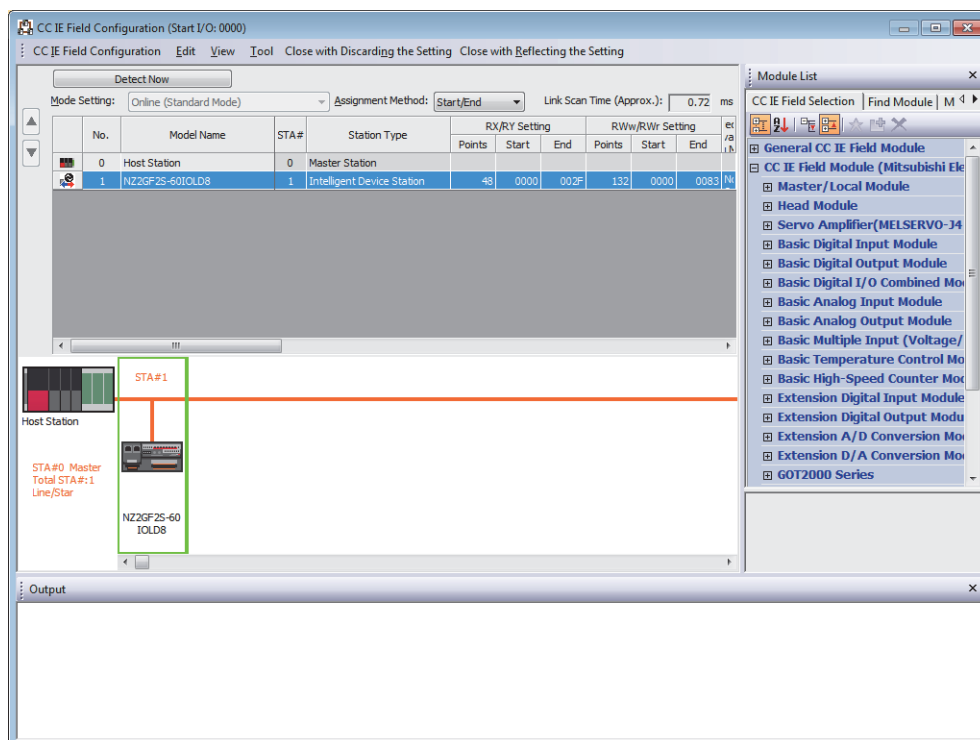

3. Register M_CommDTM-IOLink and Device DTM to the DTM catalog of FDC. This registration is necessary only for the first startup. It will not be necessary for the next and subsequent startups.

4. Click the [Update] button to start the update of the DTM catalog.

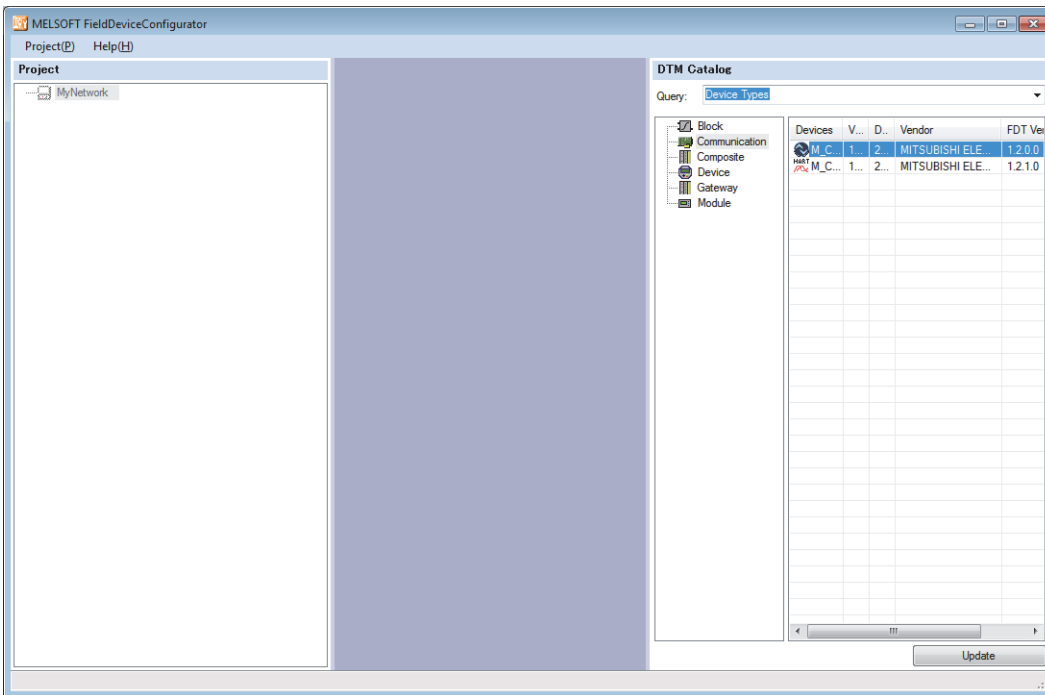

5. Create an FDC project.

☞ Page 59 Creation procedure

6. Add M_CommDTM-IOLink to the created FDC project.

Import the communication setting of M_CommDTM-IOLink from GX Works3.

☞ Page 60 Procedure for adding M_CommDTM-IOLink

☞ Page 61 Procedure for configuring communication setting with M_CommDTM-IOLink

7. The connected IO-Link device is automatically detected.

☞ [M_CommDTM-IOLink] ⇒ Right-click ⇒ [Detect Now] ⇒ [Execute to All Channels] or [Execute to Selected Channels]

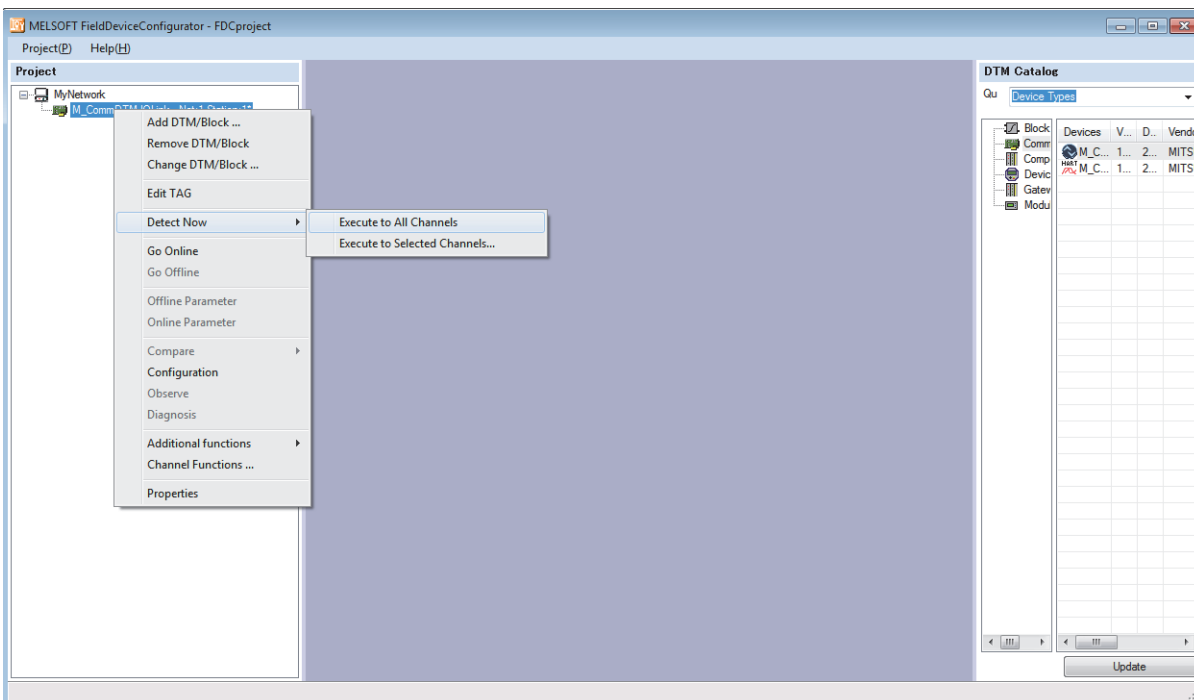

8. IO-Link device is detected.

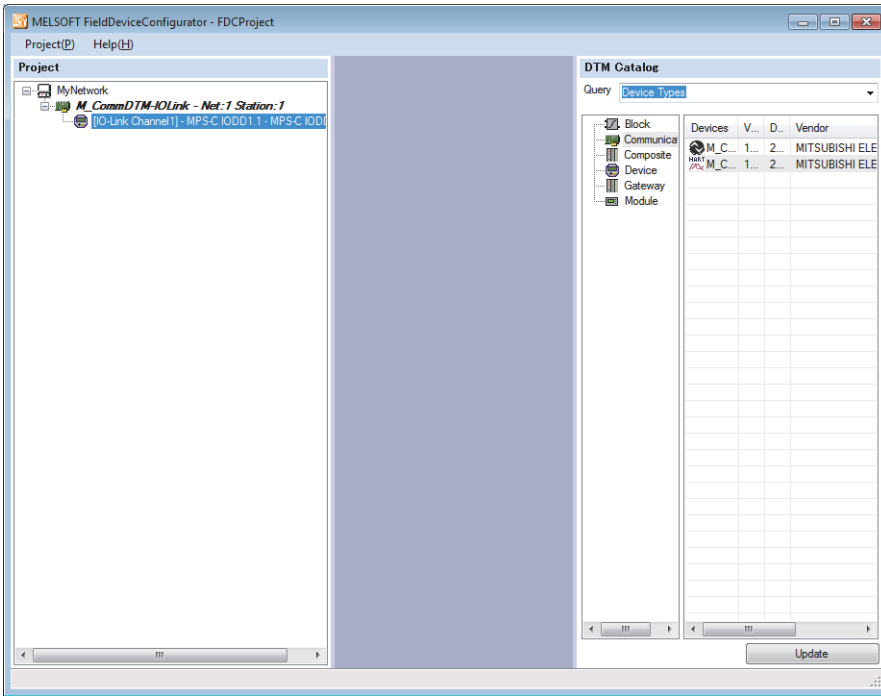

9. Write the parameter of the connected IO-Link device.

☞ Page 63 Procedure for setting the IO-Link device parameter

Conversion procedure of IODD

The following describes how to convert IODD.

Conversion procedure

1. Start IODD DTM Configurator. Device DTM already converted to IODD is listed on the window.

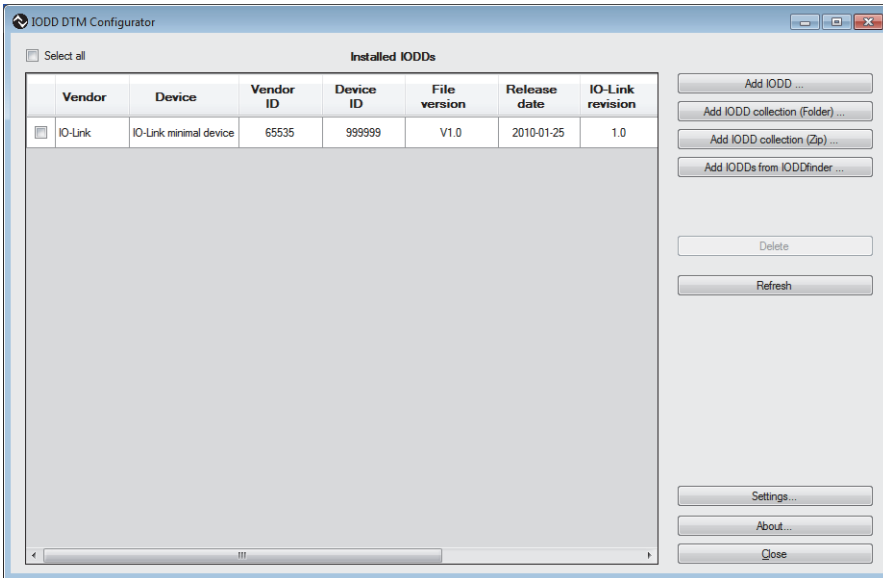

2. Click the [Add IODD ...] button.
3. Select the XML file of IODD to be read, and click the [Open] button.

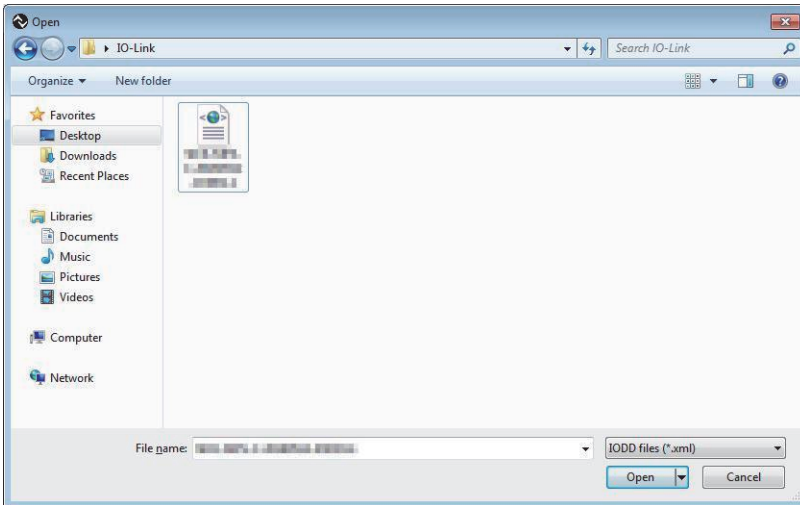

4. Check that IO-Link is added properly and click the [Close] button to exit.

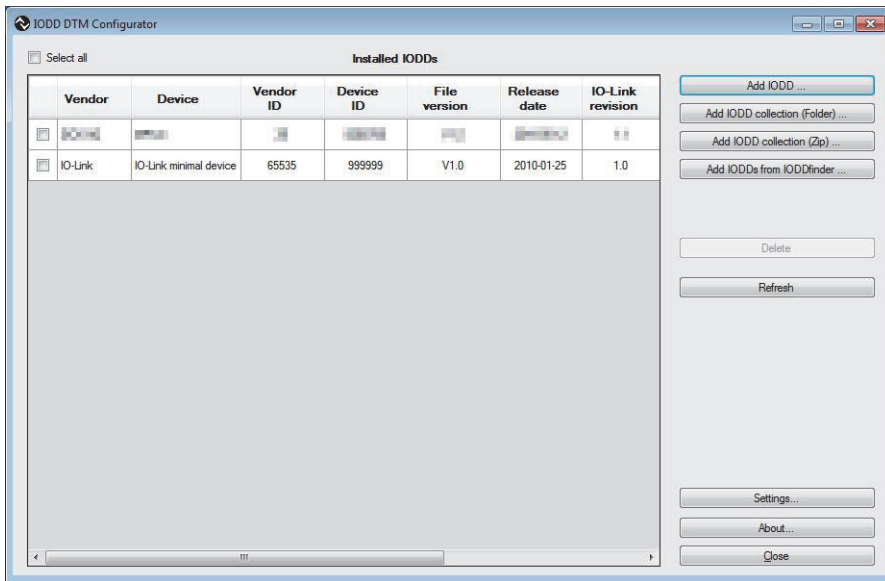

Creation procedure of FDC project

The following describes how to create an FDC project.

Creation procedure

1. Open the "New Project" window from the menu.

 [Project] ⇒ [New]

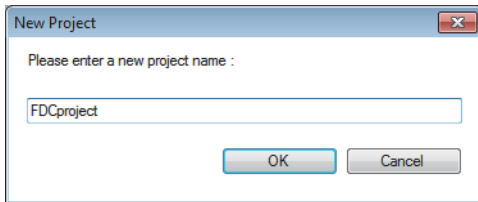

2. Enter the FDC project name, and click the [OK] button.

Procedure for adding M_CommDTM-IOLink

The following describes how to add M_CommDTM-IOLink.

Addition procedure

1. Select M_CommDTM-IOLink from the DTM catalog, and click the [OK] button.

FDC project tree ⇒ [MyNetwork] ⇒ Right-click ⇒ [Add DTM]

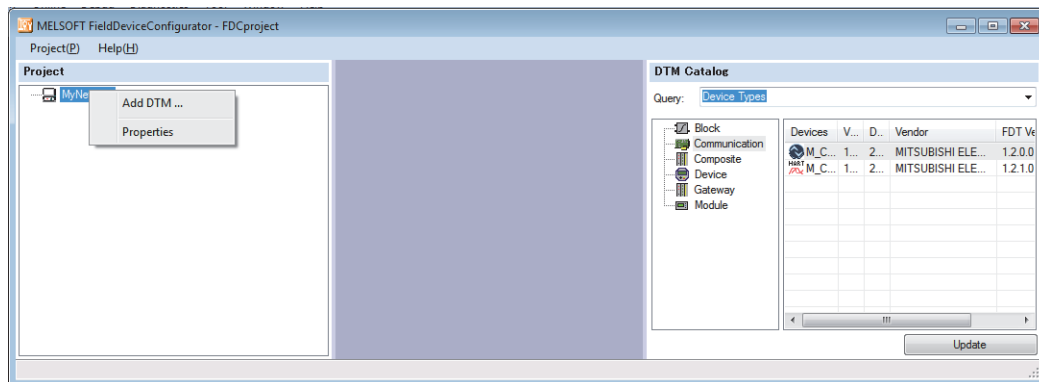

2. M_CommDTM-IOLink is added to the FDC project.

Procedure for configuring communication setting with M_CommDTM-IOLink

The following describes how to import the communication setting of M_CommDTM-IOLink from GX Works3.

Communication setting procedure

1. Import the communication setting of M_CommDTM-IOLink from the connection destination specification and the network configuration setting information of GX Works3. Double-click M_CommDTM-IOLink to display the M_CommDTM-IOLink window.

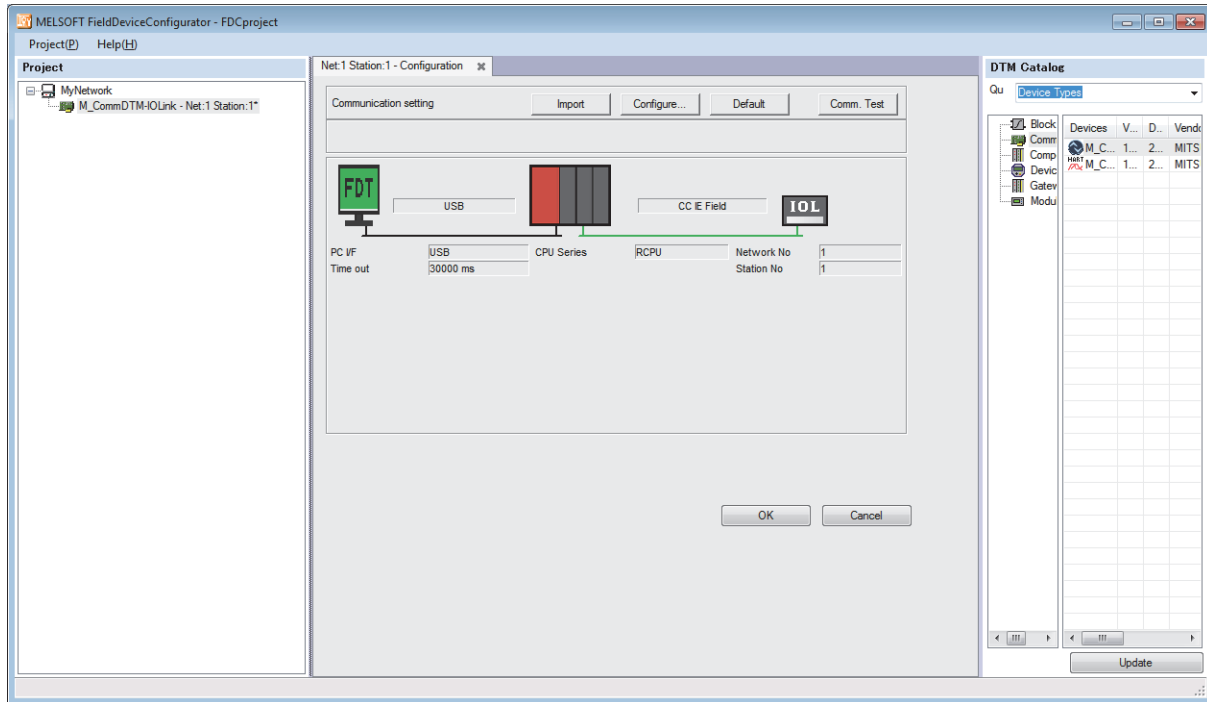

2. Click the [Import] button.
3. The network configuration setting information of GX Works3 is imported, and the communication setting is updated. Click the [OK] button to determine the setting.

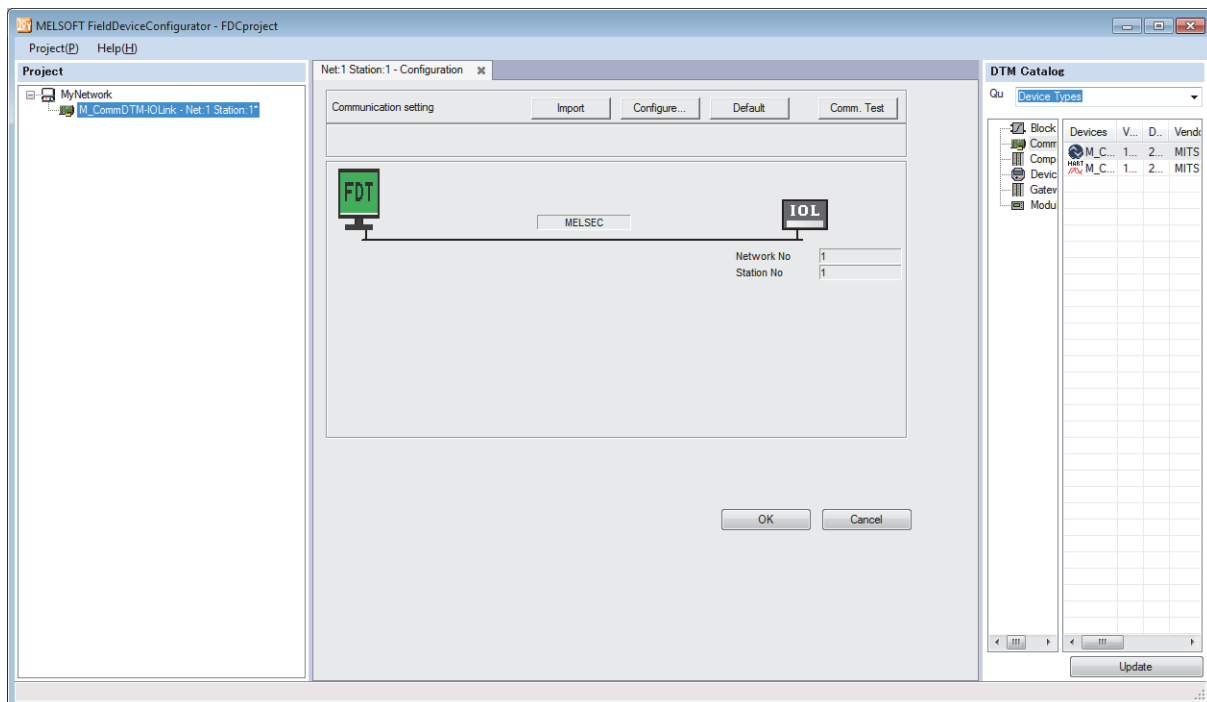

Precautions

The import function can be used only when FDC is started from GX Works3. When FDC is started directly, the import function is disabled, and therefore the communication setting needs to be configured from FDC separately.

Procedure for setting the IO-Link device parameter

The following describes how to set the IO-Link device parameter.

Setting procedure

1. Make the online connection between the personal computer and the IO-Link device.

🖱️ FDC project tree ⇒ Right-click on the Device DTM node of the control target ⇒ [Go Online]

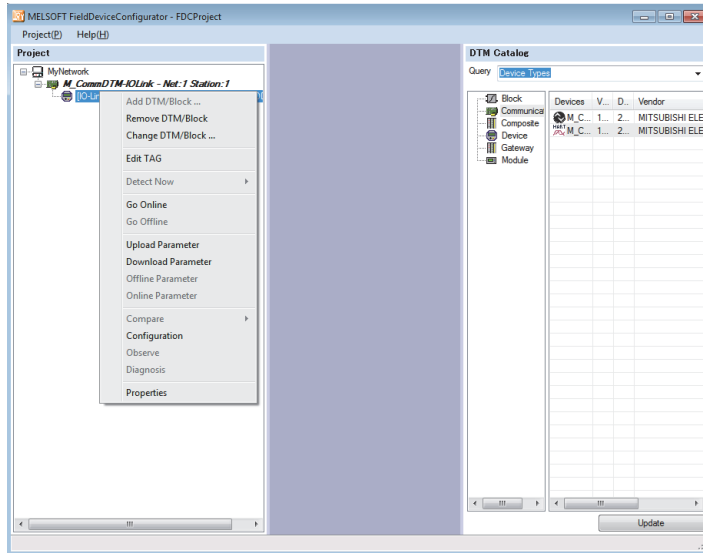

2. Configure the parameter setting of the IO-Link device. Right-click on the Device DTM node of the control target, and select [Configuration] in the context menu displayed by right-clicking to start the Device DTM setting window.
3. Read the parameter setting of the IO-Link device. Click the icon to read parameters of the connected IO-Link device in the parameter field of the Device DTM settings window.

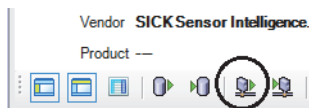

4. Set the items to be changed. For setting details of Device DTM, refer to the manual supplied from the manufacturer.
5. Write the set parameters to the IO-Link device. Click the icon to write the Device DTM setting to the connected IO-Link device.

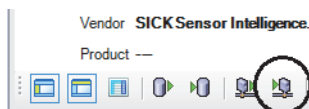

7 FUNCTIONS

This chapter describes the details of the functions available in the IO-Link module, and the setting procedures for those functions.

For details on remote I/O signals and remote register, refer to the following.

☞ Page 145 Remote I/O Signals

☞ Page 151 Remote Register

7.1 IO-Link Master Functions

IO-Link cyclic transmission function

This function communicates process data periodically with the IO-Link device connected to each channel.

With this function, information on the IO-Link device can be acquired and the IO-Link device can be controlled.

The communication cycle (cycle time) is automatically set to the minimum cycle time of the connected IO-Link device.

A maximum of 32 bytes process data can be communicated. The data size and structure vary depending on the connected IO-Link module.

To validate output process data, turn on CH□ Output data valid flag (RY8 to RYF).

Precautions

When the minimum cycle time of the connected IO-Link device is less than 1.0ms, the cycle time is set to 1.0ms.

Operation mode

This function is enabled only in the following operation modes.

- IO-Link (standard) mode
- IO-Link (sink input) mode

Process data

Process data contains the following data.

■IO-Link (standard) mode

- Data masking results
- Input process data
- Output process data

■IO-Link (sink input) mode

- DI signal
- Input process data
- Output process data

Precautions

- When CH□ Input data invalid flag (RX8 to RXF) is on, input process data is an undefined value and cannot be used with programs.
- When CH□ Output data valid flag (RY8 to RYF) is off, the IO-Link module notifies the IO-Link device that the output process data is invalid. When output process data is invalid, IO-Link device operates in accordance with the specifications of the IO-Link device being used.
- When Output process data output enabled command at channel error (address: 3720H to 3727H) is off (default), the output process data is invalid if a channel error occurs. To keep the output process data valid even when a channel error occurs, turn on Output process data output enabled command at channel error (address: 3720H to 3727H). (☞ Page 188 Output process data output enabled command at channel error)

Function combinations

The following shows a list of operations of the function combinations that deal with input process data.

Parameter setting	Swap operation	Bit segment operation	Input data masking operation
When "Number of Slicings" is 0	Input process data that has been swapped or not yet swapped is stored in the remote register in accordance with "Byte Position Swap".	No operation.	Masking results for the process data configuration defined in the IO-Link device manual are stored in the remote input in accordance with "Input Data Mask". Data to be masked is not affected by the swap or bit segment operations.
When "Number of Slicings" is 1 or more	No operation.	Input process data segmented is stored in the remote register in accordance with "Bit Slicing Setting".	Masking results for the process data configuration defined in the IO-Link device manual are stored in the remote input in accordance with "Input Data Mask". Data to be masked is not affected by the swap or bit segment operations.

For details on the functions, refer to the following.

☞ Page 74 Input data masking function

☞ Page 76 Swap function

☞ Page 78 Bit segment function

Setting method

Operating procedure

1. Open the "CC IE Field Configuration" window.
 - ☞ [Navigation window] ⇒ [Parameter] ⇒ [Module Information] ⇒ [RJ71GF11-T2] ⇒ [Basic Settings] ⇒ [Network Configuration Settings]
2. Open the "Parameter Processing of Device Station" window.
 - ☞ From the list of stations, select an IO-Link module ⇒ [CC IE Field Configuration] ⇒ [Online] ⇒ [Parameter Processing of Device Station].
3. Set "Method selection" to "Write Parameters".
4. For each channel, set "Operation Mode" to any of the following.
 - 1: IO-Link(Standard)Mode
 - 2: IO-Link(Sync Input)Mode

Window

Name	Initial Value	Unit	Read Value	Unit	Write Value	Unit	Setting
Individual Module Parameters CH1							
<input checked="" type="checkbox"/> Operation Mode	0: Disabled ...						
<input checked="" type="checkbox"/> Device Validation Setting	0: Do not v...						
<input checked="" type="checkbox"/> Input Off Delay Setting	0	x400us		x400us	0: Disabled mode		
<input checked="" type="checkbox"/> Input Data Mask	0x0000				1: IO-Link(Standard)Mode		
<input checked="" type="checkbox"/> Byte Position Swap	1: Enable				2: IO-Link(Sync Input)Mode		
<input checked="" type="checkbox"/> Event Retrieval Setting					4: SIO(Sync Input)Mode		
<input type="checkbox"/> Notifications	0: Do not re...				7: SIO(Source Output)Mode		
					8: Power Supply Mode		

IO-Link transient communication function

This function reads/writes IO-Link device parameters from/to the IO-Link device connected to each channel.

Also, this function reads/writes any IO-Link device parameters using the module FB or FDC.

 Page 67 IO-Link device setting automatic upload/download function

 Page 186 IO-Link device parameter manual upload command

 Page 186 IO-Link device parameter manual upload completed

 Page 54 IO-Link Device Parameter Setting

 CC-Link IE Field Network Remote IO-Link Module Function Block Reference (For MELSEC iQ-R)

IO-Link device setting automatic upload/download function

This function saves the parameters of IO-Link device connected to each channel in the IO-Link module.

When the IO-Link devices are replaced, this function allows new IO-Link devices to inherit the IO Link device parameters that have been stored in the old IO-Link devices.

The IO-Link device parameters can be uploaded manually. ( Page 69 Manual uploading)

Precautions

- This function can be used only when the connected IO-Link device supports the data storage function.
- Since IO-Link device parameters vary depending on the IO-Link device, all IO-Link device parameters may not be saved. Refer to the manual of the IO-Link device used.
- IO-Link device parameters are not uploaded or downloaded automatically when "Device Validation Setting" is not "0: Do not validate" and the device validation result is unacceptable. For details on device validation, refer to IO-Link device validation function. ( Page 70 IO-Link device validation function)

Operation mode

This function is enabled only in the following operation modes.

- IO-Link (standard) mode
- IO-Link (sink input) mode

Point

When the operation mode is not the IO-Link mode, IO-Link device parameters stored on the non-volatile memory of the IO-Link module are cleared.

7

Automatic uploading

IO-Link device parameters are automatically uploaded from IO-Link devices to the non-volatile memory of the IO-Link module.

Automatic downloading

IO-Link device parameters are automatically downloaded from the non-volatile memory of the IO-Link module to IO-Link devices.

Execution conditions

The following shows the conditions for automatic uploading and downloading of IO-Link device parameters.

Conditions			Processing operation	
IO-Link device parameters on non-volatile memory	Device validation setting	Device validation result	During processing of IO-Link device connections	During processing of IO-Link device parameter changes
Not exist	Not validate/Compatibility validation/Identity validation	—	Automatic uploading	—
Exist	Not validate	Match	Automatic uploading	Automatic uploading
	Compatibility validation/Identity validation	Match	Automatic downloading ^{*1*2}	
		Mismatch	No processing	—

*1 Even if the device validation result is match, the parameters may not be automatically downloaded properly if the structure of IO-Link device parameters has been changed. When the firmware version of the IO-Link device is defined, the firmware version is checked during automatic downloading, and a notification is issued as an event if the firmware version is different. (Parameters are automatically downloaded even if the firmware versions are different.)

*2 If IO-Link device parameters are the same, they are not downloaded automatically and no processing is performed.

■When IO-Link device parameters on non-volatile memory do not exist

In the following cases, IO-Link device parameters do not exist on the non-volatile memory.

- When no IO-Link device parameters have been uploaded so far since the shipment from the factory
- When no IO-Link device parameters have been uploaded so far since when the operation mode was set to other than IO-Link mode and the IO-Link device parameters on the non-volatile memory were cleared

■During processing of IO-Link device connections

This means the timing at which connections established with IO-Link devices operating in IO-Link mode are detected by the IO-Link module.

■During processing of IO-Link device parameter changes

This means the case where IO-Link device parameters are changed by a device mounted on the IO-Link device.

Manual uploading

Parameters can be uploaded manually using "Manual upload" of "Command Execution of Device Station" of the engineering tool.

Operating procedure

1. Open the "CC IE Field Configuration" window.
 - ☞ [Navigation window] ⇒ [Parameter] ⇒ [Module Information] ⇒ [RJ71GF11-T2] ⇒ [Basic Settings] ⇒ [Network Configuration Settings]
2. Open the "Command Execution of Device Station" window.
 - ☞ From the list of stations, select an IO-Link module ⇒ [CC IE Field Configuration] ⇒ [Online] ⇒ [Command Execution of Device Station].
3. Set "Method selection" to "Manual upload", select the target channel in "Write Value", and click the [Execute] button. When "0: All Channels" is selected in "Write Value", all channels are turned on simultaneously.

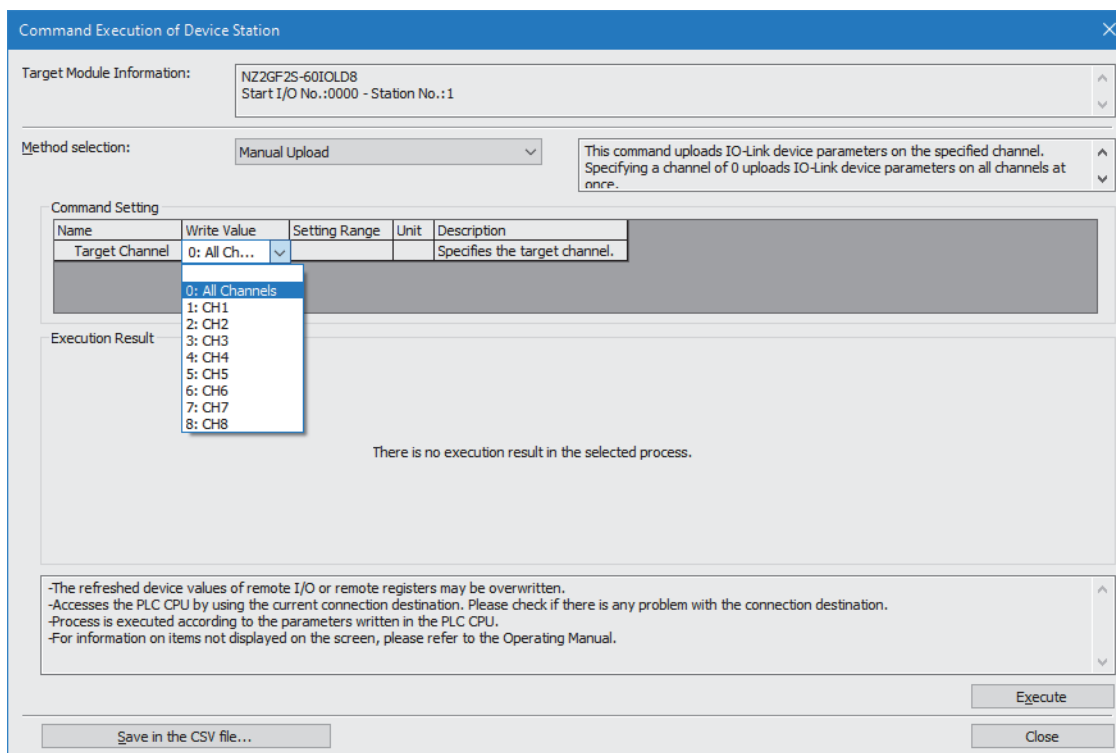

IO-Link device validation function

This function validates compatibility and identity of the IO-Link device connected to each channel.

This function can be used to recognize connection with unintended IO-Link devices when replacing IO-Link devices.

Check that the connected IO-Link device is an intended one. If not, review the connection or set "0: Do not validate" to "Device Validation Setting" to validate the IO-Link device after replacement.

IO-Link device validation is performed under the following circumstances.

- When an IO-Link device is connected
- When the operation mode is changed to IO-Link (standard) mode or IO-Link (sink input) mode
- When the IO-Link module is powered off and on with an IO-Link device connected
- When the IO-Link device is powered off and on with an IO-Link module connected

Operation mode

This function is enabled only in the following operation modes.

- IO-Link (standard) mode
- IO-Link (sink input) mode

Point

Device validation data on the non-volatile memory of the IO-Link module is cleared if the operation mode is set to a mode other than IO-Link mode.

Validated items for each type of device validation

The following table lists validation types and items to be validated.

○: Validated, ×: Not validated

Validation type	Validated item			
	Revision ID	Vendor ID	Device ID	Serial number
Not validate	○	×	×	×
Compatibility validation	○	○	○	×
Identity validation	○	○	○	○

Precautions

- If the validation result is unacceptable, a device validation error (error code: 1808H) occurs and communication is not established with the IO-Link device.
- Revision ID is always verified.
- Device validation is not performed if there is no device validation data on the non-volatile memory of the IO-Link module.

Automatic updating of device validation data on non-volatile memory

Data on the non-volatile memory of the IO-Link module is automatically updated as the device validation data of the connected IO-Link device when IO-Link device parameters are automatically uploaded. For the conditions for automatic uploading, refer to the following.

☞ Page 68 Execution conditions



Device validation data on the non-volatile memory is automatically updated even if the connected IO-Link device is not supporting the data storage function.

Precautions

When the identity validation is performed on an IO-Link device with an undefined serial number, a device validation error (error code: 1808H) occurs due to a serial number mismatch.

Setting method

Operating procedure

1. Open the "CC IE Field Configuration" window.
 [Navigation window] ⇒ [Parameter] ⇒ [Module Information] ⇒ [RJ71GF11-T2] ⇒ [Basic Settings] ⇒ [Network Configuration Settings]
2. Open the "Parameter Processing of Device Station" window.
 From the list of stations, select an IO-Link module ⇒ [CC IE Field Configuration] ⇒ [Online] ⇒ [Parameter Processing of Device Station].
3. Set "Method selection" to "Write Parameters".
4. Set "Device Validation Setting" for each channel.

Window

	Name	Initial Value	Unit	Read Value	Unit	Write Value	Unit	Setting Range	Description
<input checked="" type="checkbox"/>	Device Validation Setting	0: Do not v...				0: Do n...			This setting determ
<input checked="" type="checkbox"/>	Input Off Delay Setting	0	x400us		x400us				
<input checked="" type="checkbox"/>	Input Data Mask	0x0000				0: Do not validate			
<input checked="" type="checkbox"/>	Byte Position Swap	1: Enable				1: Compatibility Validation(vendor information and model name)			
<input checked="" type="checkbox"/>	Event Retrieval Setting					2: Identity Validation(vendor information, model name, and serial number)			

Displayed items

Name	Setting range
Device Validation Setting	<ul style="list-style-type: none">• 0: Do not validate (Default value)• 1: Compatibility Validation (vendor information and model name)• 2: Identity Validation (vendor information, model name, and serial number)

Reading of device validation data

Device validation data of the IO-Link device held by the IO-Link module and device validation data of the IO-Link device currently connected to the IO-Link module can be checked using "Read Device Validation Data" of "Command Execution of Device Station" of the engineering tool.

Operating procedure

1. Open the "CC IE Field Configuration" window.
 - ☞ [Navigation window] ⇒ [Parameter] ⇒ [Module Information] ⇒ [RJ71GF11-T2] ⇒ [Basic Settings] ⇒ [Network Configuration Settings]
2. Open the "Command Execution of Device Station" window.
 - ☞ From the list of stations, select an IO-Link module ⇒ [CC IE Field Configuration] ⇒ [Online] ⇒ [Command Execution of Device Station].
3. Set "Method selection" to "Read Device Validation Data" and click the [Execute] button.

Command Execution of Device Station

Target Module Information: NZ2GF2S-60IOLD8
Start I/O No.:0000 - Station No.:1

Method selection: Read Device Validation Data

This command reads the IO-Link device validation data stored in the IO-Link module and the IO-Link device validation data stored in the currently connected IO-Link module.

Command Setting

There is no command setting in the selected process.

Execution Result

Name	Read Value	Unit	Description
Device Validation Data(CH1)			
CH1.Revision ID(Module)			This is the revision ID configured in the IO-Link module during the ...
CH1.Vendor ID(Module)			This is the vendor ID configured in the IO-Link module during the ...
CH1.Device ID(Module)			This is the device ID configured in the IO-Link module during the a...
CH1.Serial Numbers 1 - 4(Module)			These are the serial numbers 1 through 4 configured in the IO-Lin...
CH1.Serial Numbers 5 - 8(Module)			These are the serial numbers 5 through 8 configured in the IO-Lin...
CH1.Serial Numbers 9 - 12(Module)			These are the serial numbers 9 through 12 configured in the IO-Li...
CH1.Serial Numbers 13 - 16(Module)			These are the serial numbers 13 through 16 configured in the IO-...
CH1.Revision ID(Device)			This is the revision ID configured in the IO-Link device.

-The refreshed device values of remote I/O or remote registers may be overwritten.
-Accesses the PLC CPU by using the current connection destination. Please check if there is any problem with the connection destination.
-Process is executed according to the parameters written in the PLC CPU.
-For information on items not displayed on the screen, please refer to the Operating Manual.

Execute

Save in the CSV file... Close

Point

Connection of a non-compatible IO-Link device causes a device validation error to occur, preventing some data of the currently connected IO-Link device from being acquired. 0 is displayed.

Disconnection detection function

This function detects disconnection if communication with an IO-Link device is lost in IO-Link mode.

Point

- Disconnections are detected even if an IO-Link device is not connected to a channel operating in IO-Link mode.
- To disable disconnection detection when replacing an IO-Link device with another IO-Link or an SIO device while the IO-Link module power is on, select the target channel in "Start Device Changeout" of "Command Execution of Device Station" of the engineering tool. ( Page 99 Device Replacement Function)

Operation mode

This function is enabled only in the following operation modes.

- IO-Link (standard) mode
- IO-Link (sink input) mode

Disconnection notification

The following occurs when a disconnection from the IO-Link device is detected.

- The ERR. LED flashes.
- CH□ ERR. LED of the target channel turns on.
- CH□ LED of the target channel flashes in green.
- CH□ Input data invalid flag (RX8 to RXF) for the target channel turns on.
- CH□ IO-Link device connection status flag (RX20 to RX27) for the target channel turns off.
- Warning status flag (RWr0.b12) turns on.
- A disconnection error (error code: 1806H) is stored in Warning code (RWr2).
- Occurrence of minor error (RX19) turns on.

Recovery from a disconnection

The following occurs in five seconds after recovery from a disconnection.

- The ERR. LED turns off.
- CH□ ERR. LED of the target channel turns off.
- CH□ LED of the target channel turns on in green.
- CH□ Input data invalid flag (RX8 to RXF) for the target channel turns off.
- CH□ IO-Link device connection status flag (RX20 to RX27) for the target channel turns on.
- Warning status flag (RWr0.b12) turns off.
- Warning code (RWr2) is cleared.

Point

Occurrence of minor error (RX19) remains on. Occurrence of minor error (RX19) can be turned off by turning on Occurrence of minor error clear request flag (RY19).

Input data masking function

This function calculates ON/OFF values in IO-Link (standard) mode according to the input process data. With this function, changes in a specified bit of input process data can be detected easily.

Operation mode

This function is enabled only in IO-Link (standard) mode.

Description

Any bit from the first two bytes of input process data will be masked.

Set "Input Data Mask" depending on the process data structure of the IO-Link device used.

For information on IO-Link device process data structures, refer to the manual of the IO-Link device used.

If all input process data for the bits set to 1 in "Input Data Mask" is 1, CH□ Data masking results (RX0 to RX7) turn on.

If any of them is 0, CH□ Data masking results (RX0 to RX7) turn off.

Point

- Input data masking results can be used with the input OFF delay function.
- When the bit segment function is enabled, input process data will be masked before bit segmentation. For details on the bit segment function, refer to Bit segment function. (Page 78 Bit segment function)

Ex.

When the input data masking result is 1

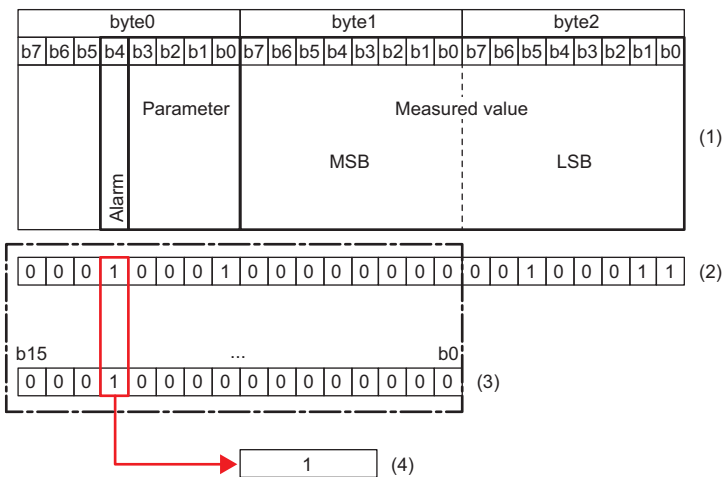

- (1) IO-Link device process data structure
- (2) IO-Link device input process data value
- (3) "Input Data Mask": 1000H
- (4) Masking result

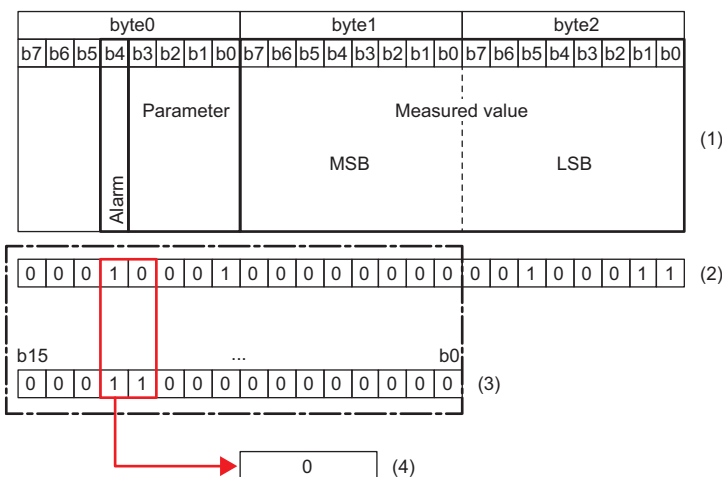

When the input data masking result is 0



- (1) IO-Link device process data structure
- (2) IO-Link device input process data value
- (3) "Input Data Mask": 1800H
- (4) Masking result

Setting method

Operating procedure

1. Open the "CC IE Field Configuration" window.
 [Navigation window] ⇒ [Parameter] ⇒ [Module Information] ⇒ [RJ71GF11-T2] ⇒ [Basic Settings] ⇒ [Network Configuration Settings]
2. Open the "Parameter Processing of Device Station" window.
 From the list of stations, select an IO-Link module ⇒ [CC IE Field Configuration] ⇒ [Online] ⇒ [Parameter Processing of Device Station].
3. Set "Method selection" to "Write Parameters".
4. Set "Input Data Mask" for each channel.

Window

	Name	Initial Value	Unit	Read Value	Unit	Write Value
<input checked="" type="checkbox"/>	Input Data Mask	0x0000				1000

Displayed items

Name	Setting range
Input Data Mask	0000H to FFFFH

Swap function

This function swaps the upper and lower bytes of data sent and received between the IO-Link module and the IO-Link device connected to each channel.

With this function, there is no need to program an operation to swap the upper and lower bytes when using an IO-Link device that handles the upper and lower bytes in reverse.

Ex.

When the swap function is enabled

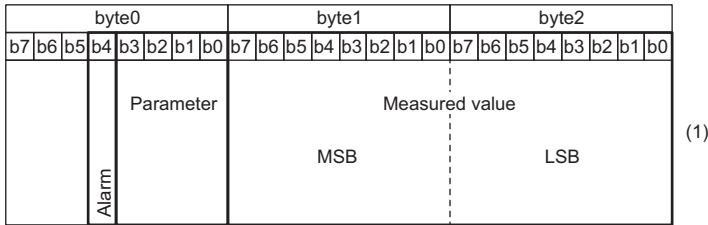

- (1) Structure of IO-Link device input process data
- (2) CPU module device
- (3) Input process data (1st word)
- (4) Input process data (2nd word)

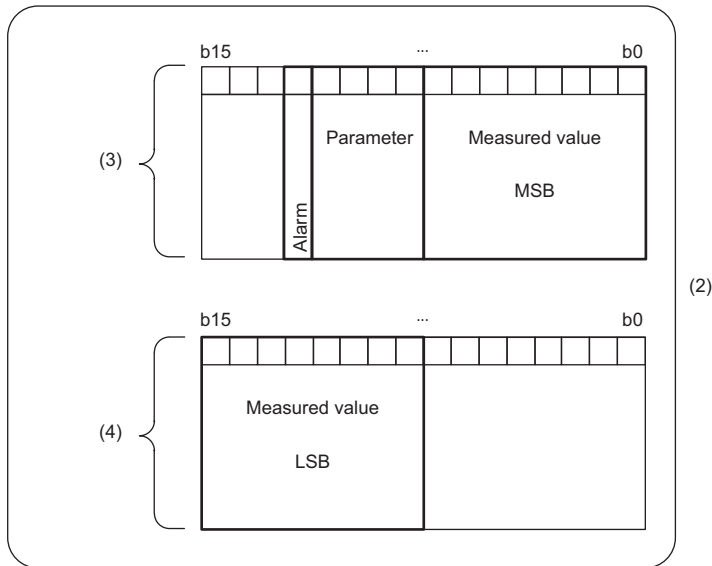

Ex.

When the swap function is disabled

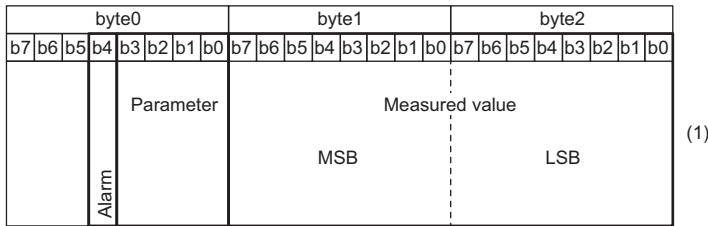

- (1) Structure of IO-Link device input process data
- (2) CPU module device
- (3) Input process data (1st word)
- (4) Input process data (2nd word)

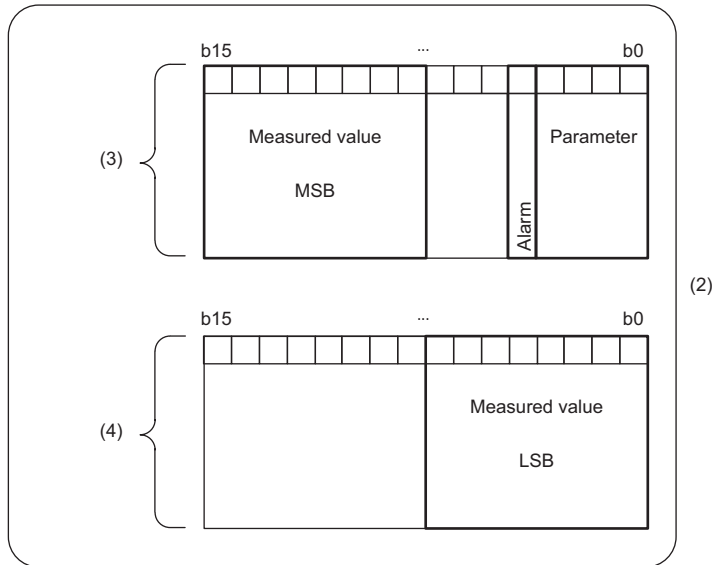

Setting method

Operating procedure

1. Open the "CC IE Field Configuration" window.
 - [Navigation window] ⇒ [Parameter] ⇒ [Module Information] ⇒ [RJ71GF11-T2] ⇒ [Basic Settings] ⇒ [Network Configuration Settings]
2. Open the "Parameter Processing of Device Station" window.
 - From the list of stations, select an IO-Link module ⇒ [CC IE Field Configuration] ⇒ [Online] ⇒ [Parameter Processing of Device Station].
3. Set "Method selection" to "Write Parameters".
4. Set "Byte Position Swap".

Window

Name	Initial Value	Unit	Read Value	Unit	Write Value
<input checked="" type="checkbox"/> Byte Position Swap	1: Enable				1: Enable
<input checked="" type="checkbox"/> Event Retrieval Setting					
Notifications	0: Do not re...				0: Disable
Warnings	1: Retrieve ...				1: Enable

Displayed items

Name	Setting range
Byte Position Swap	<ul style="list-style-type: none"> • 0: Disable • 1: Enable (Default value)

Bit segment function

This function segments input process data using the bit count set for each channel.

The bit segment function can be used to segment continuous input process data into data units.

This function eliminates the necessity to perform tasks such as using a program to extract specified bits.

Description

This function segments input process data into bits.

Number of Slicings is the number of times input process data is to be segmented. If not using the bit segment function, select 0.

Set the bit length and bit offset of the input process data to be segmented in Bit length and Bit offset. Input process data is segmented from the specified bit offset position for the specified number of bits.

Point

The bit segment function assigns the input process data from the IO-Link device to CH□ Input process data (RWr4 to RWr83) in the order set in "Bit Slicing Setting" (starting from No.1).
0 is stored for CH□ Input process data (RWr4 to RWr83) that do not support the value set in "Bit Slicing Setting".

Ex.

For bit segmenting of alarm, parameter, and measured value of the input process data from the IO-Link device connected to CH1

Set the bit offset with the most significant bit (b7) of byte0 as offset 0.

- Alarm: Data of Bit offset = 3, Bit length = 1
- Parameter: Data of Bit offset = 4, Bit length = 4 bits
- Measured value: Data of Bit offset = 8, Bit length = 16 bits

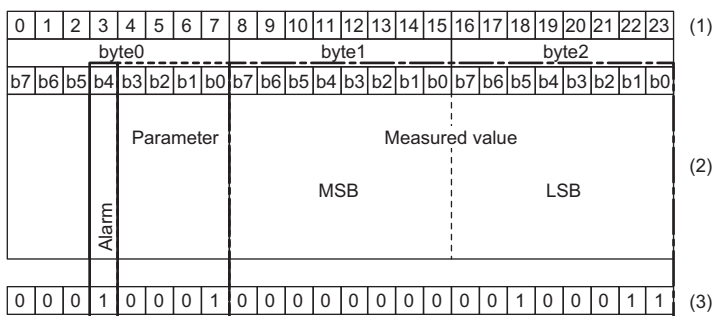

Set "Bit Slicing Setting" of Individual Module Parameters CH1 as follows.

- "Number of Slicings": 3
- "No.1Bit Offset": 3, "No.1Bit Length": 1
- "No.2Bit Offset": 4, "No.2Bit Length": 4
- "No.3Bit Offset": 8, "No.3Bit Length": 16

Name	Initial Value	Unit	Read Value	Unit	Write Value
<input checked="" type="checkbox"/> Bit Slicing Setting					
Number of Slicings	0				3
No. 1Bit Offset	0				3
No. 1Bit Length	0				1
No. 2Bit Offset	0				4
No. 2Bit Length	0				4
No. 3Bit Offset	0				8
No. 3Bit Length	0				16

Segmented values are stored as follows.

- Alarm values are stored in CH1 Input process data (1st word) (RWr4).

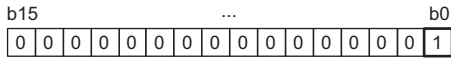

- Parameter values are stored in CH1 Input process data (2nd word) (RWr5).

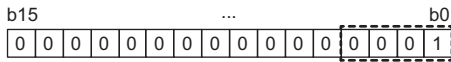

- Measured values are stored in CH1 Input process data (3rd word) (RWr6).

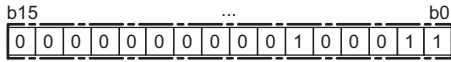

Precautions



- The bit offset or bit length values exceeding the setting of "Number of Slicings" are ignored.
- When the bit length is set to 0, 0 is stored in all bits of the corresponding CH□ Input process data (RWr4 to RWr83).
- Input data masking of bit-segmented input process data and the bit segmenting of input data masking results are not possible.
- If the specified bit offset and bit length exceed the input process data, any excess bits are ignored.

Ex.

When input process data is 32 bits, the bit offset is set to 30, and the bit length is set to 5
The input process data is segmented with the bit offset 30 and the bit length 2.

Setting method

Operating procedure

1. Open the "CC IE Field Configuration" window.
 [Navigation window] ⇒ [Parameter] ⇒ [Module Information] ⇒ [RJ71GF11-T2] ⇒ [Basic Settings] ⇒ [Network Configuration Settings]
2. Open the "Parameter Processing of Device Station" window.
 From the list of stations, select an IO-Link module ⇒ [CC IE Field Configuration] ⇒ [Online] ⇒ [Parameter Processing of Device Station].
3. Set "Method selection" to "Write Parameters".
4. Set "Number of Slicings" for each channel.
5. Set the bit offset and bit length for each channel.

Window

Name	Initial Value	Unit	Read Value	Unit	Write Value	Unit	Setting Range
<input checked="" type="checkbox"/> Bit Slicing Setting							
Number of Slicings	0						0 to 16
No. 1Bit Offset	0						0 to 255
No. 1Bit Length	0						0 to 16
No. 2Bit Offset	0						0 to 255
No. 2Bit Length	0						0 to 16
No. 3Bit Offset	0						0 to 255
No. 3Bit Length	0						0 to 16
No. 4Bit Offset	0						0 to 255
No. 4Bit Length	0						0 to 16

Displayed items

Name	Setting range
Number of Slicings	<ul style="list-style-type: none"> • 0 (no bit segment) (Default value) • 1 to 16
No.1Bit Offset to No.16Bit Offset	0 to 255 (Default value: 0)
No.1Bit Length to No.16Bit Length	0 to 16 (Default value: 0)

IO-Link communication retry count integration function

This function counts the number of IO-Link communication retries for each channel.

With this function, the number of IO-Link communication retries can be checked when the IO-Link frame cannot be received properly from IO-Link devices.

This function can diagnose the quality of IO-Link communication.

The IO-Link communication retry count integration value counts from 0 to 65535 and stops after counting 65535.

Point

- IO-Link communication retry count integration values are cleared and then restarted upon power-off or reset.
- The count is stopped while the corresponding channel in Device replacement status (address: 299DH) is on.

Method for checking the IO-Link communication retry count

Operating procedure

1. Open the "CC IE Field Configuration" window.
🔗 [Navigation window] ⇒ [Parameter] ⇒ [Module Information] ⇒ [RJ71GF11-T2] ⇒ [Basic Settings] ⇒ [Network Configuration Settings]
2. Open the "Command Execution of Device Station" window.
🔗 From the list of stations, select an IO-Link module ⇒ [CC IE Field Configuration] ⇒ [Online] ⇒ [Command Execution of Device Station].
3. Set "Method selection" to "Read IO-Link Communication Retry Count" and click the [Execute] button.

Window

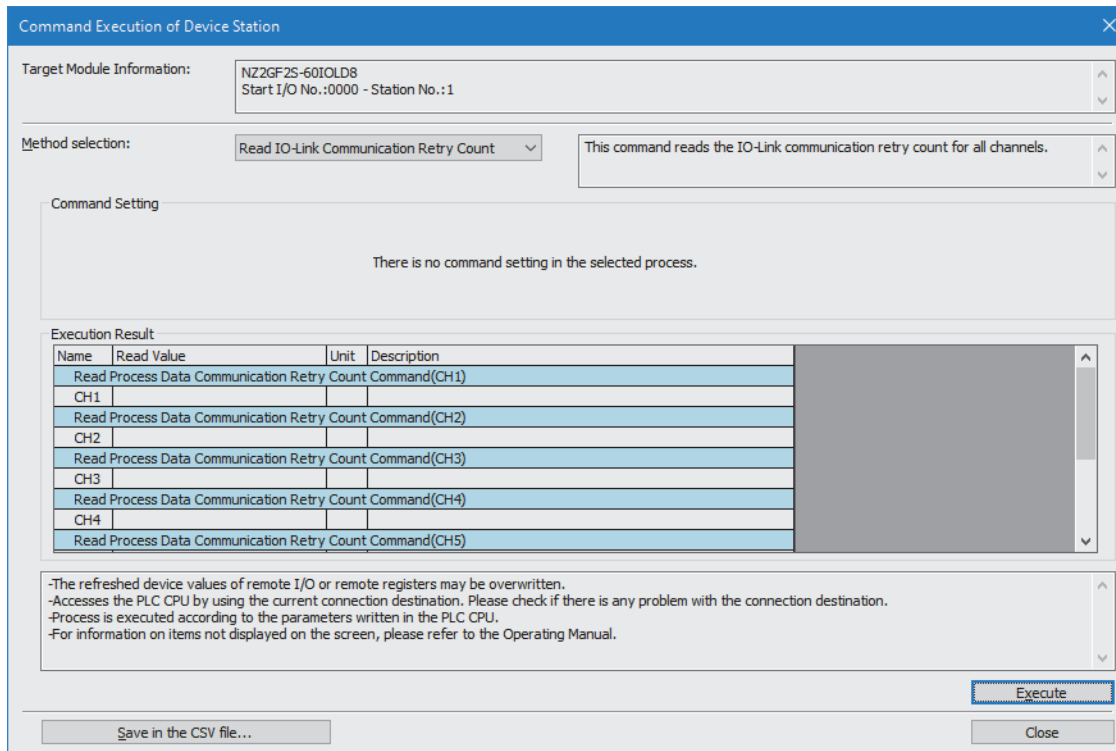

Command Execution of Device Station

Target Module Information: NZ2GF25-60IOLD8
Start I/O No.:0000 - Station No.:1

Method selection: Read IO-Link Communication Retry Count

This command reads the IO-Link communication retry count for all channels.

Command Setting

There is no command setting in the selected process.

Execution Result

Name	Read Value	Unit	Description
Read Process Data Communication Retry Count Command(CH1)			
CH1			
Read Process Data Communication Retry Count Command(CH2)			
CH2			
Read Process Data Communication Retry Count Command(CH3)			
CH3			
Read Process Data Communication Retry Count Command(CH4)			
CH4			
Read Process Data Communication Retry Count Command(CH5)			

-The refreshed device values of remote I/O or remote registers may be overwritten.
-Accesses the PLC CPU by using the current connection destination. Please check if there is any problem with the connection destination.
-Process is executed according to the parameters written in the PLC CPU.
-For information on items not displayed on the screen, please refer to the Operating Manual.

Execute

Close

Save in the CSV file...

Method for clearing the IO-Link communication retry count

Operating procedure

1. Open the "CC IE Field Configuration" window.
☞ [Navigation window] ⇒ [Parameter] ⇒ [Module Information] ⇒ [RJ71GF11-T2] ⇒ [Basic Settings] ⇒ [Network Configuration Settings]
2. Open the "Command Execution of Device Station" window.
☞ From the list of stations, select an IO-Link module ⇒ [CC IE Field Configuration] ⇒ [Online] ⇒ [Command Execution of Device Station].
3. Set "Method selection" to "Clear IO-Link Communication Retry Count", select the target channel in "Write Value", and click the [Execute] button. When "0: All Channels" is selected in "Write Value", all channels are cleared simultaneously.

Window

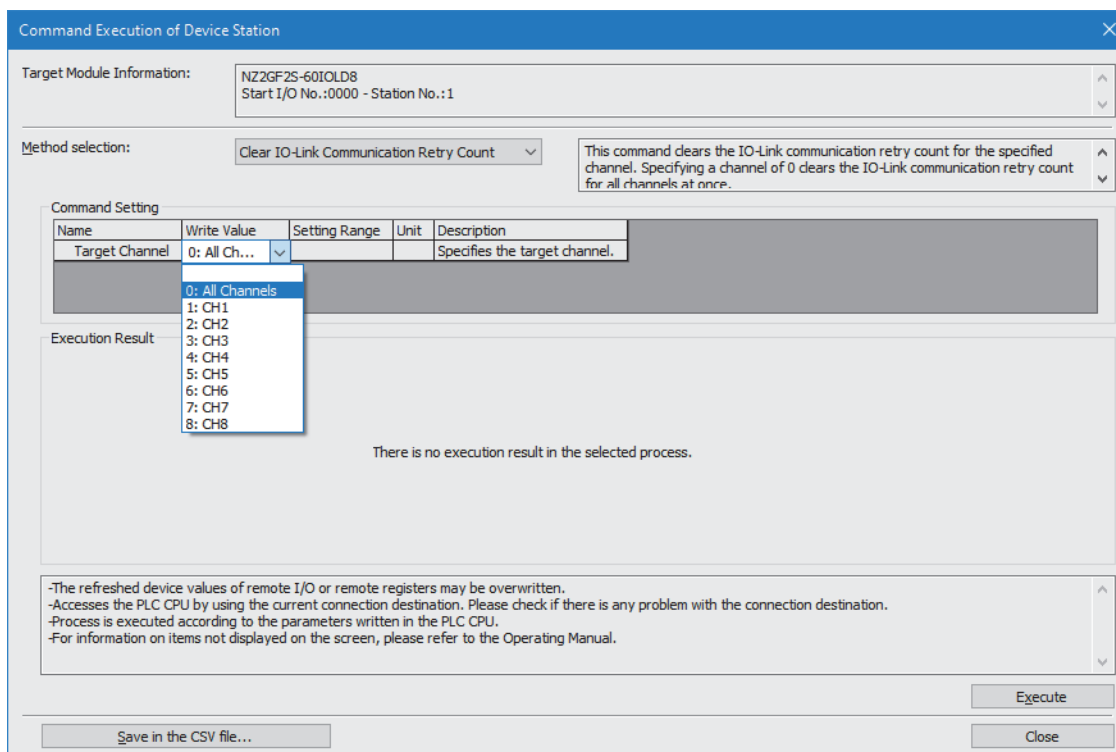

7.2 Input Function

Input OFF delay function

This function turns off an X signal after a predetermined time passed from when an actual input becomes off from on. With the input OFF delay function, even an input whose ON time is shorter than that of the link scan can be surely recognized on a program. When an external input device is replaced with a sensitive one, users can use the existing program only by adjusting the delay time.

Operation modes and data

This function is enabled only in the following operation modes and with the following data.

- IO-Link (standard) mode: Data masking results
- IO-Link (sink input) mode: DI signals
- SIO (sink input) mode: CQ input signals

Description

Ex.

A short period of ON time can be surely recognized by setting the delay time longer than the period of the link scan time.

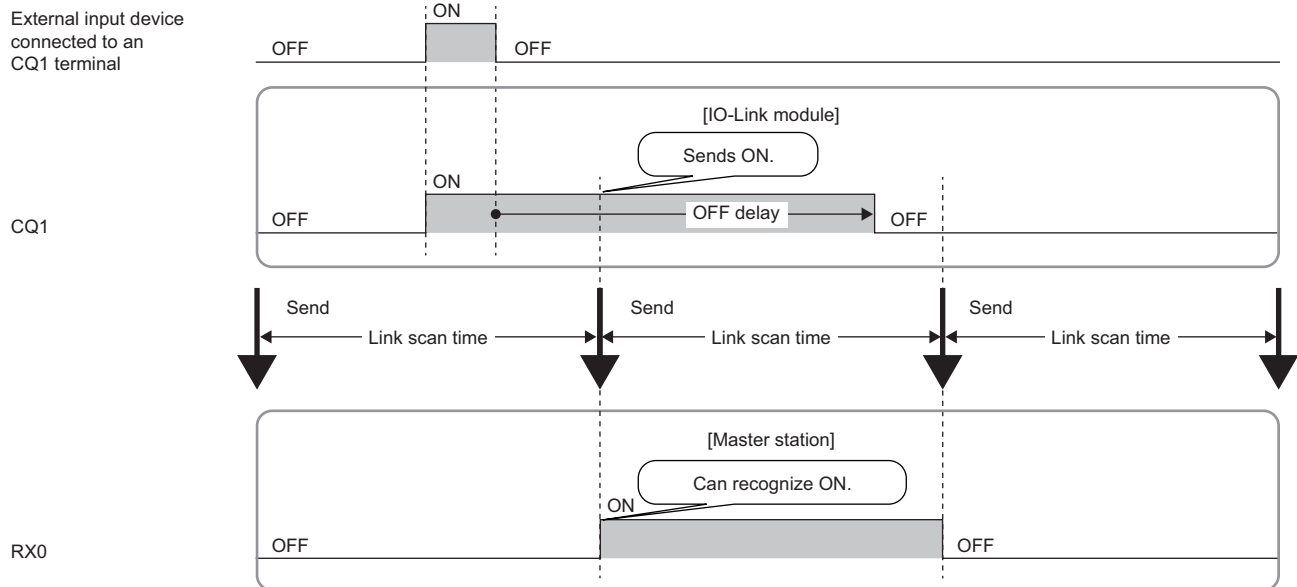

Ex.

When the input OFF delay function is disabled

External input device
connected to an
CQ1 terminal

CQ1

RX0

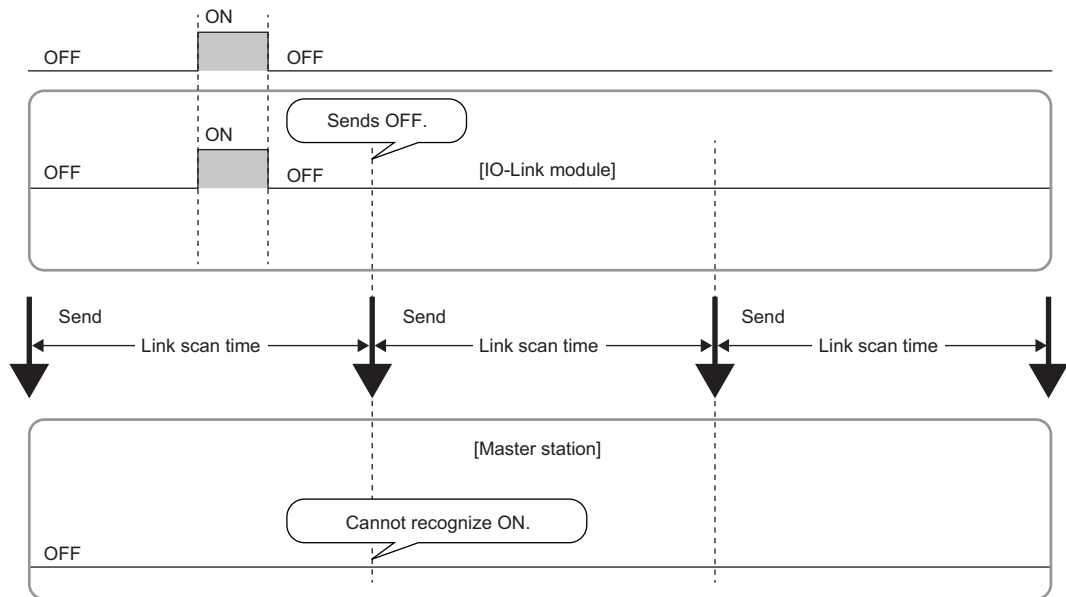

Point

- The delay time does not include the hardware response time.
- The accuracy of the delay time is 0 to 400 μ s.

Setting procedure

Operating procedure

1. Open the "CC IE Field Configuration" window.
 2. Open the "Parameter Processing of Device Station" window.
 3. Set "Method selection" to "Write Parameters".
 4. Set "Input OFF Delay Setting".
- [Navigation window] \Rightarrow [Parameter] \Rightarrow [Module Information] \Rightarrow [RJ71GF11-T2] \Rightarrow [Basic Settings] \Rightarrow [Network Configuration Settings]
- From the list of stations, select an IO-Link module \Rightarrow [CC IE Field Configuration] \Rightarrow [Online] \Rightarrow [Parameter Processing of Device Station].

Window

Name	Initial Value	Unit	Read Value	Unit	Write Value
<input checked="" type="checkbox"/> Input Off Delay Setting	0	x-400us		x-400us	100
<input checked="" type="checkbox"/> Input Data Mask	0x0000				

Displayed items

Item	Setting range
Input OFF Delay Setting	<ul style="list-style-type: none"> • 0 (No delay) • 1 to 150000 (400μs to 60s, 400μs unit)

Input response time setting function

This function prevents an incorrect input due to noise by setting the response time until the module recognizes an actual input as the X signal.

Point

Although tolerance to chattering and noise will increase with longer input response times, response to input signals will be slowed.



Operation modes and data

This function is enabled only in the following operation modes and with the following data.

- IO-Link (sink input) mode: DI signals
- SIO (sink input) mode: CQ input signals

Setting method

Operating procedure

1. Open the "CC IE Field Configuration" window.
 [Navigation window] ⇒ [Parameter] ⇒ [Module Information] ⇒ [RJ71GF11-T2] ⇒ [Basic Settings] ⇒ [Network Configuration Settings]
2. Open the "Parameter Processing of Device Station" window.
 From the list of stations, select an IO-Link module ⇒ [CC IE Field Configuration] ⇒ [Online] ⇒ [Parameter Processing of Device Station].
3. Set "Method selection" to "Write Parameters".
4. Set "Input Response Time Setting".

Window

Name	Initial Value	Unit	Read Value	Unit	Write Value
Individual Station Parameters					
<input checked="" type="checkbox"/> Input Response Time Setting	5: 10ms				0: 0ms
<input checked="" type="checkbox"/> Output HOLD/CLEAR Setting	0: CLEAR				
Individual Module Parameters CH1					
<input checked="" type="checkbox"/> Operation Mode	0: Disabled ...				2: 1.0ms 3: 1.5ms 4: 5ms 5: 10ms 6: 20ms 7: 70ms
<input checked="" type="checkbox"/> Device Validation Setting	0: Do not v...				
<input checked="" type="checkbox"/> Input Off Delay Setting	0	x400us		x400us	
<input checked="" type="checkbox"/> Input Data Mask	0x0000				
<input checked="" type="checkbox"/> Byte Position Swap	1: Enable				

Displayed items

Item	Setting range
Input Response Time Setting	<ul style="list-style-type: none">• 0: 0ms• 2: 1.0ms• 3: 1.5ms• 4: 5ms• 5: 10ms (Default value)• 6: 20ms• 7: 70ms

Precautions

The IO-Link module may capture noise as an input depending on the input response time setting. The pulse width which is taken in as an input varies depending on the input response time set in parameters. To set the input response time, consider fully the operating environment. The following table shows the minimum values of the pulse widths which may be taken in as an input. The pulse widths lower than the values shown below can be filtered as noise.

Operation mode	Input response time setting						
	0ms	1.0ms	1.5ms	5ms	10ms	20ms	70ms
IO-Link (sink input) mode	—	0.15ms	0.4ms	2ms	4ms	9ms	36ms
SIO (sink input) mode	—	0.4ms	0.8ms	2ms	8ms	17ms	62ms

7.3 Output Function

Number of output ON times integration function

The number of ON times of each output point is counted within the range of 0 to 2147483647. The integration value remains even though the IO-Link module is powered off.

Operation modes and data

This function is enabled only in the following operation modes and with the following data.

- SIO (source output) mode: CQ output signals

Checking and clearing the number of output ON times

The number of output ON times can be checked and cleared using a program.

Item	Description	Reference
CH□ Number of output ON times integration value (address: 299EH to 29ADH)	Stores the integration value of the number of output ON times integration function.	Page 177 Number of output ON times integration value
Number of output ON times integration value clear command (address: 2E80H)	When the corresponding bit of output is turned on, the integration value for the output with the number of output ON times integration function is cleared.	Page 184 Number of output ON times integration value clear command
Number of output ON times integration value clear completed (address: 2E81H)	After the integration value is cleared using Number of output ON times integration value clear command (address: 2E80H), the bit of the output that has been cleared turns on.	Page 185 Number of output ON times integration value clear completed

7

Point

- When the ON time and the OFF time of the target output signal are less than 10ms, the IO-Link module cannot recognize the output change and the number of output ON times may not be counted.
- When the number of output ON times integration value exceeds 2147483647, the count stops. To integrate the number of output ON times continuously, clear the integration value by using Number of output ON times integration value clear command (address: 2E80H).

Output ON/OFF information hold function

This function checks if the output has been turned once on or off.

Operation mode

This function is enabled only in the following operation modes and with the following data.

- SIO (source output) mode

Output ON information

Output ON information is stored in CH□ Output ON information (RWr4.b0, RWr14.b0, RWr24.b0, RWr34.b0, RWr44.b0, RWr54.b0, RWr64.b0, RWr74.b0).

Whether the output has been turned on or not can be checked with CH□ Output ON information (RWr4.b0, RWr14.b0, RWr24.b0, RWr34.b0, RWr44.b0, RWr54.b0, RWr64.b0, RWr74.b0).

CH□ Output ON information (RWr4.b0, RWr14.b0, RWr24.b0, RWr34.b0, RWr44.b0, RWr54.b0, RWr64.b0, RWr74.b0) can be cleared with CH□ Output ON information clear request (RWw4.b0, RWw14.b0, RWw24.b0, RWw34.b0, RWw44.b0, RWw54.b0, RWw64.b0, RWw74.b0).

Output OFF information

Output OFF information is stored in CH□ Output OFF information (RWr4.b1, RWr14.b1, RWr24.b1, RWr34.b1, RWr44.b1, RWr54.b1, RWr64.b1, RWr74.b1).

Whether the output has been turned off or not can be checked with CH□ Output OFF information (RWr4.b1, RWr14.b1, RWr24.b1, RWr34.b1, RWr44.b1, RWr54.b1, RWr64.b1, RWr74.b1).

CH□ Output OFF information (RWr4.b1, RWr14.b1, RWr24.b1, RWr34.b1, RWr44.b1, RWr54.b1, RWr64.b1, RWr74.b1) can be cleared with CH□ Output OFF information clear request (RWw4.b1, RWw14.b1, RWw24.b1, RWw34.b1, RWw44.b1, RWw54.b1, RWw64.b1, RWw74.b1).

7.4 CC-Link IE Field Network Communication Function

Cyclic transmission

This function periodically exchanges data among stations on the network using link devices.

An IO-Link module operates as an intelligent device station on the CC-Link IE Field Network.

The status of the master station link devices (RY, RWw) is output to the IO-Link module external devices, and the status of input from the IO-Link module external devices are stored in the master station link devices (RX, RWr).

The following table lists applications of link devices used for the IO-Link module.

Link device	Application	Reference
RX, RY	Configures the settings such as the input and output values in IO-Link mode and SIO mode.	Page 145 Remote I/O Signals
RWw, RWr	Reads error codes and reads/writes IO-Link module process data.	Page 151 Remote Register

For details on the CC-Link IE Field Network cyclic transmission, refer to the following.

 User's manual for the master/local module used

Transient transmission

This function reads or writes data on the IO-Link module in line with a dedicated instruction from the master station. The IO-Link module uses the REMFR instruction or REMTO instruction to perform transient transmission.

Data that can be read and written in transient transmission

The following table lists the IO-Link module data that can be read and written in transient transmission on the CC-Link IE Field Network.

Address		Area	Data type
Decimal	Hexadecimal		
5376 to 5631	1500H to 15FFH	Parameter area	Station-based parameter data
5632 to 7935	1600H to 1EFFH		Module-based parameter data
10240 to 10495	2800H to 28FFH	Monitoring area	Station-based monitor data
10496 to 10751	2900H to 29FFH		Module-based monitor data
11008 to 11263	2B00H to 2BFFH	Event information area	Station-based current error data
11264 to 11519	2C00H to 2CFFH		Station-based event data
11520 to 11775	2D00H to 2DFFH	Module control data area	Station-based control data
11776 to 15871	2E00H to 3DFFH		Module-based control data

Fast link-up function

This function shortens the time taken for data link establishment with the master station at power-on.

With this function, the time to change tools can be shortened in the system with a tool change mechanism (such as a tool changer) for tools that can be installed at the end of an industrial robot arm.

The data link time varies depending on the number of connected modules or cable length. When eight IO-Link modules are connected (excluding the IO-Link module directly connected to the master module) and the station-to-station distance is 30m, data link is established in 0.5s on average.

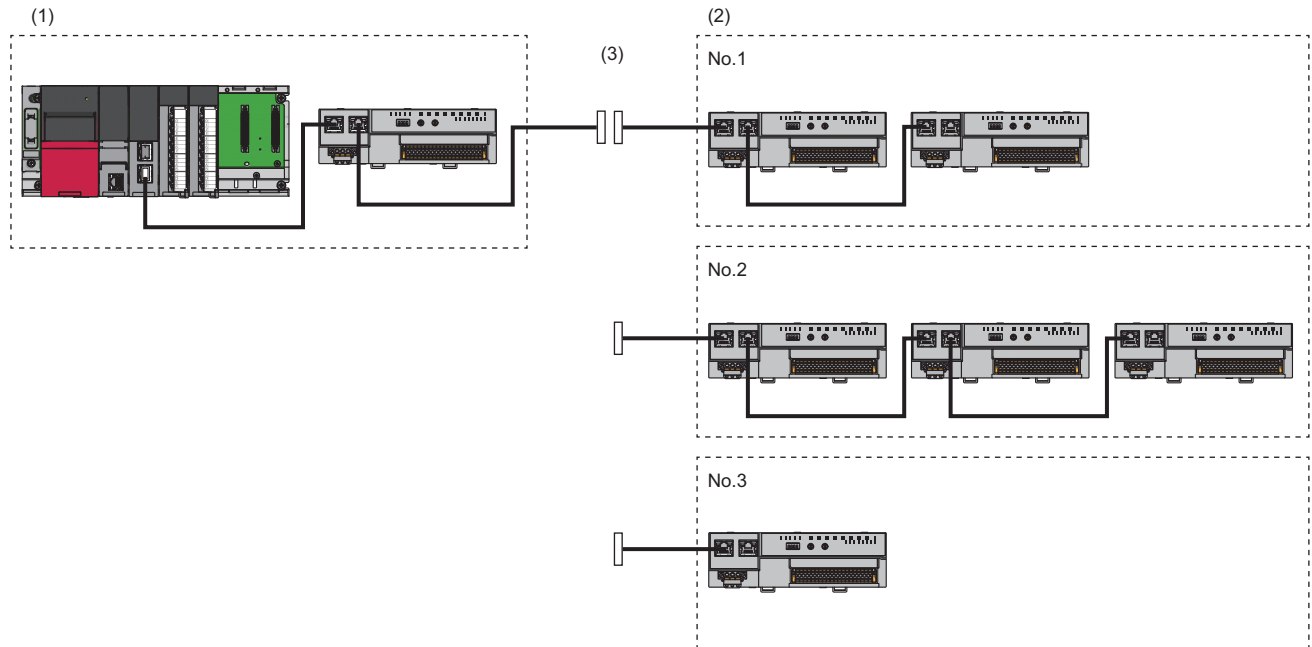

- (1) Robot-side system
- (2) System implemented in the tool at the end of an arm
- (3) Tool changer
- No.1: Tool 1
- No.2: Tool 2
- No.3: Tool 3

Applicable master station

To use the fast link-up function, use the following modules as master modules. The time to establish data link can be shortened by using the following master module.

■MELSEC-Q/L series

Master module	Serial number (first five digits)
QJ71GF11-T2	"18042" or later
LJ71GF11-T2	"18042" or later

■MELSEC iQ-R series

Master module	Firmware version
RJ71GF11-T2	"11" or later
RJ71EN71	"11" or later
RnENCPU (network part)	"9" or later

Setting method

Set the fast link-up function using the function setting switch. (☞ Page 30 Function setting switch setting)

Whether this function is enabled or disabled depends on the status of the function setting switch at the startup of the IO-Link module.

Point

When the function setting switch is changed after the IO-Link module has started up, the following error code is generated and the status of this function (enabled/disabled) is not changed. To change the status of this function (enabled/disabled), power off and on.

- When Function setting switch 1 is changed: Function setting switch 1 change error (error code: 1804H)
- When Function setting switch 2 is changed: Function setting switch 2 change error (error code: 1805H)

■Checking the status of the fast link-up function (enabled/disabled)

The current status of the fast link-up function (enabled/disabled) can be checked with Fast link-up setting status flag (address: 2801H).

How to use the fast link-up function

The following describes how to use the fast link-up function.

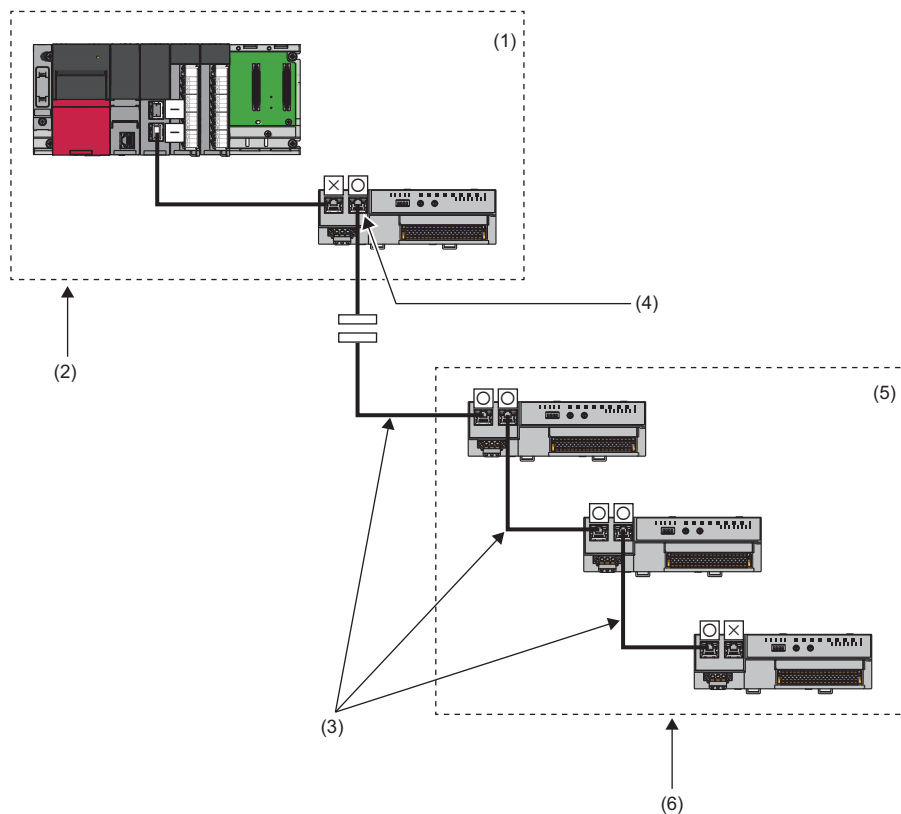

—: The fast link-up function is not supported.

×: The fast link-up function is disabled.

○: The fast link-up function is enabled.

No.	Description
(1)	In the robot-side system (The power is always on.)
(2)	<ul style="list-style-type: none"> • A master module and an IO-Link module are stored in the robot-side system. (☞ Page 93 Installation and configuration) • Keep the IO-Link module in the robot-side system powered on. (☞ Page 93 Operation)
(3)	<ul style="list-style-type: none"> • Connect between ports where the fast link-up function is enabled. (☞ Page 93 Setting) • Connect PORT1 and PORT2. (☞ Page 93 Installation and configuration)
(4)	Enable the fast link-up function for PORT2 of the I/O module in the robot-side system, and connect the IO-Link module with the I/O module of the tool-side system. (☞ Page 93 Installation and configuration)
(5)	In the tool-side system (The modules are powered on only while being connected.)

No.	Description
(6)	<ul style="list-style-type: none"> • Simultaneously power on all IO-Link modules in the tool-side system. (☞ Page 93 Operation) • Connect to a different tool one second after the master station detects that the previously used tool has been disconnected. (☞ Page 93 Operation)

■Setting

Enable the fast link-up function for the ports to be connected each other. If a port where the fast link-up function is enabled is connected with a port where the fast link-up function is not supported or disabled, link-up will not be performed.

■Installation and configuration

- Incorporate a master module and an IO-Link module in the robot-side system. Disable the fast link-up function for the port of the IO-Link module that is connected to the master module.
- Disable the fast link-up function for PORT1 of the IO-Link module in the robot-side system, and connect it with the master module. Enable the fast link-up function for PORT2 of the IO-Link module in the robot-side system, and connect it with PORT1 of the IO-Link module in the tool-side system. For any other connection, it may take longer time to establish data link.
- Connect PORT1 and PORT2 of the modules where data link is established using the fast link-up function with cables. Even if the fast link-up function is enabled, link-up will not be performed when PORT1 is connected to PORT1 or PORT2 is connected to PORT2.

■Operation

- Keep the ON state of the master module and IO-Link module in the robot-side system during operation. In the robot-side system, the master module is connected with the IO-Link module via a port where the fast link-up function is disabled, and thus the time taken to establish data link after power-on will not be shortened.
- To establish data link in a short time, simultaneously power on all of the IO-Link modules in the tool-side system after switching a tool to a different one. If the IO-Link modules are started up at the different timing, it may take longer time to establish data link.
- Connect to a tool (cable connection and power-on) one second or more after the master station detects a disconnection of a tool previously used. If a tool is connected before the detection of a disconnection or within one second after the detection, it may take longer time to establish data link. A disconnection can be detected by monitoring Data link status (each station) (SW00B0 to SW00B7) of the master station.

■Precautions

- After the master station is powered on, it may take longer time to establish data link with each IO-Link module at the first connection.
- Depending on the operating environment, it may take longer time to establish data link.
- If the link scan time of when no tool is connected is long, it may take longer time to establish data link.
- On the network configuration settings, set line topology for the network topology.
- This function shortens the time for data linking between the IO-Link module and master station. However, the module operation start time of the IO-Link module itself will not be shortened. (☞ Page 16 Performance Specifications)

Output HOLD/CLEAR setting function

Whether to hold or clear the last SIO output and output process data can be set when the IO-Link module is disconnected from data link or when the CPU module operating status is STOP.

- HOLD: Outputs the last output process data or SIO output
- CLEAR: Outputs 0 in SIO (source output) mode In IO-Link mode, a notification is issued to the IO-Link device about the output process data being invalid. (Device operation following reception of a notification differs depending on the IO-Link device.)

Operation mode

This function is enabled only in the following operation modes.

- IO-Link (standard) mode
- IO-Link (sink input) mode
- SIO (source output) mode

Output HOLD/CLEAR setting and its operation

When CLEAR or HOLD is set for an output, the output is turned on or off as follows.

ON/OFF status is indicated by CH□ Output data valid flag (RY8 to RYF) in IO-Link mode and by CH□ CQ output signal (RY0 to RY7) in SIO (source output) mode.



Operating status		Output HOLD/CLEAR setting			
		CLEAR		HOLD	
		Last output status OFF	Last output status ON	Last output status OFF	Last output status ON
Data link in operation	CPU module in RUN	OFF	ON	OFF	ON
	CPU module in STOP	OFF	OFF	OFF	ON
	CPU module in PAUSE	OFF	ON	OFF	ON
	CPU module in RESET	OFF	OFF	OFF	ON
	CPU module suspended by error	OFF	OFF	OFF	ON
During disconnection/cyclic stop		OFF	OFF	OFF	ON

Point

- Remote input signal (RX) and remote output signal (RY) will be turned off regardless of this setting if a moderate or major error occurs on the IO-Link module.
- Remote input signal (RX) and remote output signal (RY) will also be turned off regardless of this setting if a channel error occurs.

Setting method

Operating procedure

1. Open the "CC IE Field Configuration" window.
 [Navigation window] ⇒ [Parameter] ⇒ [Module Information] ⇒ [RJ71GF11-T2] ⇒ [Basic Settings] ⇒ [Network Configuration Settings]
2. Open the "Parameter Processing of Device Station" window.
 From the list of stations, select an IO-Link module ⇒ [CC IE Field Configuration] ⇒ [Online] ⇒ [Parameter Processing of Device Station].
3. Set "Method selection" to "Write Parameters".
4. Set "Output HOLD/CLEAR Setting".

Window

	Name	Initial Value	Unit	Read Value	Unit	Write Value
<input checked="" type="checkbox"/>	Output HOLD/CLEAR Setting	0: CLEAR				0: CLEAR ▾
Individual Module Parameters CH1						
<input checked="" type="checkbox"/>	Operation Mode	0: Disabled ...				0: CLEAR
<input checked="" type="checkbox"/>	Device Validation Setting	0: Do not v...				1: HOLD

Displayed items

Item	Setting range
Output HOLD/CLEAR Setting	<ul style="list-style-type: none">• 0: CLEAR (Default value)• 1: HOLD

7.5 Event Acquisition Function

This function notifies of IO-Link device events upon sending of event data from the IO-Link device to the IO-Link module. As with the IO-Link module event history, the event history can be checked using "Command Execution of Device Station". (Page 132 Method for Checking the Event History)

The event acquisition function handles the following two items.

- Notification
- Warning

Point

All types of abnormalities are acquired as errors.

Notification

Set the IO-Link device events set as notification as follows for each channel.

- Not acquire
- Acquire as event



Warning

Set the IO-Link device events set as warning as follows for each channel.

- Not acquire
- Acquire as event
- Acquire as error

Setting method

Operating procedure

1. Open the "CC IE Field Configuration" window.
 [Navigation window] ⇒ [Parameter] ⇒ [Module Information] ⇒ [RJ71GF11-T2] ⇒ [Basic Settings] ⇒ [Network Configuration Settings]
2. Open the "Parameter Processing of Device Station" window.
 From the list of stations, select an IO-Link module ⇒ [CC IE Field Configuration] ⇒ [Online] ⇒ [Parameter Processing of Device Station].
3. Set "Method selection" to "Write Parameters".
4. Set "Event Retrieval Setting".

Window

Name	Initial Value	Unit	Read Value	Unit	Write Value	Unit
Notifications	0: Do not re...					
Warnings	1: Retrieve ...					
<input checked="" type="checkbox"/> Bit Slicing Setting					0: Do not retrieve	
Number of Slicings	0				1: Retrieve as events	

Displayed items

Item	Setting details	
Event Retrieval Setting	Notifications	<ul style="list-style-type: none"> • 0: Do not retrieve (Default value) • 1: Retrieve as events
	Warnings	<ul style="list-style-type: none"> • 0: Do not retrieve • 1: Retrieve as events (Default value) • 2: Retrieve as errors

7.6 Protection Function

The overload protection function and overheat protection function protect the internal circuit from overcurrent and its heat.

Point

The overload protection function and the overheat protection function do not protect external devices but protect the internal circuit of the module.

A problem on a load may raise the internal temperature of the module, causing deterioration in output elements and discoloration on the case and the printed-circuit board. Turn off the corresponding output as soon as a problem on a load is found, and remove the cause.

Overload protection function

Current is cut off when the IO-Link module detects overcurrent. At that time, the following error codes are generated.

- Overcurrent detected in C/Q cable (error code: 180AH)
- Overcurrent detected in L+ cable (error code: 180CH)

Overcurrent detection values and limited currents are as follows.

- C/Q output: 200mA or more per point
- L+ output: 1.6A or more per point

If the load current becomes equal to the overcurrent detection value or lower, the module returns to normal operation.

Overheat protection function

If high heat is detected in the module, C/Q output turns off and a temperature rise error (160°C or more) (error code: 180EH) occurs.

The overheat protection function operates at each point. If the heat descends, the module automatically returns to normal operation.

7.7 External Power Supply Monitoring Function

This function monitors the ON/OFF status of the external power supplies of IO-Link modules.

When an external power supply turns off, an external power supply OFF error (error code: 3006H) occurs.

An external power supply OFF error (error code: 3006H) occurs also when the power-on of the external power supply is not detected within five seconds after the IO-Link module is powered on.

7.8 Device Replacement Function

This function enables device replacement while the power of the IO-Link module is on. With this function, IO-Link devices can be replaced without disconnections being detected. For the IO-Link device replacement procedure, refer to the following.

 Page 189 IO-Link Device Replacement Procedure

Device replacement

When the connected device is an IO-Link device

Provided below is the explanation of the following two cases.

- When replacing a connected IO-Link device with another IO-Link device
- When replacing a connected IO-Link device with an SIO device

■Before replacement

Specify the target channel using "Start Device Changeout" of "Command Execution of Device Station" of the engineering tool. The following occurs when the target channel is specified.

- CH□ Input data invalid flag (RX8 to RXF) for the target channel turns on.
- CH□ LED of the target channel flashes in green.
- CH□ Output process data of the target channel becomes invalid.

Point

Input/output from/to the IO-Link device will be disabled.

■After replacing with another IO-Link device

After replacing with another IO-Link device, specify the target channel using "Device Changeout Complete" of "Command Execution of Device Station" of the engineering tool.

The following occurs after the target channel is specified and the IO-Link device is replaced with another IO-Link device properly.

- CH□ Input data invalid flag (RX8 to RXF) for the target channel turns off.
- CH□ LED of the target channel turns on in green.

Point

Even after replacing with another IO-Link device, input/output from/to the IO-Link device remains disabled until the target channel is specified.

■After replacing with an SIO device

After replacing with an SIO device, specify the target channel using "Device Changeout Complete" of "Command Execution of Device Station" of the engineering tool.

The following occurs after the target channel is specified and the IO-Link device is replaced with an SIO device properly.

- CH□ Input data invalid flag (RX8 to RXF) for the target channel turns off.

Point

- After replacing an IO-Link device with an SIO device, review the program and the parameter settings of the IO-Link module as necessary before specifying the target channel.
- Even after replacing with an SIO device, input/output from/to the SIO device remains off until the target channel is specified.

When the connected device is an SIO device

Provided below is the explanation of the following two cases.

- When replacing a connected SIO device with another SIO device
- When replacing a connected SIO device with an IO-Link device

■Before replacement

Specify the target channel using "Start Device Changeout" of "Command Execution of Device Station" of the engineering tool.

The following occurs when the target channel is specified.

- CH□ Input data invalid flag (RX8 to RXF) for the target channel turns on.

Point

Input/output from/to the SIO device turn off.

■After replacing with another SIO device

After replacing with another SIO device, specify the target channel using "Device Changeout Complete" of "Command Execution of Device Station" of the engineering tool.

The following occurs after the target channel is specified and the SIO device is replaced with another SIO device properly.

- CH□ Input data invalid flag (RX8 to RXF) for the target channel turns off.

Point

Even after replacing with another SIO device, input/output from/to the SIO device remains off until the target channel is specified.

■After replacing with an IO-Link device

After replacing with an IO-Link device, specify the target channel using "Device Changeout Complete" of "Command Execution of Device Station" of the engineering tool.

The following occurs after the target channel is specified and the SIO device is replaced with an IO-Link device properly.

- CH□ Input data invalid flag (RX8 to RXF) for the target channel turns off.
- CH□ LED of the target channel turns on in green.

Point

- After replacing an SIO device with an IO-Link device, review the program and the parameter settings of the IO-Link module and IO-Link device as necessary.
- Input/output from/to the IO-Link device remains disabled until the target channel is specified.

Device replacement start procedure

Operating procedure

1. Open the "CC IE Field Configuration" window.
① [Navigation window] ⇒ [Parameter] ⇒ [Module Information] ⇒ [RJ71GF11-T2] ⇒ [Basic Settings] ⇒ [Network Configuration Settings]
2. Open the "Command Execution of Device Station" window.
① From the list of stations, select an IO-Link module ⇒ [CC IE Field Configuration] ⇒ [Online] ⇒ [Command Execution of Device Station].
3. Set "Method selection" to "Start Device Changeout", specify the target channel in "Write Value", and click the [Execute] button. When "0: All Channels" is selected in "Write Value", the device replacement status of all channels turns on simultaneously.

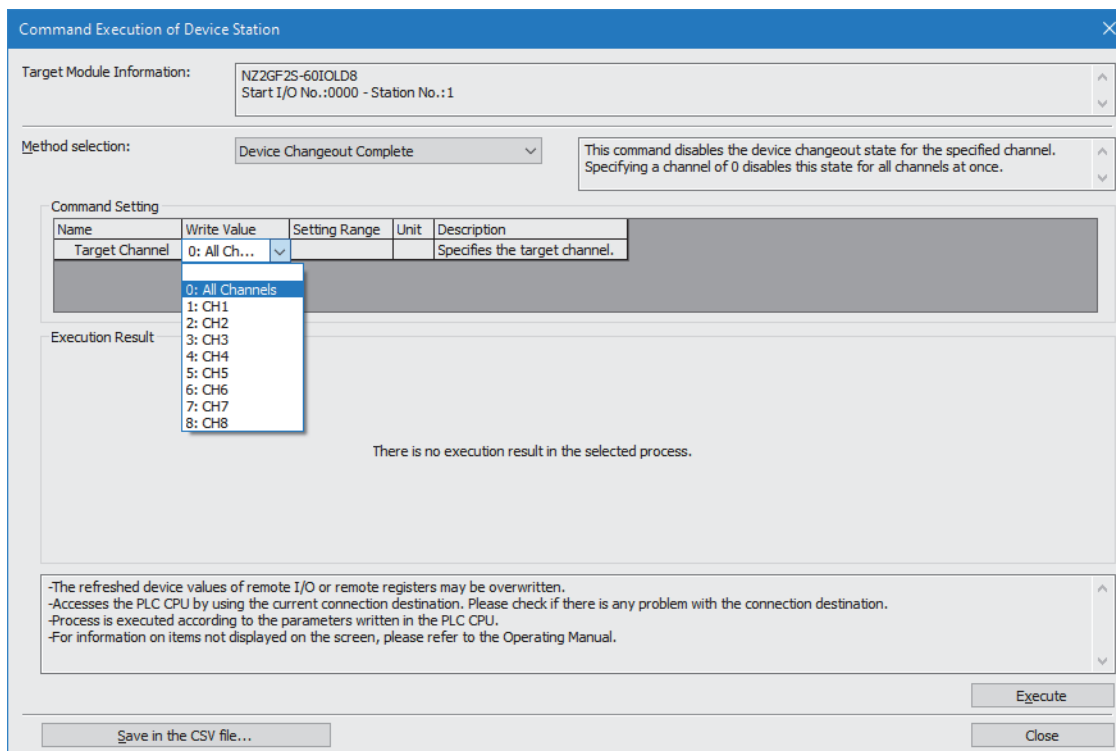

Device replacement completion procedure

Operating procedure

1. Open the "CC IE Field Configuration" window.
 - 🔗 [Navigation window] ⇒ [Parameter] ⇒ [Module Information] ⇒ [RJ71GF11-T2] ⇒ [Basic Settings] ⇒ [Network Configuration Settings]
2. Open the "Command Execution of Device Station" window.
 - 🔗 From the list of stations, select an IO-Link module ⇒ [CC IE Field Configuration] ⇒ [Online] ⇒ [Command Execution of Device Station].
3. Set "Method selection" to "Device Changeout Complete", specify the target channel in "Write Value", and click the [Execute] button. When "0: All Channels" is selected in "Write Value", the device replacement status of all channels turns off simultaneously.

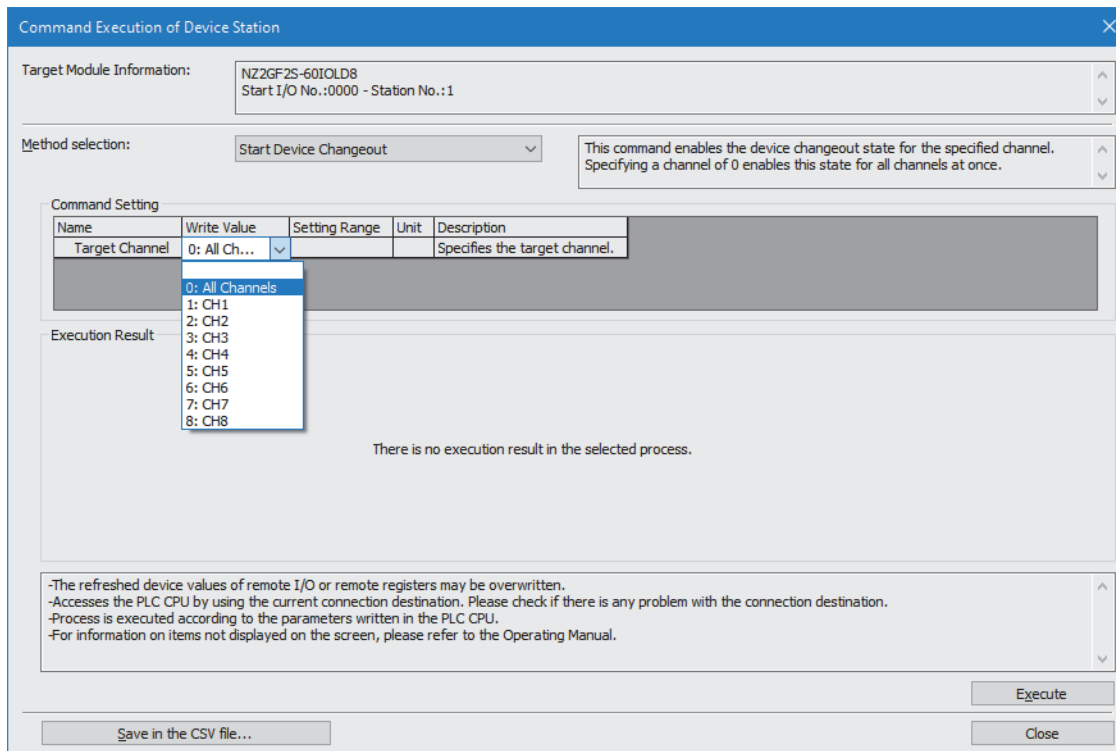

8 FUNCTION BLOCK (FB)

This chapter describes FBs for the IO-Link module.

Using the FBs reduces a load of the user programming and improves the readability of the program.

How to obtain FBs

Please consult your local Mitsubishi Electric representative.

FB details

Depending on the series of the CPU module used, two types of the FB are available. For details on each type, refer to the following.

Series	Manual name	Manual number
MELSEC iQ-R	CC-Link IE Field Network Remote IO-Link Module Function Block Reference (For MELSEC iQ-R)	BCN-P5999-1048
MELSEC-Q/L	CC-Link IE Field Network Remote IO-Link Module Function Block Reference (For MELSEC-Q/L)	FBM-M234

MEMO

9 PROGRAMMING

This chapter describes the programming of the IO-Link module.

9.1 Precautions for Programming

This section describes precautions to create CC-Link IE Field Network programs.

Cyclic transmission program

For a cyclic transmission program, interlock with the following link special relay (SB) and link special register (SW).

- Own station data link status (master station) (SB0049)
- Data link status (each station) (SW00B0 to SW00B7)

For details on the link special relay (SB) and link special register (SW), refer to the user's manual for the master/local module used.

Ex.

Interlock example

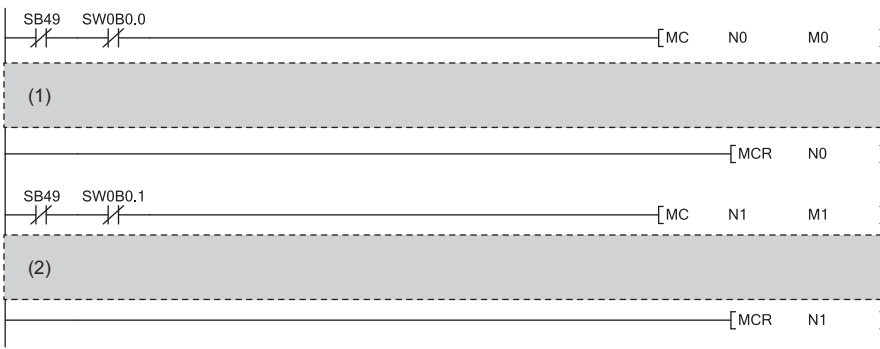

- (1) Communication program with station No.1
- (2) Communication program with station No.2

Transient transmission program

For a transient transmission program, interlock with the following link special relay (SB) and link special register (SW).

- Own station baton pass status (master station) (SB0047)
- Baton pass status (each station) (SW00A0 to SW00A7)

For details on the link special relay (SB) and link special register (SW), refer to the user's manual for the master/local module used.

Ex.

Interlock example

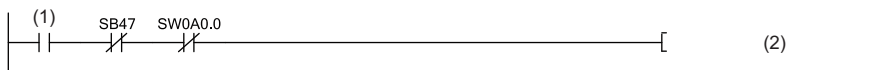

- (1) Start contact
- (2) Dedicated instruction to station No.1

9.2 Example of Program to Communicate with an IO-Link Device

The following describes an example of a program to communicate with an IO-Link device.

System configuration example

■ System configuration

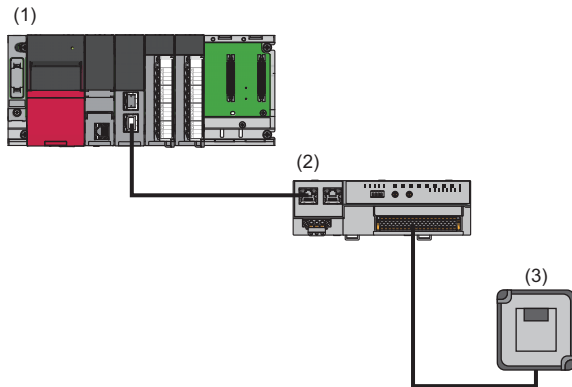

(1) Master station (network No.1, station No.0)

- Power supply module: R61P
- CPU module: R04CPU
- CC-Link IE Field Network master/local module: RJ71GF11-T2 (Start I/O number: 0000H to 001FH)
- Input module: RX40C7 (start I/O number: 0020H to 002FH)
- Output module: RY40NT5P (start I/O number: 0030H to 003FH)

(2) Device station (network No.1, station No.1)

- IO-Link module: NZ2GF2S-60IOLD8

(3) IO-Link device (CH1)

■ Assignment of link devices

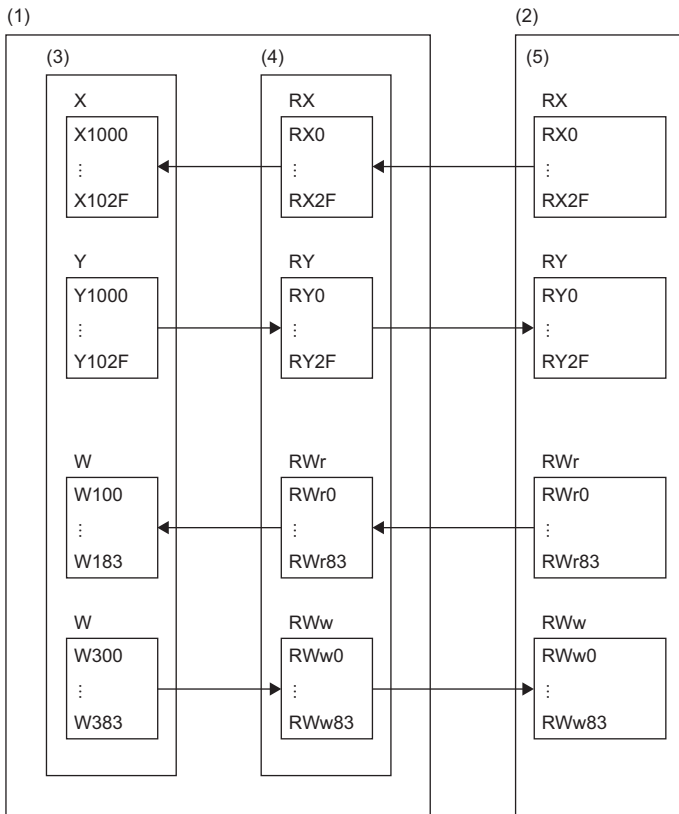

- (1) CC-Link IE Field Network master station
- (2) CC-Link IE Field Network device station
- (3) CPU module
- (4) Master/local module
- (5) IO-Link module

Initial setting description

The following table lists the initial settings of the IO-Link module.

Item		Setting value	
Individual Station Parameters	Input Response Time Setting	5: 10ms	
	Output HOLD/CLEAR Setting	0: CLEAR	
Individual Module Parameters CH1	Operation Mode	1: IO-Link(Standard)Mode	
	Device Validation Setting	0: Do not validate	
	Input Data Mask	0x0000	
	Byte Position Swap	1: Enable	
	Event Retrieval Setting	Notifications	0: Do not retrieve
		Warnings	1: Retrieve as events
	Bit Slicing Setting	Number of Slicings	1
		No. 1Bit Offset/Bit Length	8 ^{*1}
No. 2 to No. 16Bit Offset/Bit Length		0	
Input OFF Delay Setting		0: 0	
Individual Module Parameters CH2 to Individual Module Parameters CH8		Initial value	

*1 Configure the bit slicing setting according to the IO-Link device used.

In this program, input process data from an IO-Link device with the following structure is used as an example.

0  15

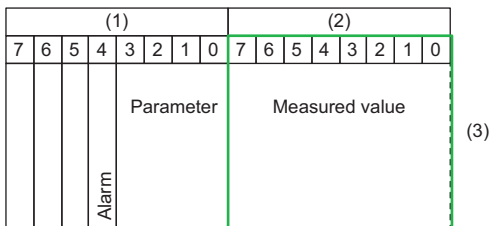

(1) 0 bytes

(2) 1 byte

(3) Input process data

Setting parameters

Connect an engineering tool to the CPU module and set parameters.

1. Configure the CPU module in the following way.

 [Project] ⇒ [New]

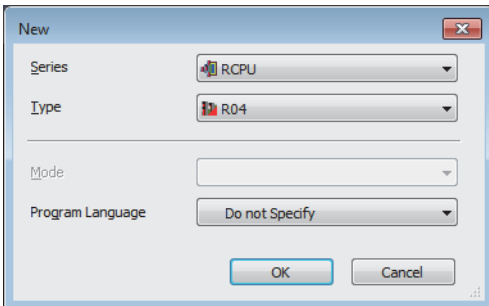

2. Click the [Setting Change] button in the following window and set the item to use module labels.

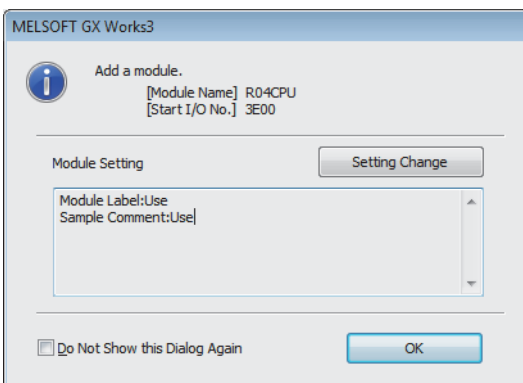

3. Configure the CC-Link IE Field Network master/local module in the following way.

 [Navigation window] ⇒ [Parameter] ⇒ [Module Information] ⇒ Right-click ⇒ [Add New Module]

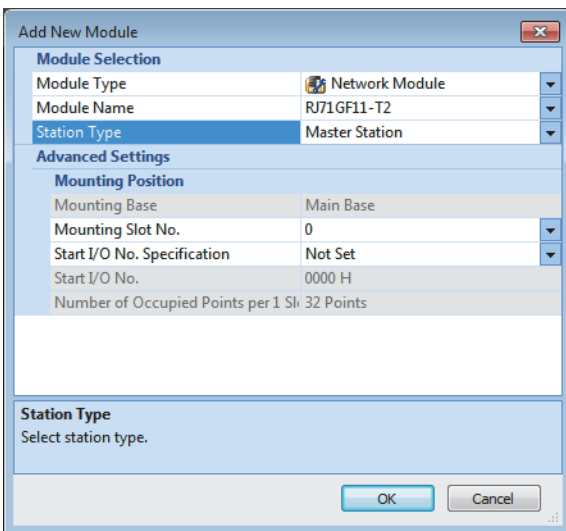

4. Click [OK] button on the following window to add a module label of the CC-Link IE Field Network master/local module.

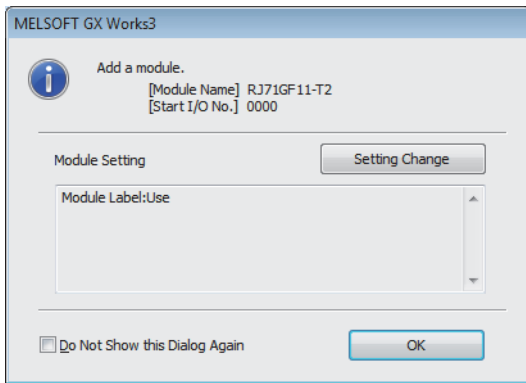

5. Configure "Required Settings" of "Module Parameter" in the following way.

[Navigation window] ⇒ [Parameter] ⇒ [Module Information] ⇒ [RJ71GF11-T2] ⇒ [Required Settings]

Item	Setting
Station Type	
Station Type	Master Station
Network No.	
Network No.	1
Station No.	
Setting Method	Parameter Editor
Station No.	0
Parameter Setting Method	
Setting Method of Basic/Application Settings	Parameter Editor

6. Configure the network in the following way.

[Navigation window] ⇒ [Parameter] ⇒ [Module Information] ⇒ [RJ71GF11-T2] ⇒ [Basic Settings] ⇒ [Network Configuration Settings]

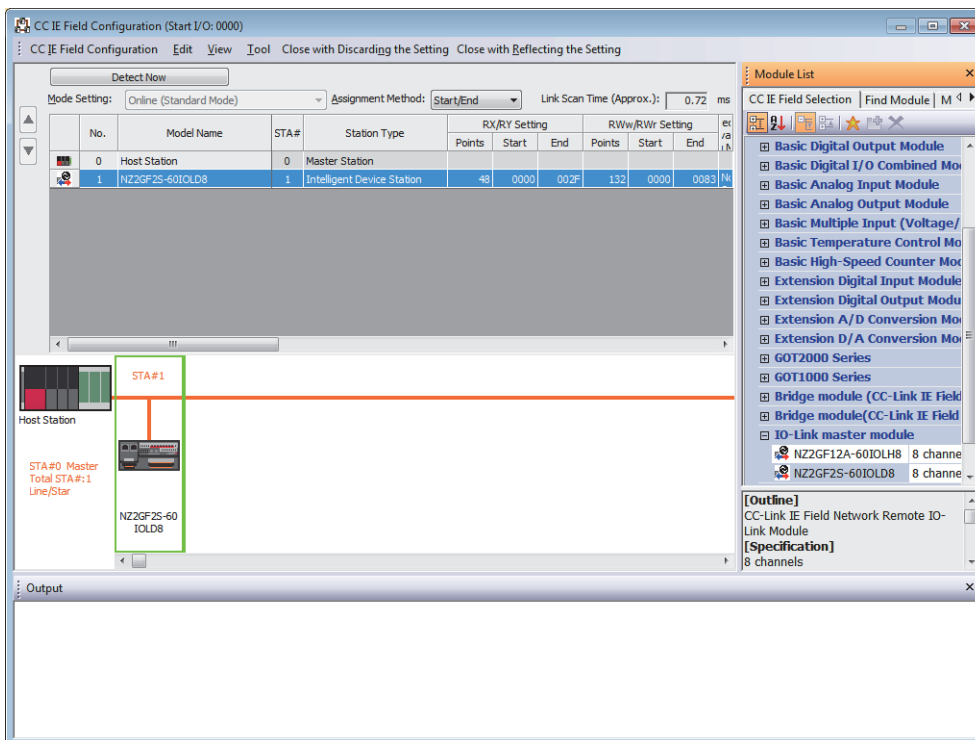

7. Display the "Parameter Processing of Device Station" window.

From the list of stations, select an IO-Link module ⇒ [CC IE Field Configuration] ⇒ [Online] ⇒ [Parameter Processing of Device Station].

8. Set "Method selection" to "Write Parameters".

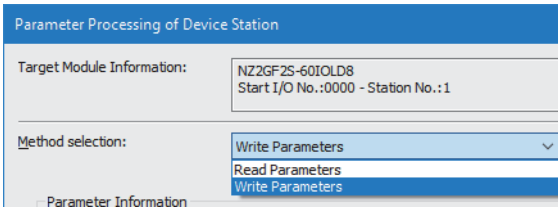

9. Set "Write Value". The following are the procedure.

- Click the title cell of "Initial Value" to select all the items and copy them.
- Click the title cell of "Write Value" to select all the items and paste the copy.
- Select the items to be changed, and set new values according to Initial setting description. (Page 108 Initial setting description)

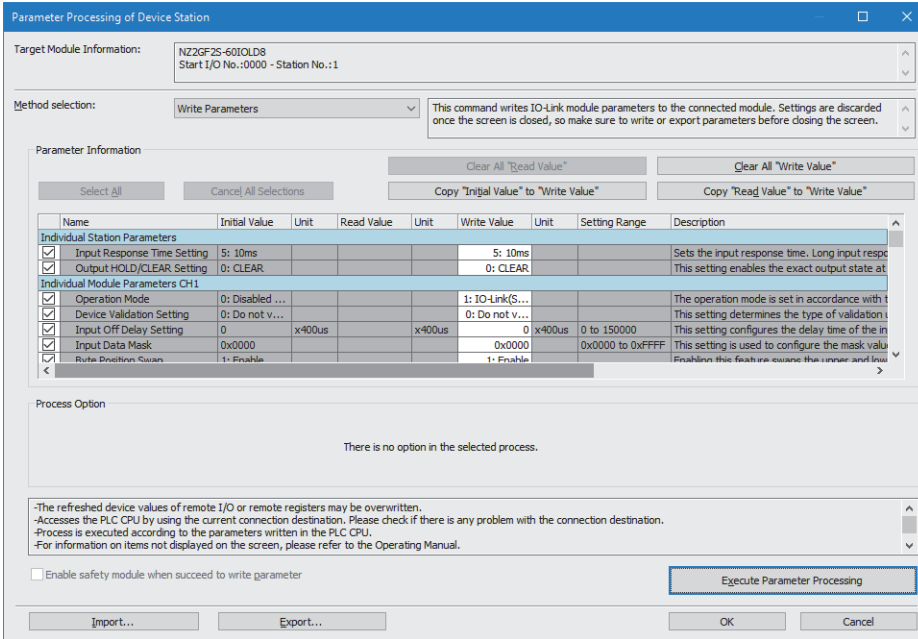

10. Click the [Execute Parameter Processing] button to write the parameter to the IO-Link module.

11. Close the "CC IE Field Configuration" window.

[CC IE Field Configuration] ⇒ [Close with Reflecting the Setting]

12. Display the refresh parameter setting window and configure the setting as follows.

[Navigation window] ⇒ [Parameter] ⇒ [Module Information] ⇒ [RJ71GF11-T2] ⇒ [Basic Settings] ⇒ [Refresh Setting]

No.	Link Side					CPU Side				
	Device Name	Points	Start	End		Target	Device Name	Points	Start	End
-	SB	512	00000	001FF	🔌	Module Label				
-	SW	512	00000	001FF	🔌	Module Label				
1	RX	48	00000	0002F	🔌	Specify Devi	X	48	01000	0102F
2	RY	48	00000	0002F	🔌	Specify Devi	Y	48	01000	0102F
3	RWr	132	00000	00083	🔌	Specify Devi	W	132	00100	00183
4	RWw	132	00000	00083	🔌	Specify Devi	W	132	00300	00383
5					🔌					

13. Write the set parameter to the CPU module of the master station, and reset the CPU module or turn off and on the power supply.

 [Online] ⇌ [Write to PLC]

Point 

In this example, default settings are used for parameters other than the above. For details on parameters, refer to the following.

 Page 43 PARAMETER SETTING

 User's manual for the master/local module used

Program example

Classification	Label name	Description	Device		
Module label	RCPU.stSM.Always_ON	Always ON	SM400		
	GF11_1.bSts_DataLinkError	Own station data link error status	SB0049		
	GF11_1.bnSts_DataLinkError_Station[1]	Data link status (each station) (station No.1)	SW00B0.0		
Defined labels	Define global labels as follows.				
	Label Name	Data Type	Class	Assign (Device/Label)	Consta
1	wInputPDMeasuredValue	Word [Unsigned]/Bit String [16-bit]	VAR_GLOBAL	W104	
2	bInvalidInputFlag	Bit	VAR_GLOBAL	X1008	
3	bConnectionStateFlag	Bit	VAR_GLOBAL	X1020	
4	bErrorClearSwitch	Bit	VAR_GLOBAL	X20	
5	bErrorLamp	Bit	VAR_GLOBAL	Y30	
6	bWarningLamp	Bit	VAR_GLOBAL	Y31	
7	wErrorCodeStorage	Word [Unsigned]/Bit String [16-bit]	VAR_GLOBAL	D100	
8	wWarningCodeStorage	Word [Unsigned]/Bit String [16-bit]	VAR_GLOBAL	D101	
9	bStartDirection	Bit	VAR_GLOBAL	M0	
10	bErrorFlag	Bit	VAR_GLOBAL	W100.A	
11	bRemoteReady	Bit	VAR_GLOBAL	W100.B	
12	bWarningFlag	Bit	VAR_GLOBAL	W100.C	
13	bErrorClearFlag	Bit	VAR_GLOBAL	W300.A	
14	wErrorCode	Word [Unsigned]/Bit String [16-bit]	VAR_GLOBAL	W101	
15	wWarningCode	Word [Unsigned]/Bit String [16-bit]	VAR_GLOBAL	W102	
16	wMeasuredValueStorage	Word [Signed]	VAR_GLOBAL	D200	
17	bExceedThresholdLamp	Bit	VAR_GLOBAL	Y32	
18	GC_ThresholdValue	Word [Signed]	VAR_GLOBAL_CONSTANT		128

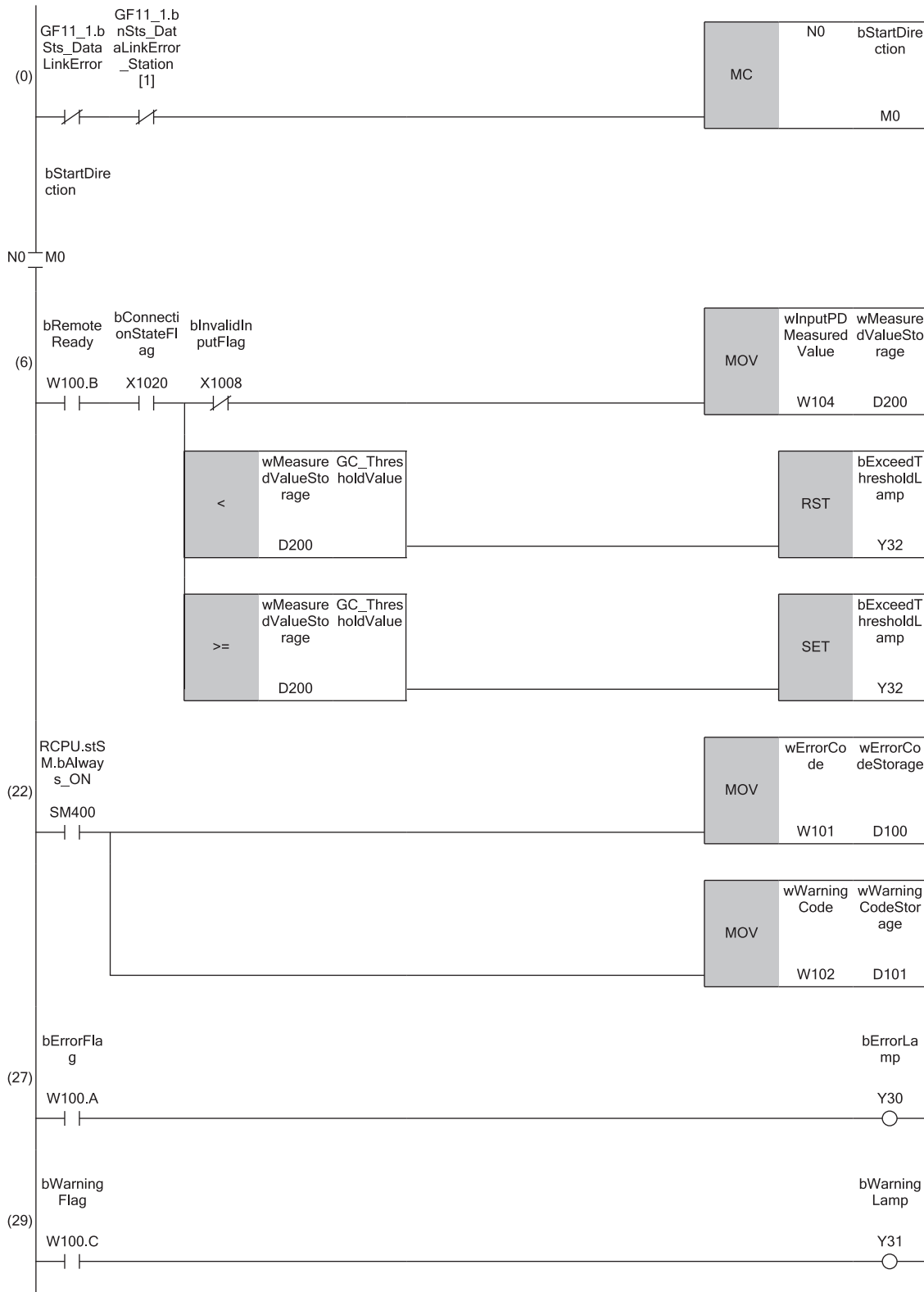

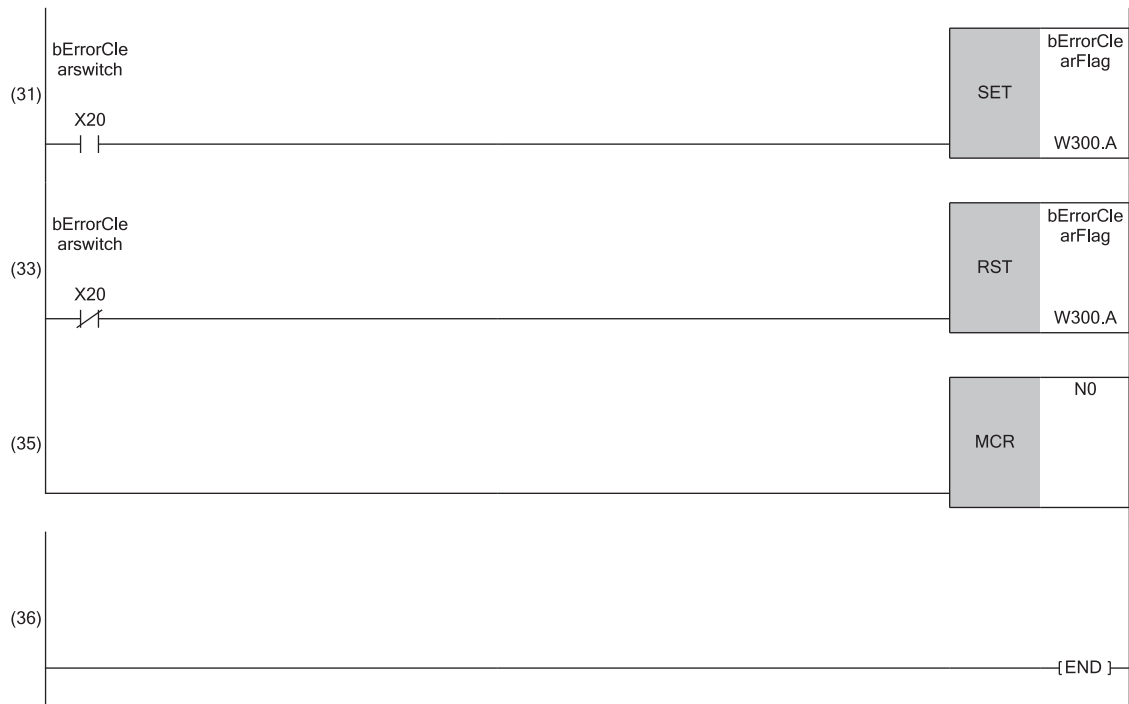

(6) Processing of measured values from the IO-Link device connected to CH1.
 (22), (27), (29), (31), and (33) Processing performed in the event of an error.

9.3 Example of Program to Communicate with SIO Device

The following describes an example of a program to communicate with an SIO device.

System configuration example

■System configuration

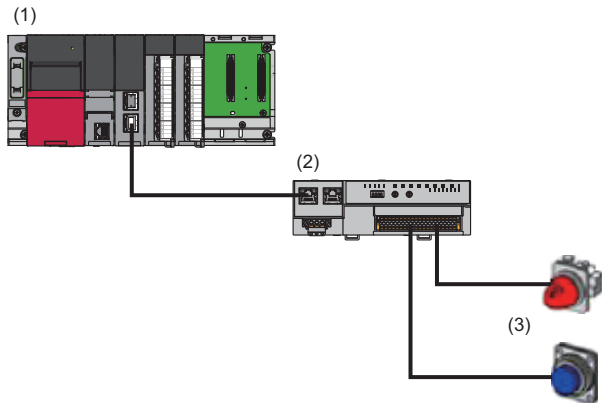

(1) Master station (network No.1, station No.0)

- Power supply module: R61P
- CPU module: R04CPU
- CC-Link IE Field Network master/local module: RJ71GF11-T2 (Start I/O number: 0000H to 001FH)
- Input module: RX40C7 (start I/O number: 0020H to 002FH)
- Output module: RY40NT5P (start I/O number: 0030H to 003FH)

(2) Device station (network No.1, station No.1)

- IO-Link module: NZ2GF2S-60IOLD8

(3) SIO device (CH1: switch, CH8: lamp)

■Assignment of link devices

The assignment of link devices is the same as the example of the program to communicate with an IO-Link device. ()

Page 107 Assignment of link devices)

Initial setting description

The following table lists the initial settings of the IO-Link module.

Item		Setting value	
Individual Station Parameters	Input Response Time Setting	5: 10ms	
	Output HOLD/CLEAR Setting	0: CLEAR	
Individual Module Parameters CH1	Operation Mode	4: SIO(Sync Input)Mode	
	Device Validation Setting	0: Do not validate	
	Input Data Mask	0x0000	
	Byte Position Swap	1: Enable	
	Event Retrieval Setting	Notifications	0: Do not retrieve
		Warnings	1: Retrieve as events
	Bit Slicing Setting	Number of Slicings	0
		No. 1 to No.16Bit Offset/Bit Length	0
Input OFF Delay Setting	0: 0		
Individual Module Parameters CH2 to Individual Module Parameters CH7		Initial value	
Individual Module Parameters CH8	Operation Mode	7: SIO(Source Output)Mode	
	Device Validation Setting	0: Do not validate	
	Input Data Mask	0x0000	
	Byte Position Swap	1: Enable	
	Event Retrieval Setting	Notifications	0: Do not retrieve
		Warnings	1: Retrieve as events
	Bit Slicing Setting	Number of Slicings	0
		No. 1 to No.16Bit Offset/Bit Length	0
Input OFF Delay Setting	0: 0		

Setting parameters

The setting of parameters is the same as the example of the program to communicate with an IO-Link device. (☞ Page 109 Setting parameters)



For details on initial parameter settings, refer to the following.
☞ Page 116 Initial setting description

Program example

Classification	Label name	Description	Device																																																																																
Module label	RCPU.stSM.Always_ON	Always ON	SM400																																																																																
	GF11_1.bSts_DataLinkError	Own station data link error status	SB0049																																																																																
	GF11_1.bnSts_DataLinkError_Station[1]	Data link status (each station) (station No.1)	SW00B0.0																																																																																
Defined labels	Define global labels as follows.																																																																																		
	<table border="1"> <thead> <tr> <th></th> <th>Label Name</th> <th>Data Type</th> <th>Class</th> <th>Assign (Device/Label)</th> </tr> </thead> <tbody> <tr> <td>1</td> <td>bInputSwitch</td> <td>Bit</td> <td>VAR_GLOBAL</td> <td>X1000</td> </tr> <tr> <td>2</td> <td>bInputInvalidFlag</td> <td>Bit</td> <td>VAR_GLOBAL</td> <td>X1008</td> </tr> <tr> <td>3</td> <td>bOutputLamp</td> <td>Bit</td> <td>VAR_GLOBAL</td> <td>Y1007</td> </tr> <tr> <td>4</td> <td>bErrorClearSwitch</td> <td>Bit</td> <td>VAR_GLOBAL</td> <td>X20</td> </tr> <tr> <td>5</td> <td>bErrorLamp</td> <td>Bit</td> <td>VAR_GLOBAL</td> <td>Y30</td> </tr> <tr> <td>6</td> <td>bWarningLamp</td> <td>Bit</td> <td>VAR_GLOBAL</td> <td>Y31</td> </tr> <tr> <td>7</td> <td>wErrorCodeStorage</td> <td>Word [Unsigned]/Bit String [16-bit]</td> <td>VAR_GLOBAL</td> <td>D100</td> </tr> <tr> <td>8</td> <td>wWarningCodeStorage</td> <td>Word [Unsigned]/Bit String [16-bit]</td> <td>VAR_GLOBAL</td> <td>D101</td> </tr> <tr> <td>9</td> <td>bStartDirection</td> <td>Bit</td> <td>VAR_GLOBAL</td> <td>M0</td> </tr> <tr> <td>10</td> <td>bErrorFlag</td> <td>Bit</td> <td>VAR_GLOBAL</td> <td>W100.A</td> </tr> <tr> <td>11</td> <td>bRemoteReady</td> <td>Bit</td> <td>VAR_GLOBAL</td> <td>W100.B</td> </tr> <tr> <td>12</td> <td>bWarningFlag</td> <td>Bit</td> <td>VAR_GLOBAL</td> <td>W100.C</td> </tr> <tr> <td>13</td> <td>bErrorClearFlag</td> <td>Bit</td> <td>VAR_GLOBAL</td> <td>W300.A</td> </tr> <tr> <td>14</td> <td>wErrorCode</td> <td>Word [Unsigned]/Bit String [16-bit]</td> <td>VAR_GLOBAL</td> <td>W101</td> </tr> <tr> <td>15</td> <td>wWarningCode</td> <td>Word [Unsigned]/Bit String [16-bit]</td> <td>VAR_GLOBAL</td> <td>W102</td> </tr> </tbody> </table>		Label Name	Data Type	Class	Assign (Device/Label)	1	bInputSwitch	Bit	VAR_GLOBAL	X1000	2	bInputInvalidFlag	Bit	VAR_GLOBAL	X1008	3	bOutputLamp	Bit	VAR_GLOBAL	Y1007	4	bErrorClearSwitch	Bit	VAR_GLOBAL	X20	5	bErrorLamp	Bit	VAR_GLOBAL	Y30	6	bWarningLamp	Bit	VAR_GLOBAL	Y31	7	wErrorCodeStorage	Word [Unsigned]/Bit String [16-bit]	VAR_GLOBAL	D100	8	wWarningCodeStorage	Word [Unsigned]/Bit String [16-bit]	VAR_GLOBAL	D101	9	bStartDirection	Bit	VAR_GLOBAL	M0	10	bErrorFlag	Bit	VAR_GLOBAL	W100.A	11	bRemoteReady	Bit	VAR_GLOBAL	W100.B	12	bWarningFlag	Bit	VAR_GLOBAL	W100.C	13	bErrorClearFlag	Bit	VAR_GLOBAL	W300.A	14	wErrorCode	Word [Unsigned]/Bit String [16-bit]	VAR_GLOBAL	W101	15	wWarningCode	Word [Unsigned]/Bit String [16-bit]	VAR_GLOBAL	W102		
	Label Name	Data Type	Class	Assign (Device/Label)																																																																															
1	bInputSwitch	Bit	VAR_GLOBAL	X1000																																																																															
2	bInputInvalidFlag	Bit	VAR_GLOBAL	X1008																																																																															
3	bOutputLamp	Bit	VAR_GLOBAL	Y1007																																																																															
4	bErrorClearSwitch	Bit	VAR_GLOBAL	X20																																																																															
5	bErrorLamp	Bit	VAR_GLOBAL	Y30																																																																															
6	bWarningLamp	Bit	VAR_GLOBAL	Y31																																																																															
7	wErrorCodeStorage	Word [Unsigned]/Bit String [16-bit]	VAR_GLOBAL	D100																																																																															
8	wWarningCodeStorage	Word [Unsigned]/Bit String [16-bit]	VAR_GLOBAL	D101																																																																															
9	bStartDirection	Bit	VAR_GLOBAL	M0																																																																															
10	bErrorFlag	Bit	VAR_GLOBAL	W100.A																																																																															
11	bRemoteReady	Bit	VAR_GLOBAL	W100.B																																																																															
12	bWarningFlag	Bit	VAR_GLOBAL	W100.C																																																																															
13	bErrorClearFlag	Bit	VAR_GLOBAL	W300.A																																																																															
14	wErrorCode	Word [Unsigned]/Bit String [16-bit]	VAR_GLOBAL	W101																																																																															
15	wWarningCode	Word [Unsigned]/Bit String [16-bit]	VAR_GLOBAL	W102																																																																															

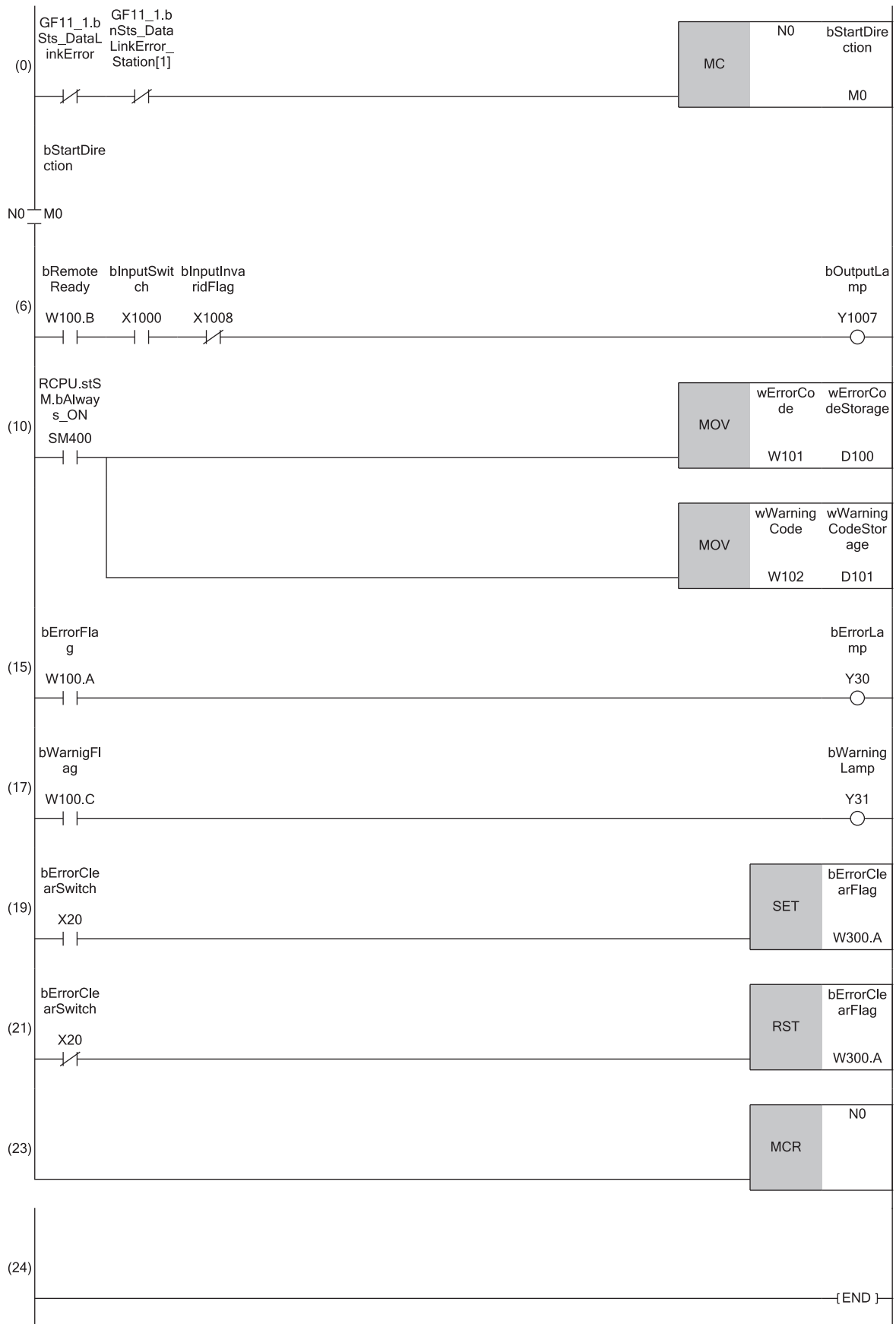

(6) Processing of measured values from SIO devices connected to CH1 and CH8.
 (10), (15), (17), (19), and (21) Processing performed in the event of an error.

10 MAINTENANCE AND INSPECTION

The IO-Link module has no special item to be inspected. However, to maintain the best condition of the system, perform the inspection in accordance with the items described in the user's manual of the CPU module used.

10

MEMO

11 TROUBLESHOOTING

This chapter describes error contents that may occur while the IO-Link module is used and how to troubleshoot.

11.1 Checking the LEDs

This section describes how to troubleshoot the system by the LEDs.

When the PW LED does not turn on

Check item	Action
Is any LED other than the PW LED turned on?	When any LED other than the PW LED turns on, the possible cause is a hardware failure. Please consult your local Mitsubishi representative.
Is the module power supply (24VDC) wired?	Wire the module power supply (24VDC).
Is the module power supply (24VDC) turned on?	Turn on the module power supply (24VDC).
Is the voltage of the module power supply (24VDC) within the specified range?	Set the voltage value within the range of performance specifications.

When the I/O PW LED does not turn on

Check item	Action
Is the external power supply (24VDC) wired?	Wire the external power supply (24VDC).
Is the external power supply (24VDC) turned on?	Turn on the external power supply (24VDC).
Is the voltage of the external power supply (24VDC) within the specified range?	Set the voltage value within the range of performance specifications.

When the RUN LED does not turn on

Check item	Action
Does the voltage of the module power supplied externally reach to the voltage of the specifications?	Check that module power supply voltage is within the range of performance specifications. (☞ Page 16 Performance Specifications)
Has any hardware error occurred?	After the check, power off and on the module. If the RUN LED does not turn on even after the module power supply is turned off and on, the possible cause is a module failure. Please consult your local Mitsubishi representative.

When the MODE LED flashes

Check item	Action
Is the IO-Link module conducting the unit test?	The IO-Link module is conducting the unit test. The MODE LED turns off when the unit test is finished. Take corrective action according to the result of the unit test. (☞ Page 124 Unit Test)

When the MODE LED is off

Check item	Action
Has the IO-Link module finished the unit test?	The IO-Link module has finished the unit test. Take corrective action according to the result of the unit test. (☞ Page 124 Unit Test)

When the D LINK LED turns off

Check item	Action
Is the IO-Link module connected to the network and operating properly?	Refer to the troubleshooting for when the LINK LED is off. (☞ Page 123 When the LINK LED is off)
Are 1000BASE-T-compliant Ethernet cables used?	Replace the cable with a 1000BASE-T-compliant Ethernet cable. (☞ User's manual for the master/local module used)
Is the station-to-station distance 100m or less?	Change the station-to-station distance to 100m or less.
Does the cabling condition (bending radius) meet the specifications?	Refer to the manual for the Ethernet cable used, and correct the bending radius.
Is any Ethernet cable disconnected?	Replace the Ethernet cable.
Do other stations connected to the IO-Link module normally operate?	Check that the power supplies of the stations are on.
Does the switching hub normally operate?	<ul style="list-style-type: none"> • Check that a 1000BASE-T-compliant switching hub is used. (☞ User's manual for the master/local module used) • Check that the power supply of the switching hub is turned on.
Is the station number of the IO-Link module shared by other stations?	Change the setting so that all the station numbers are different.

When the D LINK LED flashes

Check item	Action
Does the station number setting of the IO-Link module match the station number of the IO-Link module that has been set in the network configuration settings of the master station or in the CC IE Field Configuration?	Match the station number of the IO-Link module with the station number set by the network configuration settings of the master station or by the CC IE Field Configuration.
Is the station type set to intelligent device station?	In the network configuration settings of the master station, set the station type to intelligent device station.
Is the module a reserved station?	Change the setting of reserved/error invalid station to other than the reserved station in the network configuration settings of the master station.
Is the station number setting switch set to any value other than 1 to 120?	Change the setting within the range from 1 to 120.
Is stop of the data link checked through CC-Link IE Field Network diagnostics?	Check the link status through CC-Link IE Field Network diagnostics and start the link when the data link is stopped.
Has the connection been changed to the other master station with a different network number?	<ul style="list-style-type: none"> • Correct the connection to the previous master station. • To communicate with a master station with a different network number, power off and on the IO-Link module.

When the ERR. LED flashes or turns on

Check item	Action
Has any error occurred?	Identify the error factor of the IO-Link module with the engineering tool to take the corrective action. (☞ Page 129 Checking for the Error Codes and the Warning Codes)

When the L ER LED turns on

Check item	Action
Are Ethernet cables normal?	<ul style="list-style-type: none"> • Check that 1000BASE-T-compliant Ethernet cables are used. (📖 User's manual for the master/local module used) • Check that the station-to-station distance is 100m or less. • Check that the Ethernet cables are not disconnected.
Does the switching hub in the system normally operate?	<ul style="list-style-type: none"> • Check that a 1000BASE-T-compliant switching hub is used. (📖 User's manual for the master/local module used) • Check that the power supply of the switching hub is turned on.
Do other stations connected to the IO-Link module normally operate?	Check that the power supplies of the stations are on.
Is there any noise affecting the system?	Check the status of wiring. Ground the control panel with the module installed in it.*1
Is the loopback function enabled for the master station?	When the loopback function is enabled, check that the ring topology is correctly configured for the PORT where the L ER LED is on. (📖 User's manual for the master/local module used)

*1 When an IO-Link module is installed in a control panel, the control panel is electrically connected to the FG terminal of the module via the DIN rail.

Therefore, if the control panel is not grounded, noise may go into the FG terminal from the control panel via the DIN rail.

When the LINK LED is off

Check item	Action
Are Ethernet cables normal?	<ul style="list-style-type: none"> • Check that 1000BASE-T-compliant Ethernet cables are used. (📖 User's manual for the master/local module used) • Check that the station-to-station distance is 100m or less. • Check that the Ethernet cables are not disconnected.
Do the switching hub and other stations in the system normally operate?	<ul style="list-style-type: none"> • Check that a 1000BASE-T-compliant switching hub is used. (📖 User's manual for the master/local module used) • Check that the power supplies of the switching hub and other stations are turned on.
Are the statuses of the fast link-up functions of the modules connected to each other the same (enabled or disabled)?	For the ports connected to each other, set the same state (enable/disable) for the fast link-up function. And then power off and on the modules. In addition, disable the fast link-up function for the port that is to be connected to the port where the fast link-up function is not supported.
For the modules to be connected to each other with the fast link-up function being enabled, are PORT1 and PORT2 connected with a cable?	Connect PORT1 and PORT2 with a cable when connecting modules where the fast link-up function is enabled.

Point

If link-up processing is repeated due to a condition of a device on the line, it may take a longer time for the LINK LED to turn on.

This symptom may be eliminated by connecting the Ethernet cable to a different module PORT. (example: PORT1 → PORT2)

When CH1 to CH8 ERR. LEDs turn on

Check item	Action
Has any error occurred?	Identify the error factor of the IO-Link module with the engineering tool to take the corrective action. (📖 Page 129 Checking for the Error Codes and the Warning Codes)

11.2 Unit Test

Check for an IO-Link module hardware failure.

Operating procedure

1. Power off the IO-Link module and external power supply.
2. Connect the PORT1 and PORT2 connectors of the IO-Link module with an Ethernet cable.
3. Set the station number setting switch as follows.
 - ×10: TEST
 - ×1: 0
4. Power on the IO-Link module and external power supply.
5. Unit test begins.

The MODE LED flashes while the unit test is being executed.

Do not turn off the external power supply during the unit test.

If the MODE LED is still flashing 30 seconds after the start of the unit test, check the I/O PW LED. If the I/O PW LED is off, power on the external power supply. If the I/O PW LED is on, an IO-Link module hardware failure may exist. Please consult your local Mitsubishi representative.

6. The MODE LED turns off when the unit test finishes successfully.
 - When the test finishes successfully, the ERR. LED remains off and does not turn on.
 - If the test fails, the ERR. LED turns on. If the unit test fails, check the I/O PW LED. If the I/O PW LED is off, check whether the voltage of the external power supply is correct. Perform rewiring if necessary and run the test again. If the I/O PW LED is on, replace the Ethernet cable and run the test again. If the test fails again, an IO-Link module hardware failure may exist. Please consult your local Mitsubishi representative.

Point

When unit test fails, the error details can be checked in the error history.

To check the error history, reset the station number setting switch of the IO-Link module from TEST and connect the module to the master station with an Ethernet cable.

For error history, refer to the following.

 Page 129 Checking for the Error Codes and the Warning Codes

 Page 178 Current error data

11.3 Troubleshooting by Symptom

This section describes troubleshooting by symptom.

Perform troubleshooting by symptom when the IO-Link module does not operate properly even though no errors exist on the IO-Link module. If an error occurs on the IO-Link module, identify the cause of the error using the engineering tool.

When process data cannot be written in IO-Link mode

Check item	Action
Is Remote READY (RWr0.b11) on?	Check that Operating condition setting request flag (address: 2D07H) is off. If Operating condition setting request flag (address: 2D07H) is on, turn it off and check that Remote READY (RWr0.b11) is on. ☞ Page 155 Remote READY (RWr0.b11)
Is CH□ IO-Link device connection status flag (RX20 to RX27) on?	Reconnect the IO-Link device properly. For IO-Link device connection methods, refer to the following. ☞ Page 39 Wiring of IO-Link terminal block and external devices
Are there any IO-Link device parameter downloading failure events in the event history?	Reconnect the IO-Link device connected to the channel in which the IO-Link device parameter downloading failure event occurred.
Are there any IO-Link device parameter uploading failure events in the event history?	Reconnect the IO-Link device connected to the channel in which the IO-Link device parameter uploading failure event occurred.
Are there any IO-Link device access failure events in the event history?	Check that the data storage function of the IO-Link device is not locked, referring to the IO-Link device manual. If it is locked, unlock it and reconnect the IO-Link device.
Are there any data storage buffer overflow events in the event history?	Reconnect the IO-Link device that sends parameters of a size compliant with the IO-Link standards to the channel in which the data storage buffer overflow event occurred.
Is CH□ Input data invalid flag (RX8 to RXF) off?	Check whether a channel error has occurred. Refer to the manual of the IO-Link device connected to that channel and eliminate the error. Also, check whether Device replacement status (address: 299DH) is off. If Device replacement status (address: 299DH) is on, specify the relevant channel in "Write Value" of "Device Changeout Complete" of "Command Execution of Device Station". ☞ Page 99 Device Replacement Function
Is Device replacement status (address: 299DH) off?	Input and output are disabled during device replacement. Specify the relevant channel in "Write Value" of "Device Changeout Complete" of "Command Execution of Device Station". ☞ Page 99 Device Replacement Function
Is the channel in the correct operation mode?	Set "Operation Mode" of the channel to "1: IO-Link(Standard)Mode" or "2: IO-Link(Sync Input)Mode" depending on the mode of the connected IO-Link device.
Is the swap function set correctly?	Set "Byte Position Swap" to "1: Enabled" or "0: Disabled" according to application requirements.
Is the bit segment function set correctly?	Set "Bit Slicing Setting" correctly.
Is the refresh device set correctly?	Check the refresh parameter and correct the setting of the refresh device so that it matches with the setting in the program. For the setting of the refresh parameters, refer to the following. ☞ User's manual for the master/local module used
Is the output process data written to the remote register?	Write the output process data to CH□ output process data (RWw4 to RWw83) on the engineering tool monitor.
Is CH□ Output data valid flag (RY8 to RYF) on?	After writing the output process data to CH□ Output process data (RWw4 to RWw83), turn on CH□ Output data valid flag (RY8 to RYF).

When the ON/OFF status of an external input cannot be read in SIO mode

Check item	Action
Does the CH□ LED of the relevant channel of the IO-Link module turn on when the external input device turns on?	If the LED does not turn on, there is a problem on the input wiring. Check the wiring confirming that the input wiring is not disconnected or short-circuited, or the voltage of the input signal is correct. For details on the rated input voltage, refer to the following. ☞ Page 16 Performance Specifications
Is Remote READY (RWr0.b11) on?	Check that Operating condition setting request flag (address: 2D07H) is off. If Operating condition setting request flag (address: 2D07H) is on, turn it off and check that Remote READY (RWr0.b11) is on. ☞ Page 181 Operating condition setting request flag, Page 183 Operating condition setting completion flag
Is Device replacement status (address: 299DH) off?	Input is off during device replacement. Specify the relevant channel in "Write Value" of "Device Changeout Complete" of "Command Execution of Device Station". ☞ Page 99 Device Replacement Function
Is the refresh device set correctly?	Check the refresh parameter and correct the setting of the refresh device so that it matches with the setting in the program. For the setting of the refresh parameters, refer to the following. ☞ User's manual for the master/local module used
Is the operation mode set correctly?	Check that the operation mode matches that of the external input device, and correct it if necessary. For details on the operation mode setting, refer to the following. ☞ Page 168 Operation mode setting
Is the input OFF delay function used correctly?	When the input OFF delay function is enabled, Remote input signal (RX) turns off after the delay time passes following OFF of an external device. Disable the input OFF delay function or change the setting of the delay time. ☞ Page 83 Input OFF delay function

When the ON/OFF status of an external output cannot be changed in SIO mode

Check item	Action
Does the CH□ LED of the relevant channel of the IO-Link module turn on when CH□ CQ output signal (RY0 to RY7) turns on?	There is a problem with output wiring. Check the wiring confirming that the output wiring is not disconnected or short-circuited.
Is Remote READY (RWr0.b11) on?	Check that Operating condition setting request flag (address: 2D07H) is off. If Operating condition setting request flag (address: 2D07H) is on, turn it off and check that Remote READY (RWr0.b11) is on. ☞ Page 181 Operating condition setting request flag, Page 183 Operating condition setting completion flag
Is Device replacement status (address: 299DH) off?	Output is off during device replacement. Specify the relevant channel in "Write Value" of "Device Changeout Complete" of "Command Execution of Device Station". ☞ Page 99 Device Replacement Function
Is the refresh device set correctly?	Check the refresh parameter and correct the setting of the refresh device so that it matches with the setting in the program. For the setting of the refresh parameters, refer to the following. ☞ User's manual for the master/local module used
Is the operation mode set correctly?	Check that the operation mode matches that of the external output device, and correct it if necessary. For details on the operation mode setting, refer to the following. ☞ Page 168 Operation mode setting

When parameters cannot be read or written

When reading/writing parameters or the CC-Link IE Field Network diagnostics fails, check the following using the engineering tool.

Check item	Action
Is the version of the engineering tool supported?	Please consult your local Mitsubishi representative.
Do the setting of the network parameter and that of the CPU module match?	Perform PLC verification on the network parameter to check those settings. When they are not matched, perform reading and writing and match the network parameter settings with those of the module and write the module parameter of the device station.

11.4 Examples of Troubles with IO-Link Modules

Troubleshooting for input circuit

This section describes the troubleshooting for input circuit.

A signal incorrectly inputs data

■Cause

Noise is taken as input data.

■Action

- To prevent excessive noise, avoid installing power cables together with I/O cables.
- Connect surge absorbers to noise-generating devices such as relay and conductors using the same power supply or take other noise reduction measures.

Troubleshooting for output circuit

This section describes the troubleshooting for output circuit.

A load momentarily turns on from off when the system is powered off

■Cause

When an inductive load is connected, the load [2] may turn on from off due to a sneak current of back EMF at the time of shutoff [1].

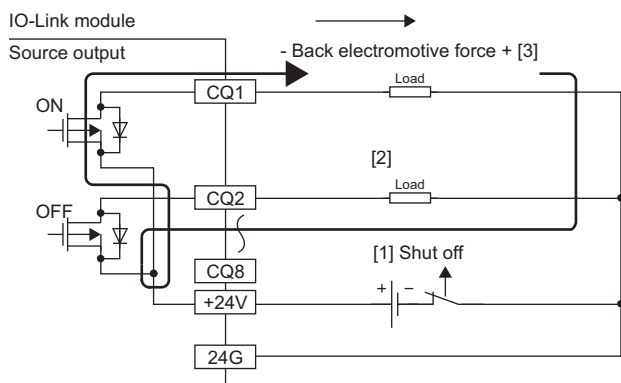

■Action

To suppress the back EMF, connect a diode parallel to the load where the back EMF is generated in [3].

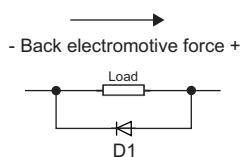

D1 is as follows.

Reverse voltage VR (VRM)^{*1}

Forward current IF (IFM)^{*2}

*1 Approximately 10 times as large as the rated voltage in the specifications

Example: 24VDC → Approximately 200V

*2 Twice as much as the maximum load current (common) in the specifications or more

Example: 2A/1 common → 4A or more

When output is turned on, load connected to other outputs is turned on simultaneously

■Cause

When a non-wiring state occurs due to, for example, a shutoff or disconnection between 0V of the external power supply and the common of a load, a current flows across the load that is off through an unexpected circuit of the output element that is off. Continuous use in the following state may cause failure.

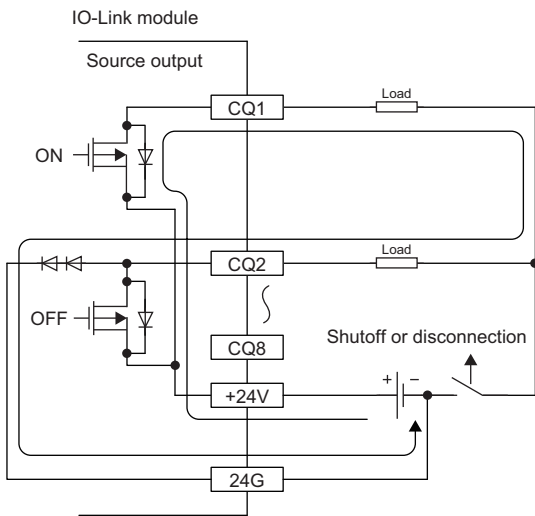

■Action

Connect the external power supply with the load correctly.

To prevent the state described above, install diodes in each output terminal as shown below.

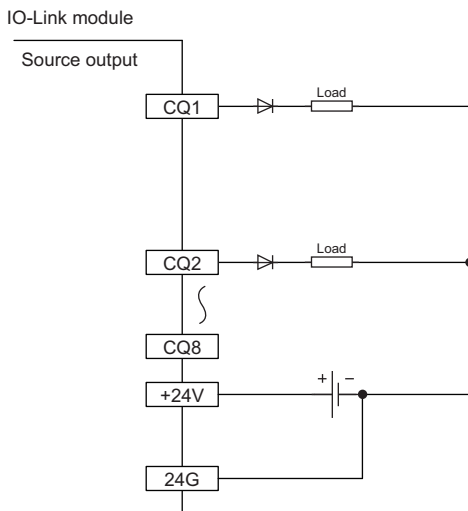

11.5 Checking for the Error Codes and the Warning Codes

Error codes can be checked by any of the following methods:

- ☞ Page 129 Checking by executing a command of the device station
- ☞ Page 131 Checking by Error code (RWr1)

Warning codes can be checked by any of the following methods:

- ☞ Page 129 Checking by executing a command of the device station
- ☞ Page 131 Checking by Warning code (RWr2)

Point

Reading of error history from CC-Link IE Field Network diagnostics is not supported. An error message is displayed if "Error History" is selected from CC-Link IE Field Network diagnostics.

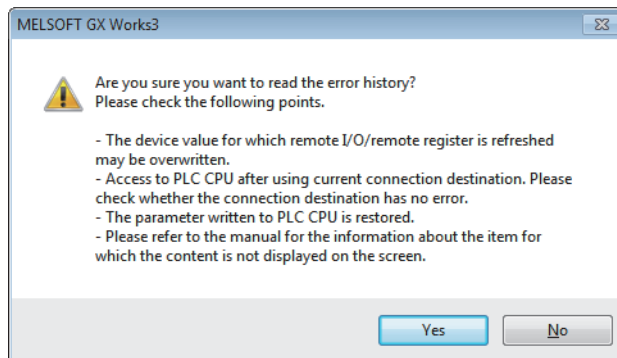

Checking by executing a command of the device station

This section describes how to check the errors by executing a command of the device station.

Operating procedure

1. Select the IO-Link module in List of stations in the "CC IE Field Configuration" window.

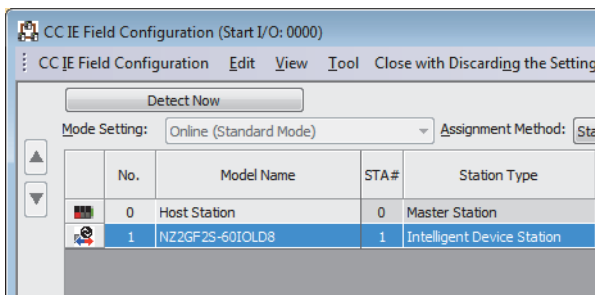

2. Open the "Command Execution of Device Station" window.

☞ [CC IE Field Configuration] ⇒ [Online] ⇒ [Command Execution of Device Station]

3. Set "Method selection" to "Read Current Errors" and click the [Execute] button. Follow the instructions displayed in the window, and the current error of the IO-Link module will be displayed in "Execution Result".

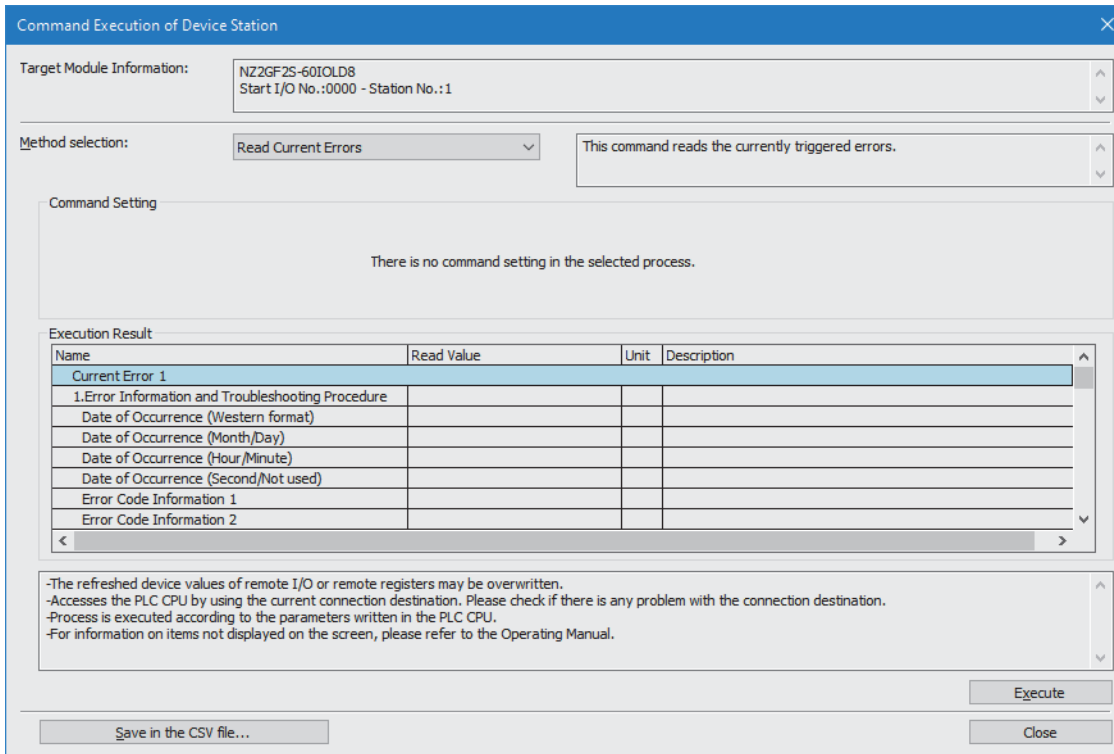

Displayed items

Item	Contents
Error Information and Troubleshooting Procedure	The action for the error is displayed.
Date of Occurrence (Western format) ^{*1}	The date and hour of error occurrence is displayed. (When the tens place of month, hour, and second is 0, 0 is omitted.)
Date of Occurrence (Month/Day) ^{*1}	
Date of Occurrence (Hour/Minute) ^{*1}	
Date of Occurrence (Second/Not Used) ^{*1}	
Error Code Information 1 ⋮ Error Code Information 3	Values of Error code details 1 to 3 of the remote buffer memory are stored when an error occurs.

*1 "Date of Occurrence" of the current error is based on the clock information acquired from the CPU module of the master station. If an error occurs without data link establishment with the master station, the error time is not recorded because the IO-Link module does not have clock information used as the reference.

Point

- The current error can be read from a program. Refer to the remote buffer memory address where the error history is stored. (📖 Page 178 Current error data)
- Up to 16 current errors (15 minor/moderate errors and one major error) are recorded. When 15 minor and moderate errors have occurred, new minor and moderate errors that occur are held in the IO-Link module.
- If the same error occurs continuously, only the error that occurred first is stored.
- Even after the power of the module is turned off and on, the error history remains.
- To initialize the current error, set "Method selection" to "Clear Current Error" in the "Command Execution of Device Station" window and click the [Execute] button after eliminating the cause of the error. Although the error can be cleared temporarily even if "Clear Current Error" is executed without eliminating the error cause, the error will be detected again and stored in as current errors.

Checking by Error code (RWr1)

Check the latest error code with the remote register of the master/local module.

Ex.

When the refresh target device for Error code (RWr1) is W101

Operating procedure

[Online] ⇒ [Monitor] ⇒ [Device/Buffer Memory Batch Monitor]

Window

The screenshot shows the 'Device/Buffer Memory Batch Monitor' window. The 'Device Name' is set to 'W101'. Below the controls is a table with columns for bit positions F through 0 and a 'Current Value' column. The bit for position 1 is highlighted in blue, indicating it is set to 1.

Device Name	F	E	D	C	B	A	9	8	7	6	5	4	3	2	1	0	Current Value
W101	0	0	0	1	0	0	0	0	0	0	0	0	0	1	1	0	12294
W102	0	0	0	0	0	0	0	0	0	0	0	0	0	0	0	0	0
W103	0	0	0	0	0	0	0	0	0	0	0	0	0	0	0	0	0

Checking by Warning code (RWr2)

Check the latest warning code with the remote register of the master/local module.

Ex.

When the refresh target device for Warning code (RWr2) is W102

Operating procedure

[Online] ⇒ [Monitor] ⇒ [Device/Buffer Memory Batch Monitor]

Window

The screenshot shows the 'Device/Buffer Memory Batch Monitor' window. The 'Device Name' is set to 'W102'. Below the controls is a table with columns for bit positions F through 0 and a 'Current Value' column. The bit for position 1 is highlighted in blue, indicating it is set to 1.

Device Name	F	E	D	C	B	A	9	8	7	6	5	4	3	2	1	0	Current Value
W102	0	0	0	0	1	0	0	0	0	0	0	0	0	0	1	0	6146
W103	0	0	0	0	0	0	0	0	0	0	0	0	0	0	0	0	0
W104	0	0	0	0	0	0	0	0	0	0	0	0	0	0	0	0	0

11.6 Method for Checking the Event History

The event history can be checked using "Command Execution of Device Station".

Operating procedure

1. Select the IO-Link module in List of stations in the "CC IE Field Configuration" window.

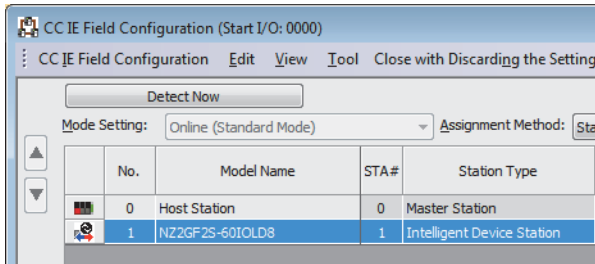

2. Open the "Command Execution of Device Station" window.

[CC IE Field Configuration] ⇒ [Online] ⇒ [Command Execution of Device Station]

3. Set "Method selection" to one of the following and click the [Execute] button.

- Read Event History Entries (1 - 40)
- Read Event History Entries (41 - 80)
- Read Event History Entries (81 - 120)
- Read Event History Entries (121 - 160)
- Read Event History Entries (161 - 200)

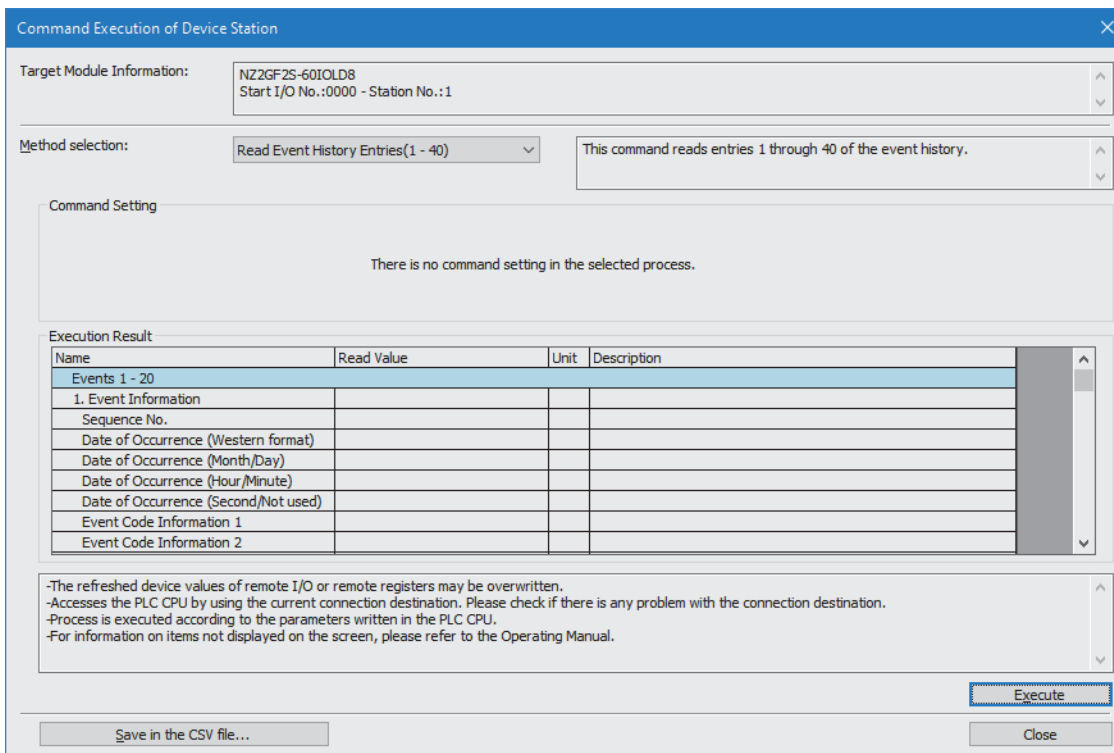

4. Follow the instructions displayed in the window, and the event history of the IO-Link module will be displayed in "Execution Result".

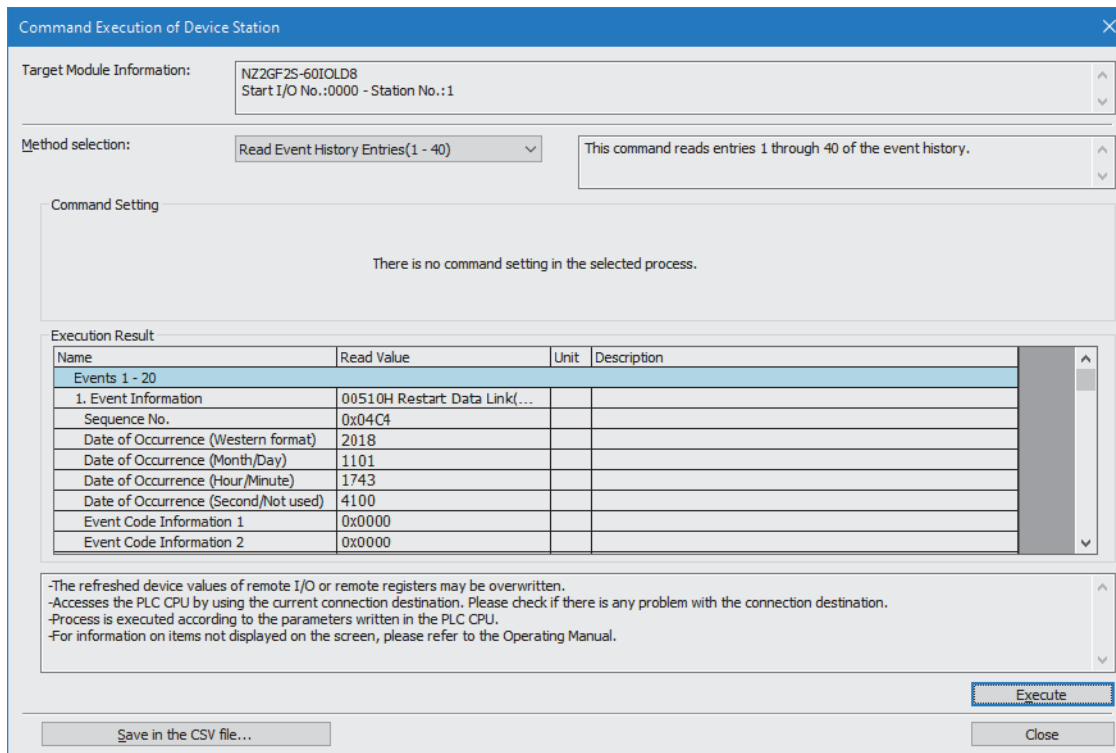

Displayed items

Item	Contents
Event Information	Details of the event and corrective actions are displayed.
Sequence No.	Events are displayed in order of occurrence. (A value between 0 and 65535 is stored.) Counting starts from 1 and goes up to 65535 before resetting to 0. If the event history is cleared, the count returns to 1.
Date of Occurrence (Western format)*1	Events are displayed in date and time of occurrence. (When the tens place of Month, Hour, and Second is 0, 0 is omitted.)
Date of Occurrence (Month/Day)*1	
Date of Occurrence (Hour/Minute)*1	
Date of Occurrence (Second/Not Used)*1	
Event Code Information 1 : Event Code Information 3	Event code detailed information is stored.

*1 "Data of Occurrence" of the event is based on the clock information acquired from the CPU module of the master station. If an event occurs without data link establishment with the master station, the event time is not recorded because the IO-Link module does not have clock information used as the reference.

Point

- The event history can be read from a program. Refer to the remote buffer memory address where the event history is stored. (☞ Page 180 Event data)
- The event history records up to 200 events. When more than 200 events occur, events are deleted from the oldest.
- Both IO-Link module and IO-Link device events are stored.
- Even after the module is powered off and on, the event history remains.
- To initialize the event history, set "Method selection" to "Clear Event History" in the "Command Execution of Device Station" window and click the [Execute] button.

11.7 Error Codes and Warning Codes

This section describes error codes and warning codes.

Point 

If an error not described in this manual occurs on an IO-Link device, refer to the manual of the IO-Link device used.

List of error codes and the warning codes

The error codes and warning codes are classified into the following three types.

Classification		Description
Error code	Major error	An error that cannot be recovered
	Moderate error	An error where the module cannot continue to operate
Warning code	Minor error	An error where the module can continue to operate

(1) Disabled mode, (2) IO-Link mode, (3) SIO mode, (4) Power supply mode

○: Detection possible, ×: Detection not possible

Error code (hexadecimal)	Classification	Error name	Description and cause	Action	Errors detectable in each operation mode			
					(1)	(2)	(3)	(4)
1800H	Minor error	Non-volatile memory error (event history)	The event history stored on the non-volatile memory was lost.	If the same error occurs frequently, a module hardware failure exists. Please consult your local Mitsubishi representative and explain the symptom in details.	○	○	○	○
1802H	Minor error	Station number switch changed error	The station number setting switches have been changed with the module power on.	Reset the station number setting switch to the original setting.	○	○	○	○
1804H	Minor error	Function setting switch 1 changed error	The function setting switch 1 has been changed with the module power supply on.	Reset the switch to the setting before the change.	○	○	○	○
1805H	Minor error	Function setting switch 2 changed error	The function setting switch 2 has been changed with the module power supply on.	Reset the switch to the setting before the change.	○	○	○	○
1806H ^{*1}	Minor error	Disconnection error	A status in which communication cannot be established with IO-Link devices due to disconnection.	Check the connection. If the same error is shown again, a device failure may exist.	×	○	×	×
1808H ^{*1}	Minor error	Device validation error	Device validation results show that an IO-Link device not compatible with other IO-Link devices or the one which has no identity is installed.	<ul style="list-style-type: none"> Check the device validation data registered to the IO-Link module and the device validation data held by the currently connected IO-Link device using "Read Device Validation Data" of "Command Execution of Device Station" and connect an IO-Link device that matches. Change the device validation settings and reconnect the IO-Link device. 	×	○	×	×

Error code (hexadecimal)	Classification	Error name	Description and cause	Action	Errors detectable in each operation mode			
					(1)	(2)	(3)	(4)
1809H ¹	Minor error	Revision ID not supported	A non-supported device was connected.	Change the device to an IO-Link device with a Revision ID of 1.1 or less.	×	○	×	×
180AH	Minor error	Overcurrent detected in C/Q line	An overcurrent was detected in the C/Q line.	<ul style="list-style-type: none"> Check the wiring to see whether the C/Q of the channel in which the error was detected has short-circuited. Check whether the operation mode of the channel in which the error was detected is set as intended. Implement measures to reduce noise. Check whether the current input from each device connected to the channel in which the error was detected is 200mA or more and modify the current value input to the C/Q line if necessary. <p>If the same error is shown again, a module hardware failure may exist. Please consult your local Mitsubishi representative and explain the symptom in details.</p>	×	○	○	○
180BH	Minor error	L+ line voltage drop detection	A voltage drop was detected in the L+ line.	Check the wiring of the power supply and relevant channels, as well as the power supply equipment status, and implement measures to reduce noise. If the same error is shown again, a module hardware failure may exist. Please consult your local Mitsubishi representative and explain the symptom in details.	×	○	○	○
180CH	Minor error	Overcurrent detected in L+ line	An overcurrent was detected in the L+ line.	Check the wiring of each device and implement measures to reduce noise. If the same error is shown again, a module hardware failure may exist. Please consult your local Mitsubishi representative and explain the symptom in details.	×	○	○	○
180DH	Minor error	Channel supply voltage error (9V or less) ³	The channel supply voltage has decreased to an error level.	Check the wiring of the power supply and relevant channels, as well as the power supply equipment status, and implement measures to reduce noise. If the same error is shown again, a module hardware failure may exist. Please consult your local Mitsubishi representative and explain the symptom in details.	×	○	○	○

Error code (hexadecimal)	Classification	Error name	Description and cause	Action	Errors detectable in each operation mode			
					(1)	(2)	(3)	(4)
180EH	Minor error	Temperature rise error (160°C or higher) ^{*3}	The temperature of the channel has exceeded an error level.	Check the wiring of the power supply and relevant channels, as well as the power supply equipment status, and implement measures to reduce noise. Check whether the operating ambient temperature is within specification. If the same error is shown again, a module hardware failure may exist. Please consult your local Mitsubishi representative and explain the symptom in details.	×	○	○	○
1810H ^{*1}	Minor error	IO-Link device error notification reception	An error notification from the IO-Link device has been received.	Check the error code shown in the error code details with the manual for the IO-Link device.	×	○	×	×
1811H	Minor error	Minor hardware failure	A minor hardware failure has occurred.	Implement measures to reduce noise. If the same error is shown again, a module hardware failure may exist. Please consult your local Mitsubishi representative and explain the symptom in details.	○	○	○	○
3004H ^{*2}	Moderate error	Non-volatile memory data error (module working information)	An error was detected in the module operation information stored in the non-volatile memory.	If the same error occurs again, it is a module hardware failure. Please consult your local Mitsubishi representative and explain the symptom in details.	○	○	○	○
3005H	Moderate error	Non-volatile memory error (parameter)	An error was detected in the parameter data stored on the non-volatile memory.	Reset the parameters being used. If the same error occurs again, it is a module hardware failure. Please consult your local Mitsubishi representative and explain the symptom in details.	○	○	○	○
3006H	Moderate error	External power supply OFF error	The external power supply is off.	Check the status of the external power supply. If the error occurred during system start-up, please start the external power supply first. If the error occurred during system shut-down, please turn off the external power supply last.	○	○	○	○
3008H	Moderate error	Parameter data error (out-of-range settings)	Parameter data values are out of range.	Check the parameters shown in the error code details and configure the settings again if necessary.	○	○	○	○

Error code (hexadecimal)	Classification	Error name	Description and cause	Action	Errors detectable in each operation mode			
					(1)	(2)	(3)	(4)
3009H	Moderate error	Non-volatile memory error (IO-Link device parameters)	An error was detected in the IO-Link device parameters stored on the non-volatile memory.	Check IO-Link device parameters for channels in which parameters were changed immediately before the occurrence of the error or for which IO-Link device replacement was attempted, and configure settings again if necessary. If the same error occurs again, it is a module hardware failure. Please consult your local Mitsubishi representative and explain the symptom in details.	<input type="radio"/>	<input type="radio"/>	<input type="radio"/>	<input type="radio"/>
3E00H	Major error	Hardware failure	A hardware failure has occurred.	Implement measures to reduce noise and reset. If the same error is shown again, a module hardware failure may exist. Please consult your local Mitsubishi representative and explain the symptom in details.	<input type="radio"/>	<input type="radio"/>	<input type="radio"/>	<input type="radio"/>
3E01H	Major error	Hardware failure	A hardware failure has occurred.	Implement measures to reduce noise and reset. If the same error is shown again, a module hardware failure may exist. Please consult your local Mitsubishi representative and explain the symptom in details.	<input type="radio"/>	<input type="radio"/>	<input type="radio"/>	<input type="radio"/>
3E02H	Major error	Hardware failure	A hardware failure has occurred.	Please consult your local Mitsubishi representative and explain the symptom in details.	<input type="radio"/>	<input type="radio"/>	<input type="radio"/>	<input type="radio"/>
3E03H	Major error	Hardware failure	A hardware failure has occurred.	Please consult your local Mitsubishi representative and explain the symptom in details.	<input type="radio"/>	<input type="radio"/>	<input type="radio"/>	<input type="radio"/>
3E04H	Major error	Hardware failure	A hardware failure has occurred.	Please consult your local Mitsubishi representative and explain the symptom in details.	<input type="radio"/>	<input type="radio"/>	<input type="radio"/>	<input type="radio"/>
3E05H	Major error	Hardware failure	A hardware failure has occurred.	Please consult your local Mitsubishi representative and explain the symptom in details.	<input type="radio"/>	<input type="radio"/>	<input type="radio"/>	<input type="radio"/>
3E06H	Major error	Hardware failure	A hardware failure has occurred.	Please consult your local Mitsubishi representative and explain the symptom in details.	<input type="radio"/>	<input type="radio"/>	<input type="radio"/>	<input type="radio"/>
3E07H	Major error	Hardware failure	A hardware failure has occurred.	Please consult your local Mitsubishi representative and explain the symptom in details.	<input type="radio"/>	<input type="radio"/>	<input type="radio"/>	<input type="radio"/>
3E08H	Major error	Hardware failure	A hardware failure has occurred.	Please consult your local Mitsubishi representative and explain the symptom in details.	<input type="radio"/>	<input type="radio"/>	<input type="radio"/>	<input type="radio"/>
3E09H	Major error	Hardware failure	A hardware failure has occurred.	Please consult your local Mitsubishi representative and explain the symptom in details.	<input type="radio"/>	<input type="radio"/>	<input type="radio"/>	<input type="radio"/>

Error code (hexadecimal)	Classification	Error name	Description and cause	Action	Errors detectable in each operation mode			
					(1)	(2)	(3)	(4)
3E0BH	Major error	Hardware failure	A hardware failure has occurred.	Implement measures to reduce noise and reset. If the same error is shown again, a module hardware failure may exist. Please consult your local Mitsubishi representative and explain the symptom in details.	<input type="radio"/>	<input type="radio"/>	<input type="radio"/>	<input type="radio"/>
3E0CH	Major error	Hardware failure	A hardware failure has occurred.	Implement measures to reduce noise and reset. If the same error is shown again, a module hardware failure may exist. Please consult your local Mitsubishi representative and explain the symptom in details.	<input type="radio"/>	<input type="radio"/>	<input type="radio"/>	<input type="radio"/>
3E0DH	Major error	Hardware failure	A hardware failure has occurred.	Implement measures to reduce noise and reset. If the same error is shown again, a module hardware failure may exist. Please consult your local Mitsubishi representative and explain the symptom in details.	<input type="radio"/>	<input type="radio"/>	<input type="radio"/>	<input type="radio"/>
3E0EH	Major error	Hardware failure	A hardware failure has occurred.	Implement measures to reduce noise and reset. If the same error is shown again, a module hardware failure may exist. Please consult your local Mitsubishi representative and explain the symptom in details.	<input type="radio"/>	<input type="radio"/>	<input type="radio"/>	<input type="radio"/>
3E0FH	Major error	Hardware failure	A hardware failure has occurred.	Implement measures to reduce noise and reset. If the same error is shown again, a module hardware failure may exist. Please consult your local Mitsubishi representative and explain the symptom in details.	<input type="radio"/>	<input type="radio"/>	<input type="radio"/>	<input type="radio"/>
3E11H	Major error	Hardware failure	A hardware failure has occurred.	Implement measures to reduce noise and reset. If the same error is shown again, a module hardware failure may exist. Please consult your local Mitsubishi representative and explain the symptom in details.	<input type="radio"/>	<input type="radio"/>	<input type="radio"/>	<input type="radio"/>
3E12H	Major error	Hardware failure	A hardware failure has occurred.	Implement measures to reduce noise and reset. If the same error is shown again, a module hardware failure may exist. Please consult your local Mitsubishi representative and explain the symptom in details.	<input type="radio"/>	<input type="radio"/>	<input type="radio"/>	<input type="radio"/>
3E15H	Major error	Hardware failure	A hardware failure has occurred.	Implement measures to reduce noise and reset. If the same error is shown again, a module hardware failure may exist. Please consult your local Mitsubishi representative and explain the symptom in details.	<input type="radio"/>	<input type="radio"/>	<input type="radio"/>	<input type="radio"/>

Error code (hexadecimal)	Classification	Error name	Description and cause	Action	Errors detectable in each operation mode			
					(1)	(2)	(3)	(4)
3E17H	Major error	Hardware failure	A hardware failure has occurred.	Implement measures to reduce noise and reset. If the same error is shown again, a module hardware failure may exist. Please consult your local Mitsubishi representative and explain the symptom in details.	○	○	○	○
3E18H	Major error	Hardware failure	A hardware failure has occurred.	Implement measures to reduce noise and reset. If the same error is shown again, a module hardware failure may exist. Please consult your local Mitsubishi representative and explain the symptom in details.	○	○	○	○
3E19H	Major error	Hardware failure	A hardware failure has occurred.	Implement measures to reduce noise and reset. If the same error is shown again, a module hardware failure may exist. Please consult your local Mitsubishi representative and explain the symptom in details.	○	○	○	○
3E1AH	Major error	Hardware failure	A hardware failure has occurred.	Implement measures to reduce noise and reset. If the same error is shown again, a module hardware failure may exist. Please consult your local Mitsubishi representative and explain the symptom in details.	○	○	○	○
3E1BH	Major error	Hardware failure	A hardware failure has occurred.	Implement measures to reduce noise and reset. If the same error is shown again, a module hardware failure may exist. Please consult your local Mitsubishi representative and explain the symptom in details.	○	○	○	○
3E1CH	Major error	Hardware failure	A hardware failure has occurred.	Implement measures to reduce noise and reset. If the same error is shown again, a module hardware failure may exist. Please consult your local Mitsubishi representative and explain the symptom in details.	○	○	○	○

*1 Cleared by reconnecting the IO-Link device or changing the operation mode.

*2 When a non-volatile memory error (module working information) occurs, the number of output ON times integration value is 0. Proceed with caution when using the number of ON times integration function with a program.

*3 The detection values shown are approximate values and may fluctuate depending on the operating environment. Fluctuation ranges are as follows.

Channel supply voltage error (9V or less): 7V to 9V

Temperature rise error (160°C or higher): 145°C to 175°C

Error code details

Regarding the following error codes and warning codes, additional error information is stored in the error code details.

Error code (hexadecimal)	Classification	Error code details 1	Error code details 2	Error code details 3
1806H	Minor error	Channel where error detected	0 (fixed)	0 (fixed)
1808H	Minor error	Channel where error detected	Parameter where error detected	0 (fixed)
1809H	Minor error	Channel where error detected	0 (fixed)	0 (fixed)
180AH	Minor error	Channel where error detected	0 (fixed)	0 (fixed)
180BH	Minor error	Channel where error detected	0 (fixed)	0 (fixed)
180CH	Minor error	Channel where error detected	0 (fixed)	0 (fixed)
180DH	Minor error	Channel where error detected	0 (fixed)	0 (fixed)
180EH	Minor error	Channel where error detected	0 (fixed)	0 (fixed)
1810H	Minor error	Channel where error detected	Error type	IO-Link device error code ^{*1}
3008H	Moderate error	0 (fixed)	Parameter number	First remote buffer memory address of the parameter in which an error is detected
Other than above		0 (fixed)		

*1 Refer to the manual of the IO-Link device used.

■Channel where error detected

Value of the channel in which an error was detected is stored.

Stored value	Channel
0100H	CH1
0200H	CH2
0300H	CH3
0400H	CH4
0500H	CH5
0600H	CH6
0700H	CH7
0800H	CH8

■Parameter where error detected

Value of the ID with which an error was detected is stored.

Stored value	Parameter
00E0H	Revision ID
00E1H	Vendor ID or device ID
00E2H	Serial number

■Error type

Type of the detected error is stored.

Stored value	Type
00F0H	Error
00F1H	Warning

■Parameter number

Value of the parameter number with which an error was detected is stored.

□: Parameter type, △: Parameter ID

Stored value	Parameter number details	
1□△△H	Parameter type	<ul style="list-style-type: none"> • 0: Station-based parameter • 1 to 8: Module-based parameters CH1 to CH8
	Parameter ID	<ul style="list-style-type: none"> ■When parameter type is station-based <ul style="list-style-type: none"> • 01: Input response time setting • 02: Output HOLD/CLEAR setting ■When parameter type is module-based parameters CH1 to CH8 <ul style="list-style-type: none"> • 01: Operation mode setting • 04: Device validation setting • 05: Input OFF delay setting • 06: Input data masking setting • 07: Swap setting • 08: Event acquisition setting • 09: Bit segment setting

11.8 Event History List

This section lists the events saved by the IO-Link module.

System

Event code (hexadecimal)	Overview	Cause
00400H	Power-on/reset clear	The module was powered on or reset.
00510H	Data link restart (cyclic transmission start)	Own station data link resumed.
00600H	Successful downloading of IO-Link device parameters	IO-Link device parameters were downloaded successfully.
00601H	IO-Link device connection	Connection with an IO-Link device was established successfully.
00602H	Uploading/downloading not performed	Since the connected IO-Link device does not support uploading and downloading functions, IO-Link device parameters were not uploaded or downloaded.
00603H	Successful uploading of IO-Link device parameters	IO-Link device parameters were uploaded successfully.
00604H	Data storage buffer overflow	An IO-Link device with a parameter size that exceeds IO-Link standards was connected.
00605H	IO-Link device parameter download failure	Downloading of IO-Link device parameters failed.
00606H	IO-Link device parameter upload failure	Uploading of IO-Link device parameters failed.
00607H	IO-Link device access failure	Access to IO-Link device parameters failed.
0060FH	IO-Link device event reception (clear)	A notification about event clear has been issued from the IO-Link device.
00610H	IO-Link device event reception (occur)	A notification about event occurrence has been issued from the IO-Link device.
00C10H	Data link stop (cyclic transmission stop)	Own station data link was stopped.
00E00H	IO-Link device firmware version mismatch	Parameters have been downloaded for an IO-Link device with a firmware version different from that of the module.
00E01H	Channel supply voltage warning (18V or less) ^{*1}	The channel supply voltage has decreased to a warning level.
00E02H	Temperature rise warning (135°C or higher) ^{*1}	The temperature of the channel has exceeded a warning level.

*1 The detection values shown are approximate values and may fluctuate depending on the operating environment. Fluctuation ranges are as follows.

Channel supply voltage warning (18V or less): 16V to 18V

Temperature rise warning (135°C or higher): 120°C to 150°C

Operation

Event code (hexadecimal)	Overview	Cause
20100H	Error clear	Errors were cleared.
20200H	Event history clear	Event history was cleared.
24001H	Remote operation request reception	A remote operation request (RESET) was received.
24300H	Device replacement start	Device replacement was started.
24301H	Device replacement end	Device replacement ended.
24305H	IO-Link module parameter setting	IO-Link module parameters were written.
24306H	IO-Link device parameter setting	IO-Link device parameters were written.
24309H	Manual upload request	A manual upload request was issued.

Detailed information

Regarding the following event history, additional event information is stored in the error code details.

Event code (hexadecimal)	Type	Detailed information 1	Detailed information 2	Detailed information 3
00600H	System	Relevant channel	—	—
00601H	System	Relevant channel	—	—
00602H	System	Relevant channel	—	—
00603H	System	Relevant channel	—	—
00604H	System	Relevant channel	—	—
00605H	System	Relevant channel	—	—
00606H	System	Relevant channel	—	—
00607H	System	Relevant channel	—	—
0060FH	System	Relevant channel	Event type	Event information received from IO-Link devices ^{*1}
00610H	System	Relevant channel	Event type	Event information received from IO-Link devices ^{*1}
00E01H	System	Relevant channel	—	—
00E02H	System	Relevant channel	—	—
00C10H	System	—	Data link stop cause	—
00E00H	System	Relevant channel	—	—
24300H	Operation	Relevant channel	—	—
24301H	Operation	Relevant channel	—	—
24306H	Operation	Relevant channel	—	Index
24309H	Operation	Relevant channel	—	—
Other than above		—		

*1 Refer to the manual of the IO-Link device used.

■ Relevant channel

Value of the channel in which an event was detected is stored.

Stored value	Channel
0100H	CH1
0200H	CH2
0300H	CH3
0400H	CH4
0500H	CH5
0600H	CH6
0700H	CH7
0800H	CH8

■ Event type

Value of the event type is stored.

Stored value	Type
00F1H	Warning
00F2H ^{*1}	Notification

*1 Only for event code 00610H

■Data link stop cause

Value of the data link stop cause is stored.

Stored value	Cause
0001H	Stop instruction issued
0002H	Monitoring time timeout
0010H	Parameters not received
0011H	Own station No. out of range
0012H	Own station reserved specification
0013H	Own station number duplication
0016H	Station number not set
0018H	Parameter error
0019H	Parameter being communicated
001AH	Station type mismatch
001CH	Parameter mismatch

APPENDICES

Appendix 1 Remote I/O Signals

This section lists I/O signals for a master/local module.

Remote input (RX) indicates the input signal from the IO-Link module to the master/local module.

Remote output (RY) indicates the output signal from the master/local module to the IO-Link module.

The remote I/O signals of the IO-Link module are assigned as shown below.

Module	Remote input (RX)	Remote output (RY)
IO-Link module	RX0 to RX2F	RY0 to RY2F

Point

Do not use any "Use prohibited" remote I/O signals. Doing so may cause an accident due to incorrect output or malfunction.

List of remote I/O signals

Remote input (RX)

Signal direction: IO-Link module → Master/local module				
Device No.	Signal name			
	IO-Link (standard) mode	IO-Link (sink input) mode	SIO (sink input) mode	SIO (source output) mode
RX0	CH1 Data masking result	CH1 DI signal	CH1 CQ input signal	Use prohibited
RX1	CH2 Data masking result	CH2 DI signal	CH2 CQ input signal	
RX2	CH3 Data masking result	CH3 DI signal	CH3 CQ input signal	
RX3	CH4 Data masking result	CH4 DI signal	CH4 CQ input signal	
RX4	CH5 Data masking result	CH5 DI signal	CH5 CQ input signal	
RX5	CH6 Data masking result	CH6 DI signal	CH6 CQ input signal	
RX6	CH7 Data masking result	CH7 DI signal	CH7 CQ input signal	
RX7	CH8 Data masking result	CH8 DI signal	CH8 CQ input signal	
RX8	CH1 Input data invalid flag			
RX9	CH2 Input data invalid flag			
RXA	CH3 Input data invalid flag			
RXB	CH4 Input data invalid flag			
RXC	CH5 Input data invalid flag			
RXD	CH6 Input data invalid flag			
RXE	CH7 Input data invalid flag			
RXF	CH8 Input data invalid flag			
RX10 to RX18	Use prohibited			
RX19	Occurrence of minor error			
RX1A	External power supply ready			
RX1B	Use prohibited			
RX1C				
RX1D	Event status flag			
RX1E	Use prohibited			
RX1F				

Signal direction: IO-Link module → Master/local module

Device No.	Signal name			
	IO-Link (standard) mode	IO-Link (sink input) mode	SIO (sink input) mode	SIO (source output) mode
RX20	CH1 IO-Link device connection status flag		Use prohibited	
RX21	CH2 IO-Link device connection status flag			
RX22	CH3 IO-Link device connection status flag			
RX23	CH4 IO-Link device connection status flag			
RX24	CH5 IO-Link device connection status flag			
RX25	CH6 IO-Link device connection status flag			
RX26	CH7 IO-Link device connection status flag			
RX27	CH8 IO-Link device connection status flag			
RX28 to RX2F	Use prohibited			

Remote output (RY)

Signal direction: Master/local module → IO-Link module

Device No.	Signal name			
	IO-Link (standard) mode	IO-Link (sink input) mode	SIO (sink input) mode	SIO (source output) mode
RY0	Use prohibited			CH1 CQ output signal
RY1				CH2 CQ output signal
RY2				CH3 CQ output signal
RY3				CH4 CQ output signal
RY4				CH5 CQ output signal
RY5				CH6 CQ output signal
RY6				CH7 CQ output signal
RY7				CH8 CQ output signal
RY8	CH1 Output data valid flag		Use prohibited	
RY9	CH2 Output data valid flag			
RYA	CH3 Output data valid flag			
RYB	CH4 Output data valid flag			
RYC	CH5 Output data valid flag			
RYD	CH6 Output data valid flag			
RYE	CH7 Output data valid flag			
RYF	CH8 Output data valid flag			
RY10 to RY18	Use prohibited			
RY19	Occurrence of minor error clear request flag			
RY1A to RY2F	Use prohibited			

Details of remote input signals

Data masking result

■Device number, remote input signal name

Device No.	Name
RX0	CH1 Data masking result
RX1	CH2 Data masking result
RX2	CH3 Data masking result
RX3	CH4 Data masking result
RX4	CH5 Data masking result
RX5	CH6 Data masking result
RX6	CH7 Data masking result
RX7	CH8 Data masking result

■Description

Masking results are stored using the input data masking function of the corresponding channel.

For details on the input data masking function, refer to the following.

 Page 74 Input data masking function

DI signal, CQ input signal

■Device number, remote input signal name

Device No.	Name	
RX0	CH1 DI signal	CH1 CQ input signal
RX1	CH2 DI signal	CH2 CQ input signal
RX2	CH3 DI signal	CH3 CQ input signal
RX3	CH4 DI signal	CH4 CQ input signal
RX4	CH5 DI signal	CH5 CQ input signal
RX5	CH6 DI signal	CH6 CQ input signal
RX6	CH7 DI signal	CH7 CQ input signal
RX7	CH8 DI signal	CH8 CQ input signal

■Description

The digital input value of the corresponding channel will be reflected.

However, when the input OFF delay function is enabled, the reflected value may not match with the actual on/off state of the external input.

Input data invalid flag

■Device number, remote input signal name

Device No.	Name
RX8	CH1 Input data invalid flag
RX9	CH2 Input data invalid flag
RXA	CH3 Input data invalid flag
RXB	CH4 Input data invalid flag
RXC	CH5 Input data invalid flag
RXD	CH6 Input data invalid flag
RXE	CH7 Input data invalid flag
RXF	CH8 Input data invalid flag

■Description

The input data invalid flag turns on in any of the following cases.

- When an error is detected in the corresponding channel
- When data input to the corresponding channel is defined as invalid by the IO-Link device
- When the device replacement flag (address: 36CCH) for the corresponding channel is on
- When CH□ IO-Link device connection status flag (RX20 to RX27) for the corresponding channel is off
- When a moderate or major error occurs
- When Remote READY (RWr0.b11) is off
- When a minor hardware error (error code: 1811H) occurs

Occurrence of minor error

■Device number, remote input signal name

Device No.	Name
RX19	Occurrence of minor error

■Description

Use to check whether a minor error has occurred even once.

Occurrence of minor error (RX19) can be cleared by turning on Occurrence of minor error clear request flag (RY19).

External power supply ready

■Device number, remote input signal name

Device No.	Name
RX1A	External power supply ready

■Description

Status of the external power supply is indicated.

This flag turns on when the external power supply is detected as being on.

This flag turns off when the external power supply is detected as being off.

Event status flag

■Device number, remote input signal name

Device No.	Name
RX1D	Event status flag

■Description

This flag turns on when a new event occurs.

This flag turns off when reading of all events is completed by Event read request flag (address: 2D09H).

IO-Link device status flag

■ Device number, remote input signal name

Device No.	Name
RX20	CH1 IO-Link device connection status flag
RX21	CH2 IO-Link device connection status flag
RX22	CH3 IO-Link device connection status flag
RX23	CH4 IO-Link device connection status flag
RX24	CH5 IO-Link device connection status flag
RX25	CH6 IO-Link device connection status flag
RX26	CH7 IO-Link device connection status flag
RX27	CH8 IO-Link device connection status flag

■ Description

Connection status of the IO-Link device is indicated.

This flag turns on when an IO-Link device connection is detected and turns off when an IO-Link device disconnection is detected.



When the operation mode is other than IO-Link (standard) or IO-Link (sink input) mode, this flag does not turn on even if an IO-Link device is connected.

Details of remote output signals

CQ output signal

■Device number, remote output signal name

Device No.	Name
RY0	CH1 CQ output signal
RY1	CH2 CQ output signal
RY2	CH3 CQ output signal
RY3	CH4 CQ output signal
RY4	CH5 CQ output signal
RY5	CH6 CQ output signal
RY6	CH7 CQ output signal
RY7	CH8 CQ output signal

■Description

This flag turns on and off the external output for the corresponding channel.

Output data valid flag

■Device number, remote output signal name

Device No.	Name
RY8	CH1 Output data valid flag
RY9	CH2 Output data valid flag
RYA	CH3 Output data valid flag
RYB	CH4 Output data valid flag
RYC	CH5 Output data valid flag
RYD	CH6 Output data valid flag
RYE	CH7 Output data valid flag
RYF	CH8 Output data valid flag

■Description

When this flag turns on for the corresponding channel in the IO-Link mode, output process data becomes valid.

When this flag is off, output process data becomes invalid.

Occurrence of minor error clear request flag

■Device number, remote output signal name

Device No.	Name
RY19	Occurrence of minor error clear request flag

■Description

When this flag turns on, minor error occurrences can be cleared.

Clear processing continues while this flag is on.

Appendix 2 Remote Register

This section lists the remote register for a master/local module.

The following shows an assignment example of remote register with the remote register of the IO-Link module assigned to RWr0 to RWr83 and RWw0 to RWw83.

The remote register is assigned in station-based units.

Remote register (RWr) is the information input from the IO-Link module to the master/local module.

Remote register (RWw) is the information output from the master/local module to the IO-Link module.



Do not read or write data from/to any "Use prohibited" remote register. Doing so may cause an accident due to incorrect output or malfunction.

List of remote register

Remote register (RWr)				
Signal direction: IO-Link module → Master/local module				
Device No.	Name			
	IO-Link (standard) mode	IO-Link (sink input) mode	SIO (sink input) mode	SIO (source output) mode
RWr0	Module status area			
RWr1	Error code			
RWr2	Warning code			
RWr3	Use prohibited			
RWr4 ^{*1}	CH1 Input process data (1st word)		Use prohibited	CH1 Output information
RWr5 ^{*1}	CH1 Input process data (2nd word)			Use prohibited
⋮	⋮			
RWr13 ^{*1}	CH1 Input process data (16th word)			
RWr14 ^{*1}	CH2 Input process data (1st word)			CH2 Output information
RWr15 ^{*1}	CH2 Input process data (2nd word)			Use prohibited
⋮	⋮			
RWr23 ^{*1}	CH2 Input process data (16th word)			
RWr24 ^{*1}	CH3 Input process data (1st word)			CH3 Output information
RWr25 ^{*1}	CH3 Input process data (2nd word)			Use prohibited
⋮	⋮			
RWr33 ^{*1}	CH3 Input process data (16th word)			
RWr34 ^{*1}	CH4 Input process data (1st word)			CH4 Output information
RWr35 ^{*1}	CH4 Input process data (2nd word)			Use prohibited
⋮	⋮			
RWr43 ^{*1}	CH4 Input process data (16th word)			
RWr44 ^{*1}	CH5 Input process data (1st word)		CH5 Output information	
RWr45 ^{*1}	CH5 Input process data (2nd word)		Use prohibited	
⋮	⋮			
RWr53 ^{*1}	CH5 Input process data (16th word)			
RWr54 ^{*1}	CH6 Input process data (1st word)		CH6 Output information	
RWr55 ^{*1}	CH6 Input process data (2nd word)		Use prohibited	
⋮	⋮			
RWr63 ^{*1}	CH6 Input process data (16th word)			
RWr64 ^{*1}	CH7 Input process data (1st word)		CH7 Output information	
RWr65 ^{*1}	CH7 Input process data (2nd word)		Use prohibited	
⋮	⋮			
RWr73 ^{*1}	CH7 Input process data (16th word)			



Signal direction: IO-Link module → Master/local module				
Device No.	Name			
	IO-Link (standard) mode	IO-Link (sink input) mode	SIO (sink input) mode	SIO (source output) mode
RWr74*1	CH8 Input process data (1st word)		Use prohibited	CH8 Output information
RWr75*1	CH8 Input process data (2nd word)			Use prohibited
⋮	⋮			
RWr83*1	CH8 Input process data (16th word)			

*1 When CH□ Input data invalid flag (RX8 to RXF) is on, input process data is an undefined value and cannot be used with programs.

Remote register (RWw)

Signal direction: Master/local module → IO-Link module				
Device number	Name			
	IO-Link (standard) mode	IO-Link (sink input) mode	SIO (sink input) mode	SIO (source output) mode
RWw0	Module operation area			
RWw1 to RWw3	Use prohibited			
RWw4*1	CH1 Output process data (1st word)		Use prohibited	CH1 Output information operation flag
RWw5*1	CH1 Output process data (2nd word)			Use prohibited
⋮	⋮			
RWw13*1	CH1 Output process data (16th word)			
RWw14*1	CH2 Output process data (1st word)			CH2 Output information operation flag
RWw15*1	CH2 Output process data (2nd word)			Use prohibited
⋮	⋮			
RWw23*1	CH2 Output process data (16th word)			
RWw24*1	CH3 Output process data (1st word)			CH3 Output information operation flag
RWw25*1	CH3 Output process data (2nd word)			Use prohibited
⋮	⋮			
RWw33*1	CH3 Output process data (16th word)			
RWw34*1	CH4 Output process data (1st word)			CH4 Output information operation flag
RWw35*1	CH4 Output process data (2nd word)			Use prohibited
⋮	⋮			
RWw43*1	CH4 Output process data (16th word)			
RWw44*1	CH5 Output process data (1st word)		CH5 Output information operation flag	
RWw45*1	CH5 Output process data (2nd word)		Use prohibited	
⋮	⋮			
RWw53*1	CH5 Output process data (16th word)			
RWw54*1	CH6 Output process data (1st word)		CH6 Output information operation flag	
RWw55*1	CH6 Output process data (2nd word)		Use prohibited	
⋮	⋮			
RWw63*1	CH6 Output process data (16th word)			
RWw64*1	CH7 Output process data (1st word)		CH7 Output information operation flag	
RWw65*1	CH7 Output process data (2nd word)		Use prohibited	
⋮	⋮			
RWw73*1	CH7 Output process data (16th word)			
RWw74*1	CH8 Output process data (1st word)		CH8 Output information operation flag	
RWw75*1	CH8 Output process data (2nd word)		Use prohibited	
⋮	⋮			
RWw83*1	CH8 Output process data (16th word)			

*1 When CH□ Output data valid flag (RY8 to RYF) is off, the IO-Link module notifies the IO-Link device that the output process data is invalid. When output process data is invalid, IO-Link device operation is performed in accordance with the specifications of the IO-Link device being used.



Details of remote register

Module status area

■ Device number, remote register name

Device No.	Name
RWr0	Module status area

■ Details of module status area

Module status area	Name
RWr0.b0 to RWr0.b9	Use prohibited
RWr0.b10	Error status flag
RWr0.b11	Remote READY
RWr0.b12	Warning status flag
RWr0.b13 to RWr0.b15	Use prohibited

■ Error status flag (RWr0.b10)

Error status flag (RWr0.b10) turns on when a moderate error or major error occurs (excluding a watchdog timer error). Eliminating the cause of the error and turning on Error clear request flag (RWw0.b10) resets Error code (RWr1) to 0000H and turns off Error status flag (RWr0.b10).

Also, corresponding moderate errors for Current error data 1 to 16 (address: 2B00H to 2BFFH) are reset to 0000H.

If the cause of the error cannot be eliminated and Error clear request flag (RWw0.b10) is on, Current error data 1 to 16 (address: 2B00H to 2BFFH) cannot be cleared.

When a major error has occurred, the error clear operation is not available.

Multiple errors occurring on multiple channels can be cleared collectively.

Point

The event history is not cleared even if Error clear request flag (RWw0.b10) is turned on and off. To clear the event history, set Event history clear command (address: 2D00H) to on (1). (Page 180 Event history clear command)

- When a moderate error occurs

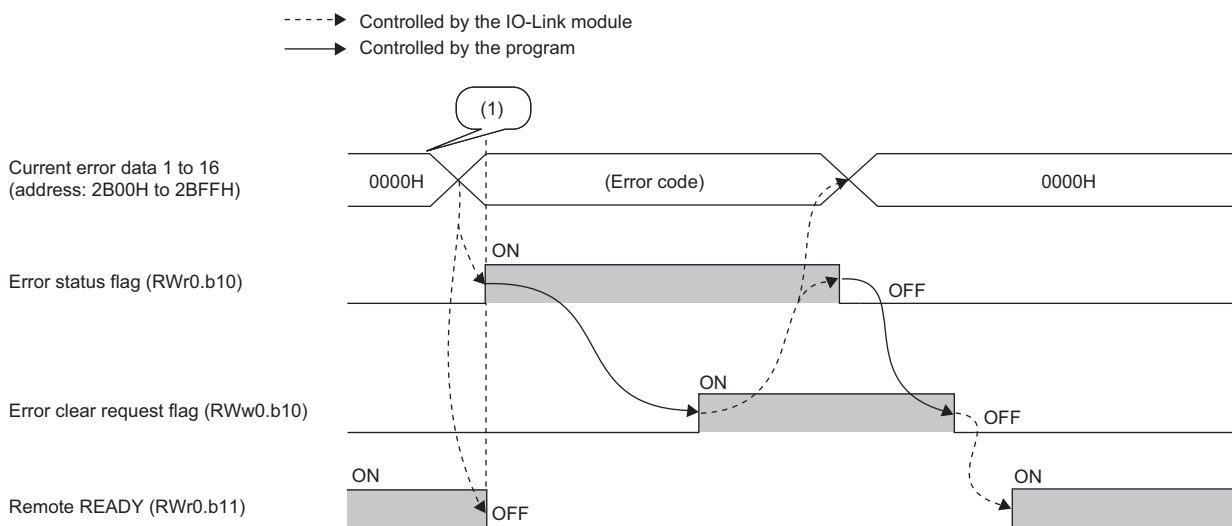

(1) Occurrence of an error

- When a major error occurs

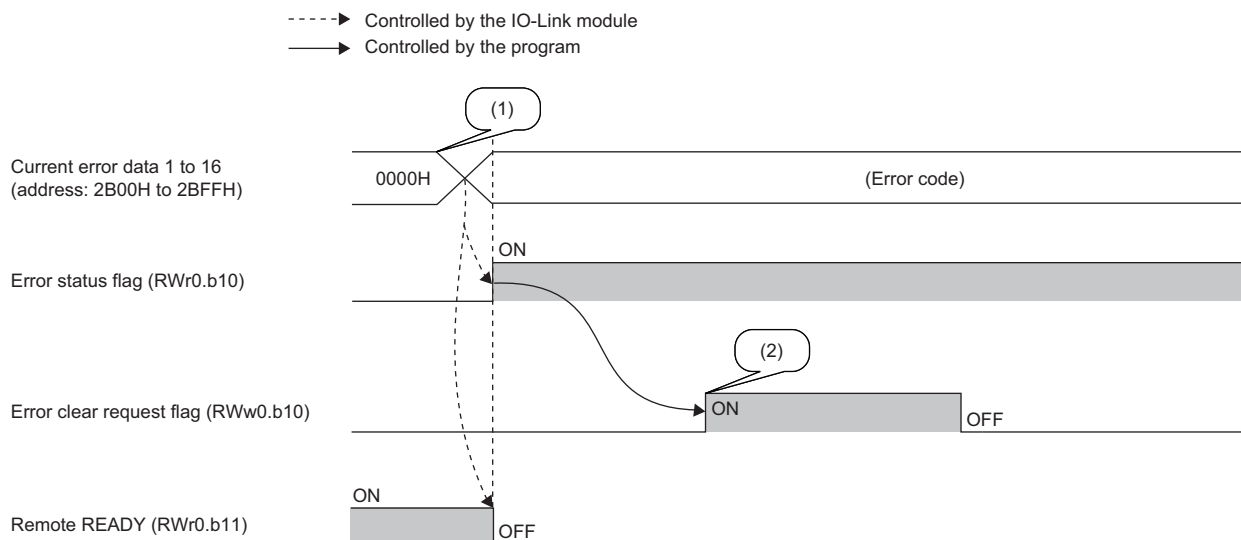

- (1) Occurrence of an error
- (2) When a major error has occurred, current error data is not cleared even if an error clear request is issued.

■ Remote READY (RWr0.b11)

This signal is used as an interlock condition when the CC-Link IE Field Network master station reads/writes data from/to the remote register and other areas of the IO-Link module.

When turning on or resetting the module power supply, Remote READY (RWr0.b11) turns on.

Remote READY (RWr0.b11) may turn off while the IO-Link module is operating.

The following shows the conditions under which Remote READY (RWr0.b11) turns off.

- When a moderate or major error occurs (When a moderate error occurs, Remote READY (RWr0.b11) will remain off until all causes of errors are eliminated from Current error data 1 to 16 (address: 2B00H to 2BFFH) and Error clear request flag (RWw0.b10) is turned off.)
- When Error clear request flag (RWw0.b10) is on
- When parameter changes are requested

■ Warning status flag (RWr0.b12)

Warning status flag (RWr0.b12) turns on when a minor error occurs.

After five seconds from eliminating the cause of the minor error, the corresponding minor error for Current error data 1 to 16 (address: 2B00H to 2BFFH) is automatically reset to 0000H and Warning status flag (RWr0.b12) turns off.

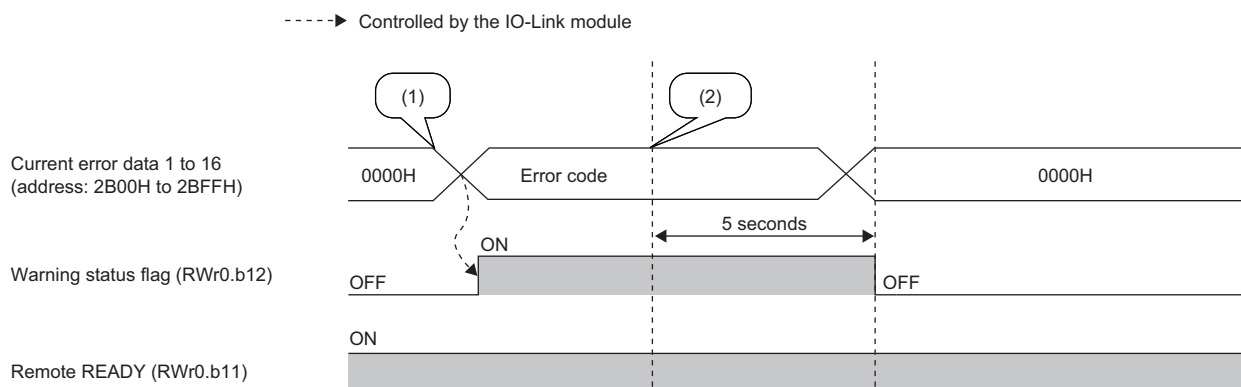

- (1) Occurrence of a minor error
- (2) The minor error is cleared.



Error code

■Device number, remote register name

Device No.	Name
RWr1	Error code

■Description

An error code is stored when a moderate error or major error occurs (excluding a watchdog timer error).
Turning on Error clear request flag (RWW0.b10) after eliminating the cause of the error clears the error code.



While a moderate error is occurring, the latest error code will not be overwritten by any new moderate errors that may occur. If a major error occurs while a moderate error is occurring, the error code is overwritten with that for the major error.

Warning code

■Device number, remote register name

Device number	Name
RWr2	Warning code

■Description

Warning codes are stored when minor errors occur.
After five seconds from eliminating the cause of the minor error, the latest warning code is automatically cleared.



While a minor error is occurring, the latest warning code will not be overwritten by any new minor errors that may occur.

Input process data

■Device number, remote register name

Device No.	Name
RWr4 to RWr13	CH1 Input process data
RWr14 to RWr23	CH2 Input process data
RWr24 to RWr33	CH3 Input process data
RWr34 to RWr43	CH4 Input process data
RWr44 to RWr53	CH5 Input process data
RWr54 to RWr63	CH6 Input process data
RWr64 to RWr73	CH7 Input process data
RWr74 to RWr83	CH8 Input process data

■Description

If the bit segment setting is disabled, assignment will take place starting from the 1st word of the input process data.
If the bit segment setting is enabled, assignment will take place in the order (starting from No.1) for input process data bits set using the bit segment function.

Input process data is invalid under the following circumstances.

- When CH□ Input data invalid flag (RX8 to RXF) is on

Output information

■ Device number, remote register name

Device No.	Name
RWr4	CH1 Output information
RWr14	CH2 Output information
RWr24	CH3 Output information
RWr34	CH4 Output information
RWr44	CH5 Output information
RWr54	CH6 Output information
RWr64	CH7 Output information
RWr74	CH8 Output information

■ Details of output information

Output information	Name	
CH1 Output information (RWr4)	b0	Output ON information
	b1	Output OFF information
	b2 to b15	Use prohibited
CH2 Output information (RWr14)	Same as CH1 Output information (RWr4)	
CH3 Output information (RWr24)	Same as CH1 Output information (RWr4)	
CH4 Output information (RWr34)	Same as CH1 Output information (RWr4)	
CH5 Output information (RWr44)	Same as CH1 Output information (RWr4)	
CH6 Output information (RWr54)	Same as CH1 Output information (RWr4)	
CH7 Output information (RWr64)	Same as CH1 Output information (RWr4)	
CH8 Output information (RWr74)	Same as CH1 Output information (RWr4)	

■ Output ON information

Whether the external output has been turned on or not can be checked with Output ON information (RWr4.b0). Output ON information (RWr4.b0) can be cleared using Output ON information clear request (RWw4.b0). (Page 160 Output ON information clear request)

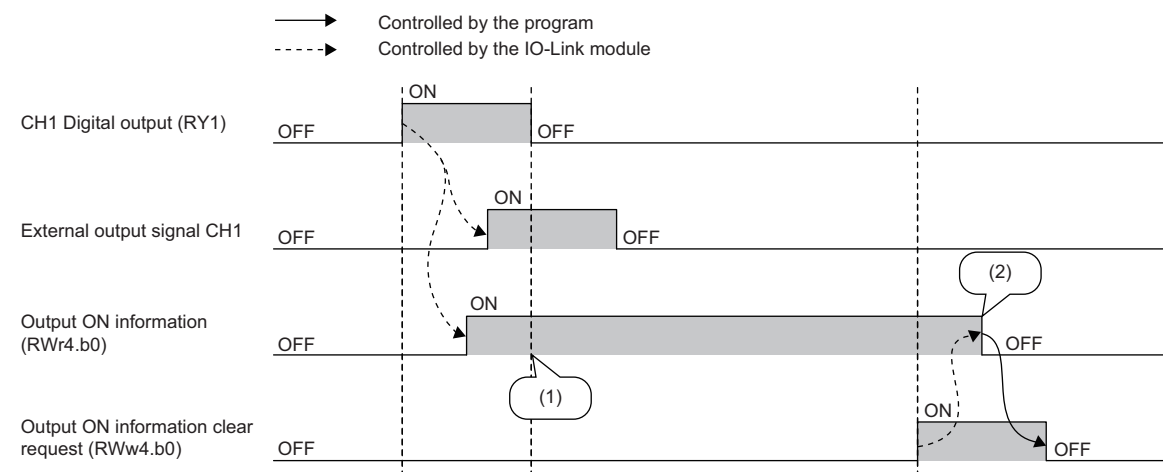

- (1) Remains on even after CH1 turns off.
 (2) Turns off when the clear request turns on.



■Output OFF information

Whether the external output has been turned off or not can be checked with Output OFF information (RWr4.b1).

Output OFF information (RWr4.b1) can be cleared using Output OFF information clear request (RWw4.b1). ( Page 160

Output OFF information clear request)

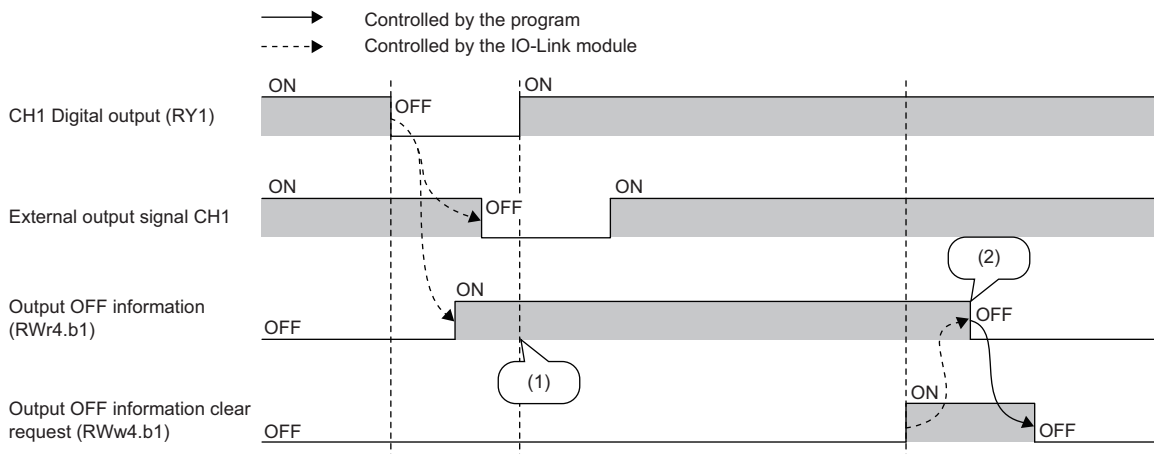

(1) Remains on even after CH1 turns on.

(2) Turns off when the clear request turns on.

Module operation area

■Device number, remote register name

Device No.	Name
RWw0	Module operation area

■Details of module operation area

Module operation area	Name
RWw0.b0 to RWw0.b9	Use prohibited
RWw0.b10	Error clear request flag
RWw0.b11 to RWw0.b15	Use prohibited

■Error clear request flag (RWw0.b10)

Use to clear Error status flag (RWr0.b10), Error code (RWr1), and corresponding moderate errors for Current error data 1 to 16 (address: 2B00H to 2BFFH).

Output process data

■Device number, remote register name

Device No.	Name
RWw4 to RWw13	CH1 Output process data
RWw14 to RWw23	CH2 Output process data
RWw24 to RWw33	CH3 Output process data
RWw34 to RWw43	CH4 Output process data
RWw44 to RWw53	CH5 Output process data
RWw54 to RWw63	CH6 Output process data
RWw64 to RWw73	CH7 Output process data
RWw74 to RWw83	CH8 Output process data

■Description

Assignment will take place starting from the 1st word of the output process data.

Output process data is invalid under the following circumstances.

Status	Condition	
	Number of output process data is 0	Number of output process data is 1 or more
When disconnected or when the CPU module is in the STOP state (the output HOLD/CLEAR setting is set to CLEAR)	—	Any of the statuses are occurring.
When CH□ Output data valid flag (RY8 to RYF) is off		
When a channel error occurs ^{*1}	Any of the statuses are occurring.	
When an IO-Link module error occurs		
When Device replacement flag (address: 36CCH) is on		
When Remote READY (RWr0.b11) is off		

*1 When Output process data output enabled command at channel error (address: 3720H to 3727H) is enabled, the output process data is valid. For details, refer to the following.

☞ Page 188 Output process data output enabled command at channel error

Output information operation flag

■Device number, remote register name

Device No.	Name
RWw4	CH1 Output information operation flag
RWw14	CH2 Output information operation flag
RWw24	CH3 Output information operation flag
RWw34	CH4 Output information operation flag
RWw44	CH5 Output information operation flag
RWw54	CH6 Output information operation flag
RWw64	CH7 Output information operation flag
RWw74	CH8 Output information operation flag

■Details of output information operation flag

Output information operation flag	Name	
CH1 Output information operation flag (RWw4)	b0	Output ON information clear request
	b1	Output OFF information clear request
	b2 to b15	Use prohibited
CH2 Output information operation flag (RWw14)	Same as CH1 Output information operation flag (RWw4)	
CH3 Output information operation flag (RWw24)	Same as CH1 Output information operation flag (RWw4)	
CH4 Output information operation flag (RWw34)	Same as CH1 Output information operation flag (RWw4)	
CH5 Output information operation flag (RWw44)	Same as CH1 Output information operation flag (RWw4)	
CH6 Output information operation flag (RWw54)	Same as CH1 Output information operation flag (RWw4)	
CH7 Output information operation flag (RWw64)	Same as CH1 Output information operation flag (RWw4)	
CH8 Output information operation flag (RWw74)	Same as CH1 Output information operation flag (RWw4)	

■Output ON information clear request

Use to clear Output ON information (RWr4.b0). Clear processing continues while Output OFF information clear request (RWw4.b1) is on.

■Output OFF information clear request

Use to clear Output OFF information (RWr4.b1). Clear processing continues while Output OFF information clear request (RWw4.b1) is on.

Appendix 3 Remote Buffer Memory

This section describes remote buffer memory.

Remote buffer memory is partitioned into parameter areas, monitor areas, event information areas, and module control data areas by addresses.

Point

- Do not read/write data from/to any "Use prohibited" remote buffer memory areas. Doing so may cause an accident due to incorrect output or malfunction.
- Some areas are disabled depending on the operation mode. If disabled, any written setting values are ignored.
- If writing values to parameter areas and module control data areas successively, write 0 for "Reserved areas".
- Unless otherwise specified, 0 is stored when the CPU module is powered on or the CPU module is reset.

List of remote buffer memory

This section lists the remote buffer memory addresses of the IO-Link module.

The remote buffer memory areas of the IO-Link module are assigned as shown below.

○: Available, ×: Not available

Address		Area	Data type		Access method		
Decimal	Hexadecimal				CC IE Field configuration of the engineering tool	REMFR instruction, REMTO instruction *1	
0 to 5375	0000H to 14FFH	Use prohibited		×	×		
5376 to 5631	1500H to 15FFH	Parameter area	Station-based parameter data		○*2	○	
5632 to 5887	1600H to 16FFH		Module-based parameter data	Use prohibited		×	×
5888 to 6143	1700H to 17FFH			CH1	○*2	○	
6144 to 6399	1800H to 18FFH			CH2			
6400 to 6655	1900H to 19FFH			CH3			
6656 to 6911	1A00H to 1AFFH			CH4			
6912 to 7167	1B00H to 1BFFH			CH5			
7168 to 7423	1C00H to 1CFFH			CH6			
7424 to 7679	1D00H to 1DFFH			CH7			
7680 to 7935	1E00H to 1EFFH			CH8			
7936 to 10239	1F00H to 27FFH		Use prohibited		×	×	
10240 to 10495	2800H to 28FFH	Monitoring area	Station-based monitor data		×	○	
10496 to 10751	2900H to 29FFH		Module-based monitor data				
10752 to 11007	2A00H to 2AFFH	Use prohibited		×	×		
11008 to 11263	2B00H to 2BFFH	Event information area	Station-based current error data		○*2	○	
11264 to 11519	2C00H to 2CFFH		Station-based event data				
11520 to 11775	2D00H to 2DFFH	Module control data area	Station-based control data		×	○	
11776 to 15871	2E00H to 3DFFH		Module-based control data				
15872 to 19967	3E00H to 4DFFH	Use prohibited		×	×		

*1 For the REMFR and REMTO instructions, refer to the following.

- 📖 User's manual for the master/local module used
- 📖 MELSEC iQ-R Programming Manual (Module Dedicated Instructions)

*2 For the access method, refer to the following.

- Parameter area (📖 Page 43 PARAMETER SETTING)
- Event information area (📖 Page 165 Event information area)



Parameter area

■ Station-based parameter data

○: Available, ×: Not available

Address		Name				Default value	Read	Write
Decimal	Hexadecimal	IO-Link (standard) mode	IO-Link (sink input) mode	SIO (sink input) mode	SIO (source output) mode			
5376	1500H	Input response time setting				0005H	○	○
5377	1501H	Output HOLD/CLEAR setting				0000H	○	○
5378 to 5631	1502H to 15FFH	Use prohibited				—	×	×

■ Module-based parameter data

○: Available, ×: Not available

Address		Channel	Name				Default value	Read	Write
Decimal	Hexadecimal		IO-Link (standard) mode	IO-Link (sink input) mode	SIO (sink input) mode	SIO (source output) mode			
5632 to 5887	1600H to 16FFH	—	Use prohibited				—	×	×
5888	1700H	CH1	Operation mode setting				0000H	○	○
5889, 5890	1701H, 1702H		Reserved area				—	○	○
5891	1703H		Device validation setting		—		0000H	○	○
5892, 5893	1704H, 1705H		Input OFF delay setting		—		00000000H	○	○
5894	1706H		Input data masking setting		—		0000H	○	○
5895	1707H		Swap setting		—		0001H	○	○
5896	1708H		Event acquisition setting		—		0002H	○	○
5897 to 5913	1709H to 1719H		Bit segment setting		—		0000H	○	○
5914 to 6143	171AH to 17FFH		Use prohibited				—	×	×
6144 to 6399	1800H to 18FFH		CH2	Same as CH1					
6400 to 6655	1900H to 19FFH	CH3	Same as CH1						
6656 to 6911	1A00H to 1AFFH	CH4	Same as CH1						
6912 to 7167	1B00H to 1BFFH	CH5	Same as CH1						
7168 to 7423	1C00H to 1CFFH	CH6	Same as CH1						
7424 to 7679	1D00H to 1DFFH	CH7	Same as CH1						
7680 to 7935	1E00H to 1EFFH	CH8	Same as CH1						



Values read from the non-volatile memory when the CPU module is powered on or the remote reset is executed are set in the parameter area.

Monitoring area

■ Station-based monitor data

○: Available, ×: Not available

Address		Name				Default value	Read	Write
Decimal	Hexadecimal	IO-Link (standard) mode	IO-Link (sink input) mode	SIO (sink input) mode	SIO (source output) mode			
10240	2800H	Use prohibited				—	×	×
10241	2801H	Fast link-up setting status flag				—	○	×
10242 to 10495	2802H to 28FFH	Use prohibited				—	×	×

■ Module-based monitor data

○: Available, ×: Not available

Address		Name				Default value	Read	Write
Decimal	Hexadecimal	IO-Link (standard) mode	IO-Link (sink input) mode	SIO (sink input) mode	SIO (source output) mode			
10496	2900H	Use prohibited				—	×	×
10497	2901H	Channel error status flag				—	○	×
10498 to 10509	2902H to 290DH	CH1 Device validation data				—	○	×
10510 to 10521	290EH to 2919H	CH2 Device validation data				—	○	×
10522 to 10533	291AH to 2925H	CH3 Device validation data				—	○	×
10534 to 10545	2926H to 2931H	CH4 Device validation data				—	○	×
10546 to 10557	2932H to 293DH	CH5 Device validation data				—	○	×
10558 to 10569	293EH to 2949H	CH6 Device validation data				—	○	×
10570 to 10581	294AH to 2955H	CH7 Device validation data				—	○	×
10582 to 10593	2956H to 2961H	CH8 Device validation data				—	○	×
10594 to 10625	2962H to 2981H	Use prohibited				—	×	×
10626	2982H	CH1 Operation mode status				—	○	×
10627	2983H	CH2 Operation mode status				—	○	×
10628	2984H	CH3 Operation mode status				—	○	×
10629	2985H	CH4 Operation mode status				—	○	×
10630	2986H	CH5 Operation mode status				—	○	×
10631	2987H	CH6 Operation mode status				—	○	×
10632	2988H	CH7 Operation mode status				—	○	×
10633	2989H	CH8 Operation mode status				—	○	×
10634 to 10641	298AH, 2991H	Use prohibited				—	×	×
10642	2992H	CH1 Cycle time status		—		—	○	×
10643	2993H	CH2 Cycle time status		—		—	○	×
10644	2994H	CH3 Cycle time status		—		—	○	×
10645	2995H	CH4 Cycle time status		—		—	○	×
10646	2996H	CH5 Cycle time status		—		—	○	×
10647	2997H	CH6 Cycle time status		—		—	○	×
10648	2998H	CH7 Cycle time status		—		—	○	×
10649	2999H	CH8 Cycle time status		—		—	○	×
10650 to 10651	299AH to 299BH	Use prohibited				—	×	×
10652	299CH	IO-Link device parameter upload/download status check flag		—		—	○	×
10653	299DH	Device replacement status				—	○	×
10654, 10655	299EH, 299FH	—			CH1 Number of output ON times integration value	—	○	×

A

Address		Name				Default value	Read	Write
Decimal	Hexadecimal	IO-Link (standard) mode	IO-Link (sink input) mode	SIO (sink input) mode	SIO (source output) mode			
10656, 10657	29A0H, 29A1H	—			CH2 Number of output ON times integration value	—	○	×
10658, 10659	29A2H, 29A3H	—			CH3 Number of output ON times integration value	—	○	×
10660, 10661	29A4H, 29A5H	—			CH4 Number of output ON times integration value	—	○	×
10662, 10663	29A6H, 29A7H	—			CH5 Number of output ON times integration value	—	○	×
10664, 10665	29A8H, 29A9H	—			CH6 Number of output ON times integration value	—	○	×
10666, 10667	29AAH, 29ABH	—			CH7 Number of output ON times integration value	—	○	×
10668, 10669	29ACH, 29ADH	—			CH8 Number of output ON times integration value	—	○	×
10670	29AEH	CH1 IO-Link communication retry count	—			—	○	×
10671	29AFH	CH2 IO-Link communication retry count	—			—	○	×
10672	29B0H	CH3 IO-Link communication retry count	—			—	○	×
10673	29B1H	CH4 IO-Link communication retry count	—			—	○	×
10674	29B2H	CH5 IO-Link communication retry count	—			—	○	×
10675	29B3H	CH6 IO-Link communication retry count	—			—	○	×
10676	29B4H	CH7 IO-Link communication retry count	—			—	○	×
10677	29B5H	CH8 IO-Link communication retry count	—			—	○	×
10678 to 10751	29B6H to 29FFH	Use prohibited				—	×	×

Event information area

■ Station-based current error data

○: Available, ×: Not available

Address		Name				Default value	Read	Write
Decimal	Hexadecimal	IO-Link (standard) mode	IO-Link (sink input) mode	SIO (sink input) mode	SIO (source output) mode			
11008 to 11023	2B00H to 2B0FH	Current error data 1				—	○	×
11024 to 11039	2B10H to 2B1FH	Current error data 2				—	○	×
11040 to 11055	2B20H to 2B2FH	Current error data 3				—	○	×
11056 to 11071	2B30H to 2B3FH	Current error data 4				—	○	×
11072 to 11087	2B40H to 2B4FH	Current error data 5				—	○	×
11088 to 11103	2B50H to 2B5FH	Current error data 6				—	○	×
11104 to 11119	2B60H to 2B6FH	Current error data 7				—	○	×
11120 to 11135	2B70H to 2B7FH	Current error data 8				—	○	×
11136 to 11151	2B80H to 2B8FH	Current error data 9				—	○	×
11152 to 11167	2B90H to 2B9FH	Current error data 10				—	○	×
11168 to 11183	2BA0H to 2BAFH	Current error data 11				—	○	×
11184 to 11199	2BB0H to 2BBFH	Current error data 12				—	○	×
11200 to 11215	2BC0H to 2BCFH	Current error data 13				—	○	×
11216 to 11231	2BD0H to 2BDFH	Current error data 14				—	○	×
11232 to 11247	2BE0H to 2BEFH	Current error data 15				—	○	×
11248 to 11263	2BF0H to 2BFFH	Current error data 16				—	○	×

■ Station-based event data

○: Available, ×: Not available

Address		Name				Default value	Read	Write
Decimal	Hexadecimal	IO-Link (standard) mode	IO-Link (sink input) mode	SIO (sink input) mode	SIO (source output) mode			
11264 to 11268	2C00H to 2C04H	Event data				—	○	×
11269 to 11519	2C05H to 2CFFH	Use prohibited				—	×	×

A

Module control data area

■ Station-based control data

○: Available, ×: Not available

Address		Name				Default value	Read	Write
Decimal	Hexadecimal	IO-Link (standard) mode	IO-Link (sink input) mode	SIO (sink input) mode	SIO (source output) mode			
11520	2D00H	Event history clear command				0	○	○
11521	2D01H	Event history clear completed				—	○	×
11522 to 11526	2D02H to 2D06H	Use prohibited				—	×	×
11527	2D07H	Operating condition setting request flag				0	○	○
11528	2D08H	Operating condition setting completion flag				—	○	×
11529	2D09H	Event read request flag				0	○	○
11530	2D0AH	Event read completion flag				—	○	×
11531 to 11775	2D0BH to 2DFFH	Use prohibited				—	×	×

■ Module-based control data

○: Available, ×: Not available

Address		Name				Default value	Read	Write
Decimal	Hexadecimal	IO-Link (standard) mode	IO-Link (sink input) mode	SIO (sink input) mode	SIO (source output) mode			
11776 to 11903	2E00H to 2E7FH	Use prohibited				—	×	×
11904	2E80H	Number of output ON times integration value clear command				0	○	○
11905	2E81H	Number of output ON times integration value clear completed				—	○	×
11906 to 14027	2E82H to 36CBH	Use prohibited				—	×	×
14028	36CCH	Device replacement flag				0	○	○
14029	36CDH	IO-Link device parameter manual upload command		—		0	○	○
14030	36CEH	IO-Link device parameter manual upload completed		—		—	○	○
14031 to 14102	36CF to 3716H	Use prohibited				—	×	×
14103	3717H	IO-Link communication retry count clear command				0	○	○
14104	3718H	IO-Link communication retry count clear completed				—	○	×
14105 to 14111	3719H to 371FH	Use prohibited				—	×	×
14112 to 14119	3720H to 3727H	Output process data output enabled command at channel error				0	○	○
14120 to 15871	3728H to 3DFFH	Use prohibited				—	×	×

Details of remote buffer memory addresses

This section describes the details of remote buffer memory addresses of the IO-Link module.

Input response time setting

■Remote buffer memory address

Address	Name
1500H	Input response time setting

■Description

The input response time of the IO-Link module is set.

Setting value	Input response time
0H	0ms
2H	1.0ms
3H	1.5ms
4H	5ms
5H (default value)	10ms
6H	20ms
7H	70ms

■Enabling the setting

Turn on and off Operating condition setting request flag (address: 2D07H) to enable the setting.

Output HOLD/CLEAR setting

■Remote buffer memory address

Address	Name
1501H	Output HOLD/CLEAR setting

■Description

Set whether to hold or clear the last status of each output for when the I/O module is disconnected from data link or the CPU module is in STOP status.

Setting value	Output HOLD/CLEAR setting
0H (default value)	CLEAR
1H	HOLD

■Enabling the setting

Turn on and off Operating condition setting request flag (address: 2D07H) to enable the setting.

A

Operation mode setting

■Remote buffer memory address

Address	Name
1700H	CH1 Operation mode setting
1800H	CH2 Operation mode setting
1900H	CH3 Operation mode setting
1A00H	CH4 Operation mode setting
1B00H	CH5 Operation mode setting
1C00H	CH6 Operation mode setting
1D00H	CH7 Operation mode setting
1E00H	CH8 Operation mode setting

■Description

The following shows which operation modes are supported by connected external devices.

External device	Operation mode
SIO device	<ul style="list-style-type: none">• SIO (sink input) mode• SIO (source output) mode
IO-Link device that can perform IO-Link communication and digital input simultaneously	IO-Link (sink input) mode
Other IO-Link device	IO-Link (standard) mode

Set the operation mode of each channel.

Setting value	Operation mode
0H (default value)	Disabled mode
1H	IO-Link (standard) mode
2H	IO-Link (sink input) mode
4H	SIO (sink input) mode
7H	SIO (source output) mode
8H	Power supply mode

■Enabling the setting

Turn on and off Operating condition setting request flag (address: 2D07H) to enable the setting.

Device validation setting

Remote buffer memory address

Address	Name
1703H	CH1 Device validation setting
1803H	CH2 Device validation setting
1903H	CH3 Device validation setting
1A03H	CH4 Device validation setting
1B03H	CH5 Device validation setting
1C03H	CH6 Device validation setting
1D03H	CH7 Device validation setting
1E03H	CH8 Device validation setting

Description

The device validation settings for the device validation function of each channel is set.

Setting value	Device validation setting
0H (default value)	Not validate
1H	Compatibility validation (vendor ID, device ID)
2H	Identity validation (vendor ID, device ID, serial number)

Restriction

This setting is enabled only when the operation mode is the IO-Link mode.

Enabling the setting

Turn on and off Operating condition setting request flag (address: 2D07H) to enable the setting.

Input OFF delay setting

Remote buffer memory address

Address	Name
1704H, 1705H	CH1 Input OFF delay setting
1804H, 1805H	CH2 Input OFF delay setting
1904H, 1905H	CH3 Input OFF delay setting
1A04H, 1A05H	CH4 Input OFF delay setting
1B04H, 1B05H	CH5 Input OFF delay setting
1C04H, 1C05H	CH6 Input OFF delay setting
1D04H, 1D05H	CH7 Input OFF delay setting
1E04H, 1E05H	CH8 Input OFF delay setting

Description

The input OFF delay time is set for each channel.

Delay time refers to the time calculated using the following formula.

- Delay time = Input OFF delay setting × 400 [μs].

Point

Delay time is enabled for the following signals.

- IO-Link (standard) mode: Data masking result
- IO-Link (sink input) mode: DI signal
- SIO (sink input) mode: CQ input signal

Setting range

Setting range is 0 (No delay) or 1 to 150000 (400μs to 60s). Set the values in increments of 400μs. (Default value: 0 (No delay))

Enabling the setting

Turn on and off Operating condition setting request flag (address: 2D07H) to enable the setting.

Input data masking setting

Remote buffer memory address

Address	Name
1706H	CH1 Input data masking setting
1806H	CH2 Input data masking setting
1906H	CH3 Input data masking setting
1A06H	CH4 Input data masking setting
1B06H	CH5 Input data masking setting
1C06H	CH6 Input data masking setting
1D06H	CH7 Input data masking setting
1E06H	CH8 Input data masking setting

Description

The masking value used for the input data masking function of each channel is set.



This setting is enabled only when the operation mode is the IO-Link (standard) mode.

Setting range

The setting range is 0000H to FFFFH. (Default value: 0000H)

Enabling the setting

Turn on and off Operating condition setting request flag (address: 2D07H) to enable the setting.

Swap setting

Remote buffer memory address

Address	Name
1707H	CH1 Swap setting
1807H	CH2 Swap setting
1907H	CH3 Swap setting
1A07H	CH4 Swap setting
1B07H	CH5 Swap setting
1C07H	CH6 Swap setting
1D07H	CH7 Swap setting
1E07H	CH8 Swap setting

Description

Whether the swap setting function of each channel is enabled or disabled is set.

Setting value	Swap setting
0H	Disabled
1H (default value)	Enabled



This setting is enabled only when the operation mode is the IO-Link mode.

Enabling the setting

Turn on and off Operating condition setting request flag (address: 2D07H) to enable the setting.

Event acquisition setting

Remote buffer memory address

Address	Name
1708H	CH1 Event acquisition setting
1808H	CH2 Event acquisition setting
1908H	CH3 Event acquisition setting
1A08H	CH4 Event acquisition setting
1B08H	CH5 Event acquisition setting
1C08H	CH6 Event acquisition setting
1D08H	CH7 Event acquisition setting
1E08H	CH8 Event acquisition setting

Description

The event acquisition function for the IO-Link device of each channel is set.

b15	b14	b13	b12	b11	b10	b9	b8	b7	b6	b5	b4	b3	b2	b1	b0
0 (fixed)													(2)	(1)	

(1) Notifications

(2) Warnings

• Notifications

Setting value	Notifications
0H (default value)	Do not retrieve
1H	Retrieve as events

• Warnings

Setting value	Warnings
0H	Do not retrieve
1H (default value)	Retrieve as events
2H	Retrieve as errors

Restriction

This setting is enabled only when the operation mode is the IO-Link mode.

Enabling the setting

Turn on and off Operating condition setting request flag (address: 2D07H) to enable the setting.

Bit segment setting

Remote buffer memory address

Address	Name
1709H to 1719H	CH1 Bit segment setting
1809H to 1819H	CH2 Bit segment setting
1909H to 1919H	CH3 Bit segment setting
1A09H to 1A19H	CH4 Bit segment setting
1B09H to 1B19H	CH5 Bit segment setting
1C09H to 1C19H	CH6 Bit segment setting
1D09H to 1D19H	CH7 Bit segment setting
1E09H to 1E19H	CH8 Bit segment setting

Description

The data (the number of segments, bit offset, bit length) used for the bit segment function is set. ( Page 78 Bit segment function)

Ex.

The following shows settings for CH1 Bit segment setting (address: 1709H to 1719H).

n: 1 to 16

Address	b15	b14	b13	b12	b11	b10	b9	b8	b7	b6	b5	b4	b3	b2	b1	b0
1709H	0 (fixed)											Number of segments				
170AH	0 (fixed)			No.1 bit length				No.1 bit offset								
⋮	⋮															
1719H	0 (fixed)			No.16 bit length				No.16 bit offset								

Restriction

This setting is enabled only when the operation mode is the IO-Link mode.

Number of segments

The number of segments is the number of times input process data is to be segmented. If the bit segmentation is not used, set 0.

Bit length, bit offset

Set the bit length and bit offset of the input process data to be segmented in Bit length and Bit offset. Bit segmenting of input process data is performed from the set offset position and at the bit number set for the bit length.

Point

The No.2 bit length, No.2 bit offset (address: 170BH), and onwards will be enabled according to the value set for the number of segments.

Setting range

- Number of segments: The setting range is 0 to 16. (Default value: 0)
- Bit length: The setting range is 0 to 16. (Default value: 0)
- Bit offset: The setting range is 0 to 255. (Default value: 0)

Enabling the setting

Turn on and off Operating condition setting request flag (address: 2D07H) to enable the setting.

Fast link-up setting status flag

Remote buffer memory address

Address	Name
2801H	Fast link-up setting status flag

Description

The setting status of the fast link-up function is stored. The setting status of the fast link-up function depends on the status of the function setting switch at power-on. (Page 30 Function setting switch setting)

b15	b14	b13	b12	b11	b10	b9	b8	b7	b6	b5	b4	b3	b2	b1	b0
0 (fixed)														(2)	(1)

- (1) ON: PORT1 enabled, OFF: PORT1 disabled
 (2) ON: PORT2 enabled, OFF: PORT2 disabled

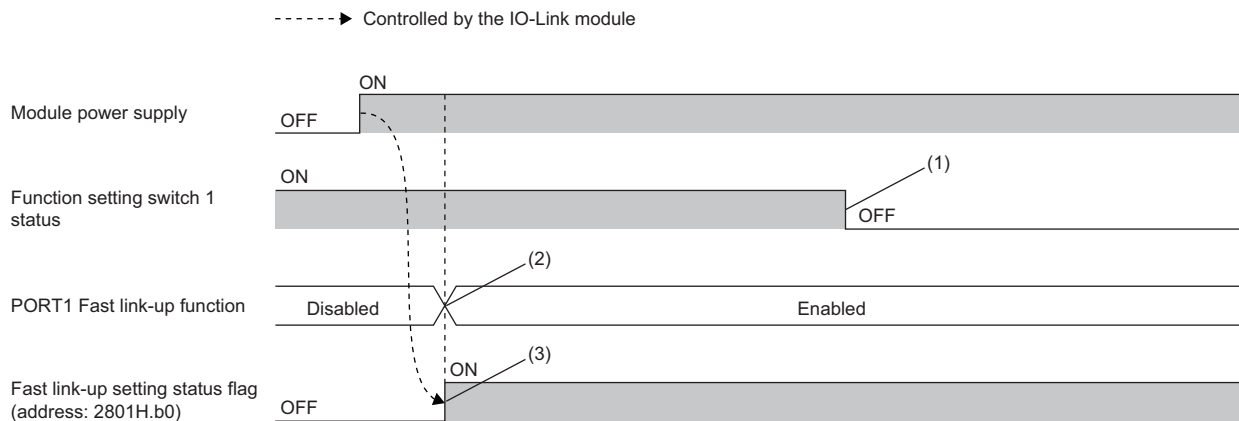

- (1) The status of the fast link-up function (enabled or disabled) does not change even if the status of the function setting switch 1 changes during operation.
 (2) The fast link-up function is enabled or disabled depending on the status of the function setting switch 1 at power-on.
 (3) Fast link-up setting status flag (PORT1) does not indicate the status of the function setting switch 1 but indicates the status of the fast link-up function of PORT1 (enabled or disabled).

Channel error status flag

Remote buffer memory address

Address	Name
2901H	Channel error status flag

Description

The bit of the corresponding channel turns on when a minor error occurs.

b15	b14	b13	b12	b11	b10	b9	b8	b7	b6	b5	b4	b3	b2	b1	b0
0 (fixed)								CH8	CH7	CH6	CH5	CH4	CH3	CH2	CH1

CH□ ON: Minor error occurred, OFF: Minor error has not occurred

Device validation data

Remote buffer memory address

Address	Name
2902H to 290DH	CH1 Device validation data
290EH to 2919H	CH2 Device validation data
291AH to 2925H	CH3 Device validation data
2926H to 2931H	CH4 Device validation data
2932H to 293DH	CH5 Device validation data
293EH to 2949H	CH6 Device validation data
294AH to 2955H	CH7 Device validation data
2956H to 2961H	CH8 Device validation data

Description

This data shows device validation data for IO-Link devices held by the IO-Link module.

The following shows the details of device validation data for each channel.

Name	Address	Name
CH1 Device validation data	2902H	Revision ID
	2903H	Vendor ID
	2904H, 2905H	Device ID
	2906H to 290DH	Serial number
CH2 Device validation data	290EH	Revision ID
	290FH	Vendor ID
	2910H, 2911H	Device ID
	2912H to 2919H	Serial number
CH3 Device validation data	291AH	Revision ID
	291BH	Vendor ID
	291CH, 291DH	Device ID
	291EH to 2925H	Serial number
CH4 Device validation data	2926H	Revision ID
	2927H	Vendor ID
	2928H, 2929H	Device ID
	292AH to 2931H	Serial number
CH5 Device validation data	2932H	Revision ID
	2933H	Vendor ID
	2934H, 2935H	Device ID
	2936H to 293DH	Serial number
CH6 Device validation data	293EH	Revision ID
	293FH	Vendor ID
	2940H, 2941H	Device ID
	2942H to 2949H	Serial number
CH7 Device validation data	294AH	Revision ID
	294BH	Vendor ID
	294CH, 294DH	Device ID
	294EH to 2955H	Serial number
CH8 Device validation data	2956H	Revision ID
	2957H	Vendor ID
	2958H, 2959H	Device ID
	295AH to 2961H	Serial number

Operation mode status

■ Remote buffer memory address

Address	Name
2982H	CH1 Operation mode status
2983H	CH2 Operation mode status
2984H	CH3 Operation mode status
2985H	CH4 Operation mode status
2986H	CH5 Operation mode status
2987H	CH6 Operation mode status
2988H	CH7 Operation mode status
2989H	CH8 Operation mode status

■ Description

The current operation mode of each channel is stored.

Stored value	Operation mode status
0H	Disabled mode
1H	IO-Link (standard) mode
2H	IO-Link (sink input) mode
4H	SIO (sink input) mode
7H	SIO (source output) mode
8H	Power supply mode

Cycle time status

Remote buffer memory address

Address	Name
2992H	CH1 Cycle time status
2993H	CH2 Cycle time status
2994H	CH3 Cycle time status
2995H	CH4 Cycle time status
2996H	CH5 Cycle time status
2997H	CH6 Cycle time status
2998H	CH7 Cycle time status
2999H	CH8 Cycle time status

Description

The actual operating cycle time of each channel is stored.



This setting is enabled only when the operation mode is the IO-Link mode.

IO-Link device parameter upload/download status check flag

Remote buffer memory address

Address	Name
299CH	IO-Link device parameter upload/download status check flag

Description

IO-Link device parameter upload/download status check flag (address: 299CH) turns on under the following circumstances.

- When IO-Link device parameter upload fails
- When IO-Link device parameter download fails
- When there is a possibility that download was not performed normally due to the current firmware version of the IO-Link device being different from that at time of upload.

When this flag turns on, the following states may have occurred.

- The IO-Link device is not operating normally.
- Because parameters were not uploaded normally, data may not be downloaded correctly at the next download.

This flag turns off when download and upload are completed successfully. It also turns off if the IO-Link device does not support the data storage function.



This setting is enabled only when the operation mode is the IO-Link mode.

b15	b14	b13	b12	b11	b10	b9	b8	b7	b6	b5	b4	b3	b2	b1	b0
0 (fixed)								CH8	CH7	CH6	CH5	CH4	CH3	CH2	CH1

CH□ ON: Check required, OFF: Normal

Device replacement status

Remote buffer memory address

Address	Name
299DH	Device replacement status



Description

The device replacement status of each channel is stored.



The following occurs when Device replacement status (address: 299DH) is on.

- Disconnections will not be detected in the corresponding channel.
- Input from or output to IO-Link devices is disabled in the IO-Link mode.
- Input from or output to SIO devices is turned off in the SIO mode.

Using Device replacement status (address: 299DH), the corresponding channel turns on under the following circumstances.

- When the corresponding channel turns on using Device replacement flag (address: 36CCH) ( Page 185 Device replacement flag)
- When the corresponding channel was set using "Start Device Changeout" of "Command Execution of Device Station" in the engineering tool ( Page 101 Device replacement start procedure)

Using Device replacement status (address: 299DH), the corresponding channel turns off under the following circumstances.

- When the corresponding channel turns off using Device replacement flag (address: 36CCH) ( Page 185 Device replacement flag)
- When the corresponding channel was set using "Device Changeout Complete" of "Command Execution of Device Station" in the engineering tool ( Page 102 Device replacement completion procedure)

b15	b14	b13	b12	b11	b10	b9	b8	b7	b6	b5	b4	b3	b2	b1	b0
0 (fixed)								CH8	CH7	CH6	CH5	CH4	CH3	CH2	CH1

CH□ ON: Device replacement permitted, OFF: Device replacement prohibited

Number of output ON times integration value

Remote buffer memory address

Address	Name
299EH, 299FH	CH1 Number of output ON times integration value
29A0H, 29A1H	CH2 Number of output ON times integration value
29A2H, 29A3H	CH3 Number of output ON times integration value
29A4H, 29A5H	CH4 Number of output ON times integration value
29A6H, 29A7H	CH5 Number of output ON times integration value
29A8H, 29A9H	CH6 Number of output ON times integration value
29AAH, 29ABH	CH7 Number of output ON times integration value
29ACH, 29ADH	CH8 Number of output ON times integration value

Description

Integration values of the number of output ON times integration function for each channel are saved as 32-bit signed binary data. ( Page 87 Number of output ON times integration function)

Values read from the non-volatile memory when the CPU module is powered on or the remote reset is executed are stored in the number of output ON times integration value.

Restriction

This setting is enabled only when the operation mode is the SIO (source output) mode.

IO-Link communication retry count

Remote buffer memory address

Address	Name
29AEH	CH1 IO-Link communication retry count
29AFH	CH2 IO-Link communication retry count
29B0H	CH3 IO-Link communication retry count
29B1H	CH4 IO-Link communication retry count
29B2H	CH5 IO-Link communication retry count
29B3H	CH6 IO-Link communication retry count
29B4H	CH7 IO-Link communication retry count
29B5H	CH8 IO-Link communication retry count

Description

The integration value counted using the IO-Link communication retry count integration function of each channel is stored.
( Page 81 IO-Link communication retry count integration function)

Restriction

This setting is enabled only when the operation mode is the IO-Link mode.

Current error data

Remote buffer memory address

Address	Name
2B00H to 2B0FH	Current error data 1
2B10H to 2B1FH	Current error data 2
2B20H to 2B2FH	Current error data 3
2B30H to 2B3FH	Current error data 4
2B40H to 2B4FH	Current error data 5
2B50H to 2B5FH	Current error data 6
2B60H to 2B6FH	Current error data 7
2B70H to 2B7FH	Current error data 8
2B80H to 2B8FH	Current error data 9
2B90H to 2B9FH	Current error data 10
2BA0H to 2BAFH	Current error data 11
2BB0H to 2BBFH	Current error data 12
2BC0H to 2BCFH	Current error data 13
2BD0H to 2BDFH	Current error data 14
2BE0H to 2BEFH	Current error data 15
2BF0H to 2BFFH	Current error data 16

■Description

Up to 16 errors (15 minor/moderate errors, 1 major error) of the module are recorded.

Ex.

The following shows the content stored in Current error data 1 (address: 2B00H to 2B0FH).

Address	b15	b14	b13	b12	b11	b10	b9	b8	b7	b6	b5	b4	b3	b2	b1	b0
2B00H	Error code															
2B01H																
2B02H	System area															
2B03H	First two digits of the year								Last two digits of the year							
2B04H	Month								Date							
2B05H	Hour								Minute							
2B06H	Second								00H (Fixed)							
2B07H	Error code details 1															
2B08H	Error code details 2															
2B09H	Error code details 3															
2B0AH	System area															
⋮																
2B0FH																

Item	Description	Storage example*1
Error code	The error code for the error that occurred is stored.	—
First two digits of the year/Last two digits of the year	The items on the left are stored in BCD code.	2012H
Month/Date		0829H
Hour/Minute		1035H
Second		4000H
Error code details 1	The detailed information of some errors is stored.	—
Error code details 2	The data to be stored depend on the error. (☞ Page 134 Error Codes and Warning Codes)	—
Error code details 3		—

*1 Those values show example when the error occurs at 10:35:40, August 29th, 2012.

*2 The clock information of the error that occurred is based on the clock information acquired from the CPU module of the master station. When an error has occurred before the clock information is acquired from the CPU module, the error time is not recorded.

It is stored in the same format as Current error data 2 to Current error data 16 (address: 2B10H to 2BFFH) and Current error data 1 (address: 2B00H to 2B0FH).

For the error code, refer to the following.

☞ Page 134 Error Codes and Warning Codes

■Storage order of error data

The latest error is stored in Current error data 1 (address: 2B00H to 2B0FH).

Errors that occurred up to this time are stored in Current error data 2 to Current error data 16 (address: 2B10H to 2BFFH) in reverse chronological order.

Point

When 15 minor and moderate errors are stored in Current error data, new minor and moderate errors that occur are stored in the IO-Link module.

When 15 minor and moderate errors are stored, even if one error is eliminated, the minor and moderate errors saved inside the IO-Link module are stored.

If the same cause of errors occur continuously, only the error that occurred first is stored.

Also, new errors that occur after a major error are not held.

A

Event data

Remote buffer memory address

Address	Name
2C00H to 2C04H	Event data

Description

The following shows the content stored in Event data (address: 2C00H to 2C04H).

Address	b15	b14	b13	b12	b11	b10	b9	b8	b7	b6	b5	b4	b3	b2	b1	b0
2C00H	Event															
2C01H																
2C02H	Event code details 1															
2C03H	Event code details 2															
2C04H	Event code details 3															

Reading of event data

Event data is read by turning on Event read request flag (address: 2D09H).

Event history clear command

Remote buffer memory address

Address	Name
2D00H	Event history clear command

Description

The event history stored in the IO-Link module is cleared.

b15	b14	b13	b12	b11	b10	b9	b8	b7	b6	b5	b4	b3	b2	b1	b0
0 (fixed)															(1)

(1) ON: Commanded, OFF: Not commanded

Operation of Event history clear

The following occurs when Event history clear command (address: 2D00H) is set to Commanded (ON).

- Event data (address: 2C00H to 2C04H) is cleared.
- Event status flag (RX1D) turns off.

- Controlled by the program
- - - - -→ Controlled by the IO-Link module

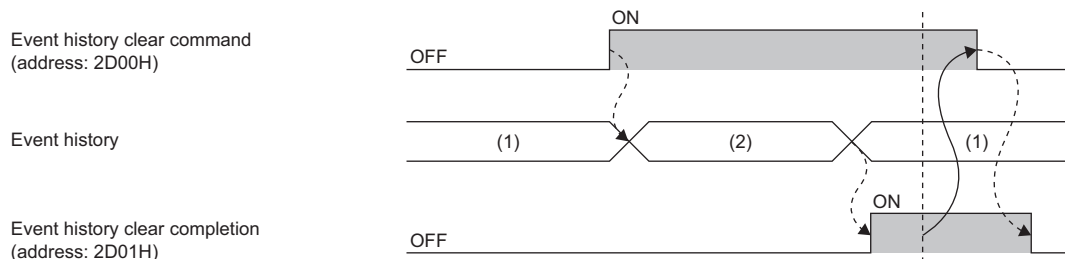

- (1) Periodically read and check the event history using the REMFR instruction.
 (2) Event history clear processing

Point

Current error data 1 to 16 (address: 2B00H to 2BFFH) are not cleared. To clear Current error data 1 to 16 (address: 2B00H to 2BFFH), turn on Error clear request flag (RWw0.b0). (Page 159 Error clear request flag (RWw0.b10))

Event history clear completed

Remote buffer memory address

Address	Name
2D01H	Event history clear completed

Description

The clear completion status of the event history stored in the IO-Link module is shown.

Stored value	Event history clear completed
0H	Not completed
1H	Completed

Operation of Event history clear

When the event history clear is completed, Event history clear completed (address: 2D01H) is turned to Completed (1). For the timing of Not completed (0) → Completed (1) → Not completed (0), refer to the following.

☞ Page 180 Event history clear command

Operating condition setting request flag

Remote buffer memory address

Address	Name
2D07H	Operating condition setting request flag

Description

This flag is used for reflecting parameters after writing parameter data to the remote buffer memory.

b15	b14	b13	b12	b11	b10	b9	b8	b7	b6	b5	b4	b3	b2	b1	b0
0 (fixed)															(1)

(1) ON: Request, OFF: Not performed

■ Operation of Operating condition setting request

After writing parameter data to the remote buffer memory, request (ON) Operating condition setting request flag (address: 2D07H). If Operating condition setting request flag (address: 2D07H) is not requested (ON), parameters written to the buffer memory will not be reflected.

Point

- Do not send another request (ON) for Operating condition setting request flag (address: 2D07H) before Operating condition setting completion flag (address: 2D08H) has completed (ON). When performed, correct operation of the IO-Link module cannot be guaranteed.
- If Operating condition setting request (address: 2D07H) is requested (ON), Parameter data errors (out-of-range settings) (error code: 3008H) is cleared from Current error data 1 to 16 (address: 2B00H to 2BFFH). However, if the cause of Parameter data error (out-of-range settings) (error code: 3008H) is not eliminated, Parameter data error (out-of-range settings) (error code: 3008H) will again be stored in Current error data 1 to 16 (address: 2B00H to 2BFFH).

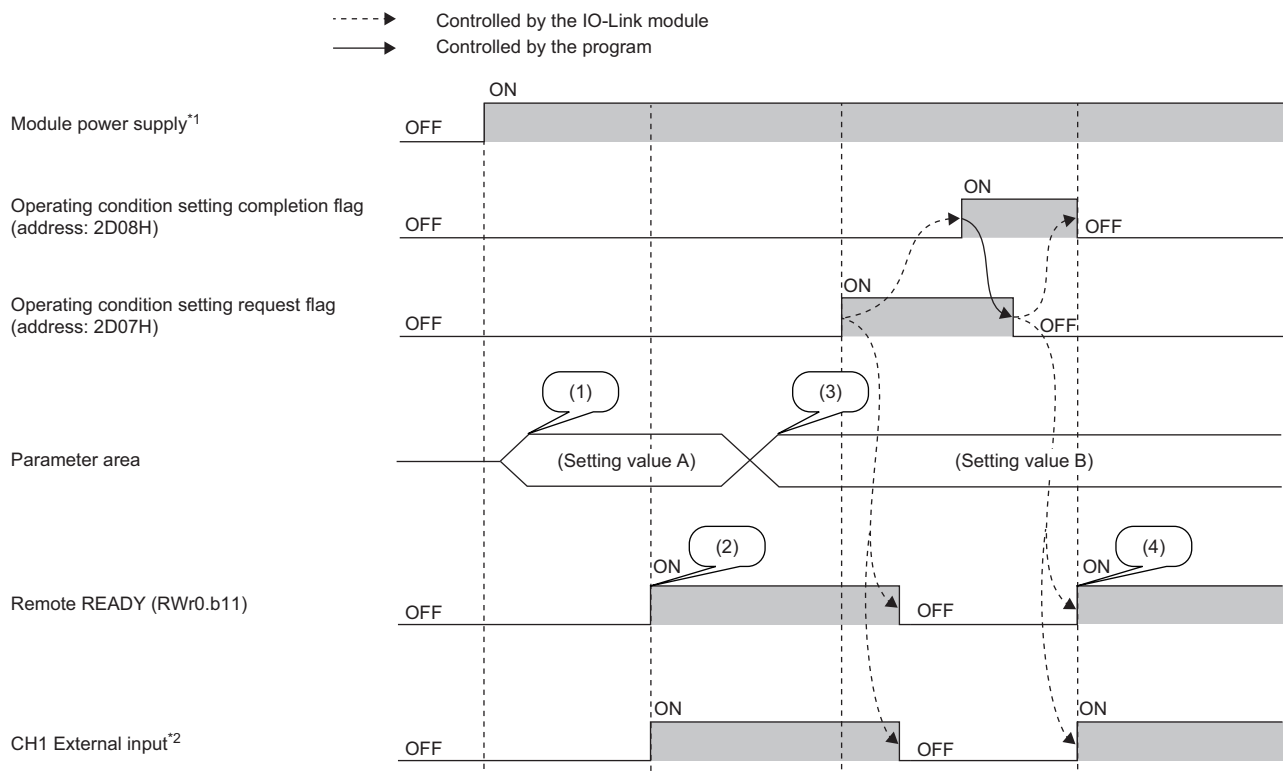

- (1) Reading of settings from internal non-volatile memory
 (2) Starting of operation with setting value A
 (3) Setting value changes by users
 (4) Starting of operation with parameter setting value B at this timing

*1 When a data link is established at the same time the module is powered on

*2 When an external input device for CH1 is on

Operating condition setting completion flag

Remote buffer memory address

Address	Name
2D08H	Operating condition setting completion flag

Description

After the operation condition is changed, Operating condition setting completion flag (address: 2D08H) turns on.

Turn off Operating condition setting request flag (address: 2D07H) after Operating condition setting completion flag (address: 2D08H) is turned on.

For the timing of Not performed (OFF) → Request (ON) → Not performed (OFF) of Operation condition setting request flag (address: 2D07H), refer to the following.

 Page 181 Operating condition setting request flag

b15	b14	b13	b12	b11	b10	b9	b8	b7	b6	b5	b4	b3	b2	b1	b0
0 (fixed)															(1)

(1) ON: Completed, OFF: Not completed

Event read request flag

Remote buffer memory address

Address	Name
2D09H	Event read request flag

Description

When this flag is turned on, the oldest event among events that have not been checked will be read to Event data (address: 2C00H to 2C04H).

b15	b14	b13	b12	b11	b10	b9	b8	b7	b6	b5	b4	b3	b2	b1	b0
0 (fixed)															(1)

(1) ON: Commanded, OFF: Not commanded

Operation of Event read request flag

Each time this flag is turned on, one new event will be read to Event data (address: 2C00H to 2C04H).

Event status flag (RX1D) turns off when all events are read.

Point

If this flag is turned from Not Commanded (OFF) to Commanded (ON) again after all events are read, Event data (address: 2C00H to 2C04H) will be cleared.

Event read completion flag

Remote buffer memory address

Address	Name
2D0AH	Event read completion flag

Description

This flag shows the completion status of Event read request flag (address: 2D09H).

Stored value	Event read completion flag
0H	Not completed
1H	Completed

Operation of Event read completion flag

When reading of the event has completed, Event read completion flag (address: 2D0AH) will be Completed (1).

When Event read request flag (address: 2D09H) is turned off, Event read completion flag (address: 2D0AH) turns off.

Number of output ON times integration value clear command

Remote buffer memory address

Address	Name
2E80H	Number of output ON times integration value clear command

Description

Values stored in CH□ Number of output ON times integration value (address: 299EH to 29ADH) are cleared.

b15	b14	b13	b12	b11	b10	b9	b8	b7	b6	b5	b4	b3	b2	b1	b0
0 (fixed)								CH8	CH7	CH6	CH5	CH4	CH3	CH2	CH1

CH□ ON: Commanded, OFF: Not commanded

Operation of Number of output ON times integration value clear

When the bit of the corresponding channel of Number of output ON times integration value clear command (address: 2E80H) is set to Commanded (ON), CH□ Number of output ON times integration value (address: 299EH to 29ADH) of the corresponding channel is cleared.

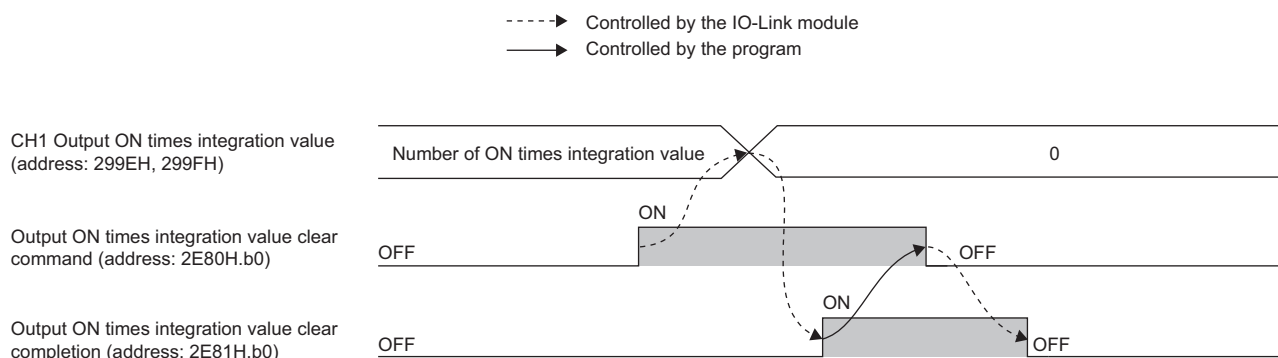

- (1) Number of output ON times integration value clear processing
- (2) Periodically read and check the event history using the REMFR instruction.

Clearing by turning on Number of output ON times integration value clear command

The number of output ON times integration value is cleared only once when the bit of the corresponding channel of Number of output ON times integration value clear command (address: 2E80H) is set to Commanded (ON). The number of output ON times integration function is executed while the specified bit remains set to Commanded (ON).

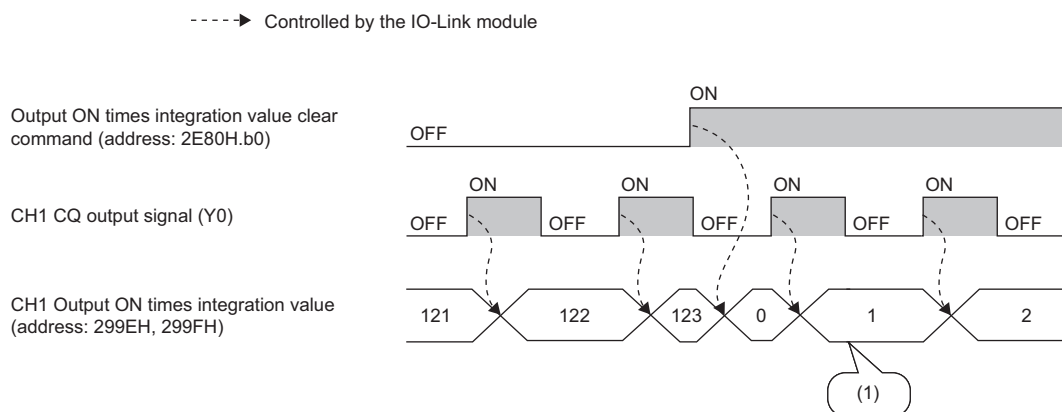

- (1) The number of output ON times integration function operates even if Number of output ON times integration value clear command is left on.

Number of output ON times integration value clear completed

Remote buffer memory address

Address	Name
2E81H	Number of output ON times integration value clear completed

Description

The clear completion status of CH□ Number of output ON times integration value (address: 299EH to 29ADH) is shown.

b15	b14	b13	b12	b11	b10	b9	b8	b7	b6	b5	b4	b3	b2	b1	b0
0 (fixed)								CH8	CH7	CH6	CH5	CH4	CH3	CH2	CH1

CH□ ON: Completed, OFF: Not completed

Operation of Number of output ON times integration value clear

Once clearing of the number of output ON times integration value is completed, the bit of the corresponding channel of Number of output ON times integration value clear completed (address: 2E81H) will be Completed (1).

For the timing of turning the bit from Not completed (0) → Completed (1) → Not completed (0), refer to the following.

☞ Page 184 Number of output ON times integration value clear command

Device replacement flag

Remote buffer memory address

Address	Name
36CCH	Device replacement flag

Description

Set this flag to perform device replacement with the IO-Link module being powered on.

When this flag is turned on, the corresponding Device replacement status (address: 299DH) turns on.

Replace the device when Device replacement status (address: 299DH) is on. Turn off this flag after replacement.

The following occurs when this flag is on.

- Input from or output to IO-Link devices is disabled in the IO-Link mode.
- Input from or output to SIO devices is turned off in the SIO mode.

When this flag is turned off, the corresponding Device replacement status (address: 299DH) turns off.

b15	b14	b13	b12	b11	b10	b9	b8	b7	b6	b5	b4	b3	b2	b1	b0
0 (fixed)								CH8	CH7	CH6	CH5	CH4	CH3	CH2	CH1

CH□ ON: Replace, OFF: Not performed

IO-Link device parameter manual upload command

Remote buffer memory address

Address	Name
36CDH	IO-Link device parameter manual upload command

Description

Turn on this flag to manually upload IO-Link device parameters.

Once upload of IO-Link device parameters is completed, IO-Link device parameter manual upload completed (address: 36CEH) turns on.

Turn off this flag after checking that IO-Link device parameter manual upload completed (address: 36CEH) has turned on.

When this flag is turned off, IO-Link device parameter manual upload completed (address: 36CEH) is turned off.

Upload of IO-Link device parameters is performed only once when this flag is turned on and off.

Manual upload of IO-Link device parameters is disabled under the following circumstances.

- When CH□ IO-Link device connection status flag (RX20 to RX27) is off (☞ Page 149 IO-Link device status flag)
- When a device validation error occurs
- When IO-Link device parameters could not be accessed

Restriction

This setting is enabled only when the operation mode is the IO-Link mode.

b15	b14	b13	b12	b11	b10	b9	b8	b7	b6	b5	b4	b3	b2	b1	b0
0 (fixed)								CH8	CH7	CH6	CH5	CH4	CH3	CH2	CH1

CH□ ON: Commanded, OFF: Not commanded

IO-Link device parameter manual upload completed

Remote buffer memory address

Address	Name
36CEH	IO-Link device parameter manual upload completed

Description

The completion of IO-Link device parameter manual upload command (address: 36CDH) is indicated.

b15	b14	b13	b12	b11	b10	b9	b8	b7	b6	b5	b4	b3	b2	b1	b0
0 (fixed)								CH8	CH7	CH6	CH5	CH4	CH3	CH2	CH1

CH□ ON: Completed, OFF: Not completed

IO-Link communication retry count clear command

Remote buffer memory address

Address	Name
3717H	IO-Link communication retry count clear command

Description

CH□ IO-Link communication retry count (address: 29AEH to 29B5H) is cleared.

b15	b14	b13	b12	b11	b10	b9	b8	b7	b6	b5	b4	b3	b2	b1	b0
0 (fixed)								CH8	CH7	CH6	CH5	CH4	CH3	CH2	CH1

CH□ ON: Commanded, OFF: Not commanded

Operation of IO-Link communication retry count clear

When the bit of the corresponding channel of IO-Link communication retry count clear command (address: 3717H) is set to Commanded (1), CH□ IO-Link communication retry count (address: 29AEH to 29B5H) of the corresponding channel is cleared.

Turn this flag off after checking that IO-Link communication retry count clear completed (address: 3718H) is turned on. When this flag is turned off, IO-Link communication retry count clear completed (address: 3718H) is turned off.

Clearing using IO-Link communication retry count clear command

Clearing of the IO-Link communication retry count is performed only once when the bit of the corresponding channel of IO-Link communication retry count clear command (address: 3717H) is set to Commanded (1). The process data communication retry count integration function is executed even while the specified bit remains set to Commanded (1).

IO-Link communication retry count clear completed

Remote buffer memory address

Address	Name
3718H	IO-Link communication retry count clear completed

Description

The completion status of clearing of CH□ IO-Link communication retry count (address: 29AEH to 29B5H) is shown.

b15	b14	b13	b12	b11	b10	b9	b8	b7	b6	b5	b4	b3	b2	b1	b0
0 (fixed)								CH8	CH7	CH6	CH5	CH4	CH3	CH2	CH1

CH□ ON: Completed, OFF: Not completed

Operation of IO-Link communication retry count clear

Once clearing of the IO-Link communication retry count is completed, the bit of the corresponding channel of IO-Link communication retry count clear completed (address: 3718H) will be Completed (1).

Output process data output enabled command at channel error

Remote buffer memory address

Address	Name
3720H	CH1 Output process data output enabled command at channel error
3721H	CH2 Output process data output enabled command at channel error
3722H	CH3 Output process data output enabled command at channel error
3723H	CH4 Output process data output enabled command at channel error
3724H	CH5 Output process data output enabled command at channel error
3725H	CH6 Output process data output enabled command at channel error
3726H	CH7 Output process data output enabled command at channel error
3727H	CH8 Output process data output enabled command at channel error

Description

If a channel error occurs on the IO-Link device of the corresponding channel, whether to permit or prohibit the output of output process data is set.

b15	b14	b13	b12	b11	b10	b9	b8	b7	b6	b5	b4	b3	b2	b1	b0
0 (fixed)															(1)

(1) ON: Permitted, OFF: Prohibited (default)

Restriction

Before using this command, check the serial number of the IO-Link module. ( Page 201 Added and Enhanced Functions)

Appendix 4 IO-Link Device Replacement Procedure

When the IO-Link module is replaced while the module is powered off

The following shows the procedure for replacing an IO-Link device with another IO-Link device in a state that the IO-Link module power supply is off.

The replacement procedure may differ depending on conditions. (☞ Page 189 Condition)

Replacement procedure

- ➊ Set "Device Validation Setting" to "0: Do not validate".
☞ Page 70 IO-Link device validation function
- ➋ Power off the IO-Link module.
- ➌ Remove the connected IO-Link device, and replace it with a new IO-Link device.
☞ Page 39 Wiring of IO-Link terminal block and external devices
- ➍ Create or change a program. Skip this step if not creating programs or making changes.
☞ Page 105 PROGRAMMING
- ➎ Power on the IO-Link module.
- ➏ Configure the parameter setting of the IO-Link device.
☞ Page 54 IO-Link Device Parameter Setting
- ➐ Check the event history for errors and confirm that events are being stored as intended.
☞ Page 132 Method for Checking the Event History
- ➑ Return "Device Validation Setting" back to the original setting.
- ➒ Restart the control.

Condition

Device validation setting	New IO-Link device	IO-Link device parameter used after replacement	Replacement procedure
Not validate	Compatible	When IO-Link device parameters are downloaded from the non-volatile memory of the IO-Link module	Set "Device Validation Setting" to "1. Compatibility Validation (vendor information and model name)". → ➊ → ➋ → ➌ → ➍ → ➎ → ➏ → ➐ → ➑
		When IO-Link device parameters are uploaded from the new IO-Link device	➊ → ➋ → ➌ → ➍ → ➎ → ➏ → ➐
		When IO-Link device parameters are newly set	➊ → ➋ → ➌ → ➍ → ➎ → ➏ → ➐
	Incompatible	When IO-Link device parameters are downloaded from the non-volatile memory of the IO-Link module	Cannot be used.
		When IO-Link device parameters are uploaded from the new IO-Link device	➊ → ➋ → ➌ → ➍ → ➎ → ➏ → ➐
		When IO-Link device parameters are newly set	➊ → ➋ → ➌ → ➍ → ➎ → ➏ → ➐
Compatibility validation	Compatible	When IO-Link device parameters are downloaded from the non-volatile memory of the IO-Link module	➊ → ➋ → ➌ → ➍ → ➎ → ➏ → ➐
		When IO-Link device parameters are uploaded from the new IO-Link device	➑ → ➊ → ➋ → ➌ → ➍ → ➎ → ➏ → ➐ → ➑
		When IO-Link device parameters are newly set	➊ → ➋ → ➌ → ➍ → ➎ → ➏ → ➐
	Incompatible	When IO-Link device parameters are downloaded from the non-volatile memory of the IO-Link module	Cannot be used.
		When IO-Link device parameters are uploaded from the new IO-Link device	➑ → ➊ → ➋ → ➌ → ➍ → ➎ → ➏ → ➐ → ➑
		When IO-Link device parameters are newly set	Perform all procedures.

Device validation setting	New IO-Link device	IO-Link device parameter used after replacement	Replacement procedure
Identity validation	Compatible	When IO-Link device parameters are downloaded from the non-volatile memory of the IO-Link module	Set "Device Validation Setting" to "1. Compatibility Validation (vendor information and model name)". → ② → ③ → ④ → ⑤ → ⑦ → ⑧ → ⑨
		When IO-Link device parameters are uploaded from the new IO-Link device	① → ② → ③ → ④ → ⑤ → ⑦ → ⑧ → ⑨
		When IO-Link device parameters are newly set	Perform all procedures.
	Incompatible	When IO-Link device parameters are downloaded from the non-volatile memory of the IO-Link module	Cannot be used.
		When IO-Link device parameters are uploaded from the new IO-Link device	① → ② → ③ → ④ → ⑤ → ⑦ → ⑧ → ⑨
		When IO-Link device parameters are newly set	Perform all procedures.

When the IO-Link module is replaced while the module is powered on

The following shows the procedure for replacing an IO-Link device with another IO-Link device in a state that the IO-Link module power supply is on.

The replacement procedure may differ depending on conditions. (📄 Page 191 Condition)

Replacement procedure

- ➊ Set "Device Validation Setting" to "0: Do not validate".
📄 Page 70 IO-Link device validation function
- ➋ Set the target channel using the "Start Device Changeout" of "Command Execution of Device Station".
📄 Page 99 Device Replacement Function
- ➌ Remove the connected IO-Link device, and replace it with a new IO-Link device.
📄 Page 39 Wiring of IO-Link terminal block and external devices
- ➍ Create or change a program. Skip this step if not creating programs or making changes.
📄 Page 105 PROGRAMMING
- ➎ Set the target channel using the "Device Changeout Complete" of "Command Execution of Device Station".
📄 Page 99 Device Replacement Function
- ➏ Return "Device Validation Setting" back to the original setting.
- ➐ Configure the parameter setting of the IO-Link device.
📄 Page 54 IO-Link Device Parameter Setting
- ➑ Check the event history for errors and confirm that events are being stored as intended.
📄 Page 132 Method for Checking the Event History
- ➒ Restart the control.

Condition

Device validation setting	New IO-Link device	IO-Link device parameter used after replacement	Replacement procedure
Not validate	Compatible	When IO-Link device parameters are downloaded from the non-volatile memory of the IO-Link module	Set "Device Validation Setting" to "1. Compatibility Validation (vendor information and model name)". ➔➊➔➋➔➌➔➍➔➎➔➏➔➐
		When IO-Link device parameters are uploaded from the new IO-Link device	➊➔➋➔➌➔➍➔➎➔➏➔➐
		When IO-Link device parameters are newly set	➊➔➋➔➌➔➍➔➎➔➏➔➐
	Incompatible	When IO-Link device parameters are downloaded from the non-volatile memory of the IO-Link module	Cannot be used.
		When IO-Link device parameters are uploaded from the new IO-Link device	➊➔➋➔➌➔➍➔➎➔➏➔➐
		When IO-Link device parameters are newly set	➊➔➋➔➌➔➍➔➎➔➏➔➐
Compatibility validation	Compatible	When IO-Link device parameters are downloaded from the non-volatile memory of the IO-Link module	➊➔➋➔➌➔➍➔➎➔➏➔➐
		When IO-Link device parameters are uploaded from the new IO-Link device	➑➔➊➔➋➔➌➔➍➔➎➔➏➔➐
		When IO-Link device parameters are newly set	➊➔➋➔➌➔➍➔➎➔➏➔➐
	Incompatible	When IO-Link device parameters are downloaded from the non-volatile memory of the IO-Link module	Cannot be used.
		When IO-Link device parameters are uploaded from the new IO-Link device	➑➔➊➔➋➔➌➔➍➔➎➔➏➔➐
		When IO-Link device parameters are newly set	Perform all procedures.

Device validation setting	New IO-Link device	IO-Link device parameter used after replacement	Replacement procedure
Identity validation	Compatible	When IO-Link device parameters are downloaded from the non-volatile memory of the IO-Link module	Set "Device Validation Setting" to "1. Compatibility Validation (vendor information and model name)". → 2 → 3 → 4 → 5 → 6 → 8 → 9
		When IO-Link device parameters are uploaded from the new IO-Link device	1 → 2 → 3 → 4 → 5 → 6 → 8 → 9
		When IO-Link device parameters are newly set	Perform all procedures.
	Incompatible	When IO-Link device parameters are downloaded from the non-volatile memory of the IO-Link module	Cannot be used.
		When IO-Link device parameters are uploaded from the new IO-Link device	1 → 2 → 3 → 4 → 5 → 6 → 8 → 9
		When IO-Link device parameters are newly set	Perform all procedures.

Appendix 5 Processing Time

Input response time

Input response time is the amount of time it takes from when input process data, CQ input signals, and DI signals are entered into the IO-Link module until they are passed to cyclic transmission of CC-Link IE Field Network.

Input response time of input process data

The following is the calculation formula for the input response time of input process data.

$$\text{Input response time} = 125n + 2000 + m \text{ [\mu s]}$$

n: Process data length [bytes]

m: Cycle time [μ s]

Input response time of CQ input signal

The following is the calculation formula for the input response time of the CQ input signal.

$$\text{Input response time} = 2000 + 1000p \text{ [\mu s]}$$

p: Time set in the input response time setting (0, 1.0, 1.5, 5, 10, 20, 70ms)

Input response time of DI signal

The following shows the input response time of the DI signal.

$$\text{Input response time} = 110 + 1000p \text{ [\mu s]}$$

p: Time set in the input response time setting (0, 1.0, 1.5, 5, 10, 20, 70ms)

Output response time

Output response time is the amount of time it takes from when output process data and CQ output signals are passed to the IO-Link module via cyclic transmission of CC-Link IE Field Network until they are output from the IO-Link module.

Output response time of output process data

The following is the calculation formula for the output response time of output process data.

$$\text{Output response time} = 125n + 1300 + m \text{ [\mu s]}$$

n: Process data length [bytes]

m: Cycle time [μ s]

Output response time of CQ output signal

The following shows the output response time of the CQ output signal.

$$\text{Output response time} = 1300 \text{ [\mu s]}$$

Appendix 6 EMC and Low Voltage Directives

In each country, laws and regulations concerning electromagnetic compatibility (EMC) and electrical safety are enacted. For the products sold in the European countries, compliance with the EU's EMC Directive has been a legal obligation as EMC regulation since 1996, as well as the EU's Low Voltage Directive as electrical safety regulation since 1997.

Manufacturers who recognize their products are compliant with the EMC and Low Voltage Directives are required to attach a "CE marking" on their products in European countries.

In some other countries and regions, manufacturers are required to make their products compliant with applicable laws or regulations and attach a certification mark on the products as well (such as UK Conformity Assessed (UKCA) marking in the UK, and Korea Certification (KC) marking in South Korea).

Each country works to make their regulatory requirements consistent across countries based on international standards.

When the requirements are consistent, measures to comply with the EMC and electrical safety regulations become common across countries.

The UK and South Korea have enacted EMC regulations whose requirements are consistent with those of the EMC Directive. The UK has also enacted electrical safety regulations whose requirements are consistent with those of the Low Voltage Directive. In this section, the requirements of the EMC and Low Voltage Directives are described as examples of those of the EMC and electrical safety regulations.

Measures to comply with the EMC Directive

The EMC Directive sets requirements for emission (conducted and radiated electromagnetic interference emitted by a product) and immunity (the ability of a product not to be influenced by externally generated electromagnetic interference).

This section describes the precautions for machinery constructed with the modules to comply with the EMC Directive.

These precautions are based on the requirements of the EMC Directive and the harmonized standards. However, they do not guarantee that the entire machinery constructed according to the descriptions complies with the EMC Directive.

The manufacturer of the machinery must determine the testing method for compliance and declare conformity to the EMC Directive.

EMC Directive related standards

■ Emission requirements

Standard	Test item	Test details	Standard value
EN61131-2: 2007	CISPR16-2-3 Radiated emission ^{*2}	Radio waves from the product are measured.	<ul style="list-style-type: none"> • 30M to 230MHz QP: 40dBμV/m (10m in measurement range)^{*1} • 230M to 1000MHz QP: 47dBμV/m (10m in measurement range)
	CISPR16-2-1, CISPR16-1-2 Conducted emission ^{*2}	Noise from the product to the power line is measured.	<ul style="list-style-type: none"> • 150k to 500kHz QP: 79dB, Mean: 66dB^{*1} • 500k to 30MHz QP: 73dB, Mean: 60dB

*1 QP: Quasi-peak value, Mean: Average value

*2 The module is an open-type device (a device designed to be housed in other equipment) and must be installed inside a conductive control panel. The tests were conducted with the module installed in a control panel.

■ Immunity requirements

Standard	Test item	Test details	Standard value
EN61131-2: 2007	EN61000-4-2 Electrostatic discharge immunity ^{*1}	Immunity test in which electrostatic is applied to the cabinet of the equipment.	<ul style="list-style-type: none"> • 8kV air discharge • 4kV contact discharge
	EN61000-4-3 Radiated, radio-frequency, electromagnetic field immunity ^{*1}	Immunity test in which electric fields are radiated to the product	<ul style="list-style-type: none"> • 80% AM modulation@1kHz • 80M to 1000MHz: 10V/m • 1.4G to 2.0GHz: 3V/m • 2.0G to 2.7GHz: 1V/m
	EN61000-4-4 Fast transient burst immunity ^{*1}	Immunity test in which burst noise is applied to the power line and signal line.	<ul style="list-style-type: none"> • AC/DC main power, I/O power, AC I/O (unshielded): 2kV • DC I/O, analog, communication lines: 1kV
	EN61000-4-5 Surge immunity ^{*1}	Immunity test in which lightning surge is applied to the power line and signal line.	<ul style="list-style-type: none"> • AC power line, AC I/O power, AC I/O (unshielded): 2kV CM, 1kV DM • DC power line, DC I/O power: 0.5kV CM, DM • DC I/O, AC I/O (shielded), analog^{*2}, communication lines: 1kV CM
	EN61000-4-6 Immunity to conducted disturbances, induced by radio-frequency fields ^{*1}	Immunity test in which high frequency noise is applied to the power line and signal line	<ul style="list-style-type: none"> • 0.15M-80MHz, • 80% AM modulation @1kHz, 10Vrms
	EN61000-4-8 Power-frequency magnetic field immunity ^{*1}	Immunity test in which the product is installed in inductive magnetic field	<ul style="list-style-type: none"> • 50Hz/60Hz, 30A/m
	EN61000-4-11 Voltage dips and interruption immunity ^{*1}	Immunity test in which power supply voltage is momentarily interrupted	<ul style="list-style-type: none"> • 0%, 0.5 periods, starting at zero-crossing • 0%, 250/300 cycles (50/60Hz) • 40%, 10/12 cycles (50/60Hz) • 70%, 25/30 cycles (50/60Hz)

*1 The module is an open-type device (a device designed to be housed in other equipment) and must be installed inside a conductive control panel. The tests were conducted with the module installed in a control panel.

*2 The accuracy of an analog-digital converter module may temporarily vary within $\pm 10\%$.

A

Installation in a control panel

The module is an open-type device and must be installed inside a control panel.

This ensures safety as well as effective shielding of programmable controller-generated electromagnetic noise.

■Control panel

- Use a conductive control panel.
- When securing the top or bottom plate using bolts, cover the grounding part on the control panel so that the part will not be painted.
- To ensure electrical contact between the inner plate and control panel, take measures such as covering the bolts so that conductivity can be ensured in the largest possible area.
- Ground the control panel with a thick ground cable so that low impedance can be ensured even at high frequencies.
- Holes in the control panel must be 10cm diameter or less. If the holes are larger than 10cm, radio wave may leak. In addition, because radio waves leak through a clearance between the control panel and its door, reduce the clearance as much as possible. The leakage of radio waves can be suppressed by the direct application of an EMI gasket on the paint surface.

Our tests have been carried out on a control panel having the damping characteristics of 37dB (max.) and 30dB (mean) (measured by 3m method, 30 to 300MHz).

■Wiring of power cables and ground cables

Near the power supply part, provide a grounding point to the control panel. Ground the FG terminal with the thickest and shortest possible ground cable (30cm or shorter).

Cables

Use shielded cables for the cables which are connected to the module and run out from the control panel. If a shielded cable is not used or not grounded correctly, the noise immunity will not meet the specified value.

■Cables for the CC-Link IE Field Network

Shielded cables should be used for the CC-Link IE Field Network. Strip a part of the jacket as shown below and ground the exposed shield in the largest possible area.

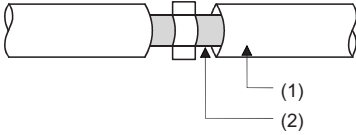

- (1) Cables for the CC-Link IE Field Network
- (2) Shield

■Grounding the cable clamp

Use shielded cables for external wiring and ground the shields of the external wiring cables to the control panel with the AD75CK cable clamp (manufactured by Mitsubishi Electric Corporation). (Ground the shield section 20 to 30cm away from the module.)

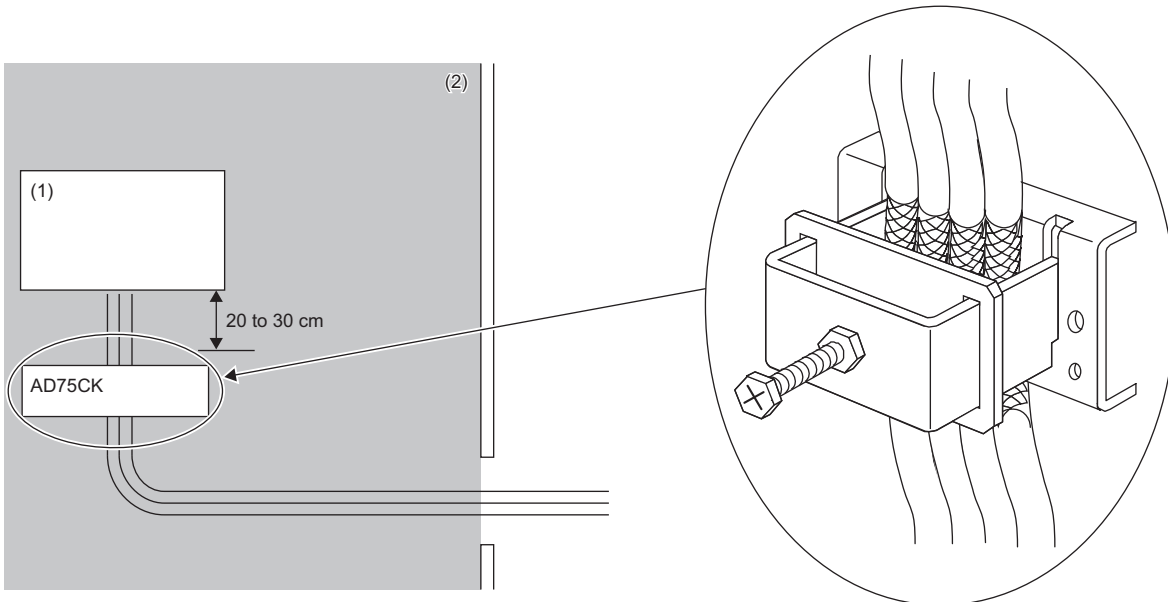

- (1) Module
- (2) Inside a control panel

For detail on the AD75CK, refer to the following.

 AD75CK Cable Clamp Instruction Manual

External power supply

- Use a CE-marked product for an external power supply and always ground the FG terminal. (External power supply used for the tests conducted by Mitsubishi Electric Corporation: IDEC PS6R-F24)
- Use a power cable of 10m or shorter when connecting it to the module power supply terminal.
- Use a power cable with a total length of 30m or less for connections to the external power supply.
- Use a power cable of 3m or less for connections from the external power supply terminal to the noise filter.

A

Others

■ Ferrite core

A ferrite core has the effect of reducing radiation noise in the 30MHz to 100MHz band. It is recommended to attach ferrite cores if shielded cables coming out of the control panel do not provide sufficient shielding effects.

Note that the ferrite cores must be attached at the position closest to the cable hole inside the control panel. If attached at an improper position, the ferrite core will not produce any effect.

Attach a ferrite core 4cm away from the IO-Link module power supply terminal connected to the IO-Link module external power supply.

(Ferrite core used for the tests conducted by Mitsubishi Electric Corporation: NEC TOKIN ESD-SR-250)

Ex.

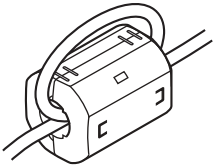

■ Noise filter (power supply line filter)

A noise filter is a component which has an effect on conducted noise. Attaching the filter can suppress more noise. (The noise filter has the effect of reducing conducted noise of 10MHz or less.)

Connect a noise filter to the external power supply of the module. Use a noise filter with the damping characteristics equivalent to those of RSEN-2006 (manufactured by TDK-Lambda Corporation). Note that a noise filter is not required if the module is used in Zone A defined in EN61131-2.

The precautions for attaching a noise filter are described below.

- Do not bundle the cables on the input side and output side of the noise filter. If bundled, the output side noise will be induced into the input side cables from which the noise was filtered out.

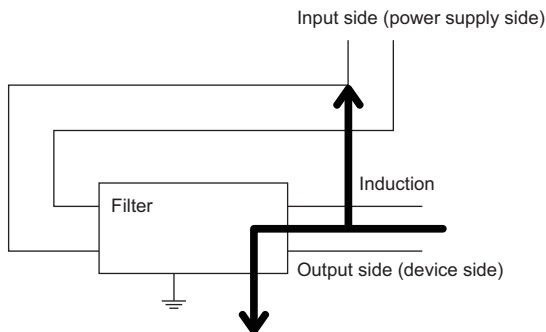

- Problematic example
Noise is induced when the input and output cables are bundled.

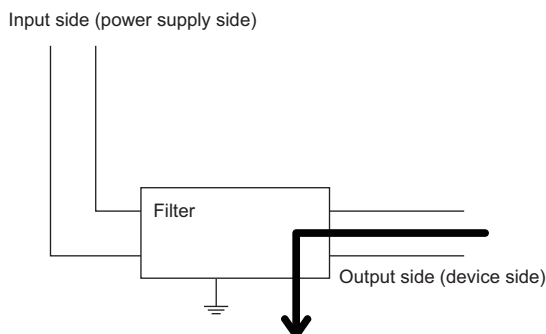

- Modification example
Install the input and output cables separately.

- Ground the noise filter ground terminal to the control panel with the shortest cable possible (approx. 10cm).

Requirements to compliance with the Low Voltage Directive

The IO-Link module operates at the rated voltage of 24VDC.

The Low Voltage Directive is not applied to the modules that operate at the rated voltage of less than 50VAC and 75VDC.

Appendix 7 How to Check Serial Number and Function Version

The serial number and function version of the IO-Link module can be checked on the rating plate.

The serial number can be also checked from production information in CC-Link IE Field Network diagnostics.

Checking on the rating plate

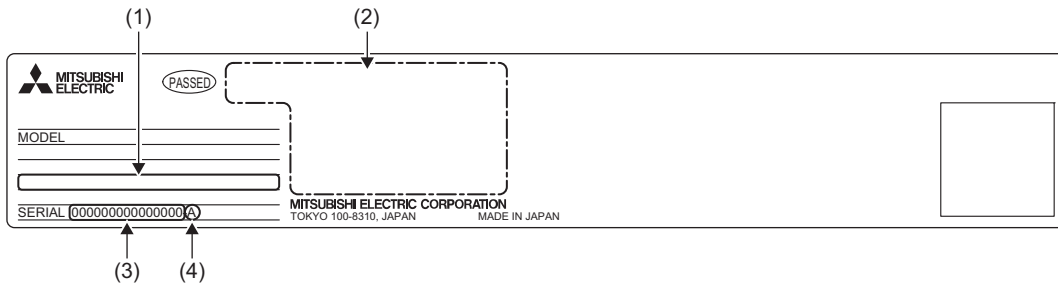

- (1) MAC address
- (2) Relevant standard symbol
- (3) Serial number
- (4) Function version

Checking by using CC-Link IE Field Network diagnostics

Operating procedure

1. Connect an engineering tool to the CPU module of the master station.
2. Start CC-Link IE Field Network diagnostics.
☞ [Diagnostics] ⇒ [CC IE Field Diagnostics]
3. Right-click on the device station whose production information is to be displayed, and select "Production Information".

Window

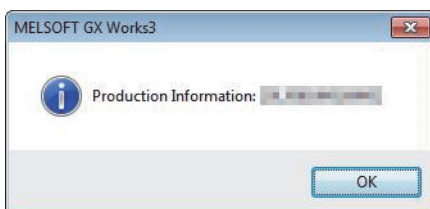

Appendix 8 Added and Enhanced Functions

This section lists the added functions in the IO-Link module.

Added and enhanced function	First five digits of serial number
Output process data output enabled command at channel error has been added ( Page 188 Output process data output enabled command at channel error)	"24042" or later



Appendix 9 External Dimensions

The following figures show the external dimensions of the IO-Link module.

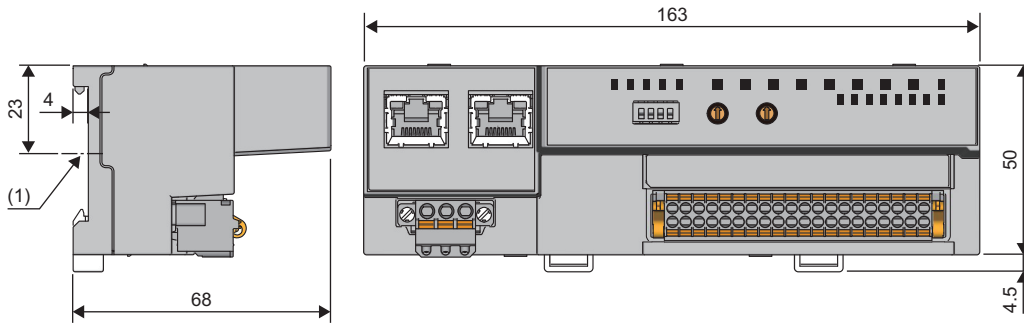

(1) Center of DIN rail

(Unit: mm)

MEMO

A

INDEX

B

Bit segment setting 172

C

Channel error status flag 173
CQ output signal 150
Current error data 178
Cycle time status 176

D

D LINK LED 13
Data masking result 147
Device replacement flag 185
Device replacement status 177
Device validation data 174
Device validation setting 169
DI signal, CQ input signal 147
DIN rail hook 14

E

ERR. LED 13
Error code 156
Event acquisition setting 171
Event data 180
Event history clear command 180
Event history clear completed 181
Event information area 165
Event read completion flag 183
Event read request flag 183
Event status flag 148
External power supply ready 148

F

Fast link-up setting status flag 173
Function setting switch 13

I

I/O PW LED 13
Input data invalid flag 148
Input data masking setting 170
Input OFF delay setting 169
Input process data 156
Input response time setting 167
IO-Link communication retry count 178
IO-Link communication retry count clear command 187
IO-Link communication retry count clear completed 187
IO-Link device parameter manual upload command 186
IO-Link device parameter upload/download status check flag 176
IO-Link device status flag 149
IO-Link terminal block 14

L

L ER LED 13
LINK LED 13

M

MODE LED 13
Module control data area 166
Module operation area 159
Module status area 154
Monitoring area 163

N

Number of output ON times integration value 177
Number of output ON times integration value clear command 184
Number of output ON times integration value clear completed 185

O

Occurrence of minor error 148
Occurrence of minor error clear request flag 150
Operating condition setting completion flag 183
Operating condition setting request flag 181
Operation mode setting 168
Operation mode status 175
Output data valid flag 150
Output HOLD/CLEAR setting 167
Output information 157
Output information operation flag 160
Output process data 159
Output process data output enabled command at channel error 188

P

Parameter area 162
PW LED 13

R

RUN LED 13

S

Station number setting switch 14
Swap setting 170

T

Terminal block for module power supply and FG 14

W

Warning code 156

MEMO

REVISIONS

*The manual number is given on the bottom left of the back cover.

Revision date	*Manual number	Description
October, 2018	SH(NA)-081917ENG-A	First edition
March, 2020	SH(NA)-081917ENG-B	■Added or modified parts GENERIC TERMS AND ABBREVIATIONS, Chapter 8
May 2021	SH(NA)-081917ENG-C	■Added or modified parts SAFETY PRECAUTIONS, CONDITIONS OF USE FOR THE PRODUCT, Section 2.1, 11.8
April 2022	SH(NA)-081917ENG-D	■Added or modified parts Section 7.1, Appendix 2, 3, 6, 8
June 2024	SH(NA)-081917ENG-E	■Added or modified parts GENERIC TERMS AND ABBREVIATIONS, Section 6.1, 6.2, 6.3, 7.1, 7.2, 7.4, 7.5, 7.8, 9.2, 9.3, 11.3, 11.5, 11.6, 11.7, Appendix 3, 4, 7

Japanese manual number: SH-081916-E

This manual confers no industrial property rights or any rights of any other kind, nor does it confer any patent licenses. Mitsubishi Electric Corporation cannot be held responsible for any problems involving industrial property rights which may occur as a result of using the contents noted in this manual.

© 2018 MITSUBISHI ELECTRIC CORPORATION

WARRANTY

Please confirm the following product warranty details before using this product.

1. Gratis Warranty Term and Gratis Warranty Range

If any faults or defects (hereinafter "Failure") found to be the responsibility of Mitsubishi occurs during use of the product within the gratis warranty term, the product shall be repaired at no cost via the sales representative or Mitsubishi Service Company.

However, if repairs are required onsite at domestic or overseas location, expenses to send an engineer will be solely at the customer's discretion. Mitsubishi shall not be held responsible for any re-commissioning, maintenance, or testing on-site that involves replacement of the failed module.

[Gratis Warranty Term]

The gratis warranty term of the product shall be for one year after the date of purchase or delivery to a designated place. Note that after manufacture and shipment from Mitsubishi, the maximum distribution period shall be six (6) months, and the longest gratis warranty term after manufacturing shall be eighteen (18) months. The gratis warranty term of repair parts shall not exceed the gratis warranty term before repairs.

[Gratis Warranty Range]

- (1) The range shall be limited to normal use within the usage state, usage methods and usage environment, etc., which follow the conditions and precautions, etc., given in the instruction manual, user's manual and caution labels on the product.
- (2) Even within the gratis warranty term, repairs shall be charged for in the following cases.
 1. Failure occurring from inappropriate storage or handling, carelessness or negligence by the user. Failure caused by the user's hardware or software design.
 2. Failure caused by unapproved modifications, etc., to the product by the user.
 3. When the Mitsubishi product is assembled into a user's device, Failure that could have been avoided if functions or structures, judged as necessary in the legal safety measures the user's device is subject to or as necessary by industry standards, had been provided.
 4. Failure that could have been avoided if consumable parts (battery, backlight, fuse, etc.) designated in the instruction manual had been correctly serviced or replaced.
 5. Failure caused by external irresistible forces such as fires or abnormal voltages, and Failure caused by force majeure such as earthquakes, lightning, wind and water damage.
 6. Failure caused by reasons unpredictable by scientific technology standards at time of shipment from Mitsubishi.
 7. Any other failure found not to be the responsibility of Mitsubishi or that admitted not to be so by the user.

2. Onerous repair term after discontinuation of production

- (1) Mitsubishi shall accept onerous product repairs for seven (7) years after production of the product is discontinued. Discontinuation of production shall be notified with Mitsubishi Technical Bulletins, etc.
- (2) Product supply (including repair parts) is not available after production is discontinued.

3. Overseas service

Overseas, repairs shall be accepted by Mitsubishi's local overseas FA Center. Note that the repair conditions at each FA Center may differ.

4. Exclusion of loss in opportunity and secondary loss from warranty liability

Regardless of the gratis warranty term, Mitsubishi shall not be liable for compensation to:

- (1) Damages caused by any cause found not to be the responsibility of Mitsubishi.
- (2) Loss in opportunity, lost profits incurred to the user by Failures of Mitsubishi products.
- (3) Special damages and secondary damages whether foreseeable or not, compensation for accidents, and compensation for damages to products other than Mitsubishi products.
- (4) Replacement by the user, maintenance of on-site equipment, start-up test run and other tasks.

5. Changes in product specifications

The specifications given in the catalogs, manuals or technical documents are subject to change without prior notice.

TRADEMARKS

IO-Link is either a registered trademark or a trademark of PROFIBUS Nutzerorganisation e.V.

The company names, system names and product names mentioned in this manual are either registered trademarks or trademarks of their respective companies.

In some cases, trademark symbols such as [™] or [®] are not specified in this manual.

SH(NA)-081917ENG-E(2406)MEE

MODEL: CCIEF-IOLINK-U-E

MODEL CODE: 13JX85

MITSUBISHI ELECTRIC CORPORATION

HEAD OFFICE: TOKYO BLDG., 2-7-3, MARUNOUCHI, CHIYODA-KU, TOKYO 100-8310, JAPAN
NAGOYA WORKS: 1-14, YADA-MINAMI 5-CHOME, HIGASHI-KU, NAGOYA 461-8670, JAPAN

When exported from Japan, this manual does not require application to the
Ministry of Economy, Trade and Industry for service transaction permission.

Specifications subject to change without notice.