

Screw Terminal Ultra-Slim Signal Conditioners M6N Series

PULSE ISOLATOR

Functions & Features

- 7.5-mm wide ultra-slim design
- Low profile allows the M6N module mounted in a 120-mm deep panel
- Galvanically isolates pulse rate signals
- High-density mounting
- Power indicator and input monitor LED

Typical Applications

- Isolating field pulse signals in order to reduce noises
- Changing e.g. dry contact signal to e.g. 5 V signals

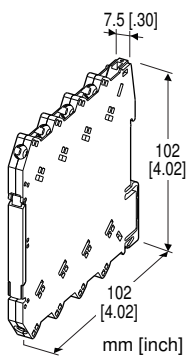

MODEL: M6NPP-[1][2][3]-R[4]

ORDERING INFORMATION

- Code number: M6NPP-[1][2][3]-R[4]
- Specify a code from below for each of [1] through [4].
(e.g. M6NPP-CMN-R/Q)
- Specify the specification for option code /Q
(e.g. /C01)

[1] INPUT

- A1:** Open collector
- A2:** Mechanical contact
- C:** 5 V pulse (sensitivity 2 V)
- D:** 12 V/24 V pulse (sensitivity 5 V)
- H:** Two-wire current pulse

[2] OUTPUT

- A1:** High frequency open collector (max. 100 kHz)
- A2:** Low frequency open collector (max. 30 Hz)
- M:** 5 V pulse
- N:** 12 V pulse
- P:** 24 V pulse

[3] OUTPUT LOGIC

- N:** The same as the input
- R:** Inverted

POWER INPUT

- DC Power**
- R:** 24 V DC
(Operational voltage range 24 V \pm 10 %, ripple 10 %p-p max.)

[4] OPTIONS

- blank:** none
- /Q:** With options (specify the specification)

SPECIFICATIONS OF OPTION: Q

- COATING (For the detail, refer to M-System's web site.)**
- /C01:** Silicone coating
- /C02:** Polyurethane coating

GENERAL SPECIFICATIONS

- Connection**
- Input and output:** M3 screw terminal (torque 0.5 N·m)
- Power input:** Via the Installation Base (model: M6NBS) or M3 screw terminal (torque 0.5 N·m)
- Recommended solderless terminal:** Max. 5.8 mm (0.23") wide; Ones with insulation sleeve do not fit.
- Applicable wire size:** 0.2 - 2.5 mm²
- Housing material:** Flame-resistant resin (black)
- Isolation:** Input to output to power
- Chattering protection:** Filter provided for mechanical contact input
- Power indicator LED:** Green LED turns on when the power is supplied.
- Input monitor LED**
- Open collector, Mechanical contact:** Orange LED turns on when the input is ON.
- Voltage pulse, 2-wire current pulse:** Orange LED turns on when the input is high.
- Input pulse sensing:** DC coupled
- **Recommended solderless terminal (unit: mm [inch])**

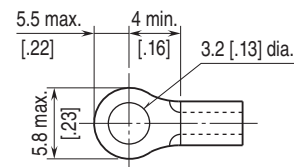

INPUT SPECIFICATIONS

- Excitation:** 12 V DC @20 mA, shortcircuit protection
- **Open Collector**
- Maximum frequency:** 100 kHz

Pulse width time requirement: $\geq 5 \mu\text{sec.}$ for ON and OFF

Sensing: Approx. 11 V DC @2.4 mA

Detecting levels: $\leq 1.8 \text{ k}\Omega/3 \text{ V}$ for ON, $\geq 4 \text{ k}\Omega/5 \text{ V}$ for OFF

■ Mechanical Contact

Maximum frequency: 30 Hz

Pulse width time requirement: $\geq 10 \text{ msec.}$ for ON and OFF

Sensing: Approx. 11 V DC @2.4 mA

Detecting levels: $\leq 1.8 \text{ k}\Omega/3 \text{ V}$ for ON, $\geq 4 \text{ k}\Omega/5 \text{ V}$ for OFF

■ Voltage Pulse

Maximum frequency: 100 kHz

Pulse width time requirement: $\geq 5 \mu\text{sec.}$ for high and low levels

Waveform: Square or sine

Input impedance: $\geq 10 \text{ k}\Omega$

Max. voltage between input terminals: 50 V

Detecting H level

5 V pulse: $\geq 3 \text{ V}$

12 V, 24 V pulse: $\geq 6 \text{ V}$

Detecting L level

5 V pulse: $\leq 1 \text{ V}$

12 V, 24 V pulse: $\leq 4 \text{ V}$

■ Two-wire Current Pulse

Max. frequency: 100 kHz

Input resistance: Receiving resistor 200 Ω

Input range: 0 - 25 mA

Detecting levels: $\leq 5 \text{ mA}$ for Lo, $\geq 15 \text{ mA}$ for Hi

Operating humidity: 30 to 90 %RH (non-condensing)

Mounting: Installation Base (model: M6NBS) or DIN rail

Weight: 60 g (2.1 oz)

PERFORMANCE

Insulation resistance: $\geq 100 \text{ M}\Omega$ with 500 V DC

Dielectric strength: 2000 V AC @1 minute (input to output to power to ground)

STANDARDS & APPROVALS

EU conformity:

EMC Directive

EMI EN 61000-6-4

EMS EN 61000-6-2

RoHS Directive

OUTPUT SPECIFICATIONS

■ High Frequency Open Collector:

50 V DC @100 mA (resistive load)

Maximum frequency: 100 kHz

Saturation voltage: 0.5 V DC

■ Low Frequency Open Collector:

50 V DC @100 mA (resistive load)

Maximum frequency: 30 Hz

Timer: Limits $\geq 75 \text{ msec.}$ within $75 \pm 25 \text{ msec.}$

ON time for output logic non-inverted

OFF time for output logic inverted

Saturation voltage: 0.5 V DC

■ Voltage Pulse

Maximum frequency: 100 kHz

High level: Rating (5, 12 or 24 V) $\pm 10 \%$

Low level: $\leq 0.5 \text{ V}$

Load resistance:

$\geq 1.0 \text{ k}\Omega$ for 5 V

$\geq 2.4 \text{ k}\Omega$ for 12 V

$\geq 4.8 \text{ k}\Omega$ for 24 V

INSTALLATION

Power consumption: Approx. 1 W

Operating temperature: -20 to +55°C (-4 to +131°F)

EXTERNAL VIEW

(With the cover open)

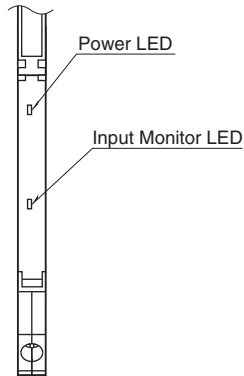

OUTPUT LOGIC

INPUT TYPE	PULSE LOGIC	INPUT	VOLTAGE PULSE OUTPUT	OPEN COLLECTOR OUTPUT
Voltage Pulse Input 2-wire Current Pulse Input	Non Inverted	H L	H L	OFF ON
	Inverted	H L	H L	OFF ON
Mechanical Contact Input Open Collector Input	Non Inverted	OFF ON	H L	OFF ON
	Inverted	OFF ON	H L	OFF ON

EXTERNAL DIMENSIONS & TERMINAL ASSIGNMENTS unit: mm [inch]

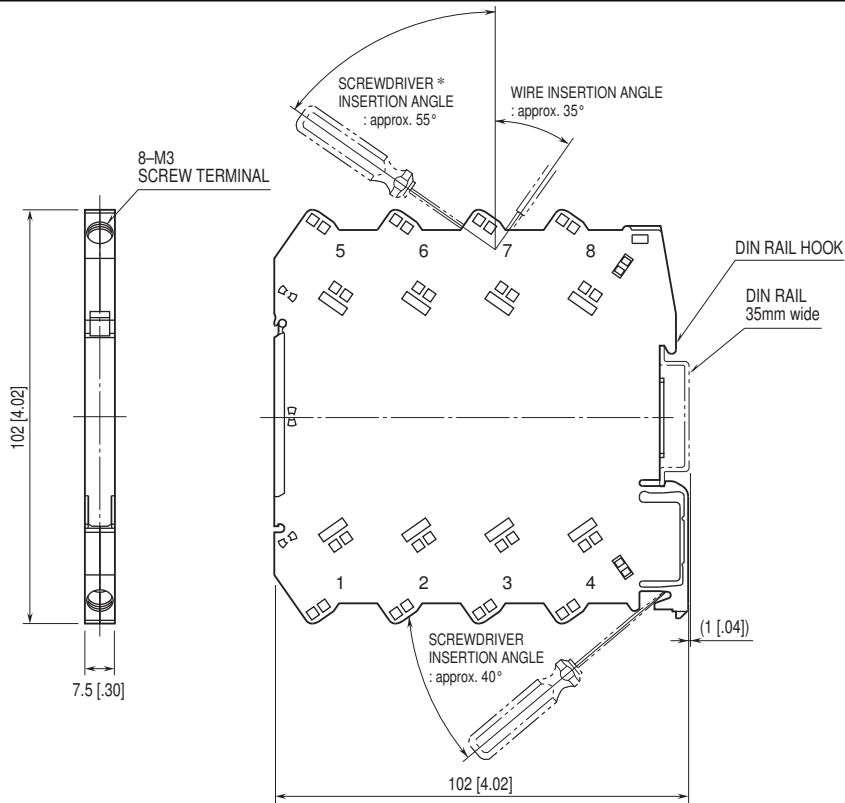

*Screwdriver stem diameter: 6 mm [.24"] or less

• When mounting, no extra space is needed between units.

SCHEMATIC CIRCUITRY & CONNECTION DIAGRAM

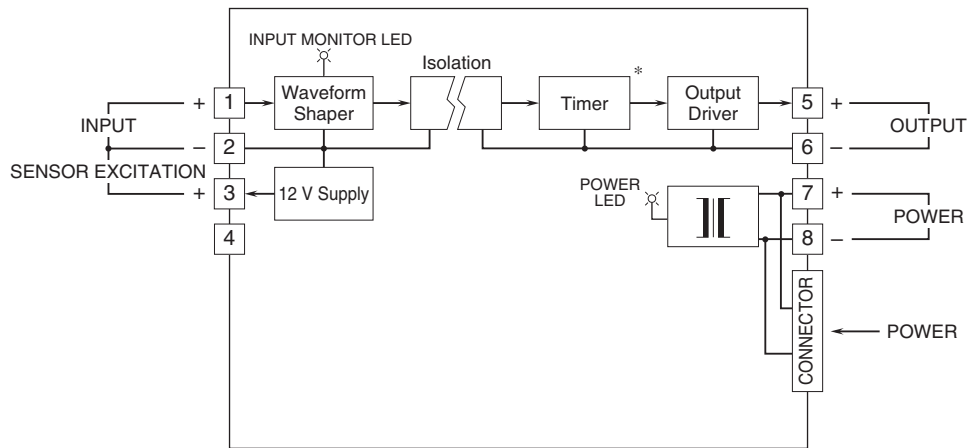

* Low freq. open collector output only.

Input Connection Examples

■ Mechanical Contact or Open Collector

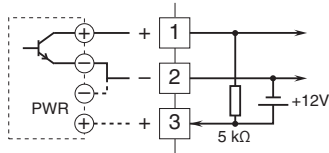

■ Voltage Pulse

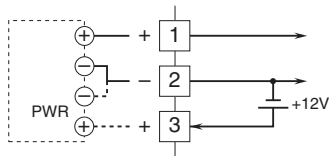

■ 2-Wire Current Pulse

• Built-in Excitation

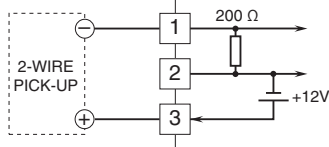

• External DC Supply

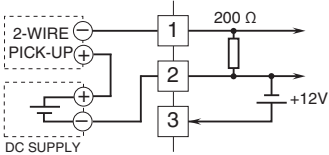

Output Connection Examples

■ Open Collector

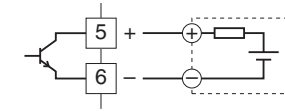

■ Voltage Pulse

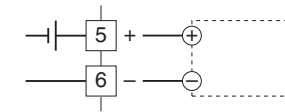

Specifications are subject to change without notice.