

DC ALARM (PC programmable)	MODEL M6NXAS
--------------------------------------	---------------------

BEFORE USE

Thank you for choosing M-System. Before use, please check contents of the package you received as outlined below. If you have any problems or questions with the product, please contact M-System's Sales Office or representatives.

■ PACKAGE INCLUDES:

Signal conditioner(1)

■ MODEL NO.

Confirm Model No. marking on the product to be exactly what you ordered.

■ INSTRUCTION MANUAL

This manual describes necessary points of caution when you use this product, including installation, connection and basic maintenance procedures.

The M6NXAS is programmable using the PC Configurator Software. For detailed information on the PC configuration, refer to the M6CFG users manual. The M6CFG PC Configurator Software is downloadable at M-System's web site: <http://www.m-system.co.jp>

POINTS OF CAUTION

■ CONFORMITY WITH EU DIRECTIVES

- This equipment is suitable for Pollution Degree 2 and Measurement Category II (output, transient voltage 2500V). Reinforced insulation (signal input or power input to output: 300V) and basic insulation (signal input to power input: 300V) are maintained. Prior to installation, check that the insulation class of this unit satisfies the system requirements.
- The equipment must be mounted inside a panel.
- Altitude up to 2000 meters.
- The equipment must be installed such that appropriate clearance and creepage distances are maintained to conform to CE requirements. Failure to observe these requirements may invalidate the CE conformance.
- The actual installation environments such as panel configurations, connected devices, connected wires, may affect the protection level of this unit when it is integrated in a panel system. The user may have to review the CE requirements in regard to the whole system and employ additional protective measures to ensure the CE conformity.
- Install lightning surge protectors for those wires connected to remote locations.

■ POWER INPUT RATING & OPERATIONAL RANGE

- Locate the power input rating marked on the product and confirm its operational range as indicated below:
 24V DC rating: 24V ±10%, approx. 0.5W

■ GENERAL PRECAUTIONS

- Before you remove the unit or mount it, turn off the power supply and input signal for safety.

■ ENVIRONMENT

- Indoor use.
- When heavy dust or metal particles are present in the air, install the unit inside proper housing with sufficient ventilation.
- Do not install the unit where it is subjected to continuous vibration. Do not subject the unit to physical impact.
- Environmental temperature must be within -20 to +55°C (-4 to +131°F) with relative humidity within 30 to 90% RH in order to ensure adequate life span and operation.

■ WIRING

- Do not install cables close to noise sources (relay drive cable, high frequency line, etc.).
- Do not bind these cables together with those in which noises are present. Do not install them in the same duct.

■ AND

- The unit is designed to function as soon as power is supplied, however, a warm up for 10 minutes is required for satisfying complete performance described in the data sheet.

COMPONENT IDENTIFICATION

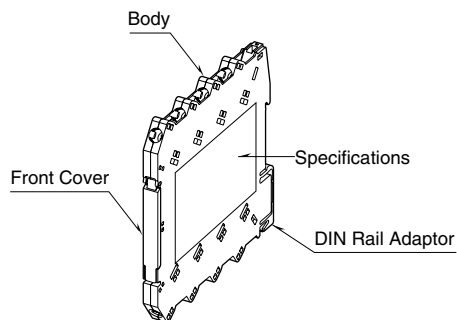

INSTALLATION

Set the unit so that its DIN rail adapter is at the bottom. When the unit is installed to an Installation Base (model M6NBS), refer to its instruction manual.

■ MOUNTING THE UNIT ON A DIN RAIL

- Hang the upper hook at the rear side of unit on the DIN rail.
- Push in the lower in keeping pressing the unit to the DIN rail.

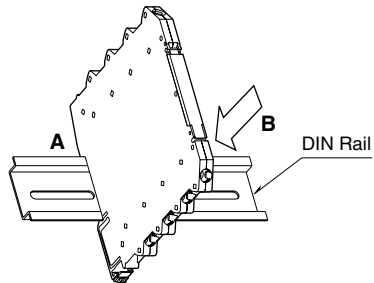

■ REMOVING THE UNIT

- Pull down the DIN rail adaptor using a minus screwdriver.
- Pull out the lower part of the unit.
- Remove the upper part from the DIN rail.

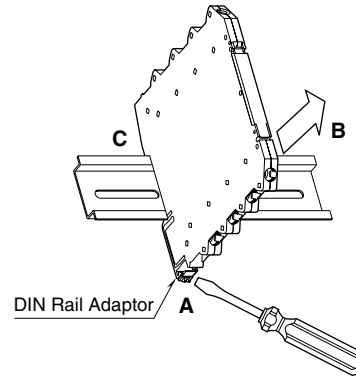

TERMINAL CONNECTIONS

Connect the unit as in the diagram below or refer to the connection diagram on the side of the unit.

■ EXTERNAL DIMENSIONS unit: mm (inch)

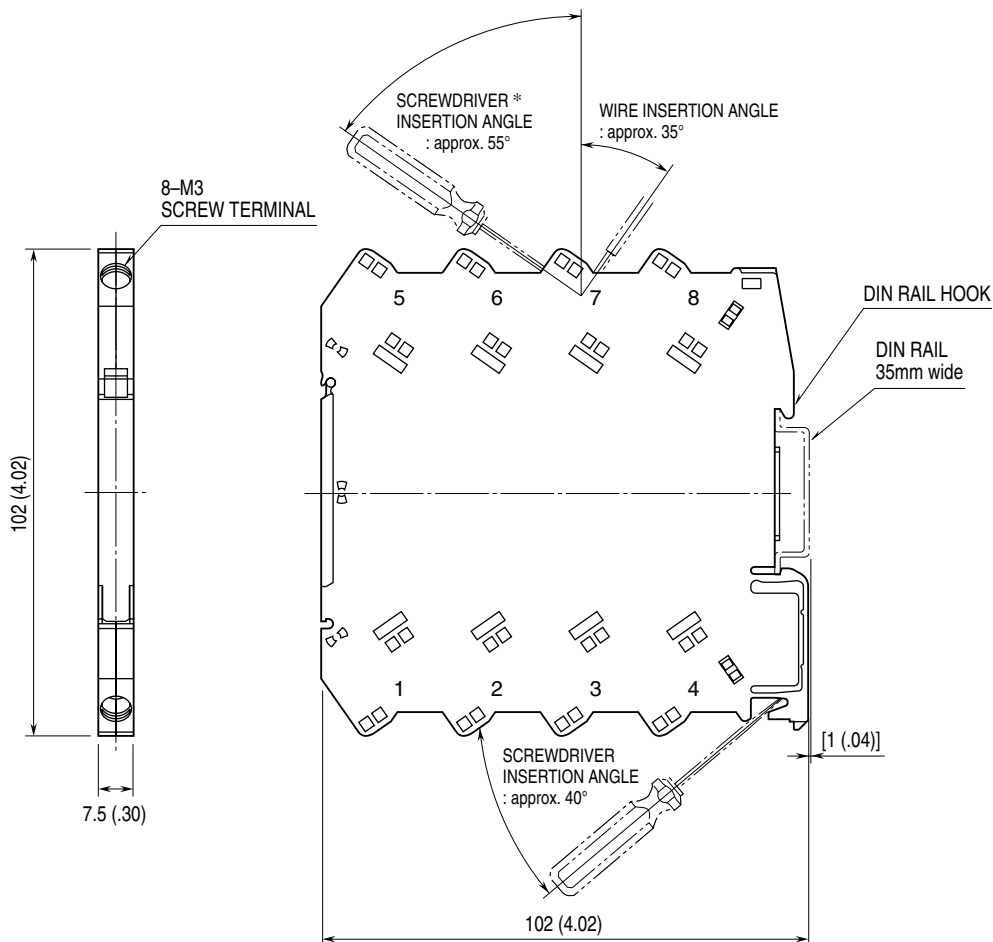

*Screwdriver stem diameter: 6 mm (.24") or less

• When mounting, no extra space is needed between units.

■ CONNECTION DIAGRAM

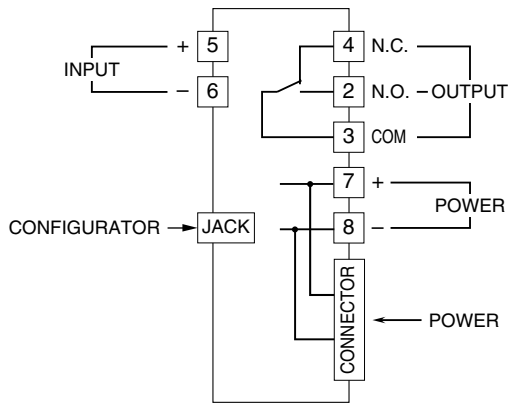

WIRING INSTRUCTIONS

■ SCREW TERMINAL

Torque: 0.5 N·m

■ SOLDERLESS TERMINAL unit: mm (inch)

Refer to the drawing below for recommended ring tongue terminal size. Spade tongue type is also applicable.

Solderless terminals with insulation sleeve do not fit.

Applicable wire size: 0.2 – 2.5 mm²

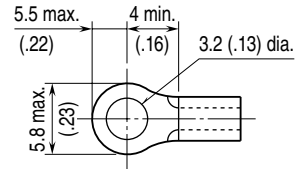

EXTERNAL VIEWS

■ FRONT VIEW (with the cover open)

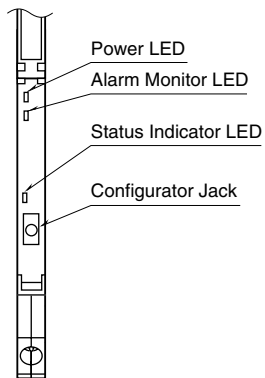

■ SIDE VIEW

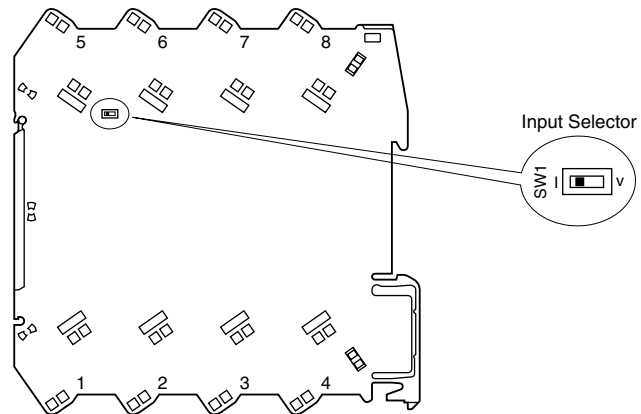

INPUT RANGING

The internal DIP switch setting is required to select input types before setting a precise input range using PC Configurator Software (model: M6CFG).

For detailed information on the PC configuration, refer to the M6CFG users manual.

Table 1. DIP switch setting: Input type

INPUT	SW
0 – 50 mA	I
-1000 – +1000 mV	V
-10 – +10 V	

CHECKING

- 1) Terminal wiring: Check that all cables are correctly connected according to the connection diagram.
- 2) Check DIP switch setting.
- 3) Power input voltage: Check voltage across the terminal 7–8 with a multimeter.
- 4) Input: Check that the input signal is within 0 – 100% of the full-scale.
- 5) Alarm operations: Check the alarm operations referring to the figure below.
- 6) Output load: Check that the output load is 250 V AC / 500 VA or 125 V DC / 60 W. For maximum relay life with inductive load, external protection is recommended.

Alarm Trip Operation Terminal No. in parentheses

• Setting Example

Hi alarm (coil energized at alarm) or
Lo alarm (coil de-energized at alarm)

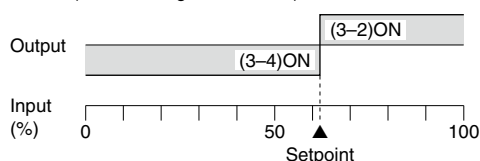

Trip operation in power failure: Terminals 3 – 4 turn ON.

LED FUNCTIONS

■ STATUS INDICATOR LED

The M6NXAS is provided with a status indicator LED which blinks in different patterns indicating various operating status.

The following figure indicates typical patterns.

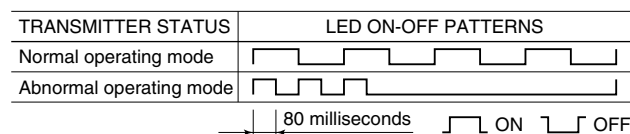

■ ALARM MONITOR LED

The M6NXAS is provided with an alarm monitor LED which blinks in different patterns indicating various alarm status. The following figure indicates typical patterns.

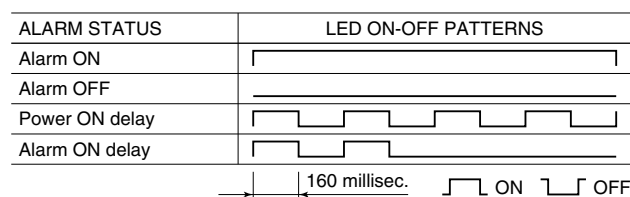

MAINTENANCE

Regular calibration procedure is explained below:

■ CALIBRATION

Warm up the unit for at least 10 minutes.

• H Setpoint

Increase the input signal from a value lower than the setpoint and check that the relay trips at the H setpoint within the setpoint accuracy described in the data sheet.

• L Setpoint

Decrease the input signal from a value higher than the setpoint and check that the relay trips at the L setpoint within the setpoint accuracy described in the data sheet.

When the setpoints are shifted, recalibrate the unit using the PC Configurator Software (model: M6CFG).

LIGHTNING SURGE PROTECTION

M-System offers a series of lightning surge protector for protection against induced lightning surges. Please contact M-System to choose appropriate models.