

THERMOCOUPLE TRANSMITTER
(PC programmable)

MODEL **M6DXT**

BEFORE USE

Thank you for choosing M-System. Before use, please check contents of the package you received as outlined below. If you have any problems or questions with the product, please contact M-System's Sales Office or representatives.

■ PACKAGE INCLUDES:

Signal conditioner(1)

■ MODEL NO.

Confirm Model No. marking on the product to be exactly what you ordered.

■ INSTRUCTION MANUAL

This manual describes necessary points of caution when you use this product, including installation, connection and basic maintenance procedures.

The M6DXT is programmable using the PC Configurator Software. For detailed information on the PC configuration, refer to the M6CFG users manual. The M6CFG PC Configurator Software is downloadable at M-System's web site: <http://www.m-system.co.jp>

POINTS OF CAUTION

■ CONFORMITY WITH EU DIRECTIVES OR UL

- The equipment must be mounted inside a panel.
- Insert a noise filter for the power source, input and output connected to the unit. COSEL Noise Filter Model NAC-04-472, TDK Noise Filter Model ZCAT 3035-1330 or equivalent is recommended.
- The actual installation environments such as panel configurations, connected devices, connected wires, may affect the protection level of this unit when it is integrated in a panel system. The user may have to review the CE requirements in regard to the whole system and employ additional protective measures to ensure the CE conformity.
- Install lightning surge protectors for those wires connected to remote locations.

■ POWER INPUT RATING & OPERATIONAL RANGE

- Locate the power input rating marked on the product and confirm its operational range as indicated below:
24V DC rating: 24V ±10%, approx. 0.5W

■ GENERAL PRECAUTIONS

- Before you remove the unit or mount it, turn off the power supply and input signal for safety.

■ ENVIRONMENT

- Indoor use.
- When heavy dust or metal particles are present in the air, install the unit inside proper housing with sufficient ventilation.
- Do not install the unit where it is subjected to continuous vibration. Do not subject the unit to physical impact.
- Environmental temperature must be within -20 to +55°C (-4 to +131°F) with relative humidity within 30 to 90% RH in order to ensure adequate life span and operation.

■ WIRING

- Do not install cables close to noise sources (relay drive cable, high frequency line, etc.).
- Do not bind these cables together with those in which noises are present. Do not install them in the same duct.

■ AND

- The unit is designed to function as soon as power is supplied, however, a warm up for 10 minutes is required for satisfying complete performance described in the data sheet.

COMPONENT IDENTIFICATION

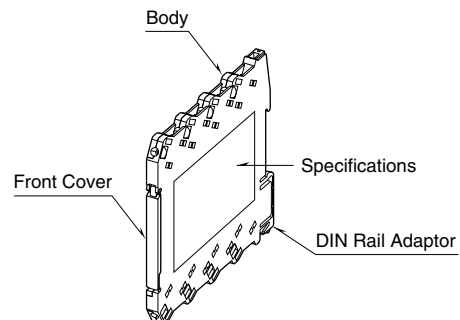

INSTALLATION

Set the unit so that its DIN rail adapter is at the bottom. When the unit is installed to an Installation Base (model M6DBS), refer to its instruction manual.

■ MOUNTING THE UNIT ON A DIN RAIL

- A) Hang the upper hook at the rear side of unit on the DIN rail.
- B) Push in the lower in keeping pressing the unit to the DIN rail.

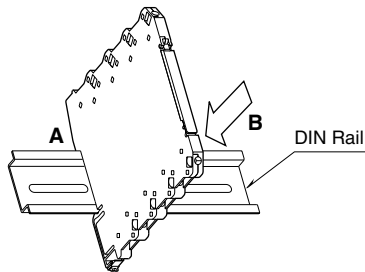

■ REMOVING THE UNIT

- A) Pull down the DIN rail adaptor using a minus screwdriver.
- B) Pull out the lower part of the unit.
- C) Remove the upper part from the DIN rail.

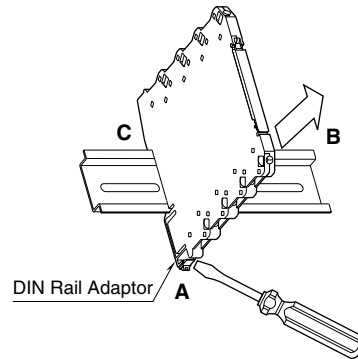

TERMINAL CONNECTIONS

Connect the unit as in the diagram below or refer to the connection diagram on the side of the unit.

■ EXTERNAL DIMENSIONS unit: mm (inch)

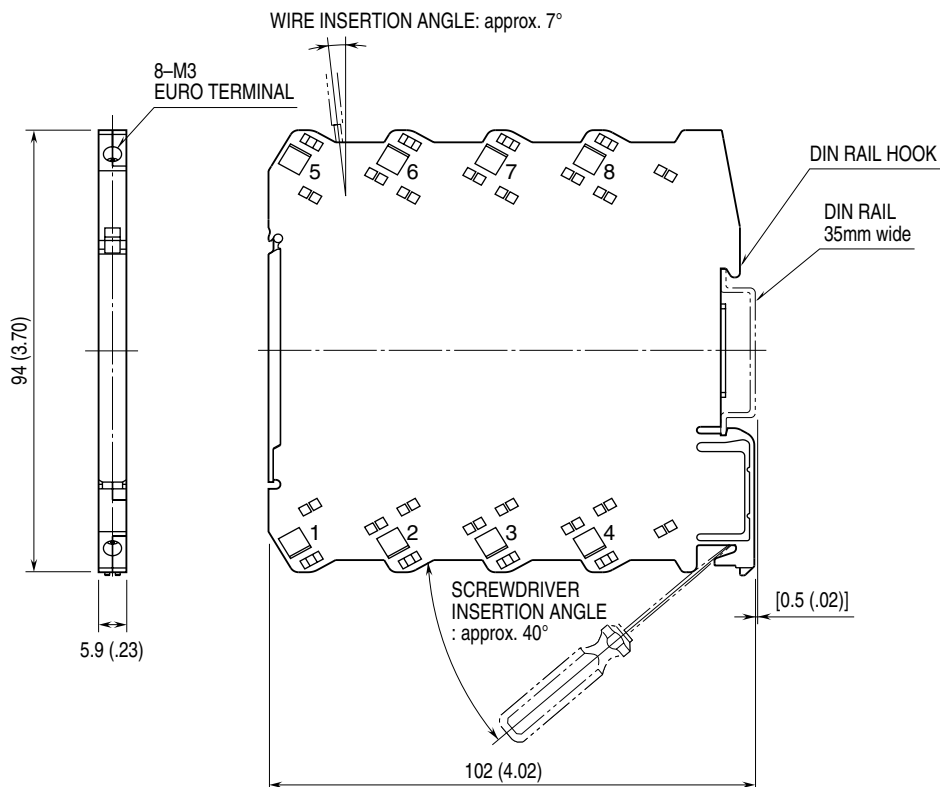

• When mounting, no extra space is needed between units.

■ CONNECTION DIAGRAM

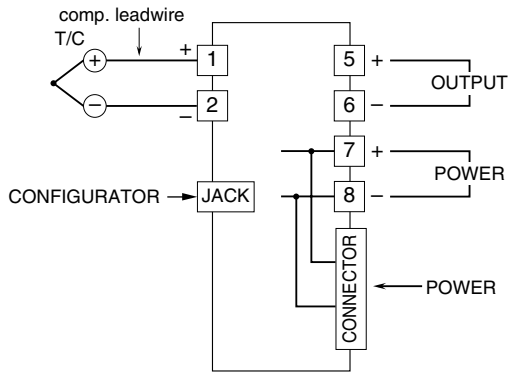

• How to Connect Wires

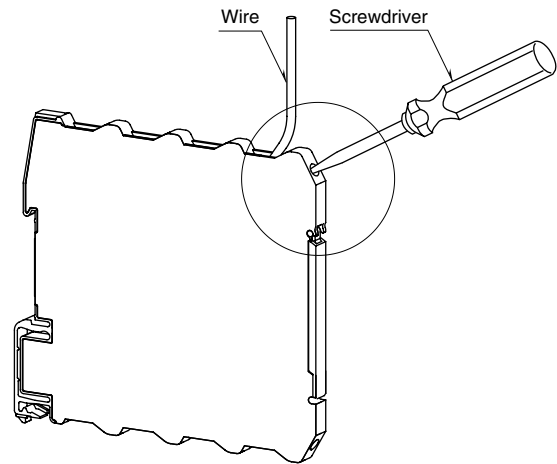

■ WIRING INSTRUCTIONS

- Applicable wire size

Solid: 0.2 to 2.5 mm² (0.55 to 1.75 dia.)

Stranded: 0.2 to 2.5 mm² (Tinning wire ends may cause contact failure and therefore is not recommended.)

Ferruled: 0.2 to 1.5 mm² (0.55 to 1.35 dia.)

- Expose wire conductors by 8 mm (0.31").

Wire exposure

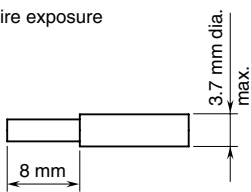

Recommended ferruled wire

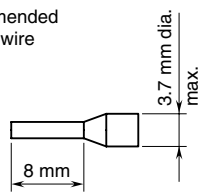

Insert a wire. Confirm that the wire tip hits the bottom and tighten the screw with a screwdriver.

Confirm that the wire's insulation tube is not caught in the terminal. (Torque: 0.3 N·m)

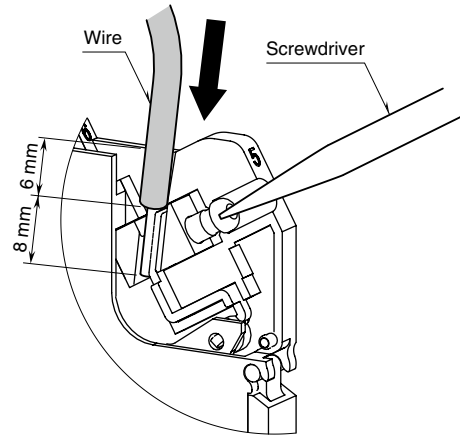

EXTERNAL VIEWS

FRONT VIEW (with the cover open)

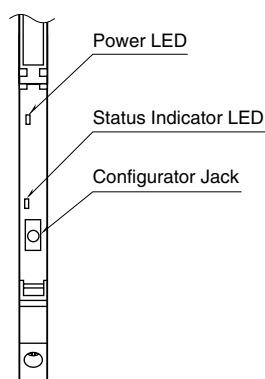

SIDE VIEW

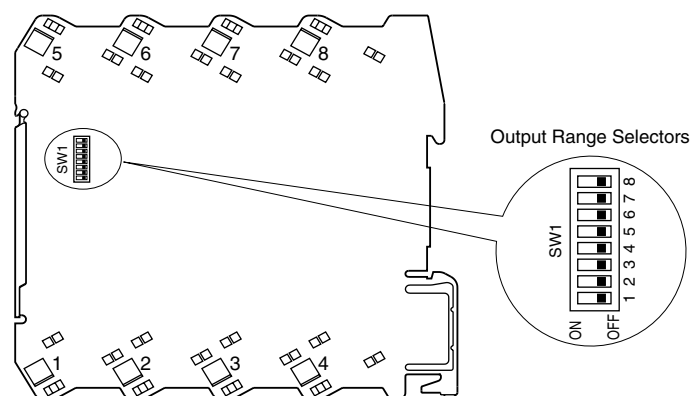

OUTPUT RANGING

The internal DIP switch setting is required to select output types before setting a precise output range using PC Configurator Software (model: M6CFG).

For detailed information on the PC configuration, refer to the M6CFG users manual.

Table 1. DIP switch setting: Output type

Output Type	SW							
	1	2	3	4	5	6	7	8
0 – 20 mA*1	ON	ON	OFF	OFF	OFF	OFF	ON	OFF
-5 – +5 V	OFF	OFF	ON	OFF	ON	OFF	OFF	ON
-10 – +10 V	OFF	OFF	ON	OFF	OFF	ON	OFF	ON

*1. For 0 – 1 mA range, set switches as in the table below.

Output Range	SW							
	1	2	3	4	5	6	7	8
0 – 1 mA	OFF	OFF	ON	OFF	OFF	OFF	ON	OFF

CHECKING

- 1) Terminal wiring: Check that all cables are correctly connected according to the connection diagram.
- 2) Check DIP switch setting.
- 3) Power input voltage: Check voltage across the terminal 7 – 8 with a multimeter.
- 4) Input: Check that the input signal is within 0 – 100% of the full-scale.

If the thermocouple or its extension wires are broken, the output goes over 100% (below 0% with downscale protection) due to the burnout function. Confirm the status indicator LED pattern and check leadwires in such a case.

- 5) Output: Check that the load resistance meets the described specifications.

STATUS INDICATOR LED

The transmitter is provided with a status indicator LED which blinks in different patterns indicating various operating status.

The following figure indicates typical patterns.

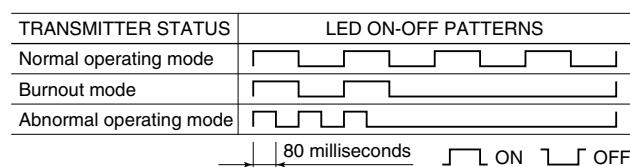

MAINTENANCE

Regular calibration procedure is explained below:

CALIBRATION

Warm up the unit for at least 10 minutes. Apply 0%, 25%, 50%, 75% and 100% input signal. Check that the output signal for the respective input signal remains within accuracy described in the data sheet. When the output is out of tolerance, recalibrate the unit using the PC Configurator Software (model: M6CFG).

LIGHTNING SURGE PROTECTION

M-System offers a series of lightning surge protector for protection against induced lightning surges. Please contact M-System to choose appropriate models.