

BEFORE USE

Thank you for choosing M-System. Before use, please check contents of the package you received as outlined below.

If you have any problems or questions with the product, please contact M-System's Sales Office or representatives.

■ PACKAGE INCLUDES:

Signal conditioner

(body + base socket + input resistor).....(1)

Input resistor is provided only with current input type.

■ MODEL NO.

Confirm Model No. marking on the product to be exactly what you ordered.

■ INSTRUCTION MANUAL

This manual describes necessary points of caution when you use this product, including installation, connection and basic maintenance procedures.

POINTS OF CAUTION**■ NONINCENDIVE APPROVAL OPTION**

- This equipment is suitable for use in Class I, Div. 2, Groups A, B, C and D or Non-Hazardous Locations only.
- **WARNING!** Before You Remove the Unit from Its Base Socket or Mount It, Turn Off the Power Supply and Input Signal for Safety.
- **WARNING!** – **Explosion Hazard** – Substitution of Components May Impair Suitability for Class I, Div. 2.
- **WARNING!** – **Explosion Hazard** – Do Not Disconnect Equipment Unless Power Has Been Switched Off or The Area is Known To Be Non-Hazardous.
- The equipment was evaluated for use in the ambient temperature and relative humidity as mentioned in 'ENVIRONMENT' section.
- The input and output wiring must be in accordance with Class I, Div. 2 wiring methods and in accordance with the authority having jurisdiction for use in these hazardous locations.

■ CONFORMITY WITH EU DIRECTIVES OR UL

- This equipment is suitable for Pollution Degree 2, Measurement Category II (input, transient voltage 2500V and output, transient voltage 1500V) and Installation Category II (transient voltage 2500V). Reinforced insulation (signal input or output 1 or output 2 to power input: 300V) and basic insulation (signal input to output 1 or output 2: 300V) are maintained. Prior to installation, check that the insulation class of this unit satisfies the system requirements.
- Altitude up to 2000 meters.
- The equipment must be mounted inside a panel.
- The equipment must be installed such that appropriate clearance and creepage distances are maintained to conform to CE/UL requirements. Failure to observe these requirements may invalidate the CE/UL conformance.

- The actual installation environments such as panel configurations, connected devices, connected wires, may affect the protection level of this unit when it is integrated in a panel system. The user may have to review the CE requirements in regard to the whole system and employ additional protective measures* to ensure the CE conformity. * For example, installation of noise filters and clamp filters for the power source, input and output connected to the unit, etc.
- Install lightning surge protectors for those wires connected to remote locations.

■ POWER INPUT RATING & OPERATIONAL RANGE

- Locate the power input rating marked on the product and confirm its operational range as indicated below:
 - 100 – 240V AC rating: 85 – 264V (90 – 264V for UL), 47 – 66 Hz, approx. 4 – 6VA
 - 24V DC rating: 24V \pm 10%, approx. 3W
 - 11 – 27V DC rating: 11 – 27V, approx. 3W
 - 110V DC rating: 85 – 150V (110V \pm 10% for UL), approx. 3W

■ GENERAL PRECAUTIONS

- Before you remove the unit from its base socket or mount it, turn off the power supply and input signal for safety.

■ ENVIRONMENT

- Indoor use.
- When heavy dust or metal particles are present in the air, install the unit inside proper housing with sufficient ventilation.
- Do not install the unit where it is subjected to continuous vibration. Do not subject the unit to physical impact.
- Environmental temperature must be within -5 to +55°C (23 to 131°F) with relative humidity within 30 to 90% RH in order to ensure adequate life span and operation.
- Be sure that the ventilation slits are not covered with cables, etc.

■ WIRING

- Do not install cables close to noise sources (relay drive cable, high frequency line, etc.).
- Do not bind these cables together with those in which noises are present. Do not install them in the same duct.

■ AND

- The unit is designed to function as soon as power is supplied, however, a warm up for 10 minutes is required for satisfying complete performance described in the data sheet.

COMPONENT IDENTIFICATION

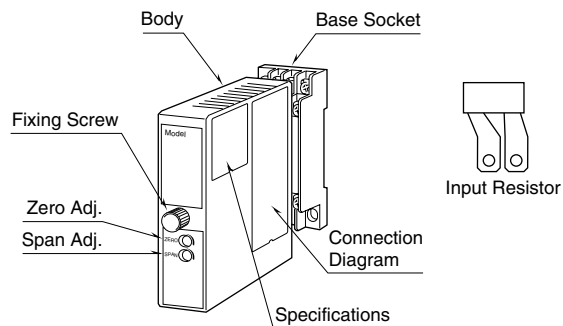

INSTALLATION

Loosen the fixing screw at the front of the unit in order to separate the body from the base socket.

■ DIN RAIL MOUNTING

Set the base socket so that its DIN rail adaptor is at the bottom. Position the upper hook at the rear side of base socket on the DIN rail and push in the lower. When removing the socket, push down the DIN rail adaptor utilizing a minus screwdriver and pull.

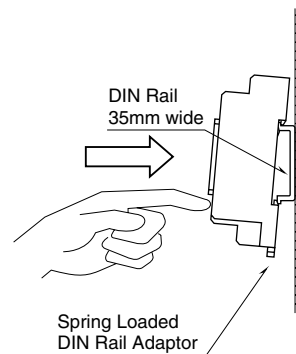

■ WALL MOUNTING

Refer to "EXTERNAL DIMENSIONS."

TERMINAL CONNECTIONS

Connect the unit as in the diagram below or refer to the connection diagram on the side of the unit.

When an input resistor is provided with the module, attach it together with input wiring to the input screw terminals.

■ EXTERNAL DIMENSIONS unit: mm (inch)

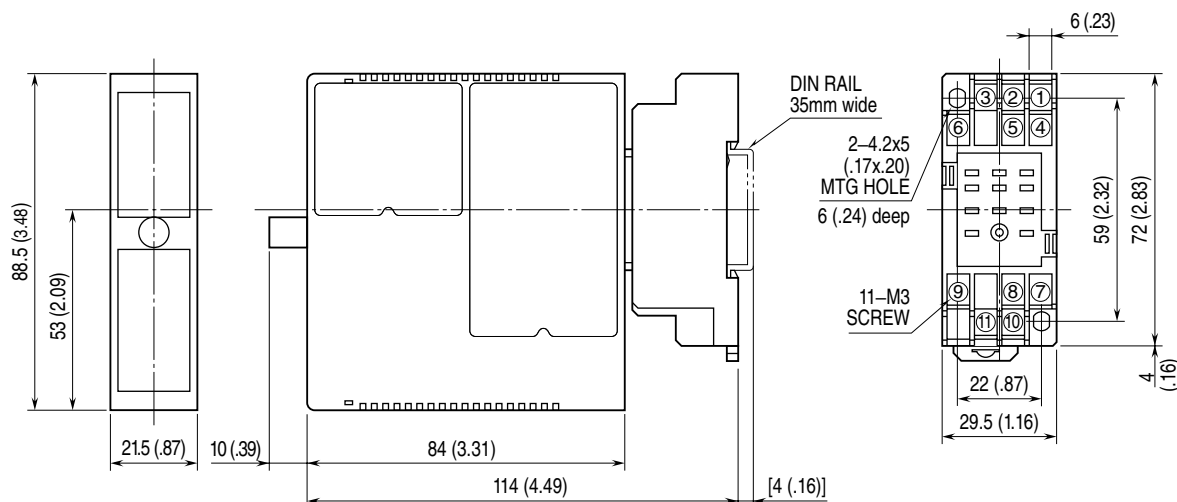

• When mounting, no extra space is needed between units.

■ CONNECTION DIAGRAM

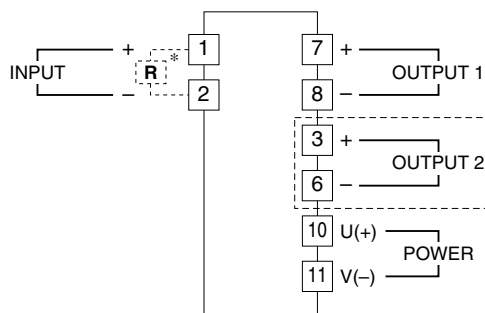

The section enclosed by broken line is only with 2nd output option.

*Input shunt resistor attached for current input.

Output Connection Examples

■ Open Collector

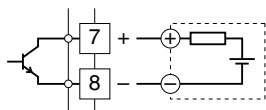

■ Dry Contact AC/DC Switch

• AC Powered

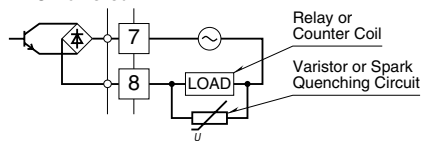

■ Voltage Pulse

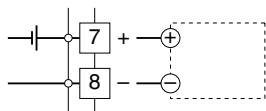

• DC Powered

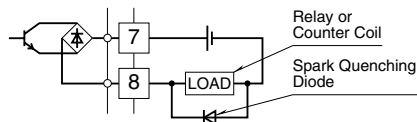

■ TERMINAL ASSIGNMENTS unit: mm (inch)

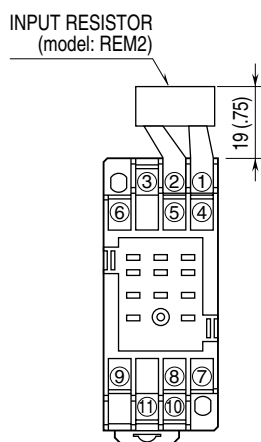

Input shunt resistor attached for current input.

WIRING INSTRUCTIONS

■ SCREW TERMINAL

Torque: 0.8 N·m

■ SOLDERLESS TERMINAL

Refer to the drawing below for recommended ring tongue terminal size. Spade tongue type is also applicable.

Applicable wire size: 0.25 to 1.65 mm² (AWG 22 to 16)

Recommended manufacturer: Japan Solderless Terminal MFG.Co.Ltd, Nichifu Co.,ltd

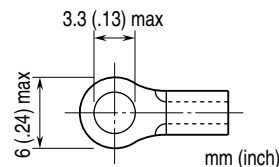

CHECKING

- 1) Terminal wiring: Check that all cables are correctly connected according to the connection diagram.
- 2) Power input voltage: Check voltage across the terminal 10 – 11 with a multimeter.
- 3) Input: Check that the input signal is within 0 – 100% of the full-scale.
- 4) Output: Check that the load resistance meets the described specifications shown below.

OUTPUT	LOAD REQUIREMENTS
Open collector	30 V DC @ 100 mA max.
5V pulse	250 Ω min.
Dry contact AC/DC switch	30 V DC @ 200 mA max (resistive load) 132 V AC @ 200 mA max. ($\cos\phi=1$)

Check also that the receiving instrument is able to accept the waveform as explained in the figure below.

■ Frequency less than 500 Hz at 100% input

→ See the figure below.

• Open Collector

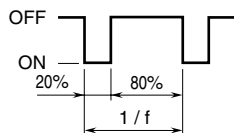

• Voltage Pulse

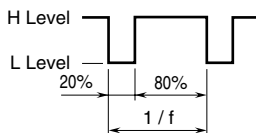

■ Frequency greater than 500 Hz at 100% input

→ See the figure and equation below.

• Open Collector

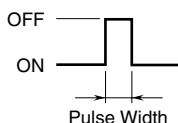

• Voltage Pulse

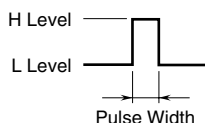

$$\text{Pulse Width [millisec.]} = \frac{1}{2.09 \times 100\% \text{ Frequency [kHz]}}$$

■ When the dry contact AC/DC Switch is selected as either OUTPUT 1 or OUTPUT 2

→ See the figure below. ON or L pulse width is limited within 75 \pm 25 msec. when the output frequency gets low (below 2 to 4 Hz).

• Open Collector

Dry Contact AC/DC Switch

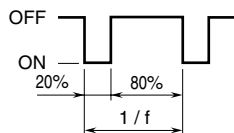

• Voltage Pulse

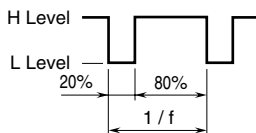

ADJUSTMENT PROCEDURE

This unit is calibrated at the factory to meet the ordered specifications, therefore you usually do not need any calibration.

For matching the signal to a receiving instrument or in case of regular calibration, adjust the output as explained in the following.

■ HOW TO CALIBRATE THE OUTPUT SIGNAL

Use a signal source and measuring instruments of sufficient accuracy level. Turn the power supply on and warm up for more than 10 minutes.

1) ZERO: Apply 5% input and adjust output to 5%.

2) SPAN: Apply 100% input and adjust output to 100%.

3) Check ZERO adjustment again with 5% input.

4) When ZERO value is changed, repeat the above procedure 1) – 3).

MAINTENANCE

Regular calibration procedure is explained below:

■ CALIBRATION

Warm up the unit for at least 10 minutes. Apply 0%, 5%, 25%, 50%, 75% and 100% input signal. Check that the output signal for the respective input signal remains within accuracy described in the data sheet. When the output is out of tolerance, recalibrate the unit according to the “ADJUSTMENT PROCEDURE” explained earlier.

LIGHTNING SURGE PROTECTION

M-System offers a series of lightning surge protector for protection against induced lightning surges. Please contact M-System to choose appropriate models.