

MULTI-FUNCTION PID CONTROLLER
(color LCD with touch-panel, MV output backup)

MODEL **SC110**

BEFORE USE

Thank you for choosing M-System. Before use, please check contents of the package you received as outlined below.

If you have any problems or questions with the product, please contact M-System's Sales Office or representatives.

- This product is for use in general industrial environments, therefore may not be suitable for applications which require higher level of safety (e.g. safety or accident prevention systems) or of reliability (e.g. vehicle control or combustion control systems).
- For safety, installation and maintenance of this product must be conducted by qualified personnel.

■ PACKAGE INCLUDES:

- Multi-function PID controller.....(1)
- Resistor module.....(2)
- CJC sensor.....(2)
- Mounting bracket.....(2)
- Connector adapter (with stereo jack type).....(1)

■ MODEL NO.

Confirm Model No. marking on the product to be exactly what you ordered.

■ INSTRUCTION MANUAL

This manual describes necessary points of caution when you use this product, including installation, connection and basic maintenance procedures. For more details, refer to the users manual (EM-6337-B) downloadable at M-System's web site: <http://www.m-system.co.jp>.

POINTS OF CAUTION

■ CONFORMITY WITH EU DIRECTIVES

- This equipment is suitable for Pollution Degree 2, Installation Category II (transient voltage 2500V) and Measurement Category II (contact output, transient voltage 2500V). Reinforced insulation (signal input or output to power: 300V) and basic insulation (signal input or output to contact output: 300V) are maintained. Prior to installation, check that the insulation class of this unit satisfies the system requirements.
- Altitude up to 2000 meters.
- Do not share the grounding point of PE (Protective Earth) of other devices with FG (Functional Ground). Handle as signal ground.
- The equipment must be installed such that appropriate clearance and creepage distances are maintained to conform to CE requirements. Failure to observe these requirements may invalidate the CE conformance.
- The actual installation environments such as panel configurations, connected devices, connected wires, may affect the protection level of this unit when it is integrated in a panel system. The user may have to review the CE requirements in regard to the whole system and employ additional protective measures to ensure the CE conformity.
- In order to enable the operator to turn off the power input immediately, install a switch or a circuit breaker according to the relevant requirements in IEC 60947-2 and properly indicate it.
- The equipment is intended to be installed in a industrial environment defined by EN 61000-6-2, EN 61000-6-4.
- Analog signals may have some fluctuation within $\pm 5\%$ during following tests.
 - EN 61000-4-3
Radiated, radio-frequency, electromagnetic field
 - EN 61000-4-6
Immunity to conducted disturbances, induced by radio-frequency fields
 - EN 61000-4-8
Power frequency magnetic field

■ POWER INPUT RATING & OPERATIONAL RANGE

- Locate the power input rating marked on the product and confirm its operational range as indicated below:
 - 100 – 240V AC rating: 85 – 264V, 50/60 Hz
 - Control module: $\leq 25VA$ at 100V
 $\leq 40VA$ at 240V
 - Backup module: $\leq 10VA$ at 100V
 $\leq 15VA$ at 240V
 - 24V DC rating: 24V $\pm 10\%$
 - Control module: $\leq 650mA$
 - Backup module: $\leq 150mA$
- Supplying any level of power other than specified above can damage the unit or the power source.
- Power supply start-up characteristics must reach within 5 seconds to the operational voltage range of the unit.
- Power cables and signal I/O cables for the unit must be located separately.
- Power cables and signal I/O cables for the unit should not be bundled together.

- To increase noise resistance of the power input wires, twist the strands before connecting.

■ GENERAL PRECAUTIONS

- Before you remove the unit, turn off the power supply and input signal for safety.
- Do not disassemble or modify the unit in any way. Doing so may result in a fire or an electrical shock.
- Do not block the unit's ventilation openings or use it in areas where heat accumulates. Additionally, do not store or use it under high-temperature conditions.
- Do not use this unit in an environment where flammable/corrosive gases are present.
- Do not store or use this unit in locations subject to direct sunlight, or where excessive dust, dirt or metal particles are present.
- This unit is a precision instrument. Do not store or use it where large shocks or excessive vibration can occur.
- Do not store or use this unit in environments subject to chemical evaporation (such as that of organic solvents), or where there are chemicals and/or acids present in the environment.
- Do not use paint thinner or organic solvents to clean this unit.
- Observe the environmental conditions when using this unit.
- Wait at least 30 seconds before turning on the power supply after it was turned off.

■ ENVIRONMENT

- Indoor use.
- This unit is designed to be mounted on a vertical panel. It is not suitable for a slanted or a horizontal panel surface.
- Environmental temperature must be within -5 to +55°C (23 to 131°F) with relative humidity within 5 to 90% RH in order to ensure adequate life span and operation.

■ GROUNDING

- Be sure to determine in advance the most stable grounding point in the environment and earth the unit's FG terminal and that of connected devices to it in order to protect the devices from dielectric breakdown.
- Grounding is also effective to eliminate noise that could cause errors in the unit's operation.

■ LCD PANEL

- The LCD panel's liquid contains an irritant. If the panel is damaged and the liquid contacts your skin, rinse immediately the contact area with running water for at least 15 minutes. If the liquid gets in your eyes, rinse immediately your eyes with running water for at least 15 minutes and consult a doctor.
- The following phenomena are LCD characteristics, and NOT a product defect:
 - LCD screen may show uneven brightness depending upon displayed images or contrast settings.
 - The LCD screen pixels may contain minute black-and-white-colored spots.
 - The color displayed on the LCD screen may appear different when seen from outside the specified viewing angle.
 - When the same image is displayed on the screen for a long time period, an afterimage may appear when the image is changed. If this happens, turn off the unit and wait for a while before restarting it.

- To prevent an afterimage:
 - Set the screensaver when you plan to display the same image for a long time period.
 - Plan to change the screen image periodically so that the same image does not remain for the long time period.
- The LCD surface is covered with a protective film at the factory shipment. Remove it once the unit is installed.

■ MINIMIZING NOISE INTERFERENCE TO ANALOG SIGNAL CABLES

- Noise entering through the analog signal cables may cause irregular measurement values, degradation of overall accuracy, and malfunction of the product. We recommend that you would conduct wiring to the unit with the following points of caution.
- Do not install cables close to noise sources (high frequency line, etc.).
- Do not bind the analog I/O cables together with those in which noises are present. Do not install them in the same duct.

■ CONNECTOR ADAPTER

- The connector adapter is included in "Stereo jack" type.
- PC Configurator cable (model: COP-US) is required when configuring.

■ CONNECTOR JACK

- The connector jack is covered with a cap. This cap protects against ingress of moisture or dust. Avoid moisture ingress into the jack.
- Do not operate the unit if moisture is inside the jack. Proceed cleaning blowing with air etc.
- To use the configurator cable, remove the cap of the jack and connect it after the conversion adapter is attached.
- Put the cap on the jack after operating with the configurator cable.

■ AND

- We recommend use of an UPS to supply power backups.
- The unit is designed to function as soon as power is supplied, however, a warm up for 10 minutes is required for satisfying complete performance described in the data sheet.

COMPONENT IDENTIFICATION

■ CONTROL MODULE FRONT VIEW

• Infrared communication type

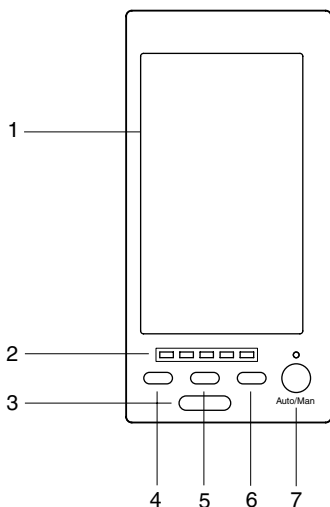

• Stereo jack type

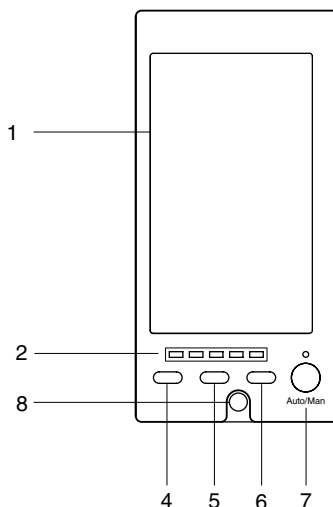

1. TFT Color LCD with touch panel
Provides operation and engineering views to facilitate monitoring and setting
2. MV output setting indicator LEDs for the backup mode
3. Infrared communication port
Used to communicate with PC via IRDA Communication Adaptor (model: COP-IRDA) to program and change parameters using Loop Configuration Builder Software (model: SFEW3E) or PC Configurator Software (model: SCCFG)
4. MV value (DOWN) button
5. Acceleration button
(Accelerates MV signal's changing speed by pressing simultaneously with MV value button)
6. MV value (UP) button
7. Auto / Man selector (changes the control mode for MV output)
8. Configurator jack and cap
Connects with a PC where Loop Configuration Builder Software (model: SFEW3E) or PC configurator software (model: SCCFG) is installed via a PC configurator cable (model: COP-US) and enables programming and parameter setting

■ BACKUP MODULE

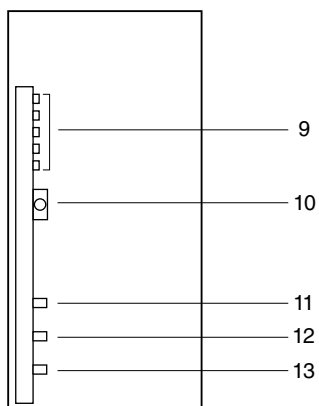

9. MV output setting indicators
10. Configurator jack
11. MV value (UP) button
12. Acceleration button
(Accelerates MV signal's changing speed by pressing simultaneously with MV value button)
13. MV value (DOWN) button

INSTALLATION

■ PANEL CUTOUT unit: mm

• Single mounting

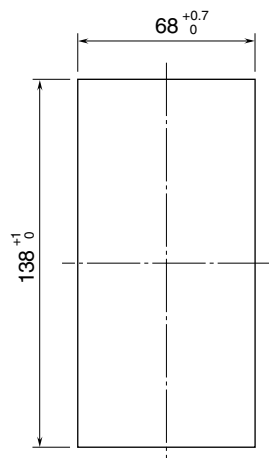

• Clustered mounting

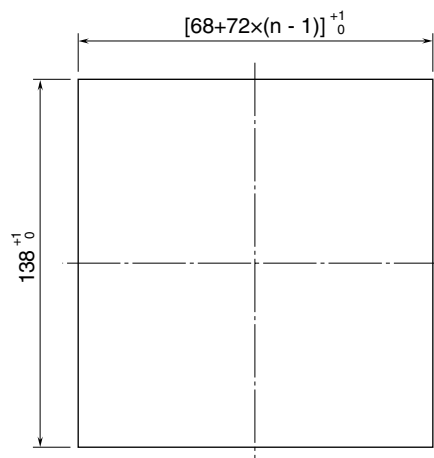

n = number of units

Panel thickness 2.3 – 20

■ CAUTION

- IP55 is ensured for the front panel of the unit mounted independently according to a panel. Test the sealing at the mounting surface once the device is installed.
- Set the unit on a vertical surface with its operation buttons at the lower side. Mounting in other directions may cause heat built up inside the unit and shorten its life or degrade its performance.
- Ensure that there is sufficient space for ventilation inside a panel. Do not install above the devices that generate high heat such as heaters, transformers or resistors. Leave at least 30 mm (1.2 inch) space above, below and behind the unit for maintenance purpose (e.g. wiring, removing or installing).

■ HOW TO REMOVE THE TERMINAL BLOCK

The terminal block is separable in two pieces (with option /T). Loosen two screws on upper and lower of the terminal block to separate.

In order to attach the terminal block, tighten the terminal fixing screws evenly. (torque: 1.2 N·m)

Be sure to turn off the power supply, input signal and power supply to the output relays before separating the terminal block.

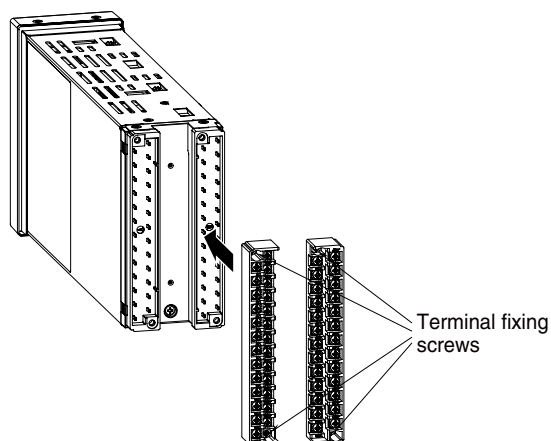

■ HOW TO MOUNT THE UNIT ON A PANEL

- 1) Remove both mounting brackets.
- 2) Detach the terminal cover and insert it first and then the module itself into the cutout hole. (The cover is slightly wider than the module.)
- 3) Put and slide the brackets back into the holes at the top and the bottom and tighten them until the module is firmly fixed.

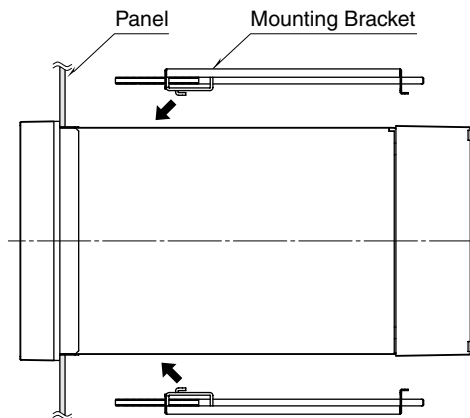

■ HOW TO REMOVE THE TERMINAL COVER

Insert the minus tip of a screwdriver into each hole at the four corners of the cover and pull it to the direction as indicated below to separate the terminal cover.

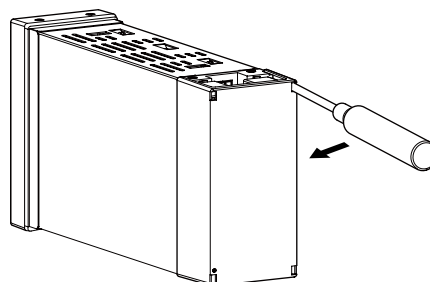

TERMINAL CONNECTIONS

Connect the unit as in the diagram below or refer to the connection diagram on the terminal cover.

■ EXTERNAL DIMENSIONS unit: mm (inch)

■ INFRARED COMMUNICATION TYPE

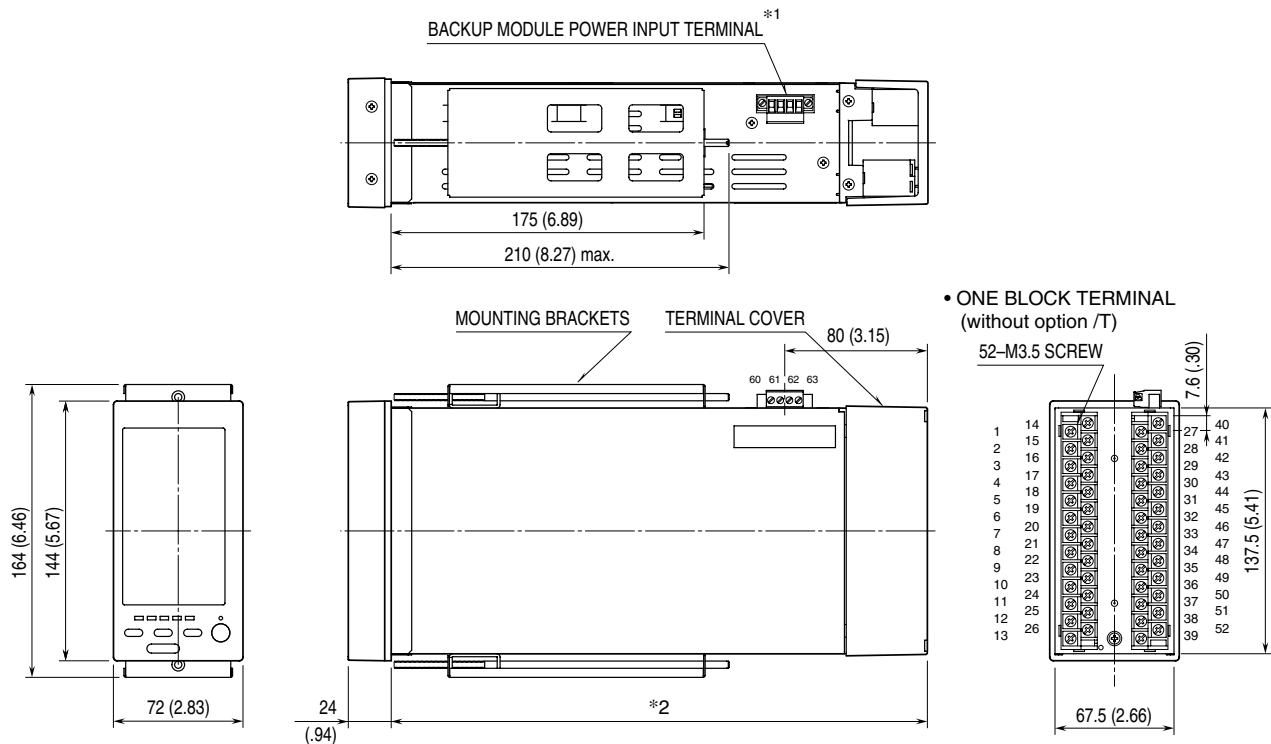

*1. Option /M2, /R only
 *2. Option /3: 300 mm (11.81")
 Option /4: 400 mm (15.75")
 Option /6: 600 mm (23.62")

• ONE BLOCK TERMINAL (without option /T)

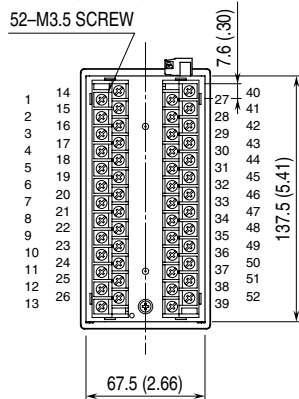

• SEPARABLE TERMINAL (with option /T)

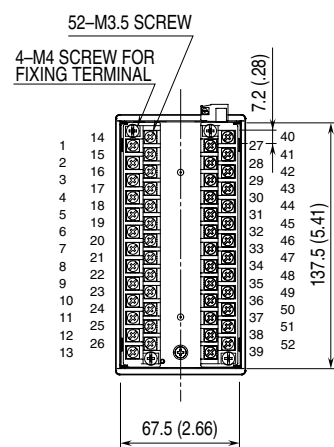

■ STEREO JACK TYPE

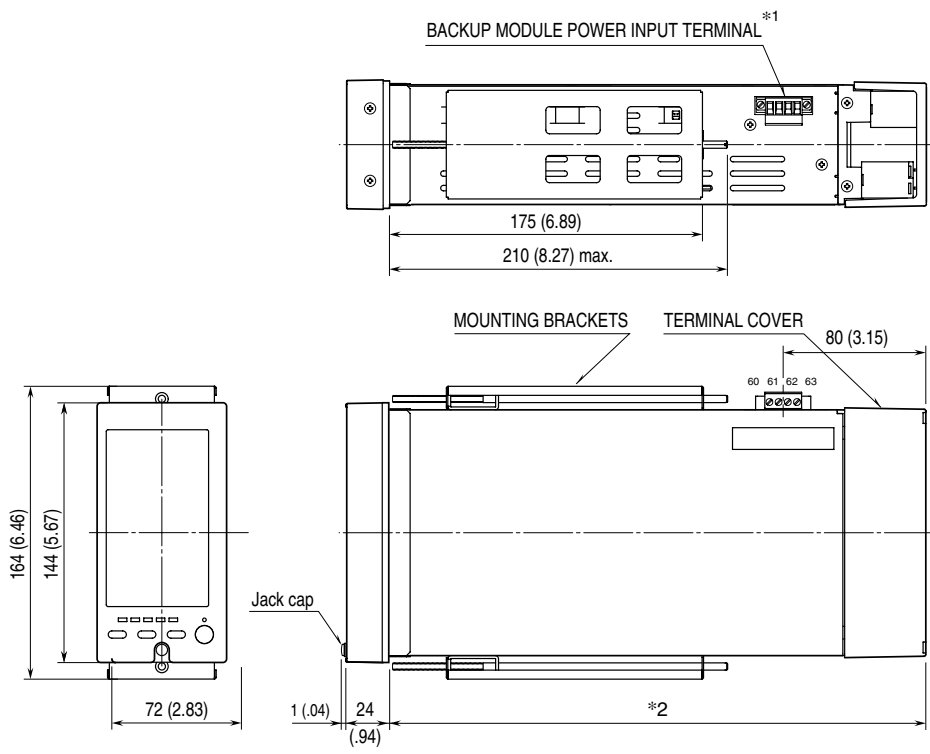

*1. Option /M2, /R only *2. Option /3: 300 mm (11.81")
 Option /4: 400 mm (15.75")
 Option /6: 600 mm (23.62")

• ONE BLOCK TERMINAL (without option /T)

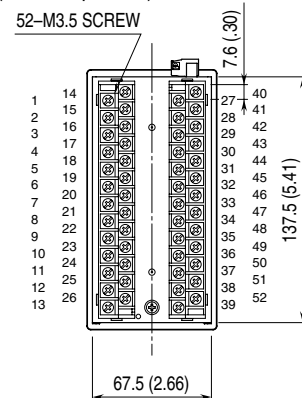

• SEPARABLE TERMINAL (with option /T)

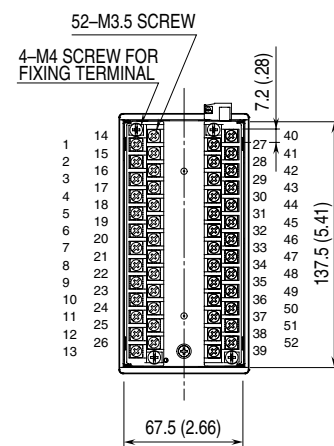

■ CONNECTION DIAGRAM

Note: In order to improve EMC performance, bond the FG terminal to ground.

Caution: FG terminal is NOT a protective conductor terminal.

■ BACKUP MODULE POWER SUPPLY: SINGLE SUPPLY

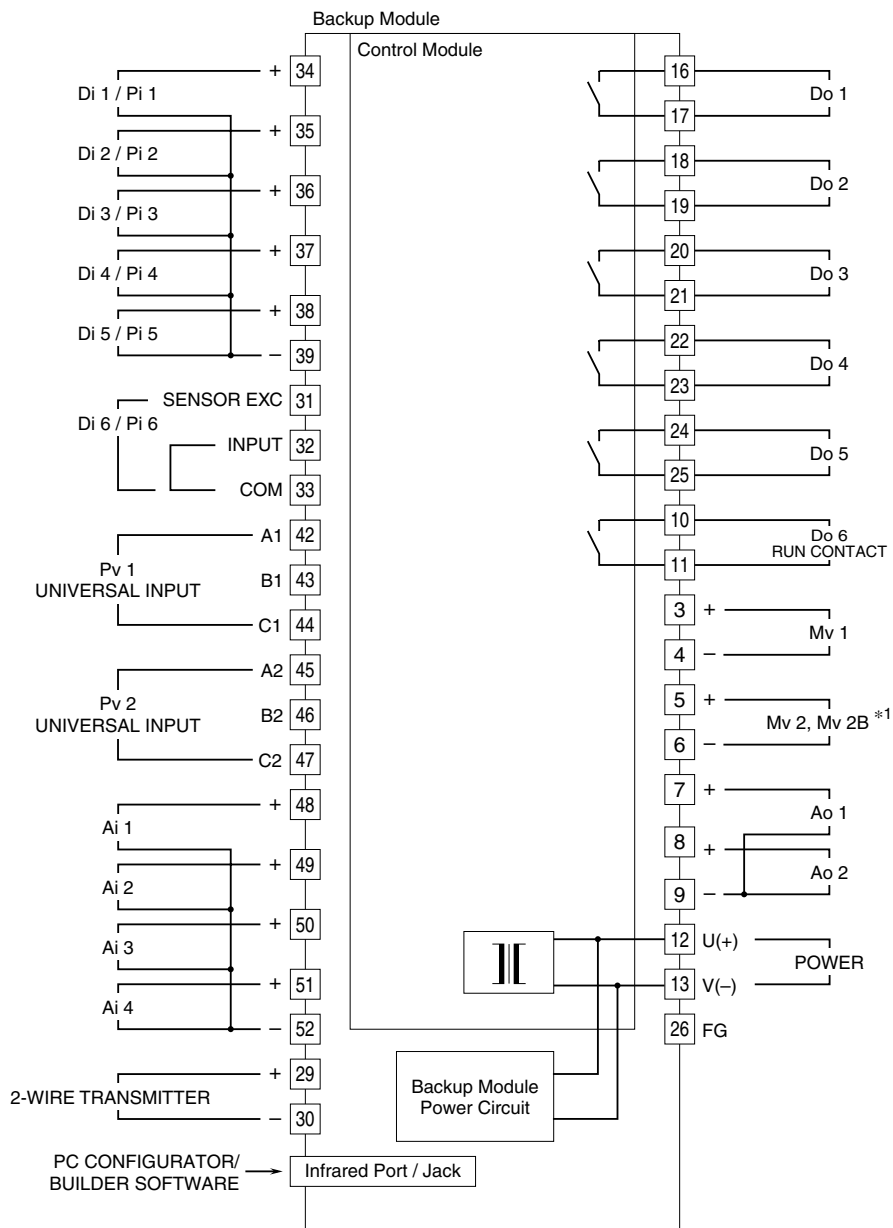

*1. Backup is applicable to Mv 2 only. Mv 2B is output of the backup module.

■ UNIVERSAL INPUT CONNECTION E.G.

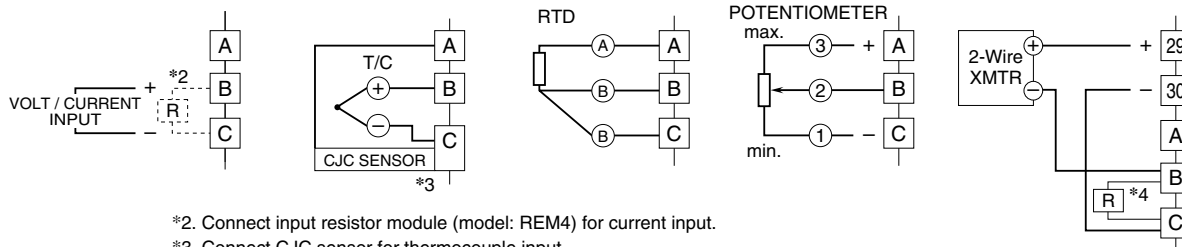

*2. Connect input resistor module (model: REM4) for current input.

*3. Connect C/JC sensor for thermocouple input.

*4. Connect input resistor module (model: REM4).

■ DISCRETE INPUT PULSE INPUT CONNECTION E.G.:

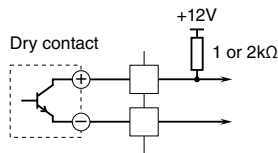

■ BACKUP MODULE POWER SUPPLY: DUAL SUPPLY

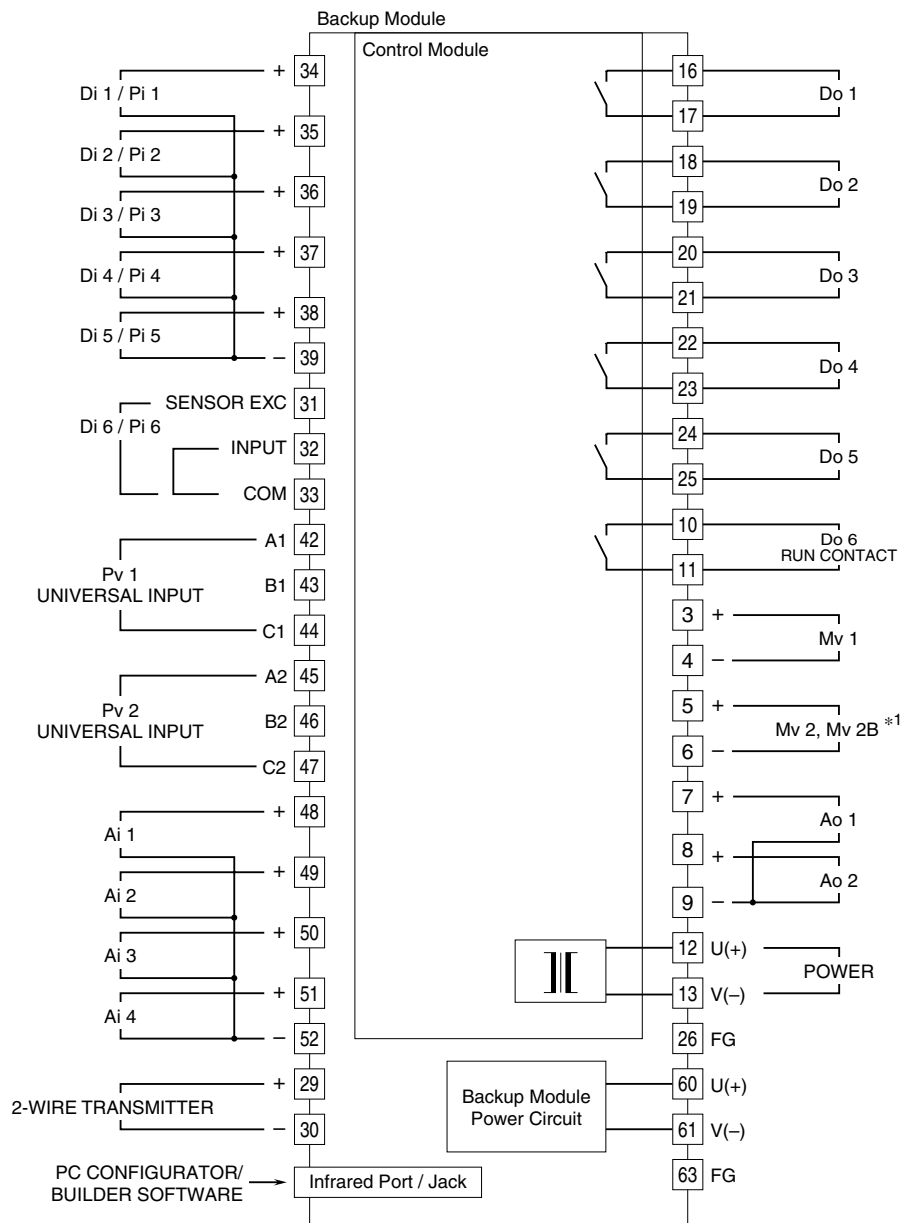

*1. Backup is applicable to Mv 2 only. Mv 2B is output of the backup module.

■ UNIVERSAL INPUT CONNECTION E.G.

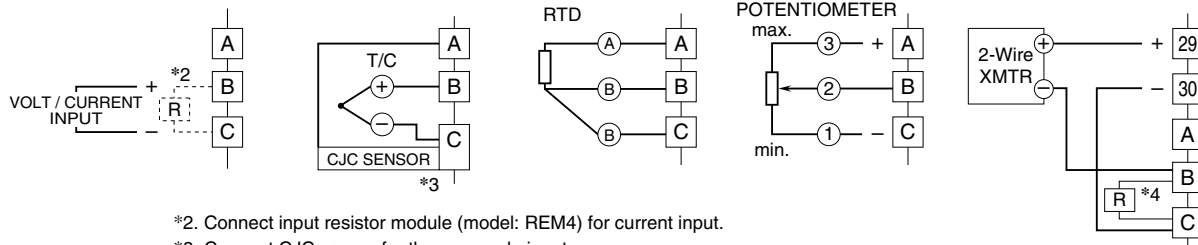

- *2. Connect input resistor module (model: REM4) for current input.
- *3. Connect C/JC sensor for thermocouple input.
- *4. Connect input resistor module (model: REM4).

■ DISCRETE INPUT PULSE INPUT CONNECTION E.G.:

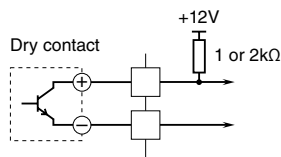

PREPARATION & WIRING TO THE UNIT

■ POWER SUPPLY

Confirm the power input rating marked on the product.

- 1) Remove the terminal cover.
- 2) Connect power input and protective earth cables to the power supply terminals.
- 3) Replace the terminal cover.

■ I/O SIGNALS

Refer to the following example of connecting DC signal to Pv 1 universal input terminals:

- 1) Turn off the power supply and remove the terminal cover.
- 2) Connect positive signal wire to the terminal B1 [43] and negative wire to C1 [44].
- 3) Replace the terminal cover.

Choose appropriate solderless terminals and wires:

- **Power supply, I/O terminal**

Connection

Terminal screws: M3.5 screw terminal (torque 1.0 N·m)

Terminal fixing screws: M4 screw terminal (torque 1.2 N·m)

Screw terminal

Terminal screws: Nickel-plated steel (standard) or stainless steel

Terminal fixing screws: Chrome-plated steel

Recommended solderless terminal: R1.25-3.5

- **Backup module power supply terminal (option /M2, /R)**

Applicable wire size: dia. 2.4 max., 0.5 – 2.5 mm²

Stripped length: 10 mm

LIGHTNING SURGE PROTECTION

M-System offers a series of lightning surge protector for protection against induced lightning surges. Please contact M-System to choose appropriate models.