

Remote I/O R1M Series

RTD & POTENTIOMETER INPUT MODULE

(8 points)

Functions & Features

- 8-point RTD or potentiometer inputs
- Easy system expansion via Modbus RTU

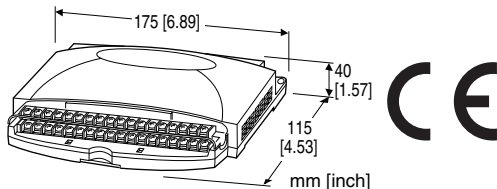

MODEL: R1M-J3T-[1][2]

ORDERING INFORMATION

- Code number: R1M-J3T-[1][2]

Specify a code from below for each of [1] and [2].

- (e.g. R1M-J3T-M2/Q)
- Specify the specification for option code /Q (e.g. /C01)

FIELD TERMINAL TYPE

T: M3 screw terminals

[1] POWER INPUT

AC Power

M2: 100 - 240 V AC (Operational voltage range 85 - 264 V, 47 - 66 Hz)

DC Power

R: 24 V DC

(Operational voltage range 24 V \pm 10 %, ripple 10 %p-p max.)

[2] OPTIONS

blank: none

/Q: With options (specify the specification)

SPECIFICATIONS OF OPTION: Q

COATING (For the detail, refer to M-System's web site.)

/C01: Silicone coating

/C02: Polyurethane coating

/C03: Rubber coating

RELATED PRODUCTS

- R1X configurator software (model: R1CON)

Downloadable at M-System's web site.

A dedicated cable is required to connect the module to the PC. Please refer to the internet software download site or the users manual for the PC configurator for applicable cable types.

GENERAL SPECIFICATIONS

Connection

Power input, transmission: Euro type connector terminal (Applicable wire size AWG24-12 (0.2 - 2.5 mm²), stripped length 7 mm)

RS-232-C: 9-pin D-sub connector (male)

(Lock screw No. 4-40 UNC)

Input: M3 screw terminals (torque: 0.6N·m)

Screw terminal: Nickel-plated steel

Housing material: Flame-resistant resin (gray)

Isolation: Input to RS-232-C or RS-485 to power

Node address setting: Rotary switch; 1 - F (15 nodes)

RUN indicator LED: Green light blinks in normal conditions.

COMMUNICATION

Baud rate: 38.4 kbps

Communication: Half-duplex, asynchronous, no procedure

Protocol: Modbus RTU

Refer to Modbus Protocol Reference Guide (EM-5650) for supported functions.

■ RS-232-C

Standard: Conforms to RS-232-C, EIA

Transmission distance: 10 meters max.

■ RS-485

Standard: Conforms to TIA/EIA-485-A

Transmission distance: 500 meters max.

Transmission media: Shielded twisted-pair cable (CPEV-S 0.9 dia.)

INPUT SPECIFICATIONS

Input: RTD or potentiometer input, 8 points

Maximum leadwire resistance: 20 Ω per wire (3-wire)

Sensing current: \leq 1 mA

RTDs: JPt 100 (JIS '89), Pt 100 (JIS '89), Pt 100

(JIS '97, IEC), Pt 50 Ω (JIS '81), Ni 508.4 Ω , Pt 1000

Potentiometers: 0 - 100 Ω , 0 - 500 Ω , 0 - 1 k Ω , 0 - 10 k Ω

Sampling rate: 100 msec./8 points

- **Trigger input:** Dry contact; ON detected at \leq 1.5 V

Sensing: Approx. 5 V DC @ 1 mA

INSTALLATION**Power consumption**

- AC: Approx. 10 VA
- DC: Approx. 7 W

Operating temperature: -5 to +60°C (23 to 140°F)

Operating humidity: 30 to 90 %RH (non-condensing)

Mounting: Surface or DIN rail

Weight: 400 g (0.88 lb)

PERFORMANCE (% of measuring range)

Temp. coefficient: ± 0.015 %/°C (± 0.008 %/°F)

Insulation resistance: ≥ 100 M Ω with 500 V DC

Dielectric strength: 2000 V AC @ 1 minute (input to RS-232-C or RS-485 to power to FG)

Accuracy

Potentiometer input: $\pm 0.3\%$

RTD input: See the table below.

RTD	USABLE RANGE		ACCURACY (%)
	°C	°F	
JPt 100 (JIS '89)	-200 to +500	-328 to +932	± 0.2
Pt 100 (JIS '89)	-200 to +660	-328 to +1220	± 0.2
Pt 100 (JIS '97, IEC)	-200 to +850	-328 to +1562	± 0.2
Pt 50 Ω (JIS '81)	-200 to +649	-328 to +1200	± 0.3
Ni 508.4 Ω	-50 to +280	-58 to +536	± 0.3
Pt 1000	-200 to +850	-328 to +1562	± 0.2

STANDARDS & APPROVALS**EU conformity:**

EMC Directive

EMI EN 61000-6-4

EMS EN 61000-6-2

Low Voltage Directive

EN 61010-1, EN 61010-2-201

Measurement Category II (output)

Pollution Degree 2

Input or RS-232-C/RS-485 to power: Reinforced insulation (300 V)

Input to RS-232-C/RS-485: Basic insulation (300 V)

RoHS Directive

EXTERNAL VIEW

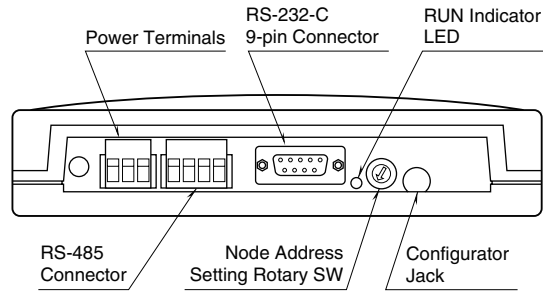

■ RS-232-C INTERFACE



ABBR.	PIN NO.	EXPLANATION OF FUNCTION
BA (SD)	2	Transmitted Data
BB (RD)	3	Received Data
AB (SG)	5	Signal Common
CB (CS)	7	Clear to Send
CA (RS)	8	Request to Send
	1	Not Used.
	4	DO NOT connect. Connecting may cause malfunctions.
	6	
	9	

MODBUS WIRING CONNECTION

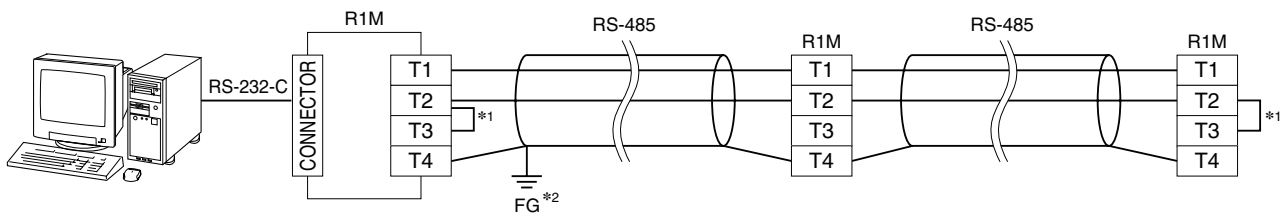

*1. Internal terminating resistor is used when the device is at the end of a transmission line.

*2. Install shielded cables to all sections and ground them at single point.

CONNECTION DIAGRAM

Note: In order to improve EMC performance, bond the FG terminal to ground.

Caution: FG terminal is NOT a protective conductor terminal.

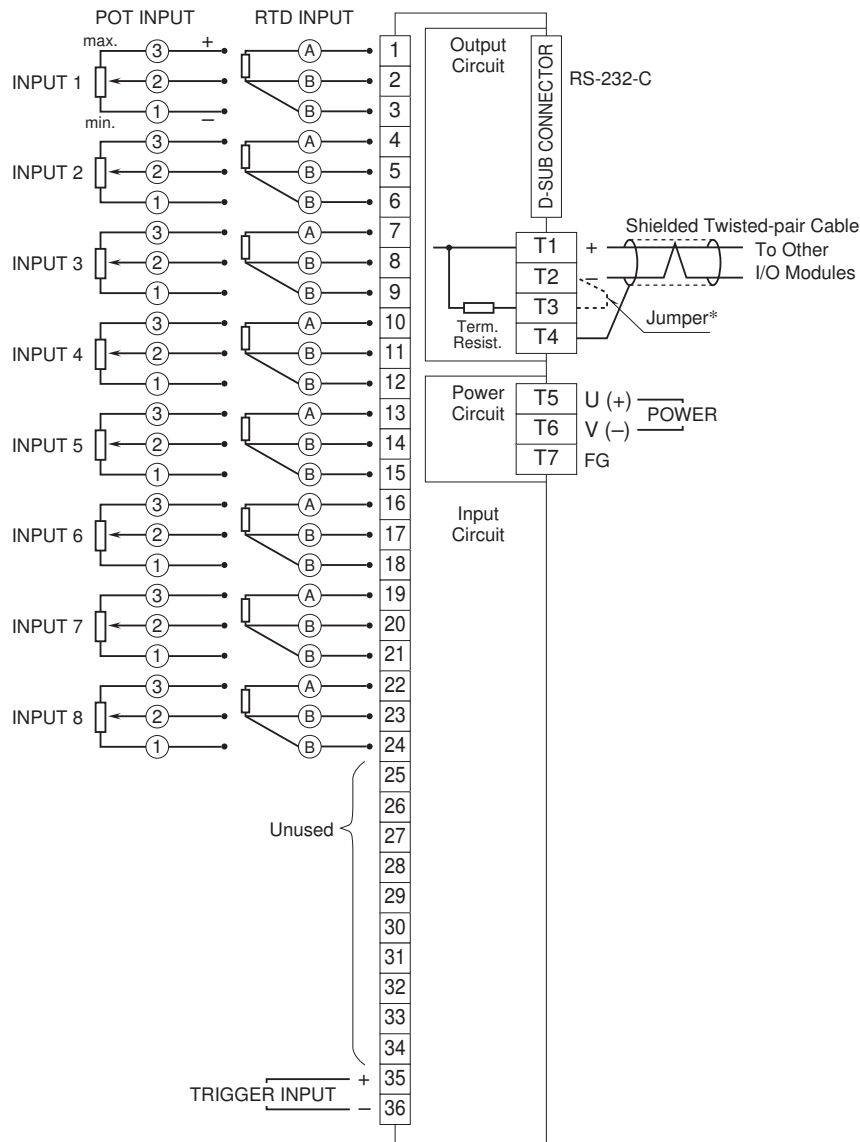

* When the device is located at the end of a transmission line via twisted-pair cable, (when there is no cross-wiring), close across the terminal T2 –T3 with the attached jumper pin (or with a leadwire). When the device is not at the end, remove the jumper pin.

This device is not designed to attenuate noises on input signals, therefore we recommend that the user takes precautions to eliminate noises from the input signals e.g. by using shielded twisted-pair cable. DO NOT CONNECT to the terminals 25 through 34. Wrong connection may cause failure of the device.

MODBUS COMMUNICATION

■ COMMUNICATION PARAMETERS

PARAMETER	SPECIFICATION
Data Mode	RTU
Baud Rate	9600 / 19200 / 38400 (*) bps
Parity	None / Odd (*) / Even
Bit Length	8
Stop Bit	1 (*) / 2
Node Address	1 (*) to 15
Floating Point Data	N/A
Interface	RS-232-C/ RS-485

(*) Ex-factory setting

■ FUNCTION CODES & SUPPORTED CODES

CODE	NAME		
01	Read Coil Status	X	Digital output from the slave
02	Read Input Status	X	Status of digital inputs to the slave
03	Read Holding Registers	X	General purpose register within the slave
04	Read Input Registers	X	Collected data from the field by the slave
05	Force Single Coil	X	Digital output from the slave
06	Preset Single Registers	X	General purpose register within the slave
07	Read Exception Status		
08	Diagnostics		
09	Program 484		
10	Poll 484		
11	Fetch Comm. Event Counter		Fetch a status word and an event counter
12	Fetch Comm. Event Log		A status word, an event counter, a message count and a field of event bytes
13	Program Controller		
14	Poll Controller		
15	Force Multiple Coils	X	Digital output from the slave
16	Preset Multiple Registers	X	General purpose register within the slave
17	Report Slave ID		Slave type / 'RUN' status
18	Program 884/M84		
19	Reset Comm. Link		
20	Read General Reference		
21	Write General Reference		
22	Mask Write 4X Register		
23	Read/Write 4X Register		
24	Read FIFO Queue		

■ DATA ADDRESS

	ADDRESS	TYPE				DATA FORMAT	NAME	
		GH2	J3	A1	D1			
Coil (0X)	1 – 32	---	---	---	Y	bit	DO *1	
	33 – 48	Y	---	---	---	bit	Cold junction compensation SW (0: Disable, 1: Enable) *2	
Input Status (1X)	1 – 32	Y	Y	Y	---	bit	DI *3	
	33 – 48	Y	Y	---	---	bit	ADC overrange	
Input Register (3X)	1 – 16	Y	---	---	---	I	AI in % (1 – 8 for Type J3)	
	17 – 48	Y	Y	---	---	F	AI per channel in engineering unit	
	49 – 50	Y	---	---	---	F	Cold junction temperature *2	
	81 – 96	Y	Y	---	---	I	Channel status	
	513	Y	Y	Y	Y	I	Bit	System Status
							0 to 5	Reserved for system use
							6	E ² PROM diagnostics (0: Normal, 1: Error)
							7	ADC error (0: Normal, 1: Error)
8 to 15	Reserved for system use							
514 – 521	Y	Y	Y	Y	B16	Model No. (“R1M-x”)		
522 – 529	Y	Y	Y	Y	B16	Serial No.		
530 – 537	Y	Y	Y	Y	B16	Hardware version No.		
538 – 545	Y	Y	Y	Y	B16	Firmware version No.		
Holding Register (4X)	1 – 16	---	---	---	---	I	(Reserved for AO in %)	
	17 – 48	---	---	---	---	F	(Reserved for AO in engineering unit)	
	145 – 160	Y	Y	---	---	I	I/O type No.	
	161 – 176	Y	---	---	---	I	Burnout type (161 – 168 for Type J3) (0: No burnout, 1: Upscale, 2: Downscale) *4	

I = 16-bit integer, F = 32-bit floating, B16 = 16-byte character

*1. Discrete output only.

*2. Thermocouple input only.

*3. Trigger contact input for Types GH2 and J3. (Only Address 10001 is enabled.)

*4. Same setting for all channels. For potentiometer inputs, always leave certain residual resistance at 0% side in order to avoid wrong burnout detection. (0% input or shortcircuit across the terminals 1 – 2 = Wire breakdown at the terminal 3)

■ INPUT DATA

• 32-bit Floating

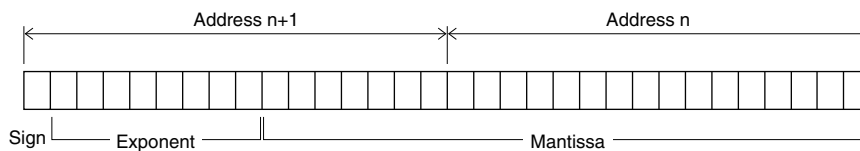

• 32-bit Integer, No sign (R1M-A1)

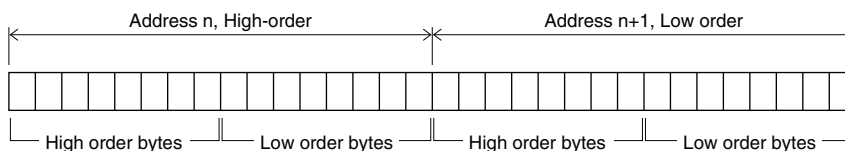

■ INPUT REGISTERS DESCRIPTION

(1) ANALOG INPUT IN % (30001 to 30016; 30001 to 30008 for J3)

Indicates analog input values in percentage for each channel (1 – 16; 1 – 8 for J3).

INPUT TYPE & RANGE		A/D DATA (Decimal)
DC	±20V	±20000
	±5V	±5000
	±1V	±10000
	±0.8V	±8000
	±0.2V	±20000
	±50mV	±5000
	±10mV	±10000
Thermocouple		Temperature x 10
RTD		Temperature x 10
Potentiometer	0 – 100Ω	±2000
	0 – 500Ω	
	0 – 1kΩ	
	0 – 10kΩ	

(2) ANALOG INPUT IN ENGINEERING UNIT (30017 to 30048; 30017 to 30032 for J3)

Indicates analog input values in engineering unit for each channel (1 – 16; 1 – 8 for J3). The unit is specific to each input type: °C for temperature, Volts for voltage, and % for potentiometer. The data are 32-bit floating values, which requires two consecutive registers for one module.

(3) CHANNEL STATUS (30081 to 30096)

Indicates the current status of analog inputs (1 – 16; 1 – 8 for J3). The following list shows the names and descriptions of each bit.

BIT	NAME	DESCRIPTION
6	Input Overrange	Indicates the designated analog input is in overrange, defined as one or more of the following condition: <ul style="list-style-type: none"> • ADC input value 0x0000 or 0xFFFF • Burnout status for thermocouple, RTD and Potentiometer input • Out of range defined in the temperature table (thermocouple and RTD) • ADC error 0 : Normal 1 : Overrange
7	ADC Error	Indicates the status of ADC. 0 : Normal 1 : Error
12	Cold Junction Compensation SW	Indicates whether the cold junction compensation is enabled or disabled, for thermocouple input. 0 : Disable 1 : Enable
Others	Reserved	For system's use

■ INPUT REGISTERS DESCRIPTION

Indicates I/O type for each channel. The data are 16-bit integer values.

MODEL	I/O	I/O TYPE	SELECTION	USABLE RANGE	NOTES
R1MS-GH3 R2M-2G3	DC input	0x00	-10 to +10 V	-10 to +10 V	
R1M-GH2	DC input	0x00	-20 to +20 V	-22.7 to +22.7 V	ATT SW ON
		0x01	-5 to +5 V	-5.6 to +5.6 V	ATT SW ON
		0x02	-1 to +1 V	-1.4 to +1.4 V	ATT SW ON
		0x03	-800 to +800 mV	-860 to +860 mV	
		0x04	-200 to +200 mV	-215 to +215 mV	
		0x05	-50 to +50 mV	-53 to +53 mV	
		0x06	-10 to +10 mV	-13.4 to +13.4 mV	
R1M-GH2 R1MS-GH3 R2M-2H3	T/C input	0x10	(PR)	0 to 1770°C	
		0x11	K (CA)	-270 to +1370°C	
		0x12	E (CRC)	-270 to +1000°C	
		0x13	J (IC)	-210 to +1200°C	
		0x14	T (CC)	-270 to +400°C	
		0x15	B (RH)	100 to 1820°C	
		0x16	R	-50 to +1760°C	
		0x17	S	-50 to +1760°C	
		0x18	C (WRe 5-26)	0 to 2320°C	
		0x19	N	-270 to +1300°C	
		0x1A	U	-200 to +600°C	
		0x1B	L	-200 to +900°C	
		0x1C	P (Platinel II)	0 to 1395°C	
R1M-J3	RTD input	0x30	JPt 100 (JIS '89)	-200 to +500°C	
		0x31	Pt 100 (JIS '89)	-200 to +660°C	
		0x32	Pt 100 (JIS '97, IEC)	-200 to +850°C	
		0x33	Pt 50 Ω (JIS '81)	-200 to +649°C	
		0x34	Ni 508.4 Ω	-50 to +280°C	
		0x35	Pt 1000	-200 to +850°C	
	POT input	0x40	0 to 100 ohms	0 to 100 %	
		0x41	0 to 500 ohms	0 to 100 %	
		0x42	0 to 1 kohms	0 to 100 %	
		0x43	0 to 10 kohms	0 to 100 %	
R1M-D1	DO	0x60			
R1M-A1	DI	0x70			

EXTERNAL DIMENSIONS & TERMINAL ASSIGNMENTS unit: mm [inch]

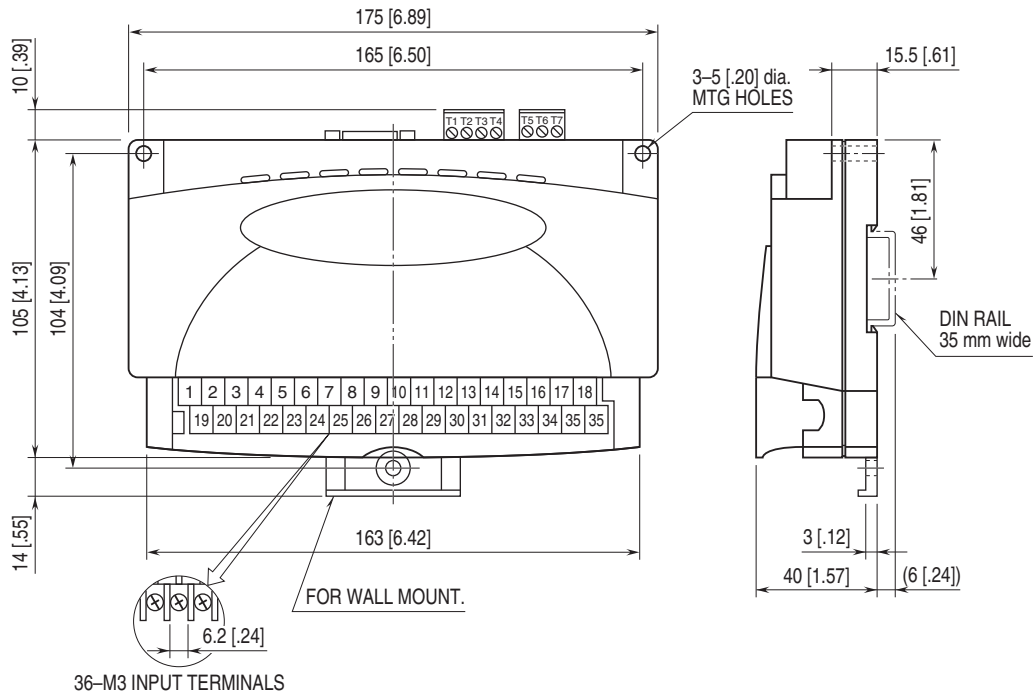

SYSTEM CONFIGURATION EXAMPLES

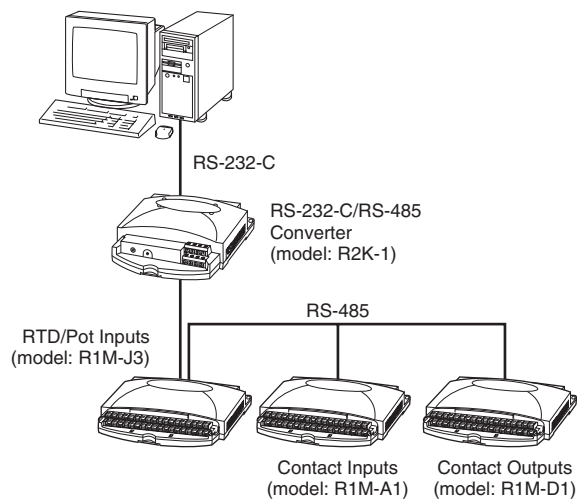

When the cable distance between the PC and the R1Ms is long, insert an RS-232C/RS-485 Converter for isolation.



Specifications are subject to change without notice.