

RTD & POTENTIOMETER INPUT MODULE (8 points)	MODEL R1M-J3
--	---------------------

BEFORE USE

Thank you for choosing M-System. Before use, please check contents of the package you received as outlined below. If you have any problems or questions with the product, please contact M-System's Sales Office or representatives.

This product is for use in general industrial environments, therefore may not be suitable for applications which require higher level of safety (e.g. safety or accident prevention systems) or of reliability (e.g. vehicle control or combustion control systems).

For safety, installation and maintenance of this product must be conducted by qualified personnel.

■ PACKAGE INCLUDES:

Remote I/O module(1)

■ MODEL NO.

Confirm Model No. marking on the product to be exactly what you ordered.

■ INSTRUCTION MANUAL

This manual describes necessary points of caution when you use this product, including installation, connection and basic maintenance procedures. For detailed information on Modbus supported functions, refer to Modbus Protocol Reference Guide (EM-5650). The R1M is programmable using the PC configurator software. For detailed information on the PC configuration, refer to the R1CON instruction manual. The R1CON PC Configurator Software is downloadable at M-System's web site: <http://www.m-system.co.jp>.

POINTS OF CAUTION

■ CONFORMITY WITH EU DIRECTIVES

- This equipment is suitable for Pollution Degree 2 and Installation Category II (transient voltage 2500V). Reinforced insulation (input or RS-232-C/RS-485 to power: 300V) and basic insulation (input to RS-232-C/RS-485: 300V) are maintained. Prior to installation, check that the insulation class of this unit satisfies the system requirements.
- Altitude up to 2000 meters.
- The equipment must be mounted inside a panel.
- Insert noise filters. Okaya Electric Industries Model SUP-E1H or equivalent for the power source connected to the unit, and TDK Model ZCAT 3035-1330 or equivalent for the RS-232-C cable are recommended.

- The equipment must be installed such that appropriate clearance and creepage distances are maintained to conform to CE requirements. Failure to observe these requirements may invalidate the CE conformance.
- The actual installation environments such as panel configurations, connected devices, connected wires, may affect the protection level of this unit when it is integrated in a panel system. The user may have to review the CE requirements in regard to the whole system and employ additional protective measures to ensure the CE conformity.
- Install lightning surge protectors for those wires connected to remote locations.

■ POWER INPUT RATING & OPERATIONAL RANGE

- Locate the power input rating marked on the product and confirm its operational range as indicated below:
 100 – 240V AC rating: 85 – 264V, 47 – 66 Hz, approx. 10VA
 24V DC rating: 24V ±10%, approx. 7W

■ GENERAL PRECAUTIONS

- Before you remove the module, turn off the power supply and input signal for safety.

■ ENVIRONMENT

- Indoor use.
- When heavy dust or metal particles are present in the air, install the module inside proper housing with sufficient ventilation.
- Do not install the module where it is subjected to continuous vibration. Do not subject the unit to physical impact.
- Environmental temperature must be within -5 to +60°C (23 to 140°F) with relative humidity within 30 to 90% RH in order to ensure adequate life span and operation.
- Be sure that the ventilation slits are not covered with cables, etc.

■ WIRING

- Wrong connection may damage the module.
- Do not connect cables to moving parts or pull them tightly.
- Do not install cables close to noise sources (relay drive cable, high frequency line, etc.).
- Do not bind these cables together with those in which noises are present. Do not install them in the same duct.

■ AND

- The module is designed to function as soon as power is supplied, however, a warm up for 10 minutes is required for satisfying complete performance described in the data sheet.

COMPONENT IDENTIFICATION

REAR VIEW

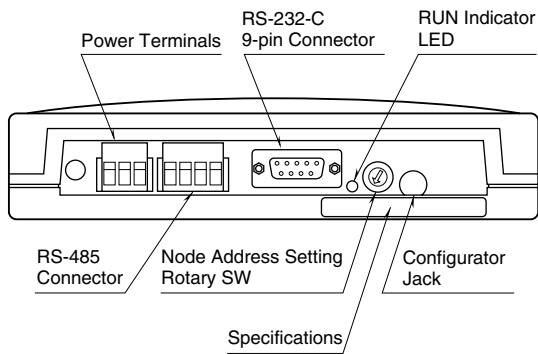

INSTALLATION

DIN RAIL MOUNTING

Set the body so that its DIN rail adaptor is at the bottom. Pull down the DIN rail adaptor.

Position the upper hook at the rear side on the DIN rail and push in the lower. Push back the DIN rail adaptor.

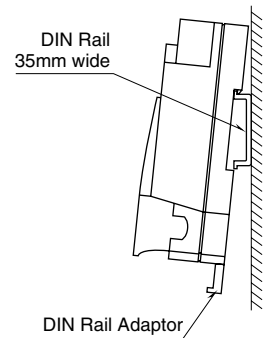

WALL MOUNTING

Set the body so that its DIN rail adaptor is at the bottom. Pull down the DIN rail adaptor.

Refer to "EXTERNAL DIMENSIONS."

TERMINAL CONNECTIONS

Connect the module referring to the connection diagram.

EXTERNAL DIMENSIONS unit: mm (inch)

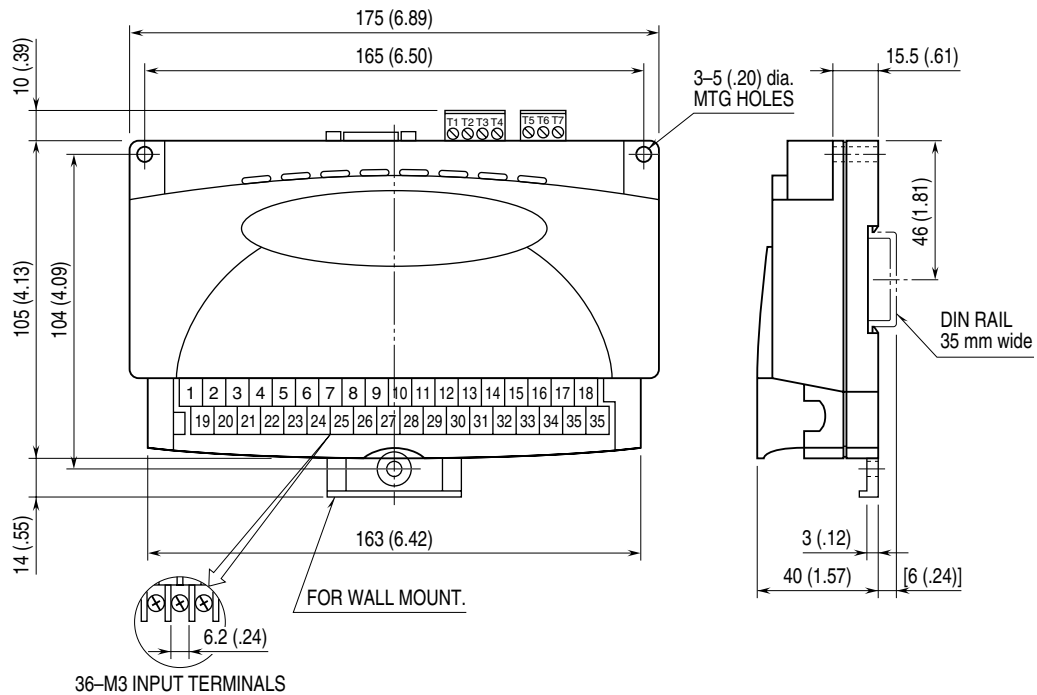

■ CONNECTION DIAGRAM

Note: In order to improve EMC performance, bond the FG terminal to ground.
 Caution: FG terminal is NOT a protective conductor terminal.

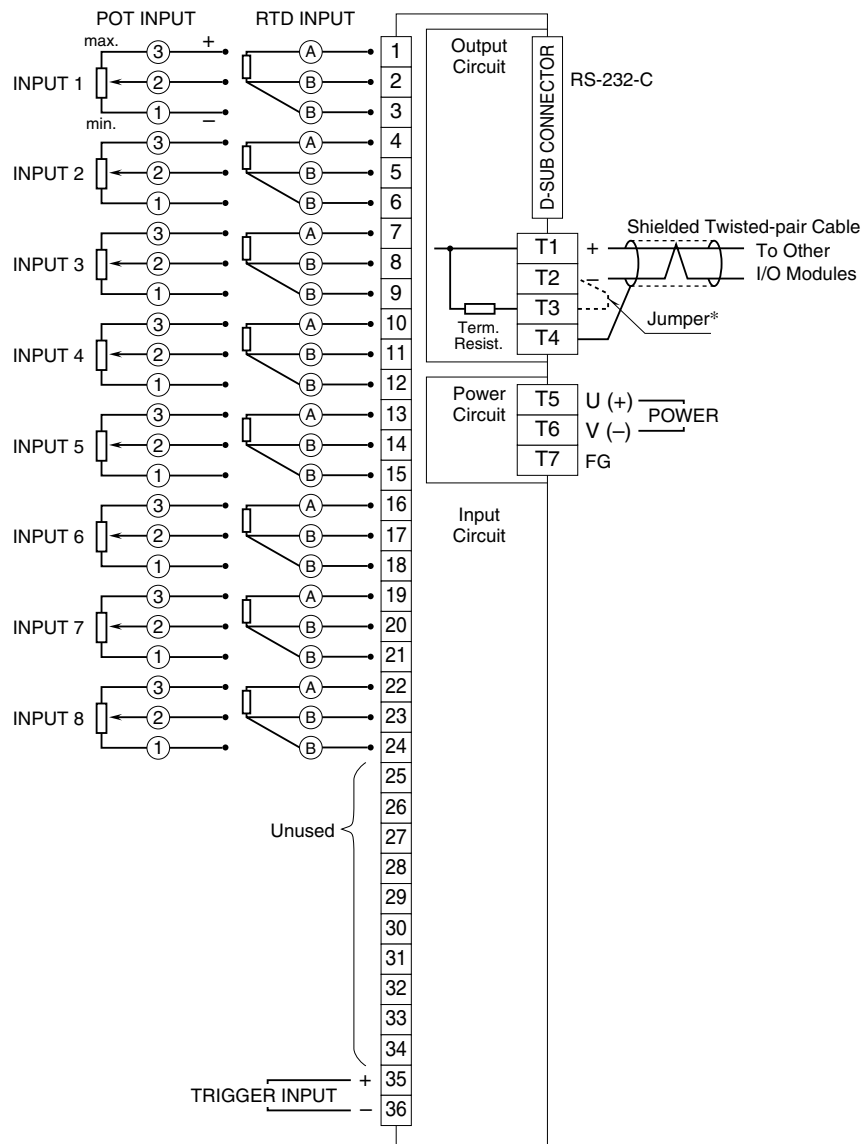

* When the device is located at the end of a transmission line via twisted-pair cable, (when there is no cross-wiring), close across the terminal T2 – T3 with the attached jumper pin (or with a leadwire).
 When the device is not at the end, remove the jumper pin.

This device is not designed to attenuate noises on input signals, therefore we recommend that the user takes precautions to eliminate noises from the input signals e.g. by using shielded twisted-pair cable. DO NOT CONNECT to the terminals 25 through 34. Wrong connection may cause failure of the device.

■ RS-232-C INTERFACE



ABBR.	PIN NO.	EXPLANATION OF FUNCTION
BA (SD)	2	Transmitted Data
BB (RD)	3	Received Data
AB (SG)	5	Signal Common
CB (CS)	7	Clear to Send
CA (RS)	8	Request to Send
	1	Not Used.
	4	DO NOT connect. Connecting may cause malfunctions.
	6	
	9	

WIRING INSTRUCTIONS

■ M3 SCREW TERMINAL (Input signal)

Torque: 0.6 N·m

■ SOLDERLESS TERMINAL

Refer to the drawing below for recommended ring tongue terminal size. Spade tongue type is also applicable.

Applicable wire size: 0.75 to 1.25 mm² (AWG19 – 16)

Recommended manufacturer: Japan Solderless Terminal MFG.Co.Ltd, Nichifu Co.,ltd

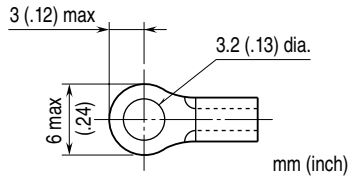

■ EURO TYPE CONNECTOR TERMINAL (Power input, Modbus)

Applicable wire size: 0.2 – 2.5 mm² (AWG24-12)

Stripped length: 7 mm

MODBUS WIRING CONNECTION

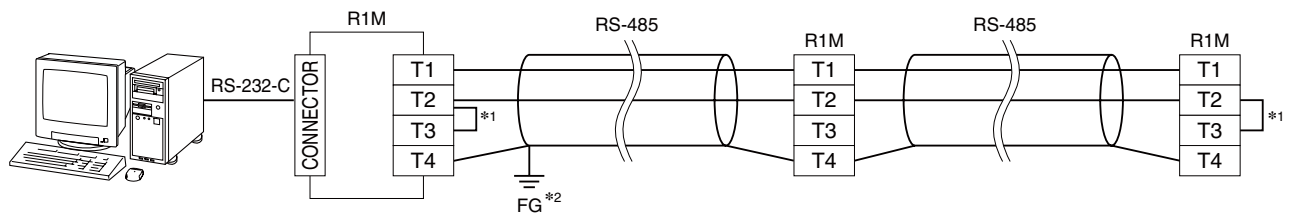

*1. Internal terminating resistor is used when the device is at the end of a transmission line.

*2. Install shielded cables to all sections and ground them at single point.

MODBUS COMMUNICATION

■ COMMUNICATION PARAMETERS

PARAMETER	SPECIFICATION
Data Mode	RTU
Baud Rate	9600 / 19200 / 38400 (*) bps
Parity	None / Odd (*) / Even
Bit Length	8
Stop Bit	1 (*) / 2
Node Address	1 (*) to 15
Floating Point Data	N/A
Interface	RS-232-C / RS-485

■ FUNCTION CODES & SUPPORTED CODES

CODE	NAME		
01	Read Coil Status	X	Digital output from the slave
02	Read Input Status	X	Status of digital inputs to the slave
03	Read Holding Registers	X	General purpose register within the slave
04	Read Input Registers	X	Collected data from the field by the slave
05	Force Single Coil	X	Digital output from the slave
06	Preset Single Registers	X	General purpose register within the slave
07	Read Exception Status		
08	Diagnostics		
09	Program 484		
10	Poll 484		
11	Fetch Comm. Event Counter		Fetch a status word and an event counter
12	Fetch Comm. Event Log		A status word, an event counter, a message count and a field of event bytes
13	Program Controller		
14	Poll Controller		
15	Force Multiple Coils	X	Digital output from the slave
16	Preset Multiple Registers	X	General purpose register within the slave
17	Report Slave ID		Slave type / 'RUN' status
18	Program 884/M84		
19	Reset Comm. Link		
20	Read General Reference		
21	Write General Reference		
22	Mask Write 4X Register		
23	Read/Write 4X Register		
24	Read FIFO Queue		

DATA ADDRESS

	ADDRESS	TYPE				DATA FORMAT	NAME	
		GH2	J3	A1	D1			
Coil (0X)	1 – 32	---	---	---	Y	bit	DO *1	
	33 – 48	Y	---	---	---	bit	Cold junction compensation SW (0: Disable, 1: Enable) *2	
Input Status (1X)	1 – 32	Y	Y	Y	---	bit	DI *3	
	33 – 48	Y	Y	---	---	bit	ADC overrange	
Input Register (3X)	1 – 16	Y	---	---	---	I	AI in % (1 – 8 for Type J3)	
	17 – 48	Y	Y	---	---	F	AI per channel in engineering unit	
	49 – 50	Y	---	---	---	F	Cold junction temperature *2	
	81 – 96	Y	Y	---	---	I	Channel status	
	513	Y	Y	Y	Y	I	Bit	System Status
							0 to 5	Reserved for system use
							6	E ² PROM diagnostics (0: Normal, 1: Error)
							7	ADC error (0: Normal, 1: Error)
	8 to 15	Reserved for system use						
	514 – 521	Y	Y	Y	Y	B16	Model No. ("R1M-x")	
522 – 529	Y	Y	Y	Y	B16	Serial No.		
530 – 537	Y	Y	Y	Y	B16	Hardware version No.		
538 – 545	Y	Y	Y	Y	B16	Firmware version No.		
Holding Register (4X)	1 – 16	---	---	---	---	I	(Reserved for AO in %)	
	17 – 48	---	---	---	---	F	(Reserved for AO in engineering unit)	
	145 – 160	Y	Y	---	---	I	I/O type No.	
	161 – 176	Y	---	---	---	I	Burnout type (161 – 168 for Type J3) (0: No burnout, 1: Upscale, 2: Downscale) *4	

I = 16-bit integer, F = 32-bit floating, B16 = 16-byte character

*1. Discrete output only.

*2. Thermocouple input only.

*3. Trigger contact input for Types GH2 and J3. (Only Address 10001 is enabled.)

*4. Same setting for all channels. For potentiometer inputs, always leave certain residual resistance at 0% side in order to avoid wrong burnout detection. (0% input or shortcircuit across the terminals 1 – 2 =Wire breakdown at the terminal 3)

INPUT DATA

32-bit Floating

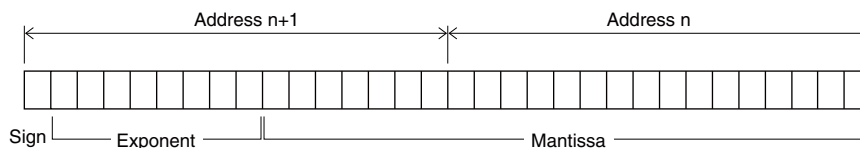

32-bit Integer, No sign (R1M-A1)

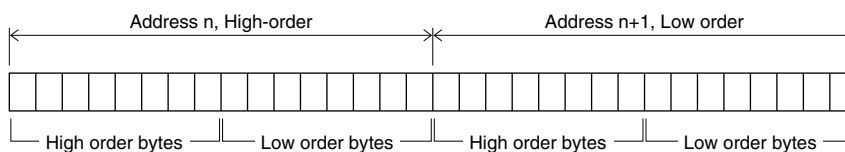

■ INPUT REGISTERS DESCRIPTION

(1) ANALOG INPUT IN % (30001 to 30016; 30001 to 30008 for J3)

Indicates analog input values in percentage for each channel (1 – 16; 1 – 8 for J3).

INPUT TYPE & RANGE		A/D DATA (Decimal)
DC	±20 V	±20000
	±5 V	±5000
	±1 V	±10000
	±0.8 V	±8000
	±0.2 V	±20000
	±50 mV	±5000
	±10 mV	±10000
Thermocouple		Temperature × 10
RTD		Temperature × 10
Potentiometer	0 – 100 Ω	±2000
	0 – 500 Ω	
	0 – 1 kΩ	
	0 – 10 kΩ	

(2) ANALOG INPUT IN ENGINEERING UNIT (30017 to 30048; 30017 to 30032 for J3)

Indicates analog input values in engineering unit for each channel (1 – 16; 1 – 8 for J3). The unit is specific to each input type: °C for temperature, Volts for voltage, and % for potentiometer. The data are 32-bit floating values, which requires two consecutive registers for one module.

(3) CHANNEL STATUS (30081 to 30096)

Indicates the current status of analog inputs (1 – 16; 1 – 8 for J3). The following list shows the names and descriptions of each bit.

BIT	NAME	DESCRIPTION
6	Input Overrange	Indicates the designated analog input is in overrange, defined as one or more of the following condition: <ul style="list-style-type: none"> • ADC input value 0x0000 or 0xFFFF • Burnout status for thermocouple, RTD and Potentiometer input • Out of range defined in the temperature table (thermocouple and RTD) • ADC error 0 : Normal 1 : Overrange
7	ADC Error	Indicates the status of ADC. 0 : Normal 1 : Error
12	Cold Junction Compensation SW	Indicates whether the cold junction compensation is enabled or disabled, for thermocouple input. 0 : Disable 1 : Enable
Others	Reserved	For system's use

INPUT REGISTERS DESCRIPTION

Indicates I/O type for each channel. The data are 16-bit integer values.

MODEL	I/O	I/O TYPE	SELECTION	USABLE RANGE	NOTES
R1MS-GH3 R2M-2G3	DC input	0x00	-10 to +10 V	-10 to +10 V	
R1M-GH2	DC input	0x00	-20 to +20 V	-22.7 to +22.7 V	ATT SW ON
		0x01	-5 to +5 V	-5.6 to +5.6 V	ATT SW ON
		0x02	-1 to +1 V	-1.4 to +1.4 V	ATT SW ON
		0x03	-800 to +800 mV	-860 to +860 mV	
		0x04	-200 to +200 mV	-215 to +215 mV	
		0x05	-50 to +50 mV	-53 to +53 mV	
		0x06	-10 to +10 mV	-13.4 to +13.4 mV	
R1M-GH2 R1MS-GH3 R2M-2H3	T/C input	0x10	(PR)	0 to 1770°C	
		0x11	K (CA)	-270 to +1370°C	
		0x12	E (CRC)	-270 to +1000°C	
		0x13	J (IC)	-210 to +1200°C	
		0x14	T (CC)	-270 to +400°C	
		0x15	B (RH)	100 to 1820°C	
		0x16	R	-50 to +1760°C	
		0x17	S	-50 to +1760°C	
		0x18	C (WRe 5-26)	0 to 2320°C	
		0x19	N	-270 to +1300°C	
		0x1A	U	-200 to +600°C	
		0x1B	L	-200 to +900°C	
		0x1C	P (Platinel II)	0 to 1395°C	
R1M-J3	RTD input	0x30	JPt 100 (JIS '89)	-200 to +500°C	
		0x31	Pt 100 (JIS '89)	-200 to +660°C	
		0x32	Pt 100 (JIS '97, IEC)	-200 to +850°C	
		0x33	Pt 50 Ω (JIS '81)	-200 to +649°C	
		0x34	Ni 508.4 Ω	-50 to +280°C	
		0x35	Pt 1000	-200 to +850°C	
	POT input	0x40	0 to 100 ohms	0 to 100 %	
		0x41	0 to 500 ohms	0 to 100 %	
		0x42	0 to 1 kohms	0 to 100 %	
		0x43	0 to 10 kohms	0 to 100 %	
R1M-D1	DO	0x60			
R1M-A1	DI	0x70			

CHECKING

- 1) Terminal wiring: Check that all cables are correctly connected according to the connection diagram.
- 2) Power input: Check supply voltage.
- 3) Input: Check that the input is within 0 – 100% of full-scale.
- 4) DIP SW setting: Check that all switches are set correctly.

ADJUSTMENT PROCEDURE

This unit is calibrated at the factory to meet the ordered specifications, therefore you usually do not need any calibration.

MAINTENANCE

Regular calibration procedure is explained below:

CALIBRATION

Warm up the unit for at least 10 minutes. Apply 0%, 25%, 50%, 75% and 100% input signal. Check that the output signal for the respective input signal remains within accuracy described in the data sheet. When the output is out of tolerance, please contact M-System's Sales Office or representatives.