

Remote I/O R8 Series

TEMPERATURE CONTROL MODULE

Functions & Features

- Two PID controllers
- Universal input x 2 points, control output x 2 points, clamp-on current sensor input x 2 points
- 2 universal inputs configurable to T/C, RTD, DC current or voltage independently
- Clamp-on current sensor input enables to detect heater wire break or over current
- Auto tuning function
- Configurable with PC configurator (model: R8CFG)
- Mixed installation with other I/O modules

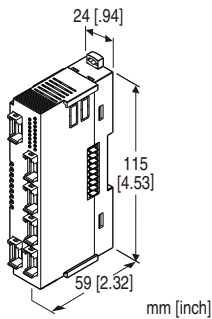

MODEL: R8-TC2[1][2]

ORDERING INFORMATION

- Code number: R8-TC2[1][2]
- Specify a code from below for each [1] and [2].
(e.g. R8-TC2A/Q)
- Specify the specification for option code /Q
(e.g. /C01)

CONTROL LOOP

2: 2 loops

[1] CONTROL OUTPUT

- A: 0 - 20 mA DC (Load resistance 450 Ω max.) 2 points
 V: 0 - 10 V DC (Load resistance 2 kΩ max.) 2 points
 P: 12 V voltage pulse (Load resistance 600 Ω max.) 2 points

[2] OPTIONS

blank: none

/Q: With options (specify the specification)

SPECIFICATIONS OF OPTION: Q

COATING (For the detail, refer to M-System's web site.)

/C01: Silicone coating

/C02: Polyurethane coating

RELATED PRODUCTS

- PC configurator software (model: R8CFG)

A dedicated cable is required to connect the module to the PC. Please refer to the users manual for the PC configurator for applicable cable types.

- Clamp-on current sensor (model: CLSE)
(Used for detecting the heater wire break)

Note: When using with Power/Network module (model: R8-NECT1), firmware version Ver1.30 or later is supported.

GENERAL SPECIFICATIONS

Connection

- I/O: 4-pin e-CON connector

Unit side connector XN2D-1474-S002 (Omron)

Recommended cable side connector XN2A-1470 (Omron)

Applicable wire size: 0.08 - 0.5 mm² (AWG28 - 20)

Outer sheath diameter: max. 1.5 dia

(The cable connector is not included in the package.)

Refer to the specifications of the product.)

- Excitation supply, internal bus:

Connected to internal bus connector

- Internal power: Supplied from internal bus connector

Isolation: Pv1 to Pv2 to Mv1 to Mv2 to exc.supply to CT1 or CT2 or internal bus or internal power

CT Input waveform

RMS sensing: Up to 15 % of 3rd harmonic content

Input Selection: Selectable with the side DIP SW

Cold Junction Compensation: CJC sensor incorporated

Module address: With DIP switch

Terminating resistor: Built-in (DIP Switch, default: disable)

Indicator LEDs: Bi-color (red/green) LED;

Other indicator LEDs: Green LED

Refer to the instruction manual.

Control mode: Standard PID, heating and cooling control PID

Proportional band (P): 0.1 to 3200.0 (temperature unit)

Integral time (I): 0 to 3999 sec.

Derivative time (D): 0.0 to 999.9 sec.

Auto-tuning: Limit cycle method

Sampling cycle: 100 msec.

Control cycle: 1.0 to 99.9 sec.

(100 msec. fixed for Mv output 0 - 20 mA DC

and 0 - 10 V DC)

Mv output range: -5 - +105 % for output scale

Parameters: Stored in non-volatile memory; write/erase cycle endurance: less than 1 000 000

Parameter setting: With PC configurator software (model:

R8CFG)

- Input
- Burnout
- CT input
- Auto-tuning

Refer to the instruction manual for detail.

INPUT SPECIFICATIONS

■ Universal input 1, 2 (Pv1, Pv2)

For input type and range configuration, refer to the instruction manual.

DC Current:

Input range: 0 - 20 mA DC

Input resistance: 49.9 Ω resistor incorporated

- DC voltage input

Input resistance: ≥ 10 k Ω (-1000 to +1000 mV DC)

Input resistance: ≥ 1 M Ω (-10 to +10 V DC)

- Thermocouple

Input resistance: ≥ 10 k Ω

Input range: Refer to the table 1

Burnout sensing: ≤ 4 μ A

Conformance range: Refer to the table 1

- RTD (2-wire or 3-wire)

Excitation: ≤ 0.33 mA

Input range: Refer to the table 1

Allowable leadwire resistance: 20 Ω per wire

- Resistor (2-wire or 3-wire)

Excitation: ≤ 0.33 mA

Input range: 0 - 4000 Ω

Allowable leadwire resistance: 20 Ω per wire

- Potentiometer

Excitation: ≤ 0.33 mA

Input range: Refer to the table 1

Allowable leadwire resistance: 20 Ω per wire

■ Clamp-on current sensor (CT1, CT2)

(Sensor model No.: AC input)

CLSE-R5: 0 - 5 A

CLSE-05: 0 - 50 A

CLSE-10: 0 - 100 A

CLSE-20: 0 - 200 A

CLSE-40: 0 - 400 A

CLSE-60: 0 - 600 A

Frequency: 50 / 60 Hz (45 - 65 Hz)

Operational range: 0 - 120 % of rating

Overload capacity:

CLSE-R5: 10 A continuous

CLSE-05: 60 A continuous

CLSE-10: 120 A continuous

CLSE-20: 240 A continuous

CLSE-40: 480 A continuous

CLSE-60: 720 A continuous

Be sure that the input voltage is of 480 V or less.

OUTPUT SPECIFICATIONS

■ Control Output (Mv1, Mv2)

Specify the type of output with the code number.

- DC Current: 0 - 20 mA DC

Operational range: 0 - 23 mA DC

Load resistance: ≤ 450 Ω

- DC Voltage: 0 - 10 V DC

Operational range: 0 - 11.5 V DC

Load resistance: ≥ 2 k Ω

■ Voltage Pulse

Maximum frequency: 1 Hz

Minimum pulse width: 1 msec.

Hi level: 12 V ± 15 %

Lo level: ≤ 0.5 V

Load resistance: 600 Ω min.

INSTALLATION

Max. current consumption: 200 mA

Exc. supply current consumption: 60 mA

Operating temperature: -10 to +55°C (14 to 131°F)

Operating humidity: 30 to 90 %RH (non-condensing)

Atmosphere: No corrosive gas or heavy dust

Mounting: DIN rail

Weight: 110 g (0.24 lb)

PERFORMANCE in percentage of span

Accuracy

• **Pv1 or Pv2:** Refer to "Input type, range & conversion accuracy" section.

• **CT1 or CT2:** ± 2 % (sensor error margin not included)

• **Mv1 or Mv2:** ± 0.5 %

Data allocation: 2

Module addresses in use: 8

Communication data:

- Loop 1 Pv1
- Loop 1 Sp1
- Loop 1 Mv1
- Loop 1 Proportional band (P1)
- Loop 1 Integral time (I1)
- Loop 1 Derivative time (D1)
- CT input 1 Current value (CT1)
- Loop 2 Pv2
- Loop 2 Sp2
- Loop 2 Mv2
- Loop 2 Proportional band (P2)
- Loop 2 Integral time (I2)
- Loop 2 Derivative time (D2)
- CT input 2 Current value (CT2)

Cold junction compensation error:

$\pm 3^\circ\text{C}$ at -10 - +55°C

$\pm 5.4^\circ\text{F}$ at 14 - 131°F

(The described accuracy may be partially not satisfied when the input temperature is below 0°C. Consult factory.)

Temp. coefficient

- **Pv1 or Pv2:** $\pm 0.03 \text{ } \%/^{\circ}\text{C}$ ($\pm 0.02 \text{ } \%/^{\circ}\text{F}$)
- **CT1 or CT2:** $\pm 0.03 \text{ } \%/^{\circ}\text{C}$ ($\pm 0.02 \text{ } \%/^{\circ}\text{F}$)

Response time

- **CT1 or CT2:** $\leq 2 \text{ sec.}$ (0 - 90 %)
- **Mv1 or Mv2:** $\leq 1 \text{ sec.}$ (0 - 90 %, DC output)

Burnout response time: $\leq 1 \text{ sec.}$

Insulation resistance: $\geq 100 \text{ M}\Omega$ with 500 V DC

Dielectric strength: 1000 V AC @1 minute (Pv1 to Pv2 to Mv1 to Mv2 to exc.supply to CT1 or CT2 or internal bus or internal power to ground)

STANDARDS & APPROVALS

EU conformity:

EMC Directive

EMI EN 61000-6-4

EMS EN 61000-6-2

RoHS Directive

CONTROL MODE

Choose from two control mode shown below with configurator software.

■ Standard PID control

It is available to control two independent loops.

Loop 1: Control by Pv1 and Mv1.

Loop 2: Control by Pv2 and Mv2.

■ Heating and cooling PID control

It is available to control one loop.

Loop 1: Control by Pv1, heating Mv1 and cooling Mv2.

Loop 2 is not available.

INPUT TYPE, RANGE & CONVERSION ACCURACY

[Table 1]

INPUT TYPE	INPUT RANGE		ACCURACY			
DC Current	0 – 20mA DC		±20μA			
DC Voltage	-1000 – +1000mV DC		When maximum range*2 is 60 mV or less: ±20μV When maximum range*2 is 120 mV or less: ±30μV When maximum range*2 exceeds 120 mV: ±200μV			
	-10 – +10V DC		± 200mV			
Potentiometer	0 – 150Ω, 0 – 300Ω, 0 – 600Ω, 0 – 1200Ω, 0 – 2500Ω, 0 – 4000Ω		Larger value of either ±0.1 Ω or ±0.1 %			
Resistor	0 – 4000Ω		Larger value of either ±0.1 Ω or ±0.1 %			
Thermocouple	°C			°F		
	INPUT RANGE	ACCURACY *1	CONFORMANCE RANGE	INPUT RANGE	ACCURACY *1	CONFORMANCE RANGE
(PR)	0 – 1760	±1.80	0 – 1760	32 – 3200	±3.24	32 – 3200
K (CA)	-270 – +1370	±0.40	-150 – +1370	-454 – +2498	±0.72	-238 – +2498
E (CRC)	-270 – +1000	±0.60	-170 – +1000	-454 – +1832	±1.08	-274 – +1832
J (IC)	-210 – +1200	±0.70	-180 – +1200	-346 – +2192	±1.26	-292 – +2192
T (CC)	-270 – +400	±0.50	-170 – +400	-454 – +752	±0.90	-274 – +752
B (RH)	100 – 1820	±2.00	400 – 1760	212 – 3308	±3.60	752 – 3200
R	-50 – +1760	±1.00	200 – 1760	-58 – +3200	±1.80	392 – 3200
S	-50 – +1760	±1.00	0 – 1760	-58 – +3200	±1.80	32 – 3200
C (WRe 5-26)	0 – 2315	±1.00	0 – 2315	32 – 4199	±1.80	32 – 4199
N	-270 – +1300	±0.50	-130 – +1300	-454 – +2372	±0.90	-202 – +2372
U	-200 – +600	±0.50	-200 – +600	-328 – +1112	±0.90	-328 – +1112
L	-200 – +900	±0.30	-200 – +900	-328 – +1652	±0.54	-328 – +1652
P (Platinel II)	0 – 1395	±0.30	0 – 1395	32 – 2543	±0.54	32 – 2543
RTD	°C			°F		
	INPUT RANGE	ACCURACY	INPUT RANGE	ACCURACY	INPUT RANGE	ACCURACY
Pt 100 (JIS '97, IEC)	-200 – +850	±0.40	-328 – +1562	±0.72	-328 – +1562	±0.72
Pt 500	-200 – +850	±0.40	-328 – +1562	±0.72	-328 – +1562	±0.72
Pt 1000	-200 – +850	±0.40	-328 – +1562	±0.72	-328 – +1562	±0.72
Pt 50Ω (JIS '81)	-200 – +649	±0.60	-328 – +1200	±1.08	-328 – +1200	±1.08
JPt 100 (JIS '89)	-200 – +510	±0.40	-328 – +950	±0.72	-328 – +950	±0.72
Ni 508.4 Ω	-50 – +200	±0.60	-58 – +392	±1.08	-58 – +392	±1.08
Cu 10 @25°C	-50 – +250	±2.00	-58 – +482	±3.60	-58 – +482	±3.60

*1. Thermocouple: CJC error margin (3.0 °C, 5.4 °F) added value indicated above.

*2. Maximum range: Absolute value of 0% or 100% of the input range, whichever is greater.

EXTERNAL VIEW

LEFT VIEW

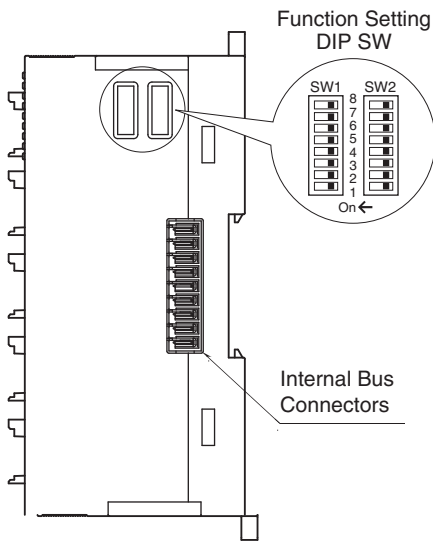

FRONT VIEW

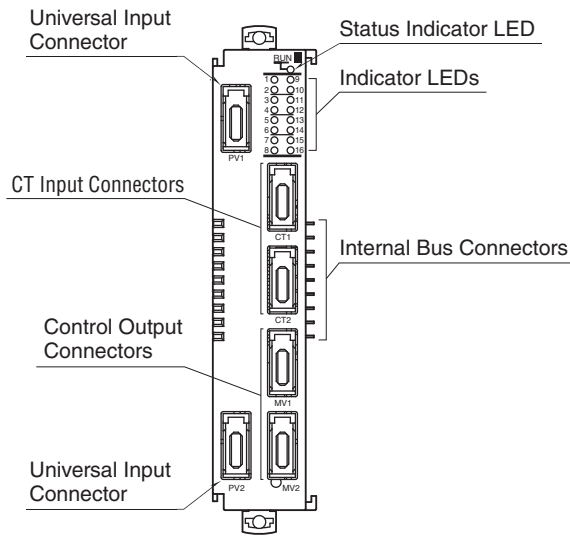

RIGHT VIEW

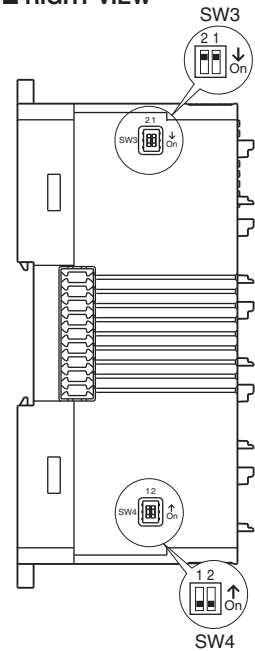

OPERATING MODE SETTING

(*) Factory default

Note: Be sure to set unused SW 2-1 through 2-5, 2-7 and 2-8 to OFF

Module Address

SW 1-1 through 1-4 determine the tenth place digit, while SW 1-5 through 1-8 do the ones place digit of the address. Address is selected between 0 to 24.

(Factory setting: 0)

MODULE ADDRESS	SW1				
	x10 x1	1 5	2 6	3 7	4 8
0		OFF	OFF	OFF	OFF
1		OFF	OFF	OFF	ON
2		OFF	OFF	ON	OFF
3		OFF	OFF	ON	ON
4		OFF	ON	OFF	OFF
5		OFF	ON	OFF	ON
6		OFF	ON	ON	OFF
7		OFF	ON	ON	ON
8		ON	OFF	OFF	OFF
9		ON	OFF	OFF	ON

Terminator DIP SW

TERMINATOR SW	SW2-6
Without (*)	OFF
With	ON

Input Selection

INPUT	UNIVERSAL INPUT1		UNIVERSAL INPUT2	
	SW3		SW4	
	1	2	1	2
DC Current	ON	OFF	ON	OFF
DC Voltage (V)*1	OFF	OFF	OFF	OFF
DC Voltage (mV)*2	OFF	ON	OFF	ON
Potentiometer	OFF	OFF	OFF	OFF
Resistor	OFF	OFF	OFF	OFF
T/C	OFF	ON	OFF	ON
RTD	OFF	OFF	OFF	OFF

*1. Input range: -10 – +10V DC

*2. Input range: -1000 – +1000mV DC

EXTERNAL DIMENSIONS unit: mm [inch]

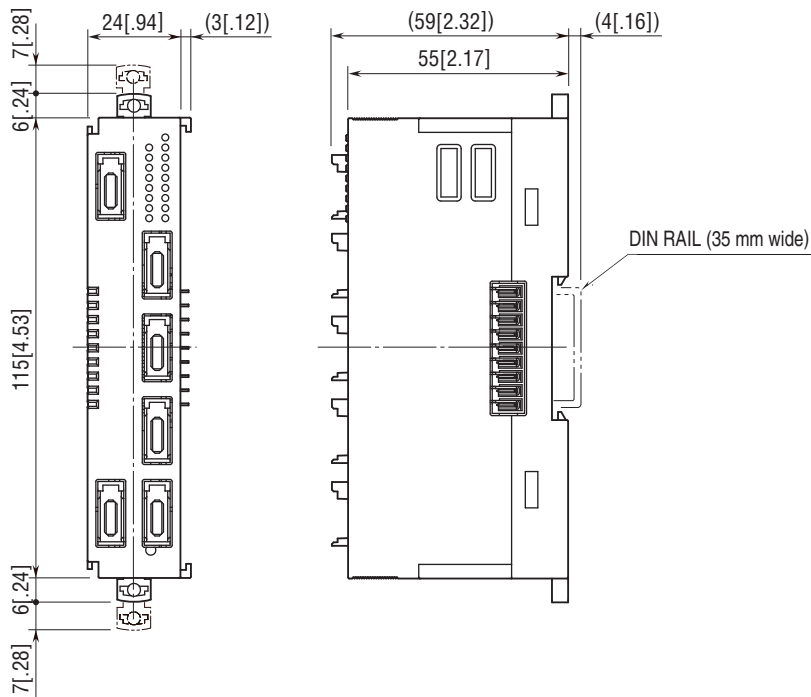

SCHEMATIC CIRCUITRY & CONNECTION DIAGRAM

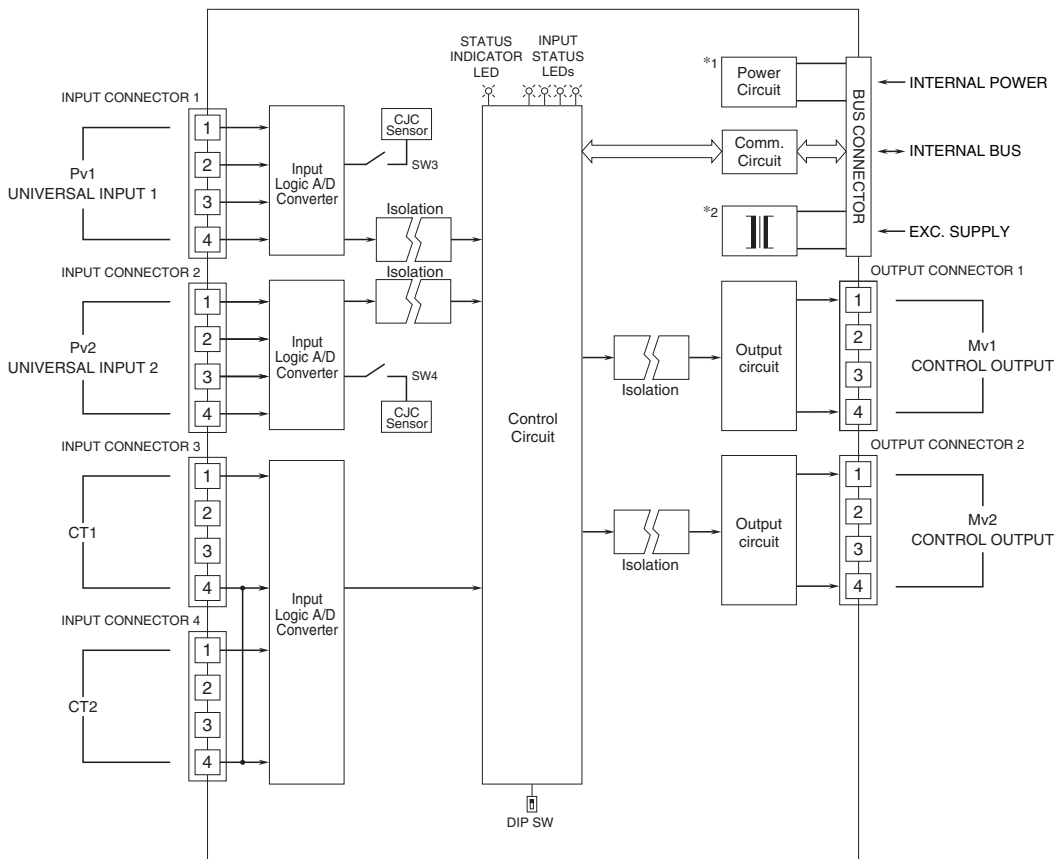

*1. The power supply for control circuit, which is non-isolated from internal power.

*2. The power supply for Mv1 and Mv2, which is isolated from the Exc. supply and the internal power.

■ UNIVERSAL INPUT (Pv1, Pv2) CONNECTION e.g.

•RTD/Resistor (3-wire)

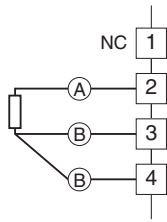

•RTD/Resistor (2-wire)

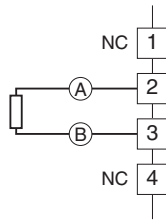

•Thermocouple

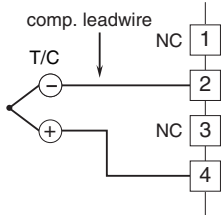

•Potentiometer

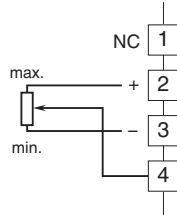

•DC Voltage (-10 – +10V DC)

•DC Current (0 – 20mA DC)

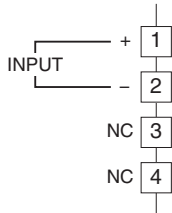

•DC Voltage (-1000 – +1000mV DC)

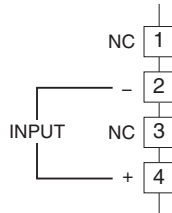

■ CT INPUT (CT1, CT2) CONNECTION e.g.

•Clamp-on current Sensor

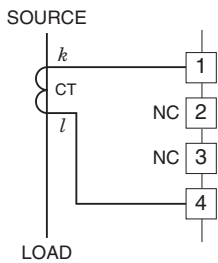

■ CONTROL OUTPUT (Mv1, Mv2) CONNECTION e.g.

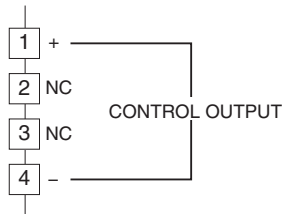

Specifications are subject to change without notice.