

## Remote I/O R7I4D Series

### EtherCAT I/O MODULE

(high-speed DC voltage input, 8 points, non-isolated, e-CON connector)

#### Functions & Features

- 8 points high-speed DC voltage input module for EtherCAT
- Easy parameter setting of individual channels with M-System's configurator software

EtherCAT® is a registered trademark and patented technology, licensed by Beckhoff Automation GmbH, Germany.

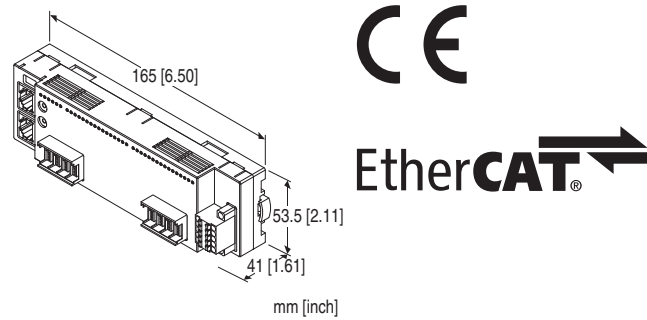

### MODEL: R7I4DECT-1-SVF8N-R[1]

#### ORDERING INFORMATION

- Code number: R7I4DECT-1-SVF8N-R[1]
- Specify a code from below for [1].  
(e.g. R7I4DECT-1-SVF8N-R/Q)
- Specify the specification for option code /Q  
(e.g. /C01/SET)

#### TERMINAL BLOCK

- 1: Tension clamp terminal block for power supply  
RJ-45 Modular jack for communication  
e-CON connector for I/O

#### I/O TYPE

**SVF8N:** DC voltage input, high-speed, 8 points (non-isolated)

#### POWER INPUT

##### DC Power

R: 24 V DC

(Operational voltage range 24 V ±10 %, ripple 10 %p-p max.)

#### [1] OPTIONS

blank: none

/Q: With options (specify the specification)

#### SPECIFICATIONS OF OPTION: Q (multiple selections)

##### COATING (For the detail, refer to M-System's web site.)

/C01: Silicone coating

/C02: Polyurethane coating

/C03: Rubber coating

##### EX-FACTORY SETTING

/SET: Preset according to the Ordering Information Sheet  
(No. ESU-7779-SVF8N)

#### RELATED PRODUCTS

- PC configurator software (model: R7CFG)
- ESI file

The configurator software and ESI files are downloadable at M-System's web site.

Use a commercially available Mini-B USB cable to connect the unit to a PC.

#### GENERAL SPECIFICATIONS

##### Connection

**EtherCAT:** RJ-45 Modular Jack

**Power:** Separable screwless spring terminal

**Input:** e-CON connector

**Housing material:** Flame-resistant resin (gray)

**Isolation:** Input to EtherCAT or FE to power

**Zero adjustments:** Configurable via R7CFG

**Span adjustments:** Configurable via R7CFG

**Input range:** Configurable via R7CFG

**Number of times of averaging:** Configurable via R7CFG

**Status indicator LED:** PWR, RUN, ERR, L/A IN, L/A OUT

(Refer to the instruction manual.)

#### EtherCAT COMMUNICATION

**Standard:** IEEE 802.3u

**Transmission type:** 100BASE-TX

**Transmission speed:** Full-duplex 100 Mbps

**Transmission media:** 100BASE-TX (STP cable; Category 5e)

**Maximum internode length:** 100 meters

**Fixed address:** Set with rotary switches

(The master must support MDP.)

#### INPUT SPECIFICATIONS

**Input resistance:** ≥ 1 MΩ

**Input range:** -10 - +10 V DC, -5 - +5 V DC, 0 - 10 V DC,  
0 - 5 V DC, 1 - 5 V DC

## INSTALLATION

**Current consumption:** Approx. 40 mA (rated current 8 A)  
**Operating temperature:** -10 to +55°C (14 to 131°F)  
**Storage temperature:** -20 to +65°C (-4 to +149°F)  
**Operating humidity:** 30 to 90 %RH (non-condensing)  
**Atmosphere:** No corrosive gas or heavy dust  
**Mounting:** Surface or DIN rail (35 mm rail)  
**Weight:** 170 g (0.37 lb)

## PERFORMANCE

**Conversion accuracy:**  $\pm 0.1\%$   
**Conversion rate:** 2.5 msec. / 8 channels  
**Data range:** 0 - 10000 of the input range  
**Temp. coefficient:**  $\pm 0.015\%/^{\circ}\text{C}$  ( $\pm 0.008\%/^{\circ}\text{F}$ )  
**Input delay time:**  $\leq 10$  msec. (0 - 90 %)  
**Insulation resistance:**  $\geq 100\ \text{M}\Omega$  with 500 V DC  
**Dielectric strength:** 1500 V AC @ 1 minute  
 (input to EtherCAT or FE to power)

## STANDARDS & APPROVALS

### EU conformity:

EMC Directive

EMI EN 61000-6-4

EMS EN 61000-6-2

RoHS Directive

## PC CONFIGURATOR

The following parameters can be set with using PC Configurator Software (model: R7CFG)

Refer to the users manual for the R7CFG for detailed operation of the software program.

### ■ CHANNEL INDIVIDUAL SETTING

PARAMETER	SETTING RANGE	DEFAULT
Unused setting	CH enable, CH disable	CH enable
Input range	-10 to +10 V DC -5 to +5 V DC 0 to 10 V DC 0 to 5 V DC 1 to 5 V DC	-10 to +10 V DC
Bias setting	-320.00 to +320.00 (%)	0.00 (%)
Gain setting	-3.2000 to +3.2000	1.0000
Zero scaling value	-32000 to +32000	0
Full scaling value	-32000 to +32000	10000

### ■ CHANNEL BATCH SETTING

PARAMETER	SETTING RANGE	DEFAULT
No. of moving average	1, 2, 4, 8, 16, 32, 64, 128	1

## EXTERNAL VIEW

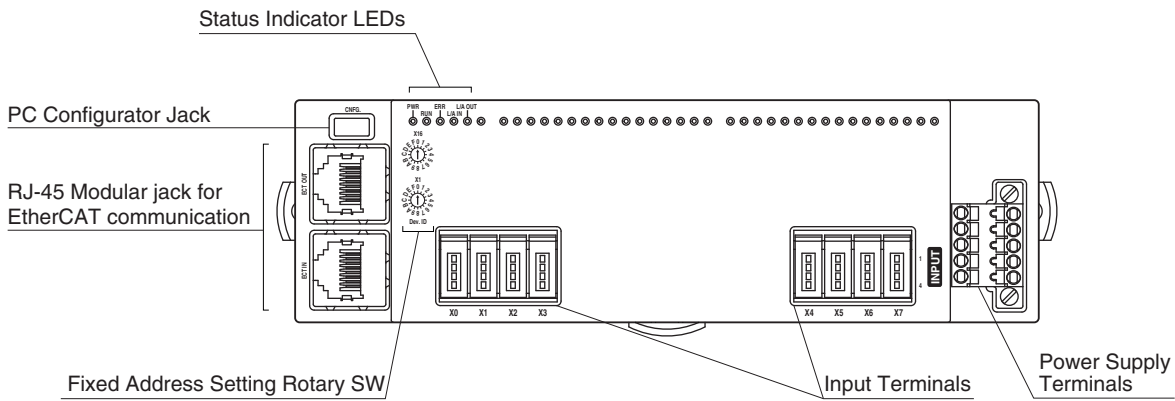

## TERMINAL ASSIGNMENTS

### ■ INPUT TERMINAL ASSIGNMENT

#### • e-CON connector

**Recommended cable connector:** 37104-( )-000FL (3M Company)

(The cable connector is not included in the package.)

Specify wire size instead of ( ); refer to the specifications of the product.)

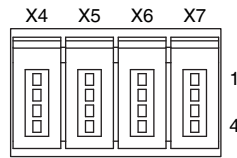
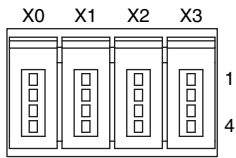

PIN No.	ID	FUNCTION	PIN No.	ID	FUNCTION
X0	1	NC	X4	1	NC
	2	COM		2	COM
	3	NC		3	NC
	4	VH0		4	VH4
X1	1	NC	X5	1	NC
	2	COM		2	COM
	3	NC		3	NC
	4	VH1		4	VH5
X2	1	NC	X6	1	NC
	2	COM		2	COM
	3	NC		3	NC
	4	VH2		4	VH6
X3	1	NC	X7	1	NC
	2	COM		2	COM
	3	NC		3	NC
	4	VH3		4	VH7

## ■ POWER SUPPLY

**Cable connector:** TFMC1,5 / 5-STF-3,5  
(Phoenix Contact) (included in the package)

**Applicable wire size:** 0.2 – 1.5 mm<sup>2</sup>; stripped length 10 mm

### Recommended solderless terminal

- AI0,25–10YE 0.25 mm<sup>2</sup> (Phoenix Contact)
- AI0,34–10TQ 0.34 mm<sup>2</sup> (Phoenix Contact)
- AI0,5–10WH 0.5 mm<sup>2</sup> (Phoenix Contact)
- AI0,75–10GY 0.75 mm<sup>2</sup> (Phoenix Contact)
- A1–10 1.0 mm<sup>2</sup> (Phoenix Contact)
- A1,5–10 1.5 mm<sup>2</sup> (Phoenix Contact)

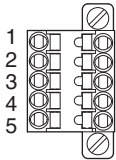

- |         |                  |
|---------|------------------|
| 1. PWR+ | Power Supply     |
| 2. PWR- | Power Supply     |
| 3. FE   | Functional earth |
| 4. NC   | Unused           |
| 5. NC   | Unused           |

Note: The numbers marked on the connector have no relationship to the pin number of the unit.  
Wire according to the instruction manual of the unit.

## RESPONSE TIME

- Input module

Response time is time from when a step (0 to 100%) input signal is applied to the input module (slave) until when output from its communication CPU reaches 90% of the final value.

$T_{COM}$ : EtherCAT communication cycle set by the host device (master)  
(The cycle is determined in accordance with the system configuration and settings.)

$T_{INP}$ : Input module response time  $\leq$  Delay time of input circuit ( $T_a$ ) + Conversion speed<sup>\*1</sup> ( $T_b$ ) + Input internal processing time ( $T_c$ ) (Communication cycle x 2)

\*1. Conversion speed x No. of moving averages (1 to 128)

ex.) When No. of moving averages: 1 and EtherCAT communication cycle: 1 msec.,  
Input module response time ( $T_{INP}$ ): Delay time of input circuit (10 msec.) + Conversion speed (2.5 msec.) x No. of moving averages (1) + Input internal processing time (1 msec. x 2) = 14.5 [msec.]

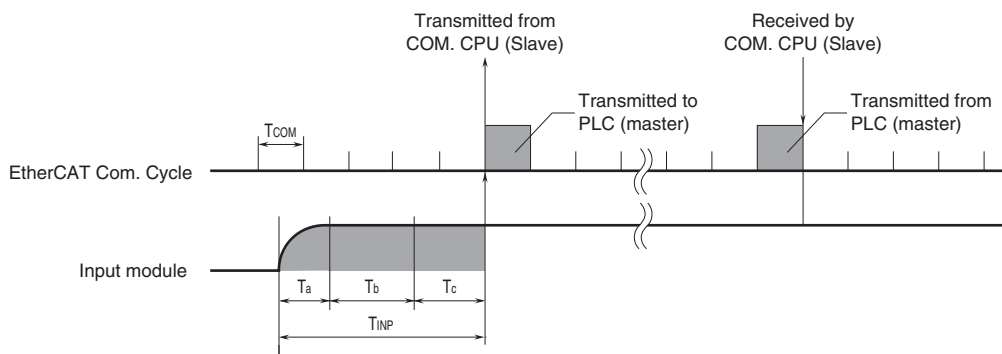

## I/O DATA DESCRIPTIONS

Scaling of analog input module is configurable with the configurator software (model: R7CFG). Refer to the software manual for details.

### ANALOG INPUT MODULE

#### Input Area Objects



16 bit binary data

Negative values are represented by 2's complements.

### STATUS (Input Area Object)

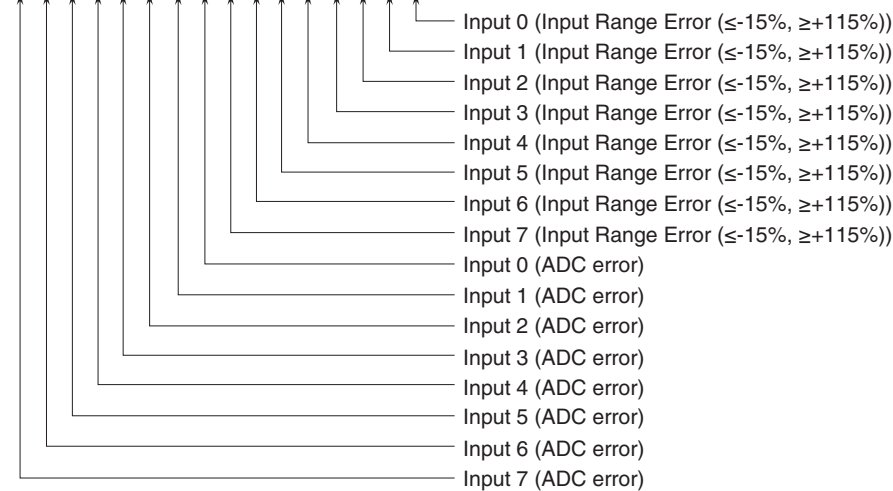

Input Range Error

0 : Normal 1 : Error

ADC error (no response from ADC)

0 : Normal 1 : Error

## EXTERNAL DIMENSIONS unit: mm [inch]

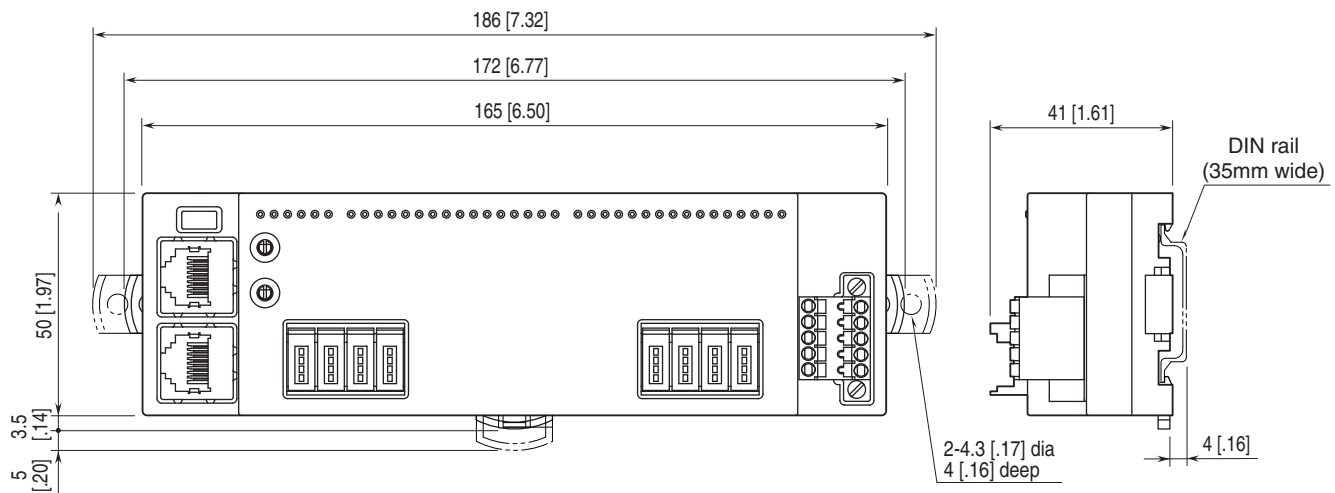

## MOUNTING REQUIREMENTS unit: mm [inch]

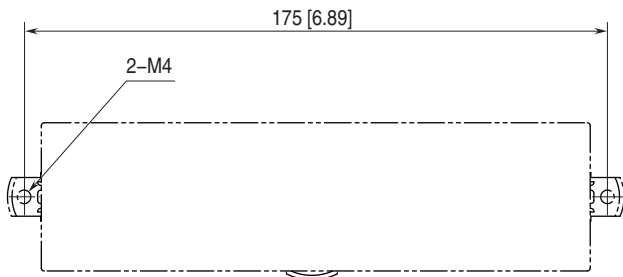

## SCHEMATIC CIRCUITRY & CONNECTION DIAGRAM

Note: In order to improve EMC performance, bond the FE terminal to ground.

Caution: FE terminal is NOT a protective conductor terminal.

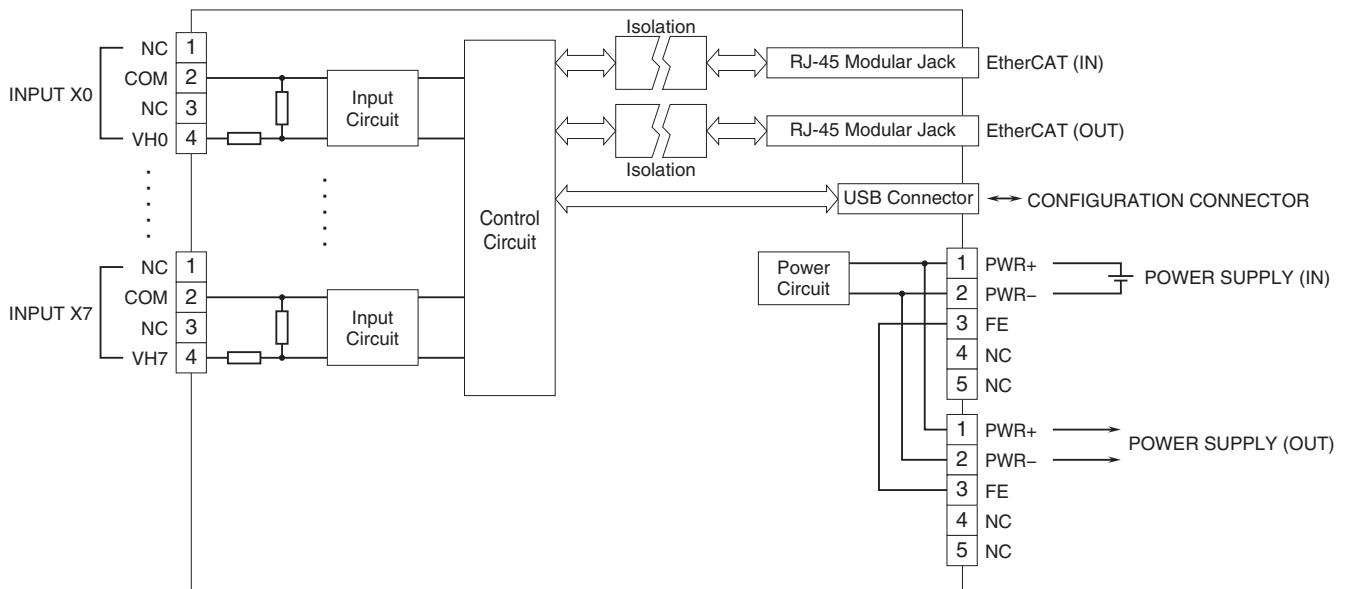

Specifications are subject to change without notice.