

EtherCAT I/O MODULE

(high-speed totalized pulse input, 8 points, e-CON connector)

MODEL R7I4DECT-1-PA8A

BEFORE USE

Thank you for choosing M-System. Before use, please check contents of the package you received as outlined below.

If you have any problems or questions with the product, please contact M-System's Sales Office or representatives.

■ PACKAGE INCLUDES:

High-speed totalized pulse input module(1)
Surface mounter slider(2)

■ MODEL NO.

Confirm Model No. marking on the product to be exactly what you ordered.

■ INSTRUCTION MANUAL

This manual describes necessary points of caution when you use this product, including installation, connection and basic maintenance procedures.

■ ESI FILES

ESI files are downloadable at M-System's website (<http://www.m-system.co.jp/>).

POINTS OF CAUTION

■ CONFORMITY WITH EU DIRECTIVE

- The equipment must be mounted inside the instrument panel of a metal enclosure.
- The actual installation environments such as panel configurations, connected devices, connected wires, may affect the protection level of this unit when it is integrated in a panel system. The user may have to review the CE requirements in regard to the whole system and employ additional protective measures to ensure the CE conformity.

■ POWER INPUT RATING & OPERATIONAL RANGE

- Locate the power input rating marked on the product and confirm its operational range as indicated below:
24V DC rating: 24V \pm 10%, approx. 50mA

■ GENERAL PRECAUTIONS

- Before you remove the unit or mount it, turn off the power supply and input signal for safety.

■ ENVIRONMENT

- Indoor use.
- When heavy dust or metal particles are present in the air, install the unit inside proper housing with sufficient ventilation.
- Do not install the unit where it is subjected to continuous vibration. Do not subject the unit to physical impact.
- Environmental temperature must be within -10 to +55°C (14 to 131°F) with relative humidity within 30 to 90% RH in order to ensure adequate life span and operation.

■ WIRING

- Do not install cables close to noise sources (relay drive cable, high frequency line, etc.).
- Do not bind these cables together with those in which noises are present. Do not install them in the same duct.

■ AND

- The unit is designed to function as soon as power is supplied, however, a warm up for 10 minutes is required for satisfying complete performance described in the data sheet.



EtherCAT® is a registered trademark and patented technology, licensed by Beckhoff Automation GmbH, Germany.

COMPONENT IDENTIFICATION

FRONT VIEW

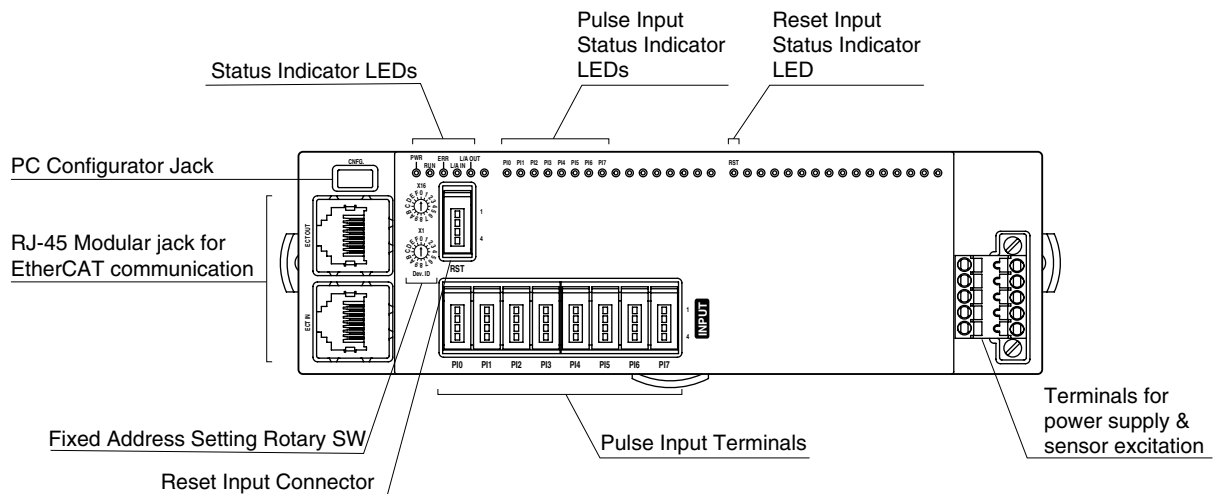

STATUS INDICATOR LED

ID	FUNCTION	COLOR	STATUS	
Power	Internal power	Green	Off	Error
			On	Normal
RUN	Device state	Green	Off	INIT
			Blinking	PRE-OPERATIONAL
			Single Flash	SAFE-OPERATIONAL
			On	OPERATIONAL
ERR	Error	Red	Off	No error
			Blinking	Invalid Configuration
			Single Flash	Local error
			Double Flash	Process data watchdog timeout/ EtherCAT watchdog timeout
			On	Application controller failure
L/A IN	IN port status	Green	Off	No Link
			Flickering	Link and activity
			On	Link without activity
L/A OUT	OUT port status	Green	Off	No Link
			Flickering	Link and activity
			On	Link without activity

Blinking	200ms-On, 200ms-Off
Single flash	200ms-On, 1000ms-Off
Double flash	200ms-On, 200ms-Off, 200ms-On, 1000ms-Off
Flickering	50ms-On, 50ms-Off

FIXED ADDRESS SETTING ROTARY SW (ID selector)

Fixed address 1 to 255 can be set using the two rotary switches each marked 0 to F in combination.

When fixed address is not used, set the switches to 0.

Settable range: 0 to 255

Factory default: 0

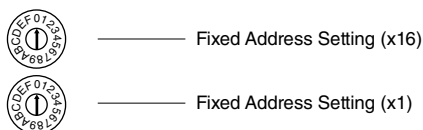

■ POWER SUPPLY AND SENSOR EXCITATION

Cable connector: TFMC1,5 / 5-STF-3,5
(Phoenix Contact) (comes with the unit)

Applicable wire size: 0.2 – 1.5 mm²

Stripped length: 10 mm

Recommended solderless terminal

- AI0,25-10YE 0.25 mm² (Phoenix Contact)
- AI0,34-10TQ 0.34 mm² (Phoenix Contact)
- AI0,5-10WH 0.5 mm² (Phoenix Contact)
- AI0,75-10GY 0.75 mm² (Phoenix Contact)
- A1-10 1.0 mm² (Phoenix Contact)
- A1,5-10 1.5 mm² (Phoenix Contact)

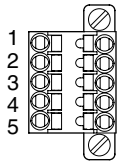

PIN No.	ID	FUNCTION
1	PWR+	Power Supply
2	PWR-	Power Supply
3	FE	Functional earth
4	SNSR.EXC+	Sensor excitation
5	SNSR.EXC-	Sensor excitation

Note: The number marked on the connector is irrelevant to the pin number of the unit.
Perform wiring according to this instruction manual.

■ PULSE INPUT TERMINAL ASSIGNMENTS

• e-CON connector

Recommended cable connector: 37104-()-000FL

(3M Company) (does not come with the unit)

(Specify wire size instead of (); refer to manufacturer's specifications for details.)

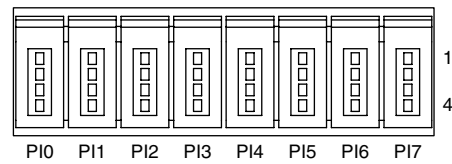

PIN No.	ID	FUNCTION	PIN No.	ID	FUNCTION		
PI0	1	+24V	24V DC	PI4	1	+24V	24V DC
	2	NC	Unused		2	NC	Unused
	3	GND	0V		3	GND	0V
	4	PI0	Pulse Input 0		4	PI4	Pulse Input 4
PI1	1	+24V	24V DC	PI5	1	+24V	24V DC
	2	NC	Unused		2	NC	Unused
	3	GND	0V		3	GND	0V
	4	PI1	Pulse Input 1		4	PI5	Pulse Input 5
PI2	1	+24V	24V DC	PI6	1	+24V	24V DC
	2	NC	Unused		2	NC	Unused
	3	GND	0V		3	GND	0V
	4	PI2	Pulse Input 2		4	PI6	Pulse Input 6
PI3	1	+24V	24V DC	PI7	1	+24V	24V DC
	2	NC	Unused		2	NC	Unused
	3	GND	0V		3	GND	0V
	4	PI3	Pulse Input 3		4	PI7	Pulse Input 7

■ RESET INPUT TERMINAL ASSIGNMENTS

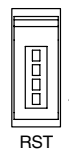

PIN No.	ID	FUNCTION
1	+24V	24V DC
2	NC	Unused
3	GND	0V
4	RST	Reset Input

PC CONFIGURATOR

The following parameter items can be configured with the PC configurator software (model: R7CFG). Refer to the users manual of the software for detailed operations.

■ CHANNEL INDIVIDUAL SETTING

PARAMETER	SETTING RANGE	DEFAULT
Unused channels	Invalid (checked), Valid (unchecked)	Valid
Maximum accumulated pulse count	1 to 4294967295	4294967295
Overflow reset value	0 or 1	0
Preset pulse count	0 to max. accumulated pulse count	0

■ CHANNEL BATCH SETTING

PARAMETER	SETTING RANGE	DEFAULT
Edge direction for counting pulses	Falling edge (DI-ON), Rising edge (DI-OFF)	Falling edge (DI-ON)
Edge direction for resetting pulse count by reset terminal	Falling edge (DI-ON), Rising edge (DI-OFF)	Falling edge (DI-ON)
Enabling or disabling pulse count reset by reset terminal	Enable or Disable	Disable
Enabling or disabling pulse count reset / preset by master	Enable or Disable	Disable

MOUNTING INSTRUCTIONS

■ DIN RAIL MOUNTING (PARALLEL)

• Mounting the unit

- 1) Hook the upper hook at the rear side of the base onto the DIN rail.
- 2) Push the lower part of the unit in the direction of the arrow until the base is firmly fixed to the DIN rail.

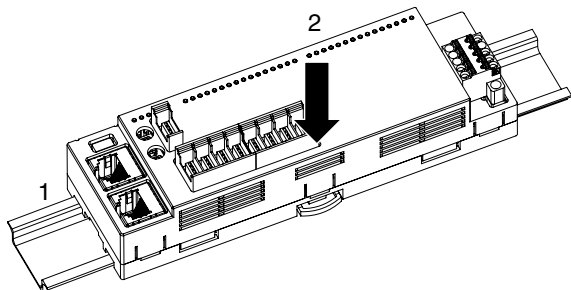

• Removing the unit

- 1) Push down the slider using a minus screwdriver.
- 2) Pull out the lower part of the unit.
- 3) Remove the upper part of the unit from the DIN rail.

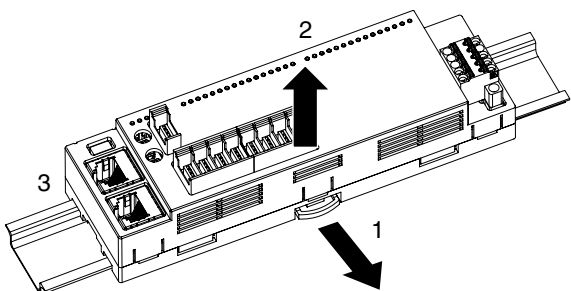

■ WALL MOUNTING

- 1) Insert the two DIN rail mounter sliders until they click once, as shown below.

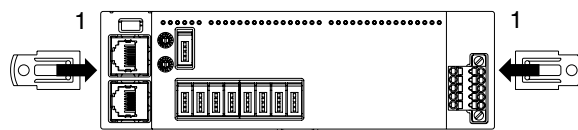

- 2) Mount the unit with M4 screws referring to the "MOUNTING REQUIREMENTS unit: mm (inch)" on page 6. (Torque: 1.4 N·m)

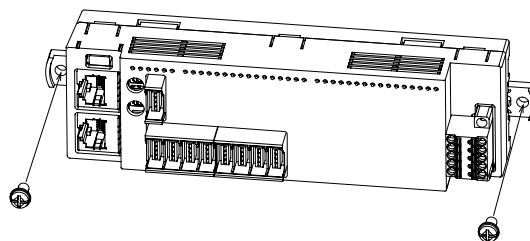

TERMINAL CONNECTIONS

Connect the unit as in the diagram below.

■ EXTERNAL DIMENSIONS unit: mm (inch)

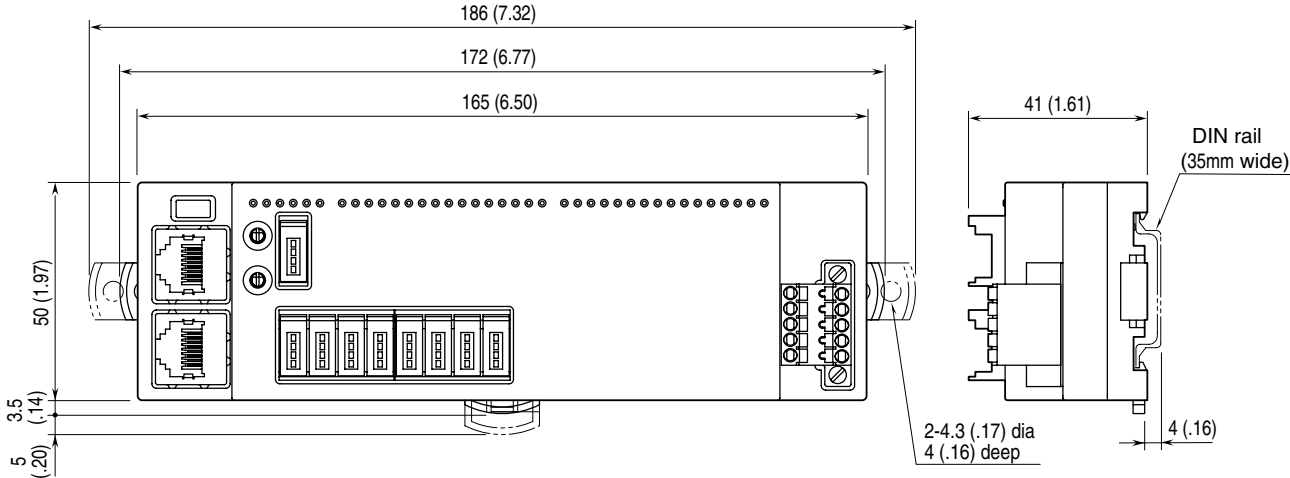

■ CONNECTION DIAGRAM

Note: In order to improve EMC performance, bond the FE terminal to ground.
 Caution: FE terminal is NOT a protective conductor terminal.

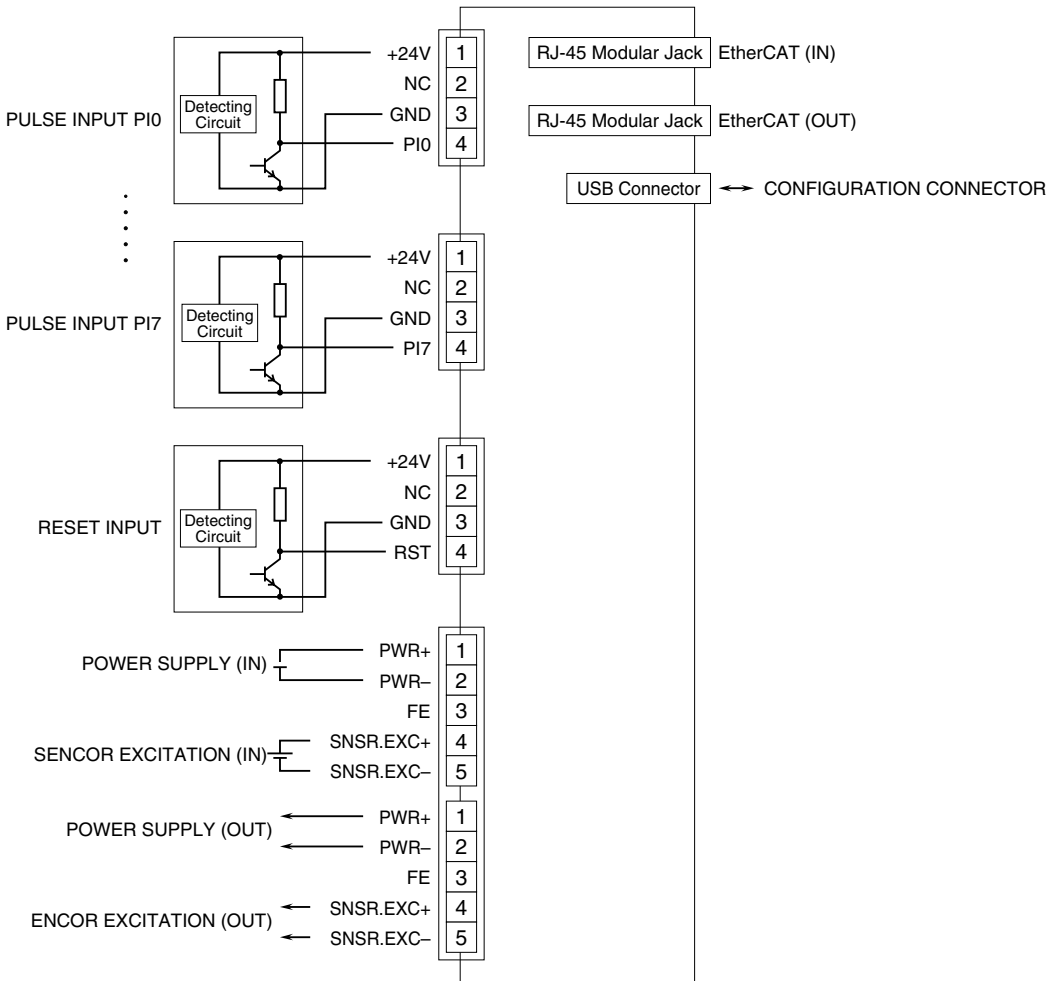

MOUNTING REQUIREMENTS unit: mm (inch)

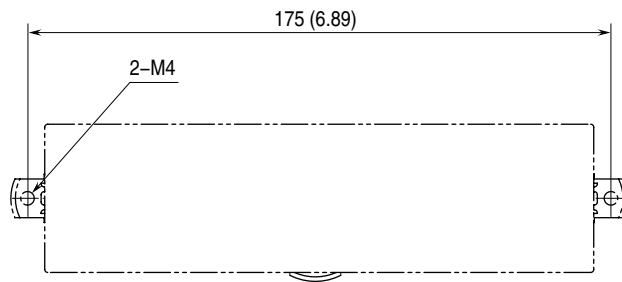

EtherCAT SPECIFICATIONS

■ Modular Device Profile

R7I4DECT-1-PA8A complies with the Modular Device Profile (MDP) standard, ETG.5001.1 of the EtherCAT standard. Be sure that the master supports the MDP standard.

■ Fixed address

R7I4DECT supports Explicit Device Identification by allowing setting of fixed address using the fixed address setting rotary switches (ID selector).

The fixed address can be set to be 1 to 255.

When fixed address is not used, set the ID selector to 0.

When the power is turned on with the ID selector set to other than 0, the designated address is written in the resistor 0x0012 of ESC (EtherCAT Slave Controller) when R7I4DECT starts up.

■ Data Configuration

Data are configured in accordance with the EtherCAT Modular Device Profile (MDP) specifications as shown below.

Table 1: Data Configuration

OBJECT	ADDRESS	CONTENT
Input Area Objects	0x6000	Input data
Output Area Objects	0x7000	Output data
PDO Mapping Objects (TxPDO)	0x1A00	Input data list
PDO Mapping Objects (RxPDO)	0x1600	Output data list
PDO Assign (IN)	0x1C13	Input data transmission order
PDO Assign (OUT)	0x1C12	Output data transmission order
Sync Manager Type	0x1C00	Sync manager type
Sync Manager Parameter Objects	0x1C32, 0x1C33	Sync mode
Device Type	0x1000	Device type
Error Register	0x1001	Error register
Manufacturer Device Name	0x1008	Device name
Manufacturer Hardware Version	0x1009	Hardware version
Manufacturer Software Version	0x100A	Software version
Identity Objects	0x1018	Vendor information

■ EtherCAT State

EtherCAT defines four states of slave: INIT, PREOP, SAFEOP, and OP.

TxPDO (input configuration data) is updated only in the SAFEOP or OP state, and RxPDO (output configuration data) is updated only in the OP state.

The RUN LED turns on only in the OP state and input and output data are updated, while only input data is updated in the PREOP state.

■ EtherCAT Diagnostics

• AL Status Code

When the slave (R7I4DECT) fails to receive a request from the master or when there is a problem with the slave during normal communication, an error code is set to registers 0x0134 and 0x0135 (AL Status Code) of ESC.

The error codes that R7I4DECT uses are as shown below.

Table 2: Error Codes of AL Status Code

CODE	ERROR
0x0000	No error
0x0011	Invalid requested state change
0x0012	Unknown requested state
0x0013	BOOT state not supported
0x0016	Invalid MailBox configuration (PREOP)
0x0017	Invalid SyncManager configuration
0x001B	SyncManager Watchdog Timeout
0x001D	Invalid Output Configuration
0x001E	Invalid Input Configuration
0x001F	Invalid Watchdog Configuration
0x0029	FreeRun needs 3 Buffer mode

• SDO Abort Code

When the master attempts to access the object dictionary via SDO, if the slave (R7I4DECT) fails to receive SDO messages for any reason, R7I4DECT sends an error code (SDO Abort Code) to the master and denies its access.

The following error codes are used.

Table 3: Error Codes of SDO Abort Code

CODE	ERROR
0x05030000	Toggle bit not changed
0x05040001	Client/Server command specifier not valid or unknown
0x05040005	Out of memory
0x06010000	Unsupported access to an object
0x06010002	Attempt to a read-only object
0x06020000	The object does not exist in the object directory
0x06070010	Data type does not match, length of service parameter does not match
0x06090011	Sub-index does not exist
0x08000020	Data cannot be transferred or stored to the application
0x08000022	Data cannot be transferred or stored to the application because of the present device state

OBJECT DICTIONARY (DATA DESCRIPTION)

■ Input Area Objects (Input Data Area: 0x6000, 0x6001)

Input data is allocated to object 0x6000.

Sub-Indexes correspond to channel numbers.

■ Output Area Objects (Output Data Area: 0x7000)

Reset/Preset Command is allocated to object 0x7000.

Table 4: Sub-Index Configuration By Module Type

MODULE TYPE	INDEX	SUB-INDEX	DATA TYPE	BIT	ACCESS	VALUE	CONTENT
Totalized pulse input, 8 points	0x6000	0	UINT8	8	RO	8	Number of items
		1	UINT32	32	RO	0x00000000 to 0xFFFFFFFF	First point input data
		2	UINT32	32	RO	0x00000000 to 0xFFFFFFFF	Second point input data
		:	:	:	:	:	:
		8	UINT32	32	RO	0x00000000 to 0xFFFFFFFF	8th point input data
Reset / Preset Command	0x7000	0	UINT8	8	RO	3	Number of items
		1	UINT16	16	RW	0x0000 to 0xFFFF	Reset request
		2	UINT16	16	RW	0x0000 to 0xFFFF	Preset request
		3	UINT32	32	RW	0x00000000 to 0xFFFFFFFF	Preset value

■ PDO Mapping Objects (Data List: 0x1600, 0x1A00)

• Objects 0x1600, 0x1A00

Output data list (RxPDO) and Input data list (TxPDO) are allocated to 0x1600 and 0x1A00, respectively.

In the data of RxPDO and TxPDO, index, sub-index, and the number of bit of each object which is referred to, are stored.

For input data, each object with the address starting with 0x6000 is referred to.

For output data, each object with the address starting with 0x7000 is referred to.

Table 5: Object Configuration For Output Data List And Input Data List

INDEX	SUB-INDEX	DATA TYPE	BIT	ACCESS	VALUE	CONTENT
0x1600 (RxPDO)	0	UINT8	8	RO	3	Number of items
	1	UINT32	32	RO	0xaaaaabbc	aaaa: Index for referenced object
	2	UINT32	32	RO		bb: Sub-Index for referenced object
	3	UINT32	32	RO		cc: Number of bits for referenced object
0x1A00 (TxPDO)	0	UINT8	8	RO	8	Number of items
	1	UINT32	32	RO	0xaaaaabbc	aaaa: Index for referenced object
	2	UINT32	32	RO		bb: Sub-Index for referenced object
	:	:	:	:		cc: Number of bits for referenced object
	8	UINT32	32	RO		

■ PDO Assign Objects (Data Transmission Order, Output: 0x1C12, Input: 0x1C13)

An allocation list for RxPDO and an allocation list for TxPDO are allocated to 0x1C12 and 0x1C13, respectively.

The indexes stored in 0x1C12 and 0x1C13 are placed in the order they are actually transmitted via PDO.

Table 6: Object Configuration For PDO Allocation Lists

INDEX	SUB-INDEX	DATA TYPE	BIT	ACCESS	VALUE	CONTENT
0x1C12	0	UINT8	8	RO	2	Number of items
	1	UINT16	16	RO	0x1600	Output data
0x1C13	0	UINT8	8	RO	3	Number of items
	1	UINT16	16	RO	0x1A00	Input data

■ Sync Manager Type (0x1C00)

Sync Manager Type is allocated to object 0x1C00 based on the EtherCAT specification.

Table 7: Object Configuration For Sync Manager Type

INDEX	SUB-INDEX	DATA TYPE	BIT	ACCESS	VALUE	CONTENT
0x1C00	0	UINT8	8	RO	4	Number of items
	1	UINT8	8	RO	1	Mailbox Write
	2	UINT8	8	RO	2	Mailbox Read
	3	UINT8	8	RO	3	Process Output Data
	4	UINT8	8	RO	4	Process Input Data

■ Sync Manager Parameter Objects (0x1C32, 0x1C33)

In R7I4DECT, objects 0x1C32 and 0x1C33 do not exist, as the value of Sync Manager Parameter is fixed.

R7I4DECT supports Free Run mode only as the Sync mode.

Note that Distributed Clock (DC) mode is not supported.

■ Device Type (0x1000)

The device type of this unit is allocated to object 0x1000. The device type is 5001.

Table 8: Object Configuration For Device Type

INDEX	DATA TYPE	BIT	ACCESS	VALUE	CONTENT
0x1000	UINT32	32	RO	5001	Device type

■ Error Register (0x1001)

R7I4DECT does not use Object 0x1001.

■ Manufacturer Device Name (0x1008)

The device name is allocated to object 0x1008 in String form.

Table 9: Object Configuration For Device Name

INDEX	DATA TYPE	BIT	ACCESS	VALUE	CONTENT
0x1008	STRING	32	RO	R7I4DECT-1-PA8A	Model number

■ Manufacturer Hardware Version (0x1009)

The hardware device version of this unit is allocated to object 0x1009 in String form.

The format of version is “n.nn.”

Table 10: Object Configuration For Hardware Version

INDEX	DATA TYPE	BIT	ACCESS	VALUE	CONTENT
0x1009	STRING	32	RO	n.nn	Hardware version

■ Manufacturer Software Version (0x100A)

The software version of this unit is allocated to object 0x100A in String form.

The format of version is “n.nn.”

Table 11: Object Configuration For Software Version

INDEX	DATA TYPE	BIT	ACCESS	VALUE	CONTENT
0x100A	STRING	32	RO	n.nn	Software version

■ Identity Object (Vendor information: 0x1018)

Vendor information is allocated to object 0x1018.

While the vendor ID and product code are fixed, the revision number is incremented by one at each major version up of the software.

A unique serial number is allocated to each product.

A serial number consists of 8 digits, starting with two alpha-numeral characters followed by six numeral characters.

The serial number is expressed as 32-bit data divided into 6-bit, 6-bit, and 20-bit groups, with the first two characters converted into 6-bit values.

6 BITS	6 BITS	20 BITS
1st digit	2nd digit	3rd to 8th digits (000000 to 999999)



CHARACTER	VALUE
0	0
1	1
:	:
9	9
A	10
B	11
:	:
Z	35

Table 12: Object Configuration For Vendor Information

INDEX	SUB-INDEX	DATA TYPE	BIT	ACCESS	VALUE	CONTENT
0x1018	0	UINT8	8	RO	4	Number of items
	1	UINT32	32	RO	0x0000060C	Vendor ID
	2	UINT32	32	RO	0x52370083	Product code
	3	UINT32	32	RO	n	Revision number
	4	UINT32	32	RO	0 to n	Serial number

I/O DATA DESCRIPTIONS

• Input Area Objects

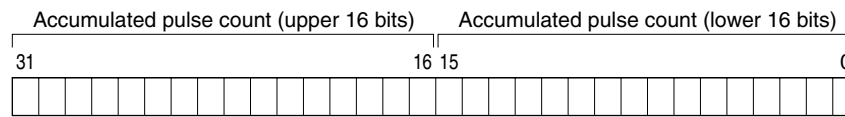

32-bit binary data

When the channel is invalid, the pulse count is fixed to 0.

• Output Area Objects

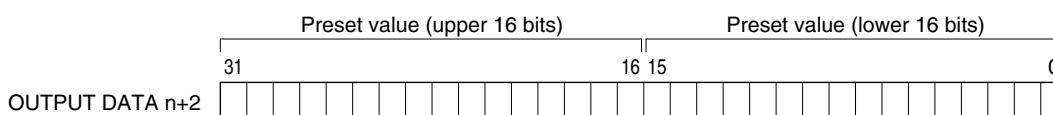
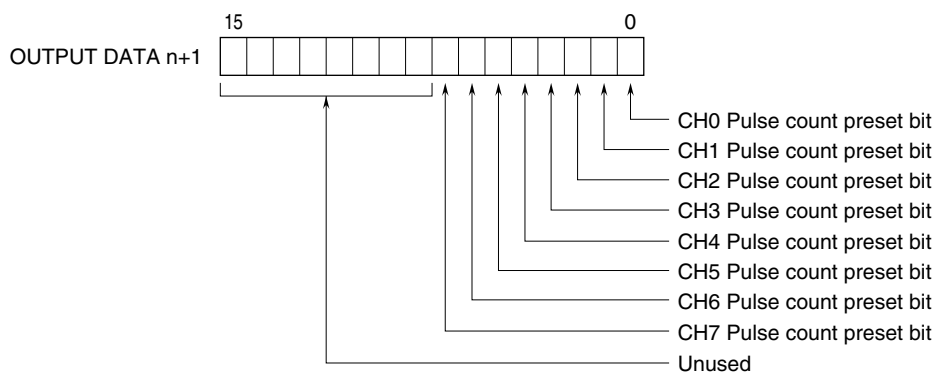
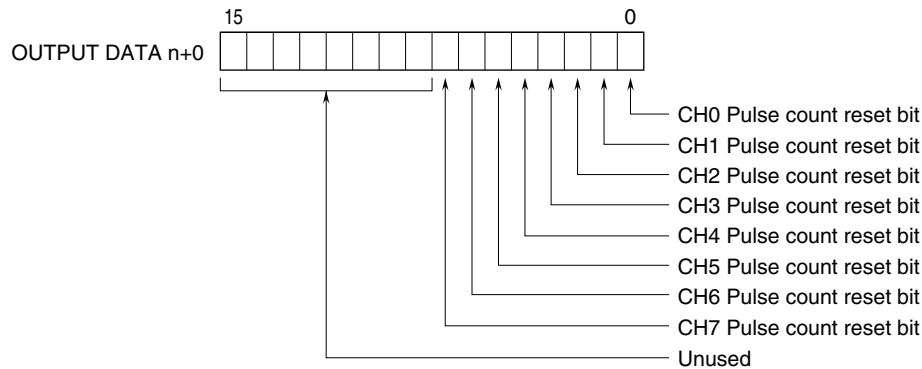

■ PULSE COUNT RESET

In $n+0$ word of the output data from host PC/PLC, the bits to reset the totalized values of the respective channels are allocated. By changing the bits from 0 to 1, the totalized values of the respective channels are reset.

Confirm that the totalized values are reset, and return the bits to 0.

Note that the next reset will not work if the reset bits remain at 1.

■ PULSE COUNT PRESET

Write the desired preset values in $n+2$ word and $n+3$ word of the output data from host PC/PLC.

The bits to preset the totalized values of the respective channels are allocated in $n+1$ word.

By changing the bits from 0 to 1, the preset values are reflected to the totalized values of the respective channels.

Confirm that the totalized values are preset, and return the bits to 0.

Note that the next preset will not work if the preset bits remain at 1.