

**DISCRETE INPUT TOWER LIGHT**  
(super-small size, 50 mm dia., 1 - 5 layers, pole mounting)

MODEL **IT50SA3**

**BEFORE USE ....**

Thank you for choosing M-System. Before use, check the contents of the package you received as outlined below.

If you have any problems or questions with the product, please contact M-System's Sales Office or representatives.

This product is for use in general industrial environments, therefore may not be suitable for applications which require higher level of safety (e.g. safety or accident prevention systems) or of reliability (e.g. vehicle control or combustion control systems).

For safety, installation and maintenance of this product must be conducted by qualified personnel.

**■ PACKAGE INCLUDES:**

- Tower Light .....(1)
- Mounting fixtures\*
  - M5 screw .....(4)
  - Plain washer .....(4)
  - Spring washer.....(4)
  - Nut .....(4)

\* Provided only for the circular base mount type.

**■ MODEL NO.**

Confirm Model No. marking on the product to be exactly what you ordered.

**■ INSTRUCTION MANUAL**

This manual describes necessary points of caution when you use this product, including installation, connection and basic maintenance procedures.

**POINTS OF CAUTION**

**■ CONFORMITY WITH EU DIRECTIVES**

- Altitude up to 2000 meters.
- The actual installation environments such as panel configurations, connected devices, connected wires, may affect the protection level of this unit when it is integrated in a panel system. The user may have to review the CE requirements in regard to the whole system and employ additional protective measures to ensure the CE conformity.
- The equipment is intended to be installed in an industrial environment defined by EN 60947-5-1.

**■ POWER INPUT RATING & OPERATIONAL RANGE**

- Locate the power input rating marked on the product and confirm its operational range as indicated below:
  - 24 V AC rating: 24 V ±10%, 47 – 66 Hz, ≤ 2.4 VA
  - 24 V DC rating: 24 V ±10%, ≤ 2.2 W
- Supplying any level of power other than specified above can damage the unit or the power source.
- Power up characteristics of a power supply for the unit must be such a way that the output voltage goes up within operational voltage range of the unit in 5 seconds.

**■ GENERAL PRECAUTIONS**

- Before you remove the unit or mount it, turn off the power supply and input signal for safety.
- The unit must not be subjected to external force.
- Do not rub the unit with organic solvent like paint thinner.
- Do not block the unit's ventilation openings or use it in areas where heat accumulates. Additionally, do not store or use it under high-temperature conditions.
- Do not use the unit in an environment where flammable gases are present. This may result in an explosion.
- Do not disassemble or modify the unit in any way. Doing so may result in a fire or an electrical shock.
- Do not store or use the unit in locations subject to direct sunlight, or where excessive dust or dirt is present.
- The unit is a precision equipment. Do not store or use it where large shocks or excessive vibration can occur.
- Observe the environmental conditions when using the unit.

**■ ENVIRONMENT**

- Indoor use.
- Do not install the unit where it is subjected to continuous vibration. Do not subject the unit to physical impact.
- Environmental temperature must be within -10 to +55°C (14 to 131°F) with relative humidity within 30 to 90% RH in order to ensure adequate life span and operation.
- Mount the unit on a foundation of sufficient strength.
- Recommended bolt/nut tightening torque:
  - M3: 0.3 – 0.4 N·m
  - M5: 1.4 – 1.6 N·m
  - M8: 6.1 – 6.3 N·m
  - M17: 24 – 26 N·m
- L-shaped bracket
  - The L-shaped bracket is only loosely fit. Tighten its M17 nut securely when the position is determined.

**■ INGRESS PROTECTION**

Circular base mount type

- Degree of protection: IP65
- The IP code is conformable when the unit is mounted vertically. The bottom of the pole is not protected.
- In order to prevent ingress of water or dust through the bottom of the pole, mount the unit on a flat plane, and be sure that the gasket on the bottom of the pole does not roll back or dust is not on the gasket.

L-shaped mount type

- Degree of protection: IP13
- The IP code is conformable when the unit is mounted vertically.

**■ WIRING**

- Do not install cables close to noise sources (relay drive cable, high frequency line, etc.).
- Do not bind these cables together with those in which noises are present. Do not install them in the same duct.

## COMPONENT IDENTIFICATION

### ■ CIRCULAR BASE MOUNT TYPE

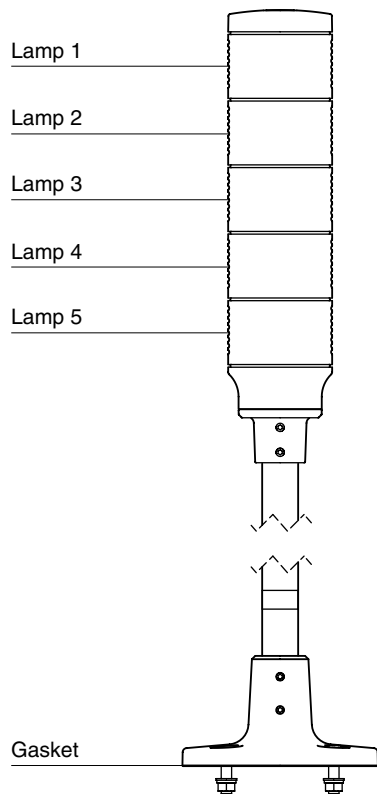

### ■ L-SHAPED MOUNT TYPE

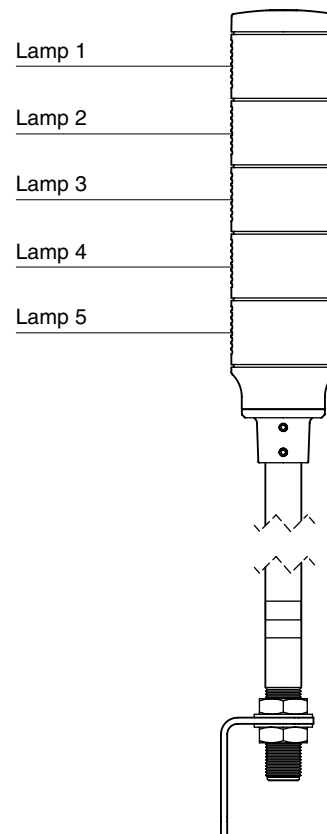

## TERMINAL CONNECTIONS

Connect the unit as in the diagram below.

### EXTERNAL DIMENSIONS unit: mm

#### CIRCULAR BASE MOUNT TYPE

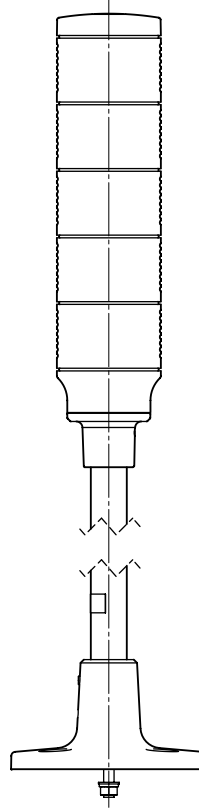
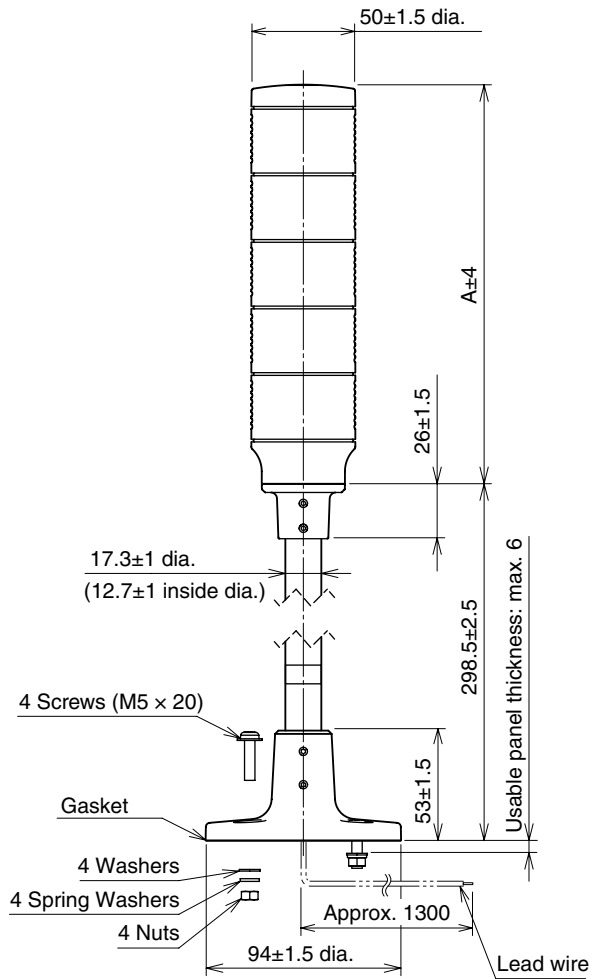

Lamp Layers	A
1	64
2	96
3	128
4	160
5	192

■ L-SHAPED MOUNT TYPE

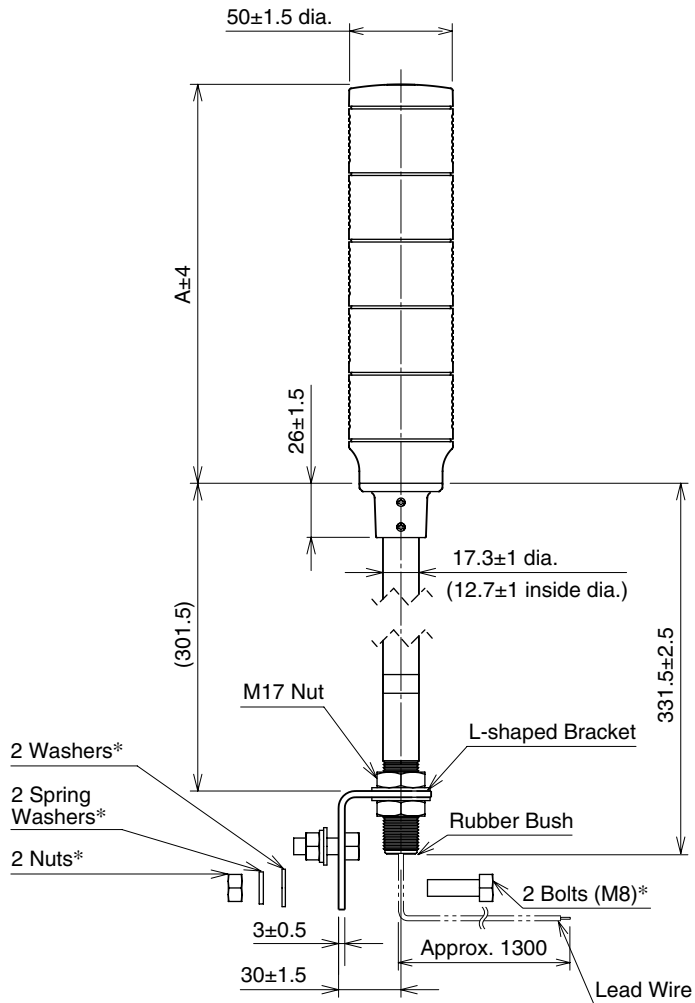

Lamp Layers	A
1	64
2	96
3	128
4	160
5	192

\* Not included with product package.

■ MOUNTING REQUIREMENTS unit: mm (inch)

■ CIRCULAR BASE MOUNT TYPE

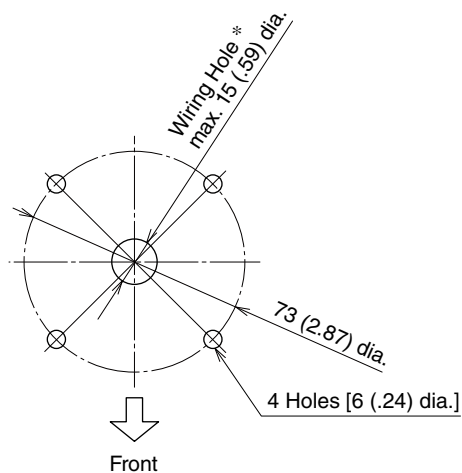

■ L-SHAPED MOUNT TYPE

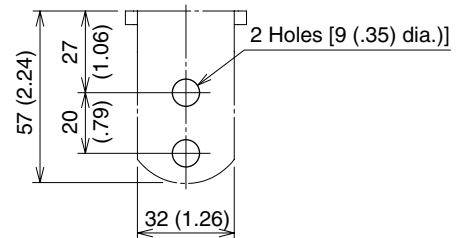

\* Protect wires to prevent scratching them on edges.  
Determine the hole diameter according to the size of the wires and connectors.

■ CONNECTION DIAGRAM

INPUT	LAMP 1 INPUT	Red	LAMP1*1
	LAMP 2 INPUT	Amber	LAMP2*1
	LAMP 3 INPUT	Green	LAMP3*1
	LAMP 4 INPUT	Blue	LAMP4*1
	LAMP 5 INPUT	White	LAMP5*1
	POWER	Orange	POW

\*1. Example of 5 layers in order: red, amber, green, blue and white.  
Lamp and wire colors are the same.

■ WIRING TO INPUT SIGNAL

• Contact input e.g.

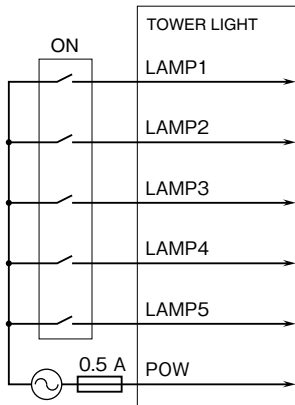

• NPN input e.g.

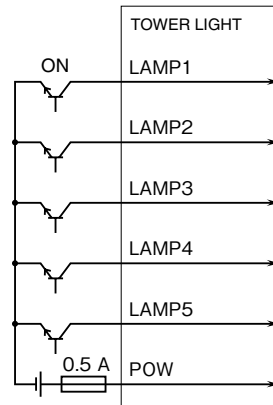

• PNP input e.g.

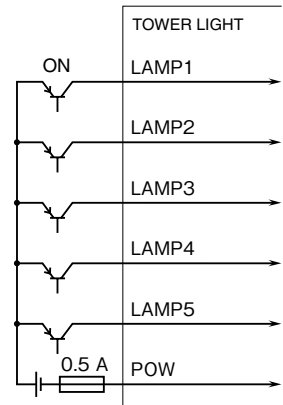

Note 1: NPN input and PNP input are available only for 24 V DC.