

<p>PULSE ISOLATOR (with sensor excitation, CE)</p>	<p>MODEL M8PP1</p>
---	---------------------------

BEFORE USE

Thank you for choosing us. Before use, please check contents of the package you received as outlined below. If you have any problems or questions with the product, please contact our sales office or representatives.

■ PACKAGE INCLUDES:

Signal conditioner(1)

■ MODEL NO.

Confirm Model No. marking on the product to be exactly what you ordered.

■ INSTRUCTION MANUAL

This manual describes necessary points of caution when you use this product, including installation, connection and basic maintenance procedures.

POINTS OF CAUTION

■ CONFORMITY WITH EU DIRECTIVES

- Operational insulation is maintained between the input and output. The input voltage across the terminals must be 70V or less in order to conform to the CE marking.
- The equipment must be mounted inside a panel.
- The actual installation environments such as panel configurations, connected devices, connected wires, may affect the protection level of this unit when it is integrated in a panel system. The user may have to review the CE requirements in regard to the whole system and employ additional protective measures* to ensure the CE conformity.
- * For example, installation of noise filters and clamp filters for the power source, input and output connected to the unit, etc.
- Install lightning surge protectors for those wires connected to remote locations.

■ POWER INPUT RATING & OPERATIONAL RANGE

- Locate the power input rating marked on the product and confirm its operational range as indicated below:
24V DC rating: 24V ±10%, approx. 90mA

■ GENERAL PRECAUTIONS

- Before you remove the unit or mount it, turn off the power supply and input signal for safety.

■ ENVIRONMENT

- Indoor use.
- When heavy dust or metal particles are present in the air, install the unit inside proper housing with sufficient ventilation.
- Do not install the unit where it is subjected to continuous vibration. Do not subject the unit to physical impact.
- Environmental temperature must be within 0 to 55°C (32 to 131°F) with relative humidity within 30 to 95% RH in order to ensure adequate life span and operation.
- Be sure that the ventilation slits are not covered with cables, etc.

■ WIRING

- Do not install cables close to noise sources (relay drive cable, high frequency line, etc.).
- Do not bind these cables together with those in which noises are present. Do not install them in the same duct.

■ AND

- The unit is designed to function as soon as power is supplied, however, a warm up for 10 minutes is required for satisfying complete performance described in the data sheet.

COMPONENT IDENTIFICATION

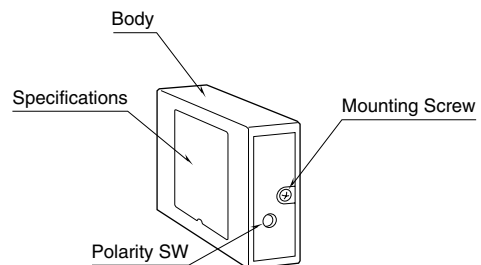

INSTALLATION

Use Installation Base (model: M8BSx).

TERMINAL CONNECTIONS

Connect the unit as in the diagrams below.

EXTERNAL DIMENSIONS unit: mm (inch)

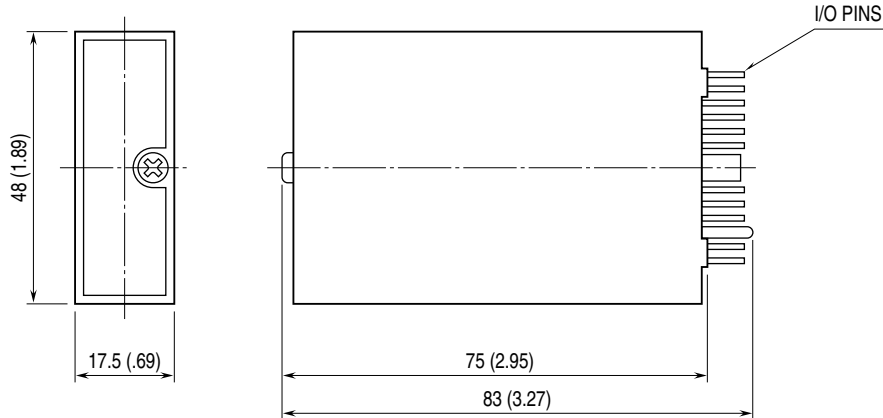

CONNECTION DIAGRAM

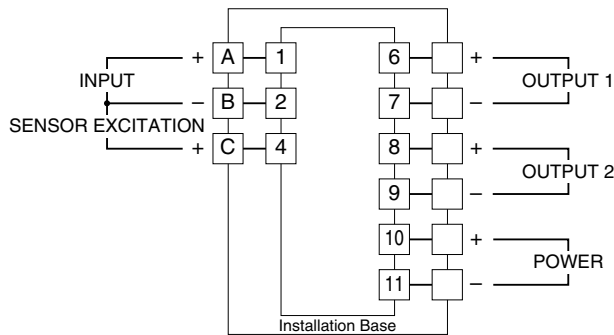

Input Connection Examples

■ Dry Contact

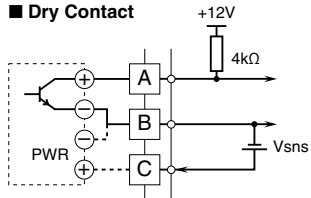

■ 2-Wire Current Pulse •Built-in Excitation

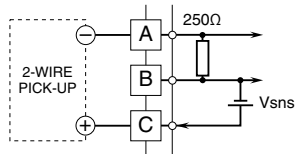

■ DC Voltage Pulse

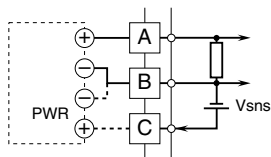

■ External DC Supply

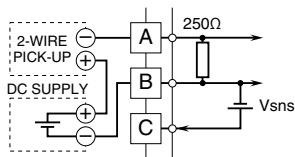

■ AC Voltage Pulse

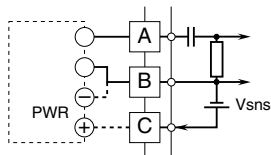

Output Connection Examples

■ Open Collector

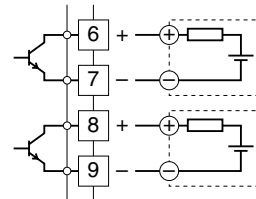

■ Voltage Pulse

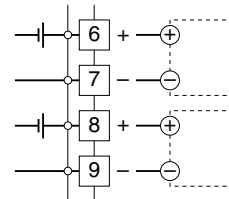

SENSOR EXCITATION

With the sensor excitation shortcircuited or exceeding 30 mA, the module stops feeding the power for protecting itself from overheating.

In order to recover feeding, disconnect the sensor and reconnect it after removing whatever caused the overload.

CHECKING

- 1) Terminal wiring: Check that all cables are correctly connected according to the connection diagram.
- 2) Power input: Check the power input voltage.
- 3) Input: Check that the input frequency is 50 kHz or less for AC voltage pulse, 100 kHz or less for other types of input; each the same or less than the maximum output frequency.
Check also that the input pulse is of 2 μ sec. or wider (except for AC voltage pulse) for over 10 Hz, of 10 msec. or wider for 0 – 10 Hz.
- 4) Output: Check that the load resistance meets the described specifications as below.

OUTPUT	LOAD REQUIREMENTS
Open collector 5 V voltage pulse	50 V DC @ 50 mA max. 1 k Ω minimum

- 5) Polarity SW: Push in the switch to invert the output logic. Push back for non-inverted output.

LIGHTNING SURGE PROTECTION

We offer a series of lightning surge protector for protection against induced lightning surges. Please contact us to choose appropriate models.