

Super-mini Signal Conditioners Mini-M Series

PULSE ISOLATOR

Functions & Features

- Galvanically isolates pulse rate signals
- Input frequency = output frequency
- Various outputs (open collector, voltage pulses and dry contact AC/DC switch)

Typical Applications

- Isolating field pulse signals in order to reduce noises
- Changing e.g. dry contact signal to e.g. 5 V signals

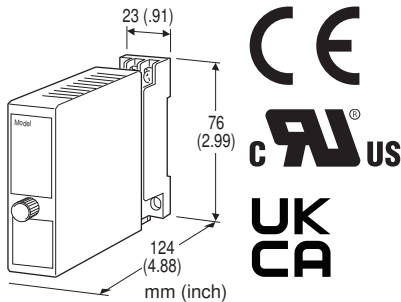

MODEL: M2PP-[1][2][3]-[4][5]

ORDERING INFORMATION

- Code number: M2PP-[1][2][3]-[4][5]
- Specify a code from below for each of [1] through [5].
(e.g. M2PP-33N-M2/CE/Q)
- Specify the specification for option code /Q
(e.g. /C01/S01)

[1] INPUT

- 1: Mechanical contact (max. 30 Hz)
- 2: Open collector (max. 10 kHz)
- 3: Voltage pulse (max. 10 kHz)
- 9: Clamp-on pulse sensor CLSP
(‘/UL’ is not selectable for ‘Standards & Approvals’ code.)

[2] OUTPUT

- 1: Low frequency open collector (max. 30 Hz)
- 2: High frequency open collector (max. 10 kHz)
- 3: 5 V pulse (max. 10 kHz)
- 4: 12 V pulse (max. 10 kHz)
- 5: 24 V pulse (max. 10 kHz)
- 7: Dry contact AC/DC switch (max. frequency 30 Hz)
(‘/UL’ is not selectable for ‘Standards & Approvals’ code.)

[3] OUTPUT LOGIC

- N: The same as the input
- R: Inverted

[4] POWER INPUT

AC Power

M: 85 – 264 V AC (Operational voltage range 85 – 264 V, 47 – 66 Hz)

(Select ‘/N’ for ‘Standards & Approvals’ code.)

M2: 100 – 240 V AC (Operational voltage range 85 – 264 V, 47 – 66 Hz)

(‘/UL’ is not selectable for ‘Standards & Approvals’ code.)

DC Power

R: 24 V DC

(Operational voltage range 24 V ±10 %, ripple 10 %p-p max.)

R2: 11 – 27 V DC

(Operational voltage range 11 – 27 V, ripple 10 %p-p max.)

(Select ‘/N’ for ‘Standards & Approvals’ code.)

P: 110 V DC

(Operational voltage range 85 – 150 V, ripple 10 %p-p max.)

(‘/UL’ is not selectable for ‘Standards & Approvals’ code.)

[5] OPTIONS (multiple selections)

Standards & Approvals (must be specified)

/N: Without CE, UKCA or UL

/CE: CE marking

/UK: CE, UKCA marking

/UL: UL approval, CE marking

Other Options

blank: none

/Q: Option other than the above (specify the specification)

SPECIFICATIONS OF OPTION: Q (multiple selections)

COATING (For the detail, refer to M-System's web site.)

/C01: Silicone coating

/C02: Polyurethane coating

/C03: Rubber coating (UL not available)

/C04: Polyolefin coating (UL not available)

TERMINAL SCREW MATERIAL

/S01: Stainless steel (UL not available)

RELATED PRODUCTS

- Clamp-on pulse sensor (model: CLSP)

GENERAL SPECIFICATIONS

Construction: Plug-in
Connection: M3 screw terminals (torque 0.8 N·m)
Screw terminal: Chromated steel (standard) or stainless steel
Housing material: Flame-resistant resin (black)
Isolation: Input to output to power
Frequency range: Input and output are the same.
Chattering protection: Filter provided for mechanical contact input
Input pulse sensing: DC coupled

INPUT SPECIFICATIONS

Excitation: 12 V DC @30 mA; shortcircuit protection

■ **Open Collector**
Maximum frequency: 10 kHz
Pulse width time requirement: 10 µsec. min. for ON and OFF
Sensing: Approx. 12 V DC @3 mA
ON/OFF level: ≤ 600 Ω / 1.8 V for ON, ≥ 100 kΩ / 3.5 V for OFF

■ **Mechanical Contact**
Maximum frequency: 30 Hz
Pulse width time requirement: 10 msec. min. for ON and OFF
Sensing: Approx. 12 V DC @3 mA
ON/OFF level: ≤ 200 Ω / 0.6 V for ON, ≥ 100 kΩ / 2.5 V for OFF

■ **Voltage Pulse**
Maximum frequency: 10 kHz
Pulse width time requirement: 10 µsec. min. for high and low levels
Waveforms: Square or sine
Hi/Lo level: 2 - 50 V for high level; ≤1 V for low level
Input impedance: 10 kΩ min.

■ **Clamp-on Pulse Sensor CLSP**
Maximum frequency: 50 000 pulses/hour
ON/OFF level: ≤ 400 Ω / 1.3 V for ON, ≥ 200 kΩ / 12 V for OFF

OUTPUT SPECIFICATIONS

■ **Low Frequency Open Collector:**
50 V DC @100 mA (resistive load)
Maximum frequency: 30 Hz
Timer: Limits ≥ 75 msec. within 75 ±25 msec.
ON time for output logic non-inverted
OFF time for output logic inverted
Saturation voltage: 0.5 V DC

■ **High Frequency Open Collector:**
50 V DC @100 mA (resistive load)
Maximum frequency: 10 kHz
Saturation voltage: 0.5 V DC

■ **Voltage Pulse**
Maximum frequency: 10 kHz
High level: Rating (5, 12 or 24 V) ±10 %
Low level: ≤ 0.5V
Load resistance:
≥ 250 Ω for 5 V
≥ 600 Ω for 12 V
≥ 1200 Ω for 24 V

■ **Dry Contact AC/DC Switch**
132 V AC @200 mA (cos φ = 1)
30 V DC @200 mA (resistive load)
Maximum frequency: 30 Hz
Timer: Limits within 75 ±25 msec.
for wider than 75 msec. pulses
ON time for output logic non-inverted
OFF time for output logic inverted
Saturation voltage: 3 V DC

INSTALLATION**Power Consumption**

• **AC:**
Approx. 3 VA at 100 V
Approx. 4 VA at 200 V
Approx. 5 VA at 264 V

• **DC:** Approx. 3 W

Operating temperature: -5 to +55°C (23 to 131°F)
Operating humidity: 30 to 90 %RH (non-condensing)
Mounting: Surface or DIN rail
Weight: 150 g (0.33 lb)

PERFORMANCE

Insulation resistance: ≥ 100 MΩ with 500 V DC
Dielectric strength: 2000 V AC @1 minute (input to output to power to ground)

STANDARDS & APPROVALS

EU conformity:
EMC Directive
EMI EN 61000-6-4

EMS EN 61000-6-2

Low Voltage Directive

EN 61010-1

Measurement Category II (output)

Installation Category II (power)

Pollution Degree 2

Input or output to power: Reinforced insulation (300 V)

Input to output: Basic insulation (300 V)

RoHS Directive

UK conformity (UKCA):

The UK legislations and designated standards are equivalent to the applicable EU directives.

(Refer to M-System’s website for more information about the legislations and designated standards.)

Approval:

UL/C-UL nonincendive Class I, Division 2,

Groups A, B, C, and D

(ANSI/ISA-12.12.01, CAN/CSA-C22.2 No.213)

UL/C-UL general safety requirements

(UL 61010-1, CAN/CSA-C22.2 No.61010-1)

OUTPUT LOGIC

INPUT TYPE	PULSE LOGIC	INPUT	VOLTAGE PULSE OUTPUT	OPEN COLLECTOR DRY CONTACT AC/DC SWITCH
Voltage Pulse	Non Inverted	H L	H L	OFF ON
	Inverted	H L	H L	OFF ON
Mechanical Contact Open Collector Clamp-on Pulse Sensor CLSP	Non Inverted	OFF ON	H L	OFF ON
	Inverted	OFF ON	H L	OFF ON

EXTERNAL DIMENSIONS & TERMINAL ASSIGNMENTS unit: mm [inch]

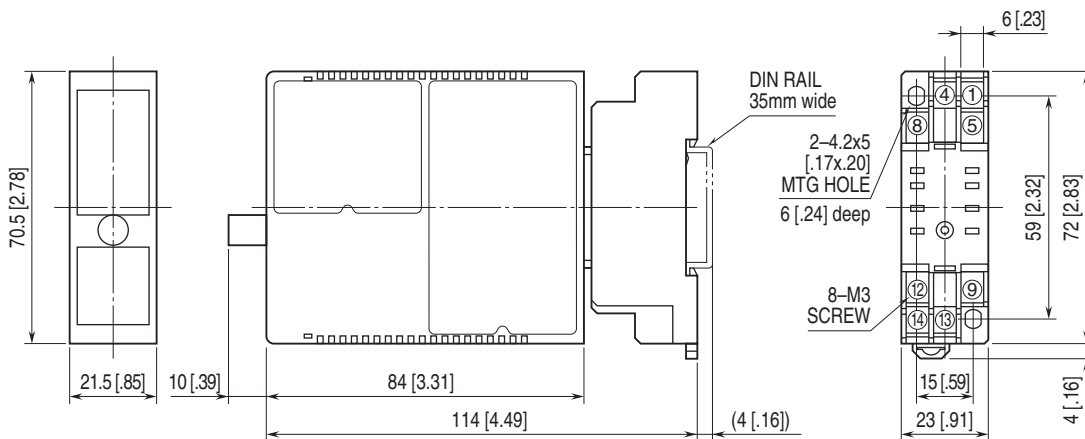

• When mounting, no extra space is needed between units.

SCHEMATIC CIRCUITRY & CONNECTION DIAGRAM

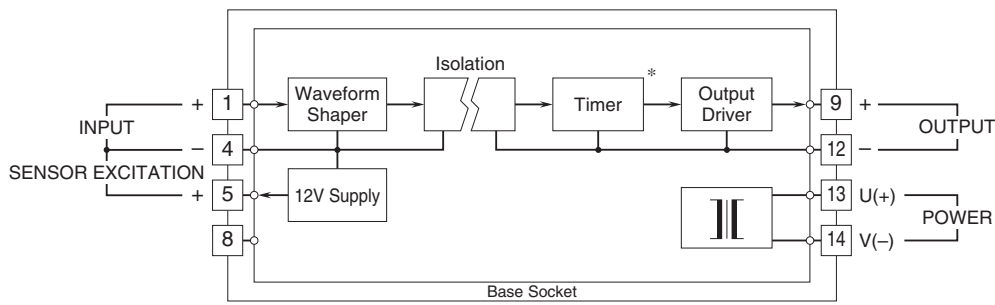

* Low freq. open collector and dry contact AC/DC switch output only.

Input Connection Examples

■ Mechanical Contact, Open Collector or Clamp-on Pulse Sensor CLSP

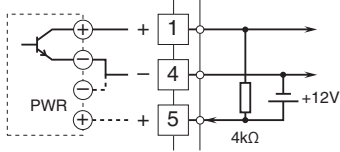

■ Voltage Pulse

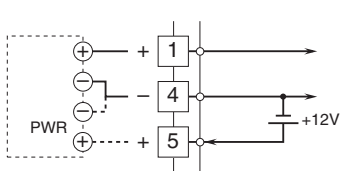

Output Connection Examples

■ Open Collector

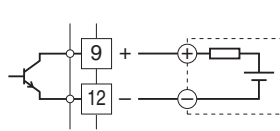

■ Voltage Pulse

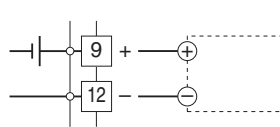

■ Dry Contact AC/DC Switch

• AC Powered

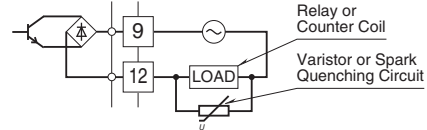

• DC Powered

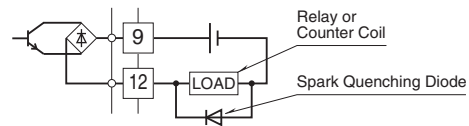

Specifications are subject to change without notice.