

**LIGHTNING SURGE PROTECTOR FOR ETHERNET**  
(100 BASE-TX / 10 BASE-T)

MODEL **MDM5E-A**

**BEFORE USE ....**

Thank you for choosing M-System. Before use, please check contents of the package you received as outlined below.

If you have any problems or questions with the product, please contact M-System's Sales Office or representatives.

■ **PACKAGE INCLUDES:**

- Lightning surge protector.....(1)
- LAN cable.....(1)

■ **MODEL NO.**

Confirm Model No. marking on the product to be exactly what you ordered.

■ **INSTALLATION / INSTRUCTION MANUAL**

This manual describes necessary points of caution when you use this product, including installation, and basic maintenance procedure.

**LIMITATION APPLICABLE TO M-RESTER**

The M-RESTER will protect electronics equipment from damage caused by lightning by absorbing most of the surge voltages.

However, M-RESTER may not be effective against certain extremely high voltages caused by a direct or almost direct hit by lightning.

M-RESTER must be installed according to this installation / instruction manual.

**SPECIFICATIONS**

	LINE TO LINE	LINE TO EARTH	SHIELD TO EARTH
Max. continuous operating voltage (Uc)	± 6 V	± 150 V	± 150 V
Voltage protection level (Up)	± 38 V	± 600 V	± 600 V
Response time	≤ 4 nsec.	≤ 20 nsec.	≤ 20 nsec.
Leakage current @Uc	≤ 0.1 mA	≤ 5 μA	≤ 5 μA
Discharge current capacity	500 A (8/20 μsec.)	500 A (8/20 μsec.)	5000 A (8/20 μsec.)
Series resistance	approx. 0 Ω		
Impulse durability	Category C1		
Transmission characteristics	Attenuation 1.5 dB (1 to 100 MHz)		

**POINTS OF CAUTION**

■ **ENVIRONMENT**

- Indoor use.
- When heavy dust or metal particles are present in the air, install the surge protector inside proper housing with sufficient ventilation.
- Do not install the surge protector where it is subjected to continuous vibration. Do not subject the unit to physical impact.
- Environmental temperature must be within -5 to +55°C (23 to 131°F) and relative humidity within 30 to 90% RH in order to ensure adequate life span and operation.

■ **AND ....**

- We recommend that you keep spare surge protectors so that you can replace them when necessary.
- Lightning surge can enter not only through signal lines but also through power supply lines. We recommend that you also use the surge protectors for power line for sufficient protection.

**COMPONENT IDENTIFICATION**

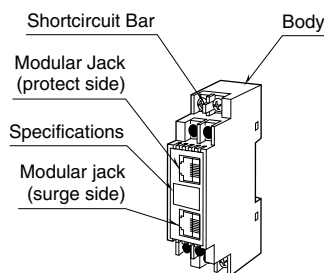

NOTE  
The shortcircuit bar is attached to the terminal at the factory.

# INSTALLATION

Set the unit so that its mounting adapter is at the bottom.

## ■ MOUNTING THE UNIT ON A DIN RAIL

- A) Hung the upper hook at the rear side of unit on the DIN rail.
- B) Push in the lower in keeping pressing the unit to the DIN rail.

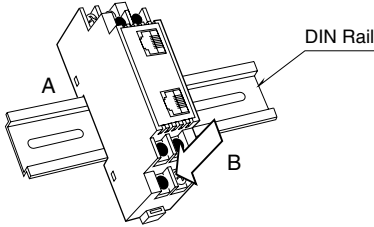

## ■ UNMOUNTING THE UNIT

- A) Push down the DIN rail adaptor utilizing a minus screwdriver.
- B) Pull out the lower part of the unit.
- C) Detach the upper part from the DIN rail.

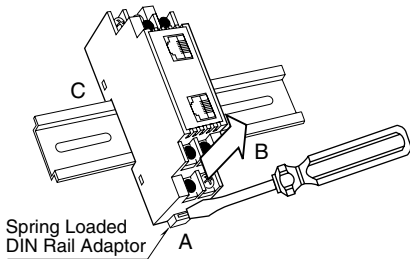

# TERMINAL CONNECTIONS

Connect the unit as in the diagram below.

## ■ EXTERNAL DIMENSIONS unit: mm (inch)

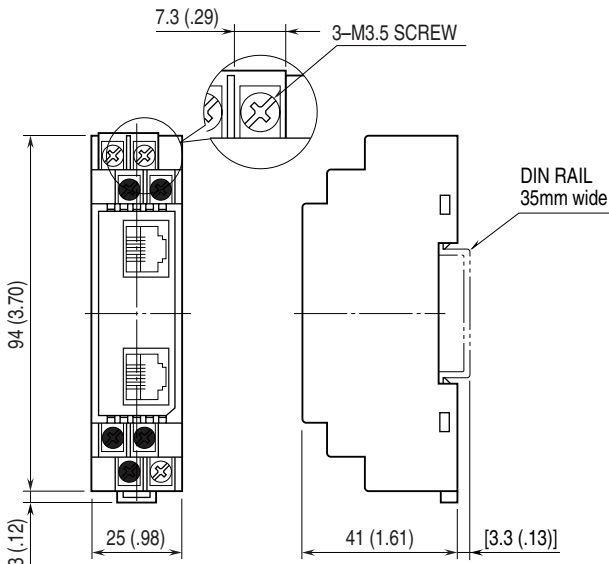

## ■ TERMINAL ASSIGNMENT

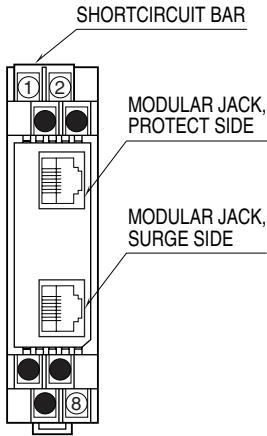

•When mounting, no extra space is needed between units.

■ NETWORK CONNECTION

■ PROTECTING NON-SPT (UTP\*3) DEVICE

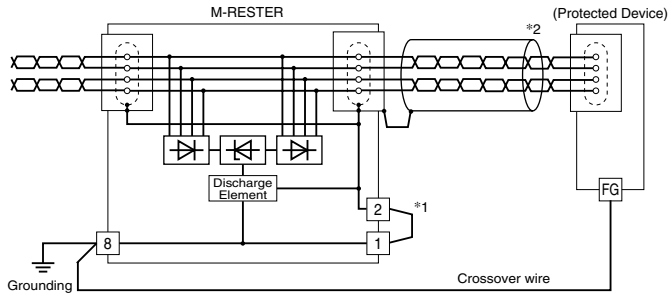

- \*1. Maintain the shortcircuit bar. The protected device is 'grounded.'
- \*2. Cable included in the product package.
- \*3. Unshielded twisted-pair cable

■ PROTECTING STP\*6 DEVICES

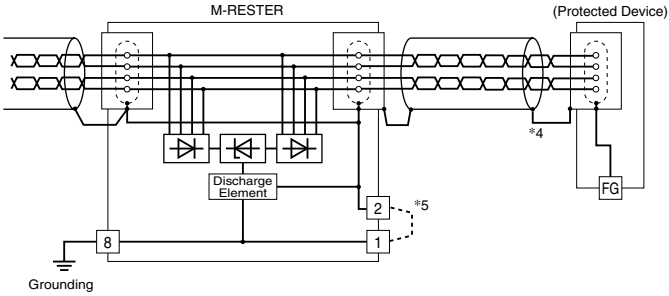

- \*4. LAN's shield wire (included in the product package) serves as the cross-over wiring.
- \*5. The protected device is 'grounded' when the shortcircuit bar is connected. Remove the bar in order to switch to 'floating' state.
- \*6. Shielded twisted-pair cable

SYSTEM CONFIGURATION EXAMPLE

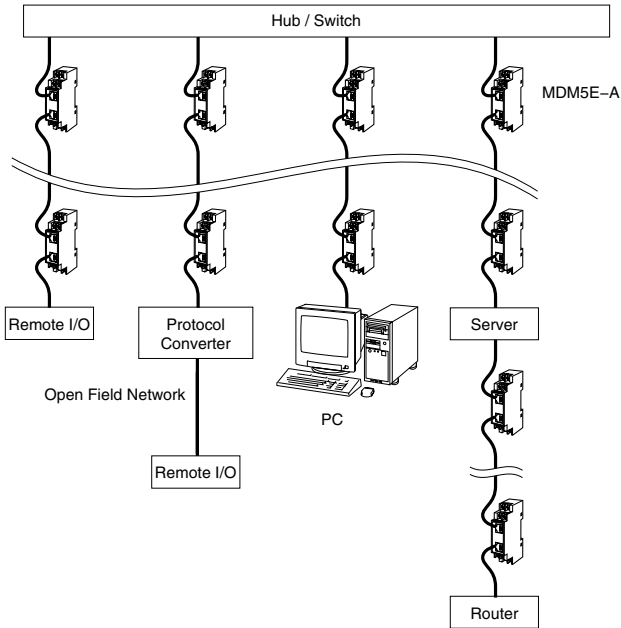

## MAINTENANCE

Check M-RESTER periodically. Many cases of lightning are ignored, and even lightning at a far distance often causes inductive surges.

We recommend that you check your M-RESTER about twice a year, before and after the rainy season. Check whenever you experience a strong lightning occurrence.

Checking procedure is explained in the following:

### ■ CHECKING

#### WIRING

- Make sure that wiring is done as instructed in the connection diagram.

#### DISCHARGE ELEMENT

Approximate checking can be conducted as following.

- 1) Remove all LAN cables connected to the MDM5E-A.
- 2) Remove also the shortcircuit bar.
- 3) Connect between the surge side modular jack and a modular jack type rosette with a LAN cable and remove the rosette's cover to expose its connecting pines.

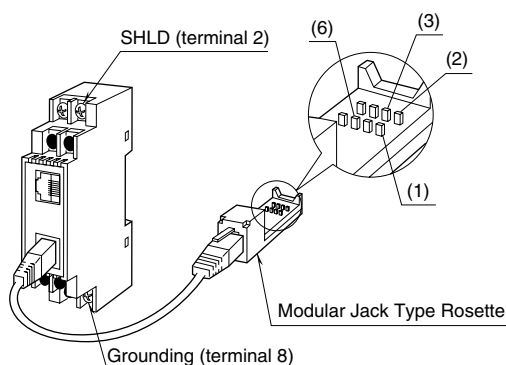

#### 4) Shortcircuit Test

Check resistance across the following terminals on the high resistance range of multimeter and confirm no conduction.

(The meter will indicate the same value as it will show when these terminals are open.)

Protector terminals (2) – (8)

Then, apply  $\pm 6V$  DC across the following terminals and measure leakage current to show  $\leq 0.1mA$ .

If a voltage generator is not available, check resistance with a multimeter and confirm no conduction. (Use of a voltage generator is strongly recommended.)

Rosette pins (1) – (2), (3) – (6)

#### 5) Discharging Test

Check that discharging occurs across the following terminals with a  $\pm 500V$  DC 1000 M $\Omega$  megger. (The megger shows  $\leq 20 M\Omega$ .)

Rosette pin (1) – Protector terminal (8)

Rosette pin (2) – Protector terminal (8)

Rosette pin (3) – Protector terminal (8)

Rosette pin (6) – Protector terminal (8)

Protector terminals (2) – (8)