

Bargraph Indicators 48N Series

BARGRAPH INDICATING ALARM

(with 4-digit digital meter; RTD input)

Functions & Features

- Displays a process variable in graphic bargraph of 101 LED segments
- Clear 4-digit digital meter
- Provides max. 4 alarm contact outputs
- Multi-color indicator
- Linearization and burnout
- LED brightness adjustment
- IP65 front cover
- Scale plate is easily replaced
- Separable terminal block

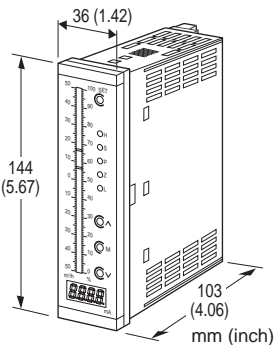

B: Blue

1: Multi-color (red, orange and green), Pattern 1
(See 'External View.')

2: Multi-color (red, orange and green), Pattern 2
(See 'External View.')

[3] INPUT RTD (2- or 3-wire)

1: JPt 100 (JIS'89)

(Usable range: -200 to +500°C, -328 to +932°F; min.span: 50°C, 90°F)

3: Pt 100 (JIS'89)

(Usable range: -200 to +650°C, -328 to +1202°F; min.span: 50°C, 90°F)

4: Pt 100 (JIS'97, IEC)

(Usable range: -200 to +850°C, -328 to +1562°F; min.span: 50°C, 90°F)

5: Pt 50 Ω (JIS'81)

(Usable range: -200 to +500°C, -328 to +932°F; min.span: 100°C, 180°F)

6: Ni 508.4 Ω

(Usable range: -50 to +200°C, -58 to +392°F; min.span: 30°C, 54°F)

Note: Consult M-System for 2-wire RTD

[4] POWER INPUT

AC Power

M: 85 - 264 V AC (Operational voltage range 85 - 264 V, 50/60 Hz
(CE or UKCA marking not available)

M2: 100 - 240 V AC (Operational voltage range 85 - 264 V, 50/60 Hz)

DC Power

R: 24 V DC

(Operational voltage range 24 V ±15 %, ripple 10 %p-p max.)

MODEL: 48NDR-[1][2][3]-[4][5]

ORDERING INFORMATION

- Code number: 48NDR-[1][2][3]-[4][5]
- Specify a code from below for each of [1] through [5].
(e.g. 48NDR-424-R/CE/D/BL/Q)
- Temperature range (e.g. 0 - 200 °C)
- Bargraph scale (e.g. 0 - 100 %) (See 'Scale Plate.')
- Digital indicator scale (e.g. 0.0 - 200.0)
- Specify the specification for option code /Q
(e.g. /C01/SET)

[1] ALARM OUTPUT

- 0:** None
- 2:** 2 points
- 4:** 4 points

[2] BAR LED COLOR

- R:** Red
- Y:** Amber
- G:** Green

[5] OPTIONS (multiple selections)

Standards & Approvals

blank: Without CE

/CE: CE marking

/UK: CE, UKCA marking

Bezels

blank: Bezels for M-System's 48 Series panel cutout

/D: Bezels for DIN panel cutout

/F: Bezels for Fuji Electric's PAJ, PAK, PBA panel cutout

Burnout

blank: Upscale burnout

/BL: Downscale burnout

Other Options

blank: none

/Q: Option other than the above (specify the specification)

SPECIFICATIONS OF OPTION: Q (multiple selections)

COATING (For the detail, refer to M-System's web site.)

Moving parts and indicators are not coated.

/C01: Silicone coating

/C02: Polyurethane coating

/C03: Rubber coating

EX-FACTORY SETTING

/SET: Preset according to the Ordering Information Sheet
(No. ESU-9436)

BEZEL OPTION

Bezels are used to adapt the 48N Series to an existing panel cutout. In order to replace M-System's 48 Series products, use the one attached to the 48N Series as standard. When the existing panel is cut according to DIN standard, specify '/D' suffix code.

For a new installation, no bezel is required. Please refer to 'Mounting Requirement' and mount the 48N directly. Ingress protection is invalid when the 48N is mounted with a bezel, or when multiple modules are stacked side by side.

SPARE PARTS

- Scale plate

GENERAL SPECIFICATIONS

Construction: Panel flush mounting

Degree of protection: IP65; applicable to the front panel for single unit mounted according to the specified panel cutout

Connection: M3 separable screw terminal (torque 0.6 N·m)

Screw terminal: Nickel-plated steel

Housing material: Flame-resistant resin (black)

Isolation: Input to output to power

Zero adjustment: 0 - 10 % (front)

Span adjustment: 90 to 100 % (front)

Scale plate: Flame resistant resin (white scale & characters on black base)

H & L alarm output delay: 0 sec. (factory setting; fieldselectable between 0 and 15 sec. by 1 sec. increments)

Setpoint adjustment

2 points:

H [L setpoint] to 100 %

L 0 to [H setpoint]

or No alarm trip

4 points:

HH [H setpoint] to 100 %

H [L setpoint] to [HH setpoint]

L [LL setpoint] to [H setpoint]

LL 0 to [L setpoint]

or No alarm trip

Alarm deadband (hysteresis): 1 %

Burnout: Upscale standard; downscale optional.

The 100 % position bargraph segment and 115 % value of the digital meter blink with upscale burnout; the 0 % position bargraph segment and -15 % value of the digital meter blink with downscale burnout.

Linearization: Standard

Setting: (Front button)

- Zero and span adjustments
- Alarm setpoint
- Others

(Refer to the instruction manual for details)

Read rate: 10/s

Moving average sample number: 4 (factory setting; field selectable among 1, 2, 4, 8 or 16)

LED brightness adjustment: 7 levels

■ BARGRAPH

LED: 101-segment LED, 100 mm (3.96") long, 3.00 mm (.12") wide

Display range: 0 to 100 (scaling function not available) (0 % or 100 % position bar blinks when over range)

Scale: Two different scales available for single bargraph

Characters: Max. 4 characters including decimal point and negative sign

Divisions: Min. 22, max. 100

Engineering unit: Max. 6 characters

■ DIGITAL DISPLAYS

LED: 7-segment red LED, character 8 mm (.31") high

Number of digits: 4 digits

Setting range: -1999 to 9999

(Min. 3 significant digits)

Minimum scale value: 100 (3 digits, the decimal point position disregarded)

Scaled range: The range between -1999 to 9999 and -15 to +115 % of input span

(The indicator blinks when the input is out of the range)

Decimal point position: 10^{-1} , 10^{-2} , 10^{-3} or none

Zero indication: Higher-digit zeros are suppressed

Engineering unit: Max. 6 characters on scale plate

INPUT SPECIFICATIONS

Maximum leadwire resistance: 200 Ω per wire (3-wire)

Sensing current: ≤ 1 mA

OUTPUT SPECIFICATIONS

- **Alarm Output:** Relay contact
- Rated load:** 250 V AC @1 A (cos ϕ = 1)
30 V DC @5 A (resistive load)
- Maximum switching voltage:** 250 V AC, 220 V DC
- Maximum switching power:** 380 VA, 150 W
- Minimum load:** 5 V DC @100 mA
- Mechanical life:** $\geq 5 \times 10^8$ cycles (rate 180 cycles/min.)

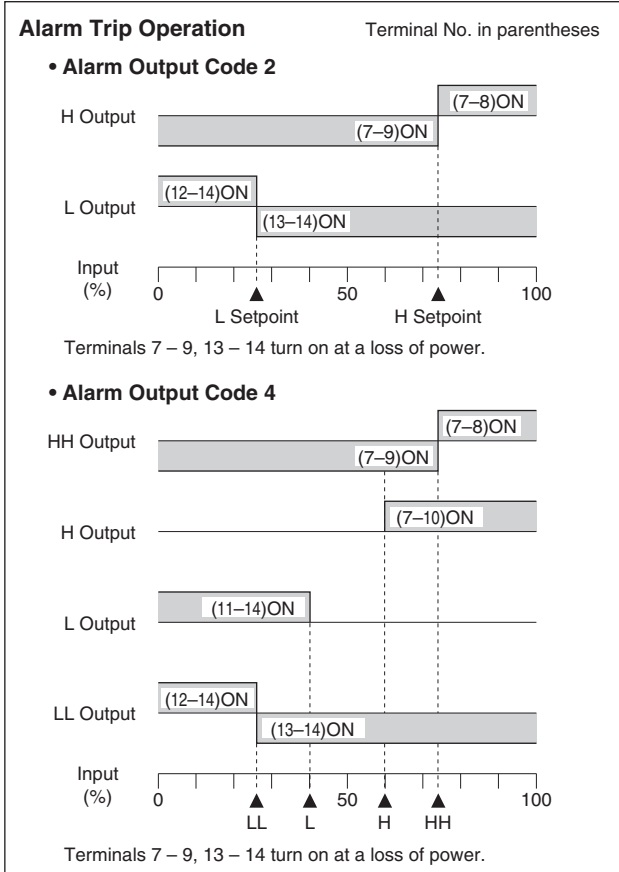

PERFORMANCE in percentage of span

- Accuracy**
- Bargraph:** $\pm 1\% \pm 1$ digit
- Digital indicator, alarm output:** $\pm 0.5\% \pm 1$ digit
- Temp. coefficient:** $\pm 0.015\%$ of FS/ $^{\circ}$ C ($\pm 0.008\%$ of FS/ $^{\circ}$ F)
- Response time:** ≤ 0.5 sec.
(moving average sample number set to 4)
- Burnout response:** ≤ 10 sec.
- Insulation resistance:** ≥ 100 M Ω with 500 V DC
- Dielectric strength:** 2000 V AC @1 minute (input to output to power to ground)

STANDARDS & APPROVALS

- EU conformity:**
- EMC Directive
 - EMI EN 61000-6-4
 - EMS EN 61000-6-2
- Low Voltage Directive
 - EN 61010-1
 - Measurement Category II (output)
 - Installation Category II (power)
 - Pollution Degree 2
- Input to output to power: Reinforced insulation (300 V)
- RoHS Directive
- UK conformity (UKCA):**
- The UK legislations and designated standards are equivalent to the applicable EU directives.
(Refer to M-System's website for more information about the legislations and designated standards.)

INSTALLATION

Power Consumption

- **AC:**
- Approx. 5.5 VA at 100 V with max. load
- Approx. 7 VA at 200 V with max. load
- Approx. 8 VA at 264 V with max. load
- **DC**
- Approx. 3.5 W at 20.4 V with max. load
- Approx. 3.5 W at 24 V with max. load
- Approx. 3.5 W at 27.6 V with max. load
- Operating temperature:** -5 to +55 $^{\circ}$ C (23 to 131 $^{\circ}$ F)
- Operating humidity:** 30 to 90 %RH (non-condensing)
- Mounting:** Panel flush mounting
- Weight:** 300 g (0.66 lb)

SCALE PLATE

■ WHAT MUST BE SPECIFIED WHEN ORDERING

Following two methods can specify scale plate.

a) Using 'Scale Plate Designer'

Access 'Design Scale Plate' in the M-System web site (<http://www.m-system.co.jp/english>). Scale plate can be designed in this web site.

By function below, it can be easy to create standard design or original design.

[Design Automatically]

Entering Minimum, Maximum, and Unit allows to create automatically a scale plate.

Maximum created scale division number is '54.9'. Use [Specify Division Number], if division number more than '54.9' is required (Maximum 100 division).

[Specify Division Interval]

Division Interval can be specified according to the application.

[Specify Division Number]

It is available to create originally with scale division number, length of line, position, character size, font and detailed position.

After designing is completed, register code is issued. Place the order with this code.

Once scale plate is designed, it is recorded. The register code can be used any number of times.

b) Specifying scale range and display unit when placing the order

It is available to create by specifying scale range and display unit for right and left.

Regarding design of scale plate such as division number, length of division number line, and character font, they are same as above [Design Automatically], M-System designs them.

■ DESIGNING BY 'DESIGN AUTOMATICALLY'

How 'Design Automatically' creates scale design is described succinctly below.

■ TYPES OF DIVISIONS

Five (5) types of divisions are used depending upon the scale span, which determined by the following equation:

$$\text{Scale Span} = (\text{Max. range value} - \text{Min. range value}) \times 10^n$$

where n = integer (used to limit the calculated scale span to the minimum of 1.1, below 11.0.)

The number of divisions is automatically determined by the scale span.

• Type 1: 1.1 Scale Span < 1.3

Number of divisions: 22 to 25.9

Scale: Starts at 0, increments by 0.02 / 0.2 / 2 / 20 / 200. Min. and max. values indicated. 4 digits including negative sign and decimal point.

Division lines: Long, Short, Medium, Short, Long (4 divisions repeated)

• Type 2: 1.3 Scale Span < 2.0

Number of divisions: 26 to 39.9

Scale: Starts at 0, increments by 0.03 / 0.3 / 3 / 30 / 300. Min. and max. values indicated. 4 digits including negative sign and decimal point.

Division lines: Long, Short, Medium, Short, Medium, Short, Long (6 divisions repeated)

Minimum Divisions	Maximum Divisions	Bipolar Scale
11 —	1.29 —	600 —
10 —	1.2 —	400 —
8 —	1.0 —	200 —
6 —	0.8 —	0 —
4 —	0.6 —	-200 —
2 —	0.4 —	-400 —
0 —	0.2 —	-600 —

Minimum Divisions	Maximum Divisions	Bipolar Scale
130 —	1.99 —	0.8 —
120 —	1.8 —	0.6 —
90 —	1.5 —	0.3 —
60 —	1.2 —	0 —
30 —	0.9 —	-0.3 —
0 —	0.6 —	-0.6 —
	0.3 —	-0.8 —
	0 —	

• **Type 3: 2.0 Scale Span < 2.6**

Number of divisions: 40 to 51.9

Scale: Starts at 0, increments by 0.05 / 0.5 / 5 / 50 / 500. Min. and max. values indicated. 4 digits including negative sign and decimal point.

Division lines: Long, Short, Medium, Short, Medium, Short, Medium, Short, Medium, Short, Long (10 divisions repeated)

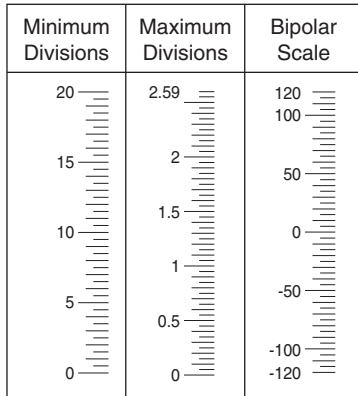

• **Type 5: 5.5 Scale Span < 11.0**

Number of divisions: 27.5 to 54.9

Scale: Starts at 0, increments by 0.01 / 0.1 / 1 / 10 / 100 / 1000. Min. and max. values indicated. 4 digits including negative sign and decimal point.

Division lines: Long, Medium, Medium, Medium, Medium, Long (5 divisions repeated)

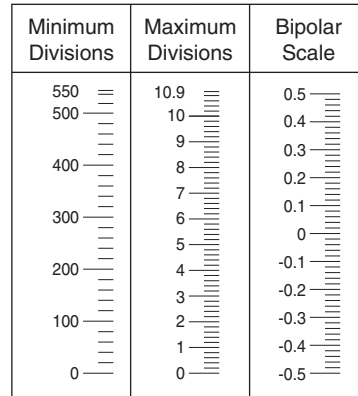

• **Type 4: 2.6 Scale Span < 5.5**

Number of divisions: 26 to 54.9

Scale: Starts at 0, increments by 0.05 / 0.5 / 5 / 50 / 500. Min. and max. values indicated. 4 digits including negative sign and decimal point.

Division lines: Long, Medium, Medium, Medium, Medium, Long (5 divisions repeated)

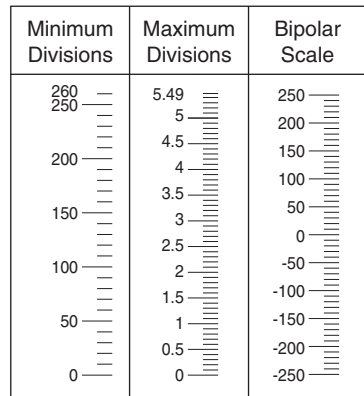

[Example] : Bargraph range 0 to 300°C (Type 4) for left
 Bargraph range 0 to 100 % (Type 5) for right
 Digital indicator range 0 to 300°C

Left scale range: 0 – 300
 Left scale unit (bargraph): °C
 Right scale range: 0 – 100
 Right scale unit (bargraph): %
 Digital indicator unit: °C

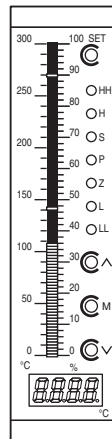

EXTERNAL VIEW

■ ALARM OUTPUT CODE 0: None

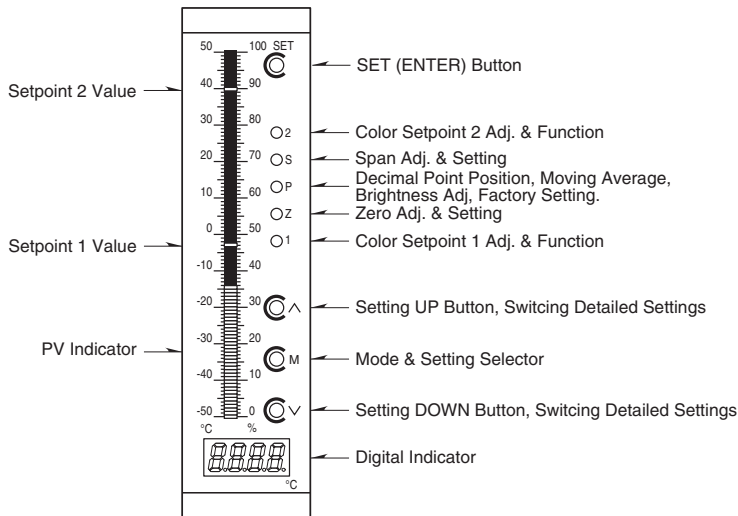

Note: Setpoint 1 or 2 provided only for the multi-color bar type.

• Bar Color Patterns

Pattern 1 (Bar LED color code 1)

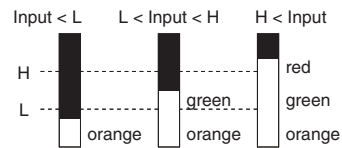

Pattern 2 (Bar LED color code 2)

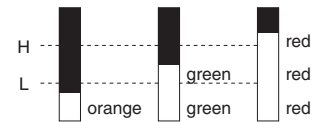

■ ALARM OUTPUT CODE 2: 2 points

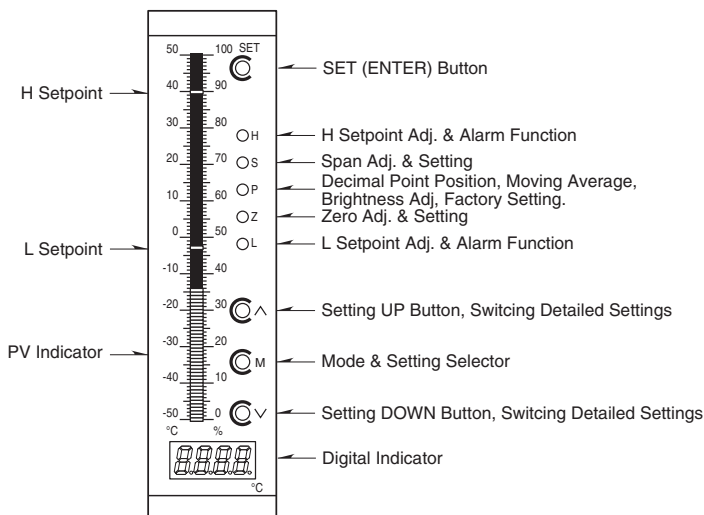

■ ALARM OUTPUT CODE 4: 4 points

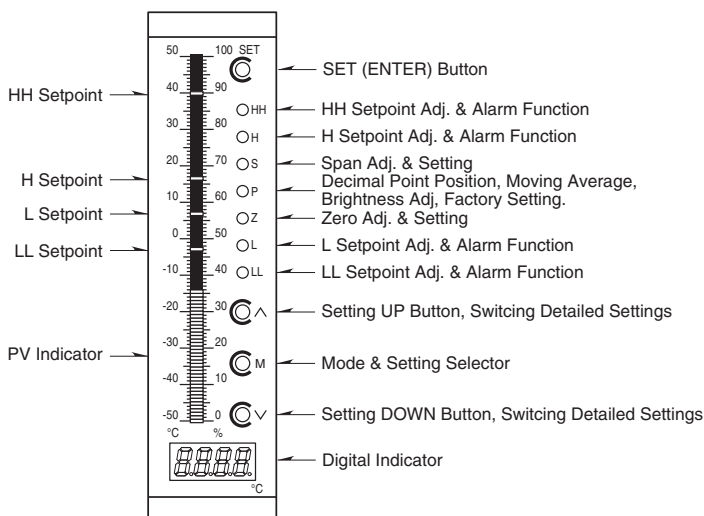

EXTERNAL DIMENSIONS & TERMINAL ASSIGNMENTS unit: mm [inch]

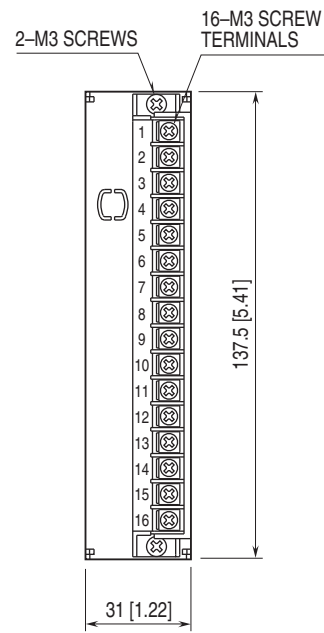
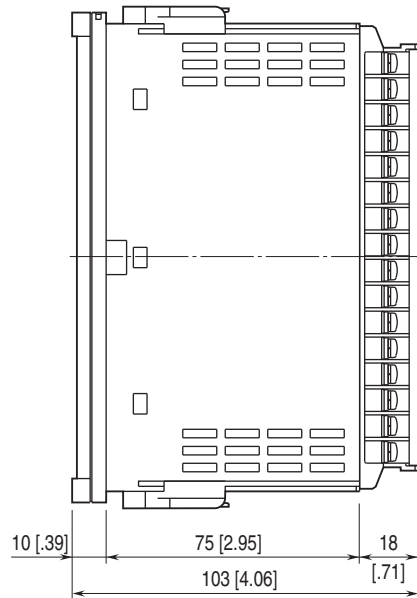
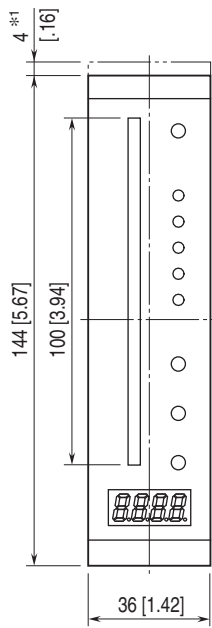

■ STANDARD BEZEL *2

■ OPTION /D BEZEL *3

■ OPTION /F BEZEL *4

Rounded corners for the option /D

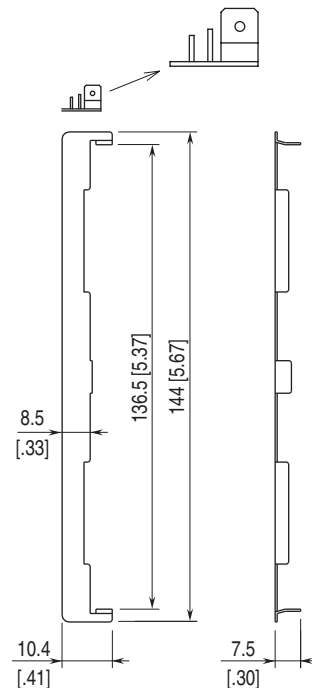
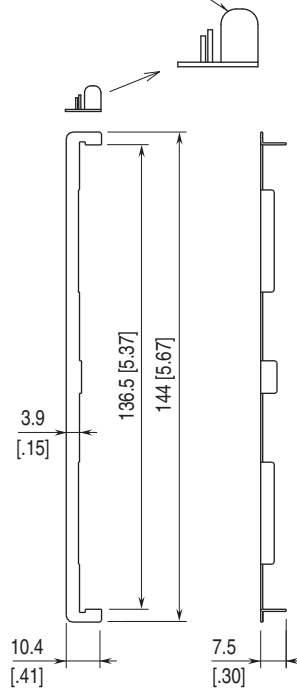
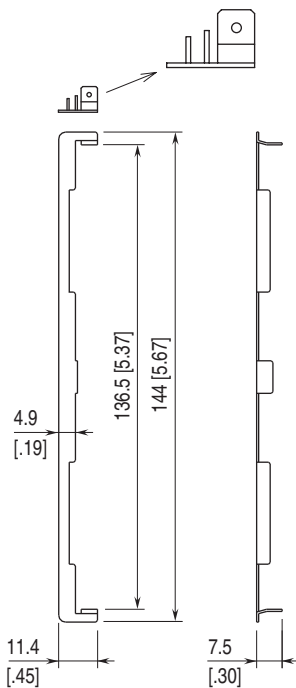

- *1. Space required when replacing the scale plate.
- *2. Used for the existing panel cutout of M-System 48 Series (38 × 139.5 mm).
- *3. Used for the existing DIN panel cutout (33 × 138 mm)
- *4. Used for the existing panel cutout of Fuji Electric PAJ, PAK, PBA (44 × 138 mm), etc.

PANEL CUTOUT unit: mm

■ SINGLE MOUNTING

(Conform to degree of protection IP65)

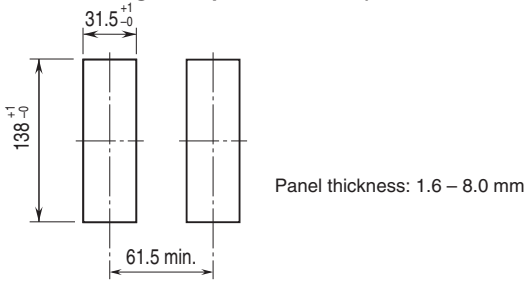

■ CLUSTERED MOUNTING

(Not conform to degree of protection IP65)

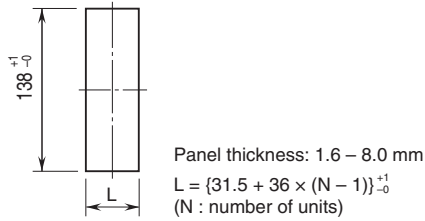

Note 1: Observe at the minimum of 3 cm above and below the units for heat dissipation.

Note 2: No bezel is needed when the panel is cut according to the above drawings.

SCHEMATIC CIRCUITRY & CONNECTION DIAGRAM

■ ALARM OUTPUT CODE 0: None

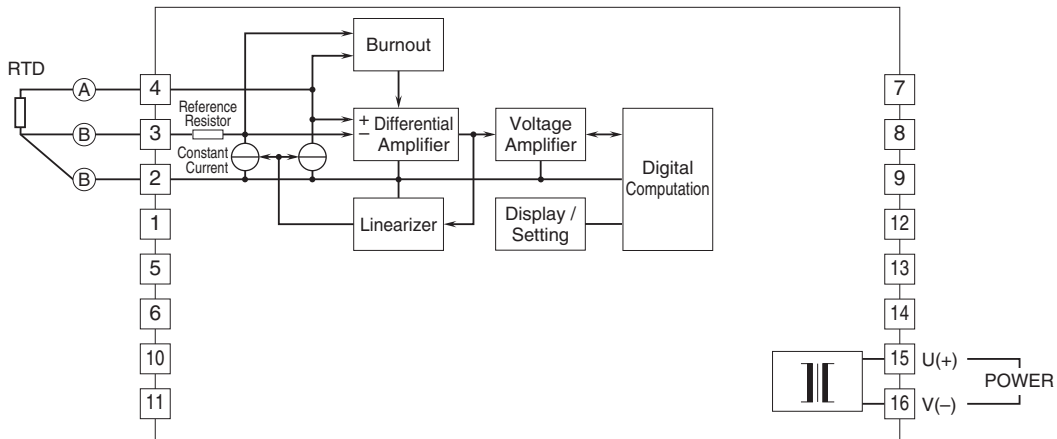

■ ALARM OUTPUT CODE 2: 2 points

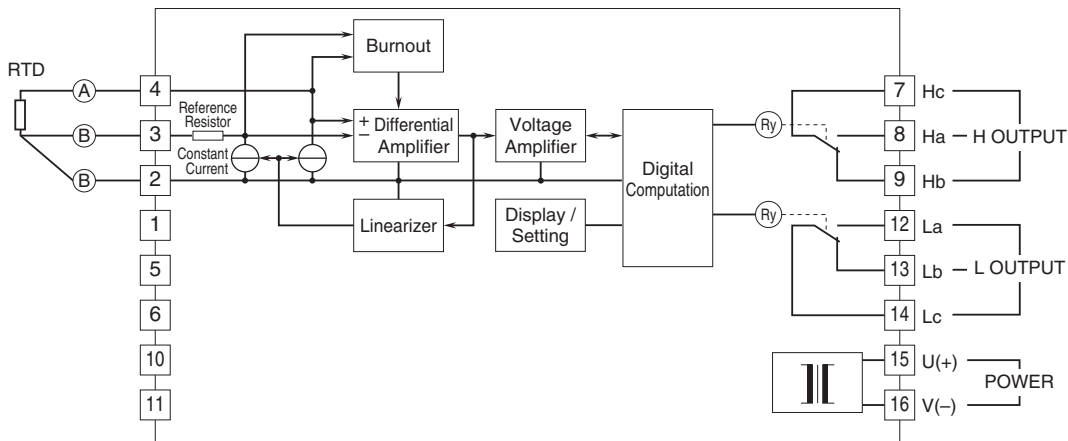

■ ALARM OUTPUT CODE 4: 4 points

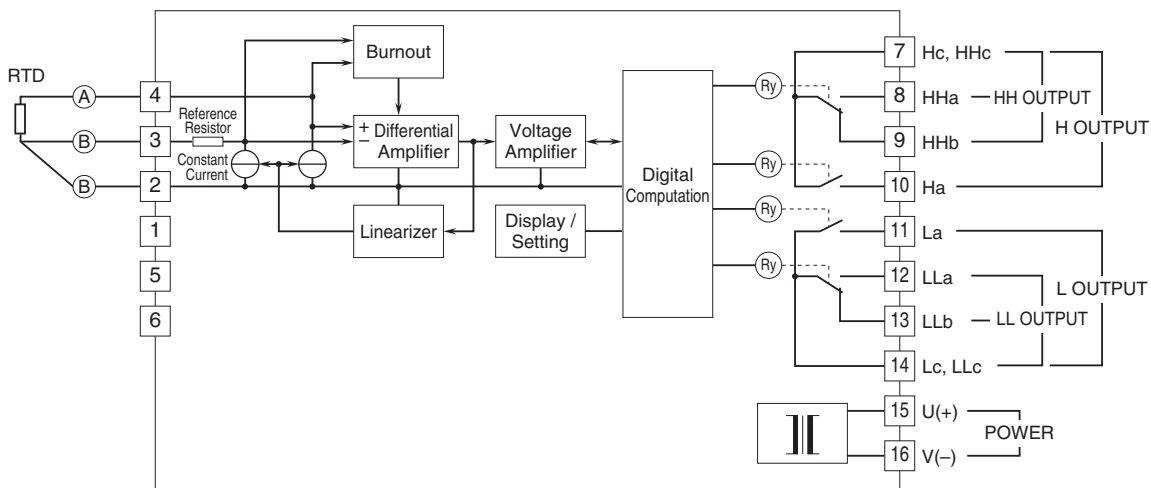

■ Relay Protection

• AC Powered

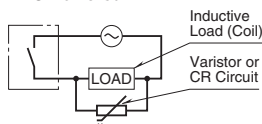

• DC Powered

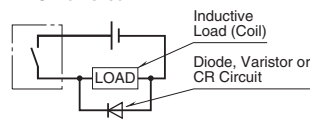



Specifications are subject to change without notice.