

**BARGRAPH INDICATING ALARM**  
(with 2-wire transmitter excitation)

MODEL **48NAVD**

**BEFORE USE ....**

Thank you for choosing M-System. Before use, please check contents of the package you received as outlined below.

If you have any problems or questions with the product, please contact M-System's Sales Office or representatives.

**■ PACKAGE INCLUDES:**

- Bargraph indicator (incl. scale plate).....(1)
- Mounting bracket.....(2)
- Bezel\*1.....(2)
- Watertight packing .....(1)

\*1. The size of included bezel differs depending on option code.

**■ MODEL NO.**

Confirm Model No. marking on the product to be exactly what you ordered.

**■ INSTRUCTION MANUAL**

This manual describes necessary points of caution when you use this product, including installation, connection and basic maintenance procedures.

**POINTS OF CAUTION**

**■ CONFORMITY WITH EU DIRECTIVES OR UK LEGISLATION**

- This equipment is suitable for Pollution Degree 2, Measurement Category II (output, transient voltage 2500V) and Installation Category II (transient voltage 2500V). Reinforced insulation (signal input to output to power input: 300V) is maintained. Prior to installation, check that the insulation class of this unit satisfies the system requirements.
- The equipment must be mounted on a panel surface. Once mounted on a panel, take appropriate precautions to prevent operators to be exposed to the terminal block.
- Altitude up to 2000 meters.
- Insert a noise filter for the power source connected to the unit. TDK-Lambda Noise Filter Model RSAN-2006 or equivalent is recommended.
- The equipment must be installed such that appropriate clearance and creepage distances are maintained to conform to CE or UKCA requirements. Failure to observe these requirements may invalidate the CE or UKCA conformance.
- The actual installation environments such as panel configurations, connected devices, connected wires, may affect the protection level of this unit when it is integrated in a panel system. The user may have to review the CE or UKCA requirements in regard to the whole system and employ additional protective measures to ensure the CE or UKCA conformity.
- In order to enable the operator to turn off the power input immediately, install a switch or a circuit breaker according to the relevant requirements in IEC 60947-2 and properly indicate it.

**■ POWER INPUT RATING & OPERATIONAL RANGE**

- Locate the power input rating marked on the product and confirm its operational range as indicated below:  
100 – 240V and 85 – 264V AC rating: 85 – 264V, 50/60 Hz, approx. 5.5 – 8.5VA  
24V DC rating: 24V ±15%, approx. 3 – 3.5W

**■ GENERAL PRECAUTIONS**

- Before you remove the unit or mount it, turn off the power supply and input signal for safety.
- Be sure to put the terminal cover on while the power is supplied.

**■ ENVIRONMENT**

- Indoor use.
- If the unit's environmental protection is compromised (e.g. when multiple units are to be mounted side by side) when heavy dust or metal particles are present in the air, install them inside an enclosure with a proper ventilation.
- Do not install the unit where it is subjected to continuous vibration. Do not subject the unit to physical impact.
- Environmental temperature must be within -10 to +55°C (14 to 131°F) with relative humidity within 30 to 90% RH in order to ensure adequate life span and operation.

**■ REQUIREMENTS TO ENSURE IP65**

- Observe the designated panel cutout size (31.5 × 138 mm).
- Single mounting only. IP65 is not ensured when the units are clustered side by side.
- The watertight packing included in the product package must be placed behind the front cover.
- The mounting bracket must be fastened tightly until they hit the panel.
- Confirm visually that the packing is not contorted or excessively run off the edge after installation.

**■ WIRING**

- Do not install cables close to noise sources (relay drive cable, high frequency line, etc.).
- Do not bind these cables together with those in which noises are present. Do not install them in the same duct.

■ **TERMINAL BLOCK**

- The terminal block is separable in two pieces. Loosen two screws on top and bottom of the terminal block to separate.
- Be sure to turn off the power supply, input signal and power supply to the output relays before separating the terminal block.

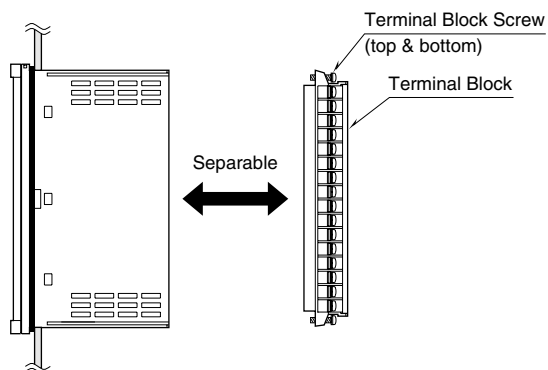

■ **AND ....**

- The unit is designed to function as soon as power is supplied, however, a warm up for 10 minutes is required for satisfying complete performance described in the data sheet.

**COMPONENT IDENTIFICATION**

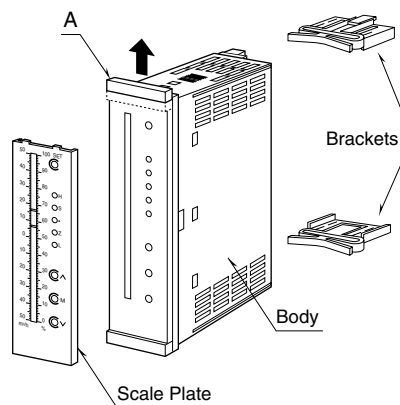

Pull up the part 'A' when replacing the scale plate.

**INSTALLATION**

■ **PANEL CUTOUT** unit: mm

■ **SINGLE MOUNTING (Conform to degree of protection IP65)**

• **Vertical Mounting**

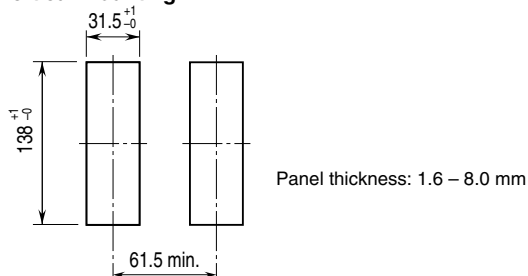

• **Horizontal Mounting**

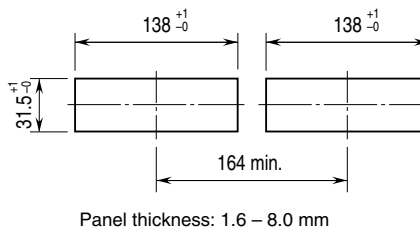

■ **CLUSTERED MOUNTING (Not conform to degree of protection IP65)**

• **Vertical Mounting**

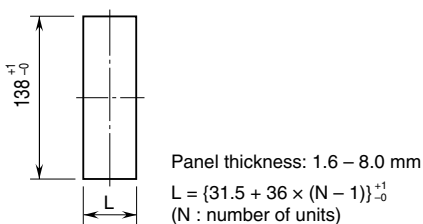

• **Horizontal Mounting**

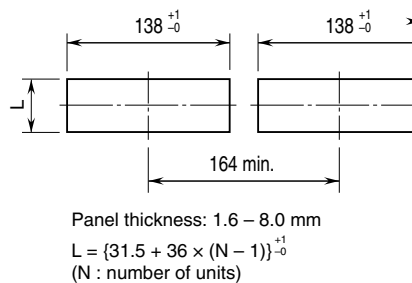

Note 1: Observe at the minimum of 3 cm above and below the units for heat dissipation.  
 Note 2: No bezel is needed when the panel is cut according to the above drawings.

### ■ USING BEZELS

Bezels are used when the unit needs to be adapted to an existing panel cutout. It is not required when the panel cutout size is as specified in the unit's data sheet (31.5 × 138 mm). Three types of bezels are selectable when ordering.

Standard type: Fits into M-System's 48 Series' panel cutout (38 × 139.5 mm)

Option /D type: Fits into DIN panel cutout (33 × 138 mm)

Option /F type: Fits into Fuji Electric PAJ, PAK, PBA, etc, panel cutout (44 × 138 mm)

Slide the top and bottom parts of the bezel into the back of the front cover as shown below.

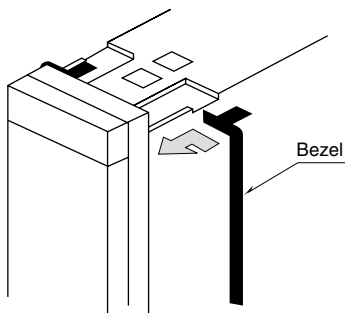

When multiple units are to be clustered side by side, insert one bezel between two units as shown below.

- When mounting two or more indicators side by side:

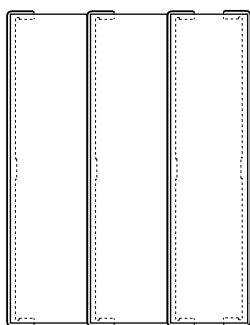

### ■ HOW TO MOUNT THE UNIT ON A PANEL

- 1) Insert the unit into the panel cutout. The watertight packing must be in place to hold the unit. Do not remove it even when the protection is not required.

The IP65 front cover protection is effective only with single mounting, with the designated cutout size (31.5 × 138 mm).

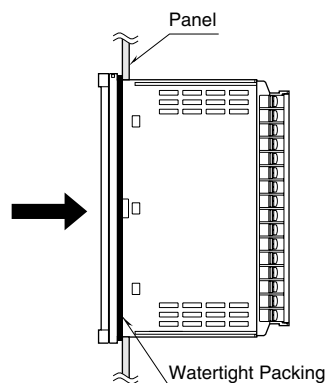

- 2) Push the mounting brackets into the grooves on top and bottom of the rear module, until they hit the panel's rear side.

Leave at least 3 centimeters both above and below the unit for ventilation.

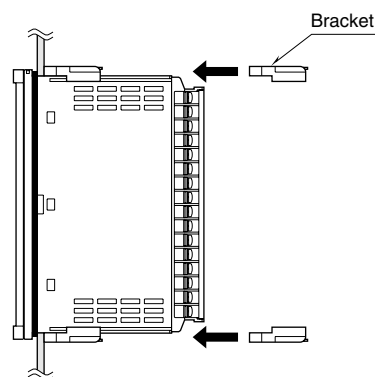

# TERMINAL CONNECTIONS

Connect the unit as in the diagram below or refer to the connection diagram on the side of the unit.

## EXTERNAL DIMENSIONS unit: mm (inch)

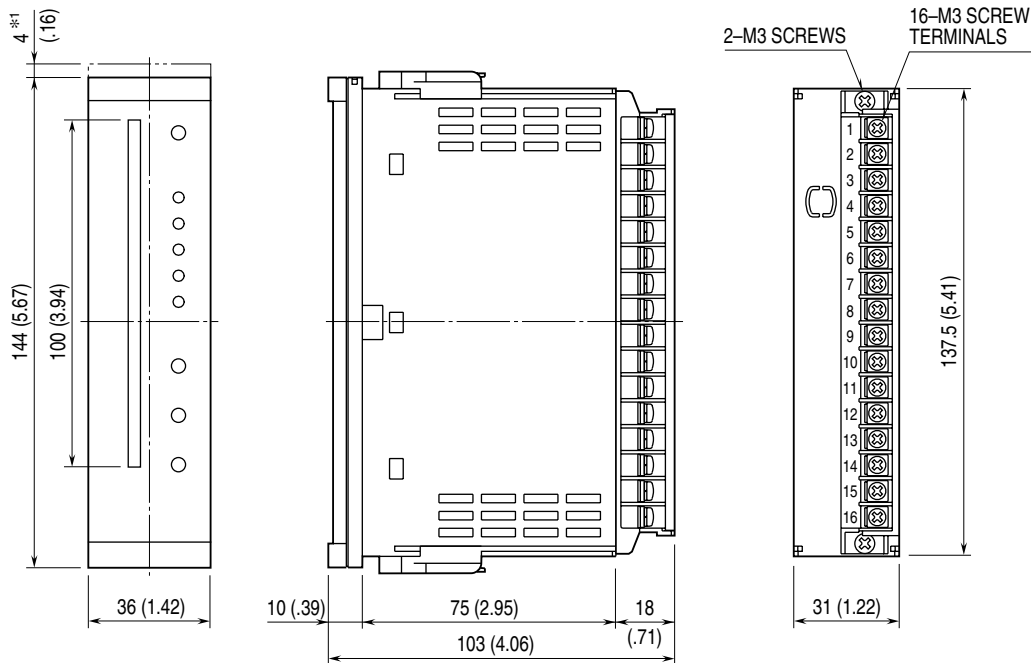

### STANDARD BEZEL \*2

### OPTION /D BEZEL \*3

### OPTION /F BEZEL \*4

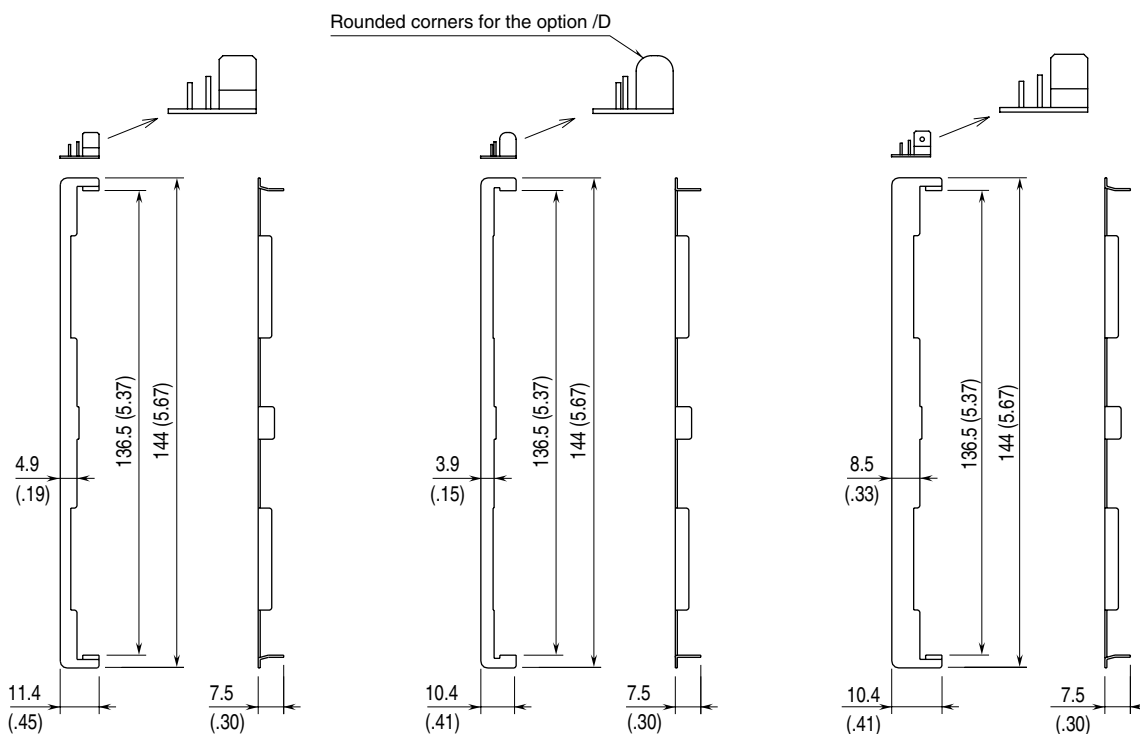

- \*1. Space required when replacing the scale plate.
- \*2. Used for the existing panel cutout of M-System 48 Series (38 × 139.5 mm).
- \*3. Used for the existing DIN panel cutout (33 × 138 mm)
- \*4. Used for the existing panel cutout of Fuji Electric PAJ, PAK, PBA (44 × 138 mm), etc.

■ CONNECTION DIAGRAM

■ ALARM OUTPUT CODE 2: 2 points

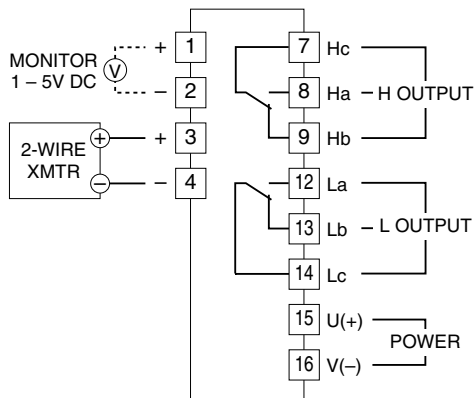

■ ALARM OUTPUT CODE 4: 4 points

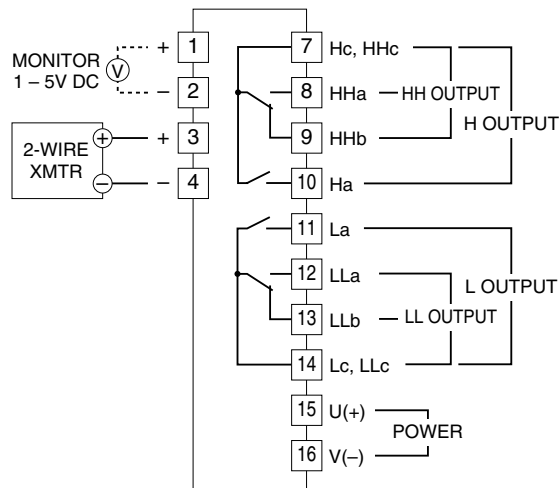

■ Relay Protection  
• AC Powered

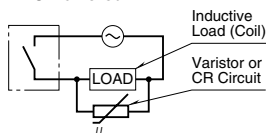

• DC Powered

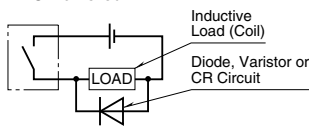

■ 4 - 20mA Input without Excitation

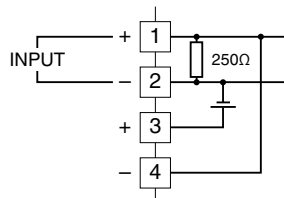

WIRING INSTRUCTIONS

■ SCREW TERMINAL

Torque: 0.6 N·m

■ SOLDERLESS TERMINAL

Refer to the drawing below for recommended ring tongue terminal size. Spade tongue type is also applicable.  
Applicable wire size: 0.25 to 1.65 mm<sup>2</sup> (AWG 22 to 16)  
Recommended manufacturer: Japan Solderless Terminal MFG.Co.Ltd, Nichifu Co.,ltd

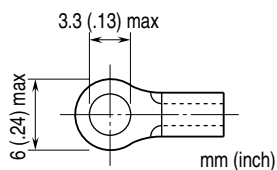

# FRONT PANEL CONFIGURATION

## ■ ALARM OUTPUT CODE 2: 2 points

### • Vertical Mounting

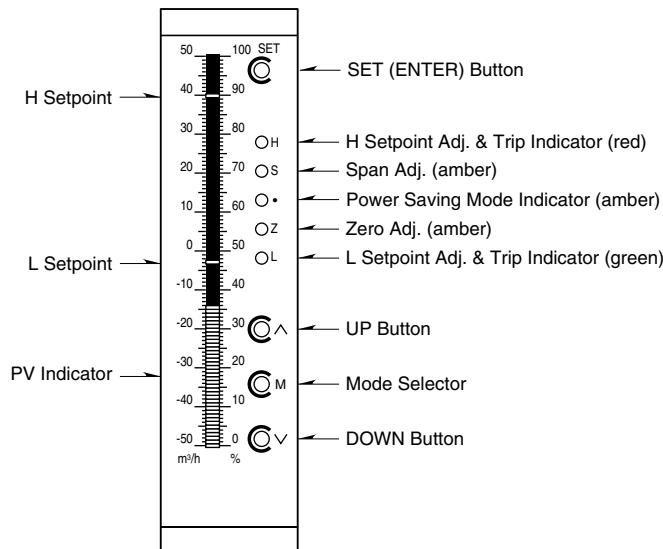

### • Horizontal Mounting

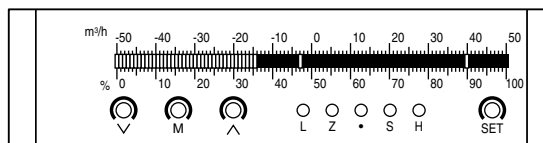

## ■ ALARM OUTPUT CODE 4: 4 points

### • Vertical Mounting

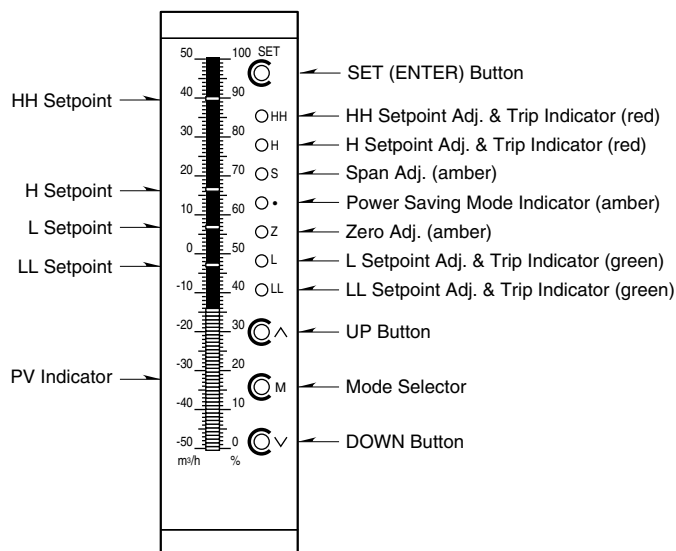

### • Horizontal Mounting

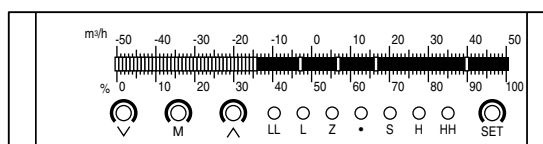

### • Bar Color Patterns

#### Pattern 1 (Bar LED color code 1)

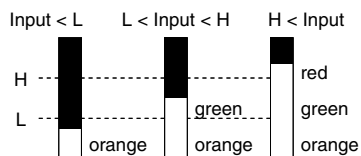

#### Pattern 2 (Bar LED color code 2)

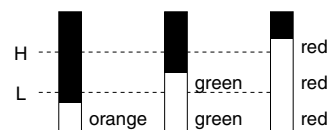

## ADJUSTMENT PROCEDURE

■ **ZERO ADJUSTMENT:** Apply 0% input signal before adjustment.



■ **SPAN ADJUSTMENT:** Apply 100% input signal before adjustment.

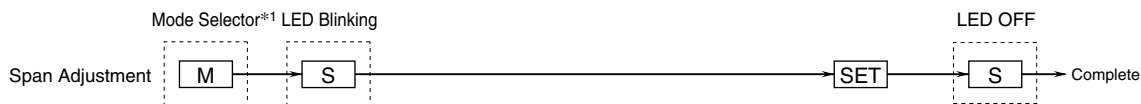

■ **ALARM SETTING:** Proceed after the zero / span adjustments.

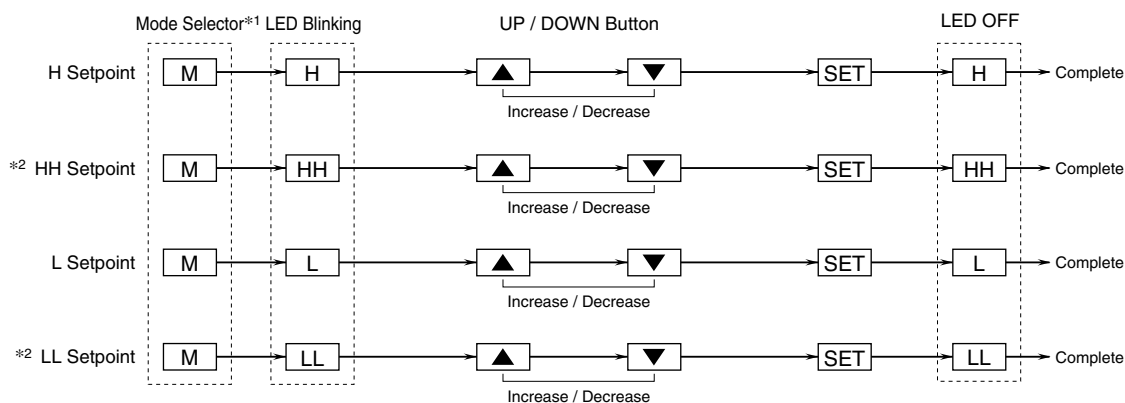

■ **POWER SAVING MODE**

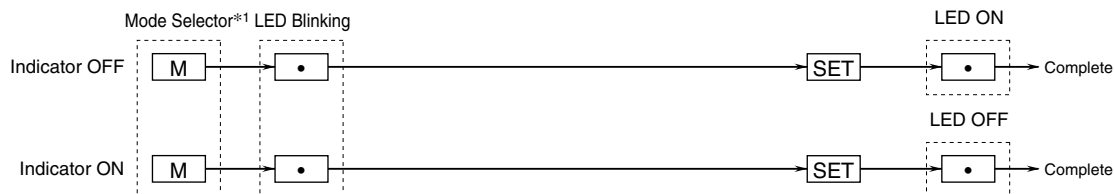

\*1. Keep pressing at least for 3 seconds to activate Mode Selector M. Press briefly for second and more times within 1 minute after it has been activated.

\*2. HH or LL setpoints are not provided for the 48NAVD-2.

Note: Each setting sequence is complete only when SET button is pressed. Once set, parameters are not lost even after the power is removed, except for the power saving mode. The power saving mode is automatically cancelled when the power is reset.

**■ ZERO ADJUSTMENT**

- 1) Apply 0% input signal.
- 2) Hold down [M] for 3 seconds\* and push [M] to choose [Z].
- 3) Press [SET], and the bargraph shows 0%.

**■ SPAN ADJUSTMENT**

- 1) Apply 100% input signal.
- 2) Hold down [M] for 3 seconds\* and push [M] to choose [S].
- 3) Press [SET], and the bargraph shows 100%.

**■ ALARM SETPOINT ADJUSTMENTS**

- 48NAVD-2: H [L setpoint] to 100%  
L 0% to [H setpoint]  
No alarm trip is selectable
- 48NAVD-4: HH [H setpoint] to 100%  
H [L setpoint] to [HH setpoint]  
L [LL setpoint] to [H setpoint]  
LL 0% to [L setpoint]  
No alarm trip is selectable

**• How to Set LL (or L, H, HH) Setpoints**

- 1) Hold down [M] for 3 seconds\* and push [M] to choose [LL].
- 2) Press [UP] or [DOWN] buttons until the indicator comes to the desired position, and press [SET].  
(Same procedure for L, H, HH setpoints)

**• How to Cancel HH and H Alarms**

- 1) Press [UP] or [DOWN] buttons until the indicator comes to the upper limit, and press [SET].  
HH indicator must be set before H as the H setpoint cannot go above the HH setpoint.

**• How to Cancel LL and L Alarms**

- 1) Press [UP] or [DOWN] buttons until the indicator comes to the lower limit, and press [SET].  
LL indicator must be set before L as the L setpoint cannot go below the LL setpoint.

\* The [M] button remain activated for 1 minute after it has been used to choose a indicator LED (programming mode). During this period, pressing the [M] button briefly is enough to choose another indicator. After 1 minute, it turns to deactivated state.

**CALIBRATION PROCEDURE**

This unit is calibrated at the factory to meet the ordered specifications, therefore you usually do not need any calibration.

For matching the indication to a receiving instrument or in case of regular calibration, adjust the output as explained in the following.

**■ HOW TO CALIBRATE THE OUTPUT INDICATION**

Use a signal source and measuring instruments of sufficient accuracy level. Turn the power supply on and warm up for more than 10 minutes.

- 1) ZERO: Apply 0% input and adjust bargraph to 0% following the procedure explained in "ADJUSTMENT PROCEDURE."
- 2) SPAN: Apply 100% input and adjust bargraph to 100% following the same procedure.
- 3) Check ZERO adjustment again with 0% input.
- 4) When ZERO value is changed, repeat the above procedure 1) – 3).

**MAINTENANCE**

Regular checking procedure is explained below:

**■ CHECKING**

Warm up the unit for at least 10 minutes. Apply 0%, 25%, 50%, 75% and 100% input signal. Check that the bargraph for the respective input signal remains within accuracy described in the data sheet. When the bargraph is out of tolerance, recalibrate the unit according to the "CALIBRATION PROCEDURE" explained earlier.

**LIGHTNING SURGE PROTECTION**

M-System offers a series of lightning surge protectors for protection against induced lightning surges. Please contact M-System to choose appropriate models.