

Digital Panel Meters 47NL Series
RTD INPUT DIGITAL PANEL METER
(4 digit, LED display type)

Model: 47NLR

OPERATING MANUAL

CONTENTS

1. INTRODUCTION	5
1.1 BEFORE USE.....	5
1.2 SAFETY PRECAUTIONS (that must be observed).....	6
1.3 POINTS OF CAUTION.....	8
1.4 COMPONENT IDENTIFICATION.....	10
1.5 INSTALLATION.....	13
1.5.1 EXTERNAL DIMENSIONS	13
1.5.2 INSTALLATION	13
1.6 WIRING INSTRUCTIONS.....	17
1.6.1 CAUTION IN WIRING	17
1.6.2 APPLICABLE WIRE	17
1.6.3 WIRING.....	17
1.6.4 TERMINAL ASSIGNMENT.....	18
1.6.5 WIRING INPUT SIGNAL.....	19
1.6.6 WIRING ALARM OUTPUTS	19
1.6.7 WIRING POWER	20
2. BASIC SETTING AND OPERATION	21
2.1 BASIC SETTING	21
2.1.1 BASIC SETTING FLOW.....	21
2.1.2 BASIC SETTING PROCEDURE.....	21
2.2 BASIC SETTING OPERATION AND INSTRUCTIONS	22
2.2.1 BASIC SETTING OPERATION.....	22
2.2.2 INSTRUCTIONS ON BASIC OPERATION.....	23
3. SETTING TEMPERATURE UNIT	24
3.1 OPERATING PROCEDURE.....	24
4. SETTING DECIMAL POINT POSITION	26
4.1 OPERATING PROCEDURE.....	26
5. OPERATION	28
6. PARAMETER CONFIGURATION	29

7. SETTING ALARM OUTPUT	33
7.1 ALARM POINT	36
7.1.1 OPERATING PROCEDURE	36
7.2 ALARM SETPOINT	37
7.2.1 ALARM SETPOINT DEFAULT VALUE	37
7.2.2 ALARM SETPOINT LIST.....	37
7.2.3 OPERATING PROCEDURE.....	38
7.3 TRIP ACTION (LO/HI)	40
7.3.1 OPERATING PROCEDURE.....	40
7.4 DEADBAND	42
7.4.1 OPERATING PROCEDURE.....	42
7.5 TRIP DELAY	44
7.5.1 OPERATING PROCEDURE.....	44
7.6 ALARM OUTPUT LOGIC (coil energized or de-energized at alarm).....	46
7.6.1 OPERATING PROCEDURE.....	46
7.7 MAIN DISPLAY BLINKING AT ALARM	48
7.7.1 OPERATING PROCEDURE	48
8. AVERAGING INPUT	50
8.1 OPERATING PROCEDURE	51
9. ADJUSTING BRIGHTNESS OF DISPLAY.....	52
9.1 OPERATING PROCEDURE	53
10. GOING BACK AUTOMATICALLY TO MEASURING MODE	55
10.1 OPERATING PROCEDURE	56
11. SETTING BURNOUT	58
11.1 OPERATING PROCEDURE.....	58
12. ADJUSTING DISPLAY REFRESHING RATE	60
12.1 OPERATING PROCEDURE	61
13. USEFUL FUNCTIONS.....	63
13.1 CONFIRMING ALARM SETPOINTS.....	63
13.2 RETAINING MAX AND MIN VALUES	64
13.3 LIMITING BUTTON OPERATION	66
13.3.1 OPERATING PROCEDURE	66
13.4 TRANSITION TIME TO LOCKOUT SETTING MODE.....	68
13.4.1 OPERATING PROCEDURE	68

14. USER CALIBRATION	70
14.1 INPUT COMPENSATION	70
14.1.1 INPUT COMPENSATION FLOW.....	70
14.1.2 OPERATING PROCEDURE.....	71
15. INSPECTION / CLEANING	73
16. TROUBLESHOOTING	74
16.1 ERROR MESSAGES.....	74
16.2 INITIALIZING SETTING VALUES.....	74
16.2.1 OPERATING PROCEDURE	74
16.3 CONFIRMING FIRMWARE VERSION	76
16.3.1 OPERATING PROCEDURE	76
17. APPENDICES.....	77
17.1 SPECIFICATIONS	77
17.2 MODEL NUMBERING.....	79
17.3 PARAMETER LIST	80
17.4 PARAMETER MAP.....	82
17.4.1 OPERATION IN MEASURING MODE.....	82
17.4.2 INITIAL SETTING MODE.....	83
17.4.3 ALARM SETTING MODE.....	84
17.4.4 ADVANCED SETTING MODE.....	85
17.4.5 LOCKOUT SETTING MODE.....	86
17.5 CHARACTER SET	87

1. INTRODUCTION

1.1 BEFORE USE....

Thank you for choosing us. Before use, please check contents of the package you received as outlined below.

■ PACKAGE INCLUDES

Digital panel meter

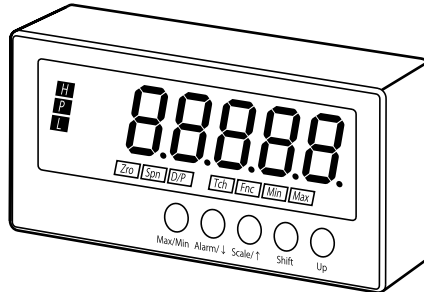

Accessories

<p>Watertight packing (1)</p>	<p>Magnet label sheet (1)</p>	<p>Stopper (1)</p>	<p>Unit fixing screw (4)</p> <p>(screw size: M4 x 10)</p>																																																																	
<p>Engineering unit sticker label sheet (1)</p> <table border="1" data-bbox="264 1339 437 1668"> <tbody> <tr><td>DC</td><td>AC</td><td>mV</td></tr> <tr><td>V</td><td>kV</td><td>μA</td></tr> <tr><td>mA</td><td>A</td><td>kA</td></tr> <tr><td>mW</td><td>W</td><td>kW</td></tr> <tr><td>var</td><td>kvar</td><td>Mvar</td></tr> <tr><td>VA</td><td>kVA</td><td>Ω</td></tr> <tr><td>kΩ</td><td>MΩ</td><td>cm</td></tr> <tr><td>mm</td><td>m</td><td>m/sec</td></tr> <tr><td>mm/min</td><td>cm/min</td><td>m/min</td></tr> <tr><td>m/h</td><td>m/s²</td><td>inch</td></tr> <tr><td>l</td><td>l/s</td><td>l/min</td></tr> <tr><td>l/h</td><td>m²</td><td>m²/sec</td></tr> <tr><td>m³/min</td><td>m³/h</td><td>Nm/h</td></tr> <tr><td>N · m</td><td>N/m²</td><td>g</td></tr> <tr><td>kg</td><td>kg/h</td><td>N</td></tr> <tr><td>kN</td><td>Pa</td><td>kPa</td></tr> <tr><td>MPa</td><td>t</td><td>t/h</td></tr> <tr><td>°C</td><td>°F</td><td>%RH</td></tr> <tr><td>J</td><td>kJ</td><td>MJ</td></tr> <tr><td>rpm</td><td>sec</td><td>min</td></tr> <tr><td>pH</td><td>%</td><td>ppm</td></tr> <tr><td colspan="3">NXXXXXX</td></tr> </tbody> </table>	DC	AC	mV	V	kV	μA	mA	A	kA	mW	W	kW	var	kvar	Mvar	VA	kVA	Ω	kΩ	MΩ	cm	mm	m	m/sec	mm/min	cm/min	m/min	m/h	m/s ²	inch	l	l/s	l/min	l/h	m ²	m ² /sec	m ³ /min	m ³ /h	Nm/h	N · m	N/m ²	g	kg	kg/h	N	kN	Pa	kPa	MPa	t	t/h	°C	°F	%RH	J	kJ	MJ	rpm	sec	min	pH	%	ppm	NXXXXXX			<p>Instruction manual</p>	<p>Ordering Information Sheet</p> <p>(included with the option code 'SET' only)</p>
DC	AC	mV																																																																		
V	kV	μA																																																																		
mA	A	kA																																																																		
mW	W	kW																																																																		
var	kvar	Mvar																																																																		
VA	kVA	Ω																																																																		
kΩ	MΩ	cm																																																																		
mm	m	m/sec																																																																		
mm/min	cm/min	m/min																																																																		
m/h	m/s ²	inch																																																																		
l	l/s	l/min																																																																		
l/h	m ²	m ² /sec																																																																		
m ³ /min	m ³ /h	Nm/h																																																																		
N · m	N/m ²	g																																																																		
kg	kg/h	N																																																																		
kN	Pa	kPa																																																																		
MPa	t	t/h																																																																		
°C	°F	%RH																																																																		
J	kJ	MJ																																																																		
rpm	sec	min																																																																		
pH	%	ppm																																																																		
NXXXXXX																																																																				

■ MODEL NO.

Confirm Model No. marking on the product to be exactly what you ordered.



1.2 SAFETY PRECAUTIONS (that must be observed)

The following signs are used in this manual to provide precautions required to ensure safe usage of the unit. Please understand these signs and graphic symbols, read the manual carefully and observe the description.

The following signs show seriousness of safety hazard or damage occurred when used wrongly with the signs ignored.

 WARNING	Indicates a potentially hazardous situation which, if not avoided, may result in serious injury or death.
--	---

 CAUTION	Indicates a potentially hazardous situation which, if not avoided, may result in injury or in property damage.
--	--

 Indicates prohibitions.	 Indicates mandatory cautions.	 Indicates cautions.
---	---	---

WARNING



CAUTION

For safety, make sure that wiring is performed by qualified personnel only.

- Failure to do so may result in a fire, electric shock or injury.



CAUTION
ELECTRIC SHOCK

Do not touch the terminals while the power is on.

- Doing so may result in electric shock.



MANDATORY
CAUTION

Check the connection diagram carefully before wire connection.

- Failure to do so may result in malfunction, a fire or electric shock.



MANDATORY
CAUTION

Provide safety measures outside of the unit to ensure safety in the whole system if an abnormality occurs due to malfunction of the unit or another external factor affecting the unit's operation.



PROHIBITION
TO BE WET

Do not splash water on the unit except for the front panel installed correctly.

- Doing so may result in a fire, electric shock or injury.



MANDATORY
CAUTION

Stop using the unit immediately if smokes, unusual smell or abnormal noises come(s) from it.

- Using the unit continuously may result in a fire or electric shock.



MANDATORY
CAUTION

Stop using the unit if it is dropped or damaged.

- Using the unit continuously may result in a fire or electric shock.



PROHIBITION

Do not throw the unit into the fire.

- Doing so may result in rupture of the electronic component.

CAUTION



PROHIBITION
TO DISCOMPOSE

- Never discompose or remodel the unit.
- Doing so may result in electric shock, malfunction or injury.



PROHIBITION

- Do not connect or remove the unit while its power is on.
- Doing so may result in electric shock, malfunction or injury.



MANDATORY
CAUTION

- Do not allow fine shavings or wire scraps to enter the unit in machining screws or wiring.
- Doing so may result in malfunction of the unit.



PROHIBITION

- Do not press buttons with a pointed object.
- Doing so may result in malfunction of the unit.



PROHIBITION

- Do not pull the wires connecting to the unit.
- Doing so may result in electric shock, damage of the unit or injury.



PROHIBITION

- Do not use the unit in the atmosphere where combustible gas is present.
- Doing so may result in inflammation, ignition or smoke.

1.3 POINTS OF CAUTION

■ CONFORMITY WITH EU DIRECTIVES

- Our products conforming to the EU Directives conforms to the standards required based on the premise that they are built into various equipment, apparatus or control panels to use. Because the EMC performance depends on the configuration, wiring or arrangement of the equipment, apparatus and control panels you build, it is necessary for you to make such equipment, apparatus or control panels to conform finally to the CE Marking by yourselves.

CAUTION

This product conforms to the EMC Directive for electrical and electronic apparatus intended for use in industrial environments. If it is used in the residential environments, it may cause radio interference, and the user is requested to take appropriate measures.

■ ENVIRONMENT

Install the unit within the installation specifications.

- Indoors use.
- Environmental temperature must be within -10 to +55°C (14 to 131°F) with relative humidity within 10 to 90% RH without condensing.
- Provide sufficient space around the unit for heat dissipation.
- For screw mounting, mount the unit to a panel between 1.0 and 3.2 mm thick.
- Install the unit in a well-ventilated place in order to prevent internal temperature rise.
- Refer to “Clustered mounting” to install several units. In mounting the unit with other equipment side by side, provide sufficient space between them, according to the dimensions in the clustered mounting.
- Do not use the unit under the following environments:
 - Where the unit is exposed to direct sunlight, rain or wind. (The unit is not designed for outdoor use.)
 - Where condensation may occur due to extreme temperature changes.
 - Where corrosive or flammable gas is present.
 - Where heavy dust, iron powder or salt is present in the air.
 - Where organic solvent such like benzene, thinner, and alcohol, or strong alkaline materials such like ammonia and caustic soda may attach to the unit, or where such materials are present in the air.
 - Where the unit is subject to continuous vibration or physical impact.
 - Where there are high-voltage lines, high-voltage equipment, power lines, power equipment, equipment with transmission unit such like a ham radio equipment, or equipment generating large switching surges around the unit.

■ WIRING

- In order to prevent potential electric shock, wire the unit after turning off the power supply and making sure that the power is not supplied to the cable.
- Be sure to confirm the name and polarity of each terminal before wiring to it.
- Do not connect anything to unused terminals.

■ HANDLING CAUTIONS

- The unit is designed to function as soon as power is supplied, however, a warm up for 10 minutes is required for satisfying complete performance described in the data sheet.
- Use the unit within the noted supply power voltage and rated load.
- The last measured values are held in mode transition. Take this into consideration when configuring the control system.
- Clean the surface of the unit with wet soft cloth. Do not use organic solvent such like benzene, thinner and alcohol. Doing so may result in deformation or discoloration of the unit.
- When abnormality is found such like smokes, unusual smell and abnormal noises coming from the unit, immediately cut the power supply and stop using it.

■ TO ENSURE DUSTPROOF AND WATERPROOF (degree of protection IP66)

To ensure dustproof and waterproof for front panel follow conditions below.

- Only screw mounting conforms.
- Observe the designated panel cutout size (30.5 mm dia.) specified by us.
- The watertight packing included in the product package must be placed between the body and panel when installing on the panel.
- Fasten the body and panel together with four M4 × 10 screws (torque: 0.6 – 0.9 N·m).

- After installation, confirm that there are no following abnormalities.
 - The packing is contorted.
 - There are some spaces between front panel and panel.
 - The packing is run off the edge.
 - The packing is cut off.
 - There are foreign objects sticking.
- When replacement of the watertight packing is needed, consult us.

1.4 COMPONENT IDENTIFICATION

■ FRONT VIEW

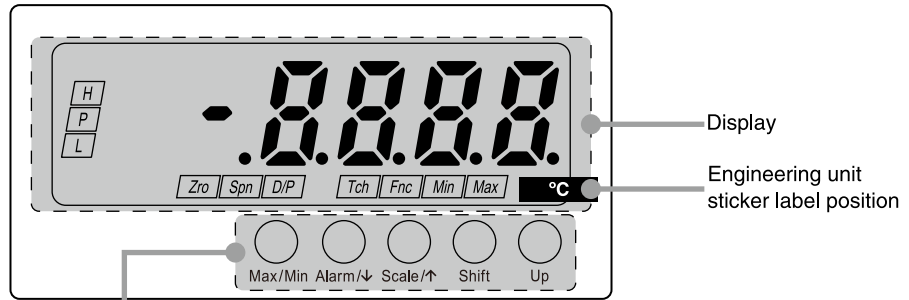

BUTTON	FUNCTION
Max/Min	Used to switch the main display to show the present value, MAX value or MIN value, and to reset the MAX and MIN values. Also used to cancel a set item.
Alarm/↓	Used to confirm the alarm setpoints, to move on to the alarm and other setting modes, or to shift through setting items in each setting mode.
Scale/↑	Used to move on to the initial and other setting modes, or to shift through setting items in each setting mode.
Shift	Used to move on to the setting standby status of each setting mode and to shift through display digits in each setting item.
Up	Used to change setting values in a setting standby mode.

NOTE

- The engineering unit sticker label position is our recommended position.
- When an engineering unit is specified by the Ordering Information Sheet, the unit(s) will be shipped with the sticker label put on the above position.

■ DISPLAY

COMPONENT	FUNCTION
Main display	Indicates present, MAX and MIN values, parameters, setting values and error codes.

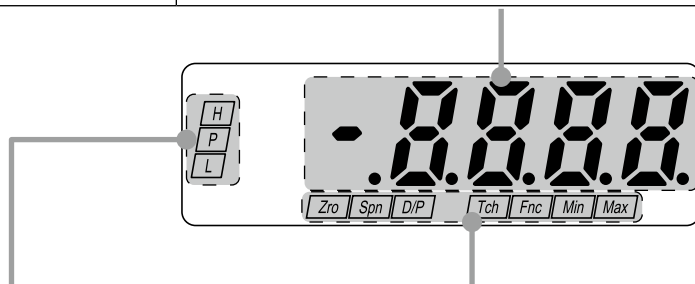

INDICATOR	MODE	FUNCTION
Alarm	Setting	Indicates parameters in Alarm Setting Mode. (Refer to 7. SETTING ALARM OUTPUT.)
	Confirming alarm setpoints	'H' or 'L' indicator blinks in confirming each alarm setpoint. (Refer to 13.1 CONFIRMING ALARM SETPOINTS.)
	Measuring	Indicates the comparison result between alarm setting values and present values. 'H' indicator turns on when the H alarm is tripped. 'L' indicator turns on when the L alarm is tripped. 'P' indicator turns on when none of the other alarms is tripped.

INDICATOR	MODE	FUNCTION
Function	Setting	Indicates parameters in each mode. 'Zro', 'Spn', 'D/P', 'Tch' and 'Fnc' indicators turn on in combination depending on the parameters. 'Max' and 'Min' indicators blink when a parameter is within invalid range while setting.
	Measuring	Indicates MAX or MIN value. 'Max' or 'Min' indicator turns on. (Refer to 13.2 RETAINING MAX AND MIN VALUES.)

■ TOP VIEW

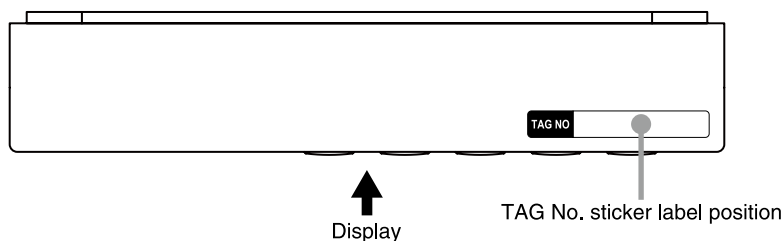

NOTE

- The tag No. label sticker position is our recommended position.
- When a tag No. is specified, the unit(s) will be shipped with the tag No. sticker label put on the above position. Max. 17 alphanumeric characters can be specified. Please consult us.

■ BOTTOM VIEW

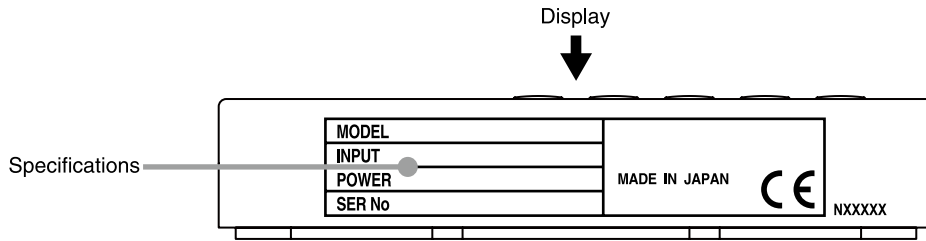

NOTE

Contents of the specification label depend on the specifications.

■ REAR VIEW

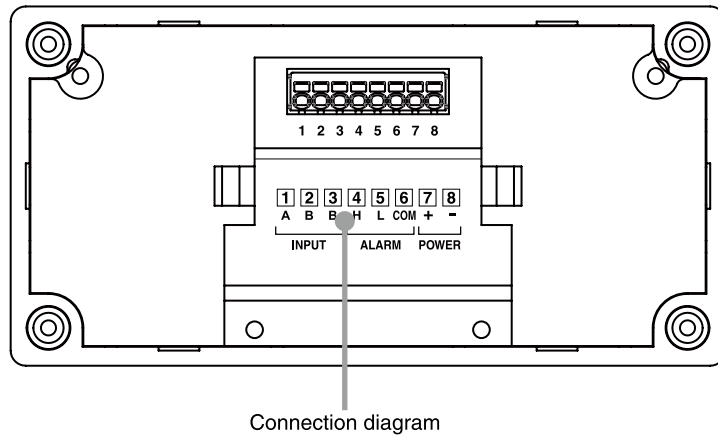

1.5 INSTALLATION

1.5.1 EXTERNAL DIMENSIONS

unit: mm (inch)

■ FRONT VIEW

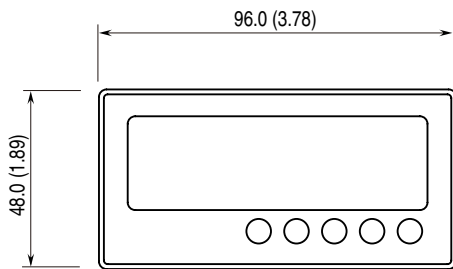

■ SIDE VIEW

• SCREW MOUNTING

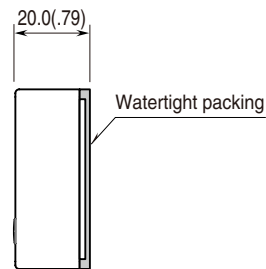

• MAGNET MOUNTING

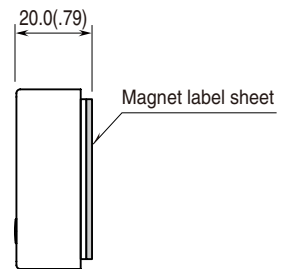

■ REAR VIEW

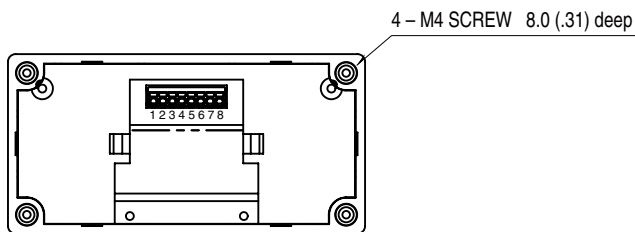

1.5.2 INSTALLATION

■ PANEL MOUNTING (Conform to degree of protection IP66)

Panel cutout must be such as specified by us.

• Single Mounting

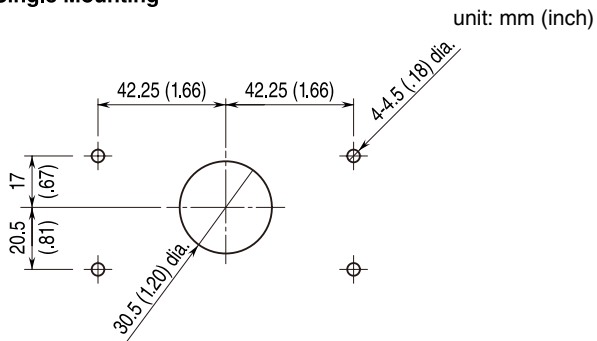

• Clustered Mounting

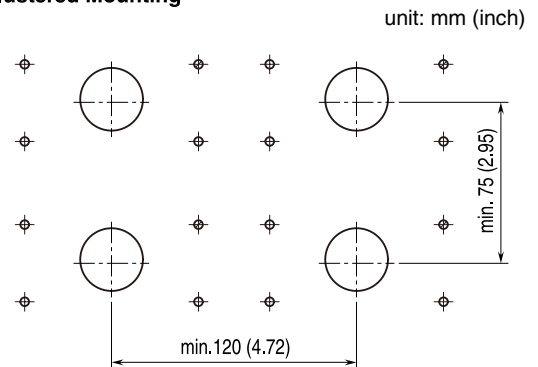

IMPORTANT

Remove burrs from the panel cut surface so that they may not damage the wires.

Use watertight packing and unit fixing screws included in the product package.
Fix the unit to the panel before wiring according to the following procedure.

Panel thickness: 1.0 – 3.2 mm

(1) Mount the watertight packing to the body. Fit the concave part of the watertight packing in the convex part of the body.

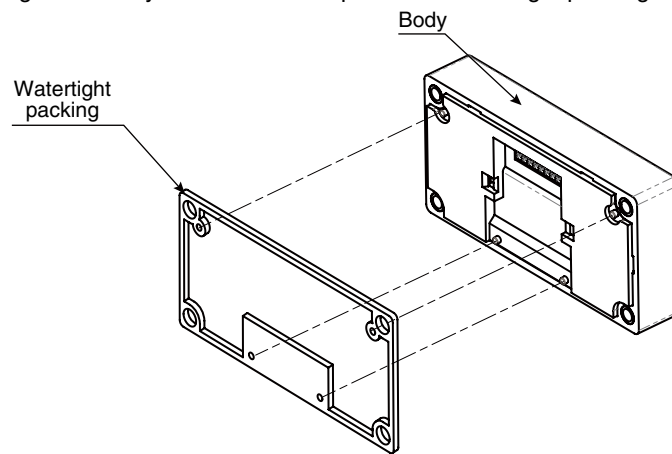

(2) Fix the screws (M4 × 10) to the panel.

Torque: 0.6 – 0.9 N·m

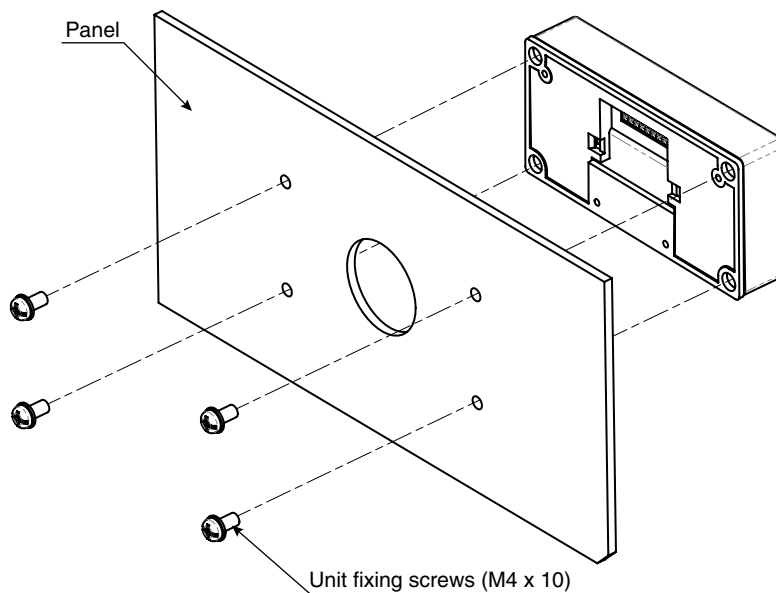

IMPORTANT

To conform to degree of protection IP66, confirm visually that the packing is not contorted, cut off or excessively run off the edge after installation.

■ **MAGNET MOUNTING** (Not conform to degree of protection IP66)

Panel cutout is not required.

Use magnet sheet and stopper included in the product package.

Follow the instruction below to fix the unit after wiring.

- (1) Tear off a protective seal, and attach it to the unit.

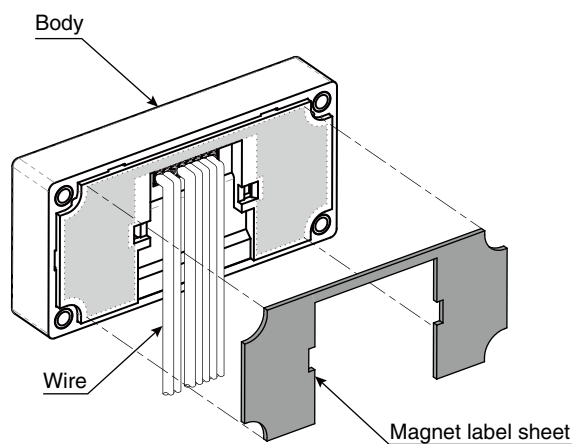

- (2) Attach the stopper to the unit to fix the wire.

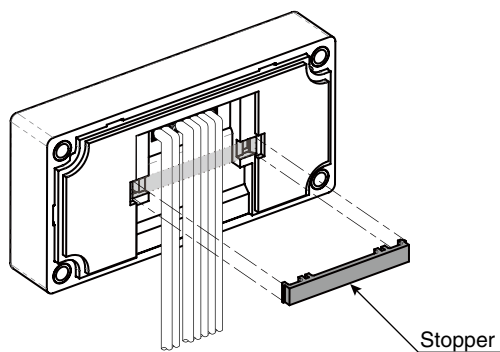

(3) Fix the unit to an iron panel.

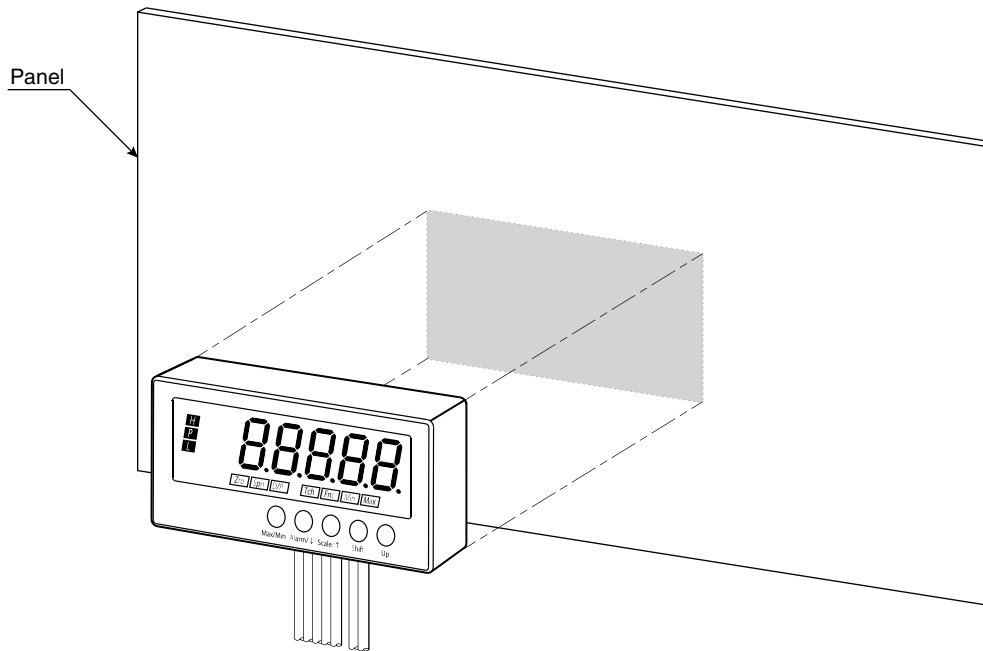

IMPORTANT

- For magnet mounting, DO NOT use where it is subjected to continuous vibration or DO NOT subject the unit to physical impact.
- The sheath of wire must be 2 mm² or less.

• Clustered Mounting

unit: mm (inch)

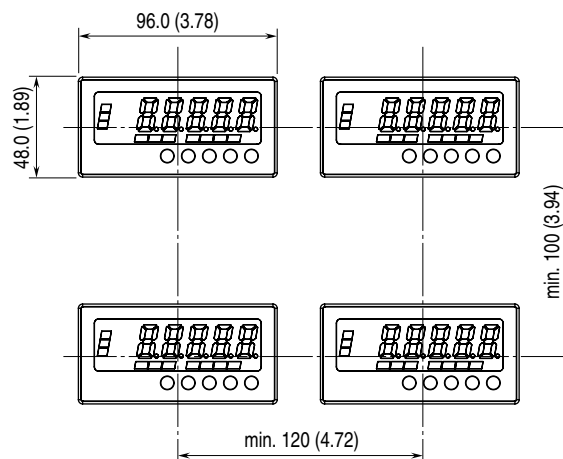

1.6 WIRING INSTRUCTIONS

1.6.1 CAUTION IN WIRING

- For safety, make sure that wiring is performed by qualified personnel only.
- In order to prevent potential electric shock, wire the unit after turning off the power supply and making sure that the power is not supplied to the cable.
- Be sure to confirm the name and polarity of each terminal before wiring to it.
- Do not connect anything to unused terminals.
- We offer a series of lightning surge protectors for protection against induced lightning surges. Please contact us to choose appropriate models.

1.6.2 APPLICABLE WIRE

- Applicable wire size: 0.2 – 0.5 mm²
- Stripped length: 6 mm (0.24")

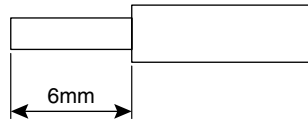

IMPORTANT

- Tinning wire ends may cause contact failure and therefore is not recommended.
- Do not use insulating sleeve when solderless terminal (ferrule) is used.
- When mounting with magnet, the sheath of wire must be 2 mm² or less.

1.6.3 WIRING

Use minus screwdriver to connect wire(s) to a tension clamp terminal block.

Blade edge: 0.4 mm (0.02")

Blade width: 2 mm (0.08")

Procedures are as follows.

- (1) Insert a minus screwdriver into the dead end to open the spring.

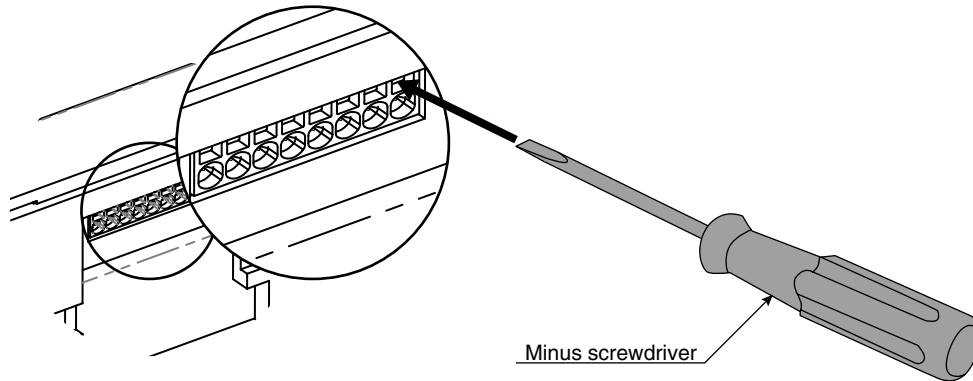

(2) Insert wire(s) deeply.

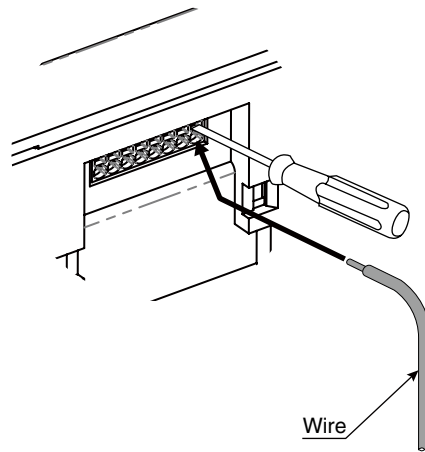

(3) Pull out the minus screwdriver to fix wire(s).

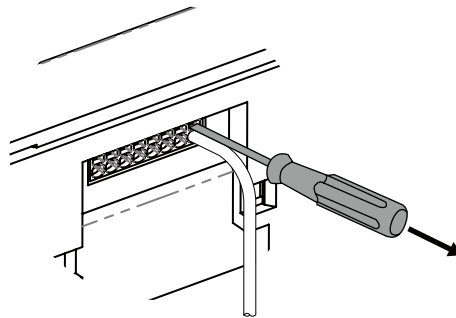

IMPORTANT

- Take measures to prevent the sheath of wire from being caught in terminal(s) to avoid contact failure.
- Pull the wire(s) lightly to confirm that the wire is not pulled off.

1.6.4 TERMINAL ASSIGNMENT

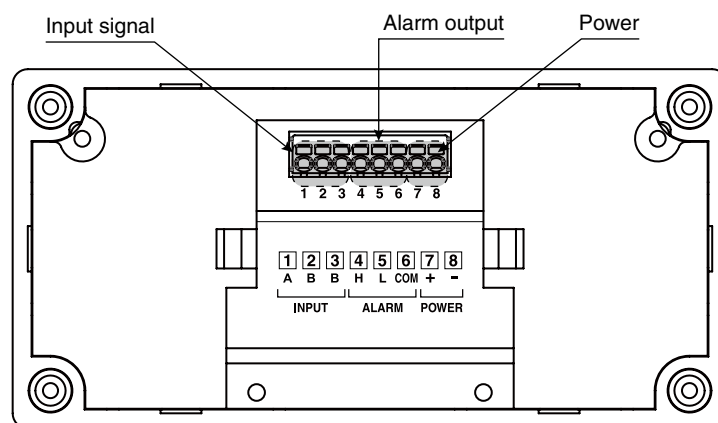

1.6.5 WIRING INPUT SIGNAL

Connect a RTD.

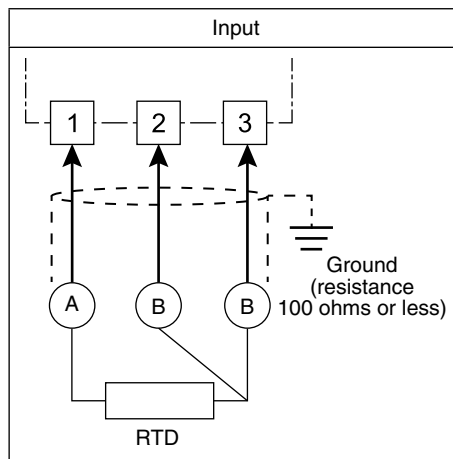

IMPORTANT

- Use wires of the same type, width and length.
- The leadwire resistance including internal resistance such like a lightning surge protector and a barrier must be maximum 60 Ω per wire.
- The excitation is 0.5 mA (0.05 mA for Pt 1000). Use a RTD with excitation 0.5 mA or more.
- Take measures to reduce noise as much as possible, e.g. by using shielded twisted pair wires for the input signal. Ground the input shield to the most stable earth to prevent noise troubles.

1.6.6 WIRING ALARM OUTPUTS

Two alarm contacts are output.

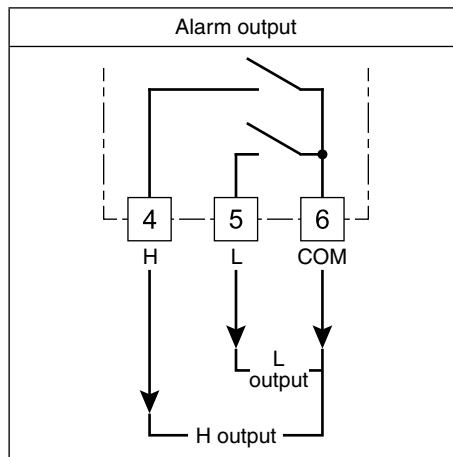

IMPORTANT

- Connect load within the specifications.
- With inductive load such like an external relay or a motor, insert a CR circuit, a diode or a varistor in parallel to protect the contacts and eliminate noise.

NOTE

Example of contact protection circuit with inductive load

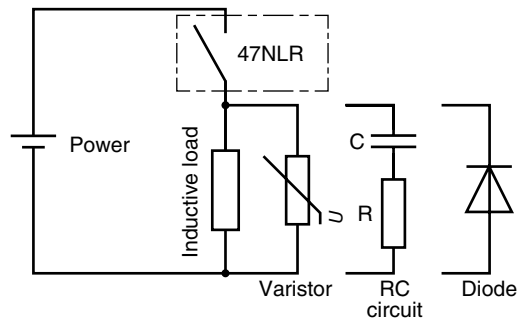

1.6.7 WIRING POWER

Connect DC power. DC power specifications are as shown in the following table.

CODE	RATING	PERMISSIBLE RANGE
R	24 V DC	±10% 0.7 W or less

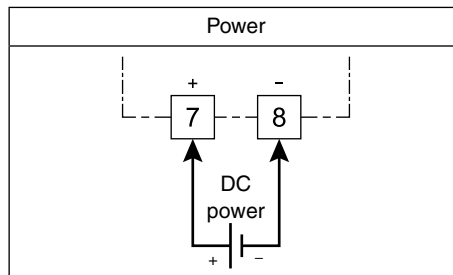

IMPORTANT

- For safety, make sure that wiring is performed by qualified personnel only.
- In order to prevent potential electric shock, wire the unit after turning off the power supply and making sure that the power is not supplied to the cable.
- Be sure to confirm the polarity in wiring.

2. BASIC SETTING AND OPERATION

2.1 BASIC SETTING

This section describes flow and procedure of the basic setting.

The following shows the flow and procedure to set the temperature unit and the decimal point as an example. In using '°C' as temperature unit and '1 decimal place' as decimal point position, setting is not necessary.

2.1.1 BASIC SETTING FLOW

The basic setting is as shown in the following flowchart.

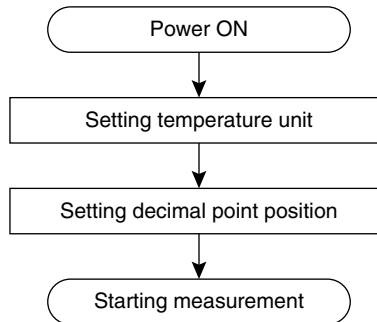

2.1.2 BASIC SETTING PROCEDURE

The following shows the procedure to set the temperature unit to '°C' and the decimal point position to 'no decimal point' as an example. Set a temperature unit and decimal point position actually used. Refer to 3. SETTING TEMPERATURE UNIT and after for details of setting.

■ PARAMETER LIST FOR BASIC SETTING

Parameters used in the basic setting are as shown in the following table.

PARAMETER	SETTING VALUE	FUNCTION INDICATOR	SETTING
Temperature unit	C	Fnc	Temperature indication in °C
Decimal point position	DOFF	D/P, Fnc	No decimal point

■ BASIC SETTING PROCEDURE

The basic setting procedure is as follows.

- 1 Confirm the wiring, turn on the power and move on to Initial Setting Mode (measurement stopped).**
 - Hold down Scale/↑ button for 3 seconds or more.
- 2 Set temperature unit.**
 - Press Shift button to shift the display into the setting standby mode and Up button to select the temperature unit.
- 3 Set decimal point position.**
 - Press Alarm/↓ or Scale/↑ button to apply the new setting and go to the next or previous parameter setting.
 - Press Shift button to shift the display into the setting standby mode and Up button to select the decimal point position.
- 4 Return to Measuring Mode (measurement started).**
 - Hold down Alarm/↓ or Scale/↑ button for 3 seconds or more to apply the new setting and return to Measuring Mode.

2.2 BASIC SETTING OPERATION AND INSTRUCTIONS

This section describes basic operation and instructions when setting parameters.

2.2.1 BASIC SETTING OPERATION

Parameters can be grouped into two setting types, “numerical value setting” and “setting value selection.” Basic operation of each type is as shown below.

■ NUMERICAL VALUE SETTING

1 Press Shift button to shift the display into the setting standby mode.

- The most significant digit starts blinking.

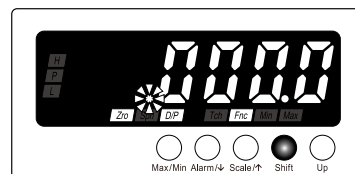

2 Press Shift and Up buttons to set a numerical value.

- Press Shift button to go to the next digit.
- Press Up button to change the blinking value.

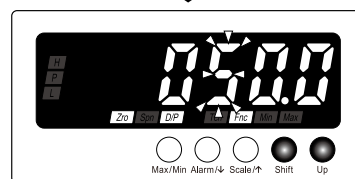

3 Press Alarm/↓ or Scale/↑ button to apply the new setting.

- The next or previous parameter setting is indicated.

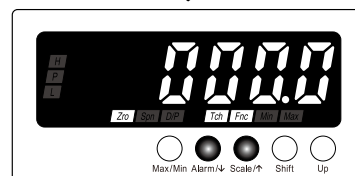

*1 Display depends on the settings.

NOTE

■ SHIFTING DIGITS

Each time pressing Shift button, the blinking digit moves to the right.

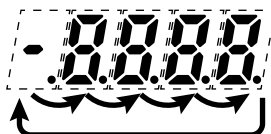

■ SETTING A NUMERICAL VALUE

- Each time pressing Up button, the numeral is incremented by 1. In setting an alarm setpoint, the indication following '9' will be '-'.
- The negative sign (-) must be set to the leftmost digit. For example, set '-040.0' instead of '-40.0'.



■ SETTING VALUE SELECTION

1 Press Shift button to shift the display into the setting standby mode.

- The current set value starts blinking.

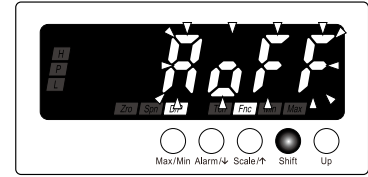

2 Press Up button to select your desired setting value.

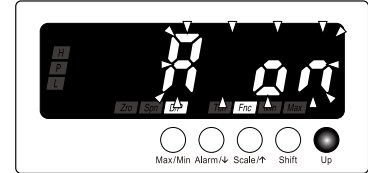

3 Press Alarm/↓ or Scale/↑ button to apply the new setting.

- The next or previous parameter setting is indicated.

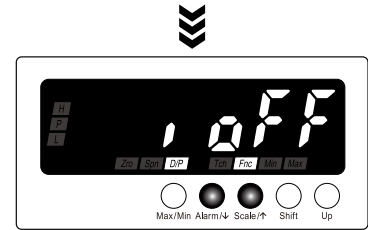

*1 Display depends on the settings.

2.2.2 INSTRUCTIONS ON BASIC OPERATION

■ INVALID PARAMETERS

- 'Max' and 'Min' indicators start blinking in setting the negative sign (-) to a digit other than the leftmost one. Return the setting within the valid range.

■ IF THE FRONT BUTTONS ARE LEFT UNTOUCHED...

- The display goes back automatically to Measuring Mode without applying the last changes after the specified time period (default: 60 sec.) while it is in the setting standby mode.
- The display goes back automatically to Measuring Mode after the specified time period (default: 60 sec.) while it is in one of the other modes.
- The setting time out is configurable. (Refer to 10. GOING BACK AUTOMATICALLY TO MEASURING MODE.)

■ TO ABORT A SETTING...

- Hold down Max/Min button for 3 seconds or more to return to Measuring Mode without applying the last changes while the display is in the setting standby mode.
- If you get lost in a setting mode, you can execute initialization. (Refer to 16.2 INITIALIZING SETTING VALUES.)

■ IN MOVING ON TO EACH SETTING MODE FROM MEASURING MODE

- The last values of the alarm outputs before mode transition are held.

■ ORDER TO DISPLAY PARAMETERS

- Refer to 6. PARAMETER CONFIGURATION for details.

3. SETTING TEMPERATURE UNIT

The temperature indication in °C ('C') or °F ('F') can be selected. The default value is °C.

IMPORTANT

- When the temperature unit is changed, the set alarm setpoints are discarded and reset to '-----'. It is recommended to record the setpoints as necessary.
- When the temperature unit is changed, the input compensation A input/compensation values and input compensation B input/compensation values are initialized. It is recommended to record the values as necessary.

3.1 OPERATING PROCEDURE

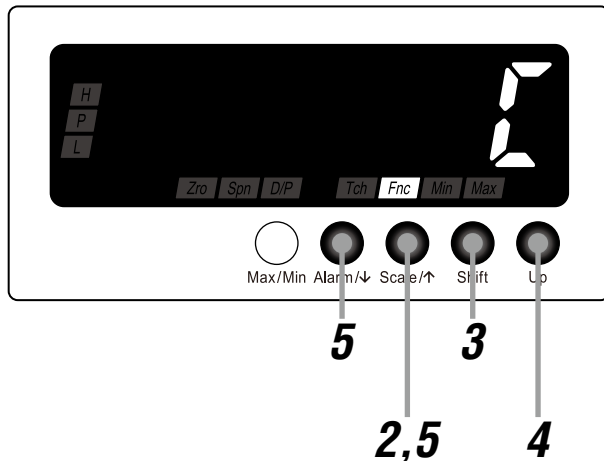

NOTE

- Procedures to change 'F' to 'C' are described here.
- To change 'C' to 'F', the procedures are the same. Select 'F' in Step 4.

1 Confirm the wiring, and turn on the power.

- All the indications turn on for approximately 5 seconds and then the display moves on to Measuring Mode.

NOTE

- Indication 'S.ERR' may blink, which shows the input out of the measurable range and does not show the unit failure.
- Indication 'B.ERR' may blink, which shows the input open and does not show the unit failure.

- Immediately after power on (all indicators on)



- Measuring Mode

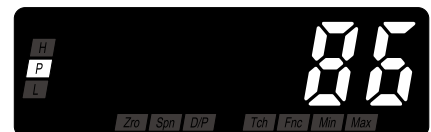

*1 Display depends on the settings and input.

2 Hold down Scale/↑ button for 3 seconds or more to move on to Initial Setting Mode.

- 'F' is indicated.
- 'Fnc' indicator turns on.



NOTE

Skip to Step 6 if the default value is acceptable.

3 Press Shift button to shift the display into the setting standby mode.

- The indication starts blinking, to which you can apply changes.

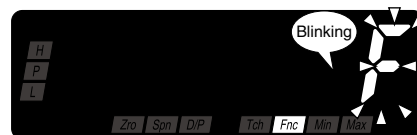

4 Press Up button to select 'C'.



5 Press Alarm/↓ or Scale/↑ button to apply the new setting.

- And the next parameter setting is indicated.

NOTE

- Press Alarm/↓ button, and the decimal point position 'D ON' or 'DOFF' will be indicated depending on the setting.
- Press Scale/↑ button, and the input compensation B compensation value will be indicated within the range of -9999 to 9999 depending on the setting.

6 ■ TO GO ON TO SET THE DECIMAL POINT POSITION,
Skip to Step 3 in "4. SETTING DECIMAL POINT POSITION".

■ TO QUIT,

Hold down Alarm/↓ or Scale/↑ button for 3 seconds or more to return to Measuring Mode.

NOTE

■ IF THE FRONT BUTTONS ARE LEFT UNTOUCHED...

- The display goes back automatically to Measuring Mode without applying the last changes after the setting time out period (default: 60 sec.) in the setting standby mode (indication blinking in Step 3 and 4).
- The display goes back automatically to Measuring Mode after the setting time out period (default: 60 sec.) in one of the other modes.
- The setting time out is configurable. (Refer to 10. GOING BACK AUTOMATICALLY TO MEASURING MODE.)

■ TO ABORT A SETTING...

- Hold down Max/Min button for 3 seconds or more in the setting standby mode (indication blinking in Step 3 and 4) to return to Measuring Mode without applying the last changes.
- If you get lost in a setting mode, you can execute initialization. (Refer to 16.2 INITIALIZING SETTING VALUES.)

4. SETTING DECIMAL POINT POSITION

The decimal point position, 1 decimal place ('D ON') or no decimal point ('DOFF') can be selected. The default value is 1 decimal place.

IMPORTANT

- '1 decimal place' is not selectable with °F.
- '1 decimal place' setting is automatically reset to 'no decimal point' when the temperature unit is switched from °C to °F.
- When the decimal point position is changed, the set alarm setpoints are discarded and reset to '----'. It is recommended to record the setpoints as necessary.
- When the decimal point position is changed, the input compensation A input/compensation values and input compensation B input/compensation values are initialized. It is recommended to record the values as necessary.

4.1 OPERATING PROCEDURE

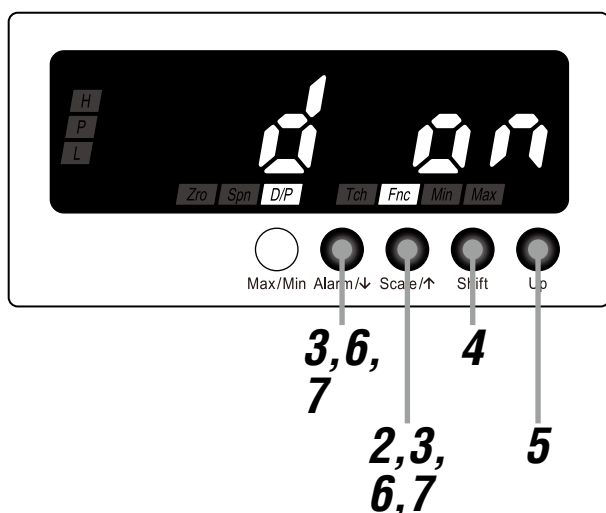

NOTE

- Procedures to change 'D ON' to 'DOFF' are described here.
- To change 'DOFF' to 'D ON', the procedures are same. Select 'D ON' in Step 5.

1 Confirm the wiring, and turn on the power.

- All the indications turn on for approximately 5 seconds and then the display moves on to Measuring Mode.

■ Immediately after power on (all indicators on)



■ Measuring Mode



*1 Display depends on the settings and input.

NOTE

- Indication 'S.ERR' may blink, which shows the input out of the measurable range and does not show the unit failure.
- Indication 'B.ERR' may blink, which shows the input open and does not show the unit failure.

2 Hold down Scale↑ button for 3 seconds or more to move on to Initial Setting Mode.

- The temperature unit is indicated.
- 'Fnc' indicator turns on.

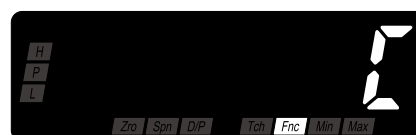

3 Press Alarm/↓ or Scale/↑ button to go to the decimal point position setting.

- 'D ON' is indicated.
- 'D/P' and 'Fnc' indicators turn on.

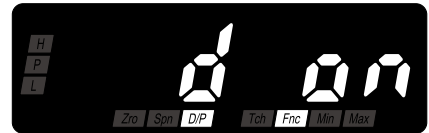

NOTE

Skip to Step 7 if the default value is acceptable.

4 Press Shift button to shift the display into the setting standby mode.

- The indication starts blinking, to which you can apply changes.

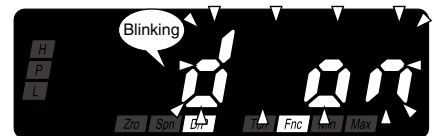

5 Press Up button to select 'DOFF'.

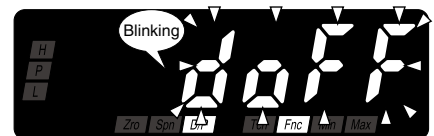

6 Press Alarm/↓ or Scale/↑ button to apply the new setting.

- And the next parameter setting is indicated.

NOTE

- Press Alarm/↓ button, and the input compensation A input value will be indicated within the range of -9999 to 9999 depending on the setting.
- Press Scale/↑ button, and the temperature unit 'C' or 'F' will be indicated depending on the setting.

7 Hold down Alarm/↓ or Scale/↑ button for 3 seconds or more to return to Measuring Mode.

NOTE

■ IF THE FRONT BUTTONS ARE LEFT UNTOUCHED...

- The display goes back automatically to Measuring Mode without applying the last changes after the setting time out period (default: 60 sec.) in the setting standby mode (indication blinking in Step 4 and 5).
- The display goes back automatically to Measuring Mode after the setting time out period (default: 60 sec.) in one of the other modes.
- The setting time out is configurable. (Refer to 10. GOING BACK AUTOMATICALLY TO MEASURING MODE.)

■ TO ABORT A SETTING...

- Hold down Max/Min button for 3 seconds or more in the setting standby mode (indication blinking in Step 4 and 5) to return to Measuring Mode without applying the last changes.
- If you get lost in a setting mode, you can execute initialization. (Refer to 16.2 INITIALIZING SETTING VALUES.)

5. OPERATION

Make sure that the input Pt 100 (JIS '97, IEC), 0 – 100°C is correctly indicated.

IMPORTANT

Before operating, make sure that the wiring is correct, the input and the power supply are within the specification range.

1 Provide 0°C input and make sure that 0°C is indicated.

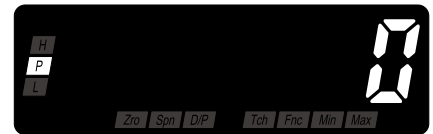

*1 Display depends on the settings and input.

NOTE

■ WHEN THE FOLLOWING IS INDICATED...

- When 'S.ERR' is indicated, the input is not applied correctly. Check the RTD type and input wiring. When 'Min' indicator blinks, the input signal is under the specification temperature. And when 'Max' indicator blinks, the input is over the specification temperature.
- When 'B.ERR' is indicated, one or some of the input wires is/are disconnected. Check the wiring.

■ ALARM INDICATORS

- The status of the alarm indicators depend on the alarm setpoints. The above display examples show 'P' indicator on.

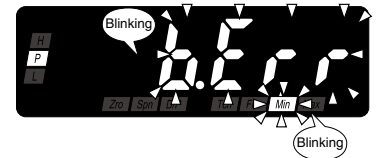
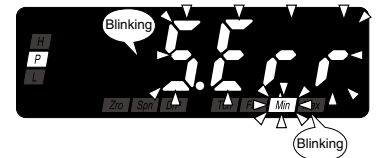

2 Provide 100°C input and make sure that 100°C is indicated.



NOTE

When the indication is shifted, perform Input Compensation. (Refer to 14.1 INPUT COMPENSATION.)

6. PARAMETER CONFIGURATION

■ MODE

Parameters can be grouped in several modes.
The 47NLR has modes as shown in the following table.

MODE	FUNCTION	MEASUREMENT
Measuring	Normal measurement state where the unit takes in input and provides alarms. Present value, MAX and MIN values, alarm setpoints can be indicated in Measuring Mode. When the power is supplied, the unit operates in Measuring Mode.	Measuring
Initial Setting	Basic settings such like temperature unit and decimal point position, and Input Compensation can be performed.	Measuring stopped
Alarm Setting	Alarm setpoints, trip action, deadband, trip delay and alarm output logic can be set.	
Advanced Setting	Moving average, brightness and burnout can be set. Also the firmware version can be confirmed.	
Lockout Setting	Settings to prevent inadvertent button operation can be performed. Mode transition and set values can be locked.	

■ MODE TRANSITION

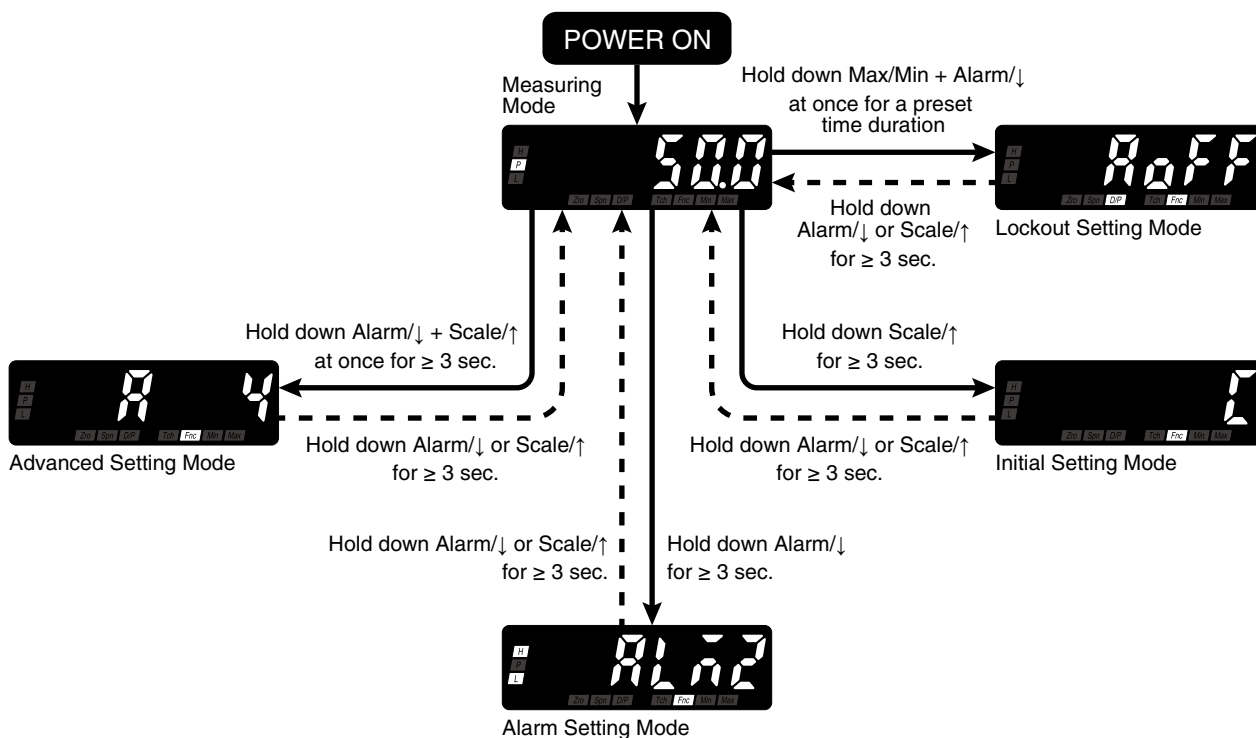

■ TRANSITION FROM MEASURING MODE TO EACH MODE

To Initial Setting Mode	Hold down Scale/↑ button for 3 seconds or more.
To Alarm Setting Mode	Hold down Alarm/↓ button for 3 seconds or more.
To Advanced Setting Mode	Hold down Alarm/↓ + Scale/↑ buttons at once for 3 seconds or more.
To Lockout Setting Mode	Hold down Max/Min + Alarm/↓ buttons at once for a preset time duration.

■ TRANSITION FROM EACH MODE TO MEASURING MODE

Hold down Alarm/↓ or Scale/↑ button for 3 seconds or more to return to Measuring Mode.

SHIFTING THROUGH SETTING PARAMETERS

(1) Parameter shifting in Initial Setting Mode

In Initial Setting Mode, pressing Alarm/↓ button shifts one parameter to the next (clockwise in the following figure). Pressing Scale/↑ button shifts one to the previous (counterclockwise).

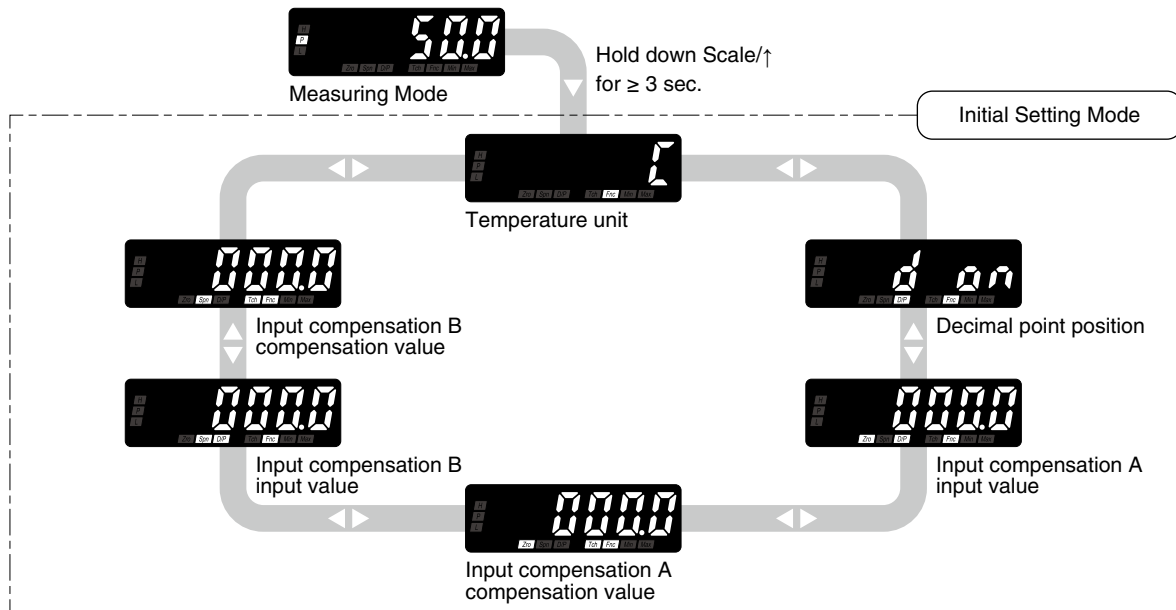

NOTE

- The display depends on the settings and input. The above displays show default values.
- Hold down Alarm/↓ or Scale/↑ button for 3 seconds or more to return to Measuring Mode from each parameter.

(2) Parameter shifting in Alarm Setting Mode

In Alarm Setting Mode, pressing Alarm/↓ button shifts one parameter to the next (clockwise in the following figure). Pressing Scale/↑ button shifts one to the previous (counterclockwise).

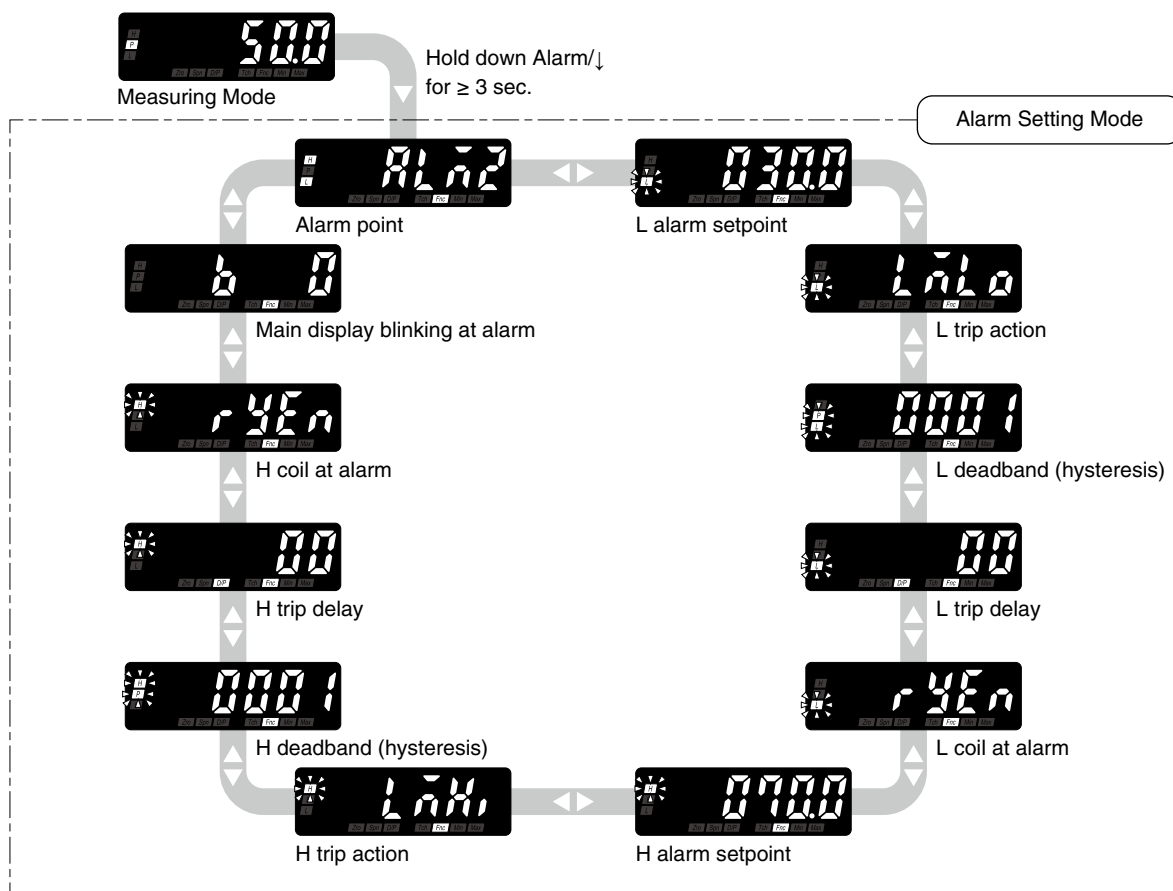

NOTE

- The display depends on the settings and input. The above displays show default values.
- Alarm Setting Mode is locked when “No alarm” is selected for the alarm point parameter.
- Hold down Alarm/↓ or Scale/↑ button for 3 seconds or more to return to Measuring Mode from each parameter.

(3) Parameter shifting in Advanced Setting Mode

In Advanced Setting Mode, pressing Alarm/↓ button shifts one parameter to the next (clockwise in the following figure). Pressing Scale/↑ button shifts one to the previous (counterclockwise).

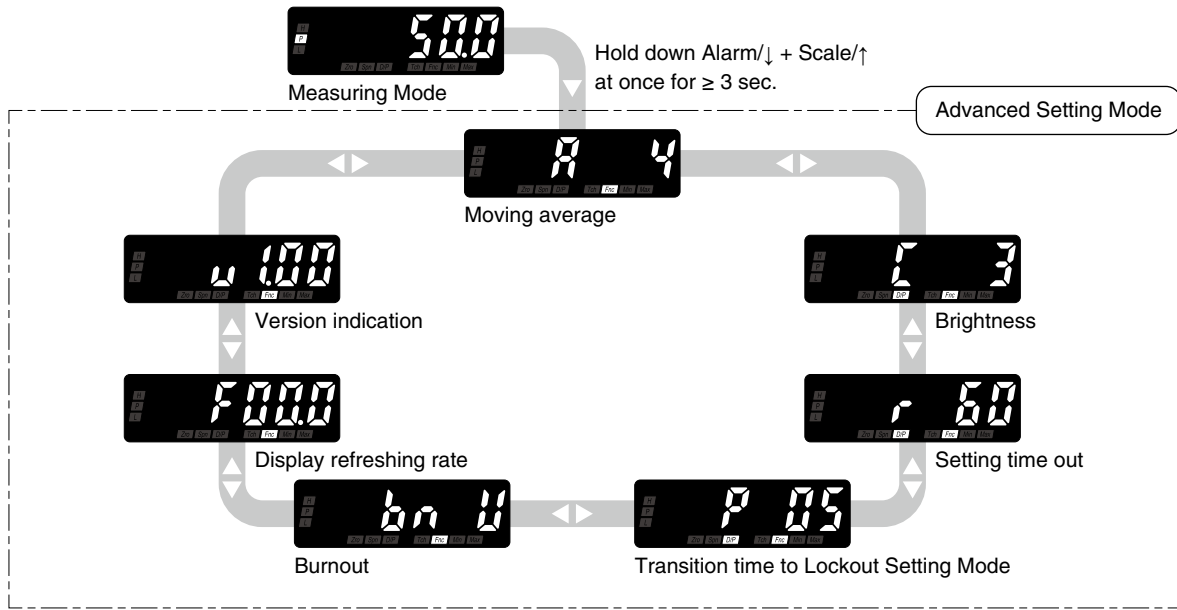

NOTE

- The display depends on the settings and input. The above displays show default values.
- Hold down Alarm/↓ or Scale/↑ button for 3 seconds or more to return to Measuring Mode from each parameter.

(4) Parameter shifting in Lockout Setting Mode

In Lockout Setting Mode, pressing Alarm/↓ button shifts one parameter to the next (clockwise in the following figure). Pressing Scale/↑ button shifts one to the previous (counterclockwise).

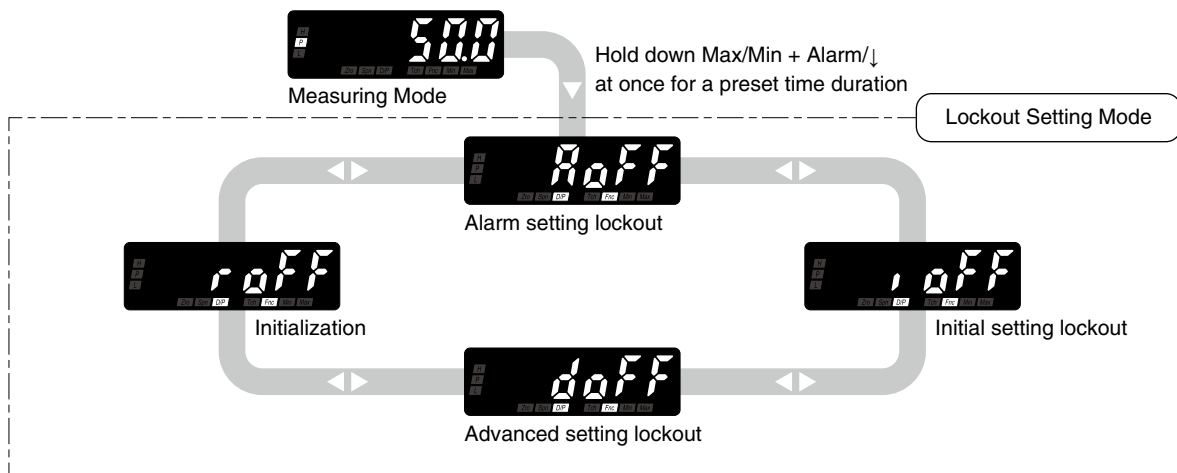

NOTE

- The display depends on the settings and input. The above displays show default values.
- Hold down Alarm/↓ or Scale/↑ button for 3 seconds or more to return to Measuring Mode from each parameter.

7. SETTING ALARM OUTPUT

The unit compares the present value with the alarm setpoints, and provides an alarm output (photo MOSFET relay). You can configure parameters as alarm conditions as shown in Tables 1 and 2. Figures 1 to 5 show alarm examples using each parameter.

■ TABLE 1: ALARM OUTPUT PARAMETERS

PARAMETER	FUNCTION
Alarm point	Dual alarm or no alarm
Alarm setpoint	Setpoint value within the range of -9999 to 9999 for the display value
Trip action	High or low trip Configuring typical L/H trip setting (Figure 1) or all trip points to high or low setting (Figure 2) is available. 'P' indicator turns on when none of the other alarms is tripped.
Deadband (hysteresis)	Once a high (low) trip alarm is ON, the alarm stays ON until the data becomes lower (higher) than the dead band value from the setpoint, which prevents the alarm output from chattering when the display value fluctuates slightly near the setpoint (Figure 3). Deadband works in the direction of increasing the display value for low trip and in the direction of decreasing it for high.
Trip delay	Alarm output is provided when the display value exceeds the setpoint and stayed for the specified time duration, which prevents the alarm output from being provided by a sudden change such like external disturbance (Figure 4).
Coil at alarm	Alarm output logic, coil energized or de-energized at alarm (Figure 5).
Main display blinking at alarm	Main display blinking interval at alarm can be selected among 5 intervals (Table 2).

■ TABLE 2: SETTING VALUES

PARAMETER	DISPLAY	FUNCTION	DEFAULT VALUE
Alarm point	RLn2	Dual alarm	RLn2
	RLn0	No alarm	
Alarm setpoint	-9999 to 9999	-9999 to 9999	L alarm setpoint: 0300 H alarm setpoint: 0700
Trip action	LnLo	Lo trip	L trip action: LnLo
	LnHi	Hi trip	H trip action: LnHi
Deadband (hysteresis)	0000 to 9999	0000 – 9999	0000
Trip delay	00 to 99	0 – 99 seconds	00
Coil at alarm	rYEn	Coil energized at alarm	rYEn
	rYd0	Coil de-energized at alarm	
Main display blinking at alarm	b 0	No blinking	b 0
	b 1	Blinking in 1.0 second intervals	
	b 2	Blinking in 0.5 second intervals	
	b 3	Blinking in 0.2 second intervals	
	b 4	Blinking in 0.1 second intervals	

Figure 1: Typical L/H trip setting

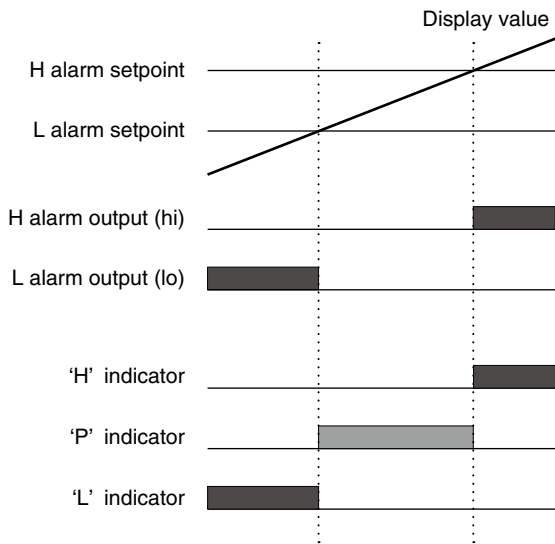
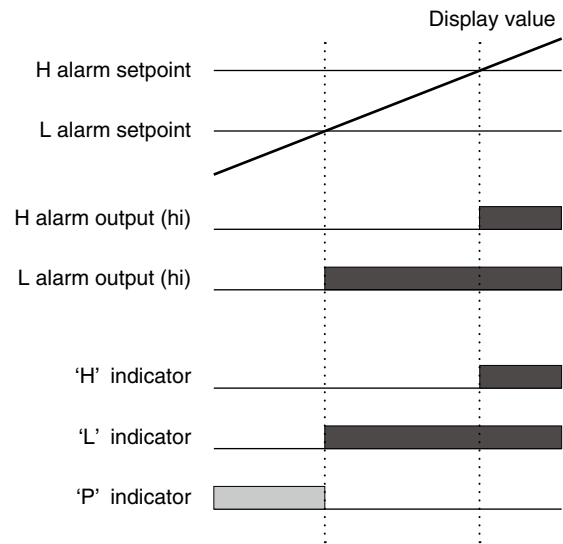

Figure 2: All trip points set to high setting



Low or high trip action can be set for each alarm output. 'L' and 'H' indicators are fixed for each alarm output. Therefore, even in case setting L alarm output to high trip action, for example, 'L' indicator turns on at alarm.

Figure 3: Deadband (hysteresis)

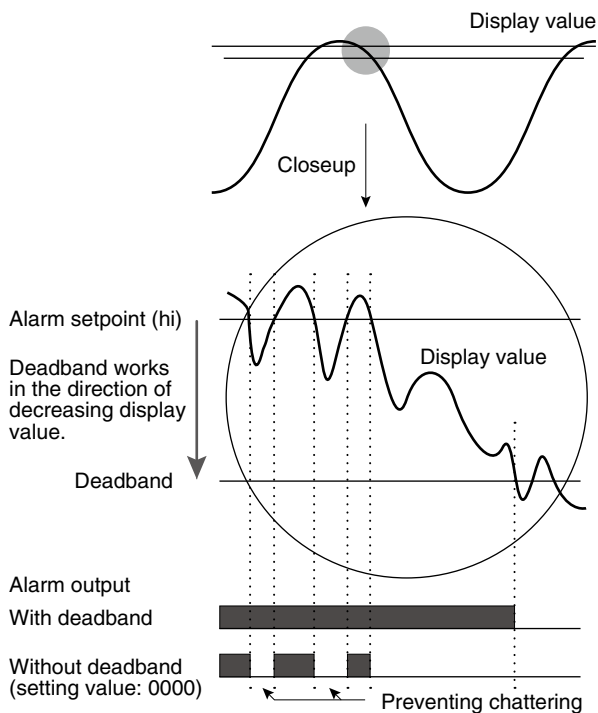
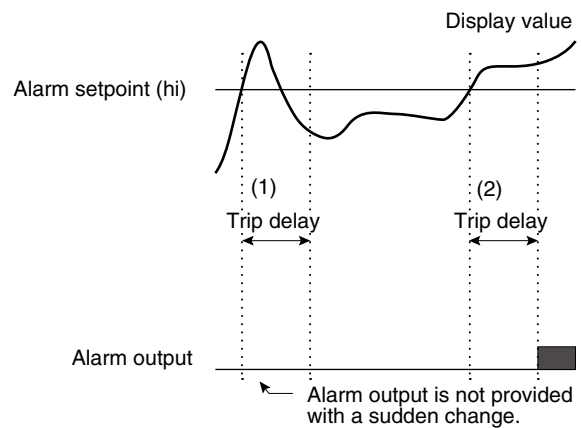
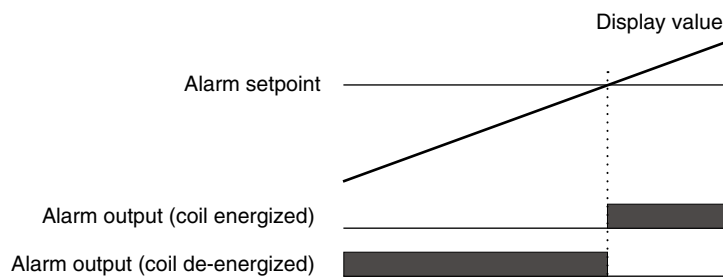

Figure 4: Trip delay



- (1) The display value once exceeds the alarm setpoint but becomes below it during trip delay time period. Therefore alarm output is not provided.
- (2) The display value exceeds the setpoint and stays over the trip delay time period. Therefore alarm output is provided.

Figure 5: Coil at alarm



In order to stop operation of an equipment when the display value exceeds the setpoint, for instance, set reversal output logic, "coil de-energized".

IMPORTANT

- When indication 'S.ERR' and 'Min' indicator blink, all the low alarm outputs are provided. When indication 'S.ERR' and 'Max' indicator blink, all the high alarm outputs are provided.
 - When 'B.ERR' is indicated, all the high alarm outputs are provided with the 'upscale burnout' setting and all the low alarm outputs are provided with the 'downscale burnout' setting.
 - When the temperature unit and decimal point position are changed, the alarm setpoints will be reset to '-----'.
-

7.1 ALARM POINT

The alarm point, no alarm 'ALM0' or dual alarm 'ALM2', can be selected.

7.1.1 OPERATING PROCEDURE

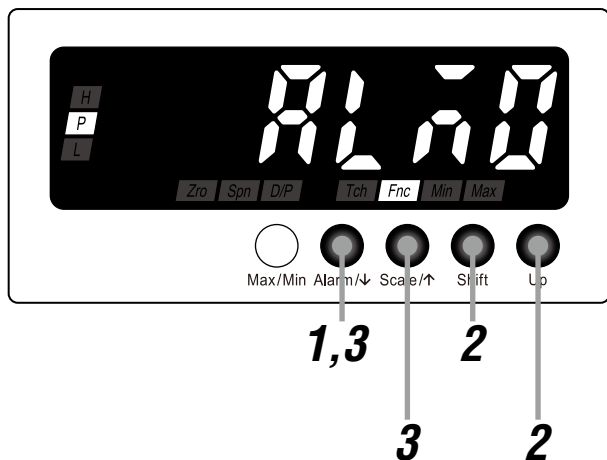

NOTE

- Procedures to change 'ALM0' to 'ALM2' are described here.
- To change 'ALM2' to 'ALM0', the procedures are same. Select 'ALM0' in Step 2.

1 Hold down Alarm/↓ button for 3 seconds or more to move on to Alarm Setting Mode.

- The alarm point is indicated.
- 'P' and 'Fnc' indicators turn on.

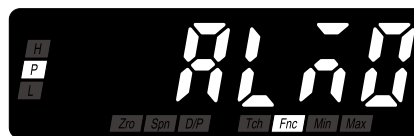

2 Press Shift or Up button to select 'ALM2'.

- 'H' and 'L' indicators now turn on.

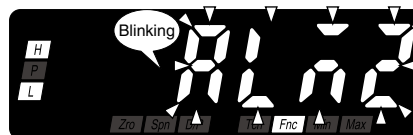

3 Press Alarm/↓ or Scale/↑ button to apply the new setting.

- And the next parameter setting is indicated.

NOTE

- Press Alarm/↓ button, and the L alarm setpoint will be indicated within the range of -9999 to 9999 depending on the setting.
- Press Scale/↑ button, and the main display blinking at alarm 'B 0', 'B 1', 'B 2', 'B 3' or 'B 4' will be indicated depending on the setting.
- When "No alarm" is selected for the alarm point parameter, Alarm Setting Mode is locked.

4 ■ TO SET THE NEXT PARAMETER, Skip to Step 2 in "7.2 ALARM SETPOINT"

■ TO QUIT,

Hold down Alarm/↓ or Scale/↑ button for 3 seconds or more to return to Measuring Mode.

7.2 ALARM SETPOINT

Alarm setpoints can be set within the usable range.

Setting the min. or max. value of the usable range as setpoint enables the unit to provide an alarm with the abnormality 'B.ERR' or 'S.ERR'.

When the temperature unit and decimal point position are changed, the alarm setpoints will be reset to '-----'.

7.2.1 ALARM SETPOINT DEFAULT VALUE

PARAMETER	DEFAULT VALUE
L alarm setpoint	0300
H alarm setpoint	0700

7.2.2 ALARM SETPOINT LIST

■ TEMPERATURE UNIT: °C

INPUT SIGNAL	RTD	USABLE RANGE	CONFORMANCE RANGE
1	JPt 100 (JIS '89)	-230 to +530	-200 to +500
3	Pt 100 (JIS '89)	-230 to +680	-200 to +650
4	Pt 100 (JIS '97, IEC)	-230 to +880	-200 to +850
5	Pt 50 Ω (JIS '81)	-230 to +679	-200 to +649
7	Pt 1000	-230 to +880	-200 to +850

■ TEMPERATURE UNIT: °F

INPUT SIGNAL	RTD	USABLE RANGE	CONFORMANCE RANGE
1	JPt 100 (JIS '89)	-382 to +986	-328 to +932
3	Pt 100 (JIS '89)	-382 to +1256	-328 to +1202
4	Pt 100 (JIS '97, IEC)	-382 to +1616	-328 to +1562
5	Pt 50 Ω (JIS '81)	-382 to +1256	-328 to +1202
7	Pt 1000	-382 to +1616	-328 to +1562

7.2.3 OPERATING PROCEDURE

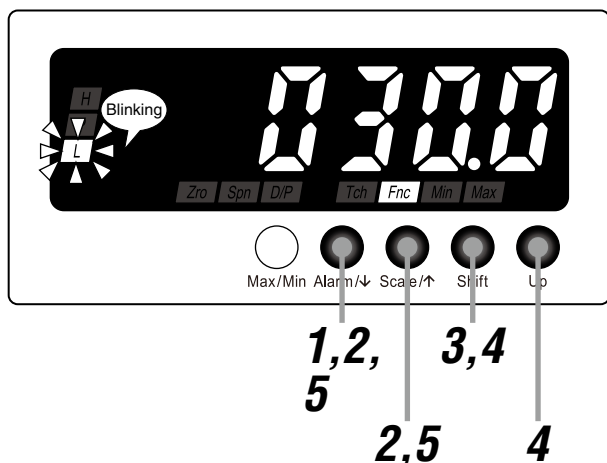

NOTE

The following figures are display examples. The displays depend on the settings.

1 Hold down Alarm/↓ button for 3 seconds or more to move on to Alarm Setting Mode.

- The alarm point is indicated.
- 'H', 'L' and 'Fnc' indicators turn on.

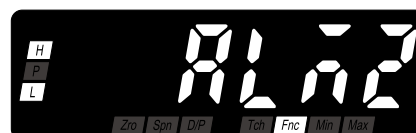

2 Press Alarm/↓ or Scale/↑ button to go to the L (H) alarm setpoint setting.

- The L (H) alarm setpoint is indicated.
- 'L' ('H') indicator blinks and 'Fnc' indicator turns on.



■ Display in setting H alarm setpoint

NOTE

The setpoint is indicated within the range of -9999 to 9999 depending on the setting.

3 Press Shift button to shift the display into the setting standby mode.

- The fifth digit starts blinking, to which you can apply changes.



4 Press Shift and Up buttons to set the L (H) alarm setpoint.

- Set within the range of -9999 to 9999.

IMPORTANT

Specify '----' to disable the alarm output.

NOTE

When the temperature unit is set to °F or the decimal point position is set to no decimal point, set the value without decimal point.

5 Press Alarm/↓ or Scale/↑ button to apply the new setting.

- And the next parameter setting is indicated.

NOTE

- Press Alarm/↓ button, and the L (H) trip action 'LMLO' or 'LMHI' will be indicated depending on the setting.
 - Press Scale/↑ button, and the alarm point 'ALM2' (or L coil at alarm 'RYEN' or 'RYDN') will be indicated.
-

6 ■ TO GO ON TO SET ANOTHER ALARM SETPOINT,
Repeat operation from Step 2.

■ TO SET THE NEXT PARAMETER,
Skip to Step 2 in "7.3 TRIP ACTION (LO/HI):"

■ TO QUIT,
Hold down Alarm/↓ or Scale/↑ button for 3 seconds or more to return to Measuring Mode.

7.3 TRIP ACTION (LO/HI)

The trip action low 'LMLO' or high 'LMHI' can be selected. Configuring typical L/H trip setting or all trip points to high or low setting is available. The default values are "low trip" for the L trip action and "high trip" for the H.

7.3.1 OPERATING PROCEDURE

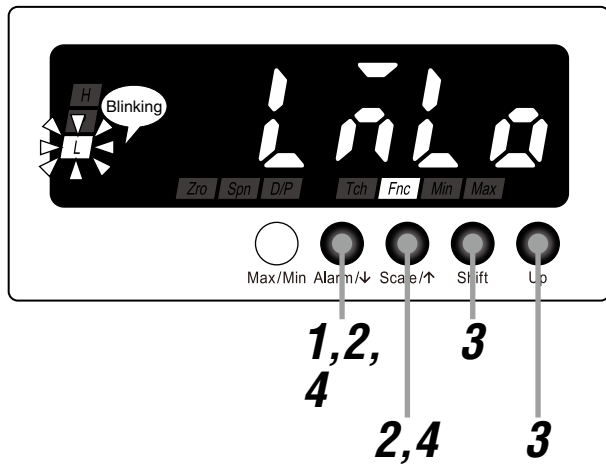

NOTE

- Procedures to change 'LMLO' to 'LMHI' are described here.
- To change 'LMHI' to 'LMLO', the procedures are the same. Select 'LMLO' in Step 3.

1 Hold down Alarm/↓ button for 3 seconds or more to move on to Alarm Setting Mode.

- The alarm point is indicated.
- 'H', 'L' and 'Fnc' indicators turn on.



2 Press Alarm/↓ or Scale/↑ button to go to the L (H) trip action setting.

- 'LMLO' is indicated.
- 'L' ('H') indicator blinks and 'Fnc' indicator turns on.



■ Display in setting H trip action

3 Press Shift or Up button to select 'LMHI'.

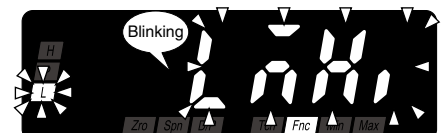

4 Press Alarm/↓ or Scale/↑ button to apply the new setting.

- And the next parameter setting is indicated.

NOTE

- Press Alarm/↓ button, and the L (H) deadband will be indicated within the range of 0000 to 9999 depending on the setting.
 - Press Scale/↑ button, and the L (H) alarm setpoint will be indicated within the range of -9999 to 9999 depending on the setting.
-

5 ■ TO GO ON TO SET ANOTHER TRIP ACTION,

Repeat operation from Step 2.

■ TO SET THE NEXT PARAMETER,

Skip to Step 2 in “7.4 DEADBAND”

■ TO QUIT,

Hold down Alarm/↓ or Scale/↑ button for 3 seconds or more to return to Measuring Mode.

7.4 DEADBAND

Once a high (low) trip alarm is ON, the alarm stays ON until the data becomes lower (higher) than a certain range from the setpoint, which prevents the alarm output from chattering when the display value fluctuates slightly near the setpoint. This range is called deadband (hysteresis) and can be set within the range of 0000 to 9999. The default value is 0001.

7.4.1 OPERATING PROCEDURE

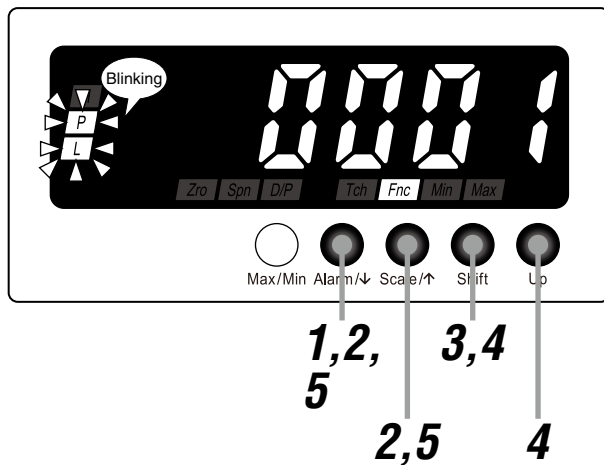

NOTE

The following figures are display examples. The displays depend on the settings.

1 Hold down Alarm/↓ button for 3 seconds or more to move on to Alarm Setting Mode.

- The alarm point is indicated.
- 'H', 'L' and 'Fnc' indicators turn on.



2 Press Alarm/↓ or Scale/↑ button to go to the L (H) deadband setting.

- The L (H) deadband is indicated.
- 'L' ('H') and 'P' indicators blink and 'Fnc' indicator turns on.



■ Display in setting H deadband

NOTE

The L (H) deadband is indicated within the range of 0000 to 9999 depending on the setting.

3 Press Shift button to shift the display into the setting standby mode.

- The fourth digit starts blinking, to which you can apply changes.

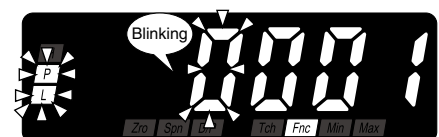

4 Press Shift and Up buttons to set the L (H) deadband.

- Set within the range of 0000 to 9999.

NOTE

Set the deadband for the setpoint. The decimal point is not indicated.

5 Press Alarm/↓ or Scale/↑ button to apply the new setting.

- And the next parameter setting is indicated.

NOTE

- Press Alarm/↓ button, and the L (H) trip delay will be indicated within the range of 00 to 99 depending on the setting.
 - Press Scale/↑ button, and the L (H) trip action 'LMLO' or 'LMHI' will be indicated depending on the setting.
-

6 ■ TO GO ON TO SET ANOTHER DEADBAND,
Repeat operation from Step 2.

■ TO SET THE NEXT PARAMETER,
Skip to Step 2 in "7.5 TRIP DELAY"

■ TO QUIT,
Hold down Alarm/↓ or Scale/↑ button for 3 seconds or more to return to Measuring Mode.

7.5 TRIP DELAY

Alarm output is provided when the display value exceeds the setpoint and stayed for the specified time duration, which prevents the alarm output from being provided by a sudden change such like external disturbance. This time duration is called trip delay and can be set within the range of 0 to 99 seconds. The default value is 0 second.

7.5.1 OPERATING PROCEDURE

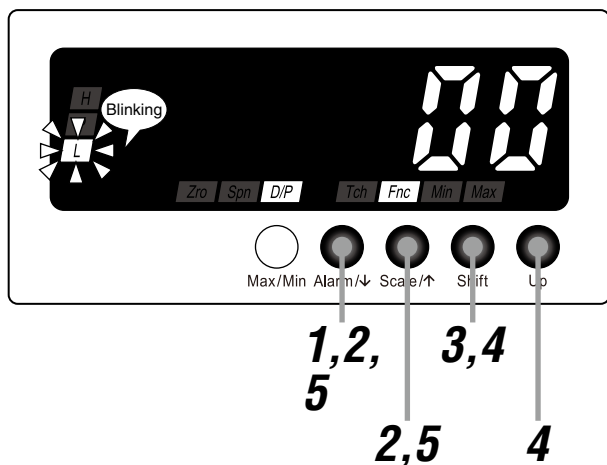

NOTE

The following figures are display examples. The displays depend on the settings.

1 Hold down Alarm/↓ button for 3 seconds or more to move on to Alarm Setting Mode.

- The alarm point is indicated.
- 'H', 'L' and 'Fnc' indicators turn on.



2 Press Alarm/↓ or Scale/↑ button to go to the L (H) trip delay setting.

- The L (H) trip delay is indicated.
- 'L' ('H') indicator blinks, 'D/P' and 'Fnc' indicators turn on.

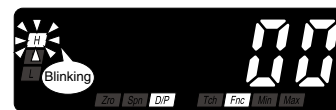
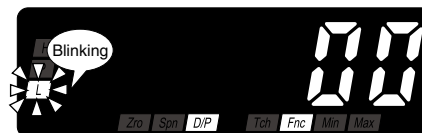

■ Display in setting H trip delay

NOTE

The trip delay is indicated within the range of 00 to 99 depending on the setting.

3 Press Shift button to shift the display into the setting standby mode.

- The second digit starts blinking, to which you can apply changes.

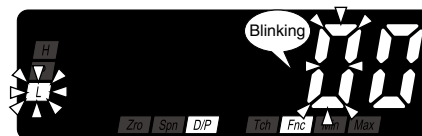

.....

4 Press Shift and Up buttons to set the L (H) trip delay.

- Set within the range of 00 to 99.

.....

5 Press Alarm/↓ or Scale/↑ button to apply the new setting.

- And the next parameter setting is indicated.

NOTE

- Press Alarm/↓ button, and the L (H) coil at alarm 'RYEN' or 'RYDN' will be indicated depending on the setting.
 - Press Scale/↑ button, and the L (H) deadband will be indicated within the range of 0000 to 9999 depending on the setting.
-

.....

6 ■ TO GO ON TO SET ANOTHER TRIP DELAY,
Repeat operation from Step 2.

■ TO SET THE NEXT PARAMETER,

Skip to Step 2 in "7.6 ALARM OUTPUT LOGIC (coil energized or de-energized at alarm)".

■ TO QUIT,

Hold down Alarm/↓ or Scale/↑ button for 3 seconds or more to return to Measuring Mode.

7.6 ALARM OUTPUT LOGIC (coil energized or de-energized at alarm)

Alarm output logic can be selected. This parameter is called energizing direction and coil energized 'RYEN' or de-energized 'RYDN' at alarm can be selected. In selecting coil de-energized at alarm, the alarm output logic is inverted. The default setting is coil energized.

7.6.1 OPERATING PROCEDURE

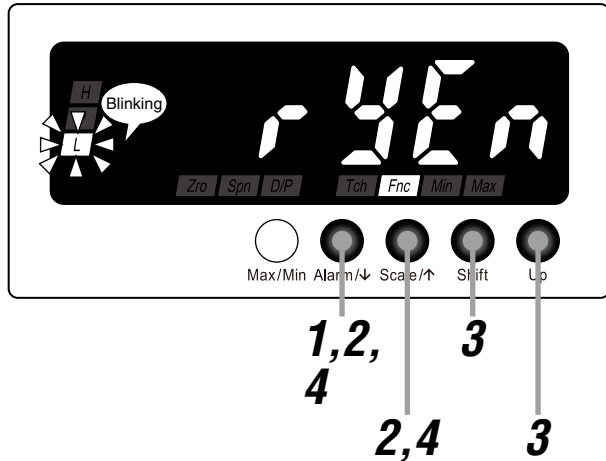

NOTE

- Procedures to change 'RYEN' to 'RYDN' are described here.
- To change 'RYDN' to 'RYEN', the procedures are same. Select 'RYEN' in Step 3.

1 Hold down Alarm/↓ button for 3 seconds or more to move on to Alarm Setting Mode.

- The alarm point is indicated.
- 'H', 'L' and 'Fnc' indicators turn on.



2 Press Alarm/↓ or Scale/↑ button to go to the setting of the L (H) coil at alarm.

- 'RYEN' is indicated.
- 'L' ('H') indicator blinks and 'Fnc' indicator turns on.

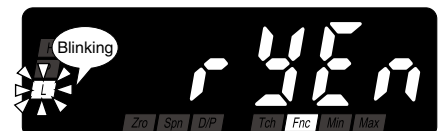

■ Display in setting H coil at alarm

3 Press Shift or Up button to select 'RYDN'.

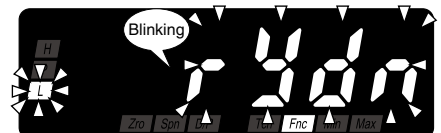

.....

4 Press Alarm/↓ or Scale/↑ button to apply the new setting.

- And the next parameter setting is indicated.

NOTE

- Press Alarm/↓ button, and the H alarm setpoint (or main display blinking at alarm) will be indicated within the range of -9999 to 9999 (or 'B 0', 'B 1', 'B 2', 'B 3' or 'B 4') depending on the setting.
 - Press Scale/↑ button, and the L (H) trip delay will be indicated within the range of 00 to 99 depending on the setting.
-

.....

5 ■ TO GO ON TO SET ANOTHER COIL AT ALARM,

Repeat operation from Step 2.

■ TO SET THE NEXT PARAMETER,

Skip to Step 2 in "7.7 MAIN DISPLAY BLINKING AT ALARM".

■ TO QUIT,

Hold down Alarm/↓ or Scale/↑ button for 3 seconds or more to return to Measuring Mode.

7.7 MAIN DISPLAY BLINKING AT ALARM

Main display blinking interval at alarm can be specified. The interval can be selected among those shown in the following table.

■ BLINKING INTERVAL AT ALARM

DISPLAY	FUNCTION	DEFAULT VALUE
	No blinking	
	Blinking in 1.0 second intervals	
	Blinking in 0.5 second intervals	
	Blinking in 0.2 second intervals	
	Blinking in 0.1 second intervals	

7.7.1 OPERATING PROCEDURE

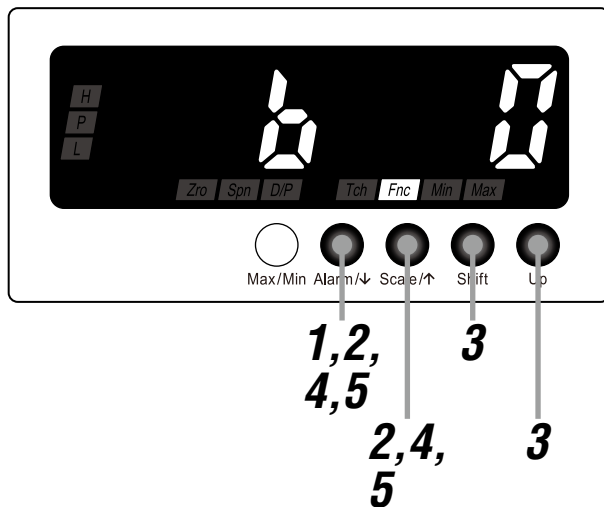

NOTE

The following figures are display examples. The displays depend on the settings.

1 Hold down Alarm/↓ button for 3 seconds or more to move on to Alarm Setting Mode.

- The alarm point is indicated.
- 'H', 'L' and 'Fnc' indicators turn on.

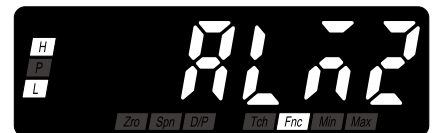

2 Press Alarm/↓ or Scale/↑ button to go to the setting of the main display blinking at alarm.

- The main display blinking at alarm is indicated.
- 'Fnc' indicator turns on.



NOTE

'B 0', 'B 1', 'B 2', 'B 3' or 'B 4' is indicated depending on the setting.

.....

3 Press Shift or Up button to select.

- Select one among 'B 0', 'B 1', 'B 2', 'B 3' and 'B 4'.

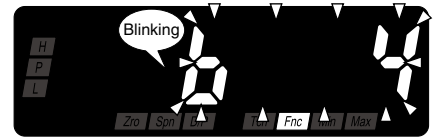

.....

4 Press Alarm/↓ or Scale/↑ button to apply the new setting.

- And the next parameter setting is indicated.

NOTE

- Press Alarm/↓ button, and the alarm point 'ALM2' will be indicated.
 - Press Scale/↑ button, and the H coil at alarm 'RYEN' or 'RYDN' will be indicated depending on the setting.
-

.....

5 Hold down Alarm/↓ or Scale/↑ button for 3 seconds or more to return to Measuring Mode.

8. AVERAGING INPUT

Moving average processing of measured values is configurable. The number of samples in processing the moving average can be selected in the following table. This operation averages sampled values, and then, averages with a new sample added and the oldest one omitted. Such operation is repeated as shown in the following figure. For instance, when 'A 4' is selected, the moving average processing with 4 samples (100 millisecond intervals) is repeated. Moving average is used to remove periodic varied noise superimposed on the input signal and suppress the display flickering.

■ NUMBER OF SAMPLES

DISPLAY	FUNCTION	DEFAULT VALUE
OFF	No moving averaging	A 4
A 2	Moving average with 2 samples (50 millisecond intervals)	
A 4	Moving average with 4 samples (100 millisecond intervals)	
A 8	Moving average with 8 samples (200 millisecond intervals)	
A 16	Moving average with 16 samples (400 millisecond intervals)	
A 32	Moving average with 32 samples (800 millisecond intervals)	
A 64	Moving average with 64 samples (1.6 second intervals)	

■ EXAMPLE OF MOVING AVERAGE WITH 4 SAMPLES

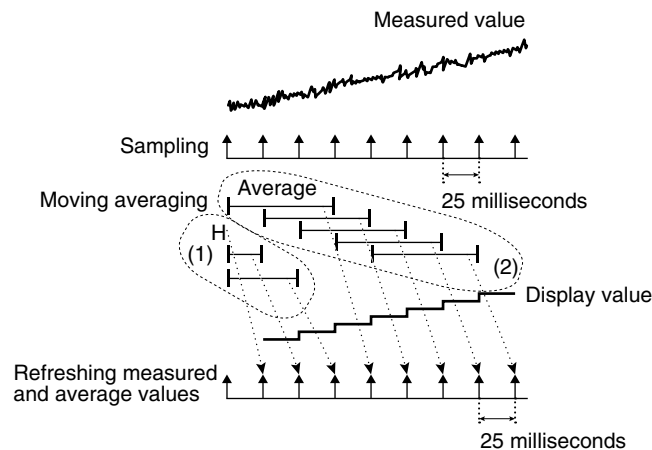

- (1) The moving average operation starts immediately after the power is on or the moving average is set. Until the sampling No. reaches the set value, all samples are averaged every 25 milliseconds.
- (2) After the sampling No. reaches the set value, a new sample is added to be averaged with the oldest one omitted. Such operation is repeated.

8.1 OPERATING PROCEDURE

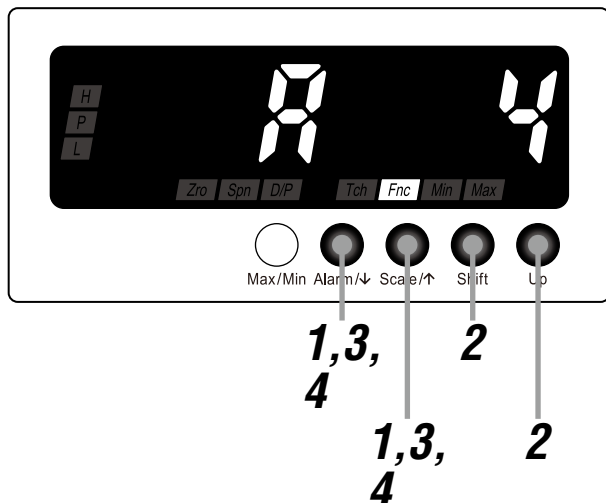

NOTE

The following figures are display examples. The displays depend on the settings.

1 Hold down Alarm/↓ and Scale/↑ buttons at once for 3 seconds or more to move on to Advanced Setting Mode.

- The moving average sampling No. is indicated.
- 'Fnc' indicator turns on.

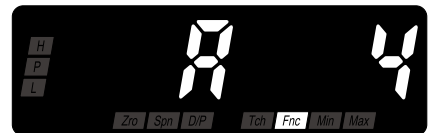

NOTE

'A OFF', 'A 2', 'A 4', 'A 8', 'A 16', 'A 32' or 'A 64' is indicated depending on the setting.

2 Press Shift or Up button to select.

- Select one among 'A OFF', 'A 2', 'A 4', 'A 8', 'A 16', 'A 32' and 'A 64'.

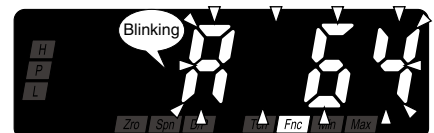

3 Press Alarm/↓ or Scale/↑ button to apply the new setting.

- And the next parameter setting is indicated.

NOTE

- Press Alarm/↓ button, and the brightness 'C 1', 'C 2', 'C 3', 'C 4' or 'C 5' will be indicated depending on the setting.
- Press Scale/↑ button, and the version indication will be indicated.

4 Hold down Alarm/↓ or Scale/↑ button for 3 seconds or more to return to Measuring Mode.

9. ADJUSTING BRIGHTNESS OF DISPLAY

The brightness of the display can be adjusted (figures below). The brightness can be selected in the following table.

■ DISPLAY BRIGHTNESS

DISPLAY	FUNCTION	DEFAULT VALUE
	Brightness level 1 (dark)	
	Brightness level 2	
	Brightness level 3	
	Brightness level 4	
	Brightness level 5 (bright)	

■ ADJUSTMENT IMAGE

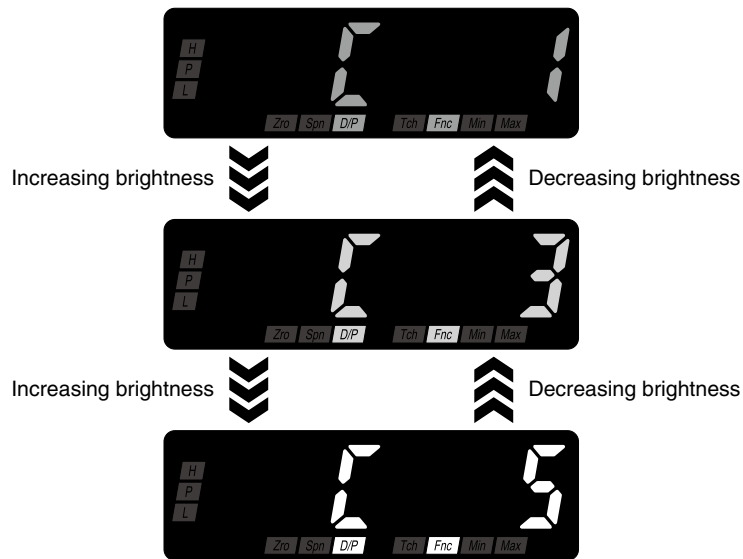

9.1 OPERATING PROCEDURE

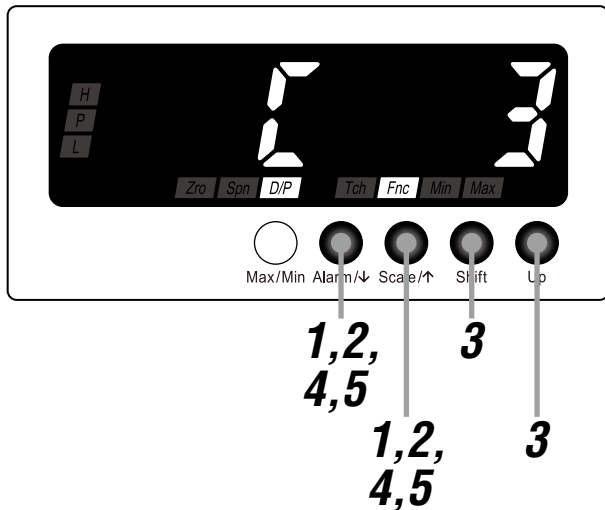

NOTE

The following figures are display examples. The displays depend on the settings.

1 Hold down Alarm/↓ and Scale/↑ buttons at once for 3 seconds or more to move on to Advanced Setting Mode.

- The moving average sampling No. is indicated.
- 'Fnc' indicator turns on.

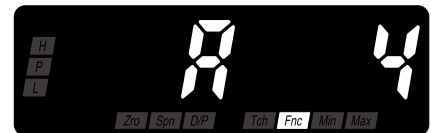

NOTE

'A OFF', 'A 2', 'A 4', 'A 8', 'A 16', 'A 32' or 'A 64' is indicated depending on the setting.

2 Press Alarm/↓ or Scale/↑ button to go to the brightness setting.

- The brightness is indicated.
- 'D/P' and 'Fnc' indicators turn on.

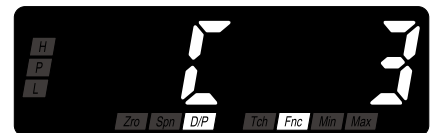

NOTE

'C 1', 'C 2', 'C 3', 'C 4' or 'C 5' is indicated depending on the setting.

3 Press Shift or Up button to select.

- Select one among 'C 1', 'C 2', 'C 3', 'C 4' and 'C 5'

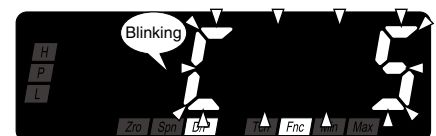

.....

4 Press Alarm/↓ or Scale/↑ button to apply the new setting.

- And the next parameter setting is indicated.

NOTE

- Press Alarm/↓ button, and the setting time out will be indicated within the range of 'R 00' to 'R 99' depending on the setting.
 - Press Scale/↑ button, and the moving average sampling No. 'AOFF', 'A 2', 'A 4', 'A 8', 'A 16', 'A 32' or 'A 64' will be indicated depending on the setting.
-

.....

5 Hold down Alarm/↓ or Scale/↑ button for 3 seconds or more to return to Measuring Mode.

10. GOING BACK AUTOMATICALLY TO MEASURING MODE

The display goes back automatically to Measuring Mode if the front buttons are left untouched for the specified time period while it is in one of the setting modes. This time period is called setting time out and can be set within the range of 1 to 99 seconds (Table 1). With the value set to 'R 00', the display must always be exited manually from the setting mode. The display does not go back automatically to Measuring Mode depending on the modes (Table 2).

■ TABLE 1: SETTING TIME OUT

DISPLAY	FUNCTION	DEFAULT VALUE
r 00	Setting time out disabled	r 60
r 01 to r 99	1 to 99 seconds	

■ TABLE 2: SETTING TIME OUT IN EACH MODE

MODE	OPERATION	SETTING TIME OUT
Measuring Mode	Confirming alarm setpoint	Enabled
	Displaying MAX or MIN value	Disabled
Initial Setting Mode		Enabled
Alarm Setting Mode		Enabled
Advanced Setting Mode		Enabled
Lockout Setting Mode		Enabled

10.1 OPERATING PROCEDURE

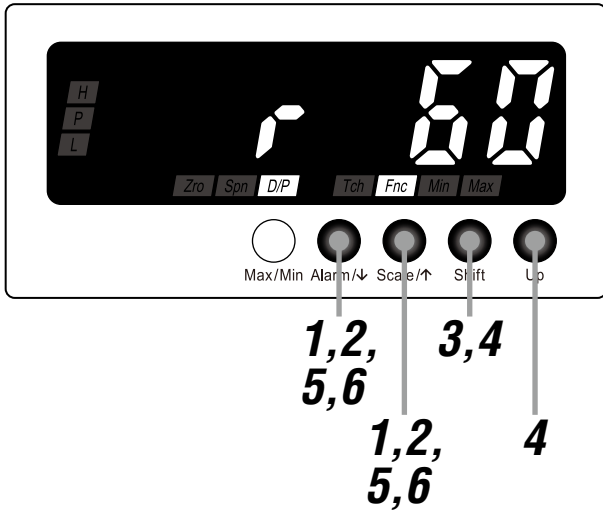

NOTE

The following figures are display examples. The displays depend on the settings.

1 Hold down Alarm/↓ and Scale/↑ buttons at once for 3 seconds or more to move on to Advanced Setting Mode.

- The moving average sampling No. is indicated.
- 'Fnc' indicator turns on.

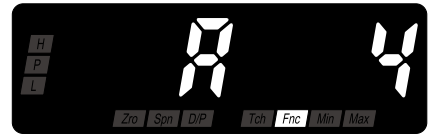

NOTE

'A OFF', 'A 2', 'A 4', 'A 8', 'A 16', 'A 32' or 'A 64' is indicated depending on the setting.

2 Press Alarm/↓ or Scale/↑ button to go to the setting time out setting.

- The setting time out is indicated.
- 'D/P' and 'Fnc' indicators turn on.

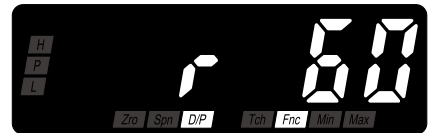

NOTE

The setting time out is indicated within the range of 'R 00' to 'R 99' depending on the setting.

3 Press Shift button to shift the display into the setting standby mode.

- The second digit starts blinking, to which you can apply changes.

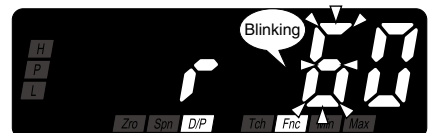

4 Press Shift and Up buttons to set the setting time out.

- Set within the range of 'R 00' to 'R 99'

.....
5 Press Alarm/↓ or Scale/↑ button to apply the new setting.

- And the next parameter setting is indicated.

NOTE

- Press Alarm/↓ button, and the transition time to Lockout Setting Mode will be indicated within the range of 'P 00' to 'P 99' depending on the setting.
 - Press Scale/↑ button, and the brightness 'C 1', 'C 2', 'C 3', 'C 4' or 'C 5' will be indicated depending on the setting.
-

.....
6 Hold down Alarm/↓ or Scale/↑ button for 3 seconds or more to return to Measuring Mode.

11. SETTING BURNOUT

Burnout is a function to provide a fail-safe condition for equipment and devices on site by outputting a high or low alarm when input is abnormal, disconnection of a wire, for instance. Burnout includes upscale burnout 'BN U' operating toward stopping heating and downscale burnout 'BN D' operating toward maintaining heating in detecting the input disconnection. When the unit detects the burnout, it indicates 'B.ERR'. With upscale burnout, all the high alarm outputs are provided. With downscale burnout, all the low alarm outputs are provided. The default is upscale burnout.

IMPORTANT

Do not change the burnout setting while 'B.ERR' is indicated.

11.1 OPERATING PROCEDURE

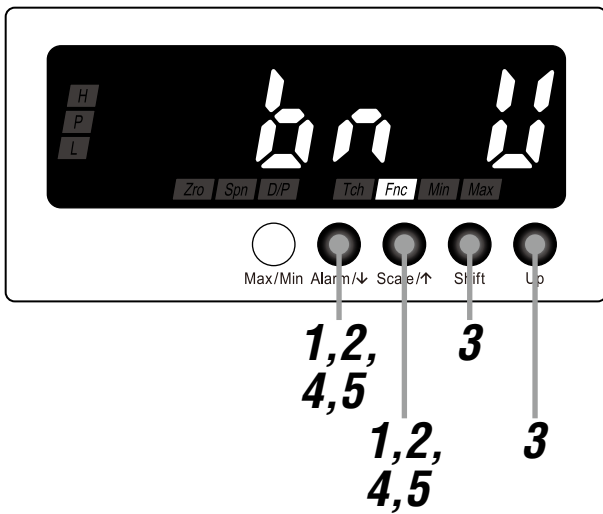

NOTE

- Procedures to change 'BN U' to 'BN D' are described here.
- To change 'BN D' to 'BN U', the procedures are same. Select 'BN U' in Step 3.

1 Hold down Alarm/↓ and Scale/↑ buttons at once for 3 seconds or more to move on to Advanced Setting Mode.

- The moving average sampling No. is indicated.
- 'Fnc' indicator turns on.

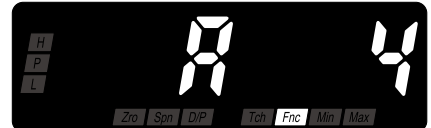

NOTE

'AOFF', 'A 2', 'A 4', 'A 8', 'A 16', 'A 32' or 'A 64' is indicated depending on the setting.

2 Press Alarm/↓ or Scale/↑ button to go to the burnout setting.

- 'BN U' is indicated.
- 'Fnc' indicator turns on.



3 Press Shift or Up button to select 'BN D'.

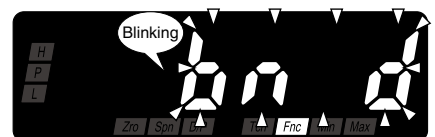

.....

4 Press Alarm/↓ or Scale/↑ button to apply the new setting.

- And the next parameter setting is indicated.

NOTE

- Press Alarm/↓ button, and the display refreshing rate will be indicated within the range of 'F00.0' to 'F99.9' depending on the setting.
 - Press Scale/↑ button, and the transition time to Lockout Setting Mode will be indicated within the range of 'P 00' to 'P 99' depending on the setting.
-

.....

5 Hold down Alarm/↓ or Scale/↑ button for 3 seconds or more to return to Measuring Mode.

12. ADJUSTING DISPLAY REFRESHING RATE

The display refreshing rate can be set within the range of 0.1 to 99.9 seconds. With this value set to 00.0, the refreshing rate will be 50 milliseconds (table below). When the input signal changes rapidly, the display refreshing rate can be slowed to suppress the display flickering.

■ DISPLAY REFRESHING RATE

DISPLAY	FUNCTION	DEFAULT VALUE
<code>F000</code>	50 milliseconds	<code>F000</code>
<code>F00.1</code> to <code>F99.9</code>	0.1 to 99.9 seconds	

■ DISPLAY REFRESHING IMAGE

e.g. Refreshing rate 0.2 seconds

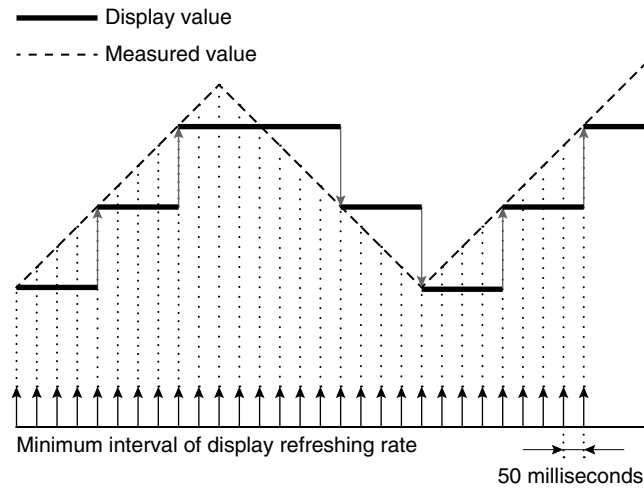

12.1 OPERATING PROCEDURE

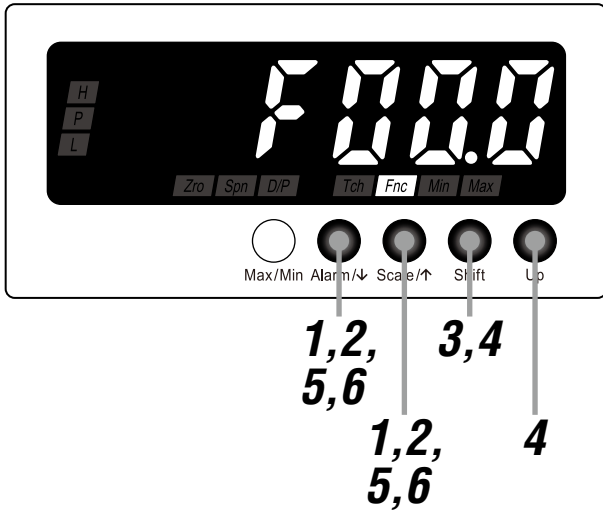

NOTE

The following figures are display examples. The displays depend on the settings.

1 Hold down Alarm/↓ and Scale/↑ buttons at once for 3 seconds or more to move on to Advanced Setting Mode.

- The moving average sampling No. is indicated.
- 'Fnc' indicator turns on.

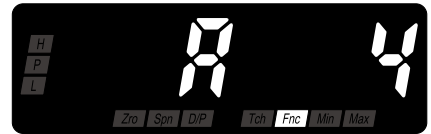

NOTE

'A OFF', 'A 2', 'A 4', 'A 8', 'A 16', 'A 32' or 'A 64' is indicated depending on the setting.

2 Press Alarm/↓ or Scale/↑ button to go to the display refreshing rate setting.

- The display refreshing rate is indicated.
- 'Fnc' indicator turns on.



NOTE

The display refreshing rate is indicated within the range of 'F00.0' to 'F99.9' depending on the setting.

3 Press Shift button to shift the display into the setting standby mode.

- The third digit starts blinking, to which you can apply changes.

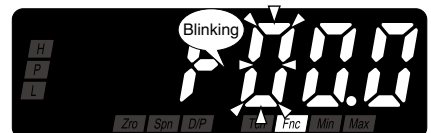

4 Press Shift and Up buttons to set the display refreshing rate.

- Set within the range of 'F00.0' to 'F99.9'.

.....
5 Press Alarm/↓ or Scale/↑ button to apply the new setting.

- And the next parameter setting is indicated.

NOTE

- Press Alarm/↓ button, and the version indication will be indicated.
 - Press Scale/↑ button, and the burnout 'BN U' or 'BN D' will be indicated depending on the setting.
-

.....
6 Hold down Alarm/↓ or Scale/↑ button for 3 seconds or more to return to Measuring Mode.

13. USEFUL FUNCTIONS

13.1 CONFIRMING ALARM SETPOINTS

The alarm setpoints set in Alarm Setting Mode can be confirmed while in Measuring Mode.

Each time pressing Alarm/↓ button during Measuring Mode, the indication is switched in the order of L alarm setpoint to H alarm setpoint and back to original indication.

■ PROCEDURE TO CONFIRM ALARM SETPOINTS

Each time pressing Alarm/↓ button in Measuring Mode, the indication is changed from the present value to L alarm setpoint to H alarm setpoint and back to present value.

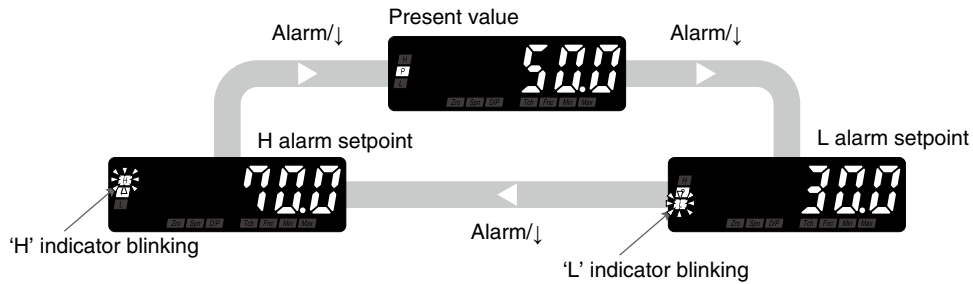

NOTE

- When “No alarm” is selected for the alarm point parameter in Alarm Setting Mode, alarm setpoints cannot be confirmed.
- The alarm setpoints can be confirmed even when MAX or MIN value is indicated. After confirmation, the indication will be back to MAX or MIN value.
- The alarm setpoints cannot be confirmed while ‘S.ERR’ or ‘B.ERR’ is indicated.

13.2 RETAINING MAX AND MIN VALUES

MAX and MIN values can be confirmed while in Measuring Mode. Each time pressing Max/Min button during Measuring Mode, the indication is switched in the order of MAX value to MIN value and back to original indication.

■ MAX AND MIN VALUES

MAX and MIN values are updated while in measuring.

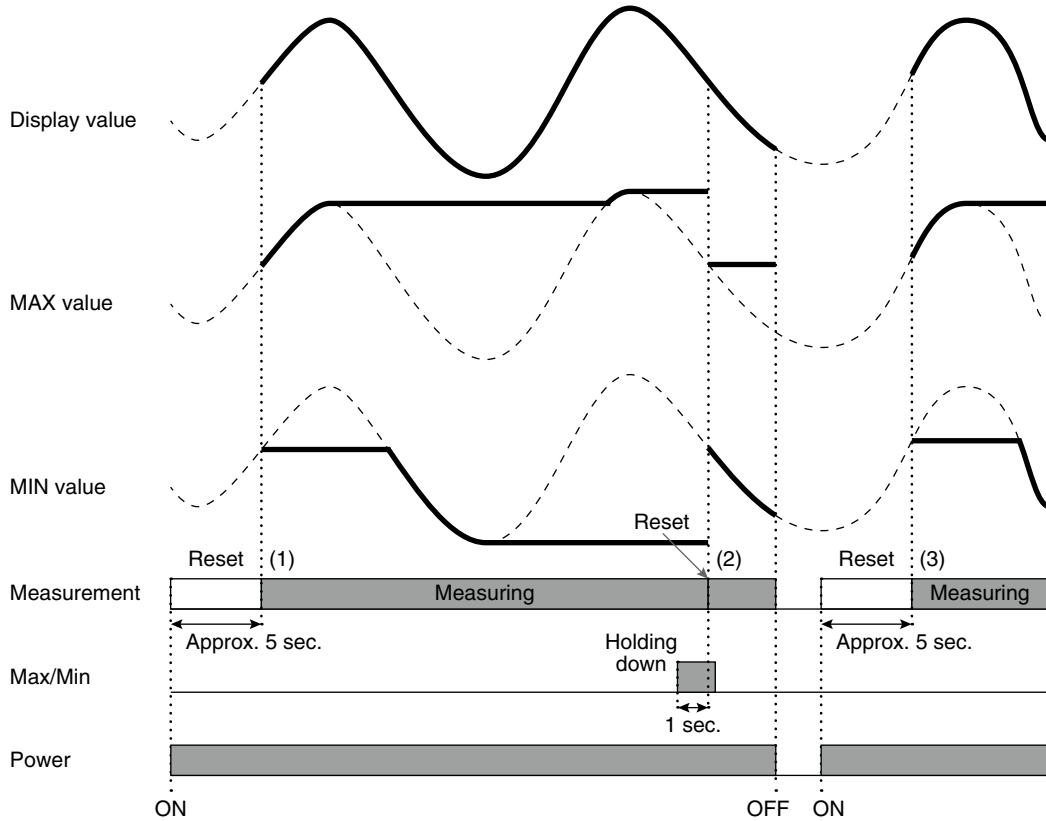

- (1) The internal memory is reset for approx. 5 seconds after the power is on, and the unit starts to measure MAX and MIN values.
- (2) Hold down Max/Min button for 1 second or more to reset the MAX and MIN values and then the unit starts to measure MAX and MIN values again.
- (3) The internal memory is reset for approx. 5 seconds after the power is off and on again, and then the unit starts to measure MAX and MIN values again.

■ PROCEDURE TO CONFIRM MAX OR MIN VALUE

- (1) Each time pressing Max/Min button during Measuring Mode, the indication is changed from the present value to MAX value, MIN value, and back to present value.
- (2) Hold down Max/Min button for 1 second or more to reset the MAX and MIN values and indicate new MAX and MIN values. The MAX and MIN values are reset when the power is turned off.

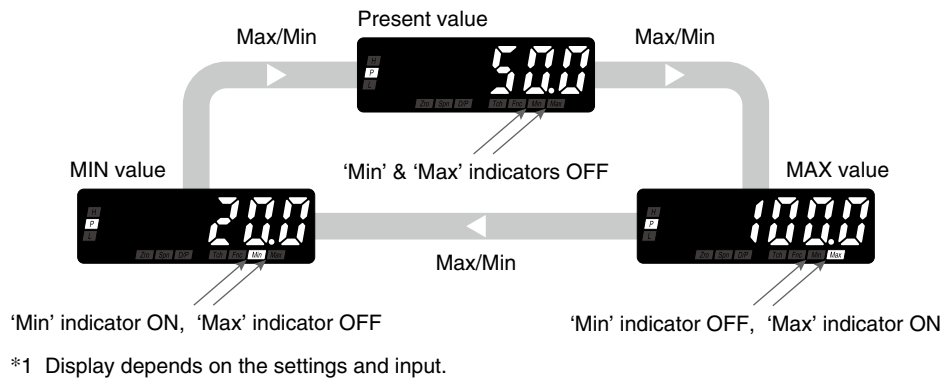

NOTE

- Pressing Max/Min button while in confirming the alarm setpoints switches the indication to MAX or MIN value.
- MAX and MIN values are not indicated while 'S.ERR' or 'B.ERR' is indicated.

13.3 LIMITING BUTTON OPERATION

Transition from Measuring Mode to each setting mode can be limited. With this setting, the transition to each mode by holding down the buttons will be disabled. In Lockout Setting Mode, the lockout per mode is selectable.

■ LOCKOUT SETTING

Following 3 lockout settings are available.

PARAMETER	INDICATORS	DISPLAY	FUNCTION	DEFAULT VALUE
Alarm setting lockout	D/P, Fnc	RoFF	Unlock Alarm Setting Mode	RoFF
		R ON	Lock Alarm Setting Mode	
Initial setting lockout		oFF	Unlock Initial Setting Mode	oFF
		i ON	Lock Initial Setting Mode	
Advanced setting lockout		doFF	Unlock Advanced Setting Mode	doFF
		d ON	Lock Advanced Setting Mode	

13.3.1 OPERATING PROCEDURE

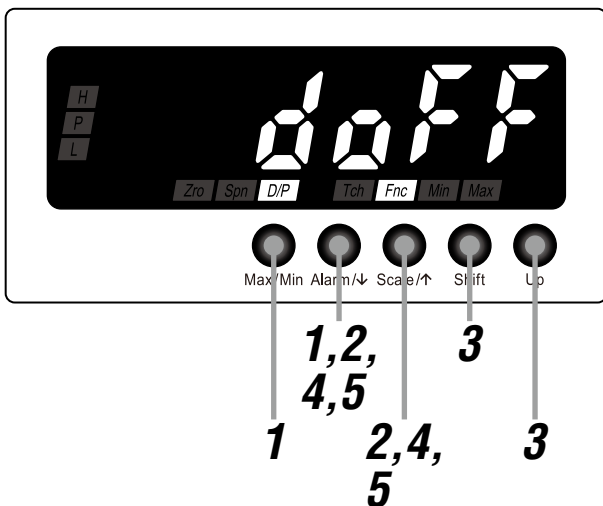

NOTE

- Procedures to lock the advanced setting mode are described here. The procedures to lock other setting modes are same. Select your desired mode to lock in Step 2.
- To cancel the limitation, select 'xOFF' in Step 3.

1 Hold down Max/Min and Alarm/↓ buttons at once for a preset time duration to move on to Lockout Setting Mode.

- The alarm setting lockout is indicated.
- 'D/P' and 'Fnc' indicators turn on.

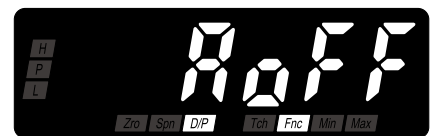

NOTE

'AOFF' or 'A ON' is indicated depending on the setting.

2 Press Alarm/↓ or Scale/↑ button to go to the advanced setting lockout setting.

- 'DOFF' is indicated.
- 'D/P' and 'Fnc' indicators turn on.



.....
3 Press Shift or Up button to select 'D ON'.

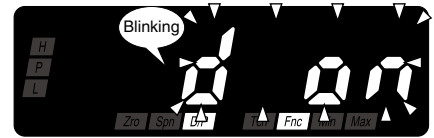

.....
4 Press Alarm/↓ or Scale/↑ button to apply the new setting.

- And the next parameter setting is indicated.

NOTE

- Press Alarm/↓ button, and the Initialization will be indicated.
 - Press Scale/↑ button, and the initial setting lockout 'IOFF' or 'I ON' will be indicated depending on the setting.
-

.....
5 Hold down Alarm/↓ or Scale/↑ button for 3 seconds or more to return to Measuring Mode.

13.4 TRANSITION TIME TO LOCKOUT SETTING MODE

Time duration to hold down the buttons for transition to Lockout Setting Mode can be set within the range of 0 to 99 seconds. The default value is 5 seconds.

13.4.1 OPERATING PROCEDURE

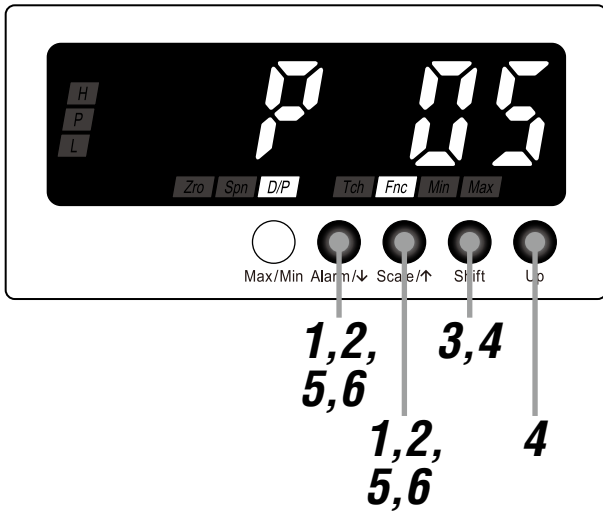

NOTE

The following figures are display examples. The displays depend on the settings.

1 Hold down Alarm/↓ and Scale/↑ buttons at once for 3 seconds or more to move on to Advanced Setting Mode.

- The moving average sampling No. is indicated.
- 'Fnc' indicator turns on.

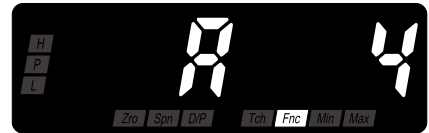

NOTE

'A OFF', 'A 2', 'A 4', 'A 8', 'A 16', 'A 32' or 'A 64' is indicated depending on the setting.

2 Press Alarm/↓ or Scale/↑ button to go to the setting of the transition time to Lockout Setting Mode.

- The transition time to Lockout Setting Mode is indicated.
- 'D/P' and 'Fnc' indicators turn on.



NOTE

The transition time is indicated within the range of 'P 00' to 'P 99' depending on the setting.

3 Press Shift button to shift the display into the setting standby mode.

- The second digit starts blinking, to which you can apply changes.

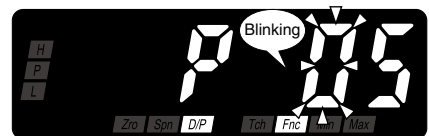

.....

4 Press Shift and Up buttons to set the transition time to Lockout Setting Mode.

- Set within the range of 'P 00' to 'P 99'.

.....

5 Press Alarm/↓ or Scale/↑ button to apply the new setting.

- And the next parameter setting is indicated.

NOTE

- Press Alarm/↓ button, and the burnout 'BN U' or 'BN D' will be indicated depending on the setting.
 - Press Scale/↑ button, and the setting time out will be indicated within the range of 'R 00' to 'R 99' depending on the setting.
-

.....

6 Hold down Alarm/↓ or Scale/↑ button for 3 seconds or more to return to Measuring Mode.

14. USER CALIBRATION

User calibration is calibration by a customer using customer’s measuring instruments and standards. To calibrate (adjust) the input signal, use “Input Compensation” function.

14.1 INPUT COMPENSATION

You can calibrate the input signal by the Input Compensation function if you need calibration. Two calibration points can be specified to compensate all the usable range by the slope connecting the points. The data will be lost after an initialization. Prepare measuring instruments and equipment for calibration by yourselves. Refer to each manual carefully for the instruments and equipment for information on handling them.

14.1.1 INPUT COMPENSATION FLOW

The Input Compensation is carried out as shown in the following flowchart.

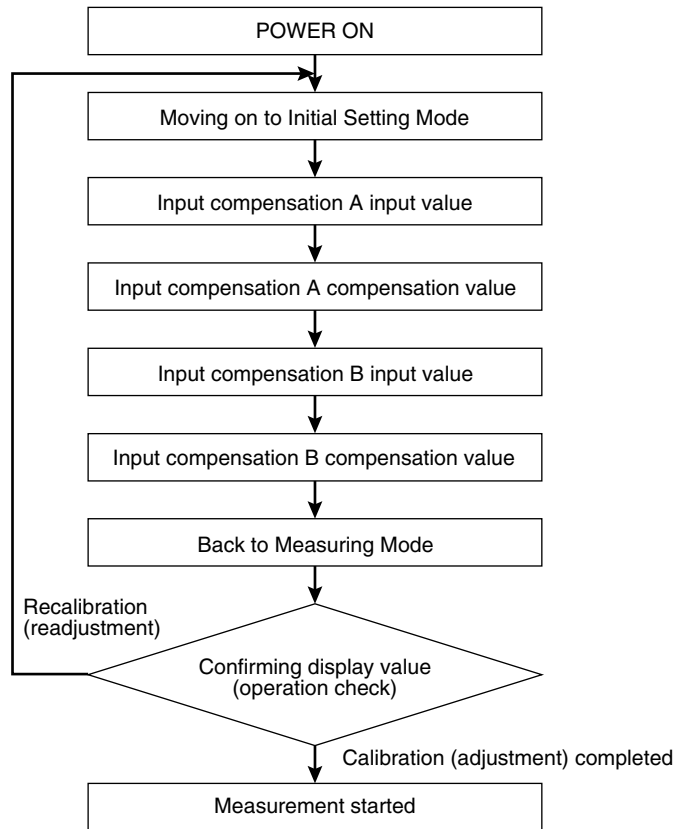

IMPORTANT

- Warm up measuring instruments, equipment and other devices on site for the time specified in each manual, and operate the unit in a stable condition.
- Two calibration points can be specified.
- Input compensation is not executed when A and B values are identical.
- When the temperature unit and decimal point position are changed, the input compensation A input value, input compensation A compensation value, input compensation B input value and input compensation B compensation value are initialized.
- Set the values within the range of -9999 to 9999.

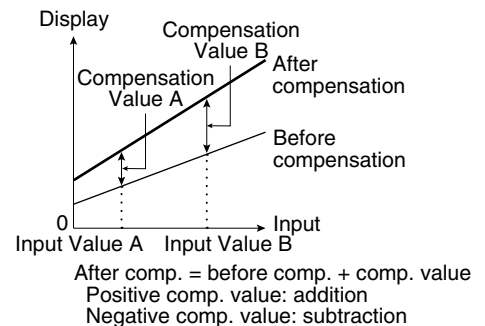

14.1.2 OPERATING PROCEDURE

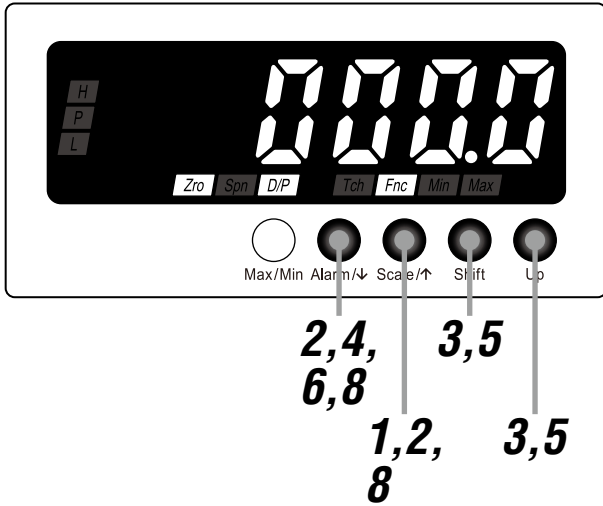

NOTE

The following figures are display examples. The displays depend on the settings.

1 Hold down Scale/↑ button for 3 seconds or more to move on to Initial Setting Mode.

- The temperature unit is indicated.
- 'Fnc' indicator turns on.

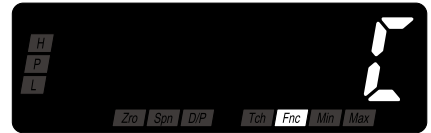

2 Press Alarm/↓ or Scale/↑ button to go to the input compensation A input value setting.

- The input compensation A input value is indicated.
- 'Zro', 'D/P' and 'Fnc' indicators turn on.



3 Press Shift button to shift the display into the setting standby mode. Press Shift and Up buttons to set the input compensation A input value.

- The fifth digit starts blinking, to which you can apply changes.
- Set within the range of -9999 to 9999.

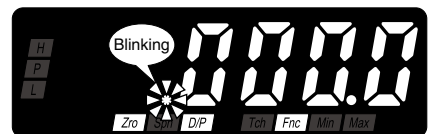

NOTE

When the temperature unit is set to °F or the decimal point position is set to no decimal point, set the value without decimal point.

4 Press Alarm/↓ button to register the value and to go to the input compensation A compensation value setting.

- The input compensation A input value is registered.
- The input compensation A compensation value is indicated.
- 'Zro', 'Tch' and 'Fnc' indicators turn on.



5 Press Shift button to shift the display into the setting standby mode. Press Shift and Up buttons to set the input compensation A compensation value.

- The fifth digit starts blinking, to which you can apply changes.
- Set within the range of -9999 to 9999.

* Set a positive value to set a higher value than the present one. Set a negative value to set a lower value.



NOTE

When the temperature unit is set to °F or the decimal point position is set to no decimal point, set the value without decimal point.

6 Press Alarm/↓ button to register the value and to go to the input compensation B input value setting.

- The input compensation A compensation value is registered.
- The input compensation B input value is indicated.
- 'Spn', 'D/P' and 'Fnc' indicators turn on.

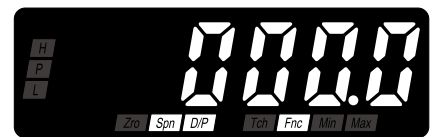

7 Set the input compensation B input value and input compensation B compensation value.

- Repeat the steps 2 to 6 to set the input compensation B input value and input compensation B compensation value.

* 'Spn', 'Tch' and 'Fnc' indicators turn on with input compensation B compensation value setting.

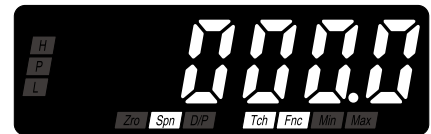

8 Hold down Alarm/↓ or Scale/↑ button for 3 seconds or more to return to Measuring Mode.

15. INSPECTION / CLEANING

To use the unit in the normal and best conditions, inspect and clean the unit routinely or periodically.

- When the display and the buttons have dirt, wipe them with wet soft cloth. Do not use organic solvent such like benzine, thinner and alcohol. Doing so may result in deformation or discoloration of the unit.
- Make sure that abnormality such like smokes, unusual smell or abnormal noises is not found. Using the unit continuously with such abnormality may result in a fire or electric shock.
- Check the wiring periodically. In checking the wiring, for safety, interrupt electricity to the power, input and alarm output.
- Make sure periodically that the screws are fixed tightly. Loosened screws may cause drop of the unit.

16. TROUBLESHOOTING

16.1 ERROR MESSAGES

MAIN DISPLAY	ERROR MESSAGE	WHAT TO DO
	Input error, Out of the measurable range	Increase/decrease the input signal until it is back within the measurable range.
	Input wire breakdown (burnout)	Check the input wires.
	Non-volatile memory error (reading)	Initialize the unit to its factory default status at the lockout setting mode.*1
	Non-volatile memory error (writing)	
	Internal data error	Repair is needed if the display does not recover after the power is reset.

*1 If the unit does not recover its function after the initialization, repairing in the factory may be required.

16.2 INITIALIZING SETTING VALUES

To restart setting from the default state, initialization can be used. Refer to attached 17.3 PARAMETER LIST for the default values.

IMPORTANT

- Currently set parameters will be lost after an initialization. It is recommended to record the parameters before initialization.
- Even if the unit is shipped with the specified parameters with the option code '/SET'; such parameters will be lost after an initialization. Be careful that the initialization does not recover the ex-factory settings.

16.2.1 OPERATING PROCEDURE

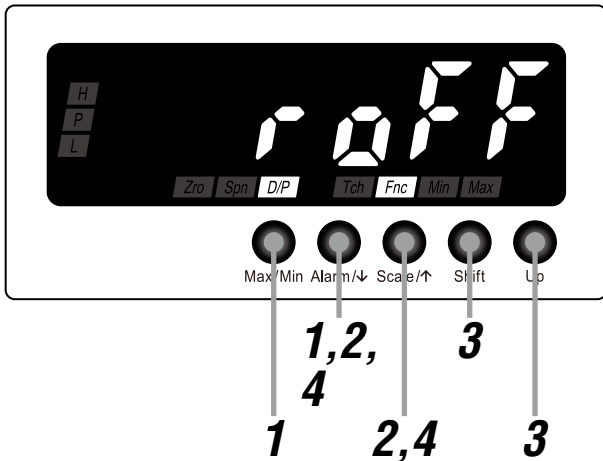

1 Hold down Max/Min and Alarm/↓ buttons at once for a preset time duration to move on to Lockout Setting Mode.

- The alarm setting lockout is indicated.
- 'D/P' and 'Fnc' indicators turn on.

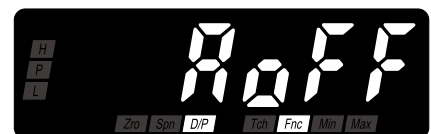

NOTE

'A OFF' or 'A ON' is indicated depending on the setting.

2 Press Alarm/↓ or Scale/↑ button to go to the initialization.

- 'ROFF' is indicated.
- 'D/P' and 'Fnc' indicators turn on.

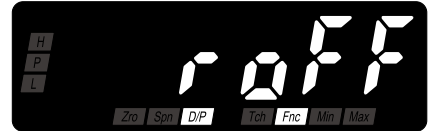

3 Press Shift or Up button to select 'RST'.

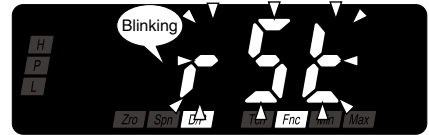

4 Press Alarm/↓ or Scale/↑ button to execute the initialization.

- The initialization will be completed in approx. 3 seconds and the display will return to Measuring Mode.

16.3 CONFIRMING FIRMWARE VERSION

The firmware version of the unit can be confirmed.

Confirm the version in the following cases:

- The display is different from the one described in the operating manual.
- The firmware version is necessary to consult us for troubles.

16.3.1 OPERATING PROCEDURE

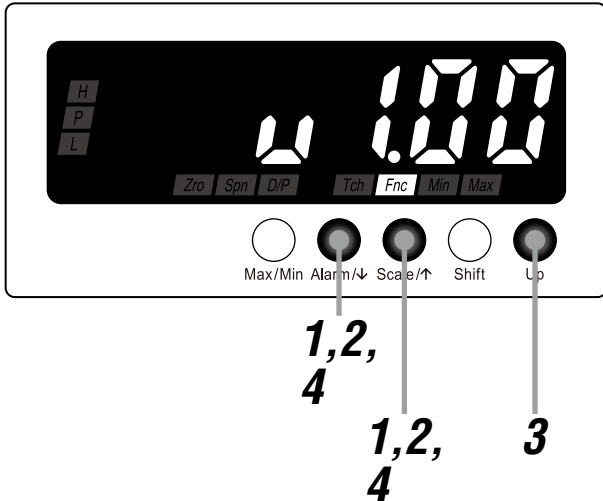

1 Hold down Alarm/↓ and Scale/↑ buttons at once for 3 seconds or more to move on to Advanced Setting Mode.

- The moving average sampling No. is indicated.
- 'Fnc' indicator turns on.

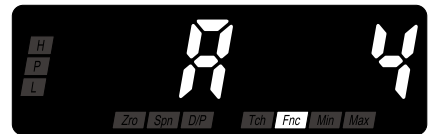

NOTE

'A OFF', 'A 2', 'A 4', 'A 8', 'A 16', 'A 32' or 'A 64' is indicated depending on the setting.

2 Press Alarm/↓ or Scale/↑ button to go to the version indication.

- The first half of the firmware version number is indicated.
- 'Fnc' indicator turns on.



3 Press Up button to indicate another 4 digits of the version number.



NOTE

- The above figures show the firmware version V1.00.0015.
- The displays depend on the firmware version number.

4 Hold down Alarm/↓ or Scale/↑ button for 3 seconds or more to return to Measuring Mode.

17. APPENDICES

17.1 SPECIFICATIONS

■ GENERAL SPECIFICATIONS

Construction		Panel mount type
Degree of protection		IP66; Applicable to the front of the panel meter mounted according to the specified panel cutout. Only screw mounting conforms.
Connection		Screwless spring terminal
Applicable wire size		0.2 to 0.5 mm ² , stripped length 6 mm
Housing material		Flame-resistant (gray)
Isolation		Input to alarm output to power
Burnout		Upscale standard; downscale optional by programming
Setting (front button)	Initial setting mode	Temperature unit, decimal point position, input compensation A input/compensation value, input compensation B input/compensation value
	Alarm setting mode	Alarm point, H/L alarm setpoint, H/L trip action, H/L deadband (hysteresis), H/L trip delay, H/L coil at alarm, main display blinking at alarm
	Advanced setting mode	Moving average, brightness, setting time out, transition time to Lockout Setting Mode, burnout, display refreshing rate, version indication
	Lockout setting mode	Alarm setting lockout, initial setting lockout, advanced setting lockout, initialization
Averaging		None or moving average
Lockout setting		Prohibiting certain operations; protecting settings

■ DISPLAY

Display		16 mm (.63) high, 4 digits, 7-segment LED
Display range		-9999 to 9999
Minimum display/setting scale		0.1°C or 1°F
Decimal point position		10 ⁻¹ or none
Zero indication		Higher-digit zeros are suppressed
Over-range indication		'S.ERR' and 'Min' or 'Max' blinking when the input signal is out of the usable range.
Burnout indication		'B.ERR' and function status 'Min' or 'Max' are displayed and blinking.
Alarm status indication	L indicator	Green turns on when the L alarm is tripped
	H indicator	Red turns on when the H alarm is tripped
	P indicator	Amber turns on when none of the other alarms is tripped Only 'P' turns on when no-alarm is selected with alarm setpoint
Function indicators		Zro, Spn, D/P, Tch, Fnc, Min, Max Display mode status and operation status, amber ON or blink

■ INPUT SPECIFICATIONS

RTD		3-wire RTDs
Maximum leadwire resistance		60 Ω per wire
Sensing current	JPt 100 (JIS '89)	0.5 mA
	Pt 100 (JIS '89)	0.5 mA
	Pt 100 (JIS '97, IEC)	0.5 mA
	Pt 50 Ω (JIS '81)	0.5 mA
	Pt 1000	0.05 mA

Temperature range	JPt 100 (JIS '89)	Conformance range	-200 to +500°C, -328 to +932°F
		Usable range	-230 to +530°C, -382 to +986°F
	Pt 100 (JIS '89)	Conformance range	-200 to +650°C, -328 to +1202°F
		Usable range	-230 to +680°C, -382 to +1256°F
	Pt 100 (JIS '97, IEC)	Conformance range	-200 to +850°C, -328 to +1562°F
		Usable range	-230 to +880°C, -382 to +1616°F
	Pt 50 Ω (JIS '81)	Conformance range	-200 to +649°C, -328 to +1202°F
		Usable range	-230 to +679°C, -382 to +1256°F
Pt 1000	Conformance range	-200 to +850°C, -328 to +1562°F	
	Usable range	-230 to +880°C, -382 to +1616°F	

■ OUTPUT SPECIFICATIONS

Alarm output		Photo MOSFET relay
	Rating	26.4 V DC @ 100 mA (resistive load)
	ON resistance	≤ 5 Ω

■ INSTALLATION

Power consumption	DC power	24 V DC	Operational voltage range 24 V DC ±10% Ripple 10% p-p max. 0.7 W max.
Operating temperature		-10 to +55°C (14 to 131°F)	
Operating humidity		10 to 90% RH (non-condensing)	
Mounting		Magnet or screw mounting	
Weight		85 g (3.0 oz)	

■ PERFORMANCE

Accuracy	±1°C ±1 digit (±2°F ±1 digit)
Temp. coefficient	±0.015%/°C (±0.008%/°F)
Response time	≤ 0.5 sec. (alarm output: 0 – 100% at 90% setpoint)
Burnout response	≤ 10 sec.
Line voltage effect	±0.1% over voltage range
Insulation resistance	≥ 100 MΩ with 500 V DC
Dielectric strength	1500 V AC @ 1 minute (input to alarm output to power to ground)

■ STANDARDS & APPROVALS

EU conformity	EMC Directive EMI EN 61000-6-4 EMS EN 61000-6-2 RoHS Directive
---------------	---

17.2 MODEL NUMBERING

Code number: **47NLR-[1][2]-R[3]**

[1] INPUT

- 1: JPt 100 (JIS '89)
- 3: Pt 100 (JIS '89)
- 4: Pt 100 (JIS '97, IEC)
- 5: Pt 50 Ω (JIS '81)
- 7: Pt 1000

[2] DISPLAY COLOR

- R: Red
- YR: Orange
- G: Green
- B: Blue
- W: White

POWER INPUT

DC Power

R: 24 V DC (operational voltage range 24 V \pm 10%, ripple 10% p-p max.)

[3] OPTIONS

Blank: None

/Q: With options (specify the specification)

■ SPECIFICATIONS OF OPTION: Q

EX-FACTORY SETTING

/SET: Preset according to the Ordering Information Sheet (No. ESU-9565)

17.3 PARAMETER LIST

MODE	PARAMETER	SETTING RANGE	INDICATOR	DISPLAY	DEFAULT VALUE	DECIMAL POINT POSITION	UNIT
Measuring	Present value	-9999 – 9999	[H], [P], [L]	----	----	*1	°C/°F
	MAX value	-9999 – 9999	[Max]	----	----	*1	°C/°F
	MIN value	-9999 – 9999	[Min]	----	----	*1	°C/°F
	L alarm setpoint	-9999 – 9999	[L]	----	----	*1	°C/°F
	H alarm setpoint	-9999 – 9999	[H]	----	----	*1	°C/°F
Initial setting	Temperature unit	°C, °F	[Fnc]	[C] [F] [C]	[C]	---	---
	Decimal point position	1 decimal place, no decimal point	[DIP], [Fnc]	[d on], [doff], [d on]	[d on]	---	---
	Input comp. A input value	-9999 – 9999	[Zco], [DIP], [Fnc]	[9999] to [9999]	[0000]	*1	°C/°F
	Input comp. A comp. value	-9999 – 9999	[Zco], [Tch], [Fnc]	[9999] to [9999]	[0000]	*1	°C/°F
	Input comp. B input value	-9999 – 9999	[Spc], [DIP], [Fnc]	[9999] to [9999]	[0000]	*1	°C/°F
	Input comp. B comp. value	-9999 – 9999	[Spc], [Tch], [Fnc]	[9999] to [9999]	[0000]	*1	°C/°F
Alarm setting	Alarm point	Dual alarm	[H], [L], [Fnc]	[ALn2]	[ALn2]	---	---
		No alarm	[P], [Fnc]	[ALn0]		---	---
	L alarm setpoint	-9999 – 9999	[L], [Fnc]	[9999] to [9999]	[0300]	*1	°C/°F
	L trip action	High trip, low trip	[L], [Fnc]	[LnHi], [LnLo], [LnLo]		---	---
	L deadband (hysteresis)	0000 – 9999	[P], [L], [Fnc]	[0000] to [9999]	[0000]	---	°C/°F
	L trip delay	00 – 99	[L], [DIP], [Fnc]	[00] to [99]	[00]	---	Second
	L coil at alarm	Coil energized at alarm, de-energized at alarm	[L], [Fnc]	[rYEn], [rYdn], [rYEn]		---	---
	H alarm setpoint	-9999 – 9999	[H], [Fnc]	[9999] to [9999]	[0700]	*1	°C/°F
	H trip action	High trip, low trip	[H], [Fnc]	[LnHi], [LnLo], [LnHi]		---	---
	H deadband (hysteresis)	0000 – 9999	[H], [P], [Fnc]	[0000] to [9999]	[0000]	---	°C/°F
	H trip delay	00 – 99	[H], [DIP], [Fnc]	[00] to [99]	[00]	---	Second
	H coil at alarm	Coil energized at alarm, de-energized at alarm	[H], [Fnc]	[rYEn], [rYdn], [rYEn]		---	---
	Main display blinking at alarm	No blinking, blinking in 1.0, 0.5, 0.2, 0.1 sec. intervals	[Fnc]	[b 0], [b 1], [b 2], [b 3], [b 4]	[b 0]	---	Second

*1 Conforms to decimal point position setting.

NOTE 1: Indicators with the present value in Measuring Mode depend on the set alarm trip action.

NOTE 2: INDICATOR: [] = ON, [] = Blinking

MODE	PARAMETER	SETTING RANGE	INDICATOR	DISPLAY	DEFAULT VALUE	DECIMAL POINT POSITION	UNIT								
Advanced setting	Moving average	None, 2, 4, 8, 16, 32, 64	[Fnc]	<table border="1"> <tr><td>RoFF</td><td>R 2</td></tr> <tr><td>R 4</td><td>R 8</td></tr> <tr><td>R 16</td><td>R 32</td></tr> <tr><td>R 64</td><td></td></tr> </table>	RoFF	R 2	R 4	R 8	R 16	R 32	R 64		R 4	----	Sample
	RoFF	R 2													
	R 4	R 8													
	R 16	R 32													
	R 64														
	Brightness	1 (dark) to 5 (bright)	[DIP], [Fnc]	<table border="1"> <tr><td>L 1</td><td>L 2</td></tr> <tr><td>L 3</td><td>L 4</td></tr> <tr><td>L 5</td><td></td></tr> </table>	L 1	L 2	L 3	L 4	L 5		L 3	----	----		
	L 1	L 2													
L 3	L 4														
L 5															
Setting time out	00 (setting time out disabled) 01 – 99	[DIP], [Fnc]	r 00 to r 99	r 60	----	Second									
Transition time to Lockout Setting Mode	00 – 99	[DIP], [Fnc]	P 00 to P 99	P 05	----	Second									
Burnout	Upscale burnout, downscale burnout	[Fnc]	bn U, bn d	bn U	----	----									
Display refreshing rate	00.0 – 99.9	[Fnc]	F000 to F999	F000	----	Second									
Version indication	----	[Fnc]	----	----	----	----									
Lockout setting	Alarm setting lockout	OFF, ON	[DIP], [Fnc]	RoFF, R on	RoFF	----	----								
	Initial setting lockout	OFF, ON	[DIP], [Fnc]	,oFF, , on	,oFF	----	----								
	Advanced setting lockout	OFF, ON	[DIP], [Fnc]	doFF, d on	doFF	----	----								
	Initialization	OFF, initialization	[DIP], [Fnc]	roFF, r 5t	roFF	----	----								

NOTE 2: INDICATOR: = ON, = Blinking

17.4 PARAMETER MAP

17.4.1 OPERATION IN MEASURING MODE

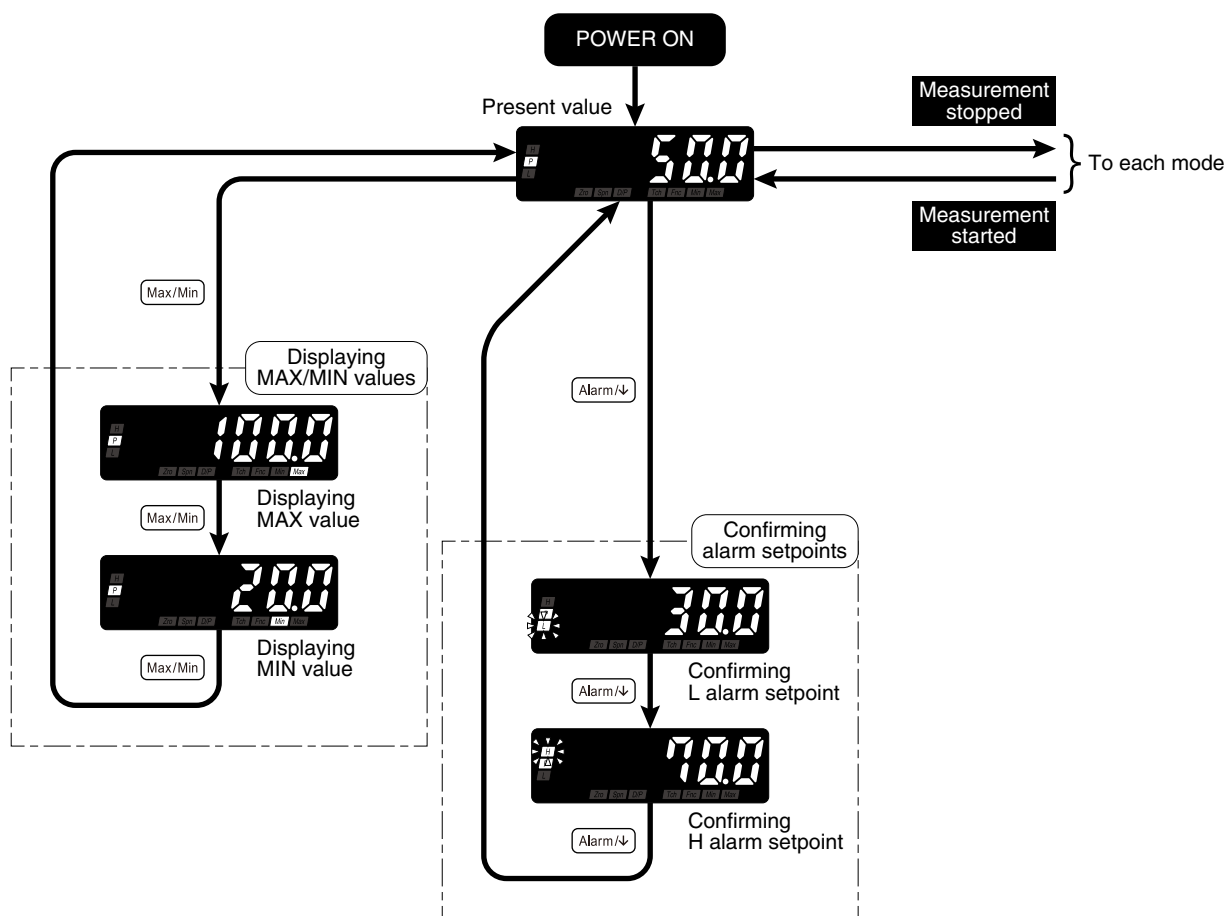

NOTE

- The display depends on the settings and input.
- When "No alarm" is selected for the alarm point parameter, alarm setpoints cannot be confirmed.

17.4.2 INITIAL SETTING MODE

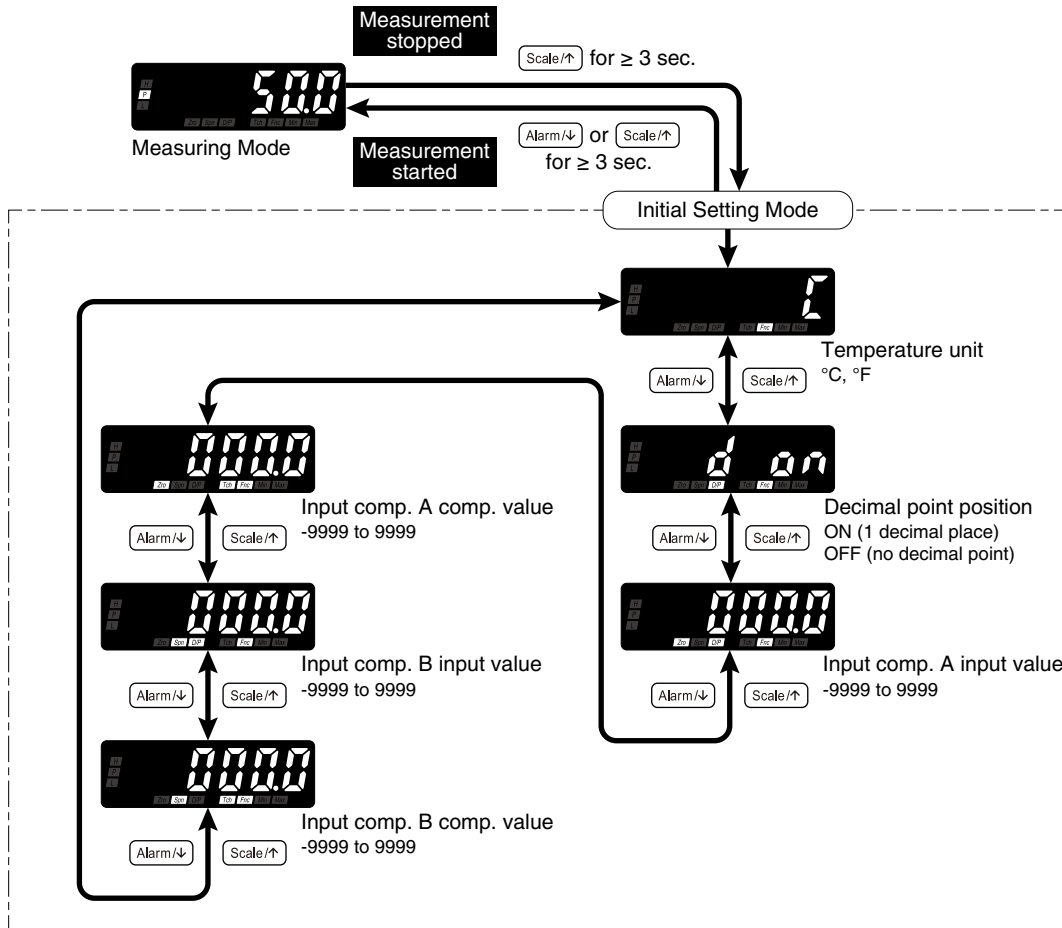

NOTE

The display depends on the settings and input.

17.4.3 ALARM SETTING MODE

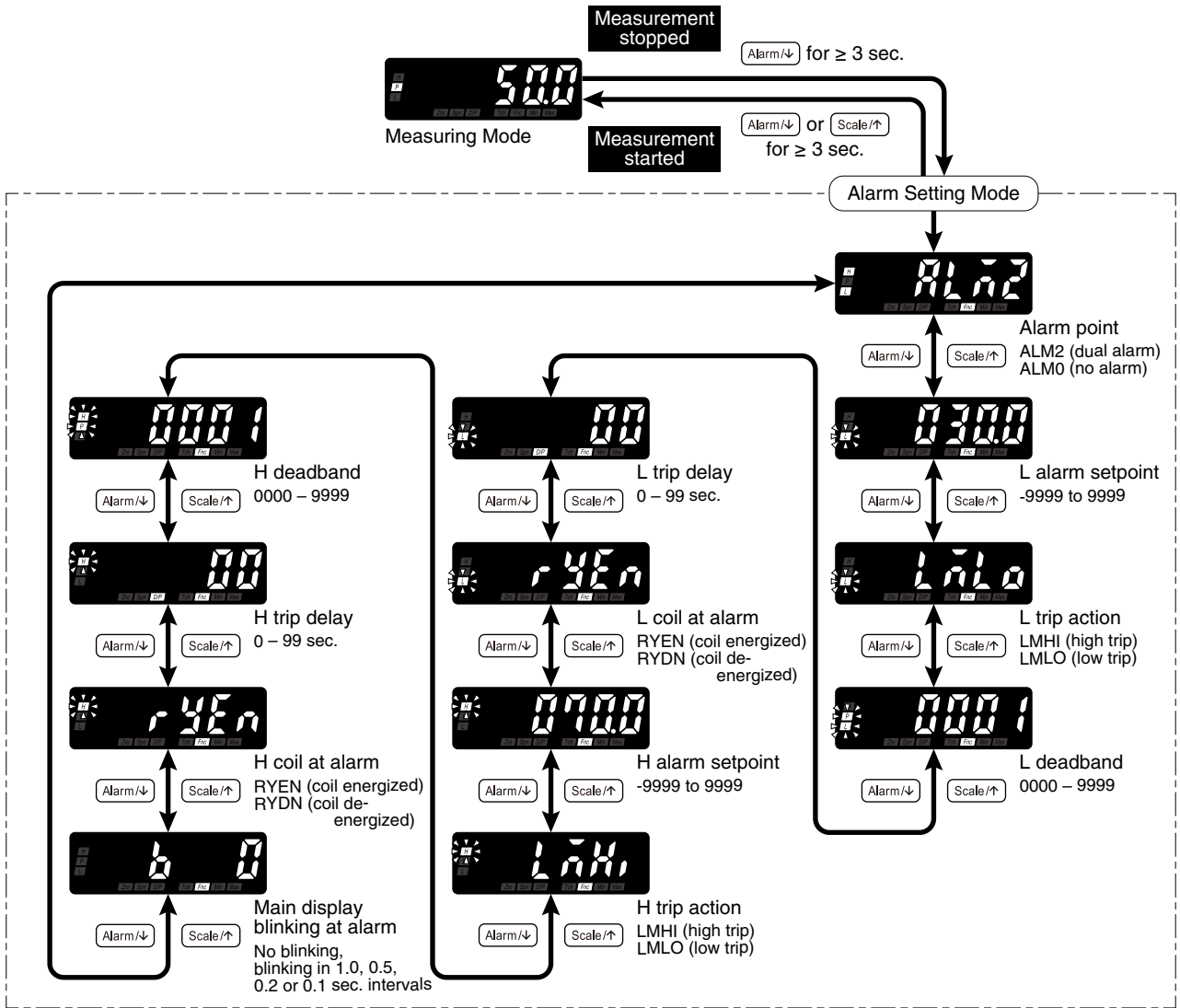

NOTE

- The display depends on the settings and input.
- Alarm Setting Mode is locked when “No alarm” is selected for the alarm point parameter.

17.4.4 ADVANCED SETTING MODE

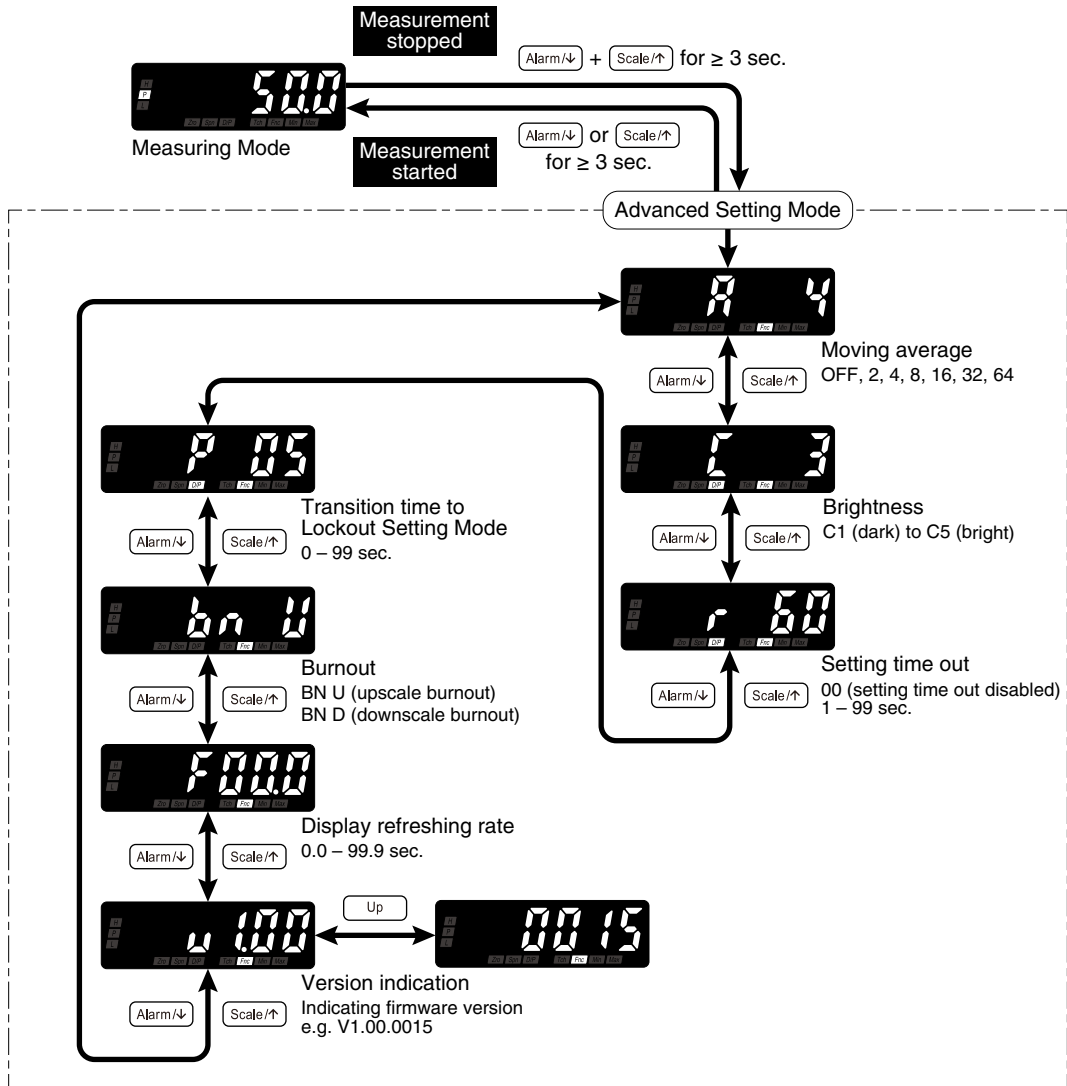

NOTE

- The display depends on the settings and input.
- Version indication is for indication only, not for setting.

17.4.5 LOCKOUT SETTING MODE

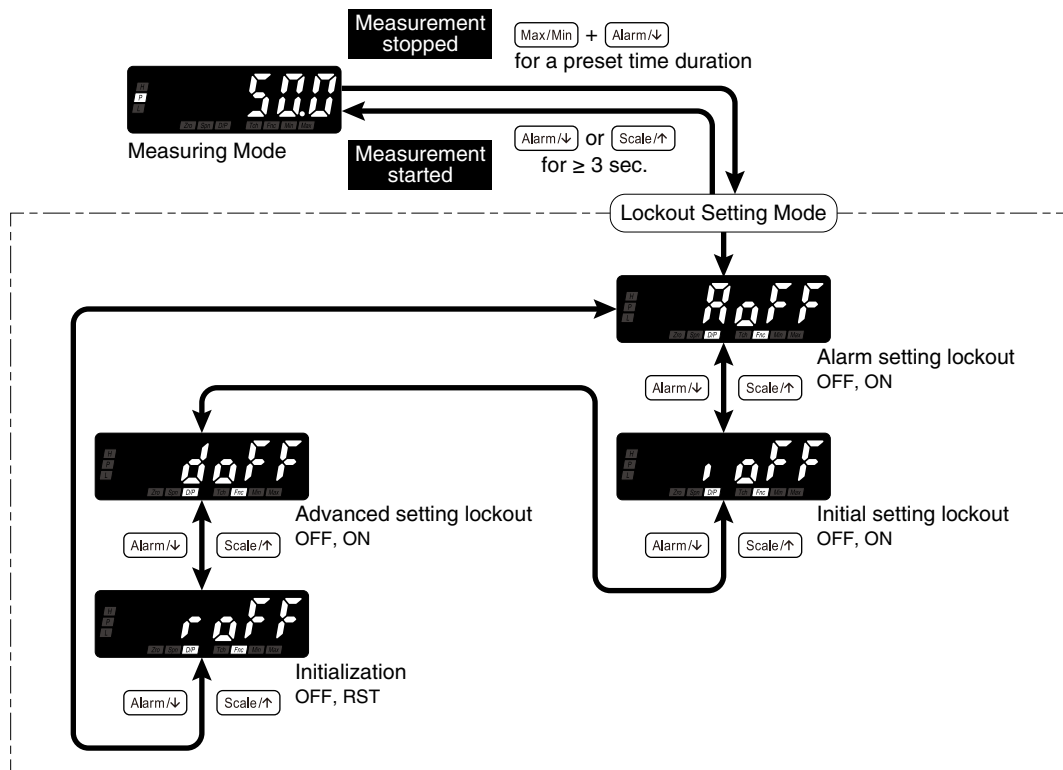











NOTE





















The display depends on the settings and input.

17.5 CHARACTER SET

■ NUMERALS AND NEGATIVE SIGN

0	1	2	3	4	5	6	7	8	9
									
-									
.									

■ ALPHABET

A	B	C	D	E	F	G	H	I	J
									
K	L	M	N	O	P	Q	R	S	T
									
U	V	W	X	Y	Z				
