

Digital Panel Meters 47NL Series
LOOP POWERED DIGITAL PANEL METER
(4 1/2 digit, LED display type)

Model: 47NLN

OPERATING MANUAL

CONTENTS

1. INTRODUCTION	5
1.1 BEFORE USE.....	5
1.2 SAFETY PRECAUTIONS (that must be observed).....	6
1.3 POINTS OF CAUTION.....	8
1.4 COMPONENT IDENTIFICATION.....	10
1.5 INSTALLATION.....	13
1.5.1 EXTERNAL DIMENSIONS	13
1.5.2 INSTALLATION	13
1.6 WIRING INSTRUCTIONS.....	17
1.6.1 CAUTION IN WIRING	17
1.6.2 APPLICABLE WIRE	17
1.6.3 WIRING.....	17
1.6.4 TERMINAL ASSIGNMENT.....	18
1.6.5 WIRING INPUT SIGNAL.....	19
2. BASIC SETTING AND OPERATION	20
2.1 BASIC SETTING	20
2.1.1 BASIC SETTING FLOW.....	20
2.1.2 RELATION BETWEEN INPUT SCALING AND DISPLAY SCALING	20
2.1.3 BASIC SETTING PROCEDURE	21
2.2 BASIC SETTING OPERATION AND INSTRUCTIONS	22
2.2.1 BASIC SETTING OPERATION.....	22
2.2.2 INSTRUCTIONS ON BASIC OPERATION.....	24
3. SETTING SCALING VALUES	25
3.1 STEP 1. INPUT SCALING ZERO.....	27
3.1.1 OPERATING PROCEDURE	27
3.2 STEP 2. DISPLAY SCALING ZERO	29
3.2.1 OPERATING PROCEDURE.....	29
3.3 STEP 3. INPUT SCALING SPAN.....	31
3.3.1 OPERATING PROCEDURE.....	31
3.4 STEP 4. DISPLAY SCALING SPAN.....	33
3.4.1 OPERATING PROCEDURE.....	33
3.5 STEP 5. DECIMAL POINT POSITION	35
3.5.1 OPERATING PROCEDURE.....	35
4. OPERATION	37
5. PARAMETER CONFIGURATION	38

6. AVERAGING INPUT	42
6.1 OPERATING PROCEDURE	43
7. ELIMINATING FLUCTUATION AROUND “0”	44
7.1 LOW-END CUTOUT	45
7.1.1 OPERATING PROCEDURE	45
7.2 LOW-END CUTOUT VALUE.....	47
7.2.1 OPERATING PROCEDURE.....	47
8. ADJUSTING BRIGHTNESS OF DISPLAY	49
8.1 OPERATING PROCEDURE	50
9. GOING BACK AUTOMATICALLY TO MEASURING MODE	52
9.1 OPERATING PROCEDURE	53
10. ADJUSTING DISPLAY REFRESHING RATE	55
10.1 OPERATING PROCEDURE	56
11. USEFUL FUNCTIONS	58
11.1 FORCING THE PRESENT DISPLAY VALUE TO ZERO	58
11.2 RETAINING MAX AND MIN VALUES.....	59
11.3 LIMITING BUTTON OPERATION.....	61
11.3.1 OPERATING PROCEDURE.....	61
11.4 TRANSITION TIME TO LOCKOUT SETTING MODE	63
11.4.1 OPERATING PROCEDURE.....	63
12. USER CALIBRATION.....	65
12.1 TEACH CALIBRATION	65
12.1.1 TEACH CALIBRATION FLOW.....	65
12.1.2 OPERATING PROCEDURE.....	66
13. INSPECTION / CLEANING	68
14. TROUBLESHOOTING	69
14.1 ERROR MESSAGES.....	69
14.2 INITIALIZING SETTING VALUES.....	69
14.2.1 OPERATING PROCEDURE	69
14.3 CONFIRMING FIRMWARE VERSION	71
14.3.1 OPERATING PROCEDURE	71

15. APPENDICES	72
15.1 SPECIFICATIONS	72
15.2 MODEL NUMBERING	73
15.3 PARAMETER LIST	74
15.4 PARAMETER MAP	75
15.4.1 OPERATION IN MEASURING MODE.....	75
15.4.2 SCALING SETTING MODE.....	76
15.4.3 ADVANCED SETTING MODE.....	77
15.4.4 LOCKOUT SETTING MODE	78
15.5 CHARACTER SET	79

1. INTRODUCTION

1.1 BEFORE USE....

Thank you for choosing us. Before use, please check contents of the package you received as outlined below.

■ PACKAGE INCLUDES

Digital panel meter

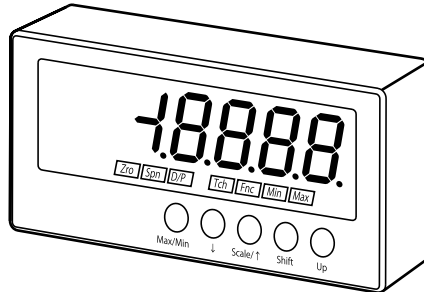

Accessories

<p>Watertight packing (1)</p>	<p>Magnet label sheet (1)</p>	<p>Stopper (1)</p>	<p>Unit fixing screw (4)</p> <p>(screw size: M4 x 10)</p>																																																																	
<p>Engineering unit sticker label sheet (1)</p> <table border="1" data-bbox="264 1339 437 1668"> <tbody> <tr><td>DC</td><td>AC</td><td>mV</td></tr> <tr><td>V</td><td>kV</td><td>μA</td></tr> <tr><td>mA</td><td>A</td><td>kA</td></tr> <tr><td>mW</td><td>W</td><td>kW</td></tr> <tr><td>var</td><td>kvar</td><td>Mvar</td></tr> <tr><td>VA</td><td>kVA</td><td>Ω</td></tr> <tr><td>kΩ</td><td>MΩ</td><td>cm</td></tr> <tr><td>mm</td><td>m</td><td>m/sec</td></tr> <tr><td>mm/min</td><td>cm/min</td><td>m/min</td></tr> <tr><td>m/h</td><td>m/s²</td><td>inch</td></tr> <tr><td>l</td><td>l/s</td><td>l/min</td></tr> <tr><td>l/h</td><td>m²</td><td>m²/sec</td></tr> <tr><td>m³/min</td><td>m³/h</td><td>Nm/h</td></tr> <tr><td>N · m</td><td>N/m²</td><td>g</td></tr> <tr><td>kg</td><td>kg/h</td><td>N</td></tr> <tr><td>kN</td><td>Pa</td><td>kPa</td></tr> <tr><td>MPa</td><td>t</td><td>t/h</td></tr> <tr><td>°C</td><td>°F</td><td>%RH</td></tr> <tr><td>J</td><td>kJ</td><td>MJ</td></tr> <tr><td>rpm</td><td>sec</td><td>min</td></tr> <tr><td>pH</td><td>%</td><td>ppm</td></tr> <tr><td colspan="3">NXXXXXX</td></tr> </tbody> </table>	DC	AC	mV	V	kV	μA	mA	A	kA	mW	W	kW	var	kvar	Mvar	VA	kVA	Ω	kΩ	MΩ	cm	mm	m	m/sec	mm/min	cm/min	m/min	m/h	m/s ²	inch	l	l/s	l/min	l/h	m ²	m ² /sec	m ³ /min	m ³ /h	Nm/h	N · m	N/m ²	g	kg	kg/h	N	kN	Pa	kPa	MPa	t	t/h	°C	°F	%RH	J	kJ	MJ	rpm	sec	min	pH	%	ppm	NXXXXXX			<p>Instruction manual</p>	<p>Ordering Information Sheet</p> <p>(included with the option code 'SET' only)</p>
DC	AC	mV																																																																		
V	kV	μA																																																																		
mA	A	kA																																																																		
mW	W	kW																																																																		
var	kvar	Mvar																																																																		
VA	kVA	Ω																																																																		
kΩ	MΩ	cm																																																																		
mm	m	m/sec																																																																		
mm/min	cm/min	m/min																																																																		
m/h	m/s ²	inch																																																																		
l	l/s	l/min																																																																		
l/h	m ²	m ² /sec																																																																		
m ³ /min	m ³ /h	Nm/h																																																																		
N · m	N/m ²	g																																																																		
kg	kg/h	N																																																																		
kN	Pa	kPa																																																																		
MPa	t	t/h																																																																		
°C	°F	%RH																																																																		
J	kJ	MJ																																																																		
rpm	sec	min																																																																		
pH	%	ppm																																																																		
NXXXXXX																																																																				

■ MODEL NO.

Confirm Model No. marking on the product to be exactly what you ordered.



1.2 SAFETY PRECAUTIONS (that must be observed)

The following signs are used in this manual to provide precautions required to ensure safe usage of the unit. Please understand these signs and graphic symbols, read the manual carefully and observe the description.

The following signs show seriousness of safety hazard or damage occurred when used wrongly with the signs ignored.

 WARNING	Indicates a potentially hazardous situation which, if not avoided, may result in serious injury or death.
--	---

 CAUTION	Indicates a potentially hazardous situation which, if not avoided, may result in injury or in property damage.
--	--

 Indicates prohibitions.	 Indicates mandatory cautions.	 Indicates cautions.
---	---	---

WARNING



CAUTION

For safety, make sure that wiring is performed by qualified personnel only.

- Failure to do so may result in a fire, electric shock or injury.



CAUTION
ELECTRIC SHOCK

Do not touch the terminals while the power is on.

- Doing so may result in electric shock.



MANDATORY
CAUTION

Check the connection diagram carefully before wire connection.

- Failure to do so may result in malfunction, a fire or electric shock.



MANDATORY
CAUTION

Provide safety measures outside of the unit to ensure safety in the whole system if an abnormality occurs due to malfunction of the unit or another external factor affecting the unit's operation.



PROHIBITION
TO BE WET

Do not splash water on the unit except for the front panel installed correctly.

- Doing so may result in a fire, electric shock or injury.



MANDATORY
CAUTION

Stop using the unit immediately if smokes, unusual smell or abnormal noises come(s) from it.

- Using the unit continuously may result in a fire or electric shock.



MANDATORY
CAUTION

Stop using the unit if it is dropped or damaged.

- Using the unit continuously may result in a fire or electric shock.



PROHIBITION

Do not throw the unit into the fire.

- Doing so may result in rupture of the electronic component.

CAUTION



PROHIBITION
TO DISCOMPOSE

- Never discompose or remodel the unit.
- Doing so may result in electric shock, malfunction or injury.



PROHIBITION

- Do not connect or remove the unit while its input signal is supplied.
- Doing so may result in electric shock, malfunction or injury.



MANDATORY
CAUTION

- Do not allow fine shavings or wire scraps to enter the unit in machining screws or wiring.
- Doing so may result in malfunction of the unit.



PROHIBITION

- Do not press buttons with a pointed object.
- Doing so may result in malfunction of the unit.



PROHIBITION

- Do not pull the wires connecting to the unit.
- Doing so may result in electric shock, damage of the unit or injury.



PROHIBITION

- Do not use the unit in the atmosphere where combustible gas is present.
- Doing so may result in inflammation, ignition or smoke.

1.3 POINTS OF CAUTION

■ CONFORMITY WITH EU DIRECTIVES

- Our products conforming to the EU Directives conforms to the standards required based on the premise that they are built into various equipment, apparatus or control panels to use. Because the EMC performance depends on the configuration, wiring or arrangement of the equipment, apparatus and control panels you build, it is necessary for you to make such equipment, apparatus or control panels to conform finally to the CE Marking by yourselves.

CAUTION

This product conforms to the EMC Directive for electrical and electronic apparatus intended for use in industrial environments. If it is used in the residential environments, it may cause radio interference, and the user is requested to take appropriate measures.

■ ENVIRONMENT

Install the unit within the installation specifications.

- Indoors use.
- Environmental temperature must be within -10 to +55°C (14 to 131°F) with relative humidity within 10 to 90% RH without condensing.
- Provide sufficient space around the unit for heat dissipation.
- For screw mounting, mount the unit to a panel between 1.0 and 3.2 mm thick.
- Install the unit in a well-ventilated place in order to prevent internal temperature rise.
- Refer to “Clustered mounting” to install several units. In mounting the unit with other equipment side by side, provide sufficient space between them, according to the dimensions in the clustered mounting.
- Do not use the unit under the following environments:
 - Where the unit is exposed to direct sunlight, rain or wind. (The unit is not designed for outdoor use.)
 - Where condensation may occur due to extreme temperature changes.
 - Where corrosive or flammable gas is present.
 - Where heavy dust, iron powder or salt is present in the air.
 - Where organic solvent such like benzene, thinner, and alcohol, or strong alkaline materials such like ammonia and caustic soda may attach to the unit, or where such materials are present in the air.
 - Where the unit is subject to continuous vibration or physical impact.
 - Where there are high-voltage lines, high-voltage equipment, power lines, power equipment, equipment with transmission unit such like a ham radio equipment, or equipment generating large switching surges around the unit.

■ WIRING

- In order to prevent potential electric shock, wire the unit after cutting the input signal and making sure that the power is not supplied to the cable.
- Be sure to confirm the name and polarity of each terminal before wiring to it.
- Do not connect anything to unused terminals.

■ HANDLING CAUTIONS

- The unit is designed to function as soon as input signal is supplied, however, a warm up for 10 minutes is required for satisfying complete performance described in the data sheet.
- Clean the surface of the unit with wet soft cloth. Do not use organic solvent such like benzene, thinner and alcohol. Doing so may result in deformation or discoloration of the unit.
- When abnormality is found such like smokes, unusual smell and abnormal noises coming from the unit, immediately remove the input signal and stop using it.

■ TO ENSURE DUSTPROOF AND WATERPROOF (degree of protection IP66)

To ensure dustproof and waterproof for front panel follow conditions below.

- Only screw mounting conforms.
- Observe the designated panel cutout size (30.5 mm dia.) specified by us.
- The watertight packing included in the product package must be placed between the body and panel when installing on the panel.
- Fasten the body and panel together with four M4 × 10 screws (torque: 0.6 – 0.9 N·m).
- After installation, confirm that there are no following abnormalities.
 - The packing is contorted.

- There are some spaces between front panel and panel.
 - The packing is run off the edge.
 - The packing is cut off.
 - There are foreign objects sticking.
- When replacement of the watertight packing is needed, consult us.

1.4 COMPONENT IDENTIFICATION

■ FRONT VIEW

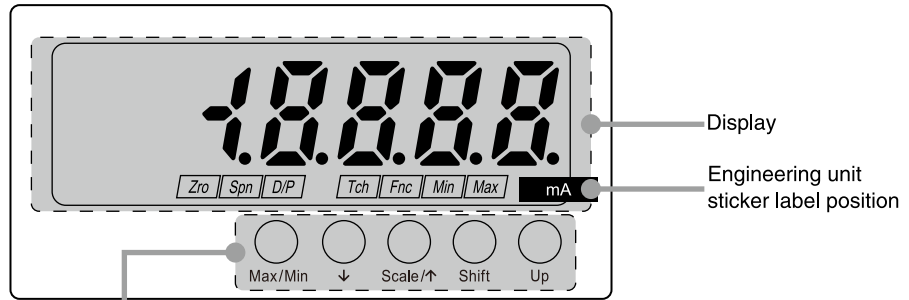

BUTTON	FUNCTION
Max/Min	Used to switch the main display to show the present value, MAX value or MIN value, and to reset the MAX and MIN values. Also used to cancel a set item.
↓	Used to move on to setting modes or to shift through setting items in each setting mode.
Scale/↑	Used to move on to the scaling and other setting modes, or to shift through setting items in each setting mode.
Shift	Used to move on to the setting standby status of each setting mode and to shift through display digits in each setting item.
Up	Used to change setting values in a setting standby mode and to execute/cancel Forced Zero in Measuring Mode.

NOTE

- The engineering unit sticker label position is our recommended position.
- When an engineering unit is specified by the Ordering Information Sheet, the unit(s) will be shipped with the sticker label put on the above position.

■ DISPLAY

COMPONENT	FUNCTION
Main display	Indicates present, MAX and MIN values, parameters, setting values and error codes.

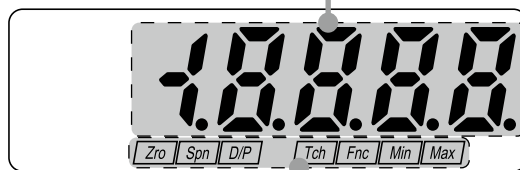

INDICATOR	MODE	FUNCTION
Function	Setting	Indicates parameters in each mode. 'Zro', 'Spn', 'D/P', 'Tch' and 'Fnc' indicators turn on in combination depending on the parameters.
		Teach Calibration. 'Zro' or 'Spn' indicator turns on and 'Tch' indicator blinks. (Refer to 12.1 TEACH CALIBRATION.)
		'Max' and 'Min' indicators blink when a parameter is within invalid range while setting.
	Measuring	Indicates Forced Zero mode. 'Zro' and 'Fnc' indicators turn on. (Refer to 11.1 FORCING THE PRESENT DISPLAY VALUE TO ZERO.)
		Indicates MAX or MIN value. 'Max' or 'Min' indicator turns on. (Refer to 11.2 RETAINING MAX AND MIN VALUES.)

■ TOP VIEW

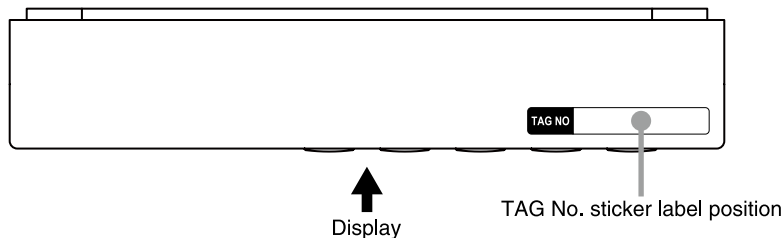

NOTE

- The tag No. label sticker position is our recommended position.
- When a tag No. is specified, the unit(s) will be shipped with the tag No. sticker label put on the above position. Max. 17 alphanumeric characters can be specified. Please consult us.

■ BOTTOM VIEW

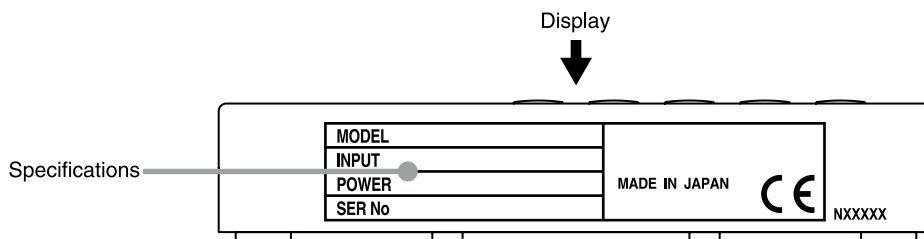

NOTE

Contents of the specification label depend on the specifications.

■ REAR VIEW

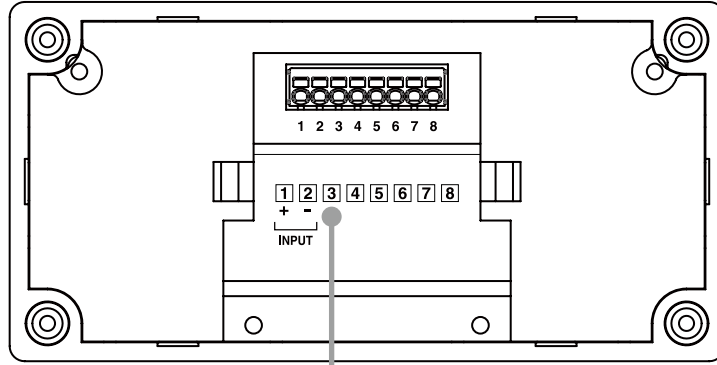

Connection diagram

1.5 INSTALLATION

1.5.1 EXTERNAL DIMENSIONS

unit: mm (inch)

■ FRONT VIEW

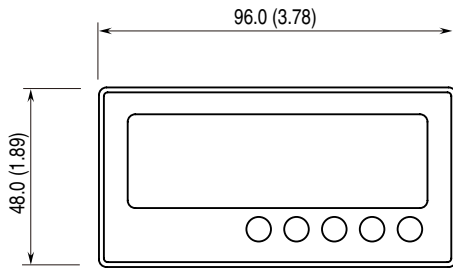

■ SIDE VIEW

• SCREW MOUNTING

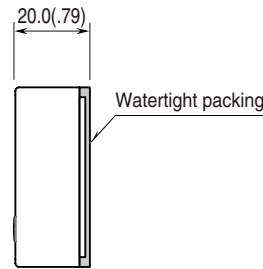

• MAGNET MOUNTING

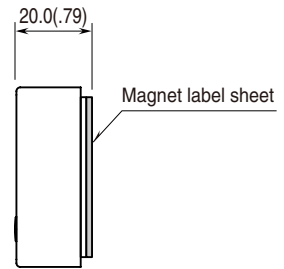

■ REAR VIEW

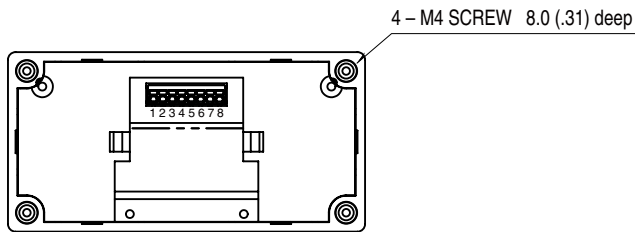

1.5.2 INSTALLATION

■ PANEL MOUNTING (Conform to degree of protection IP66)

Panel cutout must be such as specified by us.

• Single Mounting

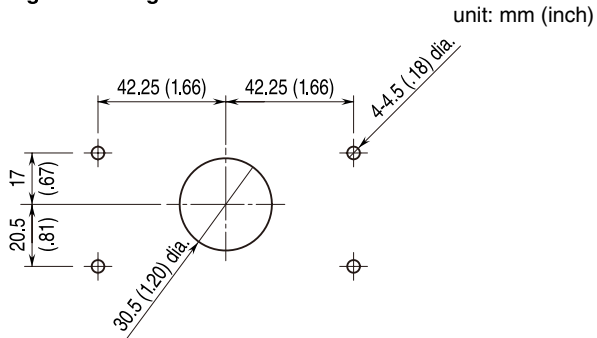

• Clustered Mounting

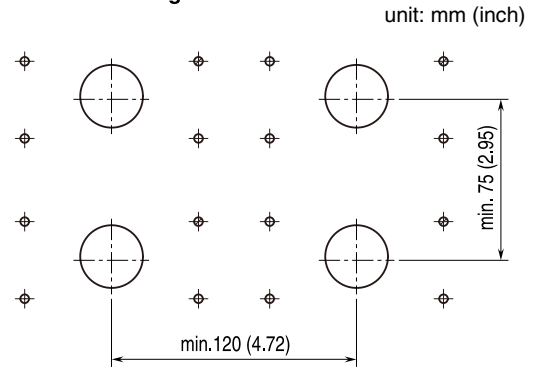

IMPORTANT

Remove burrs from the panel cut surface so that they may not damage the wires.

Use watertight packing and unit fixing screws included in the product package.
Fix the unit to the panel before wiring according to the following procedure.

Panel thickness: 1.0 – 3.2 mm

(1) Mount the watertight packing to the body. Fit the concave part of the watertight packing in the convex part of the body.

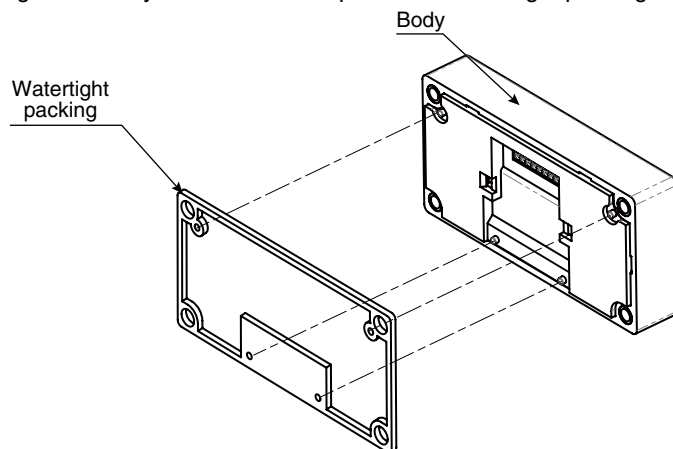

(2) Fix the screws (M4 × 10) to the panel.
Torque: 0.6 – 0.9 N·m

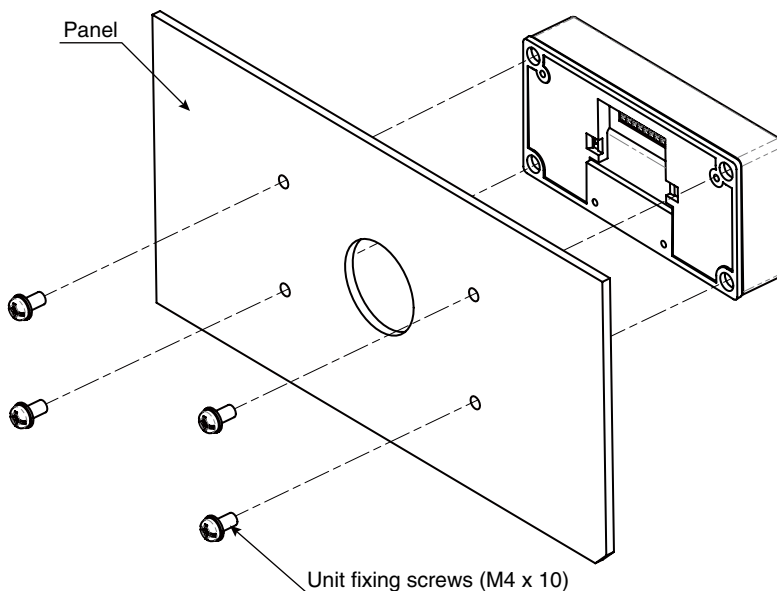

IMPORTANT

To conform to degree of protection IP66, confirm visually that the packing is not contorted, cut off or excessively run off the edge after installation.

■ **MAGNET MOUNTING** (Not conform to degree of protection IP66)

Panel cutout is not required.

Use magnet sheet and stopper included in the product package.

Follow the instruction below to fix the unit after wiring.

- (1) Tear off a protective seal, and attach it to the unit.

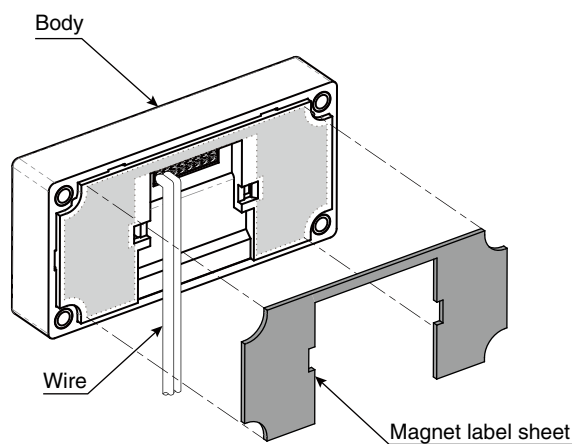

- (2) Attach the stopper to the unit to fix the wire.

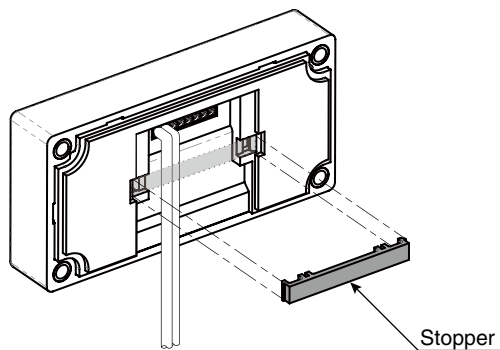

(3) Fix the unit to an iron panel.

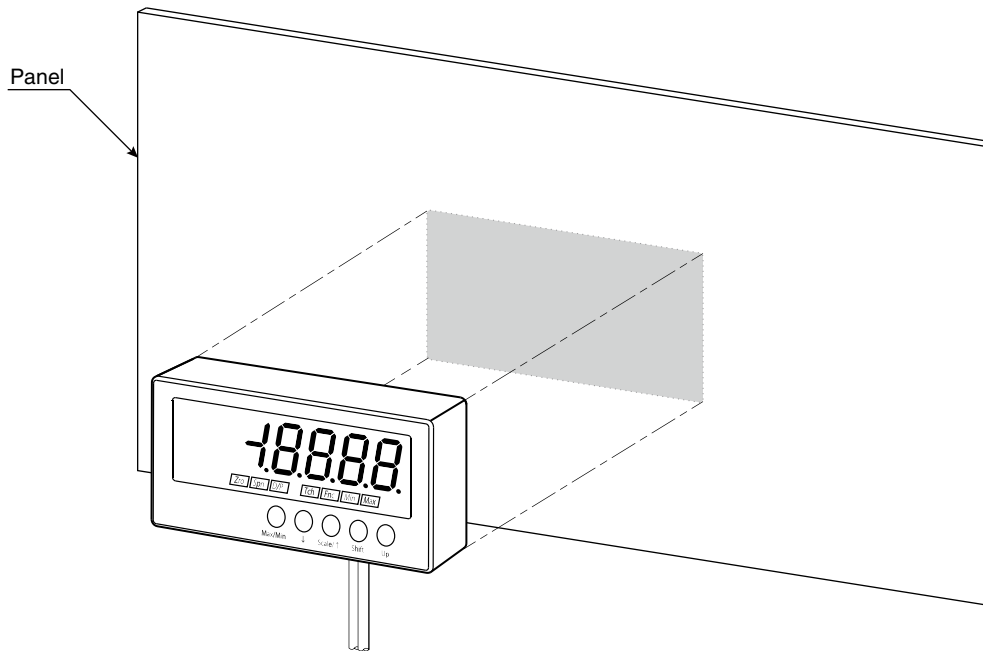

IMPORTANT

- For magnet mounting, DO NOT use where it is subjected to continuous vibration or DO NOT subject the unit to physical impact.
- The sheath of wire must be 2 mm² or less.

• Clustered Mounting

unit: mm (inch)

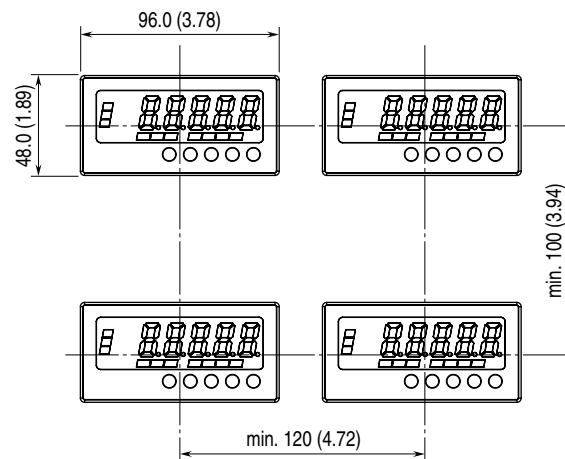

1.6 WIRING INSTRUCTIONS

1.6.1 CAUTION IN WIRING

- For safety, make sure that wiring is performed by qualified personnel only.
- In order to prevent potential electric shock, wire the unit after cutting the input signal and making sure that the power is not supplied to the cable.
- Be sure to confirm the name and polarity of each terminal before wiring to it.
- Do not connect anything to unused terminals.
- We offer a series of lightning surge protectors for protection against induced lightning surges. Please contact us to choose appropriate models.

1.6.2 APPLICABLE WIRE

- Applicable wire size: 0.2 – 0.5 mm²
- Stripped length: 6 mm (0.24")

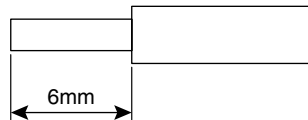

IMPORTANT

- Tinning wire ends may cause contact failure and therefore is not recommended.
- Do not use insulating sleeve when solderless terminal (ferrule) is used.
- When mounting with magnet, the sheath of wire must be 2 mm² or less.

1.6.3 WIRING

Use minus screwdriver to connect wire(s) to a tension clamp terminal block.

- Blade edge: 0.4 mm (0.02")
- Blade width: 2 mm (0.08")
- Procedures are as follows.

- (1) Insert a minus screwdriver into the dead end to open the spring.

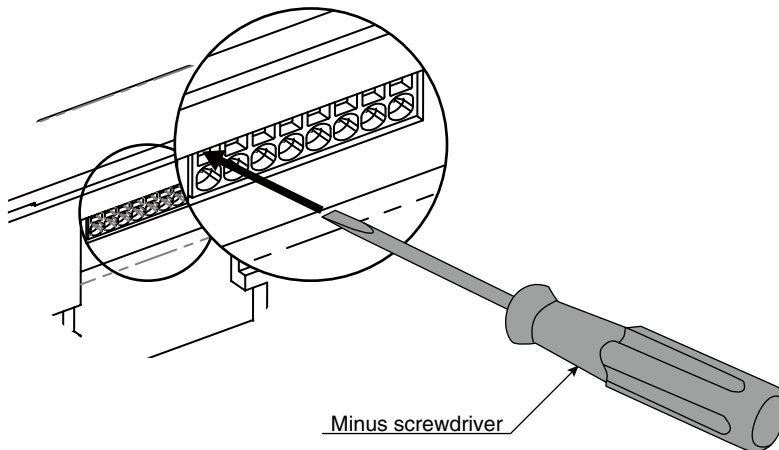

(2) Insert wire(s) deeply.

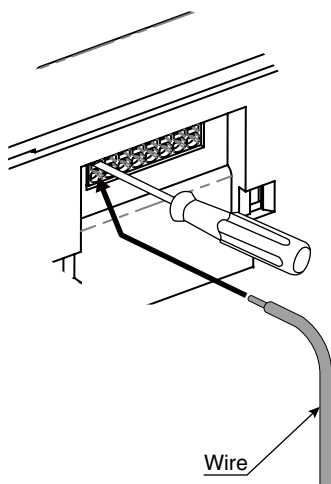

(3) Pull out the minus screwdriver to fix wire(s).

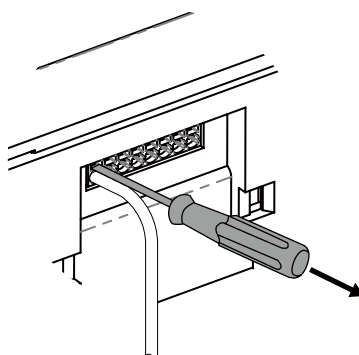

IMPORTANT

- Take measures to prevent the sheath of wire from being caught in terminal(s) to avoid contact failure.
- Pull the wire(s) lightly to confirm that the wire is not pulled off.

1.6.4 TERMINAL ASSIGNMENT

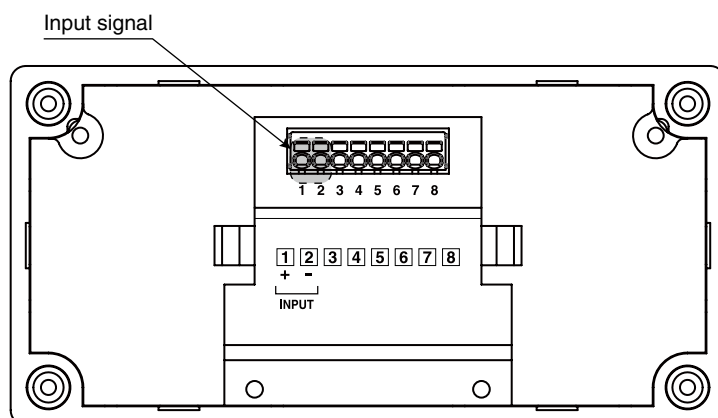

1.6.5 WIRING INPUT SIGNAL

Connect DC current signal wires.

Current range		Approx. 3.7 to 23 mA DC
Voltage drop	Input 4 mA DC	Approx. 6.3 V
	Input 20 mA DC	Approx. 6.5 V (equivalent input impedance: approx. 325 Ω)

IMPORTANT

- Be sure to confirm the input polarity in wiring. Wrong connection may result in malfunction of the unit.
- In order to prevent potential electric shock, wire the unit after cutting the input signal and making sure that the power is not supplied to the cable.
- Take measures to reduce noise as much as possible, e.g. by using shielded twisted pair wires for the input signal. Ground the input shield to the most stable earth to prevent noise troubles.
- Do not connect anything to unused terminals.
- The unit does not operate with the input under approx. 3.7 mA.
- Make sure that the equivalent input impedance is within the permissible load resistance of an input device or a two-wire transmitter.

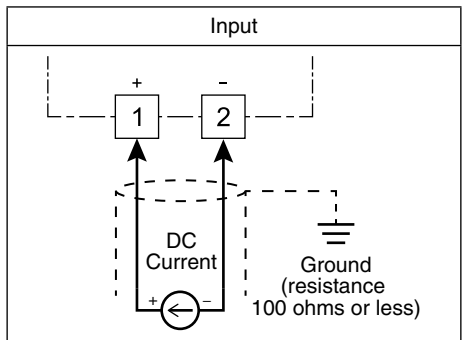

CONNECTION EXAMPLE

• 2-WIRE

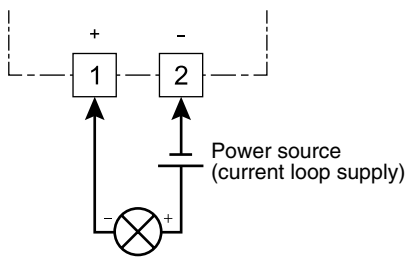

• 4-WIRE

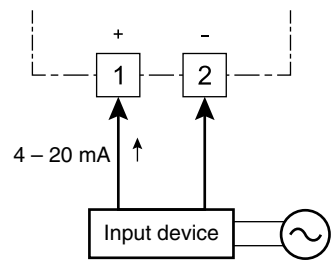

2. BASIC SETTING AND OPERATION

2.1 BASIC SETTING

This section describes flow and procedure of the basic setting.

The following shows the flow and procedure to set the input to 4 – 20 mA DC and the display to 0.0 – 1000.0 m³ as an example.

2.1.1 BASIC SETTING FLOW

The basic setting is as shown in the following flowchart.

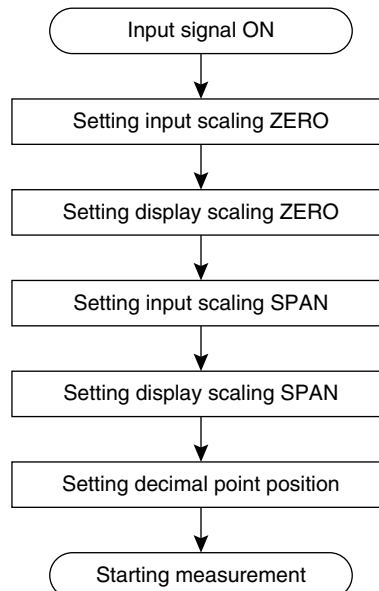

2.1.2 RELATION BETWEEN INPUT SCALING AND DISPLAY SCALING

The relation between input scaling and display scaling is as shown in the following figure and chart.

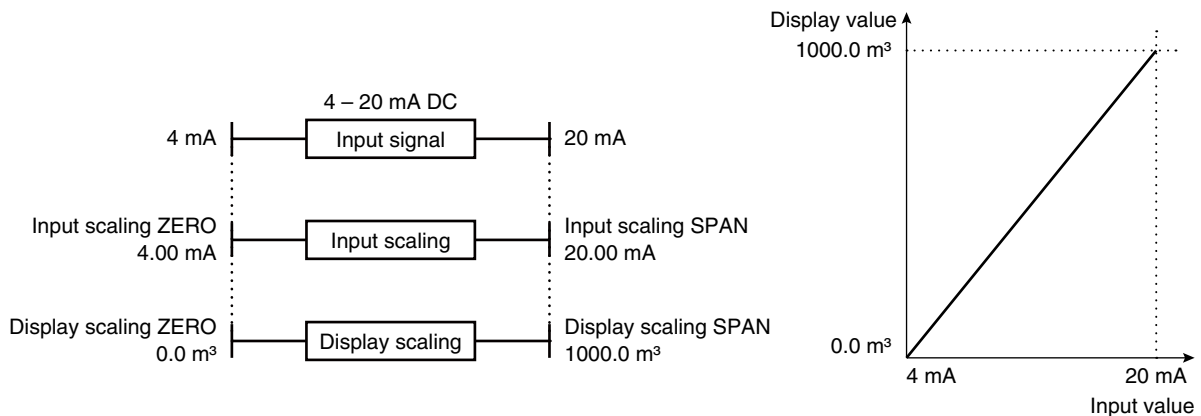

Input scaling: 0% input value (input scaling ZERO) and 100% input value (input scaling SPAN)

Display scaling: 0% display value (display scaling ZERO) and 100% display value (display scaling SPAN)

2.1.3 BASIC SETTING PROCEDURE

The following shows the procedure to set the input to 4 – 20 mA DC and the display to 0.0 – 1000.0 m³ as an example. Set values meeting signals of the equipment to use. Refer to 3. SETTING SCALING VALUES for details of setting.

■ PARAMETER LIST FOR BASIC SETTING

Parameters used in the basic setting are as shown in the following table.

PARAMETER	SETTING VALUE	FUNCTION INDICATOR	SETTING
Input scaling ZERO	04.00	Zro, Tch	0% input: 4.00 mA
Display scaling ZERO	0000*1	Zro, D/P	0% display: 0.0 m ³
Input scaling SPAN	20.00	Spn, Tch	100% input: 20.00 mA
Display scaling SPAN	10000*1	Spn, D/P	100% display: 1000.0 m ³
Decimal point position	ooo.o	D/P	1 decimal place (10 ⁻¹)

*1 The decimal point position depends on the decimal point position setting.

■ BASIC SETTING PROCEDURE

The basic setting procedure is as follows.

1 Confirm the wiring, supply the input and move on to Scaling Setting Mode (measurement stopped).

- Hold down Scale/↑ button for 3 seconds or more.

2 Set input scaling ZERO.

- Press Shift button to shift the display into the setting standby mode.
- Press Shift button to go to the next digit and Up button to change the blinking value.

3 Set display scaling ZERO.

- Press ↓ or Scale/↑ button to apply the new setting and go to the next or previous parameter setting.
- Press Shift button to shift the display into the setting standby mode.
- Press Shift button to go to the next digit and Up button to change the blinking value.

4 Set input scaling SPAN.

- Press ↓ or Scale/↑ button to apply the new setting and go to the next or previous parameter setting.
- Press Shift button to shift the display into the setting standby mode.
- Press Shift button to go to the next digit and Up button to change the blinking value.

5 Set display scaling SPAN.

- Press ↓ or Scale/↑ button to apply the new setting and go to the next or previous parameter setting.
- Press Shift button to shift the display into the setting standby mode.
- Press Shift button to go to the next digit and Up button to change the blinking value.

6 Set decimal point position.

- Press ↓ or Scale/↑ button to apply the new setting and go to the next or previous parameter setting.
- Press Shift button to shift the display into the setting standby mode and Up button to select the decimal point position.

7 Return to Measuring Mode (measurement started).

- Hold down ↓ or Scale/↑ button for 3 seconds or more to apply the new setting and return to Measuring Mode.

2.2 BASIC SETTING OPERATION AND INSTRUCTIONS

This section describes basic operation and instructions when setting parameters.

2.2.1 BASIC SETTING OPERATION

Parameters can be grouped into three setting types, “numerical value setting,” “setting value selection” and “decimal point position selection”. Basic operation of each type is as shown below.

■ NUMERICAL VALUE SETTING

1 Press Shift button to shift the display into the setting standby mode.

- The most significant digit starts blinking.

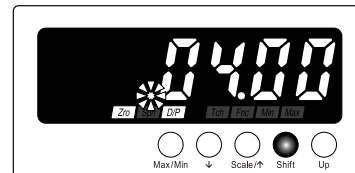

2 Press Shift and Up buttons to set a numerical value.

- Press Shift button to go to the next digit.
- Press Up button to change the blinking value.

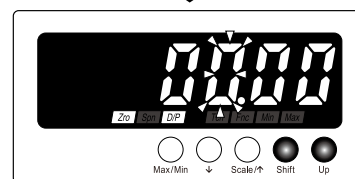

3 Press ↓ or Scale/↑ button to apply the new setting.

- The next or previous parameter setting is indicated.

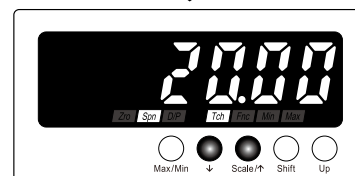

*1 Display depends on the settings.

NOTE

■ SHIFTING DIGITS

Each time pressing Shift button, the blinking digit moves to the right.

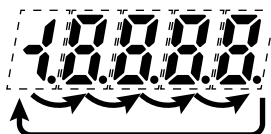

■ SETTING A NUMERICAL VALUE

- Each time pressing Up button, the numeral is incremented by 1.
- The negative sign (-) must be set to the leftmost digit. For example, set '-04.00' instead of '-4.00'.

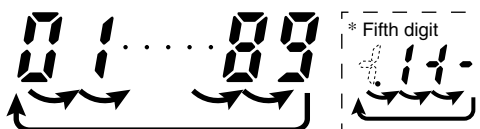

■ SETTING VALUE SELECTION

1 Press Shift button to shift the display into the setting standby mode.

- The current set value starts blinking.

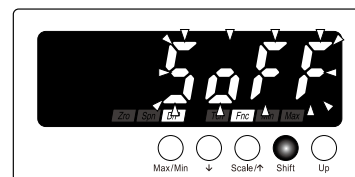

2 Press Up button to select your desired setting value.

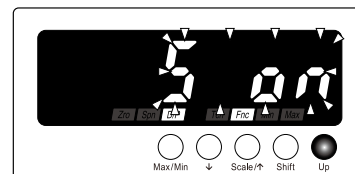

3 Press ↓ or Scale/↑ button to apply the new setting.

- The next or previous parameter setting is indicated.

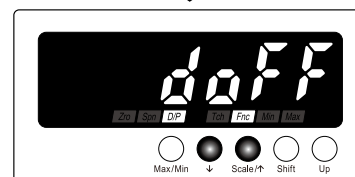

*1 Display depends on the settings.

■ DECIMAL POINT POSITION SELECTION

1 Press Shift button to shift the display into the setting standby mode.

- The current set value starts blinking.

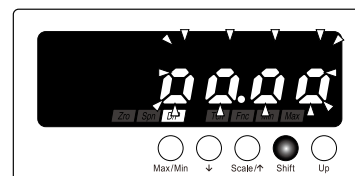

2 Press Up button to select a desired decimal point position.

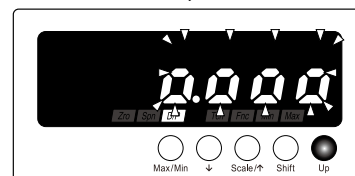

3 Press ↓ or Scale/↑ button to apply the new setting.

- The next or previous parameter setting is indicated.

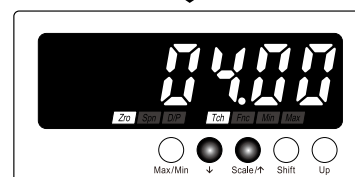

*1 Display depends on the settings.

NOTE

■ MOVING THE DECIMAL POINT

Pressing Up button moves the decimal point one place to the left.

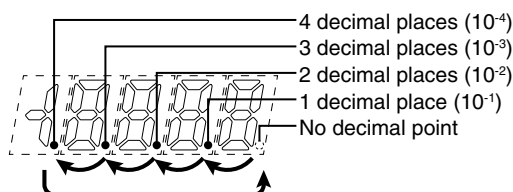

■ DECIMAL POINT POSITION

“No decimal point” to “4 decimal places” can be selected in the decimal point position setting.

SETTING VALUE	FUNCTION	SETTING VALUE	FUNCTION
0.0000	No decimal point	0.000	3 decimal places (10^{-3})
0.000	1 decimal place (10^{-1})	0.0000	4 decimal places (10^{-4})
0.000	2 decimal places (10^{-2})		

2.2.2 INSTRUCTIONS ON BASIC OPERATION

■ INVALID PARAMETERS

- ‘Max’ and ‘Min’ indicators start blinking when a parameter is within invalid range (following cases). Return the setting within the valid range.
 - In setting an input scaling value beyond the current range (hereafter called setting range), or setting ‘input scaling ZERO \geq input scaling SPAN’.
 - In setting ‘display scaling ZERO = display scaling SPAN’.

■ IF THE FRONT BUTTONS ARE LEFT UNTOUCHED...

- The display goes back automatically to Measuring Mode without applying the last changes after the specified time period (default: 60 sec.) while it is in the setting standby mode.
- The display goes back automatically to Measuring Mode after the specified time period (default: 60 sec.) while it is in one of the other modes.
- The setting time out is configurable. (Refer to 9. GOING BACK AUTOMATICALLY TO MEASURING MODE.)

■ TO ABORT A SETTING...

- Hold down Max/Min button for 3 seconds or more to return to Measuring Mode without applying the last changes while the display is in the setting standby mode.
- If you get lost in a setting mode, you can execute initialization. (Refer to 14.2 INITIALIZING SETTING VALUES.)

■ ORDER TO DISPLAY PARAMETERS

- Refer to 5. PARAMETER CONFIGURATION for details.

3. SETTING SCALING VALUES

■ INPUT SCALING

Input scaling means setting an input value within the setting range (approx. 3.7 to 23 mA DC).

The input scaling values include ZERO and SPAN.

- Input scaling ZERO is minimum value (0%) of input signal.
- Input scaling SPAN is maximum value (100%) of input signal.

e.g. Input signal 4 – 20 mA DC
Input scaling ZERO 4 mA
Input scaling SPAN 20 mA

IMPORTANT

- Set 'input scaling ZERO < input scaling SPAN'.
- Setting beyond the setting range is not available.
- Input scaling ZERO and input scaling SPAN can be adjusted by applying actual input signals. Refer to 12.1 TEACH CALIBRATION for details.

■ DISPLAY SCALING

Display scaling means setting a value to display actually.

The display scaling values include ZERO and SPAN. A decimal point can be set in any position.

- Display scaling ZERO is a display value for the input scaling ZERO.
- Display scaling SPAN is a display value for the input scaling SPAN.
- Decimal point position can be set in common for both display scaling ZERO and SPAN.

e.g. Display value 0.0 – 1000.0 m³
Display scaling ZERO 0.0 m³
Display scaling SPAN 1000.0 m³
Decimal point position 000.0 (1 decimal place)

IMPORTANT

Both normal scaling (display scaling ZERO < display scaling SPAN) and inverted scaling (display scaling ZERO > display scaling SPAN) can be set within the range of -19999 to 19999.

■ Normal Scaling

The display value increases when the input signal increases.

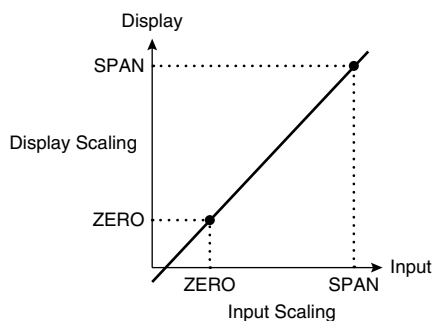

■ Inverted Scaling

The display value decreases when the input signal increases.

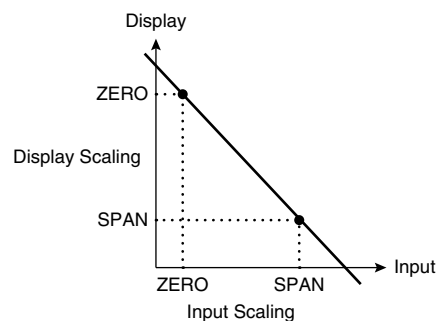

RELATION BETWEEN INPUT SCALING AND DISPLAY SCALING

The relation between input scaling and display scaling is as shown in the following figure.

e.g. To display 4 – 20 mA DC input as 0.0 – 1000.0 m³

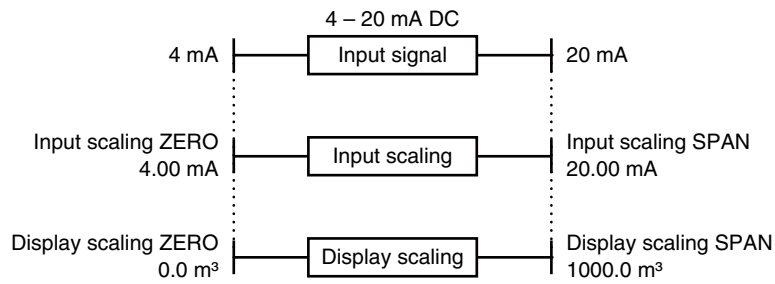

PROCEDURE TO SET SCALING VALUES

• Flow in setting scaling values

5-step settings are necessary to set scaling values.

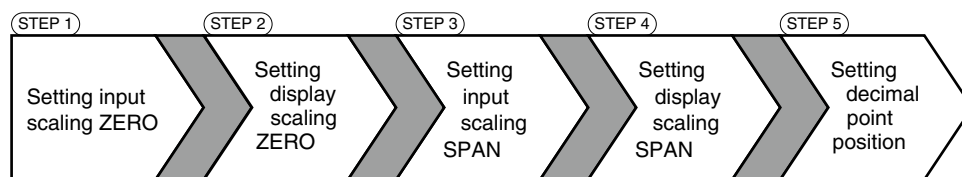

• Operating procedure to set scaling values

Following pages describe operating procedures in each step to set the input scaling to 4 – 20 mA DC, and the display scaling to 0.0 – 1000.0 m³ as an example.

3.1 STEP 1. INPUT SCALING ZERO

3.1.1 OPERATING PROCEDURE

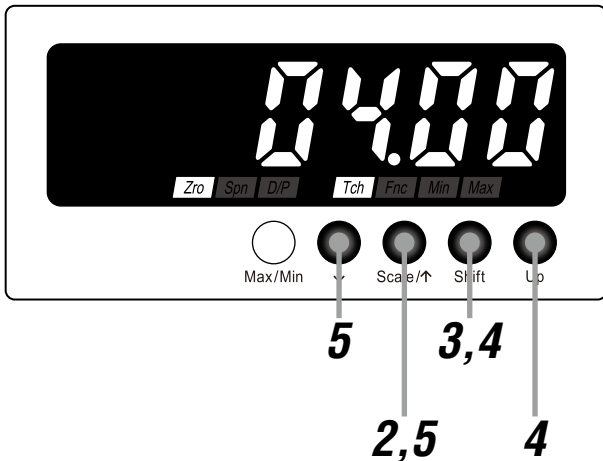

NOTE

The left figure shows a display example (default value 04.00). The display depends on the settings.

1 Confirm the wiring, and supply the input.

- The indication turns on from the left and then the display moves on to Measuring Mode.



*1 Display depends on the settings and input.

NOTE

Indication 'S.ERR' may blink, which shows the input out of the measurable range and does not show the unit failure.

2 Hold down Scale/↑ button for 3 seconds or more to move on to Scaling Setting Mode.

- The input scaling ZERO is indicated.
- 'Zro' and 'Tch' indicators turn on.

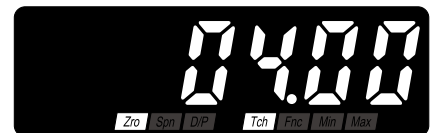

NOTE

Skip to Step 6 if the default value is acceptable.

3 Press Shift button to shift the display into the setting standby mode.

- The fifth digit starts blinking, to which you can apply changes.

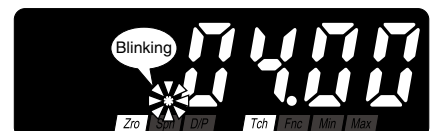

4 Press Shift and Up buttons to set to '04.00'.

- Press Shift button to go to the next digit and Up button to change the blinking value.

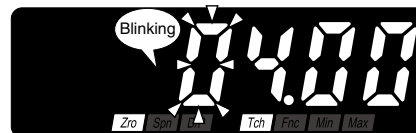

NOTE

- '04.00' is a display example. Set any value within the setting range.
- 'Min' and 'Max' indicators start blinking when the set value is within invalid range or is same as the input scaling SPAN. Return the setting within the valid range.

5 Press ↓ or Scale/↑ button to apply the new setting.

- And the next parameter setting is indicated.

NOTE

- Press ↓ button, and the display scaling ZERO will be indicated within the range of -19999 to 19999 depending on the setting.
- Press Scale/↑ button, and the decimal point position will be indicated.

6 ■ TO GO ON TO SET THE DISPLAY SCALING ZERO, Skip to Step 3 in "3.2 STEP 2. DISPLAY SCALING ZERO"

■ TO QUIT,

Hold down ↓ or Scale/↑ button for 3 seconds or more to return to Measuring Mode.

NOTE

■ INPUT SCALING SETTING

- Do not set 'input scaling ZERO \geq input scaling SPAN'.

■ IF THE FRONT BUTTONS ARE LEFT UNTOUCHED...

- The display goes back automatically to Measuring Mode without applying the last changes after the setting time out period (default: 60 sec.) in the setting standby mode (indication blinking in Step 3 and 4).
- The display goes back automatically to Measuring Mode after the setting time out period (default: 60 sec.) in one of the other modes.
- The setting time out is configurable. (Refer to 9. GOING BACK AUTOMATICALLY TO MEASURING MODE.)

■ TO ABORT A SETTING...

- Hold down Max/Min button for 3 seconds or more in the setting standby mode (indication blinking in Step 3 and 4) to return to Measuring Mode without applying the last changes.
- If you get lost in a setting mode, you can execute initialization. (Refer to 14.2 INITIALIZING SETTING VALUES.)

■ SHIFTING DIGITS

- Each time pressing Shift button, the blinking digit moves to the right.

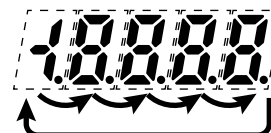

■ SETTING A NUMERICAL VALUE

- Each time pressing Up button, the numeral is incremented by 1.



3.2 STEP 2. DISPLAY SCALING ZERO

3.2.1 OPERATING PROCEDURE

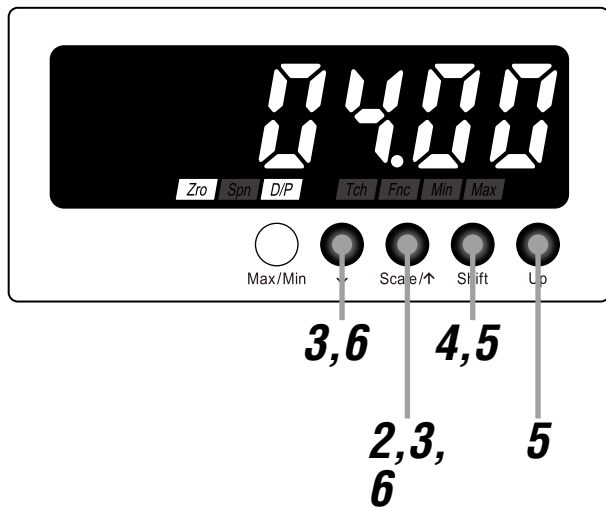

NOTE

The left figure shows a display example (default value 04.00). The display depends on the settings.

1 Confirm the wiring, and supply the input.

- The indication turns on from the left and then the display moves on to Measuring Mode.



*1 Display depends on the settings and input.

NOTE

Indication 'S.ERR' may blink, which shows the input out of the measurable range and does not show the unit failure.

2 Hold down Scale/↑ button for 3 seconds or more to move on to Scaling Setting Mode.

- The input scaling ZERO is indicated.
- 'Zro' and 'Tch' indicators turn on.

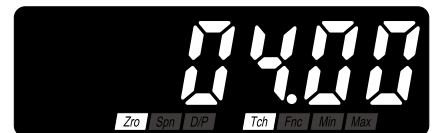

3 Press ↓ or Scale/↑ button to go to the display scaling ZERO setting.

- The display scaling ZERO is indicated.
- 'Zro' and 'D/P' indicators turn on.



NOTE

Skip to Step 7 if the default value is acceptable.

4 Press Shift button to shift the display into the setting standby mode.

- The fifth digit starts blinking, to which you can apply changes.



5 Press Shift and Up buttons to set to '00.00'.

- Press Shift button to go to the next digit and Up button to change the blinking value.

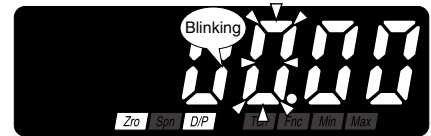

NOTE

- '00.00' is a display example. Set any value within the range of -19999 to 19999.
- The decimal point position depends on the decimal point position setting. Disregard the decimal point here.
- 'Min' and 'Max' indicators start blinking when the set value is same as the display scaling SPAN. Return the setting within the valid range.
- The negative sign (-) must be set to the leftmost digit. For example, set '-04.00' instead of '-4.00'.

6 Press ↓ or Scale/↑ button to apply the new setting.

- And the next parameter setting is indicated.

NOTE

- Press ↓ button, and the input scaling SPAN will be indicated.
- Press Scale/↑ button, and the input scaling ZERO will be indicated.

7 ■ TO GO ON TO SET THE INPUT SCALING SPAN,
Skip to Step 3 in "3.3 STEP 3. INPUT SCALING SPAN"

■ TO QUIT,

Hold down ↓ or Scale/↑ button for 3 seconds or more to return to Measuring Mode.

NOTE

■ IF THE FRONT BUTTONS ARE LEFT UNTOUCHED...

- The display goes back automatically to Measuring Mode without applying the last changes after the setting time out period (default: 60 sec.) in the setting standby mode (indication blinking in Step 4 and 5).
- The display goes back automatically to Measuring Mode after the setting time out period (default: 60 sec.) in one of the other modes.
- The setting time out is configurable. (Refer to 9. GOING BACK AUTOMATICALLY TO MEASURING MODE.)

■ TO ABORT A SETTING...

- Hold down Max/Min button for 3 seconds or more in the setting standby mode (indication blinking in Step 4 and 5) to return to Measuring Mode without applying the last changes.
- If you get lost in a setting mode, you can execute initialization. (Refer to 14.2 INITIALIZING SETTING VALUES.)

■ SHIFTING DIGITS

- Each time pressing Shift button, the blinking digit moves to the right.

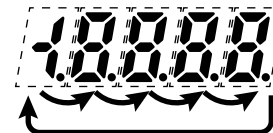

■ SETTING A NUMERICAL VALUE

- Each time pressing Up button, the numeral is incremented by 1.



3.3 STEP 3. INPUT SCALING SPAN

3.3.1 OPERATING PROCEDURE

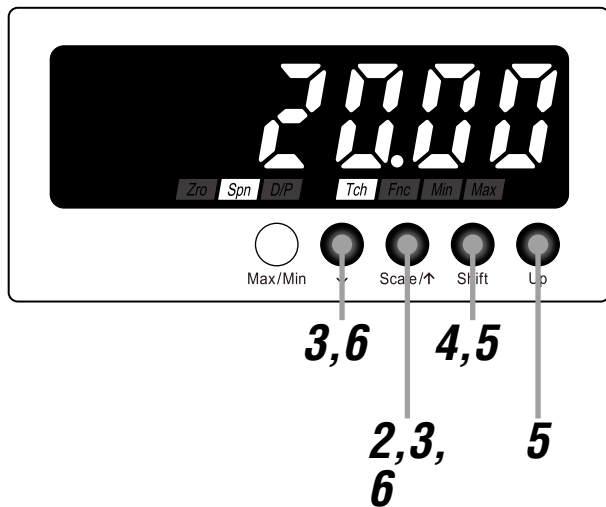

NOTE

The left figure shows a display example (default value 20.00). The display depends on the settings.

1 Confirm the wiring, and supply the input.

- The indication turns on from the left and then the display moves on to Measuring Mode.

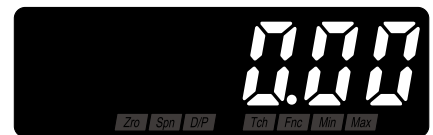

*1 Display depends on the settings and input.

NOTE

Indication 'S.ERR' may blink, which shows the input out of the measurable range and does not show the unit failure.

2 Hold down Scale/↑ button for 3 seconds or more to move on to Scaling Setting Mode.

- The input scaling ZERO is indicated.
- 'Zro' and 'Tch' indicators turn on.

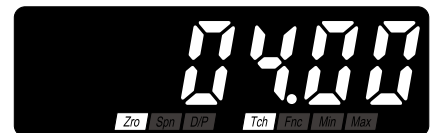

3 Press ↓ or Scale/↑ button to go to the input scaling SPAN setting.

- The input scaling SPAN is indicated.
- 'Spn' and 'Tch' indicators turn on.

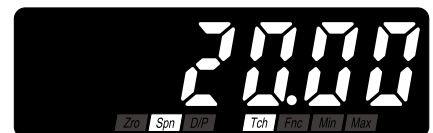

NOTE

Skip to Step 7 if the default value is acceptable.

4 Press Shift button to shift the display into the setting standby mode.

- The fifth digit starts blinking, to which you can apply changes.



5 Press Shift and Up buttons to set to '20.00'.

- Press Shift button to go to the next digit and Up button to change the blinking value.

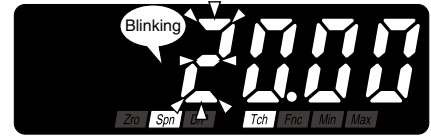

NOTE

- '20.00' is a display example. Set any value within the setting range.
- 'Min' and 'Max' indicators start blinking when the set value is within invalid range or is same as the input scaling ZERO. Return the setting within the valid range.

6 Press ↓ or Scale/↑ button to apply the new setting.

- And the next parameter setting is indicated.

NOTE

- Press ↓ button, and the display scaling SPAN will be indicated within the range of -19999 to 19999 depending on the setting.
- Press Scale/↑ button, and the display scaling ZERO will be indicated within the range of -19999 to 19999 depending on the setting.

7 ■ TO GO ON TO SET THE DISPLAY SCALING SPAN, Skip to Step 3 in "3.4 STEP 4. DISPLAY SCALING SPAN"

■ TO QUIT,

Hold down ↓ or Scale/↑ button for 3 seconds or more to return to Measuring Mode.

NOTE

■ INPUT SCALING SETTING

- Do not set 'input scaling ZERO \geq input scaling SPAN'.

■ IF THE FRONT BUTTONS ARE LEFT UNTOUCHED...

- The display goes back automatically to Measuring Mode without applying the last changes after the setting time out period (default: 60 sec.) in the setting standby mode (indication blinking in Step 4 and 5).
- The display goes back automatically to Measuring Mode after the setting time out period (default: 60 sec.) in one of the other modes.
- The setting time out is configurable. (Refer to 9. GOING BACK AUTOMATICALLY TO MEASURING MODE.)

■ TO ABORT A SETTING...

- Hold down Max/Min button for 3 seconds or more in the setting standby mode (indication blinking in Step 4 and 5) to return to Measuring Mode without applying the last changes.
- If you get lost in a setting mode, you can execute initialization. (Refer to 14.2 INITIALIZING SETTING VALUES.)

■ SHIFTING DIGITS

- Each time pressing Shift button, the blinking digit moves to the right.

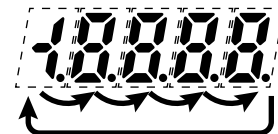

■ SETTING A NUMERICAL VALUE

- Each time pressing Up button, the numeral is incremented by 1.



3.4 STEP 4. DISPLAY SCALING SPAN

3.4.1 OPERATING PROCEDURE

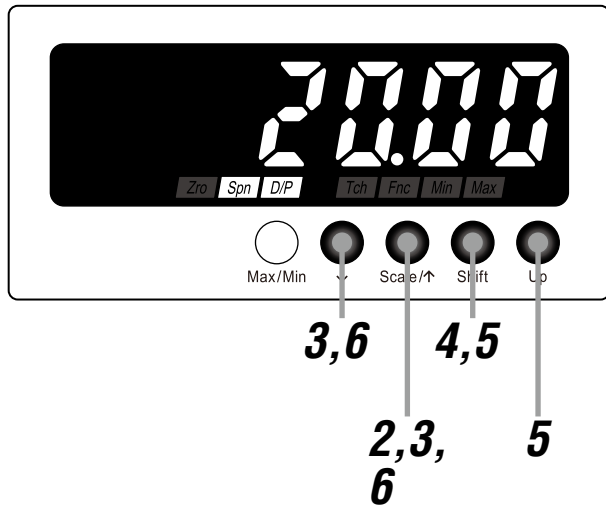

NOTE

The left figure shows a display example (default value 20.00). The display depends on the settings.

1 Confirm the wiring, and supply the input.

- The indication turns on from the left and then the display moves on to Measuring Mode.

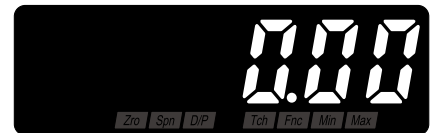

*1 Display depends on the settings and input.

NOTE

Indication 'S.ERR' may blink, which shows the input out of the measurable range and does not show the unit failure.

2 Hold down Scale/↑ button for 3 seconds or more to move on to Scaling Setting Mode.

- The input scaling ZERO is indicated.
- 'Zro' and 'Tch' indicators turn on.

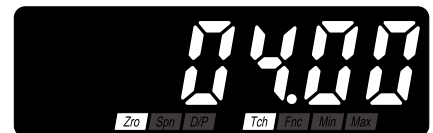

3 Press ↓ or Scale/↑ button to go to the display scaling SPAN setting.

- The display scaling SPAN is indicated.
- 'Spn' and 'D/P' indicators turn on.

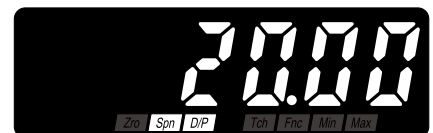

NOTE

Skip to Step 7 if the default value is acceptable.

4 Press Shift button to shift the display into the setting standby mode.

- The fifth digit starts blinking, to which you can apply changes.



5 Press Shift and Up buttons to set to '100.00'.

- Press Shift button to go to the next digit and Up button to change the blinking value.

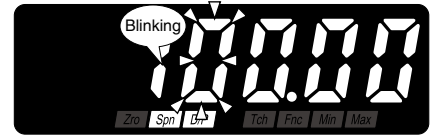

NOTE

- '100.00' is a display example. Set any value within the range of -19999 to 19999.
- The decimal point position depends on the decimal point position setting. Disregard the decimal point here.
- 'Min' and 'Max' indicators start blinking when the set value is same as the display scaling ZERO. Return the setting within the valid range.
- The negative sign (-) must be set to the leftmost digit. For example, set '-04.00' instead of '-4.00'

6 Press ↓ or Scale/↑ button to apply the new setting.

- And the next parameter setting is indicated.

NOTE

- Press ↓ button, and the decimal point position will be indicated.
- Press Scale/↑ button, and the input scaling SPAN will be indicated.

7 ■ TO GO ON TO SET THE DECIMAL POINT POSITION,
Skip to Step 3 in "3.5 STEP 5. DECIMAL POINT POSITION"

■ TO QUIT,

Hold down ↓ or Scale/↑ button for 3 seconds or more to return to Measuring Mode.

NOTE

■ IF THE FRONT BUTTONS ARE LEFT UNTOUCHED...

- The display goes back automatically to Measuring Mode without applying the last changes after the setting time out period (default: 60 sec.) in the setting standby mode (indication blinking in Step 4 and 5).
- The display goes back automatically to Measuring Mode after the setting time out period (default: 60 sec.) in one of the other modes.
- The setting time out is configurable. (Refer to 9. GOING BACK AUTOMATICALLY TO MEASURING MODE.)

■ TO ABORT A SETTING...

- Hold down Max/Min button for 3 seconds or more in the setting standby mode (indication blinking in Step 4 and 5) to return to Measuring Mode without applying the last changes.
- If you get lost in a setting mode, you can execute initialization. (Refer to 14.2 INITIALIZING SETTING VALUES.)

■ SHIFTING DIGITS

- Each time pressing Shift button, the blinking digit moves to the right.

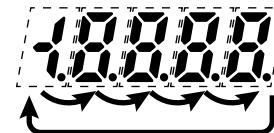

■ SETTING A NUMERICAL VALUE

- Each time pressing Up button, the numeral is incremented by 1.



3.5 STEP 5. DECIMAL POINT POSITION

3.5.1 OPERATING PROCEDURE

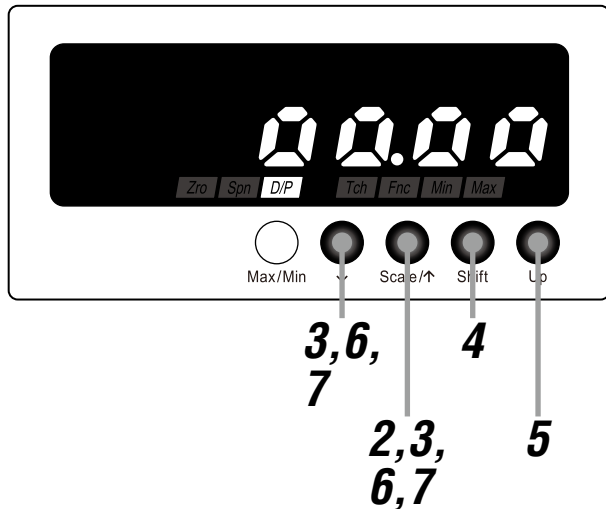

NOTE

The left figure shows a display example. The display depends on the settings.

1 Confirm the wiring, and supply the input.

- The indication turns on from the left and then the display moves on to Measuring Mode.

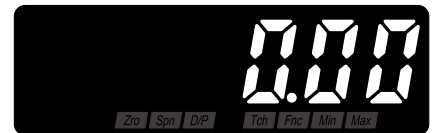

*1 Display depends on the settings and input.

NOTE

Indication 'S.ERR' may blink, which shows the input out of the measurable range and does not show the unit failure.

2 Hold down Scale/↑ button for 3 seconds or more to move on to Scaling Setting Mode.

- The input scaling ZERO is indicated.
- 'Zro' and 'Tch' indicators turn on.

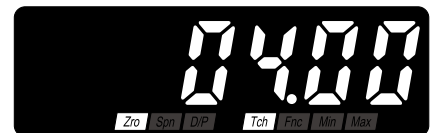

3 Press ↓ or Scale/↑ button to go to the decimal point position setting.

- The decimal point position is indicated.
- 'D/P' indicator turns on.



NOTE

Skip to Step 7 if the default value is acceptable.

4 Press Shift button to shift the display into the setting standby mode.

- The indication starts blinking, to which you can apply changes.

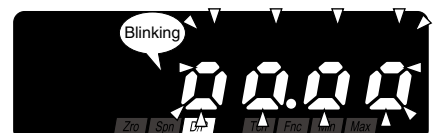

5 Press Up button to select the decimal point position.

- Select 1 decimal place (10^{-1}).
- Press Up button to move the decimal point.

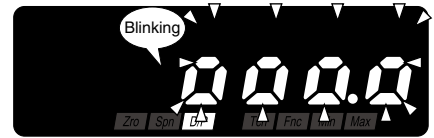

NOTE

The right figure shows a display example. Select one among “no decimal point,” and “1 decimal place” to “4 decimal places”

6 Press ↓ or Scale/↑ button to apply the new setting.

- And the next parameter setting is indicated.

NOTE

- Press ↓ button, and the input scaling ZERO will be indicated.
- Press Scale/↑ button, and the display scaling SPAN will be indicated within the range of -19999 to 19999 depending on the setting.

7 Hold down ↓ or Scale/↑ button for 3 seconds or more to return to Measuring Mode.

NOTE

■ IF THE FRONT BUTTONS ARE LEFT UNTOUCHED...

- The display goes back automatically to Measuring Mode without applying the last changes after the setting time out period (default: 60 sec.) in the setting standby mode (indication blinking in Step 4 and 5).
- The display goes back automatically to Measuring Mode after the setting time out period (default: 60 sec.) in one of the other modes.
- The setting time out is configurable. (Refer to 9. GOING BACK AUTOMATICALLY TO MEASURING MODE.)

■ TO ABORT A SETTING...

- Hold down Max/Min button for 3 seconds or more in the setting standby mode (indication blinking in Step 4 and 5) to return to Measuring Mode without applying the last changes.
- If you get lost in a setting mode, you can execute initialization. (Refer to 14.2 INITIALIZING SETTING VALUES.)

■ MOVING THE DECIMAL POINT

- Pressing Up button moves the decimal point one place to the left.

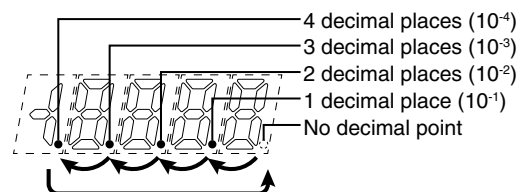

■ DECIMAL POINT POSITION

- “No decimal point” to “4 decimal places” can be selected in the decimal point position setting.

SETTING VALUE	FUNCTION	SETTING VALUE	FUNCTION
□□□□	No decimal point	□□□□	3 decimal places (10^{-3})
□□□□	1 decimal place (10^{-1})	□□□□	4 decimal places (10^{-4})
□□□□	2 decimal places (10^{-2})		

4. OPERATION

Make sure that 0.0 – 1000.0 m³ is correctly indicated according to the input 4 – 20 mA DC provided.

IMPORTANT

Before operating, make sure that the wiring is correct, and the input is within the specification range.

- 1 Apply 4 mA input (0%) and make sure that 0.0 m³ is indicated.



*1 Display depends on the settings and input.

NOTE

■ WHEN THE FOLLOWING IS INDICATED...

- When 'S.ERR' is indicated, the input is not applied correctly. Check the input wiring, equipment and signal. When 'Min' indicator blinks, the input signal is under the specification current. And when 'Max' indicator blinks, the input is over the specification current.
- When the indication is shifted with 'Zro' and 'Fnc' indicators on, the Forced Zero is being executed. Cancel the Forced Zero. (Refer to 11.1 FORCING THE PRESENT DISPLAY VALUE TO ZERO.)

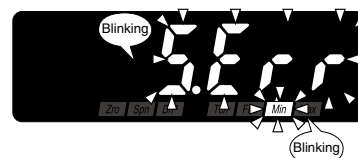

- 2 Apply 12 mA input (50%) and make sure that 500.0 m³ is indicated.



- 3 Apply 20 mA input (100%) and make sure that 1000.0 m³ is indicated.



NOTE

When the indication is shifted with the function indicators off, perform Teach Calibration. (Refer to 12.1 TEACH CALIBRATION.)

5. PARAMETER CONFIGURATION

■ MODE

Parameters can be grouped in several modes.
The 47NLN has modes as shown in the following table.

MODE	FUNCTION	MEASUREMENT
Measuring	Normal measurement state where the unit takes in input. Present value, MAX and MIN values can be indicated in Measuring Mode. Also Forced Zero can be executed and canceled in this mode. When the input is supplied, the unit operates in Measuring Mode.	Measuring
Scaling Setting	Basic settings such like input scaling and display scaling, and Teach Calibration can be performed.	Measuring stopped
Advanced Setting	Moving average, low-end cutout and brightness can be set. Also the firmware version can be confirmed.	
Lockout Setting	Settings to prevent inadvertent button operation can be performed. Mode transition and set values can be locked.	

■ MODE TRANSITION

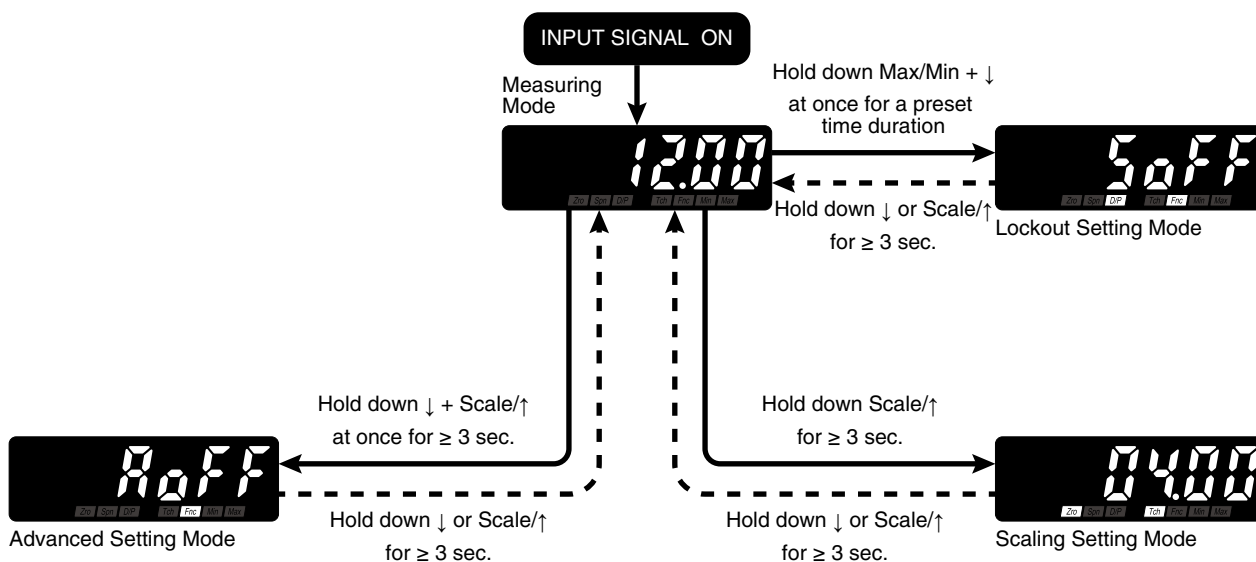

■ TRANSITION FROM MEASURING MODE TO EACH MODE

To Scaling Setting Mode	Hold down Scale/↑ button for 3 seconds or more.
To Advanced Setting Mode	Hold down ↓ + Scale/↑ buttons at once for 3 seconds or more.
To Lockout Setting Mode	Hold down Max/Min + ↓ buttons at once for a preset time duration.

■ TRANSITION FROM EACH MODE TO MEASURING MODE

Hold down ↓ or Scale/↑ button for 3 seconds or more to return to Measuring Mode.

■ SHIFTING THROUGH SETTING PARAMETERS

(1) Parameter shifting in Scaling Setting Mode

In Scaling Setting Mode, pressing ↓ button shifts one parameter to the next (clockwise in the following figure). Pressing Scale/↑ button shifts one to the previous (counterclockwise).

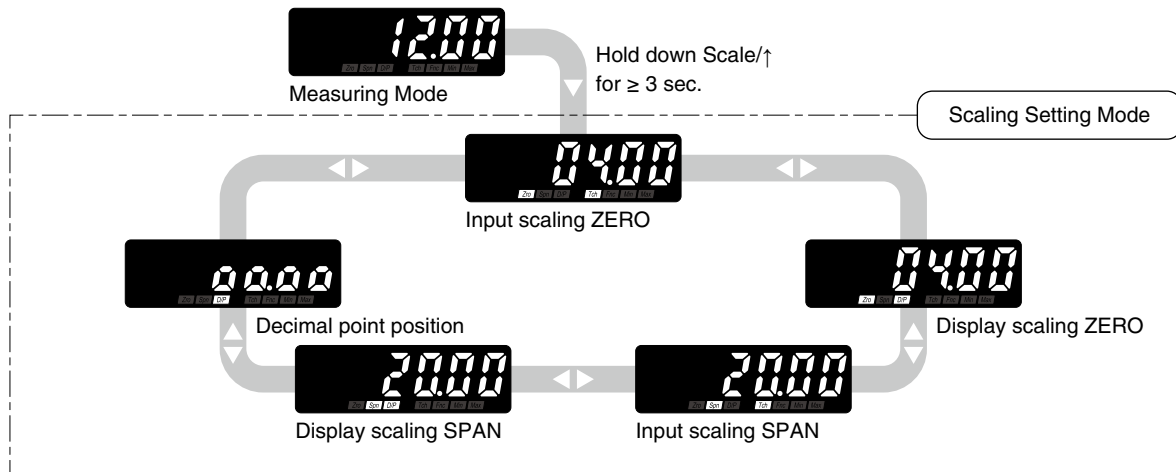

NOTE

- The display depends on the settings and input. The above displays show default values.
- Hold down ↓ or Scale/↑ button for 3 seconds or more to return to Measuring Mode from each parameter.

(2) Parameter shifting in Advanced Setting Mode

In Advanced Setting Mode, pressing ↓ button shifts one parameter to the next (clockwise in the following figure). Pressing Scale/↑ button shifts one to the previous (counterclockwise).

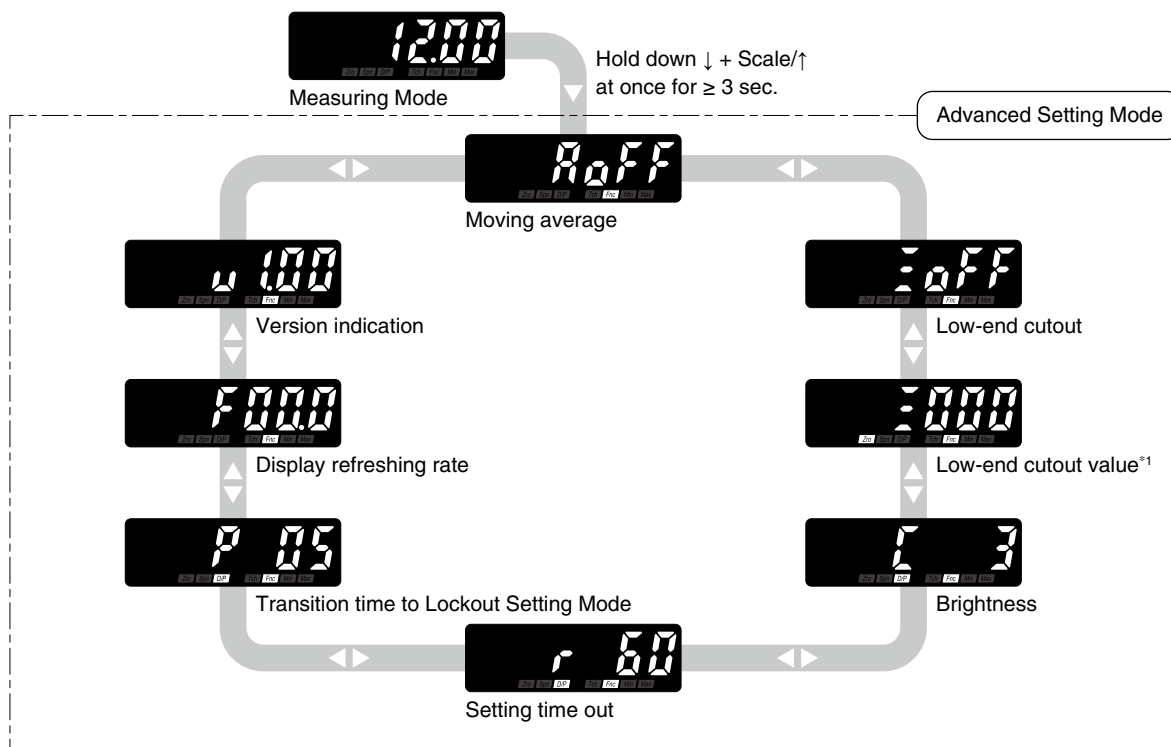

*1 With the cutout set to OFF, the low-end cutout value setting is locked.

NOTE

- The display depends on the settings and input. The above displays show default values.
- Hold down ↓ or Scale/↑ button for 3 seconds or more to return to Measuring Mode from each parameter.

(3) Parameter shifting in Lockout Setting Mode

In Lockout Setting Mode, pressing ↓ button shifts one parameter to the next (clockwise in the following figure). Pressing Scale/↑ button shifts one to the previous (counterclockwise).

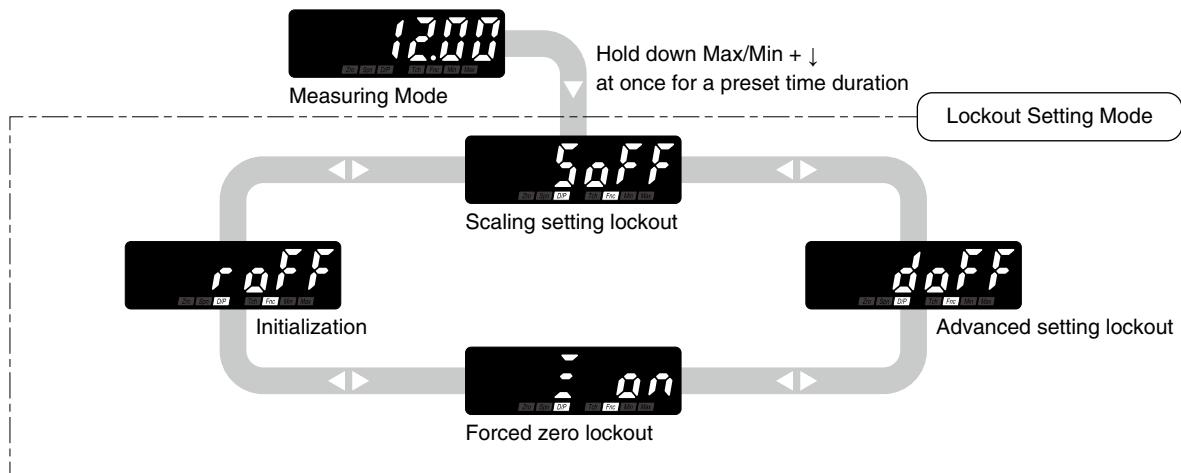

NOTE

- The display depends on the settings and input. The above displays show default values.
- Hold down ↓ or Scale/↑ button for 3 seconds or more to return to Measuring Mode from each parameter.

6. AVERAGING INPUT

Moving average processing of measured values is configurable. The number of samples in processing the moving average can be selected in the following table. This operation averages sampled values, and then, averages with a new sample added and the oldest one omitted. Such operation is repeated as shown in the following figure. For instance, when 'A 4' is selected, the moving average processing with 4 samples (400 millisecond intervals) is repeated. Moving average is used to remove periodic varied noise superimposed on the input signal and suppress the display flickering.

■ NUMBER OF SAMPLES

DISPLAY	FUNCTION	DEFAULT VALUE
OFF	No moving averaging	OFF
A 2	Moving average with 2 samples (200 millisecond intervals)	
A 4	Moving average with 4 samples (400 millisecond intervals)	
A 8	Moving average with 8 samples (800 millisecond intervals)	
A 16	Moving average with 16 samples (1.6 second intervals)	

■ EXAMPLE OF MOVING AVERAGE WITH 4 SAMPLES

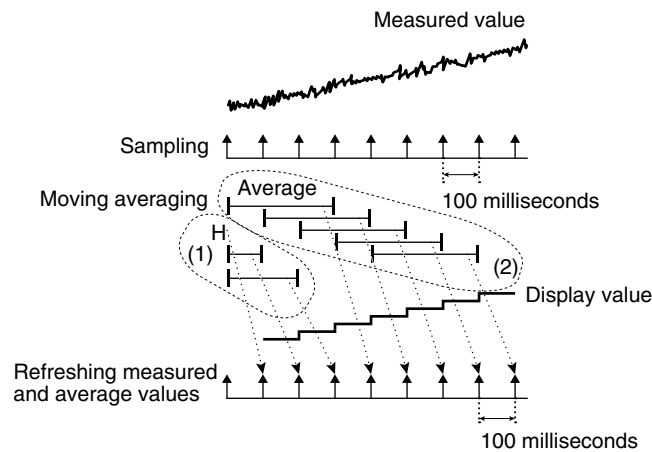

- (1) The moving average operation starts immediately after the input is supplied or the moving average is set. Until the sampling No. reaches the set value, all samples are averaged every 100 milliseconds.
- (2) After the sampling No. reaches the set value, a new sample is added to be averaged with the oldest one omitted. Such operation is repeated.

6.1 OPERATING PROCEDURE

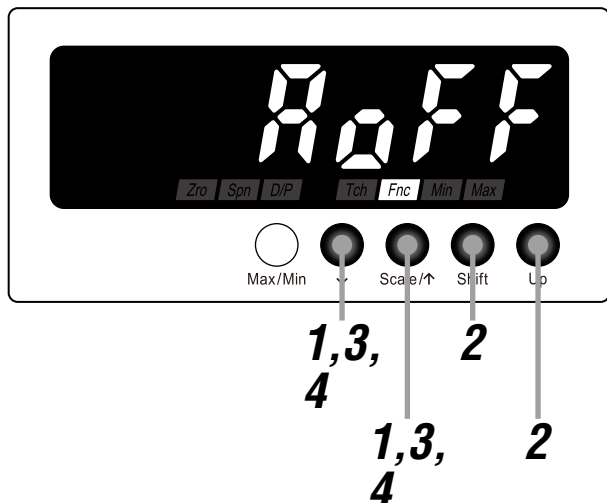

NOTE

The following figures are display examples. The displays depend on the settings.

1 Hold down ↓ and Scale/↑ buttons at once for 3 seconds or more to move on to Advanced Setting Mode.

- The moving average sampling No. is indicated.
- 'Fnc' indicator turns on.



NOTE

'A0FF', 'A 2', 'A 4', 'A 8' or 'A 16' is indicated depending on the setting.

2 Press Shift or Up button to select.

- Select one among 'A0FF', 'A 2', 'A 4', 'A 8' and 'A 16'.

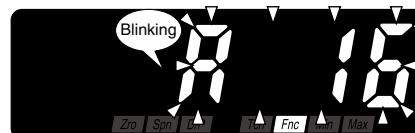

3 Press ↓ or Scale/↑ button to apply the new setting.

- And the next parameter setting is indicated.

NOTE

- Press ↓ button, and the low-end cutout 'ZOFF' or 'Z ON' will be indicated depending on the setting.
- Press Scale/↑ button, and the version indication will be indicated.

4 Hold down ↓ or Scale/↑ button for 3 seconds or more to return to Measuring Mode.

7. ELIMINATING FLUCTUATION AROUND “0”

A measured value less than the preset cutout value can be forcibly cut to 0 (figure below). This parameter is called low-end cutout and the value is called low-end cutout value. Enable the low-end cutout first (table below) and set the low-end cutout value within the range of 000 to 999. The low-end cutout is effective to eliminate slippage or fluctuation of the display values near zero.

■ LOW-END CUTOUT

DISPLAY	FUNCTION	DEFAULT VALUE
off	Low-end cutout OFF	off
on	Low-end cutout ON	

■ SETTING RANGE

Set the low-end cutout value for the three lowest digits of the display scaling value within the range of 000 to 999. The default value is 000.

■ DISPLAY EXAMPLE WITH LOW-END CUTOUT ON

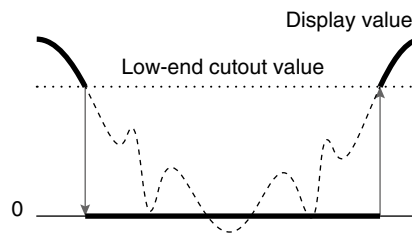

Fluctuation near 0 and negative reading can be cut to 0.

NOTE

- Set the display scaling ZERO to 0 when the low-end cutout is set to ON. Otherwise with the display scaling ± 1000 and the low-end cutout value 50, for example, the indication with the scaling value -1000 to 50 will be cut to 0.
- Low-end cutout has a deadband. With the low-end cutout value set to 50, for example, the indication will be cut to 0 when the measured value is less than 50, and will be restored when it is over 50.

7.1 LOW-END CUTOUT

7.1.1 OPERATING PROCEDURE

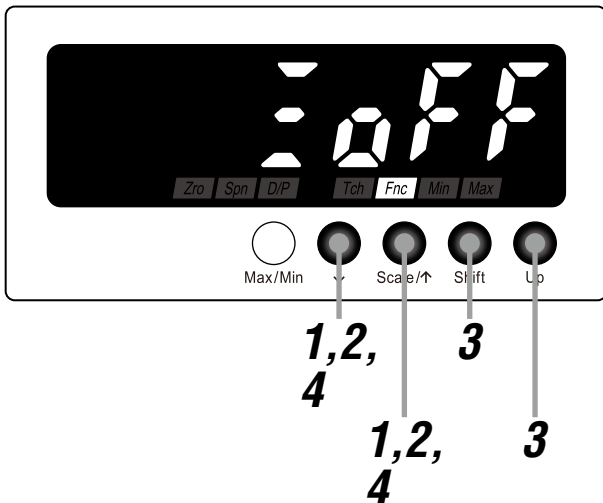

NOTE

- Procedures to change 'ZOFF' to 'Z ON' are described here.
- To change 'Z ON' to 'ZOFF', the procedures are same. Select 'ZOFF' in Step 3.

1 Hold down ↓ and Scale/↑ buttons at once for 3 seconds or more to move on to Advanced Setting Mode.

- The moving average sampling No. is indicated.
- 'Fnc' indicator turns on.



NOTE

'A OFF', 'A 2', 'A 4', 'A 8' or 'A 16' is indicated depending on the setting.

2 Press ↓ or Scale/↑ button to go to the low-end cutout setting.

- 'ZOFF' is indicated.
- 'Fnc' indicator turns on.

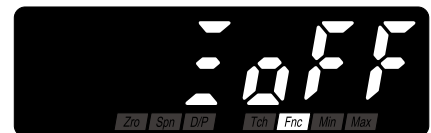

3 Press Shift or Up button to select 'Z ON'.

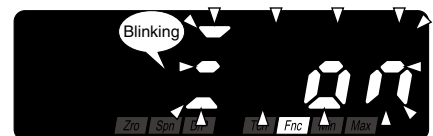

.....

4 Press ↓ or Scale/↑ button to apply the new setting.

- And the next parameter setting is indicated.

NOTE

- Press ↓ button, and the low-end cutout value will be indicated within the range of 'Z000' to 'Z999' depending on the setting. When low-end cutout OFF is selected, the brightness 'C 1', 'C 2' or 'C 3' will be indicated depending on the setting.
 - Press Scale/↑ button, and the moving average sampling No. 'AOFF', 'A 2', 'A 4', 'A 8' or 'A 16' will be indicated depending on the setting.
-

.....

5 ■ TO GO ON TO SET THE LOW-END CUTOUT VALUE,
Skip to Step 2 in "7.2 LOW-END CUTOUT VALUE:"

■ TO QUIT,

Hold down ↓ or Scale/↑ button for 3 seconds or more to return to Measuring Mode.

7.2 LOW-END CUTOUT VALUE

7.2.1 OPERATING PROCEDURE

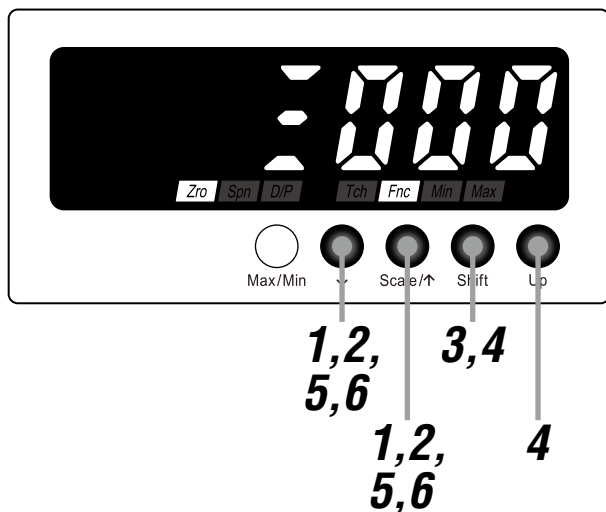

NOTE

The following figures are display examples. The displays depend on the settings.

1 Hold down ↓ and Scale/↑ buttons at once for 3 seconds or more to move on to Advanced Setting Mode.

- The moving average sampling No. is indicated.
- 'Fnc' indicator turns on.



NOTE

'A0FF', 'A 2', 'A 4', 'A 8' or 'A 16' is indicated depending on the setting.

2 Press ↓ or Scale/↑ button to go to the low-end cutout value setting.

- The low-end cutout value is indicated.
- 'Zro' and 'Fnc' indicators turn on.



NOTE

The low-end cutout value is indicated within the range of 'Z000' to 'Z999' depending on the setting.

3 Press Shift button to shift the display into the setting standby mode.

- The third digit starts blinking, to which you can apply changes.

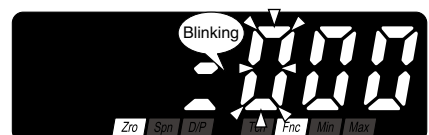

4 Press Shift and Up buttons to set the low-end cutout value.

- Set within the range of 'Z000' to 'Z999'.

NOTE

Set the value for the display scaling. The decimal point is not indicated.

5 Press ↓ or Scale/↑ button to apply the new setting.

- And the next parameter setting is indicated.

NOTE

- Press ↓ button, and the brightness 'C 1', 'C 2' or 'C 3' will be indicated depending on the setting.
 - Press Scale/↑ button, and the low-end cutout 'Z ON' will be indicated.
-

6 Hold down ↓ or Scale/↑ button for 3 seconds or more to return to Measuring Mode.

8. ADJUSTING BRIGHTNESS OF DISPLAY

The brightness of the display can be adjusted (figures below). The brightness can be selected in the following table.

■ DISPLAY BRIGHTNESS

DISPLAY	FUNCTION	DEFAULT VALUE
	Brightness level 1 (dark)	
	Brightness level 2	
	Brightness level 3 (bright)	

■ ADJUSTMENT IMAGE

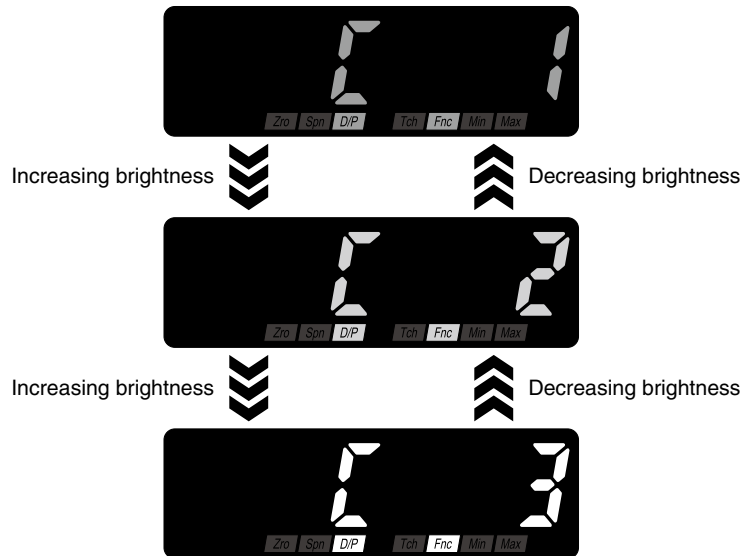

8.1 OPERATING PROCEDURE

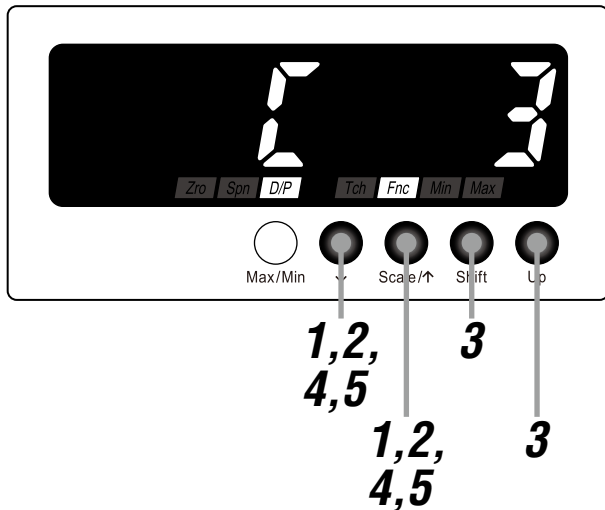

NOTE

The following figures are display examples. The displays depend on the settings.

1 Hold down ↓ and Scale/↑ buttons at once for 3 seconds or more to move on to Advanced Setting Mode.

- The moving average sampling No. is indicated.
- 'Fnc' indicator turns on.



NOTE

'A0FF', 'A 2', 'A 4', 'A 8' or 'A 16' is indicated depending on the setting.

2 Press ↓ or Scale/↑ button to go to the brightness setting.

- The brightness is indicated.
- 'D/P' and 'Fnc' indicators turn on.

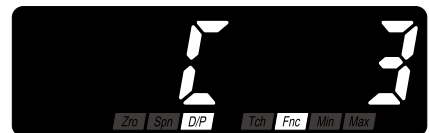

NOTE

'C 1', 'C 2' or 'C 3' is indicated depending on the setting.

3 Press Shift or Up button to select.

- Select one among 'C 1', 'C 2' and 'C 3'.

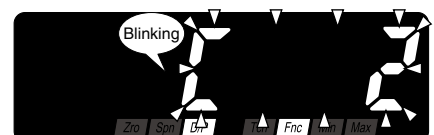

.....

4 Press ↓ or Scale/↑ button to apply the new setting.

- And the next parameter setting is indicated.

NOTE

- Press ↓ button, and the setting time out will be indicated within the range of 'R 00' to 'R 99' depending on the setting.
 - Press Scale/↑ button, and the low-end cutout value will be indicated within the range of 'Z000' to 'Z999' depending on the setting. The low-end cutout 'ZOFF' will be indicated with the cutout set to OFF.
-

.....

5 Hold down ↓ or Scale/↑ button for 3 seconds or more to return to Measuring Mode.

9. GOING BACK AUTOMATICALLY TO MEASURING MODE

The display goes back automatically to Measuring Mode if the front buttons are left untouched for the specified time period while it is in one of the setting modes. This time period is called setting time out and can be set within the range of 1 to 99 seconds (Table 1). With the value set to 'R 00', the display must always be exited manually from the setting mode. The display does not go back automatically to Measuring Mode depending on the modes (Table 2).

■ TABLE 1: SETTING TIME OUT

DISPLAY	FUNCTION	DEFAULT VALUE
r 00	Setting time out disabled	r 60
r 01 to r 99	1 to 99 seconds	

■ TABLE 2: SETTING TIME OUT IN EACH MODE

MODE	OPERATION	SETTING TIME OUT
Measuring Mode	Displaying MAX or MIN value	Disabled
	Executing Forced Zero	Disabled
Scaling Setting Mode		Enabled
Advanced Setting Mode		Enabled
Lockout Setting Mode		Enabled

NOTE

The setting time out error is $\pm 5\%$ or less of its set value.

9.1 OPERATING PROCEDURE

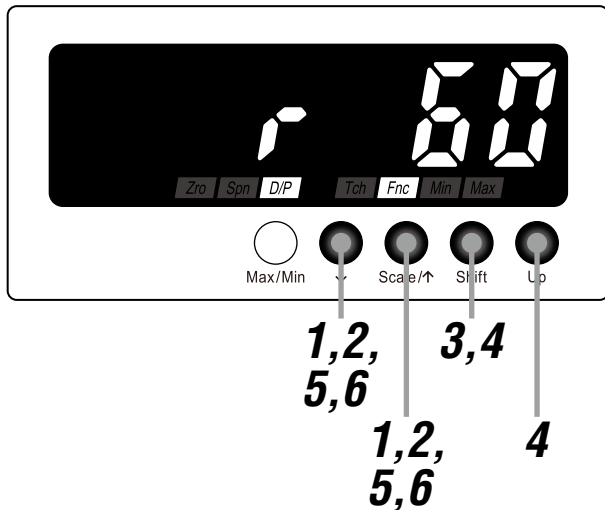

NOTE

The following figures are display examples. The displays depend on the settings.

1 Hold down ↓ and Scale/↑ buttons at once for 3 seconds or more to move on to Advanced Setting Mode.

- The moving average sampling No. is indicated.
- 'Fnc' indicator turns on.

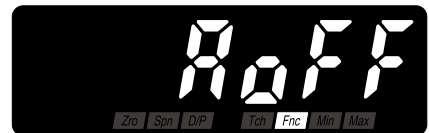

NOTE

'A0FF', 'A 2', 'A 4', 'A 8' or 'A 16' is indicated depending on the setting.

2 Press ↓ or Scale/↑ button to go to the setting time out setting.

- The setting time out is indicated.
- 'D/P' and 'Fnc' indicators turn on.



NOTE

The setting time out is indicated within the range of 'R 00' to 'R 99' depending on the setting.

3 Press Shift button to shift the display into the setting standby mode.

- The second digit starts blinking, to which you can apply changes.

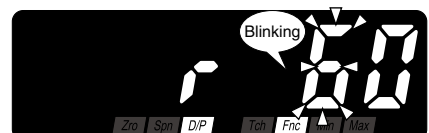

4 Press Shift and Up buttons to set the setting time out.

- Set within the range of 'R 00' to 'R 99'.

.....

5 Press ↓ or Scale/↑ button to apply the new setting.

- And the next parameter setting is indicated.

NOTE

- Press ↓ button, and the transition time to Lockout Setting Mode will be indicated within the range of 'P 00' to 'P 99' depending on the setting.
 - Press Scale/↑ button, and the brightness 'C 1', 'C 2' or 'C 3' will be indicated depending on the setting.
-

.....

6 Hold down ↓ or Scale/↑ button for 3 seconds or more to return to Measuring Mode.

10. ADJUSTING DISPLAY REFRESHING RATE

The display refreshing rate can be set within the range of 0.1 to 99.9 seconds. With this value set to 00.0, the refreshing rate will be 50 milliseconds (table below). When the input signal changes rapidly, the display refreshing rate can be slowed to suppress the display flickering.

■ DISPLAY REFRESHING RATE

DISPLAY	FUNCTION	DEFAULT VALUE
<code>F000</code>	50 milliseconds	<code>F000</code>
<code>F00.1</code> to <code>F99.9</code>	0.1 to 99.9 seconds	

■ DISPLAY REFRESHING IMAGE

e.g. Refreshing rate 0.2 seconds

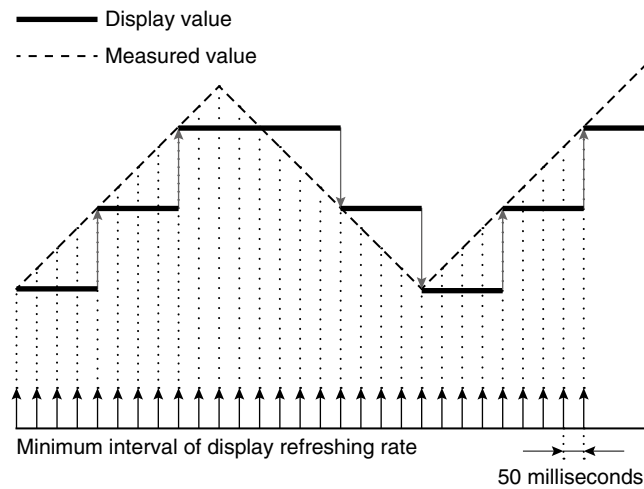

NOTE

The display refreshing rate error is $\pm 5\%$ or less of its set value.

10.1 OPERATING PROCEDURE

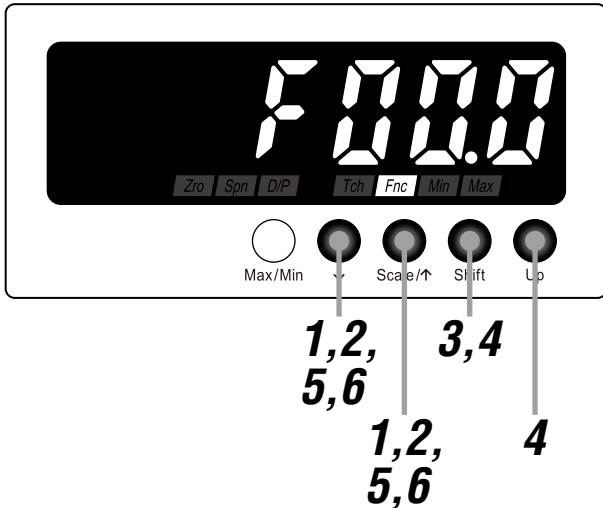

NOTE

The following figures are display examples. The displays depend on the settings.

1 Hold down ↓ and Scale/↑ buttons at once for 3 seconds or more to move on to Advanced Setting Mode.

- The moving average sampling No. is indicated.
- 'Fnc' indicator turns on.



NOTE

'A0FF', 'A 2', 'A 4', 'A 8' or 'A 16' is indicated depending on the setting.

2 Press ↓ or Scale/↑ button to go to the display refreshing rate setting.

- The display refreshing rate is indicated.
- 'Fnc' indicator turns on.



NOTE

The display refreshing rate is indicated within the range of 'F00.0' to 'F99.9' depending on the setting.

3 Press Shift button to shift the display into the setting standby mode.

- The third digit starts blinking, to which you can apply changes.

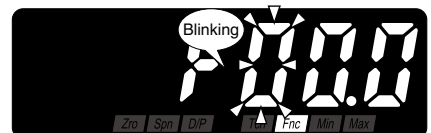

4 Press Shift and Up buttons to set the display refreshing rate.

- Set within the range of 'F00.0' to 'F99.9'.

.....
5 Press ↓ or Scale/↑ button to apply the new setting.

- And the next parameter setting is indicated.

NOTE

- Press ↓ button, and the version indication will be indicated.
 - Press Scale/↑ button, and the transition time to Lockout Setting Mode will be indicated within the range of 'P 00' to 'P 99' depending on the setting.
-

.....
6 Hold down ↓ or Scale/↑ button for 3 seconds or more to return to Measuring Mode.

11. USEFUL FUNCTIONS

11.1 FORCING THE PRESENT DISPLAY VALUE TO ZERO

The display value can be forced to 0 while in Measuring Mode. Press Up button during Measuring Mode to shift the present display value to zero and to continue measuring in reference to this point. This operation is called Forced Zero. This function can be used for applications such as measuring the weight of the contents in a container by canceling the weight of the empty container, or indicating the weight of each material adding into a container one after another.

■ DISPLAY VALUE IN EXECUTING AND CANCELING FORCED ZERO

The display value changes as shown in the following figure when Forced Zero is executed or canceled while in measuring.

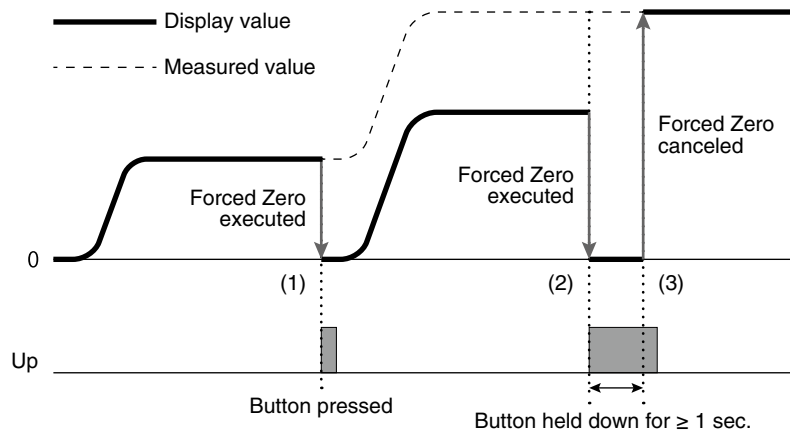

- (1) Press Up button to shift the present display value to zero.
- (2) Press Up button again for 1 second or more to cancel the Forced Zero mode. The display value is forced to 0 once.
- (3) Then the display is back to indicate the measured value.

■ OPERATING PROCEDURE TO EXECUTE/CANCEL FORCED ZERO

- (1) Press Up button in Measuring Mode to execute the Forced Zero.
- (2) Hold down Up button for 1 second or more to cancel the Forced Zero mode.

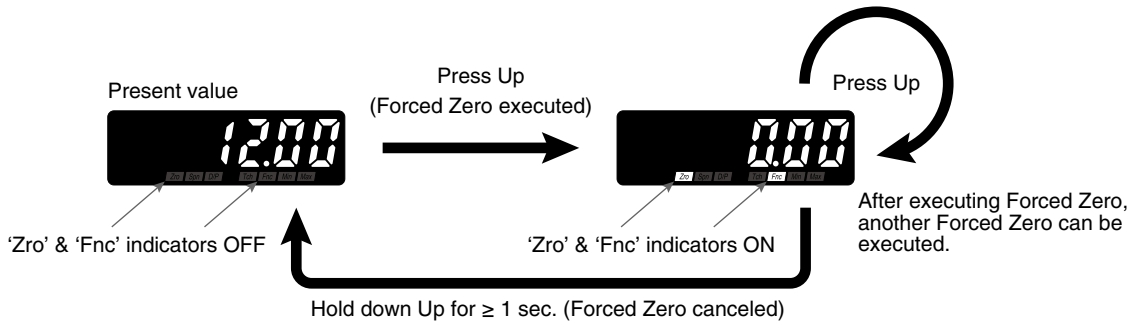

*1 Display depends on the settings and input.

NOTE

- Forced Zero cannot be executed or canceled while in the MAX/MIN Value Display mode.
- Forced Zero value is stored in memory even when the input signal is removed.
- Forced Zero cannot be executed or canceled while 'S.ERR' is indicated. Increase or decrease the input signal within the current range and then execute the Forced Zero again.

11.2 RETAINING MAX AND MIN VALUES

MAX and MIN values can be confirmed while in Measuring Mode. Each time pressing Max/Min button during Measuring Mode, the indication is switched in the order of MAX value to MIN value and back to original indication.

■ MAX AND MIN VALUES

MAX and MIN values are updated while in measuring.

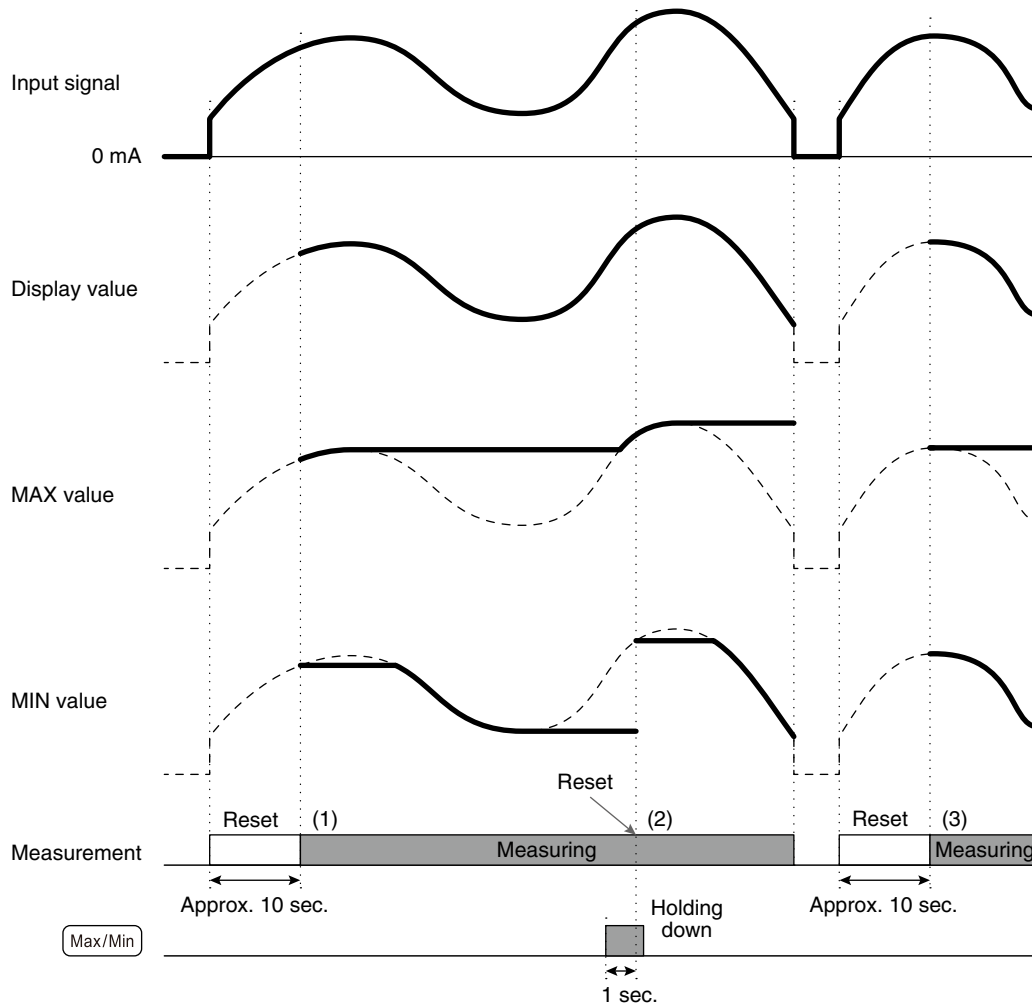

- (1) The internal memory is reset for approx. 10 seconds after the input is supplied, and the unit starts to measure MAX and MIN values.
- (2) Hold down Max/Min button for 1 second or more to reset the MAX and MIN values and then the unit starts to measure MAX and MIN values again.
- (3) The internal memory is reset for approx. 10 seconds after the input is removed and supplied again, and then the unit starts to measure MAX and MIN values again.

■ PROCEDURE TO CONFIRM MAX OR MIN VALUE

- (1) Each time pressing Max/Min button during Measuring Mode, the indication is changed from the present value to MAX value, MIN value, and back to present value.
- (2) Hold down Max/Min button for 1 second or more to reset the MAX and MIN values and indicate new MAX and MIN values. The MAX and MIN values are reset when the input is removed.

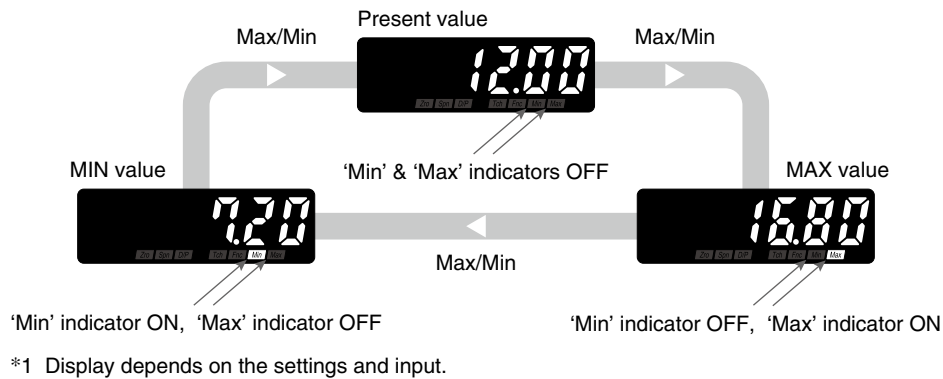

NOTE

- The MAX and MIN values are not reset even when the Forced Zero is executed or canceled.
- MAX and MIN values are not indicated while 'S.ERR' is indicated. Increase or decrease the input signal within the current range and then press Max/Min button again.

11.3 LIMITING BUTTON OPERATION

Transition from Measuring Mode to each setting mode can be limited. With this setting, the transition to each mode by holding down the buttons will be disabled. In Lockout Setting Mode, the lockout per mode is selectable.

■ LOCKOUT SETTING

Following 3 lockout settings are available.

PARAMETER	INDICATORS	DISPLAY	FUNCTION	DEFAULT VALUE
Scaling setting lockout	D/P, Fnc	S OFF	Unlock Scaling Setting Mode	S OFF
		S ON	Lock Scaling Setting Mode	
Advanced setting lockout		d OFF	Unlock Advanced Setting Mode	d OFF
		d ON	Lock Advanced Setting Mode	
Forced zero lockout		Z OFF	Unlock (Enable) Forced Zero operation	Z ON
		Z ON	Lock (Disable) Forced Zero operation	

11.3.1 OPERATING PROCEDURE

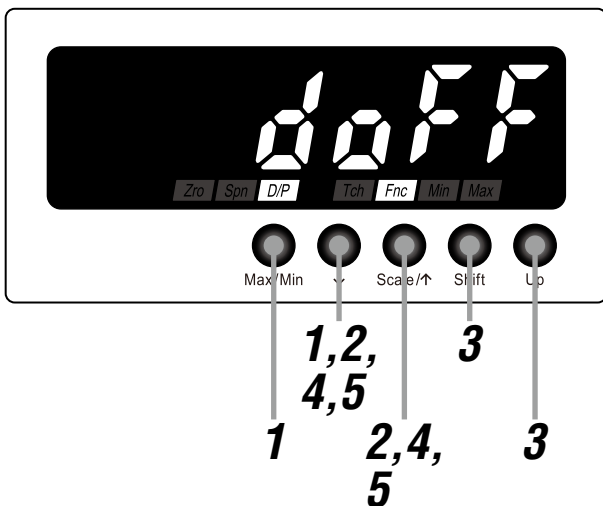

NOTE

- Procedures to lock the advanced setting mode are described here. The procedures to lock other setting modes are same. Select your desired mode to lock in Step 2.
- To cancel the limitation, select 'xOFF' in Step 3.

1 Hold down Max/Min and ↓ buttons at once for a preset time duration to move on to Lockout Setting Mode.

- The scaling setting lockout is indicated.
- 'D/P' and 'Fnc' indicators turn on.



NOTE

'SOFF' or 'S ON' is indicated depending on the setting.

2 Press ↓ or Scale/↑ button to go to the advanced setting lockout setting.

- 'DOFF' is indicated.
- 'D/P' and 'Fnc' indicators turn on.

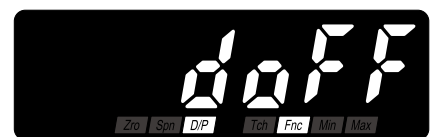

.....

3 Press Shift or Up button to select 'D ON'.

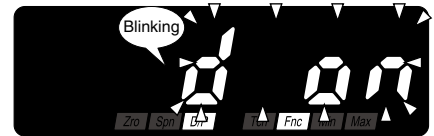

.....

4 Press ↓ or Scale/↑ button to apply the new setting.

- And the next parameter setting is indicated.

NOTE

- Press ↓ button, and the forced zero lockout 'ZOFF' or 'Z ON' will be indicated depending on the setting.
 - Press Scale/↑ button, and the scaling setting lockout 'SOFF' or 'S ON' will be indicated depending on the setting.
-

.....

5 Hold down ↓ or Scale/↑ button for 3 seconds or more to return to Measuring Mode.

11.4 TRANSITION TIME TO LOCKOUT SETTING MODE

Time duration to hold down the buttons for transition to Lockout Setting Mode can be set within the range of 0 to 99 seconds. The default value is 5 seconds.

NOTE

The error of the transition time to Lockout Setting Mode is $\pm 5\%$ or less of its set value.

11.4.1 OPERATING PROCEDURE

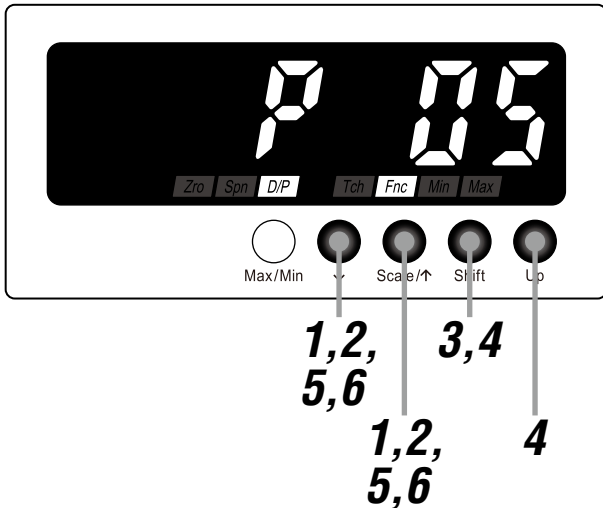

NOTE

The following figures are display examples. The displays depend on the settings.

1 Hold down \downarrow and Scale/ \uparrow buttons at once for 3 seconds or more to move on to Advanced Setting Mode.

- The moving average sampling No. is indicated.
- 'Fnc' indicator turns on.



NOTE

'A0FF', 'A 2', 'A 4', 'A 8' or 'A 16' is indicated depending on the setting.

2 Press \downarrow or Scale/ \uparrow button to go to the setting of the transition time to Lockout Setting Mode.

- The transition time to Lockout Setting Mode is indicated.
- 'D/P' and 'Fnc' indicators turn on.

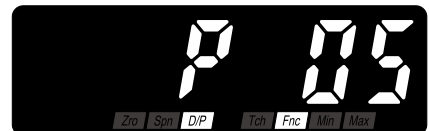

NOTE

The transition time is indicated within the range of 'P 00' to 'P 99' depending on the setting.

.....

3 Press Shift button to shift the display into the setting standby mode.

- The second digit starts blinking, to which you can apply changes.

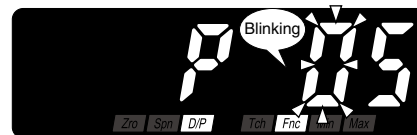

.....

4 Press Shift and Up buttons to set the transition time to Lockout Setting Mode.

- Set within the range of 'P 00' to 'P 99'.

.....

5 Press ↓ or Scale/↑ button to apply the new setting.

- And the next parameter setting is indicated.

NOTE

- Press ↓ button, and the display refreshing rate will be indicated within the range of 'F00.0' to 'F99.9' depending on the setting.
 - Press Scale/↑ button, and the setting time out will be indicated within the range of 'R 00' to 'R 99' depending on the setting.
-

.....

6 Hold down ↓ or Scale/↑ button for 3 seconds or more to return to Measuring Mode.

12. USER CALIBRATION

User calibration is calibration by a customer using customer's measuring instruments and standards.

To calibrate (adjust) the input signal, use "Teach Calibration" function.

The unit is calibrated correctly at shipment and therefore there is normally no need for customers to calibrate it.

12.1 TEACH CALIBRATION

You can calibrate the input signal by the Teach Calibration function if you need calibration.

Input scaling ZERO and SPAN can be adjusted by applying actual input signals.

Please note that we do not warrant the result of your own calibration (adjustment).

The internal calibration data is overwritten every time the unit is calibrated and it is stored even if the input is removed.

However the data will be lost after an initialization.

Prepare measuring instruments and equipment for calibration by yourselves. Refer to each manual carefully for the instruments and equipment for information on handling them.

12.1.1 TEACH CALIBRATION FLOW

The Teach Calibration is carried out as shown in the following flowchart.

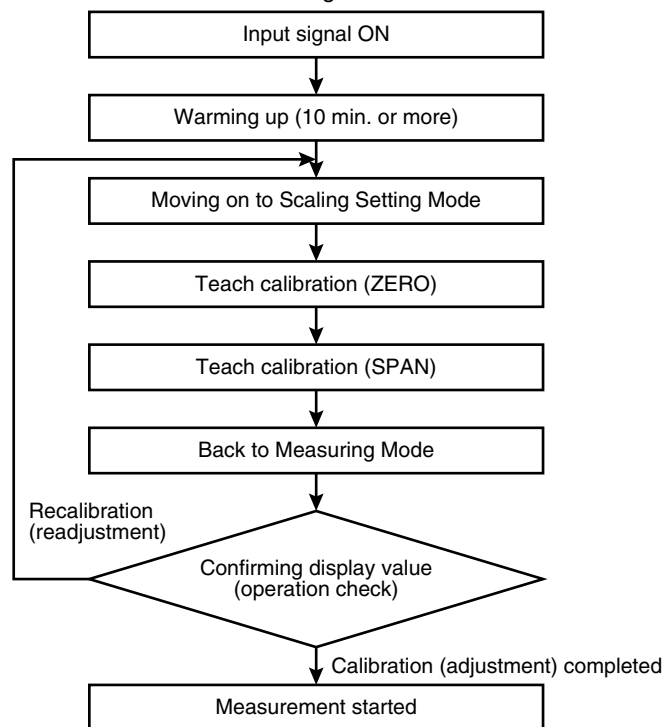

IMPORTANT

- Warm up measuring instruments, equipment and other devices on site for the time specified in each manual, and operate the unit in a stable condition.
- In setting the input scaling ZERO and SPAN using actual inputs, carry out the Teach Calibration within the setting range. Do not set 'input scaling ZERO \geq input scaling SPAN' in carrying out the Teach Calibration.

12.1.2 OPERATING PROCEDURE

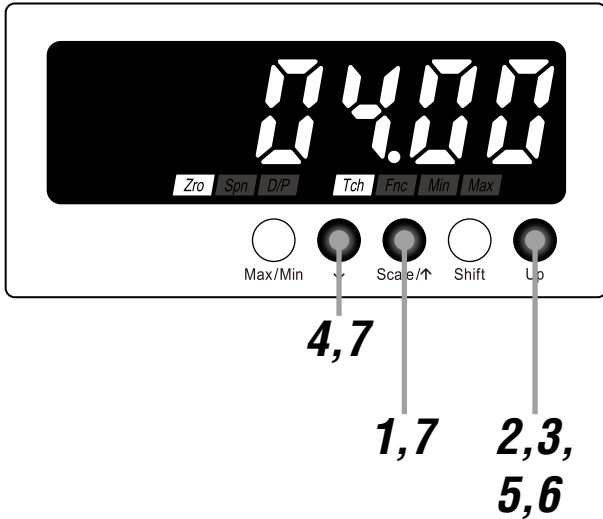

NOTE

The following figures are display examples. The displays depend on the settings.

1 Hold down Scale/↑ button for 3 seconds or more to move on to Scaling Setting Mode.

- The input scaling ZERO is indicated.
- 'Zro' and 'Tch' indicators turn on.



IMPORTANT

Warm up the unit for 10 minutes or more before carrying out the Teach Calibration.

NOTE

Skip to Step 4 when the teach calibration (ZERO) is not necessary.

2 Press Up button to go to the teach calibration (ZERO) setting.

- The present input is indicated.
- 'Tch' indicator starts blinking.

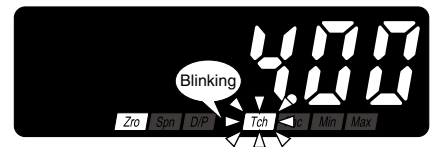

3 Apply 0% input and press Up button to register the value.

- The teach calibration (ZERO) is registered.
- 'Tch' indicator turns ON.



IMPORTANT

Confirm that the input signal is stable before pressing Up button.

4 Press ↓ button twice to go to the input scaling SPAN setting.

- The input scaling SPAN is indicated.
- 'Spn' and 'Tch' indicators turn on.

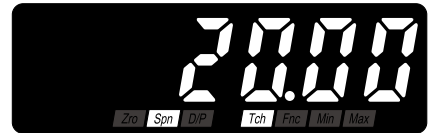

NOTE

Skip to Step 7 when the teach calibration (SPAN) is not necessary.

5 Press Up button to go to the teach calibration (SPAN) setting.

- The present input is indicated.
- 'Tch' indicator starts blinking.

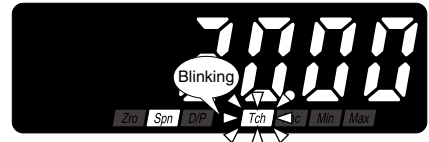

6 Apply 100% input and press Up button to register the value.

- The teach calibration (SPAN) is registered.
- 'Tch' indicator turns ON.



IMPORTANT

Confirm that the input signal is stable before pressing Up button.

7 Hold down ↓ or Scale/↑ button for 3 seconds or more to return to Measuring Mode.

13. INSPECTION / CLEANING

To use the unit in the normal and best conditions, inspect and clean the unit routinely or periodically.

- When the display and the buttons have dirt, wipe them with wet soft cloth. Do not use organic solvent such like benzine, thinner and alcohol. Doing so may result in deformation or discoloration of the unit.
- Make sure that abnormality such like smokes, unusual smell or abnormal noises is not found. Using the unit continuously with such abnormality may result in a fire or electric shock.
- Check the wiring periodically. In checking the wiring, for safety, interrupt electricity to the input.
- Make sure periodically that the screws are fixed tightly. Loosened screws may cause drop of the unit.

14. TROUBLESHOOTING

14.1 ERROR MESSAGES

MAIN DISPLAY	ERROR MESSAGE	WHAT TO DO
SErr	Input error, Out of the measurable range	Increase/decrease the input signal until it is back within the measurable range.
RErr	Non-volatile memory error (reading)	Initialize the unit to its factory default status at the lockout setting mode.*1
WErr	Non-volatile memory error (writing)	
IErr	Internal data error	Repair is needed if the display does not recover after the input signal is reset.

*1 If the unit does not recover its function after the initialization, repairing in the factory may be required.

14.2 INITIALIZING SETTING VALUES

To restart setting from the default state, initialization can be used. Refer to attached 15.3 PARAMETER LIST for the default values.

IMPORTANT

- Currently set parameters will be lost after an initialization. It is recommended to record the parameters before initialization.
- Even if the unit is shipped with the specified parameters with the option code '/SET', such parameters will be lost after an initialization. Be careful that the initialization does not recover the ex-factory settings.

14.2.1 OPERATING PROCEDURE

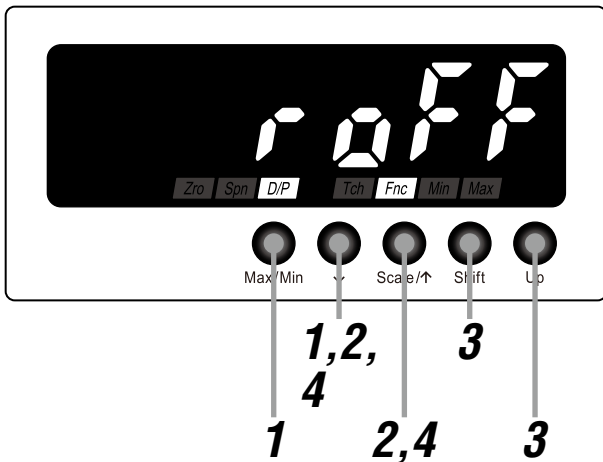

1 Hold down Max/Min and ↓ buttons at once for a preset time duration to move on to Lockout Setting Mode.

- The scaling setting lockout is indicated.
- 'D/P' and 'Fnc' indicators turn on.



NOTE

'SOFF' or 'S ON' is indicated depending on the setting.

.....

2 Press ↓ or Scale/↑ button to go to the initialization.

- 'ROFF' is indicated.
- 'D/P' and 'Fnc' indicators turn on.



.....

3 Press Shift or Up button to select 'RST'.

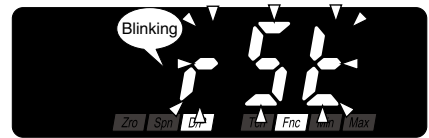

.....

4 Press ↓ or Scale/↑ button to execute the initialization.

- The initialization will be completed in approx. 3 seconds and the display will return to Measuring Mode.

14.3 CONFIRMING FIRMWARE VERSION

The firmware version of the unit can be confirmed.

Confirm the version in the following cases:

- The display is different from the one described in the operating manual.
- The firmware version is necessary to consult us for troubles.

14.3.1 OPERATING PROCEDURE

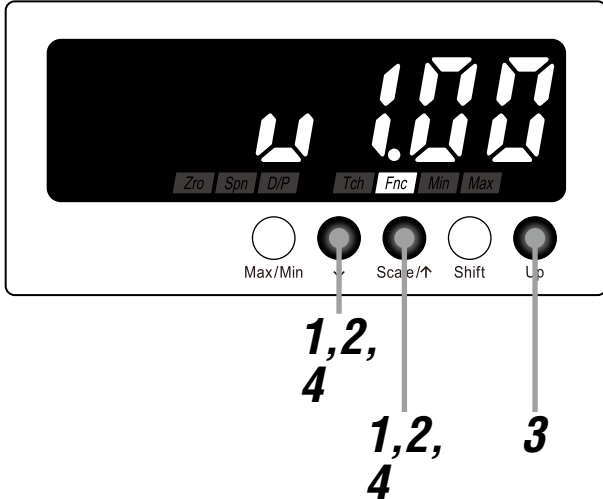

1 Hold down ↓ and Scale/↑ buttons at once for 3 seconds or more to move on to Advanced Setting Mode.

- The moving average sampling No. is indicated.
- 'Fnc' indicator turns on.



NOTE

'A0FF', 'A 2', 'A 4', 'A 8' or 'A 16' is indicated depending on the setting.

2 Press ↓ or Scale/↑ button to go to the version indication.

- The first half of the firmware version number is indicated.
- 'Fnc' indicator turns on.

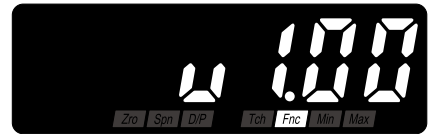

3 Press Up button to indicate another 4 digits of the version number.



NOTE

- The above figures show the firmware version V1.00.0010.
- The displays depend on the firmware version number.

4 Hold down ↓ or Scale/↑ button for 3 seconds or more to return to Measuring Mode.

15. APPENDICES

15.1 SPECIFICATIONS

■ GENERAL SPECIFICATIONS

Construction	Panel mount type	
Degree of protection	IP66; Applicable to the front of the panel meter mounted according to the specified panel cutout. Only screw mounting conforms.	
Connection	Screwless spring terminal	
Applicable wire size	0.2 to 0.5 mm ² , stripped length 6 mm	
Housing material	Flame-resistant (gray)	
Setting (front button)	Scaling setting mode	Input scaling ZERO/SPAN, display scaling ZERO/SPAN, decimal point position
	Advanced setting mode	Moving average, low-end cutout, low-end cutout value, brightness, setting time out, transition time to Lockout Setting Mode, display refreshing rate, version indication
	Lockout setting mode	Scaling setting lockout, advanced setting lockout, forced zero lockout, initialization
Averaging	None or moving average	
Lockout setting	Prohibiting certain operations; protecting settings	

■ DISPLAY

Display	16 mm (.63) high, 4 ½ digits, 7-segment LED
Display range	-19999 to 19999
Decimal point position	10 ⁻¹ , 10 ⁻² , 10 ⁻³ , 10 ⁻⁴ , or none
Zero indication	Higher-digit zeros are suppressed
Over-range indication	'-19999' or '19999' blinking for display values out of the display range. 'S.ERR' and 'Min' or 'Max' blinking when the input signal is out of the usable range.
Function indicators	Zro, Spn, D/P, Tch, Fnc, Min, Max Display mode status and operation status, ON or blink (Display color is the same as display color code.)

■ INPUT SPECIFICATIONS

DC current	Measurement range	4 – 20 mA DC
	Current range	Approx. 3.7 to 23 mA DC
	Voltage drop	Approx. 6.3 V with 4 mA; approx. 6.5 V with 20 mA (Equivalent input impedance: Approx. 325 Ω) (There is voltage drop generated by using the unit. For the two-wire transmitter power supply, make sure that the operable voltage for the two-wire transmitter is ensured including the voltage drop by other devices and wiring resistance.)

■ INSTALLATION

Operating temperature	-10 to +55°C (14 to 131°F)
Operating humidity	10 to 90% RH (non-condensing)
Mounting	Magnet or screw mounting
Weight	75 g (2.6 oz)

■ PERFORMANCE

Accuracy	±0.1% ±1 digit
Temp. coefficient	±0.015%/°C (±0.008%/°F)

■ STANDARDS & APPROVALS

EU conformity	EMC Directive EMI EN 61000-6-4 EMS EN 61000-6-2 RoHS Directive
---------------	---

15.2 MODEL NUMBERING

Code number: **47NLN-[1][2]**

INPUT

Current

4 – 20 mA DC

[1] DISPLAY COLOR

R: Red

G: Green

[2] OPTIONS

Blank: None

/Q: With options (specify the specification)

■ SPECIFICATIONS OF OPTION: Q

EX-FACTORY SETTING

/SET: Preset according to the Ordering Information Sheet (No. ESU-9563)

15.3 PARAMETER LIST

MODE	PARAMETER	SETTING RANGE	INDICATOR	DISPLAY	DEFAULT VALUE	DECIMAL POINT POSITION	UNIT
Measuring	Present value	-19999 – 19999	----	----	----	*1	User-defined
	MAX value	-19999 – 19999	<input type="checkbox"/> Max	----	----	*1	User-defined
	MIN value	-19999 – 19999	<input type="checkbox"/> Min	----	----	*1	User-defined
	Forced zero	-19999 – 19999	<input type="checkbox"/> Zro, <input type="checkbox"/> Fnc	----	----	*1	User-defined
Scaling setting	Input scaling ZERO	4.00 – 20.00	<input type="checkbox"/> Zro, <input type="checkbox"/> Tch	<input type="text" value="0400"/> to <input type="text" value="2000"/>	<input type="text" value="0400"/>	----	mA DC
	Display scaling ZERO	-19999 – 19999	<input type="checkbox"/> Zro, <input type="checkbox"/> DIP	<input type="text" value="19999"/> to <input type="text" value="19999"/>	<input type="text" value="0400"/>	*1	User-defined
	Input scaling SPAN	4.00 – 20.00	<input type="checkbox"/> Spn, <input type="checkbox"/> Tch	<input type="text" value="0400"/> to <input type="text" value="2000"/>	<input type="text" value="2000"/>	----	mA DC
	Display scaling SPAN	-19999 – 19999	<input type="checkbox"/> Spn, <input type="checkbox"/> DIP	<input type="text" value="19999"/> to <input type="text" value="19999"/>	<input type="text" value="2000"/>	*1	User-defined
	Decimal point position	No decimal point, or 10 ⁻¹ to 10 ⁻⁴	<input type="checkbox"/> DIP	<input type="text" value="0000"/> , <input type="text" value="0000"/> , <input type="text" value="0000"/> , <input type="text" value="0000"/> , <input type="text" value="0000"/>	<input type="text" value="0000"/>	----	----
	Teach calibration (ZERO)	----	<input type="checkbox"/> Zro, <input type="checkbox"/> Tch	----	----	----	----
	Teach calibration (SPAN)	----	<input type="checkbox"/> Spn, <input type="checkbox"/> Tch	----	----	----	----
Advanced setting	Moving average	None, 2, 4, 8, 16	<input type="checkbox"/> Fnc	<input type="text" value="R0FF"/> <input type="text" value="R 2"/> , <input type="text" value="R 4"/> <input type="text" value="R 8"/> , <input type="text" value="R 16"/>	<input type="text" value="R0FF"/>	----	Sample
	Low-end cutout	OFF, ON	<input type="checkbox"/> Fnc	<input type="text" value="0aFF"/> <input type="text" value="0 on"/>	<input type="text" value="0aFF"/>	----	----
	Low-end cutout value	000 – 999	<input type="checkbox"/> Zro, <input type="checkbox"/> Fnc	<input type="text" value="0000"/> to <input type="text" value="9999"/>	<input type="text" value="0000"/>	----	User-defined
	Brightness	1 (dark) to 3 (bright)	<input type="checkbox"/> DIP, <input type="checkbox"/> Fnc	<input type="text" value="1"/> <input type="text" value="2"/> , <input type="text" value="3"/>	<input type="text" value="3"/>	----	----
	Setting time out	00 (setting time out disabled) 01 – 99	<input type="checkbox"/> DIP, <input type="checkbox"/> Fnc	<input type="text" value="r 00"/> to <input type="text" value="r 99"/>	<input type="text" value="r 60"/>	----	Second
	Transition time to Lockout Setting Mode	00 – 99	<input type="checkbox"/> DIP, <input type="checkbox"/> Fnc	<input type="text" value="P 00"/> to <input type="text" value="P 99"/>	<input type="text" value="P 05"/>	----	Second
	Display refreshing rate	00.0 – 99.9	<input type="checkbox"/> Fnc	<input type="text" value="F000"/> to <input type="text" value="F999"/>	<input type="text" value="F000"/>	----	Second
	Version indication	----	<input type="checkbox"/> Fnc	----	----	----	----
Lockout setting	Scaling setting lockout	OFF, ON	<input type="checkbox"/> DIP, <input type="checkbox"/> Fnc	<input type="text" value="0aFF"/> <input type="text" value="0 on"/>	<input type="text" value="0aFF"/>	----	----
	Advanced setting lockout	OFF, ON	<input type="checkbox"/> DIP, <input type="checkbox"/> Fnc	<input type="text" value="daFF"/> <input type="text" value="d on"/>	<input type="text" value="daFF"/>	----	----
	Forced zero lockout	OFF, ON	<input type="checkbox"/> DIP, <input type="checkbox"/> Fnc	<input type="text" value="0aFF"/> <input type="text" value="0 on"/>	<input type="text" value="0 on"/>	----	----
	Initialization	OFF, initialization	<input type="checkbox"/> DIP, <input type="checkbox"/> Fnc	<input type="text" value="raFF"/> <input type="text" value="r 5t"/>	<input type="text" value="raFF"/>	----	----

*1 Conforms to decimal point position setting.

NOTE: INDICATOR: = ON, = Blinking

15.4 PARAMETER MAP

15.4.1 OPERATION IN MEASURING MODE

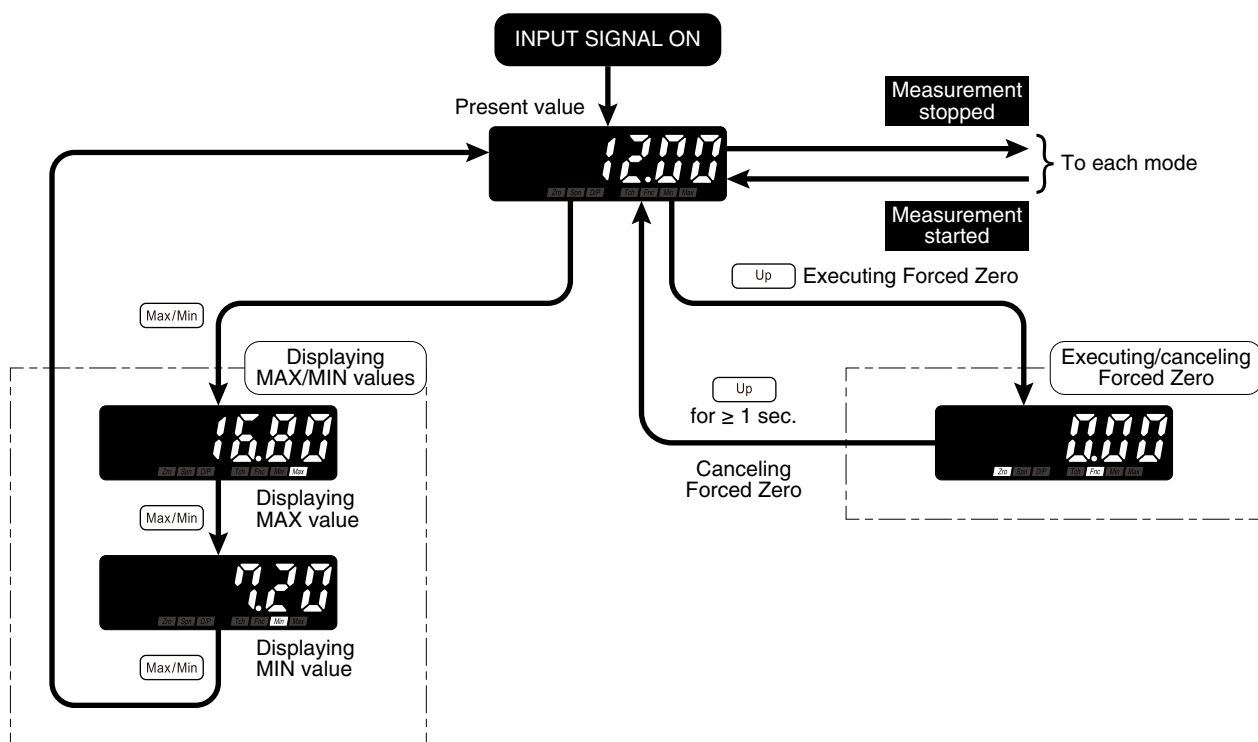

NOTE

- The display depends on the settings and input.
- Forced zero cannot be executed or canceled when the operation is disabled with the forced zero lockout setting.

15.4.2 SCALING SETTING MODE

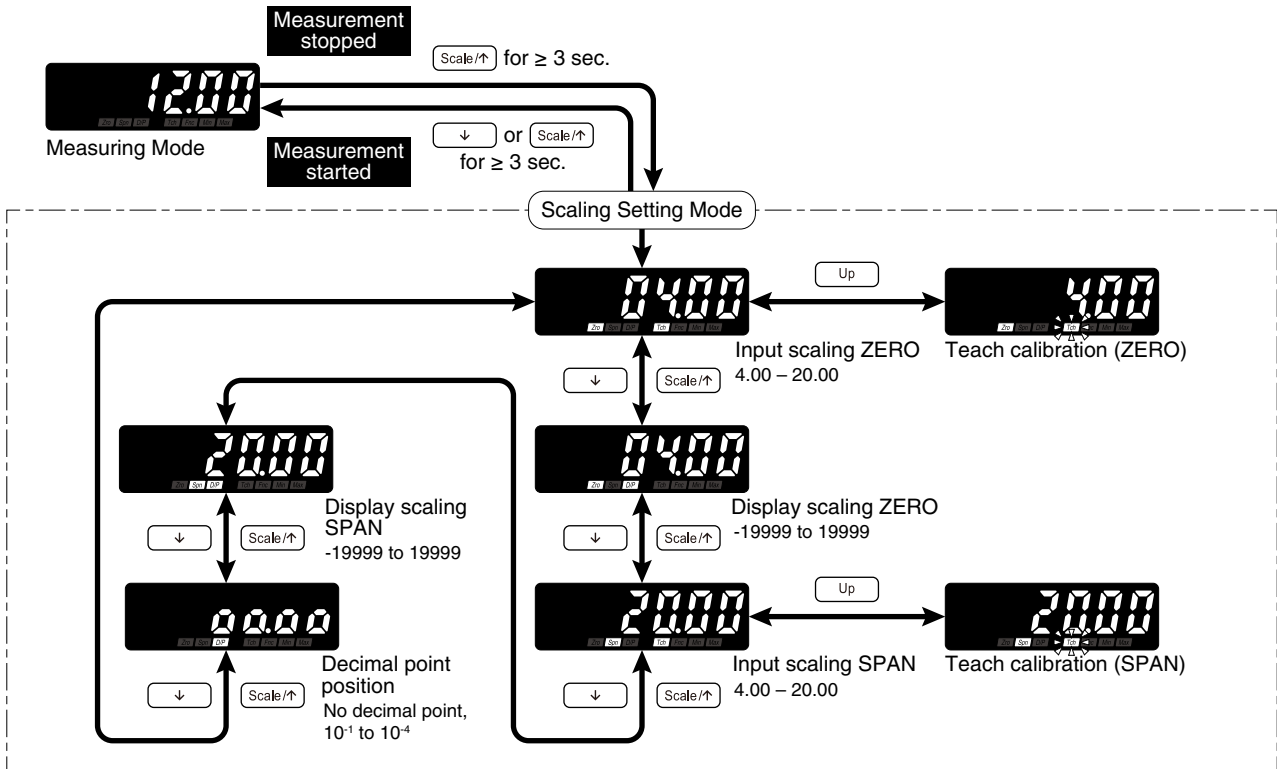

NOTE

The display depends on the settings and input.

15.4.3 ADVANCED SETTING MODE

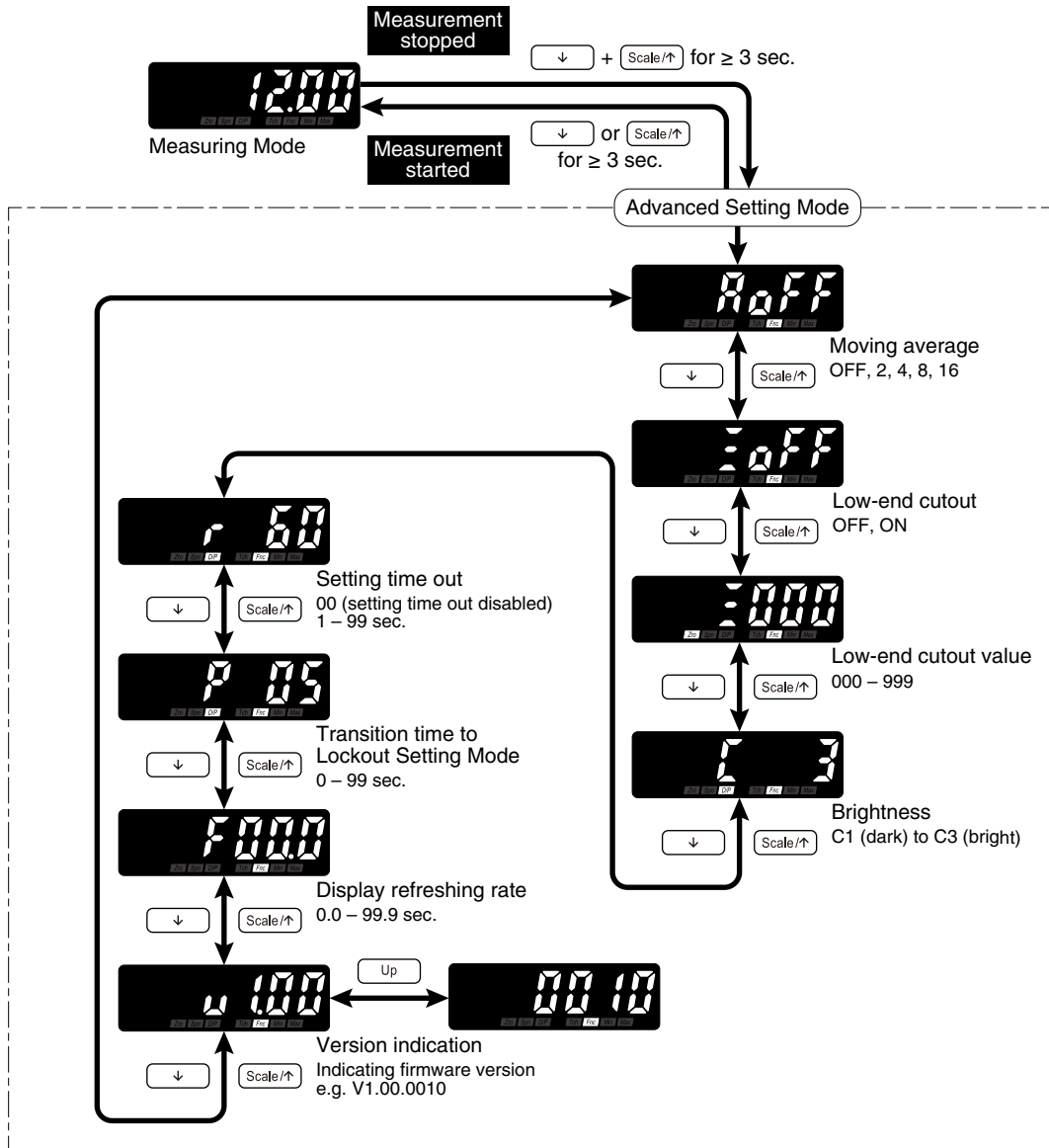

NOTE

- The display depends on the settings and input.
- With the low-end cutout set to OFF, the low-end cutout value setting is locked.
- Version indication is for indication only, not for setting.

15.4.4 LOCKOUT SETTING MODE

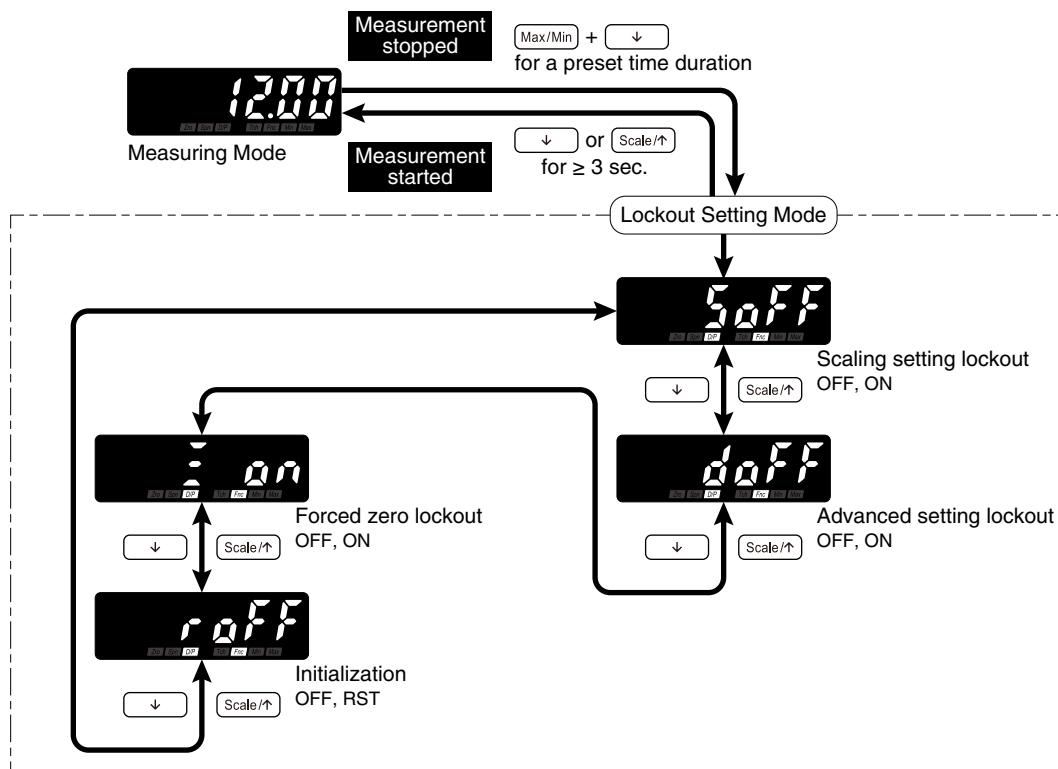













NOTE

The display depends on the settings and input.





















15.5 CHARACTER SET

■ NUMERALS AND NEGATIVE SIGN

0	1	2	3	4	5	6	7	8	9
									
-	-1*1								
									

*1 Indication when the fifth digit is '-1'.

■ ALPHABET

A	B	C	D	E	F	G	H	I	J
									
K	L	M	N	O	P	Q	R	S	T
									
U	V	W	X	Y	Z				
