

Digital Panel Meters 40 Series
LOOP POWERED DIGITAL PANEL METER
(4 digits, process meter)

Model: 40DN

OPERATING MANUAL

CONTENTS

1. INTRODUCTION	4
1.1 BEFORE USE	4
1.2 SAFETY PRECAUTIONS (that must be observed)	5
1.3 POINTS OF CAUTION	7
1.4 COMPONENT IDENTIFICATION	8
1.5 INSTALLATION	10
1.5.1 EXTERNAL DIMENSIONS	10
1.5.2 PANEL CUTOUT DIMENSIONS	10
1.5.3 INSTALLATION	11
1.6 WIRING INSTRUCTIONS	12
1.6.1 CAUTION IN WIRING	12
1.6.2 RECOMMENDED SOLDERLESS TERMINAL	12
1.6.3 TERMINAL ASSIGNMENT	12
1.6.4 WIRING INPUT SIGNAL	13
1.6.5 ATTACHING/REMOVING TERMINAL COVER	14
2. BASIC SETTING AND OPERATION	15
2.1 BASIC SETTING	15
2.1.1 BASIC SETTING FLOW	15
2.1.2 MOUNTING/REMOVING FRONT PANEL	15
2.1.3 BASIC SETTING PROCEDURE	16
2.2 BASIC SETTING OPERATION AND INSTRUCTIONS	18
2.2.1 BASIC SETTING OPERATION	18
2.2.2 INSTRUCTIONS ON BASIC OPERATION	20
3. SETTING DISPLAY SCALING	21
3.1 STEP 1. DISPLAY SCALING VALUE A	24
3.1.1 OPERATING PROCEDURE	24
3.2 STEP 2. DISPLAY SCALING VALUE B	26
3.2.1 OPERATING PROCEDURE	26
3.3 STEP 3. DECIMAL POINT POSITION	28
3.3.1 OPERATING PROCEDURE	28
4. OPERATION	30
5. PARAMETER CONFIGURATION	31
6. AVERAGING INPUT	32
6.1 OPERATING PROCEDURE	33

7. ADJUSTING BRIGHTNESS OF DISPLAY	34
7.1 OPERATING PROCEDURE.....	35
8. USER CALIBRATION.....	37
9. INSPECTION / CLEANING	38
10. TROUBLESHOOTING	39
10.1 ERROR MESSAGES.....	39
10.2 INITIALIZING SETTING VALUES.....	40
10.2.1 OPERATING PROCEDURE	40
10.3 CONFIRMING FIRMWARE VERSION	42
10.3.1 OPERATING PROCEDURE	42
11. APPENDICES.....	43
11.1 SPECIFICATIONS	43
11.2 MODEL NUMBERING.....	45
11.3 PARAMETER LIST	46
11.4 PARAMETER MAP.....	47
11.4.1 SCALING SETTING MODE	47
11.4.2 DISPLAY SETTING MODE	47
11.5 CHARACTER SET	48

1. INTRODUCTION

1.1 BEFORE USE....

Thank you for choosing us. Before use, please check contents of the package you received as outlined below.

■ PACKAGE INCLUDES

Digital panel meter

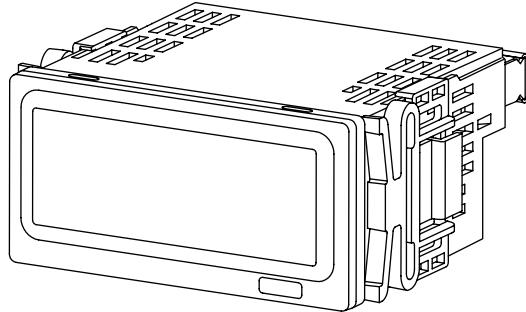

Accessories

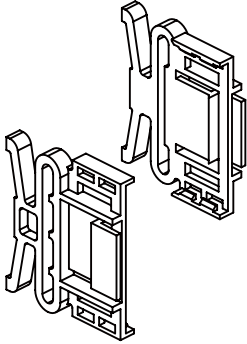
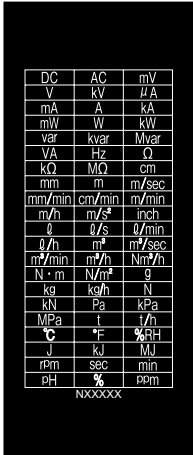
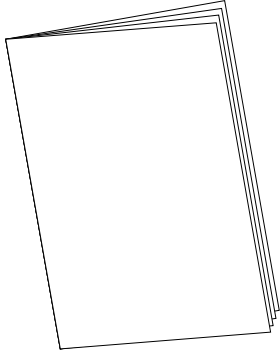
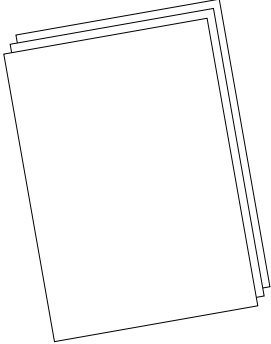
<p>Mounting bracket (2)</p> 	<p>Engineering unit sticker label sheet (1)</p>  <table border="1" data-bbox="722 972 871 1294"> <tr><td>DC</td><td>AC</td><td>mV</td></tr> <tr><td>V</td><td>kV</td><td>μA</td></tr> <tr><td>mA</td><td>A</td><td>KA</td></tr> <tr><td>mW</td><td>W</td><td>KW</td></tr> <tr><td>var</td><td>kvar</td><td>Mvar</td></tr> <tr><td>VA</td><td>Hz</td><td>Ω</td></tr> <tr><td>kΩ</td><td>MΩ</td><td>cm</td></tr> <tr><td>mm</td><td>m</td><td>m/sec</td></tr> <tr><td>mm/min</td><td>cm/min</td><td>m/min</td></tr> <tr><td>m/h</td><td>m/s²</td><td>inch</td></tr> <tr><td>l</td><td>l/s</td><td>l/min</td></tr> <tr><td>l/h</td><td>m³</td><td>m³/sec</td></tr> <tr><td>m³/min</td><td>m³/h</td><td>Nm³/h</td></tr> <tr><td>N · m</td><td>N/m²</td><td>g</td></tr> <tr><td>kg</td><td>kg/h</td><td>N</td></tr> <tr><td>kN</td><td>Pa</td><td>kPa</td></tr> <tr><td>MPa</td><td>t</td><td>t/h</td></tr> <tr><td>°C</td><td>°F</td><td>%RH</td></tr> <tr><td>J</td><td>kJ</td><td>MJ</td></tr> <tr><td>rpm</td><td>sec</td><td>min</td></tr> <tr><td>pH</td><td>%</td><td>ppm</td></tr> <tr><td colspan="3">NXXXXX</td></tr> </table>	DC	AC	mV	V	kV	μA	mA	A	KA	mW	W	KW	var	kvar	Mvar	VA	Hz	Ω	kΩ	MΩ	cm	mm	m	m/sec	mm/min	cm/min	m/min	m/h	m/s ²	inch	l	l/s	l/min	l/h	m ³	m ³ /sec	m ³ /min	m ³ /h	Nm ³ /h	N · m	N/m ²	g	kg	kg/h	N	kN	Pa	kPa	MPa	t	t/h	°C	°F	%RH	J	kJ	MJ	rpm	sec	min	pH	%	ppm	NXXXXX			<p>Instruction manual</p> 
DC	AC	mV																																																																		
V	kV	μA																																																																		
mA	A	KA																																																																		
mW	W	KW																																																																		
var	kvar	Mvar																																																																		
VA	Hz	Ω																																																																		
kΩ	MΩ	cm																																																																		
mm	m	m/sec																																																																		
mm/min	cm/min	m/min																																																																		
m/h	m/s ²	inch																																																																		
l	l/s	l/min																																																																		
l/h	m ³	m ³ /sec																																																																		
m ³ /min	m ³ /h	Nm ³ /h																																																																		
N · m	N/m ²	g																																																																		
kg	kg/h	N																																																																		
kN	Pa	kPa																																																																		
MPa	t	t/h																																																																		
°C	°F	%RH																																																																		
J	kJ	MJ																																																																		
rpm	sec	min																																																																		
pH	%	ppm																																																																		
NXXXXX																																																																				
<p>Ordering Information Sheet</p>  <p>(included with the option code 'SET' only)</p>																																																																				





■ MODEL NO.

Confirm Model No. marking on the product to be exactly what you ordered.

1.2 SAFETY PRECAUTIONS (that must be observed)

The following signs are used in this manual to provide precautions required to ensure safe usage of the unit. Please understand these signs and graphic symbols, read the manual carefully and observe the description.

The following signs show seriousness of safety hazard or damage occurred when used wrongly with the signs ignored.

 WARNING	Indicates a potentially hazardous situation which, if not avoided, may result in serious injury or death.	
 CAUTION	Indicates a potentially hazardous situation which, if not avoided, may result in injury or in property damage.	
 Indicates prohibitions.	 Indicates mandatory cautions.	 Indicates cautions.

WARNING



For safety, make sure that wiring is performed by qualified personnel only.

- Failure to do so may result in a fire, electric shock or injury.



Do not touch the terminals while the power is on.

- Doing so may result in electric shock.



Do not touch anything except for the buttons in removing the front panel.

- Doing so may result in malfunction or electric shock.



Check the connection diagram carefully before wire connection.

- Failure to do so may result in malfunction, a fire or electric shock.



Provide safety measures outside of the unit to ensure safety in the whole system if an abnormality occurs due to malfunction of the unit or another external factor affecting the unit's operation.



Do not splash water on the unit.

- Doing so may result in a fire, electric shock or injury.



Stop using the unit immediately if smokes, unusual smell or abnormal noises come(s) from it.

- Using the unit continuously may result in a fire or electric shock.



MANDATORY
CAUTION

Stop using the unit if it is dropped or damaged.
• Using the unit continuously may result in a fire or electric shock.



MANDATORY
CAUTION

Tighten the terminal block with a specified torque.
• Excessive fastening may result in damage of the terminal screws and loose screws may occasionally result in ignition.



PROHIBITION

Do not throw the unit into the fire.
• Doing so may result in rupture of the electronic component.

CAUTION



PROHIBITION
TO DISCOMPOSE

Never discompose or remodel the unit.
• Doing so may result in electric shock, malfunction or injury.



PROHIBITION

Do not connect or remove the unit while its input signal is supplied.
• Doing so may result in electric shock, malfunction or injury.



MANDATORY
CAUTION

Do not allow fine shavings or wire scraps to enter the unit in machining screws or wiring.
• Doing so may result in malfunction of the unit.



MANDATORY
CAUTION

Make sure to attach the terminal cover.
• Failure to do so may result in electric shock.



MANDATORY
CAUTION

Do not remove the front panel except in setting parameters.
• Doing so may result in malfunction due to mixing of foreign substances.



MANDATORY
CAUTION

Be aware of static electricity in operating buttons.
• Failure to do so may result in malfunction.



PROHIBITION

Do not pull the wires connecting to the unit.
• Doing so may result in electric shock, damage of the unit or injury.



PROHIBITION

Do not use the unit in an atmosphere where combustible gas is present.
• Doing so may result in inflammation, ignition, or smoke.



PROHIBITION

Do not cover the ventilation slits with cables, etc.
• Doing so may result in malfunction or heating.

1.3 POINTS OF CAUTION

■ CONFORMITY WITH EU DIRECTIVES

- Our products conforming to the EU Directives conforms to the standards required based on the premise that they are built into various equipment, apparatus or control panels to use. Because the EMC performance depends on the configuration, wiring or arrangement of the equipment, apparatus and control panels you build, it is necessary for you to make such equipment, apparatus or control panels to conform finally to the CE Marking by yourselves.

CAUTION

This product conforms to the EMC Directive for electrical and electronic apparatus intended for use in industrial environments. If it is used in the residential environments, it may cause radio interference, and the user is requested to take appropriate measures.

■ ENVIRONMENT

Install the unit within the installation specifications.

- Indoors use.
- Environmental temperature must be within -10 to +55°C (14 to 131°F) with relative humidity within 30 to 90% RH without condensing.
- Altitude up to 2000 meters.
- Provide sufficient space around the unit for heat dissipation.
- Mount the unit to a panel between 1.6 and 8 mm thick.
- Install the unit in a well-ventilated place in order to prevent internal temperature rise.
- Refer to "PANEL CUTOOUT" to install several units. In mounting the unit with other equipment side by side, provide sufficient space between them, according to the dimensions in the panel cutout.
- Do not use the unit under the following environments:
 - Where the unit is exposed to direct sunlight, rain or wind. (The unit is not designed for outdoor use.)
 - Where condensation may occur due to extreme temperature changes.
 - Where corrosive or flammable gas is present.
 - Where heavy dust, iron powder or salt is present in the air.
 - Where organic solvent such like benzene, thinner, and alcohol, or strong alkaline materials such like ammonia and caustic soda may attach to the unit, or where such materials are present in the air.
 - Where the unit is subject to continuous vibration or physical impact.
 - Where there are high-voltage lines, high-voltage equipment, power lines, power equipment, equipment with transmission unit such like a ham radio equipment, or equipment generating large switching surges around the unit.

■ WIRING

- In order to prevent potential electric shock, wire the unit after cutting the input signal and making sure that the power is not supplied to the cable.
- Be sure to confirm the name and polarity of each terminal before wiring to the terminal block.
- Do not connect anything to unused terminals.
- Be sure to attach the terminal cover to prevent electric shock.

■ HANDLING CAUTIONS

- The unit is designed to function as soon as input signal is supplied, however, a warm up for 10 minutes is required for satisfying complete performance described in the data sheet.
- Clean the surface of the unit with wet soft cloth. Do not use organic solvent such like benzene, thinner and alcohol. Doing so may result in deformation or discoloration of the unit.
- When abnormality is found such like smokes, unusual smell and abnormal noises coming from the unit, immediately remove the input signal and stop using it.

1.4 COMPONENT IDENTIFICATION

■ FRONT VIEW

• With Front Panel

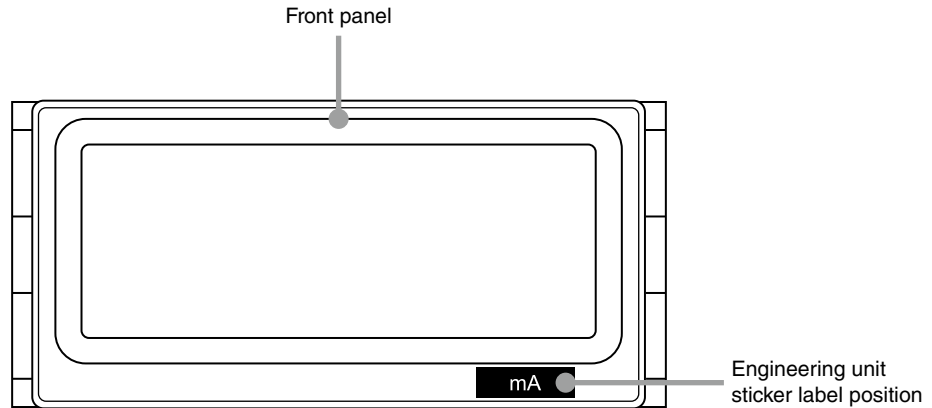

NOTE

- The engineering unit sticker label position is our recommended position.
- When an engineering unit is specified by the Ordering Information Sheet, the unit(s) will be shipped with the sticker label put on the above position.

• Without Front Panel

COMPONENT	FUNCTION	COMPONENT	FUNCTION
Polarity indicator	Turns on when negative value is displayed.	4-digit display	Indicates present value, setting value and scaling error. Range: 0 to 9999

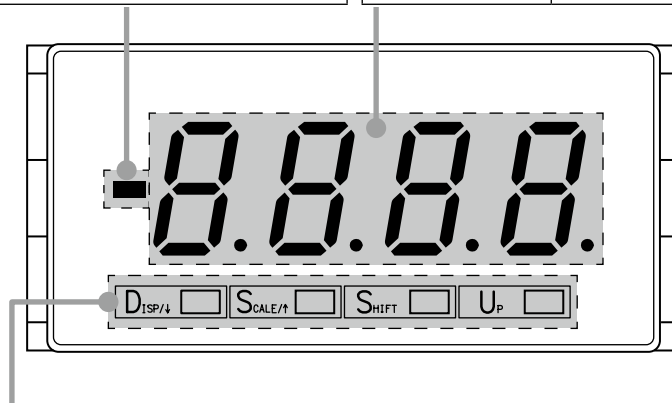

BUTTON	FUNCTION
DISP/↓	Used to move on to the display setting mode; or to shift through setting items in each setting mode.
SCALE/↑	Used to move on to the scaling setting mode; or to shift through setting items in each setting mode.
SHIFT	Used to move on to the setting standby status of each setting mode and to shift through display digits in each setting item.
UP	Used to change setting values in a setting standby mode.

■ TOP VIEW

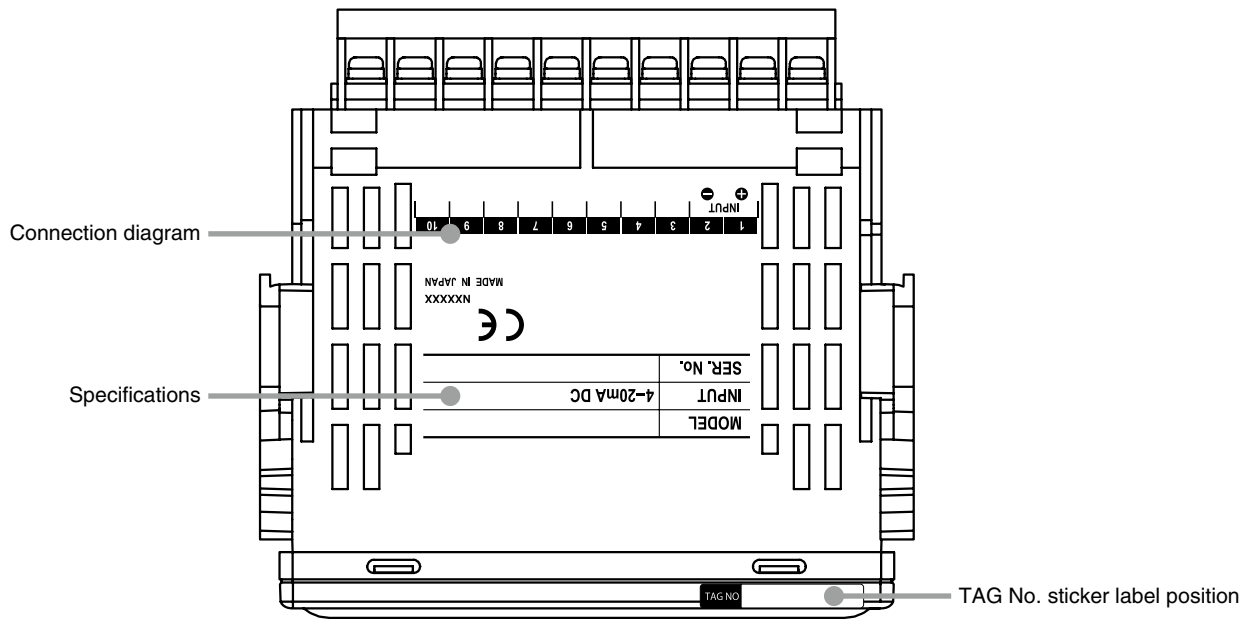

NOTE

- Contents of the specification label depend on the specifications.
- The tag No. label sticker position is our recommended position.
- When a tag No. is specified, the unit(s) will be shipped with the tag No. sticker label put on the above position. Max. 17 alphanumeric characters can be specified. Please consult us.

1.5 INSTALLATION

1.5.1 EXTERNAL DIMENSIONS

unit: mm (inch)

■ TOP VIEW

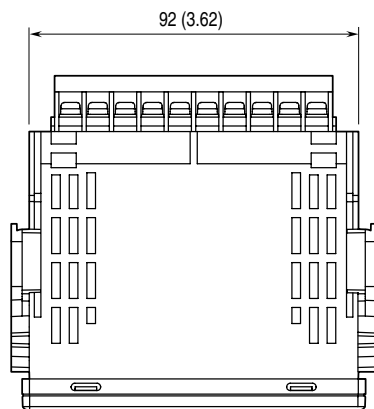

■ FRONT VIEW

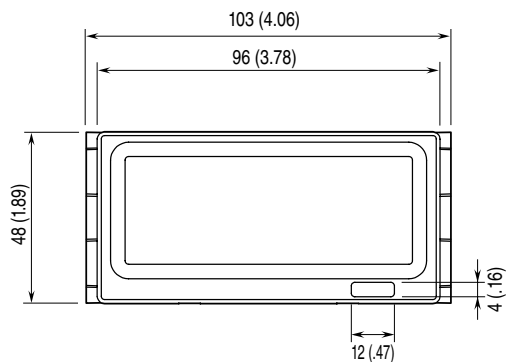

■ SIDE VIEW

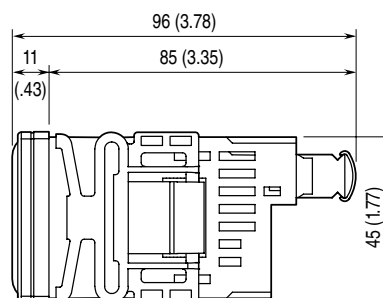

■ REAR VIEW

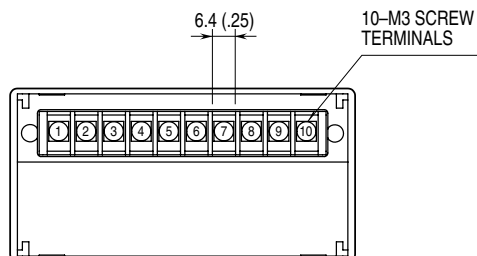

1.5.2 PANEL CUTOUT DIMENSIONS

unit: mm

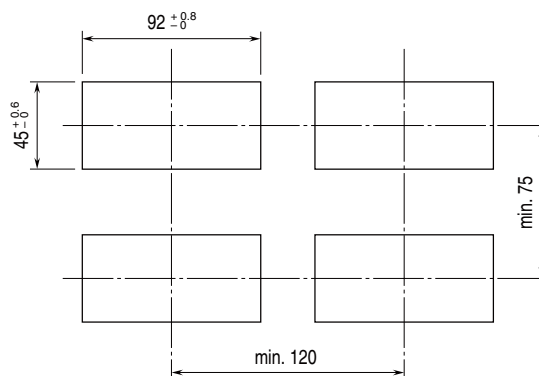

Panel thickness: 1.6 to 8.0 mm

1.5.3 INSTALLATION

- (1) Remove the mounting brackets.
 - (a) Flip a tab of a bracket.
 - (b) Then pull the bracket toward the terminal block to remove it.

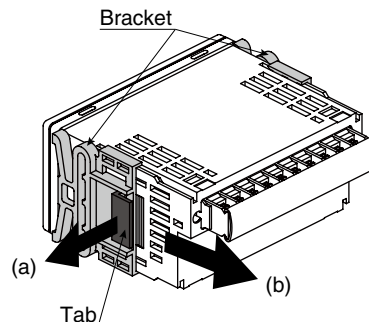

- (2) Insert the unit into the panel cutout.

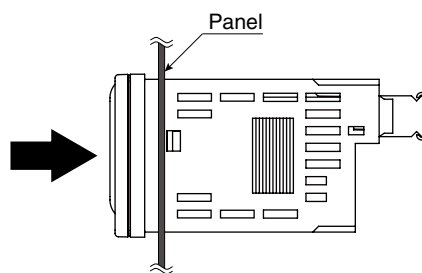

- (3) Push the mounting brackets into the grooves on both sides of the rear module, until they hit the panel's rear side.

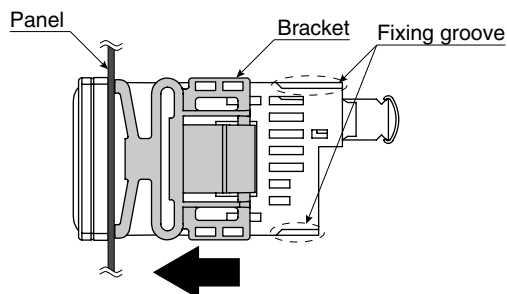

1.6 WIRING INSTRUCTIONS

1.6.1 CAUTION IN WIRING

- For safety, make sure that wiring is performed by qualified personnel only.
- In order to prevent potential electric shock, wire the unit after cutting the input signal and making sure that the power is not supplied to the cable.
- Be sure to confirm the name and polarity of each terminal before wiring to it.
- Do not connect anything to unused terminals.
- We offer a series of lightning surge protectors for protection against induced lightning surges. Please contact us to choose appropriate models.

1.6.2 RECOMMENDED SOLDERLESS TERMINAL

- Use solderless terminals for M3. Refer to the drawings below.

unit: mm (inch)

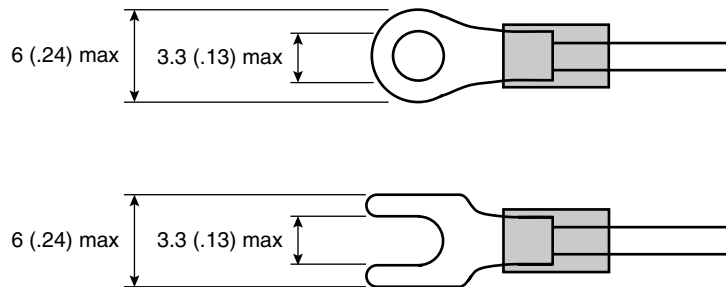

Applicable wire size: 0.25 to 1.65 mm²

Torque: 0.6 N·m

Recommended manufacturer: Japan Solderless Terminal MFG. Co., Ltd., Nichifu Co., Ltd.

IMPORTANT

- Insulated solderless terminals are recommended.
- In using non-insulated solderless terminals, cover them with insulating caps or tubes.
- Ring tongue terminals are recommended rather than spade tongue terminals to prevent from falling off.

1.6.3 TERMINAL ASSIGNMENT

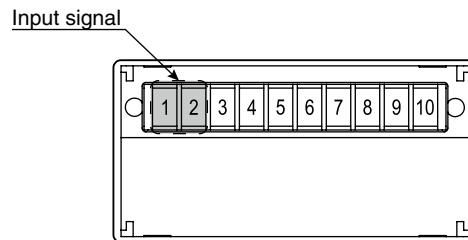

1.6.4 WIRING INPUT SIGNAL

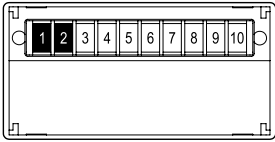

Connect DC current signal wires.

Current range		Approx. 3.7 to 23 mA DC
Voltage drop	Input 4 mA DC	Approx. 5 V
	Input 20 mA DC	Approx. 5.2 V (equivalent input impedance: approx. 260 Ω)

IMPORTANT

- Be sure to confirm the input polarity in wiring. Wrong connection may result in malfunction of the unit.
- In order to prevent potential electric shock, wire the unit after cutting the input signal and making sure that the power is not supplied to the cable.
- Take measures to reduce noise as much as possible, e.g. by using shielded twisted pair wires for the input signal. Ground the input shield to the most stable earth to prevent noise troubles.
- Do not connect anything to unused terminals.
- The unit does not operate with the input under approx. 3.7 mA.
- Make sure that the equivalent input impedance is within the permissible load resistance of an input device or a two-wire transmitter.

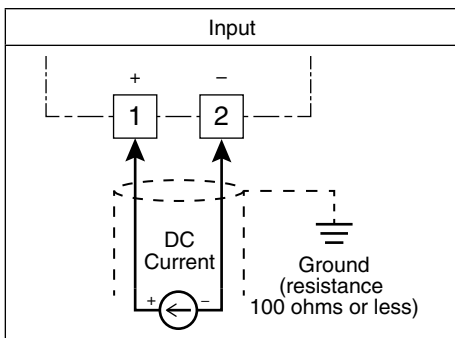

CONNECTION EXAMPLE

• 2-WIRE

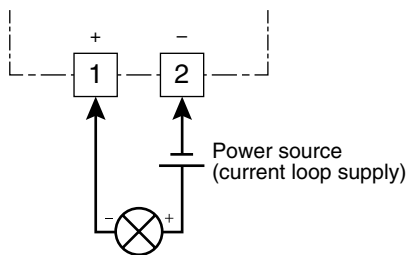

• 4-WIRE

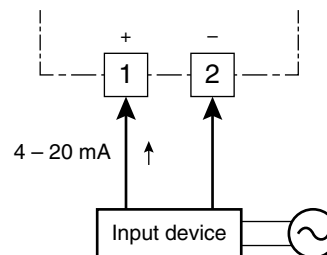

1.6.5 ATTACHING/REMOVING TERMINAL COVER

Attach the terminal cover for safety after wiring.

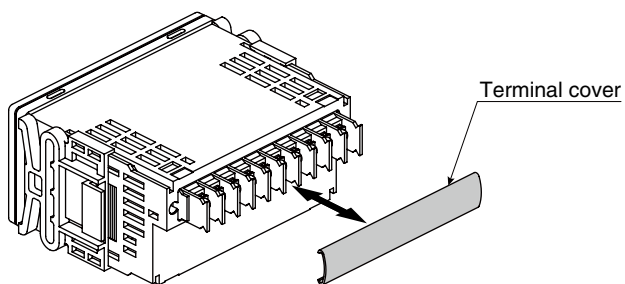

2. BASIC SETTING AND OPERATION

2.1 BASIC SETTING

This section describes flow and procedure of the basic setting.

The following shows the flow and procedure to set the input to 4 – 20 mA DC and the display to 0.0 – 100.0% as an example.

2.1.1 BASIC SETTING FLOW

The basic setting is as shown in the following flowchart.

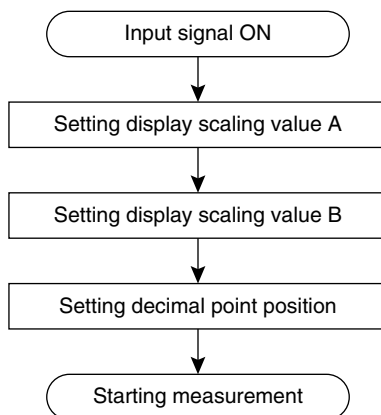

2.1.2 MOUNTING/REMOVING FRONT PANEL

- Set parameters with the buttons inside the front panel. Remove the panel in setting.
- Mount the panel after configuration.

■ REMOVING FRONT PANEL

(1) Hold up the front panel.

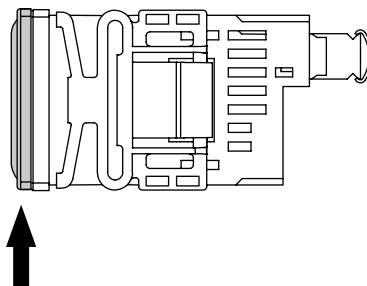

(2) Remove the panel from downside.

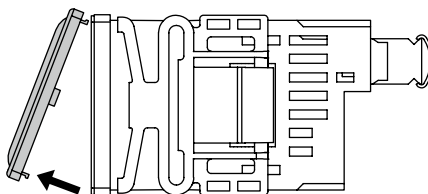

■ MOUNTING FRONT PANEL

(1) Insert the front panel hook into the case upside slots of the unit.

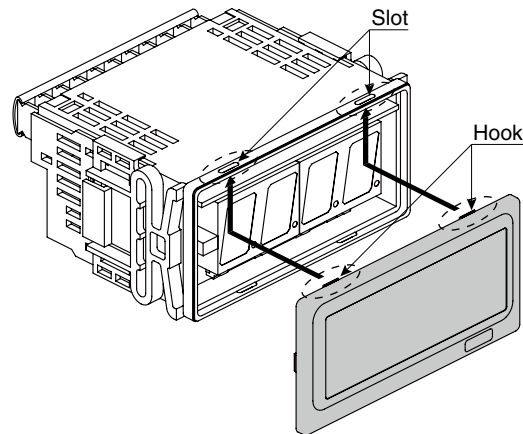

(2) Push the panel hook into the case downside slots of the unit.

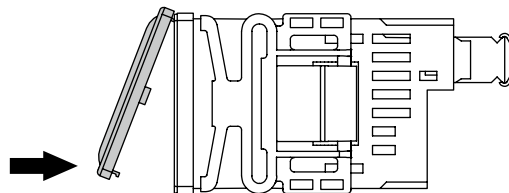

NOTE

- Be sure to confirm the direction of the front panel in mounting.
- Make sure that there is no misalignment or space between the unit and the panel after mounting.

2.1.3 BASIC SETTING PROCEDURE

The following shows the procedure to set the input to 4 – 20 mA DC and the display to 0.0 – 100.0% as an example. Set values meeting signals of the equipment to use. Refer to 3. SETTING DISPLAY SCALING for details of setting.

■ PARAMETER LIST FOR BASIC SETTING

Parameters used in the basic setting are as shown in the following table.

PARAMETER	SETTING VALUE	SETTING
Display scaling value A	0000 ^{*1}	0% display: 0.0%
Display scaling value B	1000 ^{*1}	100% display: 100.0%
Decimal point position	888.8	1 decimal place (10 ⁻¹)

*1 The decimal point position depends on the decimal point position setting.

■ BASIC SETTING PROCEDURE

The basic setting procedure is as follows.

1 Confirm the wiring, supply the input and move on to Scaling Setting Mode (measurement stopped).

- Hold down SCALE/↑ button for 3 seconds or more.

2 Set display scaling value A.

- Press SHIFT button to shift the display into the setting standby mode.
- Press SHIFT button to go to the next digit and UP button to change the blinking value.

3 Set display scaling value B.

- Press DISP/↓ or SCALE/↑ button to apply the new setting and go to the next or previous parameter setting.
- Press SHIFT button to shift the display into the setting standby mode.
- Press SHIFT button to go to the next digit and UP button to change the blinking value.

4 Set decimal point position.

- Press DISP/↓ or SCALE/↑ button to apply the new setting and go to the next or previous parameter setting.
- Press SHIFT button to shift the display into the setting standby mode and UP button to select the decimal point position.

5 Return to Measuring Mode (measurement started).

- Hold down DISP/↓ or SCALE/↑ button for 1 second or more to apply the new setting and return to Measuring Mode.

2.2 BASIC SETTING OPERATION AND INSTRUCTIONS

This section describes basic operation and instructions when setting parameters.

2.2.1 BASIC SETTING OPERATION

Parameters can be grouped into three setting types, “numerical value setting”, “setting value selection” and “decimal point position selection”. Basic operation of each type is as shown below.

■ NUMERICAL VALUE SETTING

1 Press **SHIFT** button to shift the display into the setting standby mode.

- The 4th digit starts blinking.



2 Press **SHIFT** and **UP** buttons to set a numerical value.

- Press **SHIFT** button to go to the next digit.
- Press **UP** button to change the blinking value.



3 Press **DISP/↓** or **SCALE/↑** button to apply the new setting.

- The next or previous parameter setting is indicated.



*1 Display depends on the settings.

NOTE

■ SHIFTING DIGITS

Each time pressing **SHIFT** button, the blinking digit moves to the right.

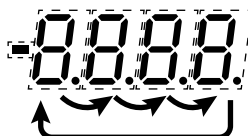

■ SETTING A NUMERICAL VALUE

- Each time pressing **UP** button, the numeral is incremented by 1.
- The negative sign (-) must be set together with the 4th digit. For example, set '-04.00' instead of '-4.00'.

- 4th digit

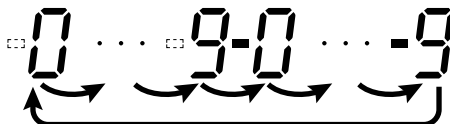

- Other digits

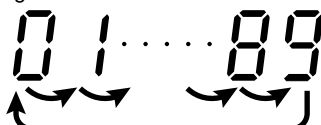

■ SETTING VALUE SELECTION

- 1 Press **SHIFT** button to shift the display into the setting standby mode.
 - The current set value starts blinking.

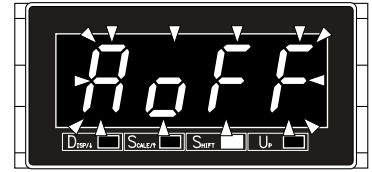

- 2 Press **UP** button to select your desired setting value.

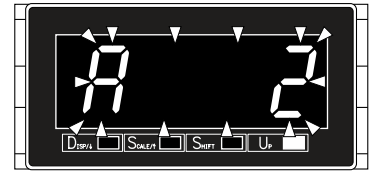

- 3 Press **DISP/↓** or **SCALE/↑** button to apply the new setting.
 - The next or previous parameter setting is indicated.



*1 Display depends on the settings.

■ DECIMAL POINT POSITION SELECTION

- 1 Press **SHIFT** button to shift the display into the setting standby mode.
 - The current set value starts blinking.

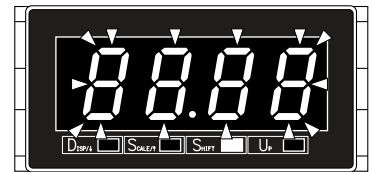

- 2 Press **UP** button to select a desired decimal point position.



- 3 Press **DISP/↓** or **SCALE/↑** button to apply the new setting.
 - The next or previous parameter setting is indicated.



*1 Display depends on the settings.

NOTE

■ MOVING THE DECIMAL POINT

Pressing UP button moves the decimal point one place to the left.

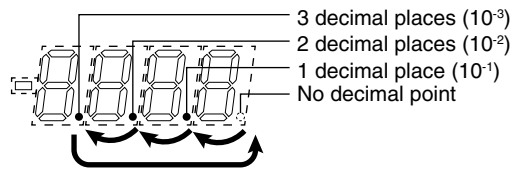

■ DECIMAL POINT POSITION

“No decimal point” to “3 decimal places” can be selected in the decimal point position setting.

SETTING VALUE	FUNCTION	SETTING VALUE	FUNCTION
0.000	No decimal point	0.000	2 decimal places (10 ⁻²)
0.000	1 decimal place (10 ⁻¹)	0.000	3 decimal places (10 ⁻³)

2.2.2 INSTRUCTIONS ON BASIC OPERATION

■ IF THE FRONT BUTTONS ARE LEFT UNTOUCHED...

- The indication turns on with applying the last changes after approximately 1 minute while it is in the setting standby mode.
- The display goes back automatically to Measuring Mode after approximately 1 minute in one of the other modes.

■ TO ABORT A SETTING...

- Hold down SHIFT button for 3 seconds or more to return to Measuring Mode without applying the last changes while the display is in the setting standby mode.
- If you get lost in a setting mode, you can execute initialization. Refer to 10.2 INITIALIZING SETTING VALUES.

3. SETTING DISPLAY SCALING

■ DISPLAY SCALING

Set display scaling within the range of -9999 to 9999 for 4 – 20 mA DC (measurement range).

The display scaling values include A and B. A decimal point can be set in any position.

- Display scaling value A is a display value for 4 mA DC.
- Display scaling value B is a display value for 20 mA DC.
- Decimal point position can be set in common for both display scaling value A and B.

e.g. Display value 0.0 – 100.0%

Measurement range 0%	4 mA DC
Measurement range 100%	20 mA DC
Display scaling value A	0.0%
Display scaling value B	100.0%
Decimal point position	888.8 (1 decimal place)

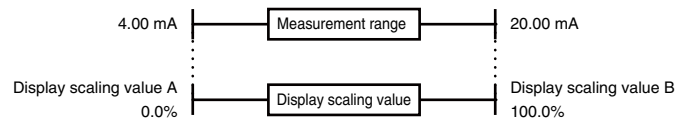

When the input signal is other than 4 – 20 mA DC (e.g. 6 – 16 mA DC), obtain the values parallel shifted from the desired display values for the input signal to 4 – 20 mA DC (measurement range). Set the obtained values as display scaling value A and B.

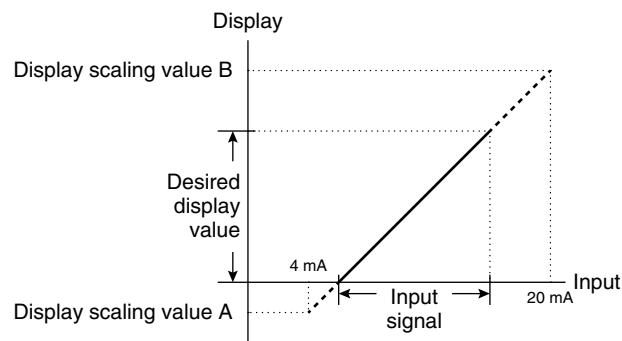

The next paragraph describes how to calculate the display scaling value A and B when the input is other than 4 – 20 mA DC.

■ CALCULATION OF DISPLAY SCALING WITH INPUT OTHER THAN 4 – 20 MA DC

Refer to the following example to calculate the display scaling value A and B when the input is other than 4 – 20 mA DC.

Example: to display 6 – 16 mA DC input as -5.00 to +5.00 m

Measurement range 4 – 20 mA DC
 Input signal 6 – 16 mA DC
 Desired display value -5.00 to +5.00 m

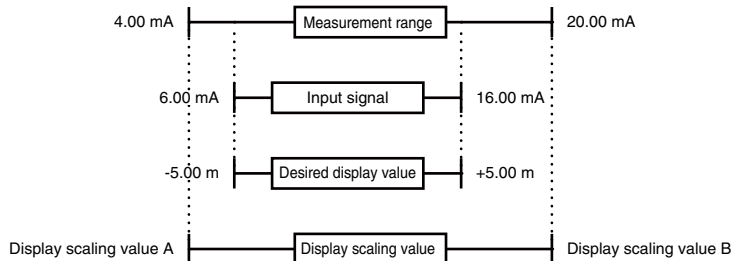

Calculate the display scaling value A and B with the following formulas.

$$SA = \frac{Rz \times Dspan + Dz \times Is - Ds \times Iz}{Ispan}$$

$$SB = \frac{Rs \times Dspan + Dz \times Is - Ds \times Iz}{Ispan}$$

- Rz Measurement range 4 mA
- Rs Measurement range 20 mA
- Iz Input signal 0%
- Is Input signal 100%
- Dz Desired display value 0%
- Ds Desired display value 100%
- Ispan Input span (Is – Iz)
- Dspan Display span (Ds – Dz)
- SA Display scaling value A
- SB Display scaling value B

(1) Display scaling value A (SA)

In the above formulas, omit the decimal point for the desired display values.

Ispan = 16 – 6 = 10
 Dspan = 500 – (-500) = 1000

$$SA = \frac{(4 \times 1000) + (-500 \times 16) - (500 \times 6)}{10}$$

$$= \frac{4000 + (-8000) - 3000}{10} = \frac{-7000}{10} = -700$$

(2) Display scaling value B (SB)

$$SB = \frac{(20 \times 1000) + (-500 \times 16) - (500 \times 6)}{10}$$

$$= \frac{20000 + (-8000) - 3000}{10} = \frac{9000}{10} = 900$$

From the above calculations, the display scaling value A is -0700, and B is 0900.

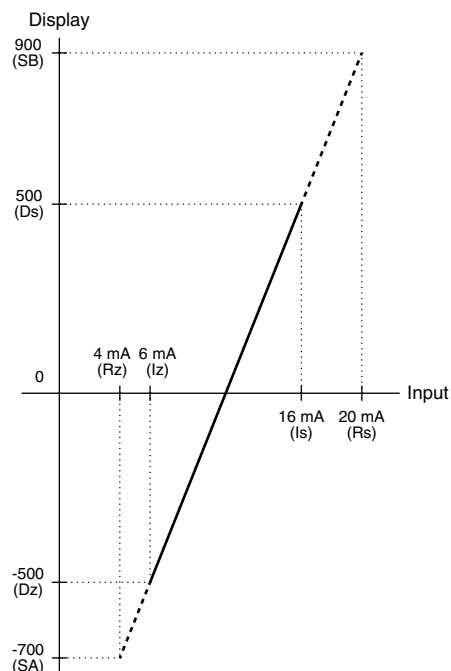

IMPORTANT

Setting the calculated display scaling value A or B below -9999 or over 9999 is not available. Change the display digit number in such a case.

■ PROCEDURE TO SET DISPLAY SCALING

- Flow in setting display scaling

3-step settings are necessary to set display scaling.

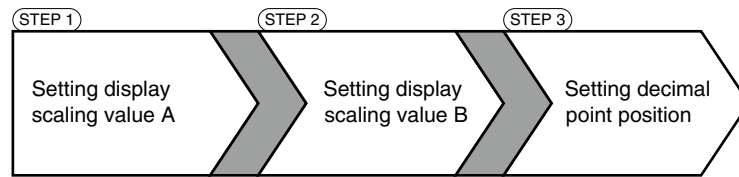

- Operating procedure to set display scaling

Following pages describe operating procedures in each step to set the display scaling to 0.0 – 100.0% with the input 4 – 20 mA DC as an example.

IMPORTANT

- To distinguish from the display scaling value B, the first decimal point blinks in setting the display scaling value A.
- Both normal scaling (display scaling value A < display scaling value B) and inverted scaling (display scaling value A > display scaling value B) can be set within the range of -9999 to 9999.

■ Normal Scaling

The display value increases when the input signal increases.

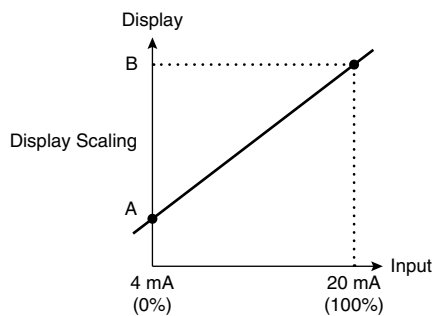

■ Inverted Scaling

The display value decreases when the input signal increases.

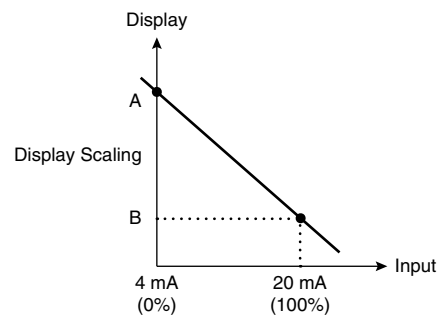

3.1 STEP 1. DISPLAY SCALING VALUE A

3.1.1 OPERATING PROCEDURE



NOTE

The left figure shows a display example. The display depends on the settings.

1 Confirm the wiring, and supply the input.

- The indication turns on from the left and then the display moves on to Measuring Mode.



*1 Display depends on the settings and input.

NOTE

Indication 'S.ERR' may blink, which shows the input out of the permissible range and does not show the unit failure.

2 Hold down SCALE/↑ button for 3 seconds or more to move on to Scaling Setting Mode.

- The display scaling value A is indicated.
- The first decimal point starts blinking.



NOTE

Skip to Step 6 if the default value is acceptable.

3 Press SHIFT button to shift the display into the setting standby mode.

- The fourth digit starts blinking, to which you can apply changes.



.....

4 Press **SHIFT** and **UP** buttons to set to '00.00'.

- Press **SHIFT** button to go to the next digit and **UP** button to change the blinking value.

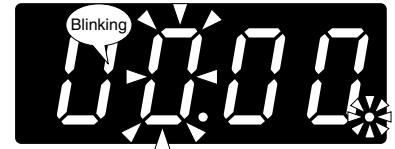

NOTE

- '00.00' is a display example. Set any value within the range of -9999 to 9999.
- The decimal point position depends on the decimal point position setting. Disregard the decimal point here.
- The negative sign (-) must be set together with the 4th digit. For example, set '-04.00' instead of '-4.00'.

.....

5 Press **DISP/↓** or **SCALE/↑** button to apply the new setting.

- And the next parameter setting is indicated.

NOTE

- Press **DISP/↓** button, and the display scaling value B will be indicated.
- Press **SCALE/↑** button, and the decimal point position will be indicated.

.....

6 ■ **TO GO ON TO SET THE DISPLAY SCALING VALUE B,**
Skip to Step 3 in "3.2 STEP 2. DISPLAY SCALING VALUE B"

■ **TO QUIT,**

Hold down **DISP/↓** or **SCALE/↑** button for 1 second or more to return to Measuring Mode.

3.2 STEP 2. DISPLAY SCALING VALUE B

3.2.1 OPERATING PROCEDURE

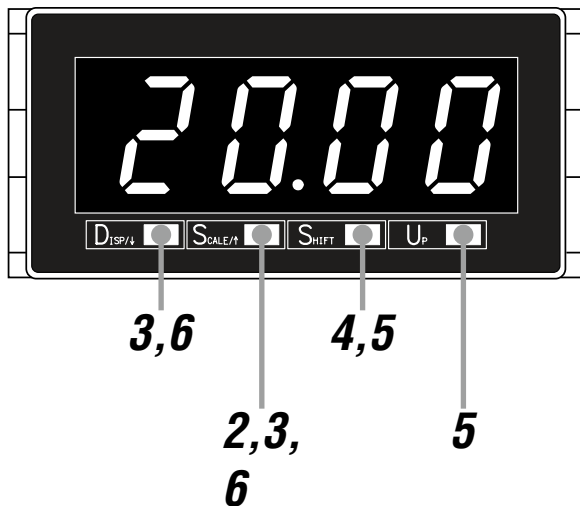

NOTE

The left figure shows a display example. The display depends on the settings.

1 Confirm the wiring, and supply the input.

- The indication turns on from the left and then the display moves on to Measuring Mode.



*1 Display depends on the settings and input.

NOTE

Indication 'S.ERR' may blink, which shows the input out of the permissible range and does not show the unit failure.

2 Hold down SCALE/↑ button for 3 seconds or more to move on to Scaling Setting Mode.

- The display scaling value A is indicated.
- The first decimal point starts blinking.



3 Press DISP/↓ or SCALE/↑ button to go to the display scaling value B setting.

- The display scaling value B is indicated.



NOTE

Skip to Step 7 if the default value is acceptable.

4 Press **SHIFT** button to shift the display into the setting standby mode.

- The forth digit starts blinking, to which you can apply changes.



5 Press **SHIFT** and **UP** buttons to set to '10.00'.

- Press **SHIFT** button to go to the next digit and **UP** button to change the blinking value.



NOTE

- '10.00' is a display example. Set any value within the range of -9999 to 9999.
- The decimal point position depends on the decimal point position setting. Disregard the decimal point here.
- The negative sign (-) must be set together with the 4th digit. For example, set '-04.00' instead of '-4.00'.

6 Press **DISP/↓** or **SCALE/↑** button to apply the new setting.

- And the next parameter setting is indicated.

NOTE

- Press **DISP/↓** button, and the decimal point position will be indicated.
- Press **SCALE/↑** button, and the display scaling value A will be indicated.

7 ■ **TO GO ON TO SET THE DECIMAL POINT POSITION,**
Skip to Step 3 in "3.3 STEP 3. DECIMAL POINT POSITION".

■ **TO QUIT,**

Hold down **DISP/↓** or **SCALE/↑** button for 1 second or more to return to Measuring Mode.

3.3 STEP 3. DECIMAL POINT POSITION

3.3.1 OPERATING PROCEDURE

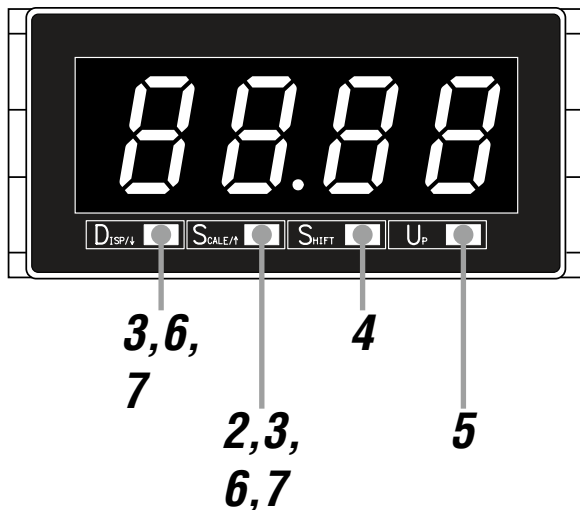

NOTE

The left figure shows a display example. The display depends on the settings.

1 Confirm the wiring, and supply the input.

- The indication turns on from the left and then the display moves on to Measuring Mode.



*1 Display depends on the settings and input.

NOTE

Indication 'S.ERR' may blink, which shows the input out of the permissible range and does not show the unit failure.

2 Hold down SCALE/↑ button for 3 seconds or more to move on to Scaling Setting Mode.

- The display scaling value A is indicated.
- The first decimal point starts blinking.



3 Press DISP/↓ or SCALE/↑ button to go to the decimal point position setting.

- The decimal point position is indicated.



NOTE

Skip to Step 7 if the default value is acceptable.

4 Press **SHIFT** button to shift the display into the setting standby mode.

- The indication starts blinking, to which you can apply changes.



5 Press **UP** button to select the decimal point position.

- Select 1 decimal place (10^{-1}).
- Press **UP** button to move the decimal point.

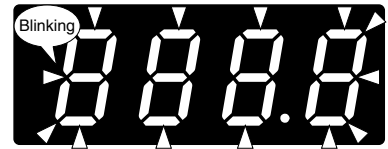

NOTE

The right figure shows a display example. Select one among “no decimal point,” and “1 decimal place” to “3 decimal places”

6 Press **DISP/↓** or **SCALE/↑** button to apply the new setting.

- And the next parameter setting is indicated.

NOTE

- Press **DISP/↓** button, and the display scaling value A will be indicated.
- Press **SCALE/↑** button, and the display scaling value B will be indicated.

7 Hold down **DISP/↓** or **SCALE/↑** button for 1 second or more to return to Measuring Mode.

4. OPERATION

Make sure that 0.0 – 100.0% is correctly indicated according to the input 4 – 20 mA DC provided.

IMPORTANT

Before operating, make sure that the wiring is correct, and the input is within the specification range.

- 1 Apply 4 mA input (0%) and make sure that 0.0% is indicated.



*1 Display depends on the settings and input.

NOTE

■ WHEN THE FOLLOWING IS INDICATED...

- When 'S.ERR' is indicated, the input is not applied correctly. Check the input wiring, equipment and signal.

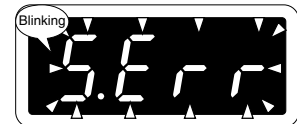

- 2 Apply 12 mA input (50%) and make sure that 50.0% is indicated.



- 3 Apply 20 mA input (100%) and make sure that 100.0% is indicated.



5. PARAMETER CONFIGURATION

■ MODE

Parameters can be grouped in several modes.
The 40DN has modes as shown in the following table.

MODE	FUNCTION	MEASUREMENT
Measuring	Normal measurement state where the unit takes in input. When the input is supplied, the unit operates in Measuring Mode.	Measuring
Scaling Setting	Basic settings such like display scaling value A and B, and decimal point position can be performed.	Measuring stopped
Display Setting	Moving average and brightness can be set. Settings can be initialized. Also the firm-ware version can be confirmed.	

■ MODE TRANSITION

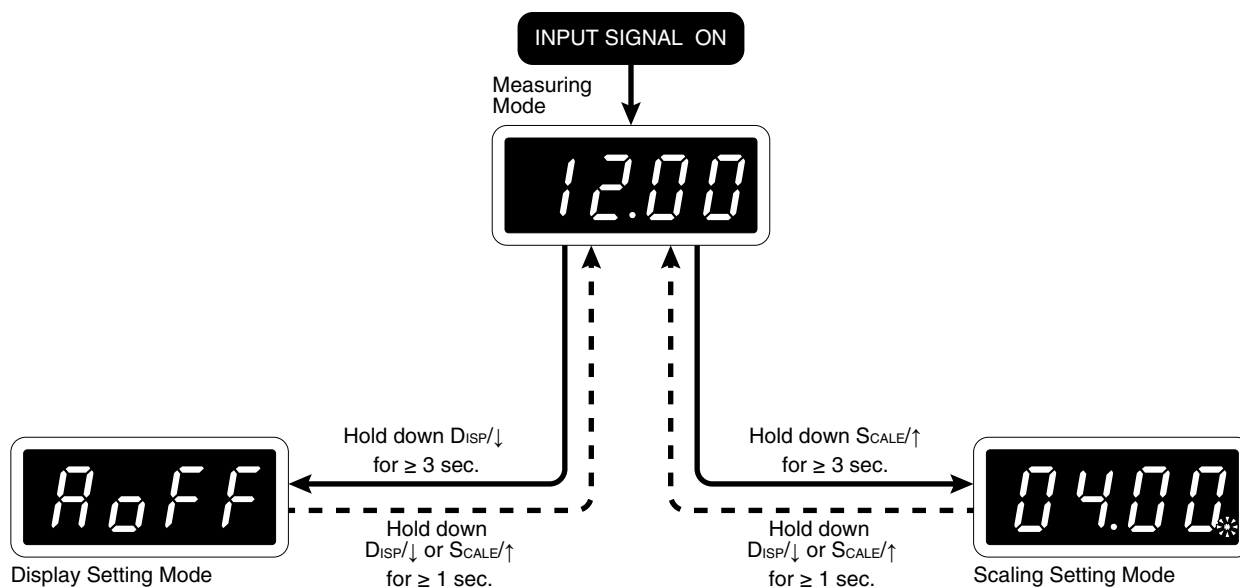

■ TRANSITION FROM MEASURING MODE TO EACH MODE

To Scaling Setting Mode	Hold down SCALE/↑ button for 3 seconds or more.
To Display Setting Mode	Hold down DISP/↓ button for 3 seconds or more.

■ TRANSITION FROM EACH MODE TO MEASURING MODE

Hold down DISP/↓ or SCALE/↑ button for 1 second or more to return to Measuring Mode.

6. AVERAGING INPUT

Moving average processing of measured values is configurable. The number of samples in processing the moving average can be selected in the following table. This operation averages sampled values, and then, averages with a new sample added and the oldest one omitted. Such operation is repeated as shown in the following figure. For instance, when 'A 4' is selected, the moving average processing with 4 samples (400 millisecond intervals) is repeated. Moving average is used to remove periodic varied noise superimposed on the input signal and suppress the display flickering.

■ NUMBER OF SAMPLES

DISPLAY	FUNCTION	DEFAULT VALUE
[R0FF]	No moving averaging	[R0FF]
[R2]	Moving average with 2 samples (200 millisecond intervals)	
[R4]	Moving average with 4 samples (400 millisecond intervals)	
[R8]	Moving average with 8 samples (800 millisecond intervals)	

■ EXAMPLE OF MOVING AVERAGE WITH 4 SAMPLES

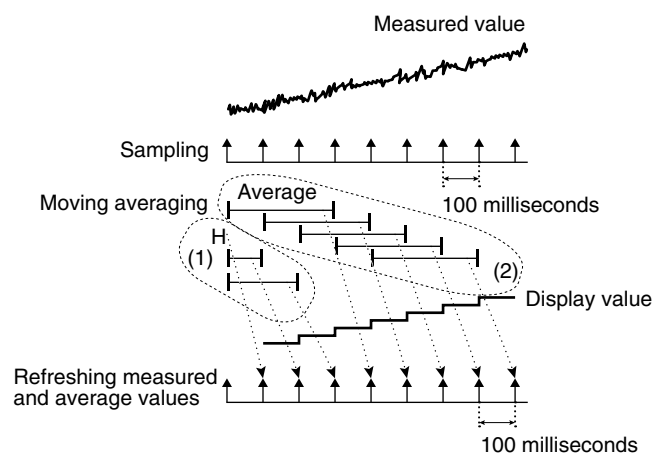

- (1) The moving average operation starts immediately after the input is supplied or the moving average is set. Until the sampling No. reaches the set value, all samples are averaged every 100 milliseconds.
- (2) After the sampling No. reaches the set value, a new sample is added to be averaged with the oldest one omitted. Such operation is repeated.

6.1 OPERATING PROCEDURE

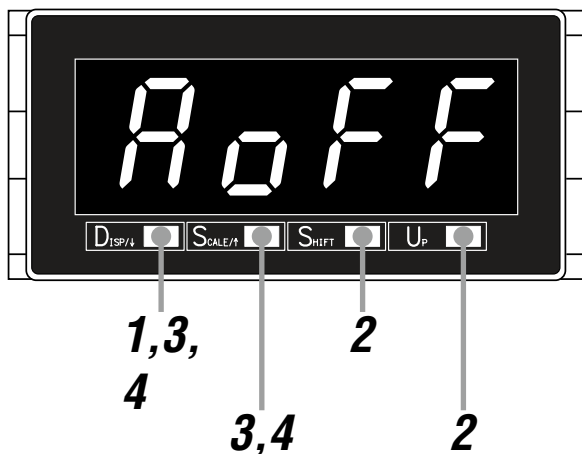

NOTE

The following figures are display examples. The displays depend on the settings.

- 1** Hold down **DISP/↑** button for 3 seconds or more to move on to Display Setting Mode.

- The moving average sampling No. is indicated.



NOTE

'A0FF', 'A 2', 'A 4' or 'A 8' is indicated depending on the setting.

- 2** Press **SHIFT** or **UP** button to select.

- Select one among 'A0FF', 'A 2', 'A 4' and 'A 8'.



- 3** Press **DISP/↓** or **SCALE/↖** button to apply the new setting.

- And the next parameter setting is indicated.

NOTE

- Press **DISP/↓** button, and the brightness 'C 1', 'C 2' or 'C 3' will be indicated depending on the setting.
- Press **SCALE/↖** button, and the version indication will be indicated.

- 4** Hold down **DISP/↓** or **SCALE/↖** button for 1 second or more to return to Measuring Mode.

7. ADJUSTING BRIGHTNESS OF DISPLAY

The brightness of the display can be adjusted (figures below). The brightness can be selected in the following table.

■ DISPLAY BRIGHTNESS

DISPLAY	FUNCTION	DEFAULT VALUE
	Brightness level 1 (dark)	
	Brightness level 2	
	Brightness level 3 (bright)	

■ ADJUSTMENT IMAGE

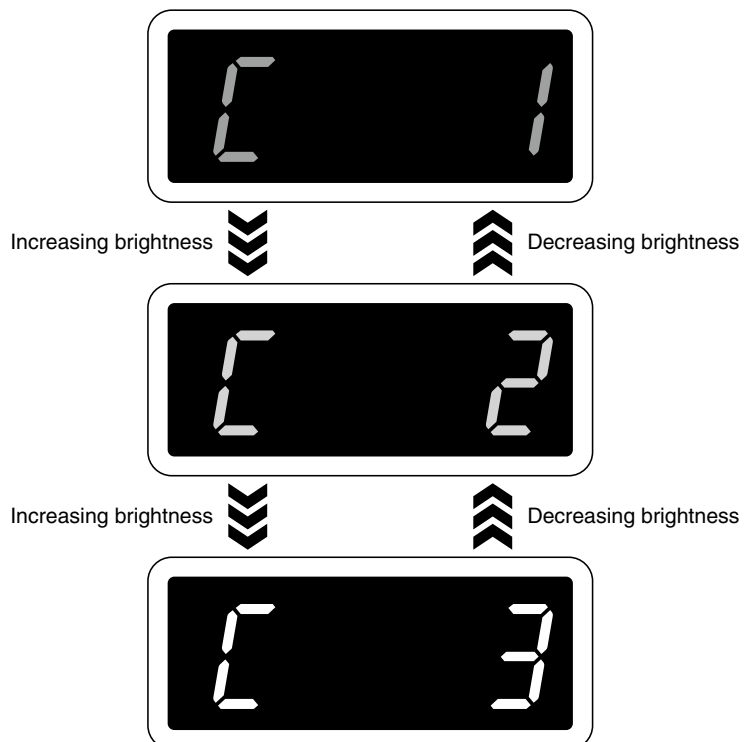

7.1 OPERATING PROCEDURE

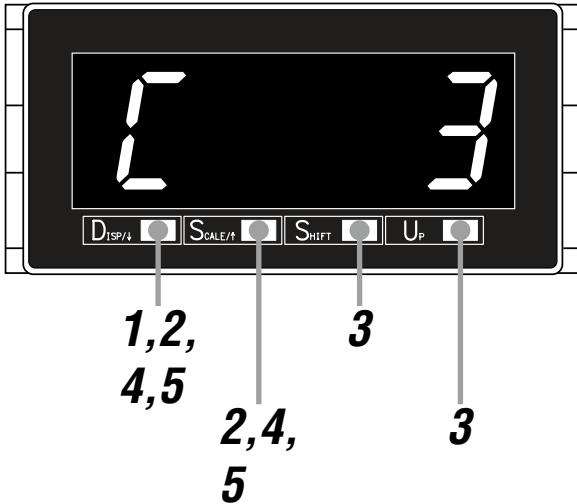

NOTE

The following figures are display examples. The displays depend on the settings.

- 1** Hold down **DISP/↓** button for 3 seconds or more to move on to Display Setting Mode.

- The moving average sampling No. is indicated.



NOTE

'A0FF', 'A 2', 'A 4' or 'A 8' is indicated depending on the setting.

- 2** Press **DISP/↓** or **SCALE/↑** button to go to the brightness setting.

- The brightness is indicated.

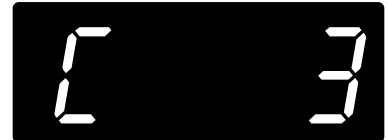

NOTE

'C 1', 'C 2' or 'C 3' is indicated depending on the setting.

- 3** Press **SHIFT** or **UP** button to select.

- Select one among 'C 1', 'C 2' and 'C 3'.



.....

4 Press DISP/↓ or SCALE/↑ button to apply the new setting.

- And the next parameter setting is indicated.

NOTE

- Press DISP/↓ button, and the initialization 'ROFF' will be indicated.
 - Press SCALE/↑ button, and the moving average sampling No. 'AOFF', 'A 2', 'A 4' or 'A 8' will be indicated depending on the setting.
-

.....

5 Hold down DISP/↓ or SCALE/↑ button for 1 second or more to return to Measuring Mode.

8. USER CALIBRATION

The 40DN does not have a function to calibrate (adjust) the input signal. Set the display scaling to compensate the deviation between the desired and actual display values.

Correction value 0% = desired display value 0% – actual display value 0% + desired display value 0%

Correction value 100% = desired display value 100% – actual display value 100% + desired display value 100%

Calculate the display scaling values using the correction values. Refer to 3. SETTING DISPLAY SCALING to set them.

Example 1: setting the display to 0.0 – 100.0% for the input 4 – 20 mA DC. Actual display 0.2 – 99.8%.

Calculate correction value 0 and 100%.

Correction value 0% = 0 – 2 + 0 = -2

Correction value 100% = 1000 – 998 + 1000 = 1002

As the measurement range is the same as the input, set the display scaling as follows:

Display scaling value A = -0002

Display scaling value B = 1002

Example 2: setting the display to 0.0 – 100.0% for the input 6 – 16 mA DC. Actual display 0.2 – 99.8%.

Calculate correction value 0 and 100%.

Correction value 0% = 0 – 2 + 0 = -2

Correction value 100% = 1000 – 998 + 1000 = 1002

As the measurement range is different from the input, calculate the display scaling value A and B. Replace the desired display values and the display span with the correction values and their span.

$$\begin{aligned} SA &= \frac{4 \times 1004 + (-2) \times 16 - 1002 \times 6}{10} \\ &= \frac{4016 - 32 - 6012}{10} = \frac{-2028}{10} = -202.8 \approx -203 \end{aligned}$$

$$\begin{aligned} SB &= \frac{20 \times 1004 + (-2) \times 16 - 1002 \times 6}{10} \\ &= \frac{20080 - 32 - 6012}{10} = \frac{14036}{10} = 1403.6 \approx 1404 \end{aligned}$$

From the above calculations, set the display scaling as follows:

Display scaling value A = -0203

Display scaling value B = 1404

9. INSPECTION / CLEANING

To use the unit in the normal and best conditions, inspect and clean the unit routinely or periodically.

- When the front panel have dirt, wipe them with wet soft cloth. Do not use organic solvent such like benzine, thinner and alcohol. Doing so may result in deformation or discoloration of the unit.
- Make sure that abnormality such like smokes, unusual smell or abnormal noises is not found. Using the unit continuously with such abnormality may result in a fire or electric shock.
- Check the terminal screws periodically. In checking the screws, for safety, interrupt electricity to the input.
- Make sure periodically that the mounting brackets are fixed tightly. Loosened brackets may cause drop of the unit.

10. TROUBLESHOOTING

10.1 ERROR MESSAGES

DISPLAY	ERROR MESSAGE	WHAT TO DO
[SERR] blinking	The input signal is out of the permissible range.	Set the input signal within the permissible range.
[9999] or [-9999] blinking	The value after scaling is out of the permissible display range.	Set the input signal within the permissible range.

■ INPUT AND ERROR CORRELATION

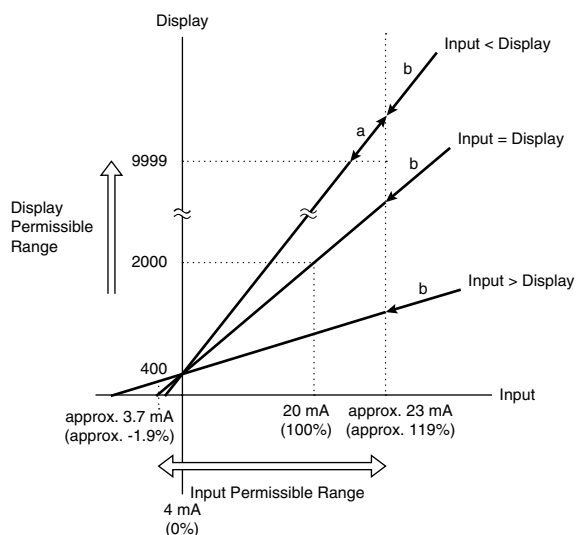

a: 9999 blinking

If the value to display after scaling is out of the permissible range, the maximum (9999) or minimum (-9999) value is blinking.

b: S.ERR blinking

If the input signal is out of the permissible range, the indicator will blink "S.ERR".

10.2 INITIALIZING SETTING VALUES

To restart setting from the default state, initialization can be used. Refer to attached 11.3 PARAMETER LIST for the default values.

IMPORTANT

- Currently set parameters will be lost after an initialization. It is recommended to record the parameters before initialization.
- Even if the unit is shipped with the specified parameters with the option code '/SET', such parameters will be lost after an initialization. Be careful that the initialization does not recover the ex-factory settings.

10.2.1 OPERATING PROCEDURE

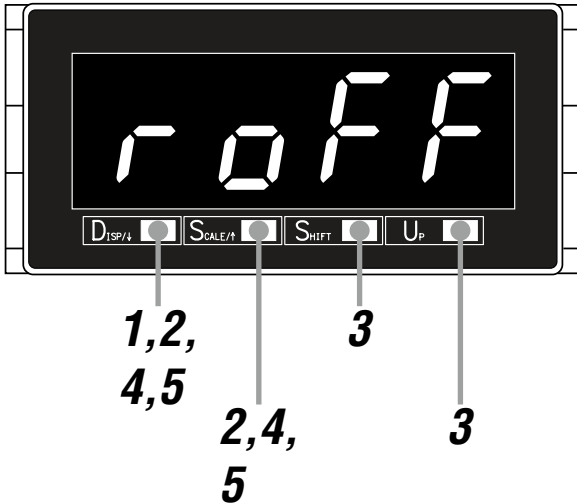

- 1** Hold down DISP/↓ button for 3 seconds or more to move on to Display Setting Mode.

- The moving average sampling No. is indicated.



NOTE

'A OFF'; 'A 2'; 'A 4' or 'A 8' is indicated depending on the setting.

- 2** Press DISP/↓ or SCALE/↑ button to go to the initialization.

- 'ROFF' is indicated.



- 3** Press SHIFT or UP button to select 'REST'.

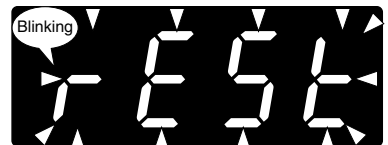

.....

4 Press DISP/↓ or SCALE/↑ button to execute the initialization.

- The settings are initialized and then the next parameter setting is indicated.

NOTE

- Press DISP/↓ button, and the version indication will be indicated.
 - Press SCALE/↑ button, and the brightness 'C 3' will be indicated.
-

.....

5 Hold down DISP/↓ or SCALE/↑ button for 1 second or more to return to Measuring Mode.

10.3 CONFIRMING FIRMWARE VERSION

The firmware version of the unit can be confirmed.

Confirm the version in the following cases:

- The display is different from the one described in the operating manual.
- The firmware version is necessary to consult us for troubles.

10.3.1 OPERATING PROCEDURE

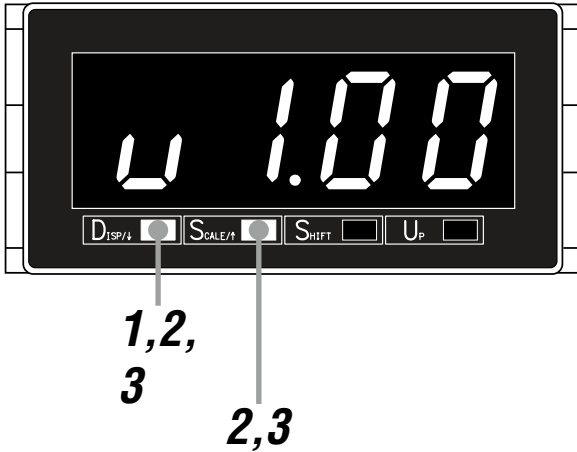

-
- 1** Hold down DISP/↑ button for 3 seconds or more to move on to Display Setting Mode.

- The moving average sampling No. is indicated.



NOTE

'A0FF', 'A 2', 'A 4' or 'A 8' is indicated depending on the setting.

-
- 2** Press DISP/↓ or SCALE/↑ button to go to the version indication.

- The firmware version number is indicated.



NOTE

The displays depend on the firmware version number.

-
- 3** Hold down DISP/↓ or SCALE/↑ button for 1 second or more to return to Measuring Mode.

11. APPENDICES

11.1 SPECIFICATIONS

■ GENERAL SPECIFICATIONS

Construction		Panel flush mounting
Connection		M3 screw terminals (torque 0.6 N·m)
Screw terminal		Nickel-plated steel
Housing material		Flame-resistant resin (gray)
Setting (front button)	Scaling setting mode	Display scaling value A, display scaling value B, decimal point position
	Display setting mode	Moving average, brightness, initialization, version indication
A/D conversion		$\Sigma - \Delta$
Sampling rate		10 times/sec. (100 msec.)
Averaging		None or moving average

■ DISPLAY

Display	4 digits of 20.3 mm (0.8 inch) height, 7-segment, red LED
Display range	-9999 to 9999
Scaling range for measurement range (4 – 20 mA)	-9999 to 9999 counts
Decimal point position	10^{-1} , 10^{-2} , 10^{-3} or none
Zero indication	Higher-digit zeros are suppressed
Over-range indication	'-9999' or '9999' blinking for display values out of the display range. 'S.ERR' blinks surpassing the permissible range.

■ INPUT SPECIFICATIONS

DC current	Measurement range	4 – 20 mA DC
	Current range	Approx. 3.7 to 23 mA DC
	Voltage drop	Approx. 5 V with 4 mA; approx. 5.2 V with 20 mA (Equivalent input impedance: Approx. 260 Ω) (There is voltage drop generated by using the unit. For the two-wire transmitter power supply, make sure that the operable voltage for the two-wire transmitter is ensured including the voltage drop by other devices and wiring resistance.)

■ INSTALLATION

Operating temperature	-10 to +55°C (14 to 131°F)
Operating humidity	30 to 90% RH (non-condensing)
Mounting	Panel flush mounting
Weight	160 g (0.35 lb)

■ PERFORMANCE

Accuracy	$\pm 0.1\% \text{ rdg} \pm 1 \text{ digit}$ "1 digit" is multiplied by scaling-multiple*1. Even in case the scaling-multiple is less than 1, multiply by 1.
Temp. coefficient	$\pm(0.01\% \text{ rdg} + 0.3 \text{ digits})/^\circ\text{C}$ "0.3 digits" is multiplied by scaling-multiple*1. Even in case the scaling-multiple is less than 1, multiply by 1.

*1 Calculate scaling-multiple with the following formula.

Scaling-multiple = $|(\text{display scaling value B} - \text{display scaling value A}) \div (\text{default display scaling value B} - \text{default display scaling value A})|$

■ STANDARDS & APPROVALS

EU conformity	EMC Directive EMI EN 61000-6-4 EMS EN 61000-6-2 RoHS Directive
---------------	---

11.2 MODEL NUMBERING

Code number: **40DN[1]**

INPUT

Current

4 – 20 mA DC

[1] OPTIONS

Blank: None

/Q: With options (specify the specification)

■ SPECIFICATIONS OF OPTION: Q

COATING (For the detail, refer to our web site.)

Moving parts and indicators are not coated.

/C01: Silicone coating

/C02: Polyurethane coating

/C03: Rubber coating

EX-FACTORY SETTING

/SET: Preset according to the Ordering Information Sheet (No. ESU-9534)

11.3 PARAMETER LIST

MODE	PARAMETER	SETTING RANGE	DISPLAY	DEFAULT VALUE	DECIMAL POINT POSITION	UNIT
Measuring	Present value	-9999 – 9999	----	----	*1	User-defined
Scaling setting	Display scaling value A	-9999 – 9999	[9999] to [9999]	[0400]	*1	User-defined
	Display scaling value B	-9999 – 9999	[9999] to [9999]	[2000]	*1	User-defined
	Decimal point position	No decimal point, or 10 ⁻¹ to 10 ⁻³	[.0000], [0.000], [00.00], [000.0]	[.0000]	----	----
Display setting	Moving average	None, 2, 4, 8	[.OFF], [R...2], [R...4], [R...8]	[.OFF]	----	Sample
	Brightness	1 (dark) to 3 (bright)	[C...1], [C...2], [C...3]	[C...3]	----	----
	Initialization	OFF, initialization	[.OFF], [F.F5E]	[.OFF]	----	----
	Version indication	----	----	----	----	----

*1 Conforms to decimal point position setting.

11.4 PARAMETER MAP

11.4.1 SCALING SETTING MODE

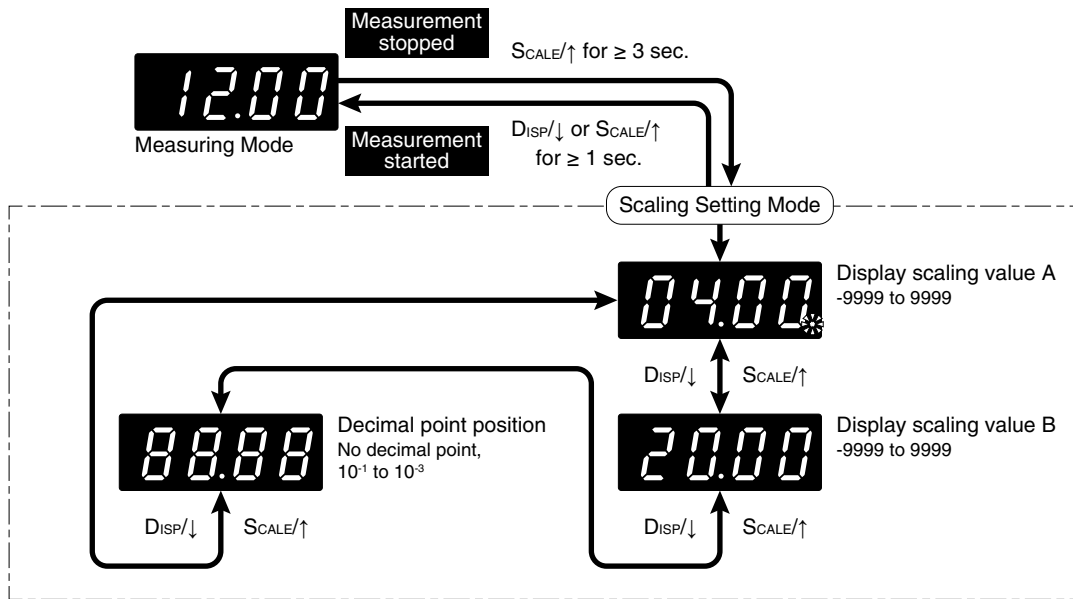

NOTE

The display depends on the settings and input.

11.4.2 DISPLAY SETTING MODE

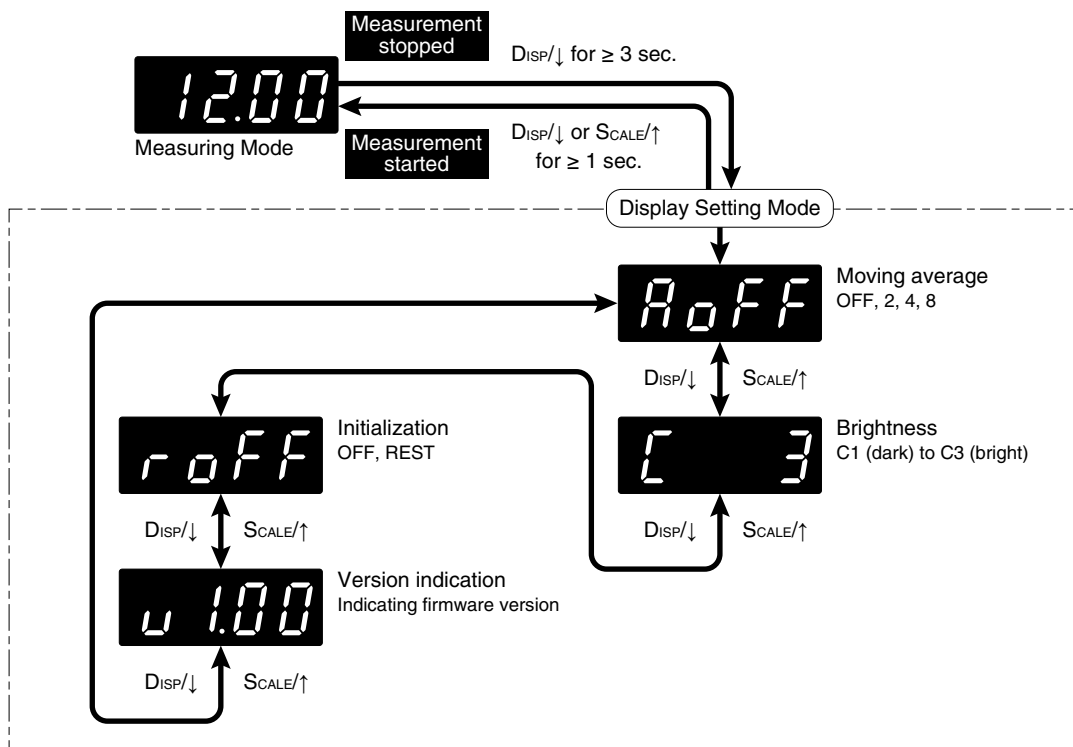









NOTE



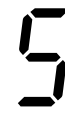

















- The display depends on the settings and input.
- Version indication is for indication only, not for setting.

11.5 CHARACTER SET

■ NUMERALS

0	1	2	3	4	5	6	7	8	9
									

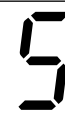
■ ALPHABET

A	B	C	D	E	F	G	H	I	J
									
K	L	M	N	O	P	Q	R	S	T
									
U	V	W	X	Y	Z				
