

Digital Panel Meters 40 Series
AC CURRENT INPUT DIGITAL PANEL METER
(4 digits, process meter, true RMS sensing)

Model: 40DCT

OPERATING MANUAL

CONTENTS

1. INTRODUCTION	4
1.1 BEFORE USE	4
1.2 SAFETY PRECAUTIONS (that must be observed)	5
1.3 POINTS OF CAUTION	7
1.4 COMPONENT IDENTIFICATION	8
1.5 INSTALLATION	10
1.5.1 EXTERNAL DIMENSIONS	10
1.5.2 PANEL CUTOUT DIMENSIONS	10
1.5.3 INSTALLATION	11
1.6 WIRING INSTRUCTIONS	12
1.6.1 CAUTION IN WIRING	12
1.6.2 RECOMMENDED SOLDERLESS TERMINAL	12
1.6.3 TERMINAL ASSIGNMENT	12
1.6.4 WIRING INPUT SIGNAL	13
1.6.5 WIRING HOLD INPUT	14
1.6.6 WIRING POWER	15
1.6.7 ATTACHING/REMOVING TERMINAL COVER	16
2. BASIC SETTING AND OPERATION	17
2.1 BASIC SETTING	17
2.1.1 BASIC SETTING FLOW	17
2.1.2 RELATION BETWEEN INPUT SCALING AND DISPLAY SCALING	17
2.1.3 MOUNTING/REMOVING FRONT PANEL	18
2.1.4 BASIC SETTING PROCEDURE	19
2.2 BASIC SETTING OPERATION AND INSTRUCTIONS	20
2.2.1 BASIC SETTING OPERATION	20
2.2.2 INSTRUCTIONS ON BASIC OPERATION	22
3. SETTING SCALING VALUES	23
3.1 STEP 1. DECIMAL POINT POSITION	25
3.1.1 DECIMAL POINT POSITION LIST	25
3.1.2 OPERATING PROCEDURE	25
3.2 STEP 2. INPUT SCALING VALUE A	27
3.2.1 INPUT SCALING LIST	27
3.2.2 OPERATING PROCEDURE	27
3.3 STEP 3. INPUT SCALING VALUE B	29
3.3.1 OPERATING PROCEDURE	29
3.4 STEP 4. DISPLAY SCALING VALUE A	31
3.4.1 DISPLAY SCALING LIST	31
3.4.2 OPERATING PROCEDURE	31
3.5 STEP 5. DISPLAY SCALING VALUE B	33
3.5.1 OPERATING PROCEDURE	33

4. OPERATION	35
5. PARAMETER CONFIGURATION.....	36
6. AVERAGING INPUT	37
6.1 OPERATING PROCEDURE.....	38
7. ADJUSTING BRIGHTNESS OF DISPLAY	39
7.1 OPERATING PROCEDURE.....	40
8. ELIMINATING FLUCTUATION AROUND “0”	41
8.1 LOW-END CUTOUT	42
8.1.1 OPERATING PROCEDURE	42
8.2 LOW-END CUTOUT VALUE.....	43
8.2.1 OPERATING PROCEDURE.....	43
9. HOLDING DISPLAY	45
10. USER CALIBRATION.....	46
11. INSPECTION / CLEANING.....	47
12. TROUBLESHOOTING	48
12.1 ERROR MESSAGES.....	48
12.2 INITIALIZING SETTING VALUES.....	49
12.2.1 OPERATING PROCEDURE	49
12.3 CONFIRMING FIRMWARE VERSION	51
12.3.1 OPERATING PROCEDURE	51
13. APPENDICES.....	52
13.1 SPECIFICATIONS	52
13.2 MODEL NUMBERING	54
13.3 PARAMETER LIST	55
13.4 PARAMETER MAP	56
13.4.1 SCALING SETTING MODE.....	56
13.4.2 DISPLAY SETTING MODE	57
13.5 CHARACTER SET	58

1. INTRODUCTION

1.1 BEFORE USE....

Thank you for choosing us. Before use, please check contents of the package you received as outlined below.

■ PACKAGE INCLUDES

Digital panel meter

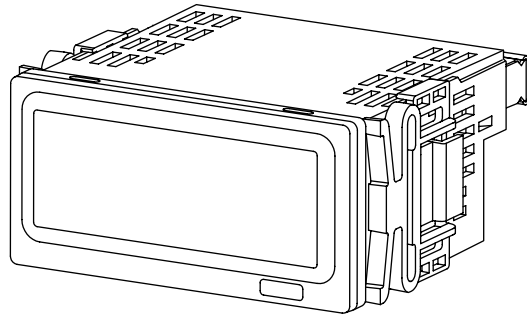

Accessories

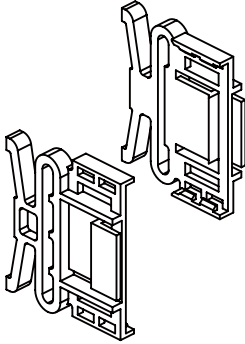
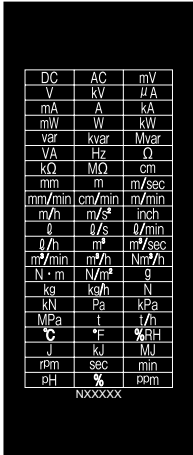
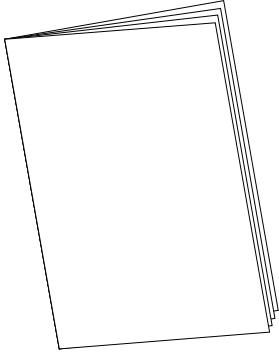
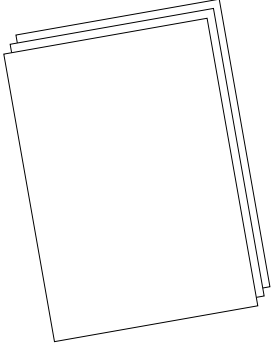
<p>Mounting bracket (2)</p> 	<p>Engineering unit sticker label sheet (1)</p>  <table border="1" data-bbox="722 972 871 1294"> <tbody> <tr><td>DC</td><td>AC</td><td>mV</td></tr> <tr><td>V</td><td>kV</td><td>μA</td></tr> <tr><td>mA</td><td>A</td><td>KA</td></tr> <tr><td>mW</td><td>W</td><td>KW</td></tr> <tr><td>var</td><td>kvar</td><td>Mvar</td></tr> <tr><td>VA</td><td>Hz</td><td>Ω</td></tr> <tr><td>kΩ</td><td>MΩ</td><td>cm</td></tr> <tr><td>mm</td><td>m</td><td>m/sec</td></tr> <tr><td>mm/min</td><td>cm/min</td><td>m/min</td></tr> <tr><td>m/h</td><td>m/s²</td><td>inch</td></tr> <tr><td>l</td><td>l/s</td><td>l/min</td></tr> <tr><td>l/h</td><td>m³</td><td>m³/sec</td></tr> <tr><td>m³/min</td><td>m³/h</td><td>Nm³/h</td></tr> <tr><td>N · m</td><td>N/m²</td><td>g</td></tr> <tr><td>kg</td><td>kg/h</td><td>N</td></tr> <tr><td>kN</td><td>Pa</td><td>kPa</td></tr> <tr><td>MPa</td><td>t</td><td>t/h</td></tr> <tr><td>°C</td><td>°F</td><td>%RH</td></tr> <tr><td>J</td><td>kJ</td><td>MJ</td></tr> <tr><td>rpm</td><td>sec</td><td>min</td></tr> <tr><td>pH</td><td>%</td><td>ppm</td></tr> <tr><td colspan="3">NXXXXX</td></tr> </tbody> </table>	DC	AC	mV	V	kV	μA	mA	A	KA	mW	W	KW	var	kvar	Mvar	VA	Hz	Ω	kΩ	MΩ	cm	mm	m	m/sec	mm/min	cm/min	m/min	m/h	m/s ²	inch	l	l/s	l/min	l/h	m ³	m ³ /sec	m ³ /min	m ³ /h	Nm ³ /h	N · m	N/m ²	g	kg	kg/h	N	kN	Pa	kPa	MPa	t	t/h	°C	°F	%RH	J	kJ	MJ	rpm	sec	min	pH	%	ppm	NXXXXX			<p>Instruction manual</p> 
DC	AC	mV																																																																		
V	kV	μA																																																																		
mA	A	KA																																																																		
mW	W	KW																																																																		
var	kvar	Mvar																																																																		
VA	Hz	Ω																																																																		
kΩ	MΩ	cm																																																																		
mm	m	m/sec																																																																		
mm/min	cm/min	m/min																																																																		
m/h	m/s ²	inch																																																																		
l	l/s	l/min																																																																		
l/h	m ³	m ³ /sec																																																																		
m ³ /min	m ³ /h	Nm ³ /h																																																																		
N · m	N/m ²	g																																																																		
kg	kg/h	N																																																																		
kN	Pa	kPa																																																																		
MPa	t	t/h																																																																		
°C	°F	%RH																																																																		
J	kJ	MJ																																																																		
rpm	sec	min																																																																		
pH	%	ppm																																																																		
NXXXXX																																																																				
<p>Ordering Information Sheet</p>  <p>(included with the option code 'SET' only)</p>																																																																				





■ MODEL NO.

Confirm Model No. marking on the product to be exactly what you ordered.

1.2 SAFETY PRECAUTIONS (that must be observed)

The following signs are used in this manual to provide precautions required to ensure safe usage of the unit. Please understand these signs and graphic symbols, read the manual carefully and observe the description.

The following signs show seriousness of safety hazard or damage occurred when used wrongly with the signs ignored.

 WARNING	Indicates a potentially hazardous situation which, if not avoided, may result in serious injury or death.	
 CAUTION	Indicates a potentially hazardous situation which, if not avoided, may result in injury or in property damage.	
 Indicates prohibitions.	 Indicates mandatory cautions.	 Indicates cautions.

WARNING



For safety, make sure that wiring is performed by qualified personnel only.

- Failure to do so may result in a fire, electric shock or injury.



Do not touch the terminals while the power is on.

- Doing so may result in electric shock.



Do not touch anything except for the buttons in removing the front panel.

- Doing so may result in malfunction or electric shock.



Check the connection diagram carefully before wire connection.

- Failure to do so may result in malfunction, a fire or electric shock.



Provide safety measures outside of the unit to ensure safety in the whole system if an abnormality occurs due to malfunction of the unit or another external factor affecting the unit's operation.



Do not splash water on the unit.

- Doing so may result in a fire, electric shock or injury.



Stop using the unit immediately if smokes, unusual smell or abnormal noises come(s) from it.

- Using the unit continuously may result in a fire or electric shock.



MANDATORY
CAUTION

Stop using the unit if it is dropped or damaged.
• Using the unit continuously may result in a fire or electric shock.



MANDATORY
CAUTION

Tighten the terminal block with a specified torque.
• Excessive fastening may result in damage of the terminal screws and loose screws may occasionally result in ignition.



PROHIBITION

Do not throw the unit into the fire.
• Doing so may result in rupture of the electronic component.

CAUTION



PROHIBITION
TO DISCOMPOSE

Never discompose or remodel the unit.
• Doing so may result in electric shock, malfunction or injury.



PROHIBITION

Do not connect or remove the unit while its power is on.
• Doing so may result in electric shock, malfunction or injury.



MANDATORY
CAUTION

Do not allow fine shavings or wire scraps to enter the unit in machining screws or wiring.
• Doing so may result in malfunction of the unit.



MANDATORY
CAUTION

Make sure to attach the terminal cover.
• Failure to do so may result in electric shock.



MANDATORY
CAUTION

Do not remove the front panel except in setting parameters.
• Doing so may result in malfunction due to mixing of foreign substances.



MANDATORY
CAUTION

Be aware of static electricity in operating buttons.
• Failure to do so may result in malfunction.



PROHIBITION

Do not pull the wires connecting to the unit.
• Doing so may result in electric shock, damage of the unit or injury.



PROHIBITION

Do not use the unit in an atmosphere where combustible gas is present.
• Doing so may result in inflammation, ignition, or smoke.



PROHIBITION

Do not cover the ventilation slits with cables, etc.
• Doing so may result in malfunction or heating.

1.3 POINTS OF CAUTION

■ CONFORMITY WITH EU DIRECTIVES

- This equipment is suitable for Pollution Degree 2, Measurement Category I (input, transient voltage 1500 V) and Installation Category II (transient voltage 2500 V). Reinforced insulation (input to power: 300 V) is maintained. Prior to installation, check that the insulation class of this unit satisfies the system requirements.
- The equipment must be installed such that appropriate clearance and creepage distances are maintained to conform to CE requirements. Failure to observe these requirements may invalidate the CE conformance.
- Our products conforming to the EU Directives conform to the standards required based on the premise that they are built into various equipment, apparatus or control panels to use. Because the EMC performance depends on the configuration, wiring or arrangement of the equipment, apparatus and control panels you build, it is necessary for you to make such equipment, apparatus or control panels to conform finally to the CE Marking by yourselves.

CAUTION

This product conforms to the EMC Directive for electrical and electronic apparatus intended for use in industrial environments. If it is used in the residential environments, it may cause radio interference, and the user is requested to take appropriate measures.

■ ENVIRONMENT

Install the unit within the installation specifications.

- Indoors use.
- Environmental temperature must be within -10 to +55°C (14 to 131°F) with relative humidity within 30 to 90% RH without condensing.
- Altitude up to 2000 meters.
- Provide sufficient space around the unit for heat dissipation.
- Mount the unit to a panel between 1.6 and 8 mm thick.
- Install the unit in a well-ventilated place in order to prevent internal temperature rise.
- Refer to "PANEL CUTOOUT" to install several units. In mounting the unit with other equipment side by side, provide sufficient space between them, according to the dimensions in the panel cutout.
- Do not use the unit under the following environments:
 - Where the unit is exposed to direct sunlight, rain or wind. (The unit is not designed for outdoor use.)
 - Where condensation may occur due to extreme temperature changes.
 - Where corrosive or flammable gas is present.
 - Where heavy dust, iron powder or salt is present in the air.
 - Where organic solvent such like benzene, thinner, and alcohol, or strong alkaline materials such like ammonia and caustic soda may attach to the unit, or where such materials are present in the air.
 - Where the unit is subject to continuous vibration or physical impact.
 - Where there are high-voltage lines, high-voltage equipment, power lines, power equipment, equipment with transmission unit such like a ham radio equipment, or equipment generating large switching surges around the unit.

■ WIRING

- In order to prevent potential electric shock, wire the unit after turning off the power supply and making sure that the power is not supplied to the cable.
- In order to enable the operator to turn off the power input immediately, install a switch or a circuit breaker according to the relevant requirements in IEC 60947-2 and properly indicate it.
- Be sure to confirm the name and polarity of each terminal before wiring to the terminal block.
- Do not connect anything to unused terminals.
- Be sure to attach the terminal cover to prevent electric shock.

■ HANDLING CAUTIONS

- The unit is designed to function as soon as power is supplied, however, a warm up for 10 minutes is required for satisfying complete performance described in the data sheet.
- Use the unit within the noted supply power voltage and rated load.
- Clean the surface of the unit with wet soft cloth. Do not use organic solvent such like benzene, thinner and alcohol. Doing so may result in deformation or discoloration of the unit.
- When abnormality is found such like smokes, unusual smell and abnormal noises coming from the unit, immediately cut the power supply and stop using it.

1.4 COMPONENT IDENTIFICATION

■ FRONT VIEW

• With Front Panel

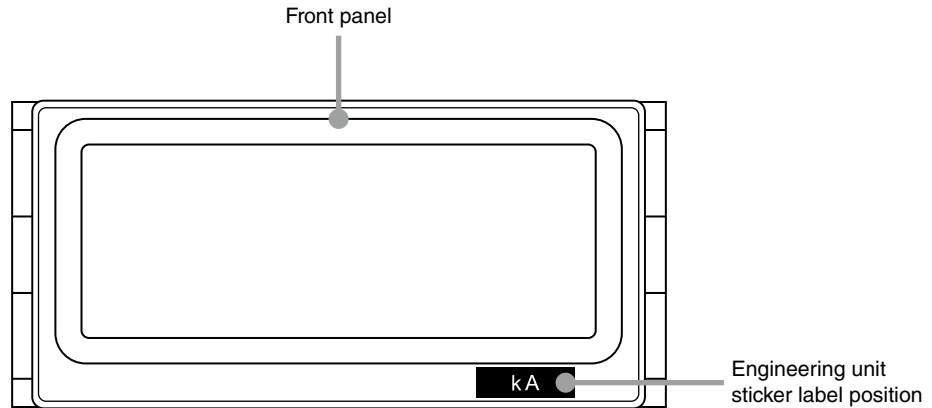

NOTE

- The engineering unit sticker label position is our recommended position.
- When an engineering unit is specified by the Ordering Information Sheet, the unit(s) will be shipped with the sticker label put on the above position.

• Without Front Panel

COMPONENT	FUNCTION	COMPONENT	FUNCTION
Polarity indicator	Turns on when negative value is displayed.	4-digit display	Indicates present value, setting value and scaling error. Range: 0 to 9999

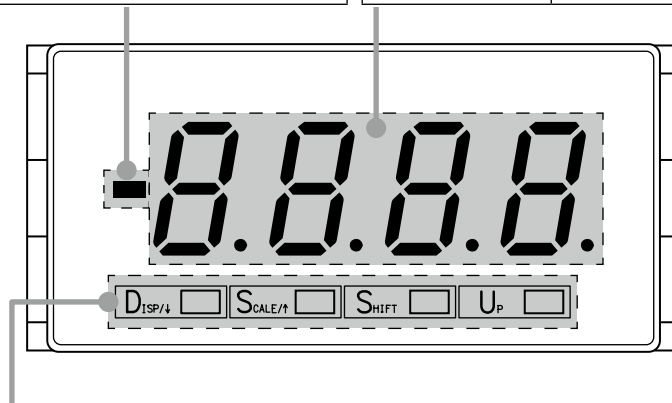

BUTTON	FUNCTION
DISP/↓	Used to move on to the display setting mode, to shift through setting items in each setting mode, or shift through display digits in each setting item.
SCALE/↑	Used to move on to the scaling setting mode, to shift through setting items in each setting mode, or shift through display digits in each setting item.
SHIFT	Used to move on to the setting standby status.
UP	Used to change setting values in a setting standby mode.

■ TOP VIEW

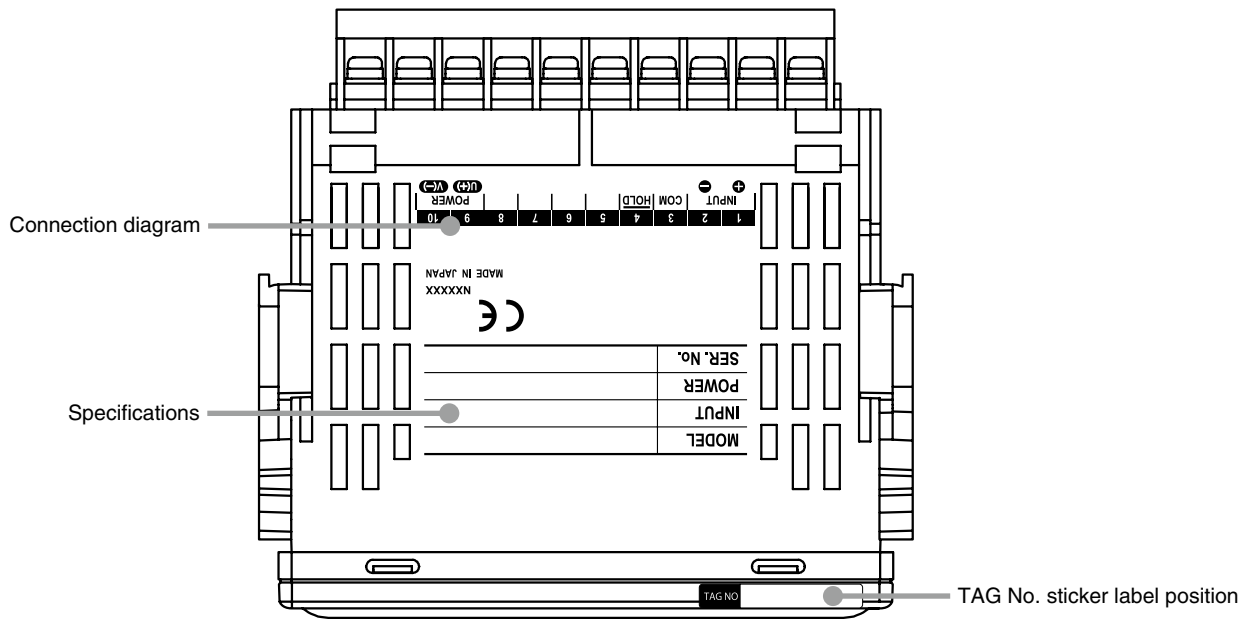

NOTE

- Contents of the specification label depend on the specifications.
- The tag No. label sticker position is our recommended position.
- When a tag No. is specified, the unit(s) will be shipped with the tag No. sticker label put on the above position. Max. 17 alphanumeric characters can be specified. Please consult us.

1.5 INSTALLATION

1.5.1 EXTERNAL DIMENSIONS

unit: mm (inch)

■ TOP VIEW

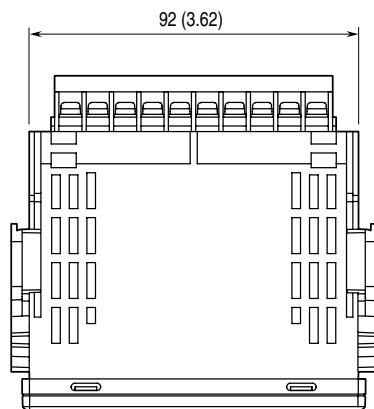

■ FRONT VIEW

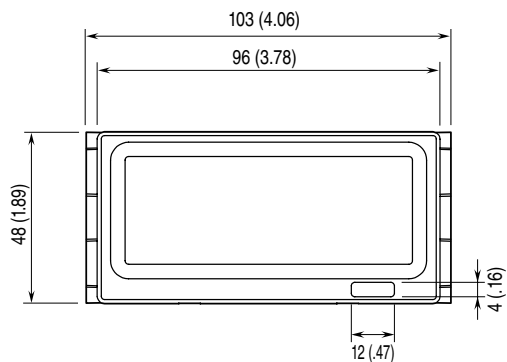

■ SIDE VIEW

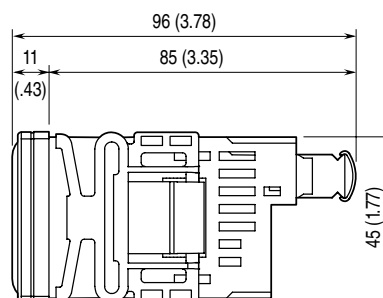

■ REAR VIEW

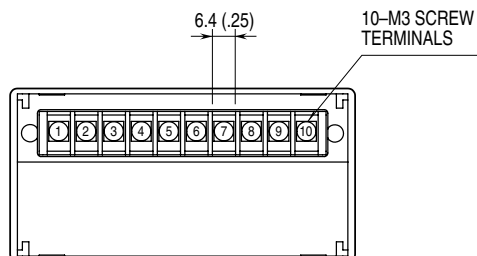

1.5.2 PANEL CUTOUT DIMENSIONS

unit: mm

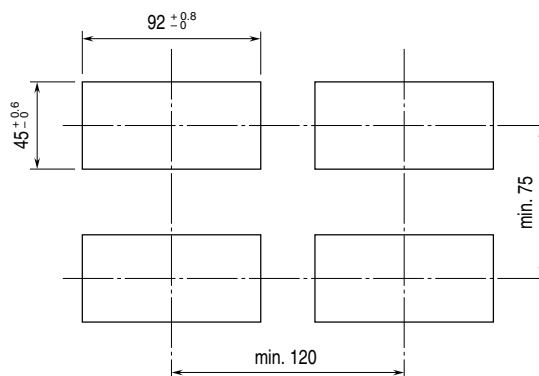

Panel thickness: 1.6 to 8.0 mm

1.5.3 INSTALLATION

- (1) Remove the mounting brackets.
 - (a) Flip a tab of a bracket.
 - (b) Then pull the bracket toward the terminal block to remove it.

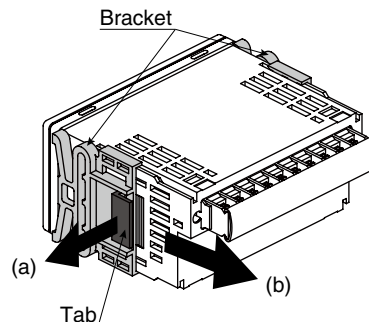

- (2) Insert the unit into the panel cutout.

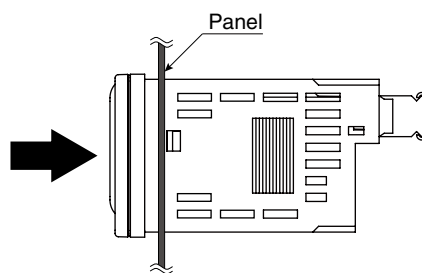

- (3) Push the mounting brackets into the grooves on both sides of the rear module, until they hit the panel's rear side.

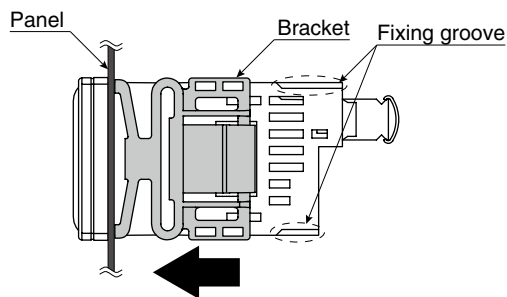

1.6 WIRING INSTRUCTIONS

1.6.1 CAUTION IN WIRING

- For safety, make sure that wiring is performed by qualified personnel only.
- In order to prevent potential electric shock, wire the unit after turning off the power supply and making sure that the power is not supplied to the cable.
- Be sure to confirm the name and polarity of each terminal before wiring to it.
- Do not connect anything to unused terminals.
- We offer a series of lightning surge protectors for protection against induced lightning surges. Please contact us to choose appropriate models.

1.6.2 RECOMMENDED SOLDERLESS TERMINAL

- Use solderless terminals for M3. Refer to the drawings below.

unit: mm (inch)

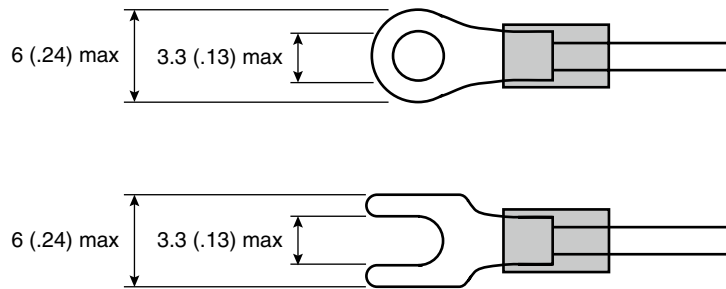

Applicable wire size: 0.25 to 1.65 mm²

Torque: 0.6 N·m

Recommended manufacturer: Japan Solderless Terminal MFG. Co., Ltd., Nichifu Co., Ltd.

IMPORTANT

- Insulated solderless terminals are recommended.
- In using non-insulated solderless terminals, cover them with insulating caps or tubes.
- Ring tongue terminals are recommended rather than spade tongue terminals to prevent from falling off.

1.6.3 TERMINAL ASSIGNMENT

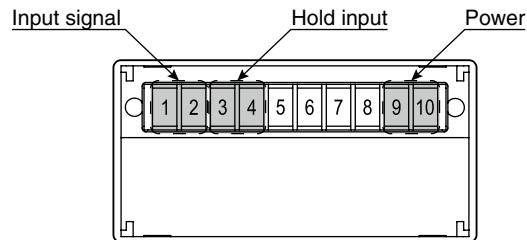

1.6.4 WIRING INPUT SIGNAL

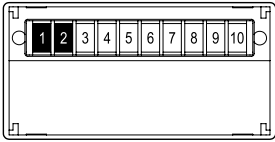

Connect AC current signal wires.

IMPORTANT

- Prepare a current transformer (CT) or a clamp type current sensor.
- When the input current is 5 A or less, direct input is available without using a CT.
- With direct input without a CT, do not ground the input circuit.
- With a low-voltage circuit, grounding the CT secondary is not necessary.
- While current is in the CT primary, opening circuit at the secondary produces a high voltage at the secondary and may cause a breakdown or a burnout accident. Do not open circuit at the secondary.
- The input frequency must be 40 to 100 Hz for the input codes 'A1', 'A2' and 'A3', and 45 to 65 Hz for 'A4' and 'A5'.
- The input waveform must be up to 15% of 3rd harmonic content.
- For safety, make sure that wiring is performed by qualified personnel only.
- In order to prevent potential electric shock, wire the unit after cutting the input signal and making sure that the power is not supplied to the cable.
- Use wires as thick as possible.
- Ground with the resistance 100 Ω or less.
- Do not connect anything to unused terminals.

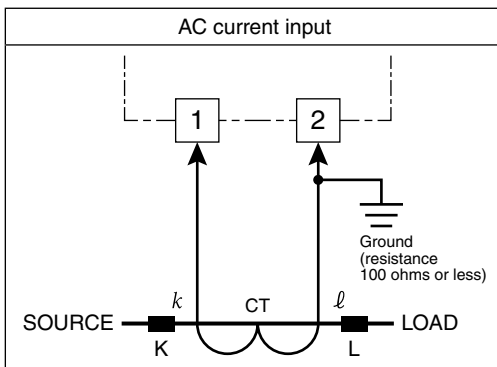

1.6.5 WIRING HOLD INPUT

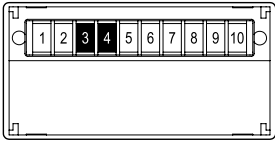

Displayed value is held with an external HOLD command input.
 Connect the contact across $\overline{\text{HOLD}}$ to COM as shown in the following figure.
 Close the contact to hold the value.

Detecting voltage	Approx. 5 V DC, 1 mA
Detecting level	≤ 1.5 V

IMPORTANT

- Be sure to confirm the input polarity in wiring.
- Isolate with a photo-coupler or a relay as the HOLD input is not isolated to the AC input signal.

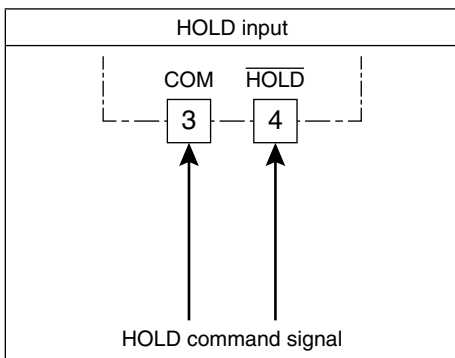

■ WIRING EXAMPLES

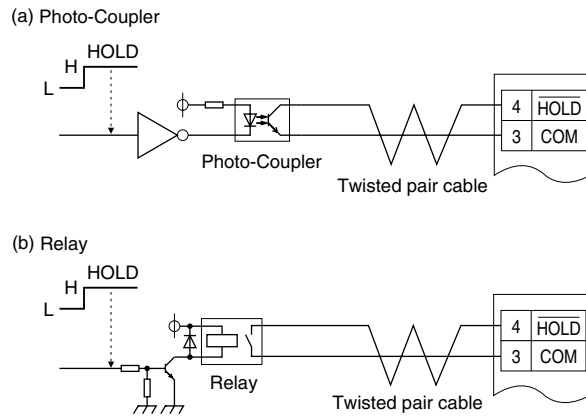

1.6.6 WIRING POWER

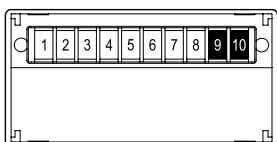

Connect power according to the power input code. The power specifications are shown in the following table.

CODE	RATING	PERMISSIBLE RANGE
K3	100 to 120 V AC	85 to 132 V AC, 47 – 66 Hz approx. 3.0 VA
L3	200 to 240 V AC	170 to 264 V AC, 47 – 66 Hz approx. 4.2 VA
R	24 V DC	±20% approx. 1.0 W

IMPORTANT

- For safety, make sure that wiring is performed by qualified personnel only.
- In order to prevent potential electric shock, wire the unit after turning off the power supply and making sure that the power is not supplied to the cable.
- Use wires as thick as possible and twist them from the end.
- For DC power, confirm the polarity.

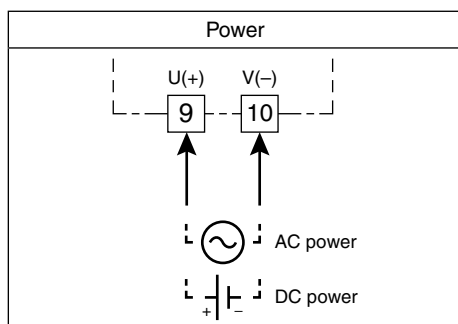

1.6.7 ATTACHING/REMOVING TERMINAL COVER

Attach the terminal cover for safety after wiring.

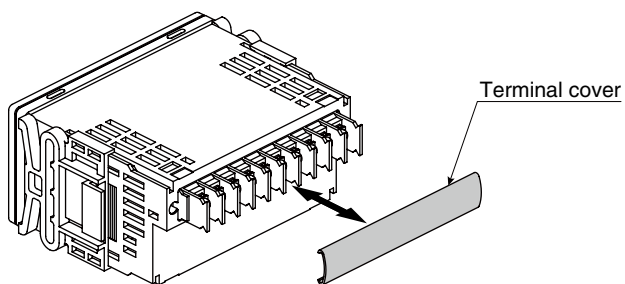

2. BASIC SETTING AND OPERATION

2.1 BASIC SETTING

This section describes flow and procedure of the basic setting.

The following shows the flow and procedure to set the CT secondary to 0 – 1 A AC and the CT primary to 0.0 – 300.0 A AC with the input code 'A4' as an example.

2.1.1 BASIC SETTING FLOW

The basic setting is as shown in the following flowchart.

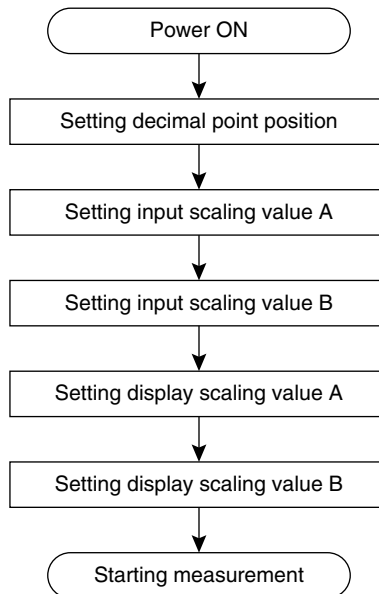

2.1.2 RELATION BETWEEN INPUT SCALING AND DISPLAY SCALING

The relation between input scaling and display scaling is as shown in the following figure and chart.

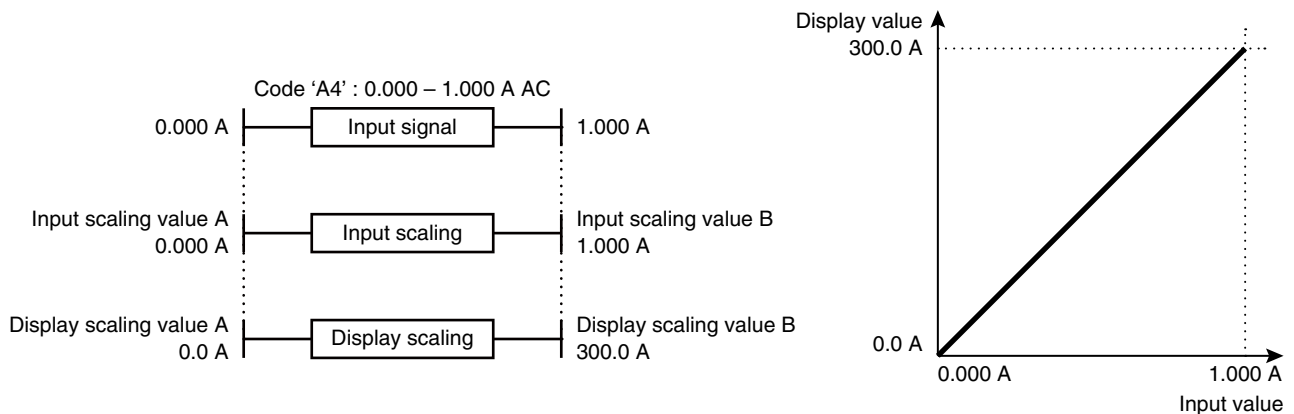

Input scaling: 0% input value (input scaling value A) and 100% input value (input scaling value B)

Display scaling: 0% display value (display scaling value A) and 100% display value (display scaling value B)

2.1.3 MOUNTING/REMOVING FRONT PANEL

- Set parameters with the buttons inside the front panel. Remove the panel in setting.
- Mount the panel after configuration.

■ REMOVING FRONT PANEL

(1) Hold up the front panel.

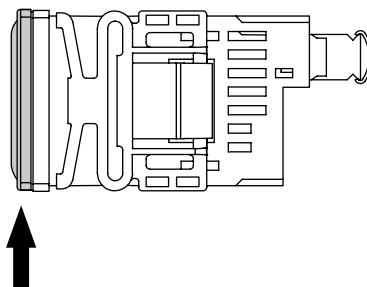

(2) Remove the panel from downside.

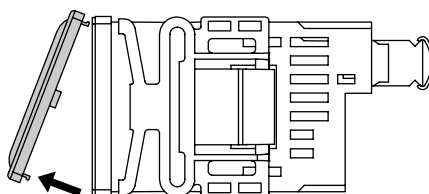

■ MOUNTING FRONT PANEL

(1) Insert the front panel hook into the case upside slots of the unit.

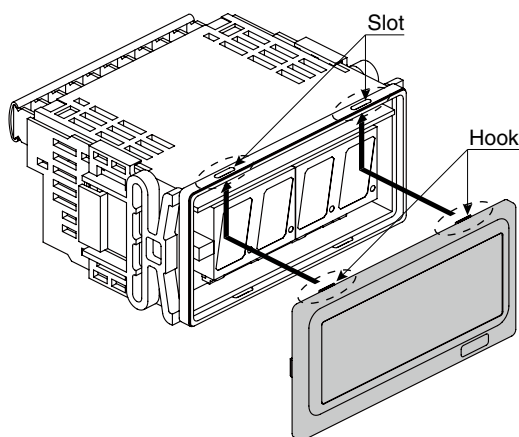

(2) Push the panel hook into the case downside slots of the unit.

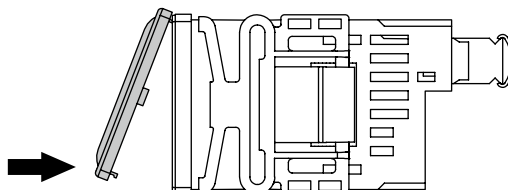

NOTE

- Be sure to confirm the direction of the front panel in mounting.
- Make sure that there is no misalignment or space between the unit and the panel after mounting.

2.1.4 BASIC SETTING PROCEDURE

The following shows the procedure to set the CT secondary to 0 – 1 A AC and the CT primary to 0.0 – 300.0 A AC as an example. Set values meeting signals to use. Refer to 3. SETTING SCALING VALUES for details of setting.

■ PARAMETER LIST FOR BASIC SETTING

Parameters used in the basic setting are as shown in the following table.

PARAMETER	SETTING VALUE	SETTING
Decimal point position	888.8	1 decimal place (10 ⁻¹)
Input scaling value A	0.000	0% input: 0.000 A
Input scaling value B	1.000	100% input: 1.000 A
Display scaling value A	000.0	0% display: 0.0 A
Display scaling value B	300.0	100% display: 300.0 A

■ BASIC SETTING PROCEDURE

The basic setting procedure is as follows.

1 Confirm the wiring, turn on the power and move on to Scaling Setting Mode (measurement stopped).

- Hold down SCALE/↑ button for 3 seconds or more.

2 Set decimal point position.

- Press SHIFT button to shift the display into the setting standby mode and UP button to select the decimal point position.
- Press SHIFT button to apply the new setting.

3 Set input scaling value A.

- Press DISP/↓ or SCALE/↑ button to go to the next or previous parameter setting.
- Press SHIFT button to show the current setting and SCALE/↑ button to shift the display into the setting standby mode.
- Press DISP/↓ or SCALE/↑ button to go to the next digit and UP button to change the blinking value.
- Press SHIFT button to apply the new setting.

4 Set input scaling value B.

- Press DISP/↓ or SCALE/↑ button to go to the next or previous parameter setting.
- Press SHIFT button to show the current setting and SCALE/↑ button to shift the display into the setting standby mode.
- Press DISP/↓ or SCALE/↑ button to go to the next digit and UP button to change the blinking value.
- Press SHIFT button to apply the new setting.

5 Set display scaling value A.

- Press DISP/↓ or SCALE/↑ button to go to the next or previous parameter setting.
- Press SHIFT button to show the current setting and SCALE/↑ button to shift the display into the setting standby mode.
- Press DISP/↓ or SCALE/↑ button to go to the next digit and UP button to change the blinking value.
- Press SHIFT button to apply the new setting.

6 Set display scaling value B.

- Press DISP/↓ or SCALE/↑ button to go to the next or previous parameter setting.
- Press SHIFT button to show the current setting and SCALE/↑ button to shift the display into the setting standby mode.
- Press DISP/↓ or SCALE/↑ button to go to the next digit and UP button to change the blinking value.
- Press SHIFT button to apply the new setting.

7 Return to Measuring Mode (measurement started).

- Hold down DISP/↓ or SCALE/↑ button for 1 second or more to return to Measuring Mode.

2.2 BASIC SETTING OPERATION AND INSTRUCTIONS

This section describes basic operation and instructions when setting parameters.

2.2.1 BASIC SETTING OPERATION

Parameters can be grouped into three setting types, "setting value selection", "decimal point position selection" and "numerical value setting". Basic operation of each type is as shown below.

■ SETTING VALUE SELECTION

1 Press **SHIFT** button to show the setting.

- The current set value is indicated.



2 Press **UP** button to select your desired setting value.

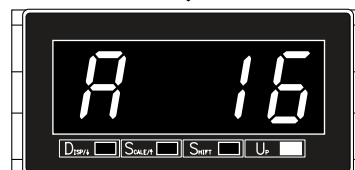

3 Press **SHIFT** button to apply the new setting.

- The setting item is indicated.



*1 Display depends on the settings.

■ DECIMAL POINT POSITION SELECTION

1 Press **SHIFT** button to show the setting.

- The current set value is indicated.



2 Press **UP** button to select a desired decimal point position.



3 Press **SHIFT** button to apply the new setting.

- The setting item is indicated.



*1 Display depends on the settings.

NOTE

MOVING THE DECIMAL POINT

Pressing UP button moves the decimal point one place to the left.

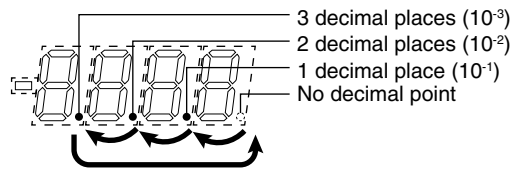

DECIMAL POINT POSITION

“No decimal point” to “3 decimal places” can be selected in the decimal point position setting.

SETTING VALUE	FUNCTION	SETTING VALUE	FUNCTION
0000	No decimal point	0000	2 decimal places (10^{-2})
0000	1 decimal place (10^{-1})	0000	3 decimal places (10^{-3})

NUMERICAL VALUE SETTING

1 Press SHIFT button to show the setting.

- The current set value is indicated.



2 Press SCALE/↑ button to shift the display into the setting standby mode.

- The most significant digit starts blinking.

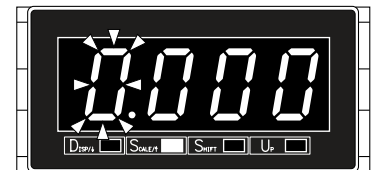

3 Press DISP/↓ or SCALE/↑, and UP buttons to set a numerical value.

- Press DISP/↓ or SCALE/↑ button to go to the next digit.
- Press UP button to change the blinking value.



4 Press SHIFT button to apply the new setting.

- The setting item is indicated.

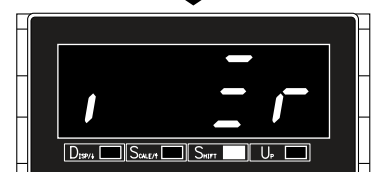

*1 Display depends on the settings.

NOTE

■ SHIFTING DIGITS

- Each time pressing $SCALE/\uparrow$ button, the blinking digit moves to the right.



- Each time pressing $DISP/\downarrow$ button, the blinking digit moves to the left.

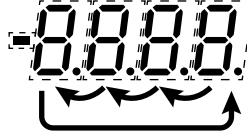

■ SETTING A NUMERICAL VALUE

- Each time pressing UP button, the numeral is incremented by 1.
- The negative sign (-) must be set together with the 4th digit. For example, set '-004.0' instead of '-4.0'.

- 4th digit

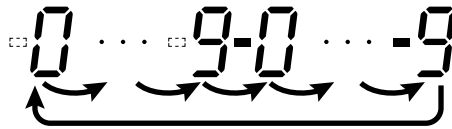

- Other digits

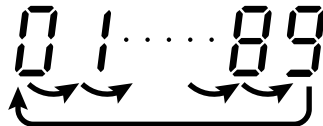

2.2.2 INSTRUCTIONS ON BASIC OPERATION

■ IF THE FRONT BUTTONS ARE LEFT UNTOUCHED...

- The setting item is indicated without applying the last changes after approximately 1 minute while it is in the setting standby mode.
- The setting item is indicated after approximately 1 minute while the set value is indicated in setting a numerical value.
- The display goes back automatically to Measuring Mode after approximately 1 minute while the setting item is indicated.

■ TO ABORT A SETTING...

- If you get lost in a setting mode, you can execute initialization. Refer to 12.2 INITIALIZING SETTING VALUES.

3. SETTING SCALING VALUES

■ INPUT SCALING

Input scaling means setting an input value within the setting range (conformance range) per input code.
The input scaling values include A and B.

- Input scaling value A is minimum value (0%) of input signal.
- Input scaling value B is maximum value (100%) of input signal.

e.g. Input signal 0 – 1 A AC
Input scaling value A 0 A
Input scaling value B 1 A

IMPORTANT

- Set 'input scaling value A < input scaling value B'.
- Setting beyond the setting range per input code is not available.

■ DISPLAY SCALING

Display scaling means setting a value to display actually.
The display scaling values include A and B. A decimal point can be set in any position.

- Display scaling value A is a display value for the input scaling value A.
- Display scaling value B is a display value for the input scaling value B.
- Decimal point position can be set in common for both display scaling value A and B.

e.g. Display value 0.0 – 300.0 A
Display scaling value A 0.0 A
Display scaling value B 300.0 A
Decimal point position 888.8 (1 decimal place)

IMPORTANT

Both normal scaling (display scaling value A < display scaling value B) and inverted scaling (display scaling value A > display scaling value B) can be set within the range of -9999 to 9999.

■ Normal Scaling

The display value increases when the input signal increases.

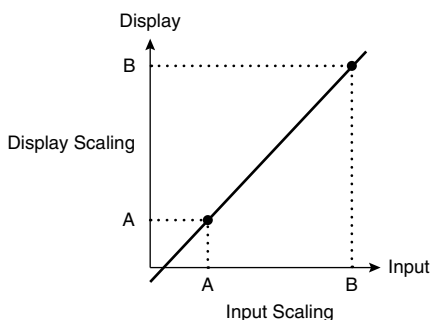

■ Inverted Scaling

The display value decreases when the input signal increases.

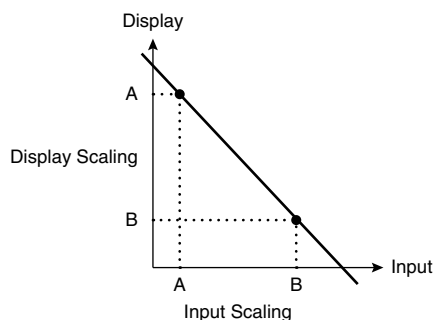

RELATION BETWEEN INPUT SCALING AND DISPLAY SCALING

The relation between input scaling and display scaling is as shown in the following figure.

e.g. CT secondary 0 – 1 A AC, CT primary 0.0 – 300.0 A AC

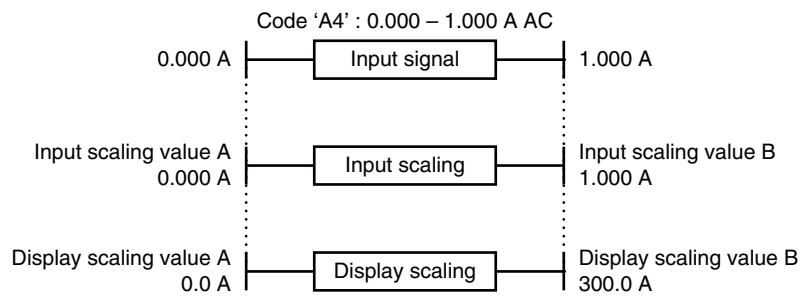

PROCEDURE TO SET SCALING VALUES

• Flow in setting scaling values

5-step settings are necessary to set scaling values.

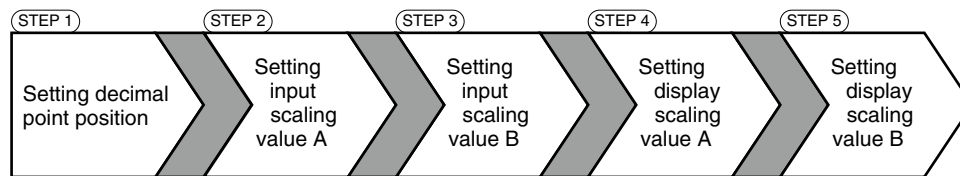

• Operating procedure to set scaling values

Following pages describe operating procedures in each step to set the input scaling to 0 – 1 A AC, and the display scaling to 0.0 – 300.0 A AC as an example.

3.1 STEP 1. DECIMAL POINT POSITION

3.1.1 DECIMAL POINT POSITION LIST

Default values of decimal point position are as shown in the following tables.

INPUT SIGNAL	DEFAULT VALUE
A1: 0.00 – 20.00 mA AC	00.00: 2 decimal places (10^{-2})
A2: 0.0 – 200.0 mA AC	000.0: 1 decimal place (10^{-1})
A3: 0.000 – 2.000 A AC	0.000: 3 decimal places (10^{-3})
A4: 0.000 – 1.000 A AC	0.000: 3 decimal places (10^{-3})
A5: 0.000 – 5.000 A AC	0.000: 3 decimal places (10^{-3})

3.1.2 OPERATING PROCEDURE

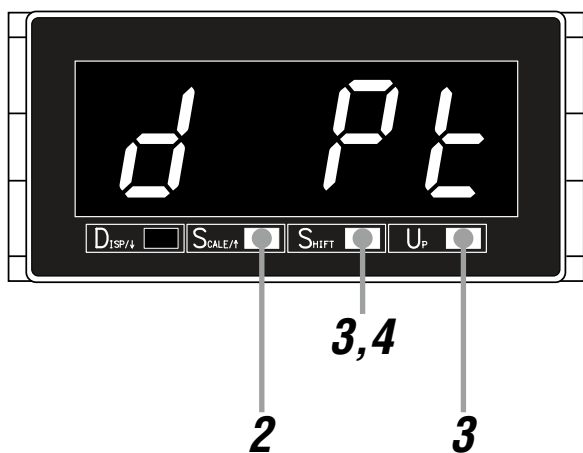

1 Confirm the wiring, and turn on the power.

- All the indications turn on for approximately 3 seconds and then the display moves on to Measuring Mode.

NOTE

Indication 'S.ERR' may blink, which shows the input out of the permissible range and does not show the unit failure.

- Immediately after power on (all indicators on)



- Measuring Mode



*1 Display depends on the settings and input.

2 Hold down **SCALE/↑** button for 3 seconds or more to move on to **Scaling Setting Mode**.

- The setting item 'D PT' (decimal point position) is indicated.



NOTE

Skip to Step 5 if the default value is acceptable.

3 Press **SHIFT** button to show the setting and **UP** button to select the decimal point position.

- Press **UP** button to move the decimal point. Select 1 decimal place (10^{-1}).



NOTE

The right figure shows a display example. Select one among "no decimal point," and "1 decimal place" to "3 decimal places."

4 Press **SHIFT** button to apply the new setting.

- And the setting item is indicated.



5 ■ **TO GO ON TO SET THE INPUT SCALING VALUE A,**
Skip to Step 3 in "3.2 STEP 2. INPUT SCALING VALUE A"

■ **TO QUIT,**

Hold down **DISP/↓** or **SCALE/↑** button for 1 second or more to return to Measuring Mode.

3.2 STEP 2. INPUT SCALING VALUE A

3.2.1 INPUT SCALING LIST

Input scaling default values and setting ranges (conformance ranges) per input code are as shown in the following table.

INPUT SIGNAL	DEFAULT VALUE	SETTING RANGE
A1: 0.00 – 20.00 mA AC	Input scaling value A: 0000 Input scaling value B: 2000	0000 to 2000
A2: 0.0 – 200.0 mA AC	Input scaling value A: 0000 Input scaling value B: 2000	0000 to 2000
A3: 0.000 – 2.000 A AC	Input scaling value A: 0000 Input scaling value B: 2000	0000 to 2000
A4: 0.000 – 1.000 A AC	Input scaling value A: 0000 Input scaling value B: 1000	0000 to 1000
A5: 0.000 – 5.000 A AC	Input scaling value A: 0000 Input scaling value B: 5000	0000 to 5000

3.2.2 OPERATING PROCEDURE

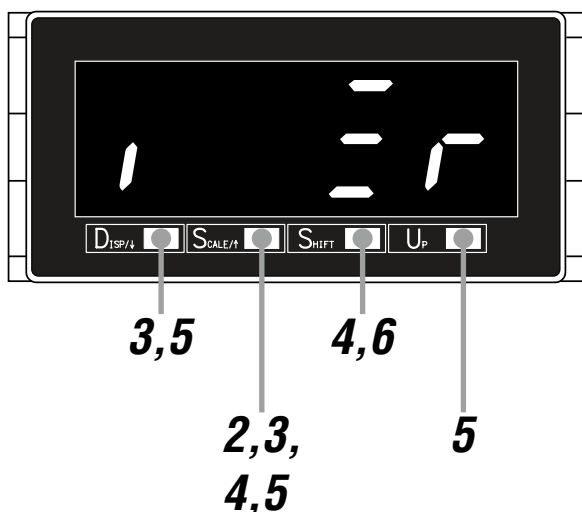

1 Confirm the wiring, and turn on the power.

- All the indications turn on for approximately 3 seconds and then the display moves on to Measuring Mode.

NOTE

Indication 'S.ERR' may blink, which shows the input out of the permissible range and does not show the unit failure.

- Immediately after power on (all indicators on)



- Measuring Mode



*1 Display depends on the settings and input.

2 Hold down **SCALE/↑** button for 3 seconds or more to move on to **Scaling Setting Mode**.

- The setting item 'D PT' (decimal point position) is indicated.



3 Press **DISP/↓** or **SCALE/↑** button to go to the input scaling value A setting.

- The setting item 'I ZR' (input scaling value A) is indicated.



NOTE

Skip to Step 7 if the default value is acceptable.

4 Press **SHIFT** button to show the setting and **SCALE/↑** button to shift the display into the setting standby mode.

- The forth digit starts blinking, to which you can apply changes.



5 Press **DISP/↓** or **SCALE/↑**, and **UP** buttons to set to '0.000'.

- Press **DISP/↓** or **SCALE/↑** button to go to the next digit, and **UP** button to change the blinking value.

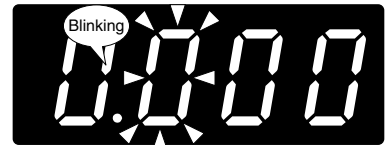

NOTE

- '0.000' is a display example. Set any value within the setting range.
- 'ERR' starts blinking back in Measuring Mode when the set value is within invalid range, or is same as or greater than the input scaling value B. Return the setting within the valid range.

6 Press **SHIFT** button to apply the new setting.

- And the setting item is indicated.



7 ■ **TO GO ON TO SET THE INPUT SCALING VALUE B,**
Skip to Step 3 in "3.3 STEP 3. INPUT SCALING VALUE B"

■ **TO QUIT,**

Hold down **DISP/↓** or **SCALE/↑** button for 1 second or more to return to Measuring Mode.

3.3 STEP 3. INPUT SCALING VALUE B

3.3.1 OPERATING PROCEDURE

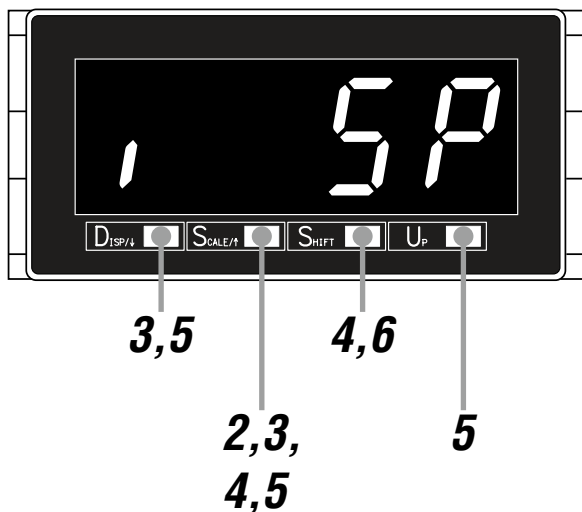

1 Confirm the wiring, and turn on the power.

- All the indications turn on for approximately 3 seconds and then the display moves on to Measuring Mode.

NOTE

Indication 'S.ERR' may blink, which shows the input out of the permissible range and does not show the unit failure.

- Immediately after power on (all indicators on)



- Measuring Mode



*1 Display depends on the settings and input.

2 Hold down SCALE/↑ button for 3 seconds or more to move on to Scaling Setting Mode.

- The setting item 'D PT' (decimal point position) is indicated.



3 Press DISP/↓ or SCALE/↑ button to go to the input scaling value B setting.

- The setting item 'I SP' (input scaling value B) is indicated.



NOTE

Skip to Step 7 if the default value is acceptable.

4 Press **SHIFT** button to show the setting and **SCALE/↑** button to shift the display into the setting standby mode.

- The fourth digit starts blinking, to which you can apply changes.



5 Press **DISP/↓** or **SCALE/↑**, and **UP** buttons to set to '1.000'.

- Press **DISP/↓** or **SCALE/↑** button to go to the next digit, and **UP** button to change the blinking value.



NOTE

- '1.000' is a display example. Set any value within the setting range.
- 'ERR' starts blinking back in Measuring Mode when the set value is within invalid range, or is same as or less than the input scaling value A. Return the setting within the valid range.

6 Press **SHIFT** button to apply the new setting.

- And the setting item is indicated.



7 ■ **TO GO ON TO SET THE DISPLAY SCALING VALUE A,**
Skip to Step 3 in "3.4 STEP 4. DISPLAY SCALING VALUE A"

■ **TO QUIT,**

- Hold down **DISP/↓** or **SCALE/↑** button for 1 second or more to return to Measuring Mode.

3.4 STEP 4. DISPLAY SCALING VALUE A

3.4.1 DISPLAY SCALING LIST

Display scaling default values per input code and setting range (permissible display range) are as shown in the following table.

INPUT SIGNAL	DEFAULT VALUE	SETTING RANGE
A1: 0.00 – 20.00 mA AC	Display scaling value A: 0000 Display scaling value B: 2000	9999 to 9999
A2: 0.0 – 200.0 mA AC	Display scaling value A: 0000 Display scaling value B: 2000	
A3: 0.000 – 2.000 A AC	Display scaling value A: 0000 Display scaling value B: 2000	
A4: 0.000 – 1.000 A AC	Display scaling value A: 0000 Display scaling value B: 1000	
A5: 0.000 – 5.000 A AC	Display scaling value A: 0000 Display scaling value B: 5000	

3.4.2 OPERATING PROCEDURE

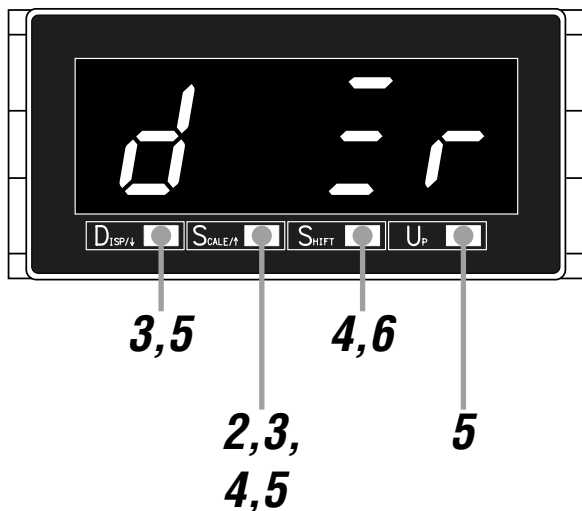

1 Confirm the wiring, and turn on the power.

- All the indications turn on for approximately 3 seconds and then the display moves on to Measuring Mode.

NOTE

Indication 'S.ERR' may blink, which shows the input out of the permissible range and does not show the unit failure.

- Immediately after power on (all indicators on)



- Measuring Mode



*1 Display depends on the settings and input.

2 Hold down **SCALE/↑** button for 3 seconds or more to move on to **Scaling Setting Mode**.

- The setting item 'D PT' (decimal point position) is indicated.



3 Press **DISP/↓** or **SCALE/↑** button to go to the display scaling value A setting.

- The setting item 'D ZR' (display scaling value A) is indicated.



NOTE

Skip to Step 7 if the default value is acceptable.

4 Press **SHIFT** button to show the setting and **SCALE/↑** button to shift the display into the setting standby mode.

- The fourth digit starts blinking, to which you can apply changes.



5 Press **DISP/↓** or **SCALE/↑**, and **UP** buttons to set to '000.0'.

- Press **DISP/↓** or **SCALE/↑** button to go to the next digit, and **UP** button to change the blinking value.



NOTE

- '000.0' is a display example. Set any value within the range of -9999 to 9999.
- The negative sign (-) must be set together with the 4th digit. For example, set '-04.00' instead of '-4.00'.

6 Press **SHIFT** button to apply the new setting.

- And the setting item is indicated.



7 ■ **TO GO ON TO SET THE DISPLAY SCALING VALUE B,**
Skip to Step 3 in "3.5 STEP 5. DISPLAY SCALING VALUE B"

■ **TO QUIT,**

Hold down **DISP/↓** or **SCALE/↑** button for 1 second or more to return to Measuring Mode.

3.5 STEP 5. DISPLAY SCALING VALUE B

3.5.1 OPERATING PROCEDURE

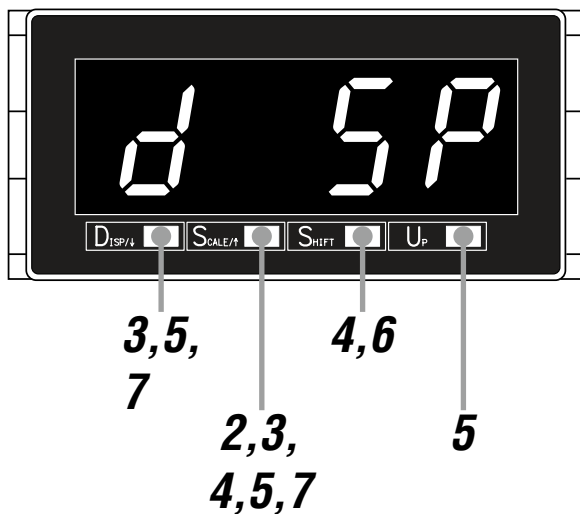

1 Confirm the wiring, and turn on the power.

- All the indications turn on for approximately 3 seconds and then the display moves on to Measuring Mode.

NOTE

Indication 'S.ERR' may blink, which shows the input out of the permissible range and does not show the unit failure.

- Immediately after power on (all indicators on)



- Measuring Mode



*1 Display depends on the settings and input.

2 Hold down **SCALE/↑** button for 3 seconds or more to move on to Scaling Setting Mode.

- The setting item 'D PT' (decimal point position) is indicated.



3 Press **DISP/↓** or **SCALE/↑** button to go to the display scaling value B setting.

- The setting item 'D SP' (display scaling value B) is indicated.

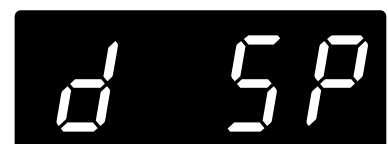

NOTE

Skip to Step 7 if the default value is acceptable.

4 Press **SHIFT** button to show the setting and **SCALE/↑** button to shift the display into the setting standby mode.

- The forth digit starts blinking, to which you can apply changes.



5 Press **DISP/↓** or **SCALE/↑**, and **UP** buttons to set to '300.0'.

- Press **DISP/↓** or **SCALE/↑** button to go to the next digit, and **UP** button to change the blinking value.

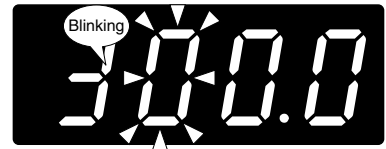

NOTE

- '300.0' is a display example. Set any value within the range of -9999 to 9999.
- The negative sign (-) must be set together with the 4th digit. For example, set '-04.00' instead of '-4.00'.

6 Press **SHIFT** button to apply the new setting.

- And the setting item is indicated.



7 Hold down **DISP/↓** or **SCALE/↑** button for 1 second or more to return to Measuring Mode.

4. OPERATION

Make sure that 0.0 – 300.0 A AC is correctly indicated according to the input 0 – 1 A AC provided.

IMPORTANT

Before operating, make sure that the wiring is correct, the input and the power supply are within the specification range.

1 Apply 0 A input (0%) and make sure that 0.0 A is indicated.



*1 Display depends on the settings and input.

NOTE

■ WHEN THE FOLLOWING IS INDICATED...

- When 'S.ERR' is indicated, the input is not applied correctly. Check the input wiring, equipment and signal.
- When 'ERR' is indicated, the input scaling value A or B is not set correctly. Return the setting within the valid range.

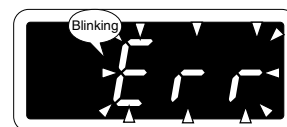
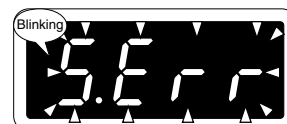

2 Apply 0.5 A input (50%) and make sure that 150.0 A is indicated.



3 Apply 1 A input (100%) and make sure that 300.0 A is indicated.



5. PARAMETER CONFIGURATION

■ MODE

Parameters can be grouped in several modes.
The 40DCT has modes as shown in the following table.

MODE	FUNCTION	MEASUREMENT
Measuring	Normal measurement state where the unit takes in input. When the power is supplied, the unit operates in Measuring Mode.	Measuring
Scaling Setting	Decimal point position, input scaling value A and B, display scaling value A and B, low-end cutout and low-end cutout value can be set.	Measuring stopped
Display Setting	Moving average and brightness can be set. Settings can be initialized. Also the firm-ware version can be confirmed.	

■ MODE TRANSITION

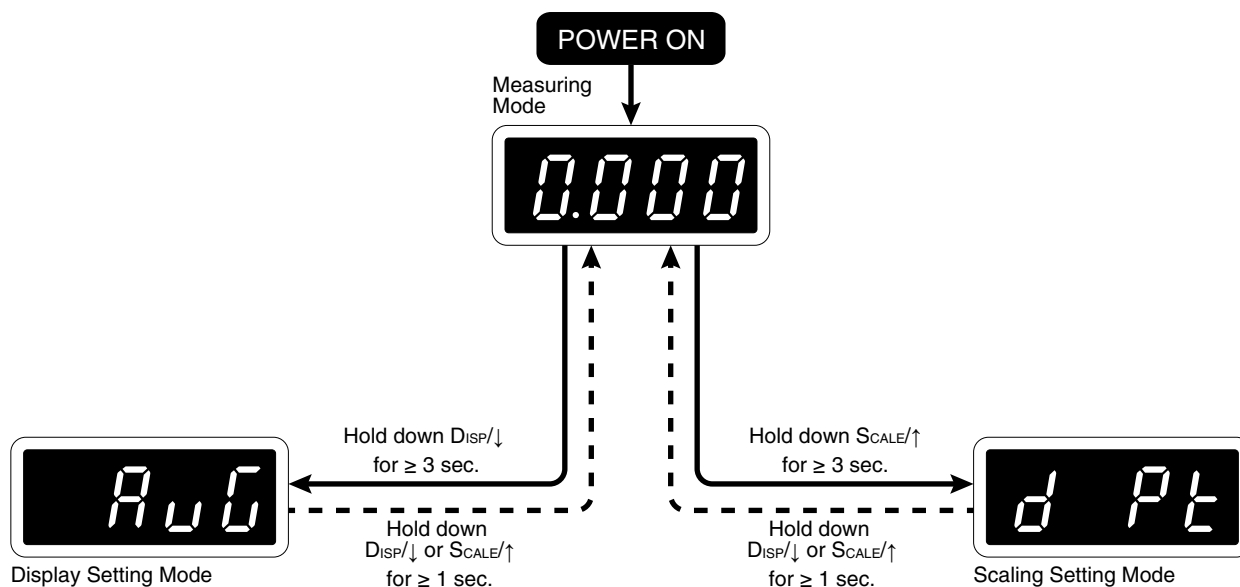

■ TRANSITION FROM MEASURING MODE TO EACH MODE

To Scaling Setting Mode	Hold down SCALE/↑ button for 3 seconds or more.
To Display Setting Mode	Hold down DISP/↓ button for 3 seconds or more.

■ TRANSITION FROM EACH MODE TO MEASURING MODE

Hold down **DISP/↓** or **SCALE/↑** button for 1 second or more to return to Measuring Mode.

6. AVERAGING INPUT

Moving average processing of measured values is configurable. The number of samples in processing the moving average can be selected in the following table. This operation averages sampled values, and then, averages with a new sample added and the oldest one omitted. Such operation is repeated as shown in the following figure. For instance, when 'A 4' is selected, the moving average processing with 4 samples (400 millisecond intervals) is repeated. Moving average is used to remove periodic varied noise superimposed on the input signal and suppress the display flickering.

■ NUMBER OF SAMPLES

DISPLAY	FUNCTION	DEFAULT VALUE
[R OFF]	No moving averaging	[R OFF]
[R 2]	Moving average with 2 samples (200 millisecond intervals)	
[R 4]	Moving average with 4 samples (400 millisecond intervals)	
[R 8]	Moving average with 8 samples (800 millisecond intervals)	
[R 16]	Moving average with 16 samples (1600 millisecond intervals)	

■ EXAMPLE OF MOVING AVERAGE WITH 4 SAMPLES

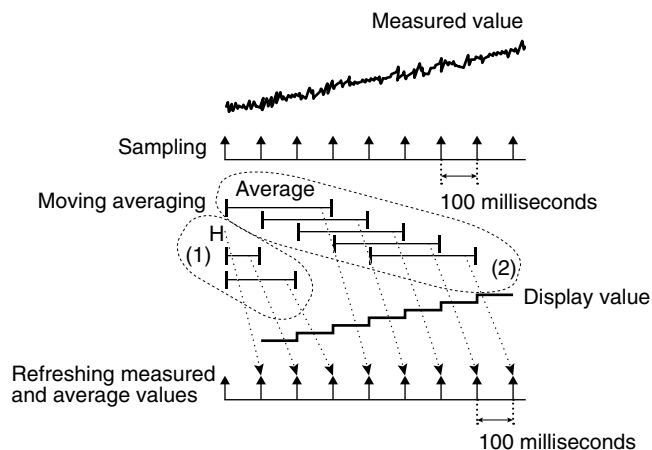

- (1) The moving average operation starts immediately after the power is on or the moving average is set. Until the sampling No. reaches the set value, all samples are averaged every 100 milliseconds.
- (2) After the sampling No. reaches the set value, a new sample is added to be averaged with the oldest one omitted. Such operation is repeated.

6.1 OPERATING PROCEDURE



1 Hold down DISP/↑ button for 3 seconds or more to move on to Display Setting Mode.

- The setting item 'AVG' (moving average sampling No.) is indicated.



2 Press SHIFT button to show the setting and UP button to select the moving average sampling No.

- Select one among 'A OFF', 'A 2', 'A 4', 'A 8' and 'A 16'.

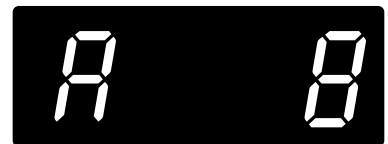

NOTE

'A OFF', 'A 2', 'A 4', 'A 8' or 'A 16' is indicated depending on the setting.

3 Press SHIFT button to apply the new setting.

- And the setting item is indicated.









4 Hold down DISP/↓ or SCALE/↑ button for 1 second or more to return to Measuring Mode.

7. ADJUSTING BRIGHTNESS OF DISPLAY

The brightness of the display can be adjusted (figures below). The brightness can be selected in the following table.

■ DISPLAY BRIGHTNESS

DISPLAY	FUNCTION	DEFAULT VALUE
	Brightness level 0 (dark)	
	Brightness level 1	
	Brightness level 2	
	Brightness level 3	
	Brightness level 4	
	Brightness level 5 (bright)	

■ ADJUSTMENT IMAGE

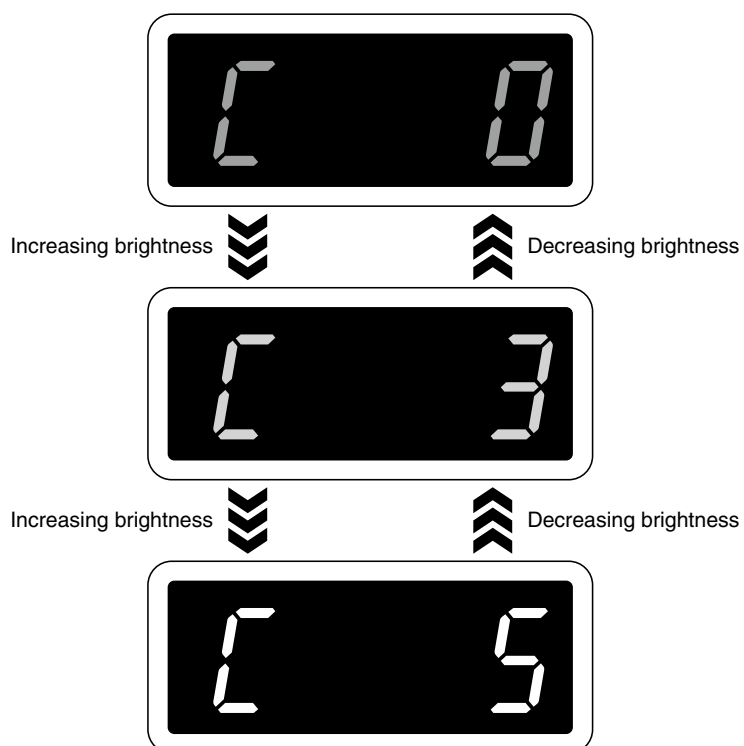

7.1 OPERATING PROCEDURE

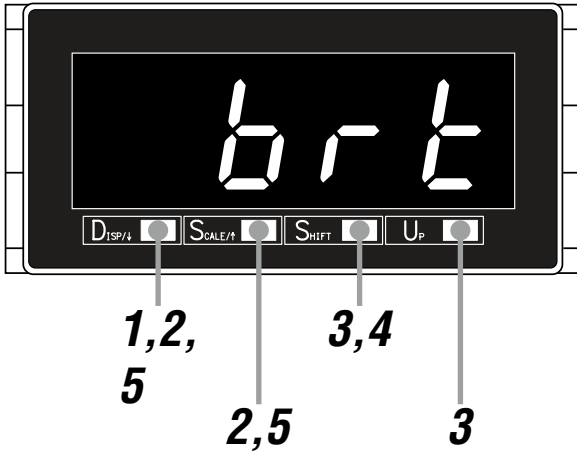

1 Hold down **DISP/↓** button for 3 seconds or more to move on to Display Setting Mode.

- The setting item 'AVG' (moving average sampling No.) is indicated.



2 Press **DISP/↓** or **SCALE/↑** button to go to the brightness setting.

- The setting item 'BRT' (brightness) is indicated.



3 Press **SHIFT** button to show the setting and **UP** button to select the brightness.

- Select one among 'C 0', 'C 1', 'C 2', 'C 3', 'C 4' and 'C 5'.

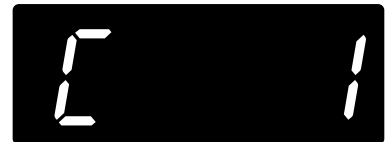

NOTE

'C 0', 'C 1', 'C 2', 'C 3', 'C 4' or 'C 5' is indicated depending on the setting.

4 Press **SHIFT** button to apply the new setting.

- And the setting item is indicated.



5 Hold down **DISP/↓** or **SCALE/↑** button for 1 second or more to return to Measuring Mode.

8. ELIMINATING FLUCTUATION AROUND “0”

A measured value less than the preset cutout value can be forcibly cut to 0 (figures below). This parameter is called low-end cutout and the value is called low-end cutout value. Enable the low-end cutout first and set the low-end cutout value within the range of 000 to 999. Figures 1 and 2 show difference between low-end cutout ON and absolute value low-end cutout ON. The low-end cutout is effective to eliminate slippage or fluctuation of the display values near zero.

■ LOW-END CUTOUT

DISPLAY	FUNCTION	DEFAULT VALUE
0.F.F	Low-end cutout OFF	0.F.F
0.n	Low-end cutout ON	
A.b.b	Absolute value low-end cutout ON	

■ SETTING RANGE

Set the low-end cutout value for the three lowest digits of the display scaling value within the range of 000 to 999. The default value is 000.

■ DIFFERENCE BETWEEN LOW-END CUTOUT AND ABSOLUTE VALUE LOW-END CUTOUT

Figure 1: Low-end cutout ON

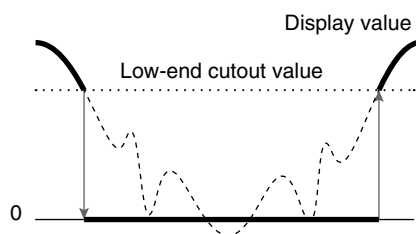

The display value less than the low-end cutout value is forcibly cut to 0.

Figure 2: Absolute value low-end cutout ON

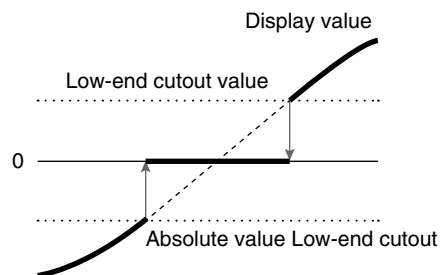

The display value of which the absolute value is less than the low-end cutout value is forcibly cut to 0.

NOTE

- Set the display scaling starting 0 when the low-end cutout is set to ON. Otherwise with the display scaling ± 1000 and the low-end cutout value 50, for example, the indication with the scaling value -1000 to 49 will be cut to 0.
- When the display scaling is set to negative to positive range, set the low-end cutout to absolute value low-end cutout ON.

8.1 LOW-END CUTOUT

8.1.1 OPERATING PROCEDURE

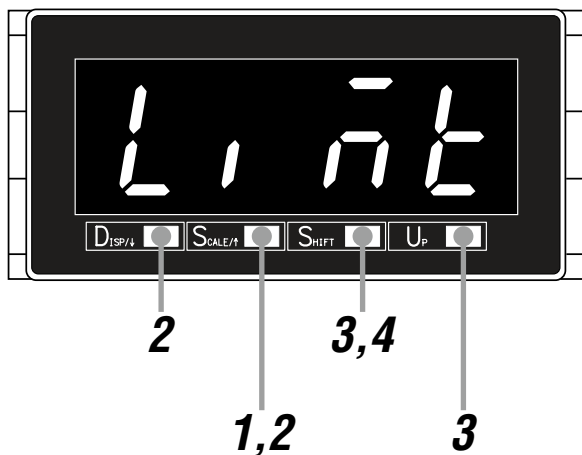

- 1** Hold down **SCALE/↑** button for 3 seconds or more to move on to Scaling Setting Mode.

- The setting item 'D PT' (decimal point position) is indicated.



- 2** Press **DISP/↓** or **SCALE/↑** button to go to the low-end cutout setting.

- The setting item 'LIMT' (low-end cutout) is indicated.



- 3** Press **SHIFT** button to show the setting and **UP** button to select the low-end cutout.

- Select one among 'OFF', 'ON' and 'ABS':

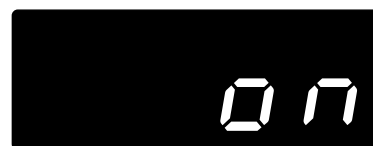

- 4** Press **SHIFT** button to apply the new setting.

- And the setting item is indicated.



- 5** ■ **TO GO ON TO SET THE LOW-END CUTOUT VALUE,**
Skip to Step 2 in "8.2 LOW-END CUTOUT VALUE"

■ **TO QUIT,**

- Hold down **DISP/↓** or **SCALE/↑** button for 1 second or more to return to Measuring Mode.

8.2 LOW-END CUTOUT VALUE

8.2.1 OPERATING PROCEDURE

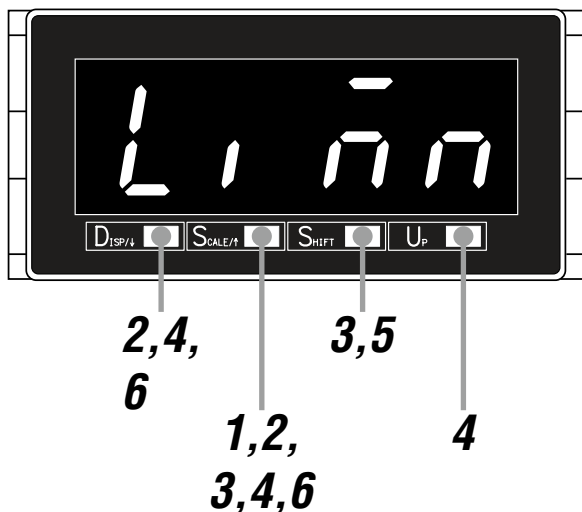

1 Hold down **SCALE/↑** button for 3 seconds or more to move on to Scaling Setting Mode.

- The setting item 'D PT' (decimal point position) is indicated.



2 Press **DISP/↓** or **SCALE/↑** button to go to the low-end cutout value setting.

- The setting item 'LIMN' (low-end cutout value) is indicated.



3 Press **SHIFT** button to show the setting and **SCALE/↑** button to shift the display into the setting standby mode.

- The third digit starts blinking, to which you can apply changes.



4 Press **DISP/↓** or **SCALE/↑** button to go to the next digit, and **UP** button to change the blinking value.

- Set within the range of 000 to 999.

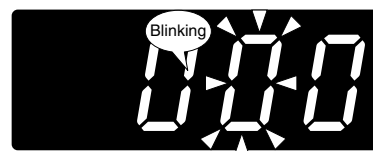

NOTE

Set the value for the display scaling. The decimal point is not indicated.

.....
5 Press **SHIFT** button to apply the new setting.

- And the setting item is indicated.



.....
6 Hold down **DISP/↓** or **SCALE/↑** button for 1 second or more to return to Measuring Mode.

9. HOLDING DISPLAY

Displayed value is held with an external HOLD command input. Connect the contact across $\overline{\text{HOLD}}$ to COM as shown in the following figures. Close the contact to hold the value.

■ WIRING EXAMPLES

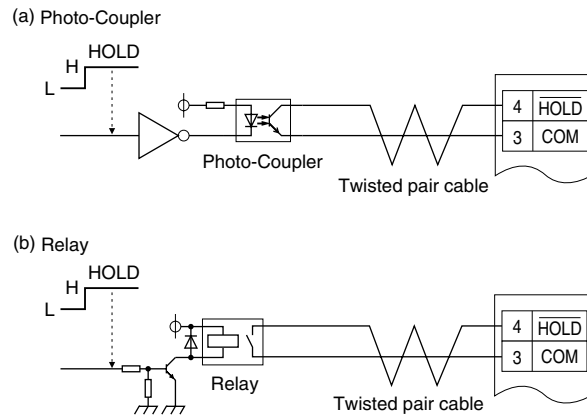

NOTE

- While the HOLD command is input, the display keeps the value at the HOLD command turning on, even though the input is out of range.
- In supplying power with the HOLD command on, 0 is indicated.

10. USER CALIBRATION

The 40DCT does not have a function to calibrate (adjust) the input signal. Set the display scaling to compensate the deviation between the set display scaling and actual display values.

Correction value 0% = display scaling value A – actual display value 0% + display scaling value A

Correction value 100% = display scaling value B – actual display value 100% + display scaling value B

Calculate the display scaling values using the correction values. Refer to 3. SETTING SCALING VALUES to set them.

Example: setting the display scaling to 0.0 – 100.0 A. Actual display 0.2 – 99.8 A AC.

Calculate correction value 0 and 100%.

Correction value 0% = $0 - 2 + 0 = -2$

Correction value 100% = $1000 - 998 + 1000 = 1002$

Set the correction value 0% and 100% as new display scaling value A and B.

Display scaling value A = -0002

Display scaling value B = 1002

11. INSPECTION / CLEANING

To use the unit in the normal and best conditions, inspect and clean the unit routinely or periodically.

- When the front panel have dirt, wipe them with wet soft cloth. Do not use organic solvent such like benzine, thinner and alcohol. Doing so may result in deformation or discoloration of the unit.
- Make sure that abnormality such like smokes, unusual smell or abnormal noises is not found. Using the unit continuously with such abnormality may result in a fire or electric shock.
- Check the terminal screws periodically. In checking the screws, for safety, interrupt electricity to the power and input.
- Make sure periodically that the mounting brackets are fixed tightly. Loosened brackets may cause drop of the unit.

12.2 INITIALIZING SETTING VALUES

To restart setting from the default state, initialization can be used. Refer to attached 13.3 PARAMETER LIST for the default values.

IMPORTANT

- Currently set parameters will be lost after an initialization. It is recommended to record the parameters before initialization.
- Even if the unit is shipped with the specified parameters with the option code '/SET', such parameters will be lost after an initialization. Be careful that the initialization does not recover the ex-factory settings.

12.2.1 OPERATING PROCEDURE

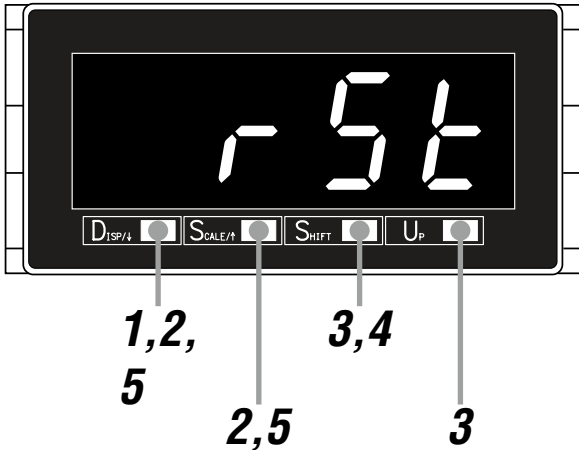

- 1** Hold down DISP/↑ button for 3 seconds or more to move on to Display Setting Mode.

- The setting item 'AVG' (moving average sampling No.) is indicated.



- 2** Press DISP/↓ or SCALE/↑ button to go to the initialization.

- The setting item 'RST' (initialization) is indicated.



- 3** Press SHIFT or UP button to select 'ON'.



.....

4 Press **SHIFT** button to execute the initialization.

- The settings are initialized and then the setting item is indicated.



.....

5 Hold down **DISP/↓** or **SCALE/↑** button for 1 second or more to return to Measuring Mode.

12.3 CONFIRMING FIRMWARE VERSION

The firmware version of the unit can be confirmed.

Confirm the version in the following cases:

- The display is different from the one described in the operating manual.
- The firmware version is necessary to consult us for troubles.

12.3.1 OPERATING PROCEDURE

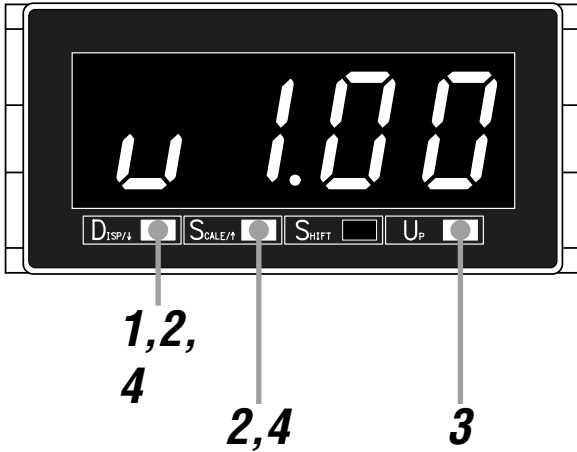

- 1** Hold down DISP/↑ button for 3 seconds or more to move on to Display Setting Mode.

- The setting item 'AVG' (moving average sampling No.) is indicated.



- 2** Press DISP/↓ or SCALE/↑ button to go to the version indication.

- The firmware version number is indicated.



- 3** Press UP button to indicate another 4 digits of the version number.



NOTE

- The above figures show the firmware version V1.00.0002.
- The displays depend on the firmware version number.

- 4** Hold down DISP/↓ or SCALE/↑ button for 1 second or more to return to Measuring Mode.

13. APPENDICES

13.1 SPECIFICATIONS

■ GENERAL SPECIFICATIONS

Construction		Panel flush mounting
Connection		M3 screw terminals (torque 0.6 N·m)
Screw terminal		Nickel-plated steel
Housing material		Flame-resistant resin (gray)
Isolation		Input to power
Input waveform		RMS sensing: Up to 15% of 3rd harmonic content
Setting (front button)	Scaling setting mode	Decimal point position, input scaling value A and B, display scaling value A and B, low-end cutout, low-end cutout value
	Display setting mode	Moving average, brightness, initialization, version indication
Sampling rate		10 times/sec. (100 msec.)
Averaging		None or moving average

■ DISPLAY

Display	4 digits of 20.3 mm (0.8 inch) height, 7-segment, red LED
Display range	-9999 to 9999
Scaling range	-9999 to 9999 counts
Decimal point position	10^{-1} , 10^{-2} , 10^{-3} or none
Zero indication	Higher-digit zeros are suppressed
Over-range indication	'-9999' or '9999' blinking for display values out of the display range. 'S.ERR' blinks surpassing the permissible range. 'ERR' blinks when input scaling setting is inappropriate.

■ INPUT SPECIFICATIONS

AC current	Input code: A1	Measurement range (conformance range)	0.00 – 20.00 mA AC
		Input range	0 – 24 mA AC
		Frequency	40 – 100 Hz
		Input resistance	5 Ω
		Input burden	0.002 VA
	Input code: A2	Measurement range (conformance range)	0.0 – 200.0 mA AC
		Input range	0 – 240 mA AC
		Frequency	40 – 100 Hz
		Input resistance	0.5 Ω
		Input burden	0.02 VA
	Input code: A3	Measurement range (conformance range)	0.000 – 2.000 A AC
		Input range	0 – 2.4 A AC
		Frequency	40 – 100 Hz
		Input resistance	0.05 Ω
		Input burden	0.2 VA
	Input code: A4	Measurement range (conformance range)	0.000 – 1.000 A AC
Input range		0 – 1.2 A AC	
Frequency		45 – 65 Hz	
Input transformer			
Input burden		0.1 VA	

AC current	Input code: A5	Measurement range (conformance range)	0.000 – 5.000 A AC
		Input range	0 – 6 A AC
		Frequency	45 – 65 Hz
		Input transformer	
	Input burden	0.5 VA	
	Overload capacity	500% of rating for 3 sec., 200% for 10 sec., 120% continuous	
Hold input		Dry contact input	
	Detecting level	≤ 1.5 V	
	Sensing	Approx. 5 V DC, 1 mA	

■ INSTALLATION

Power consumption	AC power	K3: 100 – 120 V AC	Operational voltage range 85 – 132 V, 47 – 66 Hz Approx. 3.0 VA
		L3: 200 – 240 V AC	Operational voltage range 170 – 264 V, 47 – 66 Hz Approx. 4.2 VA
	DC power	R: 24 V DC	Operational voltage range 24 V ±20% Ripple 10% p-p max. Approx. 1.0 W
Operating temperature		-10 to +55°C (14 to 131°F)	
Operating humidity		30 to 90% RH (non-condensing)	
Mounting		Panel flush mounting	
Weight		180 g (0.40 lb)	

■ PERFORMANCE

Accuracy (for each input code)	Input code: A1	±0.4% rdg ±1 digit*1
	Input code: A2	±0.4% rdg ±1 digit*1
	Input code: A3	±0.4% rdg ±1 digit*1
	Input code: A4	±0.4% FS ±1 digit
	Input code: A5	±0.4% FS ±1 digit
Temp. coefficient	±0.015%/°C (±0.008%/°F)	
Line voltage effect	±0.2% over voltage range	
Insulation resistance	≥ 100 MΩ with 500 V DC	
Dielectric strength	2000 V AC @ 1 minute (input to power to ground)	

*1 < 35% of full scale: ±0.4% FS ±1 digit

■ STANDARDS & APPROVALS

EU conformity	EMC Directive EMI EN 61000-6-4 EMS EN 61000-6-2 Low Voltage Directive EN 61010-1 Measurement Category I (input) Installation Category II (power) Pollution degree 2 Input to power: Reinforced insulation (300 V) RoHS Directive
---------------	---

13.2 MODEL NUMBERING

Code number: **40DCT-[1]-[2][3]**

[1] INPUT

Current

- A1: 0.00 – 20.00 mA AC (input resistance 5 Ω)
- A2: 0.0 – 200.0 mA AC (input resistance 0.5 Ω)
- A3: 0.000 – 2.000 A AC (input resistance 0.05 Ω)
- A4: 0.000 – 1.000 A AC (input transformer burden 0.1 VA)
- A5: 0.000 – 5.000 A AC (input transformer burden 0.5 VA)

[2] POWER INPUT

AC Power

- K3: 100 – 120 V AC (operational voltage range 85 – 132 V, 47 – 66 Hz)
- L3: 200 – 240 V AC (operational voltage range 170 – 264 V, 47 – 66 Hz)

DC Power

- R: 24 V DC (operational voltage range 24 V \pm 20%, ripple 10% p-p max.)

[3] OPTIONS

Blank: None

/Q: With options (specify the specification)

■ SPECIFICATIONS OF OPTION: Q

COATING (For the detail, refer to our web site.)

Moving parts and indicators are not coated.

- /C01: Silicone coating
- /C02: Polyurethane coating
- /C03: Rubber coating

EX-FACTORY SETTING

/SET: Preset according to the Ordering Information Sheet (No. ESU-9538)

13.3 PARAMETER LIST

MODE	PARAMETER	SETTING ITEM	SETTING RANGE	DISPLAY	DEFAULT VALUE	DECIMAL POINT POSITION	UNIT
Measuring	Present value	----	-9999 – 9999	----	----	*1	User-defined
Scaling setting	Decimal point position	[d.p.]	No decimal point, or 10 ⁻¹ to 10 ⁻³	[0000], [0000], [0000], [0000]	A1: [0000]	----	----
				A2: [0000]			
				A3: [0000]			
				A4: [0000]			
				A5: [0000]			
	Input scaling value A	[sca]	A1: 00.00 – 20.00 A2: 000.0 – 200.0 A3: 0.000 – 2.000 A4: 0.000 – 1.000 A5: 0.000 – 5.000	[0000] to [2000]	[0000]	----	mA AC
				[0000] to [2000]	[0000]		A AC
				[0000] to [2000]	[0000]		
				[0000] to [1000]	[0000]		
				[0000] to [5000]	[0000]		
Input scaling value B	[sca]	A1: 00.00 – 20.00 A2: 000.0 – 200.0 A3: 0.000 – 2.000 A4: 0.000 – 1.000 A5: 0.000 – 5.000	[0000] to [2000]	[2000]	----	mA AC	
			[0000] to [2000]	[2000]		A AC	
			[0000] to [2000]	[2000]			
			[0000] to [1000]	[1000]			
			[0000] to [5000]	[5000]			
Display scaling value A	[d.sc]	-9999 – 9999	[9999] to [9999]	A1: [0000]	*1	User-defined	
			A2: [0000]				
			A3: [0000]				
			A4: [0000]				
			A5: [0000]				
Display scaling value B	[d.sc]	-9999 – 9999	[9999] to [9999]	A1: [2000]	*1	User-defined	
			A2: [2000]				
			A3: [2000]				
			A4: [1000]				
			A5: [5000]				
Low-end cutout	[l.off]	OFF, ON, absolute value ON	[off], [on], [abs]	[off]	----	----	
			[000] to [999]	[000]			User-defined
Display setting	Moving average	[avg]	None, 2, 4, 8, 16	[off], [2], [4], [8], [16]	[off]	----	Sample
	Brightness	[brk]	0 (dark) to 5 (bright)	[0], [1], [2], [3], [4], [5]	[5]	----	----
	Initialization	[rset]	OFF, initialization	[off], [on]	[off]	----	----
	Version indication	----	----	----	----	----	----

*1 Conforms to decimal point position setting.

13.4 PARAMETER MAP

13.4.1 SCALING SETTING MODE

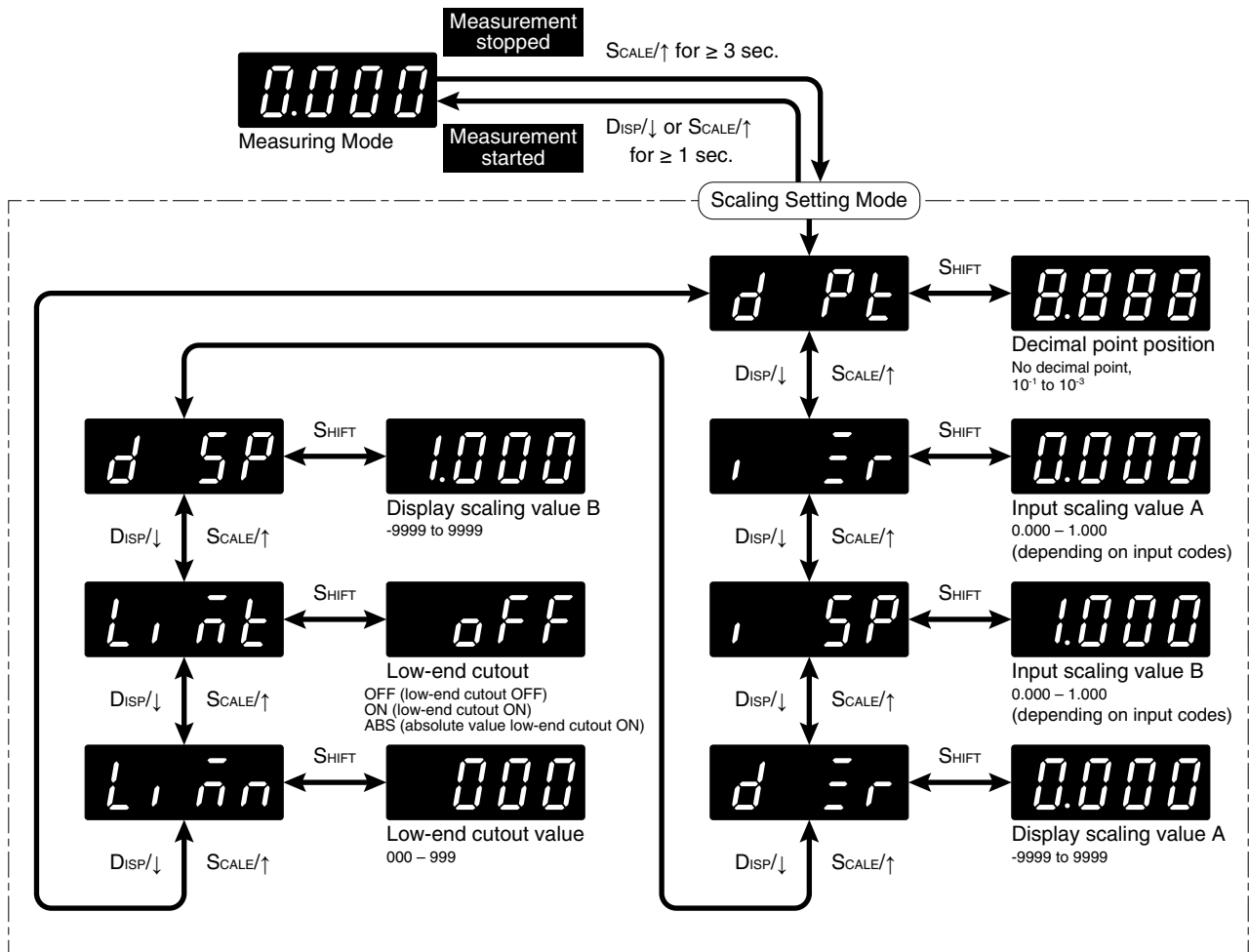

NOTE

The display depends on the specifications, settings and input.

13.4.2 DISPLAY SETTING MODE

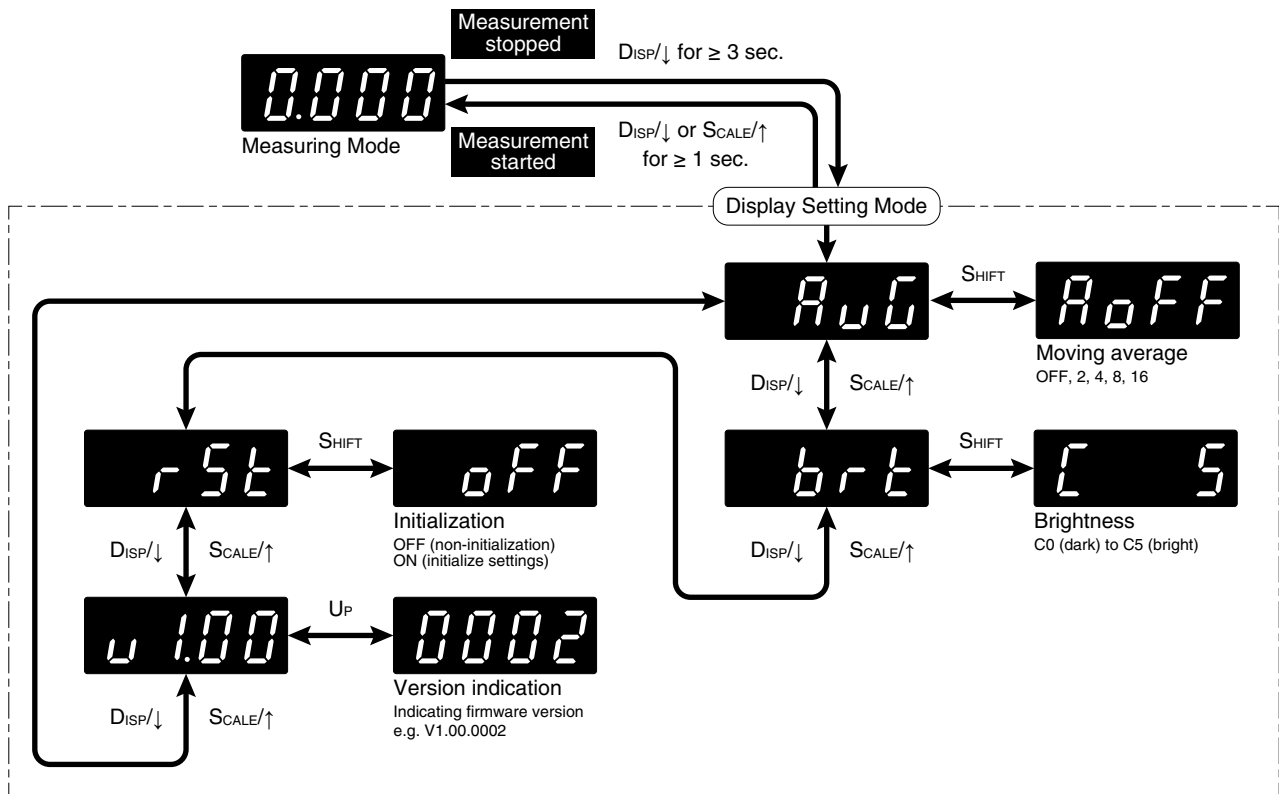









NOTE



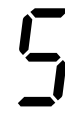

















- The display depends on the specifications, settings and input.
- Version indication is for indication only, not for setting.

13.5 CHARACTER SET

■ NUMERALS

0	1	2	3	4	5	6	7	8	9
									

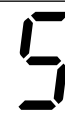
■ ALPHABET

A	B	C	D	E	F	G	H	I	J
									
K	L	M	N	O	P	Q	R	S	T
									
U	V	W	X	Y	Z				
