

2-WIRE UNIVERSAL TEMPERATURE TRANSMITTER (PC programmable)	MODEL 27U
--	------------------

BEFORE USE

Thank you for choosing us. Before use, please check contents of the package you received as outlined below. If you have any problems or questions with the product, please contact our sales office or representatives.

■ PACKAGE INCLUDES:

Signal conditioner(1)

■ MODEL NO.

Confirm Model No. marking on the product to be exactly what you ordered.

■ INSTRUCTION MANUAL

This manual describes necessary points of caution when you use this product, including installation, connection and basic maintenance procedures.

When using this product in potentially explosive atmosphere or hazardous (classified) location, you have to follow the safety procedure to install it. Please refer to "SAFE INSTALLATION MANUAL" for each type of certification.

POINTS OF CAUTION

■ CONFORMITY WITH EU DIRECTIVES

- The actual installation environments such as connected devices and connected wires may affect the protection level of this unit when it is integrated in a panel system. The user may have to review the CE requirements in regard to the whole system and employ additional protective measures to ensure the CE conformity.

■ GENERAL PRECAUTIONS

- Before you remove the module, turn off the power supply and input signal for safety.

■ ENVIRONMENT

- When heavy dust or metal particles are present in the air, install the module inside proper housing with sufficient ventilation.
- Do not install the module where it is subjected to continuous vibration. Do not subject the module to physical impact.
- Environmental temperature must be within -40 to +85°C (-40 to +185°F) with relative humidity within 0 to 95% RH in order to ensure adequate life span and operation.

■ WIRING

- Do not install cables close to noise sources (relay drive cable, high frequency line, etc.).
- Do not bind these cables together with those in which noises are present. Do not install them in the same duct.

■ AND

- The module is designed to function as soon as power is supplied, however, a warm up for 10 minutes is required for satisfying complete performance described in the data sheet.

COMPONENT IDENTIFICATION

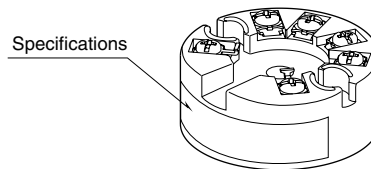

INSTALLATION unit : mm (inch)

This module is suitable for mounting inside a DIN type B head.

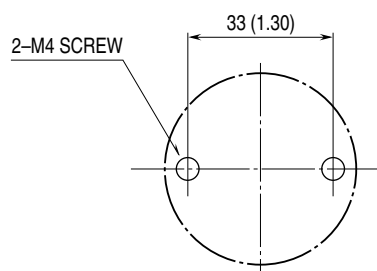

The screws are to be provided by the customer.

TERMINAL CONNECTIONS

Connect the module as in the diagram below.

EXTERNAL DIMENSIONS unit : mm (inch)

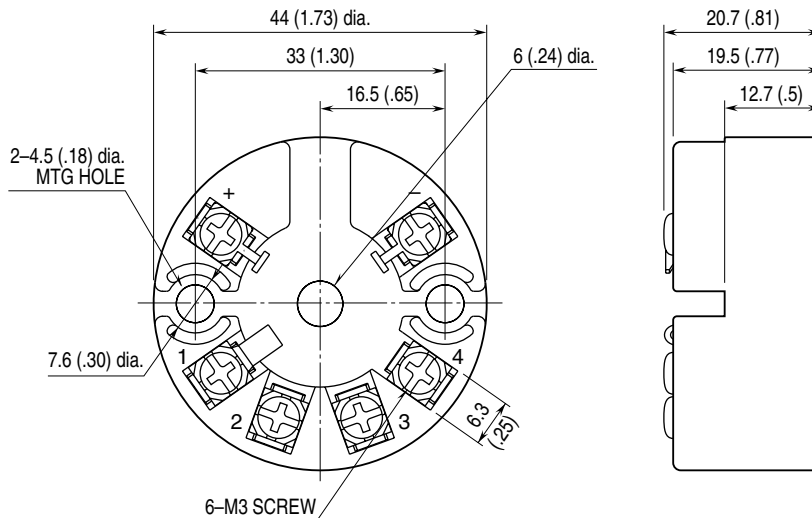

CONNECTION DIAGRAM

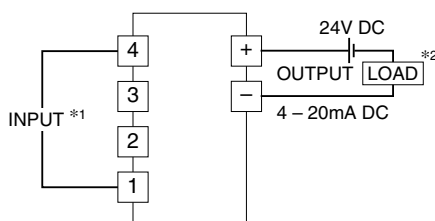

*1. Input Connection Examples

DC MILLIVOLT

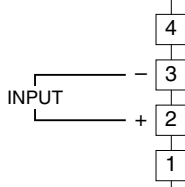

RTD & RESISTANCE

Two-wire

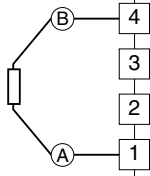

THERMOCOUPLE

Single input

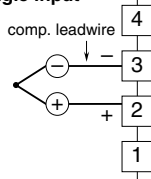

Three-wire

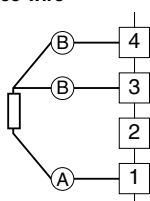

Dual input

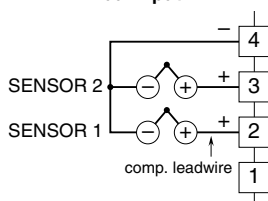

Four-wire

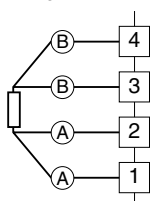

*2. Limited to 250 – 500Ω when using the communication to configure the module.

WIRING INSTRUCTIONS

SCREW TERMINAL

Torque: 0.5 N·m

CHECKING

- 1) Terminal wiring: Check that all cables are correctly connected according to the connection diagram.
- 2) Input: Check that the input signal is within 0 – 100% of full-scale.

If the thermocouple / RTD or its extension wires are broken, the output goes over 100% (below 0% with down-scale) due to the burnout function. Check leadwires in such a case.

- 3) Output: Check that the load is within the permissible limit including wiring resistance.

$$\text{Load Resistance } (\Omega) = \frac{\text{Supply Voltage (V)} - 9 \text{ (V)}}{0.023 \text{ (A)}}$$

(including leadwire resistance)

ADJUSTMENT PROCEDURE

To calibrate the signal to match with a receiving instrument or to change the factory-set configurations, use the PC Configurator software installed on a Windows PC via the Bell202 Modem (model COP-HU).

The PC Configurator software is downloadable at our web site.

LIGHTNING SURGE PROTECTION

We offer a series of lightning surge protector for protection against induced lightning surges. Please contact us to choose appropriate models.